



Exhaust Product Guide

for Medium- & Heavy-duty
Vehicles and Equipment

Mufflers • Clamps • Tubing / Connectors • Stacks / Tailpipes • Elbows • Hangers / Brackets • Shields



This publication contains a wide selection of standard mufflers and exhaust components for diesel-powered vehicles and equipment. For assistance, contact Donaldson or your local Donaldson distributor.

Distributed by:

This publication contains a wide selection of standard exhaust components for diesel-powered vehicles and equipment.

Donaldson has the technical expertise, superior customer support and vast network of locations around the world to meet your toughest needs – from initial system design through replacement products.

For assistance with muffler or accessory selection, contact your local Donaldson distributor or dealer.

Overview 2

Exhaust Product Line	2	Engine Exhaust Flow & Airflow Calculations...	6
History	4	Engine Aftermarket Exhaust Warranty	7

Shoptalk 9

Purpose of an Exhaust System.....	10	Diesel Particulate Matter (PM) Allowed per Horsepower-Hour (soot vials).....	15
Muffler Design & Performance	10	Emissions Mandates & Timing	15
Exhaust Product Materials	12	SealClamp™ Installation Instructions.....	16
Noise Sources.....	13	Cutting & Installation Instructions for Flex Tubing	18
Reduce Exhaust Noise	13	Donaldson & Industry Acronyms.....	19
Familiar Sounds on the dBA Noise Scale ...	13	Engine Brake & Exhaust Silencer	19
Noise Rules of Thumb.....	13	Terms & Definitions.....	20
E.P.A. Truck Noise Regulations	14		
Emissions Devices & Acoustic Silencing ...	14		

Accessories 21

Exhaust System Components.....	22	Universal Mounting Bracket	36
Common System Configurations	23	Pipe Hangers	36
Exhaust Joint/Connections	24	Muffler Guards & Accessories.....	37
Exhaust Clamp Performance Rankings.....	25	Muffler Hangers	37
Muffler Body Band Clamps.....	29	Heavy-Duty Muffler Mounting Straps.....	37
Heat Sleeves & Heat Wraps	30	Heavy-Duty Hangers	38
Flex Tubing & Cut to Length Flex	30	Grab Handle	40
V-Band Clamps	32	Manifold Tube/Flange.....	40
Flared Connectors & Adapters.....	33	Threaded Adapters.....	40
Marmon Flange & Flares.....	33	Universal Pipe Guards & Clamps	41
Reducers/Expanders.....	34	Elbows & Bent Tubes.....	41
Connectors.....	34	Stack Pipes	44
Tilt Cab Ball & Cone Connectors.....	35	Tailpipes	47
Y or Wye Adapter Pipe	35	Spark Arrestors	48
Splitter Tee Adapter	35	Exhaust Ejectors & Check Valves.....	49
Stack Caps.....	36	Intake Accessories.....	51
Universal Swivel Hanger	36		

Muffler Selection & Specifications 65

Muffler Selection by Style with Attenuation Ranges & Exhaust Flow	67	Muffler Specifications by Part Number.....	72
		Muffler Specifications by Style & Inlet.....	79

Truck Engine Muffler Application..... 87

Caterpillar.....	88	International	114
Cummins	98	Mack.....	119
Detroit Diesel.....	108		

Cross Reference 125

Manufacturers' Code Listing	125	0-9	128
		A-Z	162

Engine Air & Exhaust Flow Guide..... 173

Part Number Index..... 181

Features and Benefits of Donaldson Mufflers

Low Backpressure

Better fuel economy and efficient engine performance

Aluminized Steel

Delivers long service life and is corrosion resistant

Lightweight Construction

Minimizes stress and vibration on mounting system

High Temperature Paint

(Available on select product)

Paint adds corrosion resistance and enhanced finish



Donaldson Mufflers

Donaldson exhaust systems are original equipment on most pre-2007 medium- and heavy-duty trucks manufactured in North America. Donaldson engineers work with many OE truck and off-road equipment manufacturers to design and build quality exhaust systems to meet specific performance requirements.

Truck Mufflers for Every Budget

BEST

Part No. M101158 & M101181



- 1 million mile warranty on M101158 – stainless steel Silent Partner™
- 500,000 mile warranty on M101181 – aluminized steel Silent Partner
- Superior acoustic performance – specifically addresses engine brake noise by silencing engine brake “bark”

BETTER

Part No. M100580



- M100580 Donaldson muffler
- Meets all OEM back pressure, strength and life requirements
- Better acoustic performance than the M100465 muffler

GOOD

Part No. M100465



- The M100465 is the most common, most popular service muffler in the industry
- Low back pressure provides good fuel economy and efficient engine performance

What external characteristics differentiate mufflers?

- Shape of muffler (generally round or oval)
- Style (inlet/outlet configurations on the muffler)
- Materials

What internal characteristics differentiate mufflers?

- Wrapped (with insulation) or unwrapped
- Insulation sandwiched between inner and outer body
 - Reduces noise/high frequency
 - Lowers outer shell temperature
 - Reduces radiated heat
- Quantity, size, and position of internal baffles and tubes

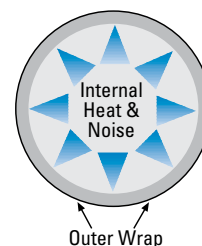

Exhaust Product Materials

A number of different materials are found in exhaust systems. Often different options are available for use in a single application. Since materials vary in strength, corrosion resistance and price, a particular material may be preferred in certain applications. Some of the most common materials, their qualities and their typical uses are listed in the table on the right.

Materials*	Used in	Qualities
Aluminized Mild Steel	Mufflers	Good Corrosion Resistance
	Exhaust Components	
Stainless Steel (with and without aluminized coating)	Flexible Tubing	Stronger Excellent Corrosion Resistance
	Mufflers	
	Exhaust Components	
	Emissions Products	
Chrome	Accessories	Bright Mirror Finish
Galvanized	Flexible Tubing	Low Material Cost Temperature Limit 600°F
Cold Rolled	Accessories	Poor Corrosion Resistance Low Cost

Muffler Styles

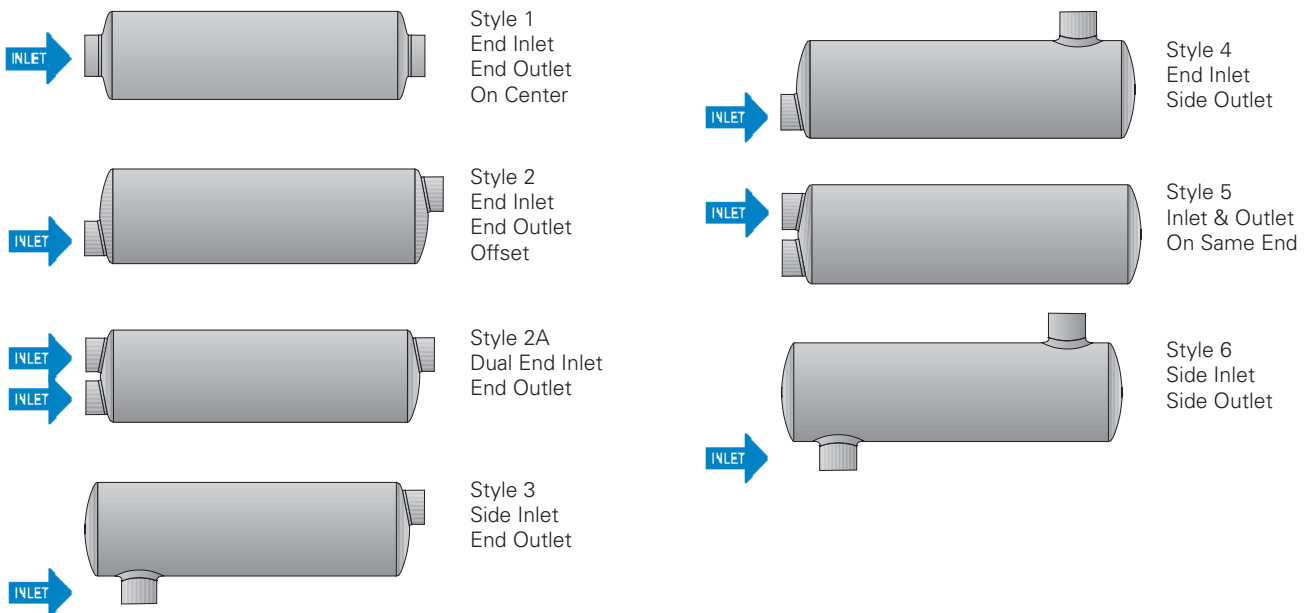

Exhaust System Configurations

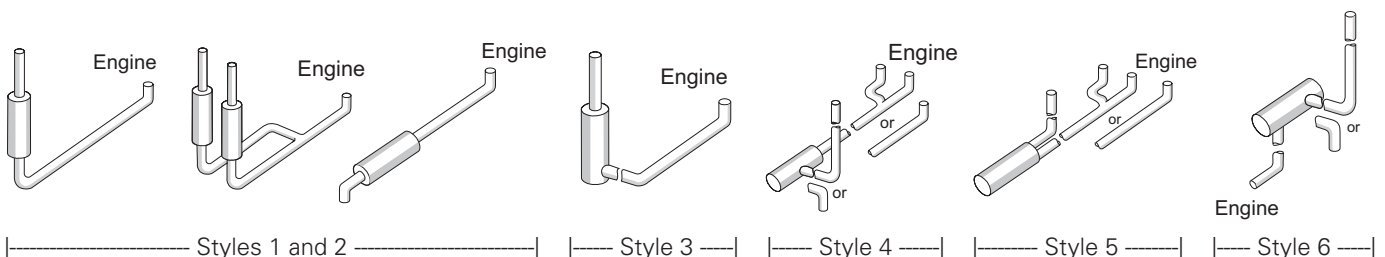

1950s

When exhaust was about silencing -- we led the way! Frank Donaldson sold enough mufflers in 1951 to open our first exhaust manufacturing facility in Grinnell, Iowa in 1952.



1960s

In the 1960s, sound meters were used to measure noise levels (see image above). Donaldson is one of the first manufacturers to introduce the use of aluminized steel in exhaust systems.

1970s

Donaldson introduces mufflers with integrated ejectors and wrapped mufflers. Wrapped mufflers reduced the overall exhaust system noise and the exterior body temperature. Donaldson SealClamp™ band-style exhaust clamp launched into the marketplace. Donaldson expands to Japan. In 1973, U.S. noise regulations went into effect for on-road vehicles – Donaldson offers a muffler line that was effective at noise reduction without loss of horsepower.



1980s

In 1981, Donaldson opens a new technical center. The center included two anechoic chambers which expanded our technical capabilities. Mufflers meet 1988 U.S. EPA truck noise regulations (sonic chokes and floating baffles).

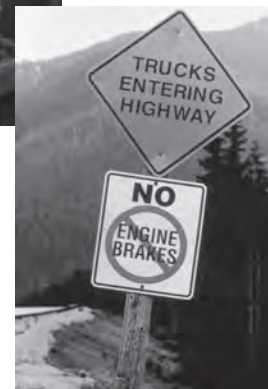
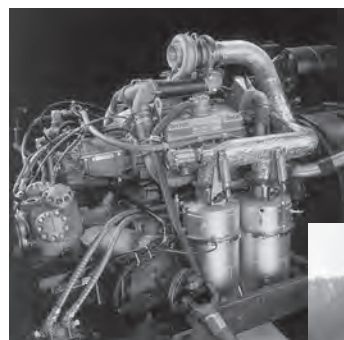

1990s

When engine manufacturers needed help to meet the first U.S. Emissions regulations, innovations continued. In the early 1990s, we pioneered the design of integrated catalytic converter mufflers and diesel particulate solutions for three major U.S. engine and truck manufacturers. In the late 1990s, Silent Partner™ was the first muffler that effectively reduced engine brake noise without loss of power or fuel economy. During this decade, Donaldson expands exhaust manufacturing in Europe (France); Mexico (Guadalajara); and the United States (Alabama).

2000s

2001 Donaldson forms a group dedicated to emissions reduction efforts for diesel engines; Spiracle™ crankcase filtration introduced to eliminate emissions from open crankcase vents. Mass production of CCMs for on-road OEs begins.

2002 First company to verify tailpipe and crankcase solution (patented).

2003 Donaldson expands exhaust manufacturing in Aguascalientes, Mexico.

2004 Donaldson upgrades and expands heavy-duty engine test cell capabilities; U.S. MSHA accepts Donaldson high temp exhaust filter.

2006 Donaldson expands European emissions staff and Mexico exhaust manufacturing to Monterrey; Donaldson improves Stepped SealClamp™.

2007 Donaldson expands OE emissions support with production of active and passive exhaust aftertreatment systems to meet U.S. EPA 2007 on-road emissions regulations.

2009 Donaldson produces urea and non-urea based NOx reduction systems for OE 2010 vehicles.



Since the early 1990s, Donaldson has sold more than a million DOC Mufflers.

The calculations on the right are provided as a reference and may be helpful as you validate and select Donaldson mufflers and components.

For the most accurate engine airflow and exhaust flow rates, Donaldson recommends using the information supplied by your engine manufacturer.

Looking for Engine Exhaust Flow Guide?



See Exhaust Flow Reference Section of this catalog, page 173.



Airflow guide should only be used as a reference document. For proper muffler application, look to your engine supplier for the most accurate and current information.

Engine Exhaust Flow Rate Calculation

Exhaust flow rate may be calculated using the following formula.

$$\left(\frac{\text{Exhaust Temp. (°F)} + 460}{540} \right) \times \text{Intake Airflow (CFM)} = \text{Exhaust Flow (CFM)}$$

Exhaust temperature and intake airflow rate must be determined to calculate the exhaust flow rate. Exhaust temperature and manufacturers maximum backpressure may be approximated using the table below.

Engine Type	Engine Temperature	Maximum Backpressure
Diesel 2-Cycle Naturally Aspirated	= 900° F	4" Hg
Diesel 2-Cycle Turbo	= 750° F	3" Hg
Diesel 4-Cycle Naturally Aspirated	= 1000° F	3" Hg
Diesel 4-Cycle Turbo	= 900° F	3" Hg
Gasoline (all types)	= 1200° F	>4" Hg

Note: If you are specifying a dual muffler system, remember to divide engine's exhaust flow (CFM) by two

Engine Airflow Calculation

CFM intake rate is available from the engine manufacturer. If CFM specifications are not available, use the volumetric efficiency calculation. A simple calculation for CFM is to multiple the horsepower of your engine by 2.5.

4-Cycle Engine Airflow Calculation

$$\left(\frac{\text{Engine Size (CID)} \times \text{RPM}}{3456} \right) \times \text{Volumetric Efficiency} = \text{Intake Airflow (CFM)}$$

2-Cycle Engine Airflow Calculation

$$\left(\frac{\text{Engine Size (CID)} \times \text{RPM}}{1728} \right) \times \text{Volumetric Efficiency} = \text{Intake Airflow (CFM)}$$

Volumetric Efficiency

Engine volumetric efficiency ratings are best obtained from your engine manufacturer. Engines operating with electronic controls could have volumetric efficiency ratings of more than 2.0. Airflow on these engines should be verified by the engine manufacturer.

4 Cycle GAS Engine	Naturally Aspirated	=	.70 - .80
2 and 4 Cycle DIESEL Engine	Naturally Aspirated	=	.90
	Turbo*	=	1.50 - 3.00*

* If VE rating is not available, Donaldson recommends using the highest value to insure proper airflow.

The information below is the exhaust portion of our Engine Aftermarket Filtration & Exhaust Warranty Document: F110064

Warranty Coverage

Donaldson warrants its Aftermarket products against failure due to defects in materials and workmanship for the period specified under Terms and Conditions for the particular product. Donaldson’s obligation under this warranty covers replacing the failed product, including transportation charges, only. If the Donaldson product failure is the sole and direct cause of damage to the equipment on which the product was properly installed, Donaldson will reimburse reasonable costs to restore the equipment to the condition it was in immediately before the failure. This warranty does not cover failure due to misapplication, misuse, abuse, neglect, rust through and corrosion (mufflers), improper installation, improper service practices or non-Donaldson approved modifications.

Engine and equipment manufacturers warranties remain in effect when Donaldson products are used.

Notification

Donaldson must be notified in writing of any claims covered by this warranty within one year of the date of failure. Donaldson, at its discretion, will either physically visit the site where the alleged failure has been found; or, request that all parts (Donaldson and other relevant parts) be shipped prepaid to its General Office, in care of the Product Lab or as otherwise specified.

Terms and Conditions

Warranty coverage begins on the date and mileage the product is purchased by the user and expires when the specified number of years or miles has passed, whichever occurs first.

The length of warranty for replacement products provided under warranty coverage is the balance of the warranty period remaining on the product being replaced.

Warranty Length by Product Type

Exhaust Products	Warranty from Date of Delivery to User
Diesel Mufflers Vertical Installation Horizontal Installation	4 years or 500,000 miles (800,000 km) 3 years or 500,000 miles (800,000 km)
Gas Mufflers	1 year
Silent Partner™ Exhaust Silencer Stainless Steel Aluminized Steel	8 years or 1,000,000 miles (1,600,000 km) 4 years or 500,000 miles (800,000 km)
Exhaust Accessories Chrome Parts (peeling and blistering only) Flex Pipe Long-Life Flex Pipe	1 year 1 year or 100,000 miles (160,000 km) 90 days 1 year or 120,000 miles (200,000 km); on-highway use only

Section Index

Purpose of an Exhaust System.....	10
Muffler Design & Performance	10
Exhaust Product Materials.....	12
Noise Sources	13
Reduce Exhaust Noise	13
Familiar Sounds on the dBA Noise Scale.....	13
Noise Rules of Thumb.....	13
E.P.A. Truck Noise Regulations	14
Emissions Devices & Acoustic Silencing.....	14
Diesel Particulate Matter (PM) Allowed per Horsepower-Hour (soot vials)	15
Emissions Mandates & Timing	15
SealClamp™ Installation Instructions	
Flat Band Style.....	16
Stepped Preformed Style	17
Cutting & Installation Instructions for Flex Tubing.....	18
Donaldson & Industry Acronyms	19
Engine Brake & Exhaust Silencer	19
Terms & Definitions	20

Purpose of an Exhaust System

Exhaust system design specifications are typically defined by the OEs. They are looking for a solution that can redirect engine exhaust, reduce exhaust noise and most recently, reduce emissions (hydrocarbons, carbon monoxide, soluble organic fraction (SOF)).

Diesel engines are a reliable and efficient power source for vehicle and equipment manufacturers. Governmental regulations across the globe are driving diesel engine users to consider buying new vehicles to meet the new emissions regulations.



Muffler Design & Performance

Donaldson mufflers are designed and tested with specific focus on three performance variables: attenuation, backpressure and structural.

Attenuation

For exhaust systems, attenuation refers to the reduction in sound level measured between an engine without a muffler and the same engine with a muffler. This sound level is typically measured in a decibel scale (dBAs). Traditional mufflers use tubes, baffles, and expansion chambers and insulation to help control noise. Newer applications include emissions reduction devices installed in the exhaust system. Many of the devices also provide the needed noise attenuation either in part or in total.

Sound quality is an additional noise characteristic that is important to the end user. An example of a sound quality concern is the sound of fingernails on a chalk board – this screeching sound makes people wince, yet the measured sound level would not be significant. A low throaty rumble may seem even quiet (and almost desirable) but may be amplified and become annoying if it reverberates within the operator's cabin.

Engine manufacturers generally expect a reduction in engine exhaust sound level of 15-25 dBA. The overall noise level of a vehicle or piece of stationary equipment is the actual regulated value. The overall noise level is typically measured while driving past a microphone at a specific speed and distance. Maximum noise levels in the U.S. are regulated by the U.S. EPA (Environmental Protection Agency).

Heavy-duty mufflers typically employ one of three sound reduction techniques including:

Reactive silencing

What's important: the ratio of the body diameter to the tube.

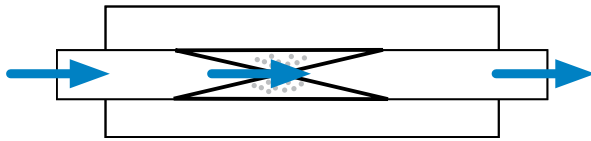

Resistive silencing

Exhaust flow is forced through a small area. It removes energy to reduce noise level.

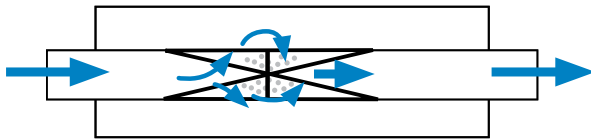

Absorptive silencing

Transforms wave energy into thermal energy. Uses acoustic packing (or wrap) just inside the outer shell of the muffler.

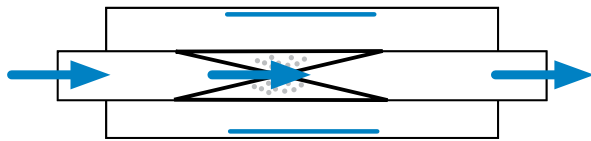

Backpressure

A key performance factor in selecting the proper muffler is backpressure. For the most efficient engine performance it is important to apply a muffler that minimizes backpressure.

Backpressure is the force necessary to flow gasses through the Exhaust system, or the resistance to exhaust flow. System considerations include friction and momentum effects - expansion / contraction / elbows, and velocity head loss at outlet.

To minimize backpressure, long tube lengths, small tube diameters and sudden contractions should be avoided.

Backpressure can reduce horsepower and fuel economy. For example, turbocharged diesel engines loose about 0.5% in horsepower and fuel economy per inch Hg backpressure. To help you minimize backpressure, our selection guide provides exhaust flow ratings at 1", 2" and 3" Hg (mercury).

Conversion: 1.0" Hg = 13.6" H₂O

Our muffler spec'ing section outlines the steps you need to take for proper muffler selection.

Structural

Another performance factor is the structural durability of the system configuration. Position, mounting support, weight and the type of material that the unit is made from are the key sub-components of system structure.

For example, the original OE stanchion or chassis mounting components are adequate for a replacement muffler. If you apply a heavier muffler, like one with an emissions device inside, it's critical to upgrade the hangers, brackets and stanchion with more robust and heavier components. Most exhaust system problems encountered by Donaldson field service are due to improper bracketing and/or use of clamps – not the muffler or muffler construction.

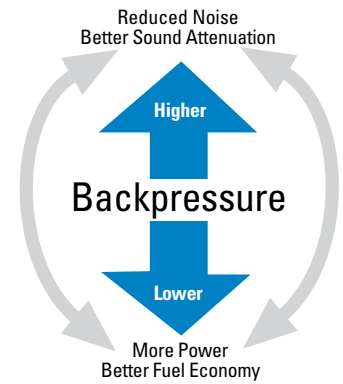

Exhaust Product Materials

There are a number of materials found in diesel exhaust applications. Some of the materials are appropriate for heavy-duty applications and have the mechanical properties to provide good service life.

Since materials vary in strength, corrosion resistance, and price, a particular material may be preferred in individual applications and components. Some of the most common materials, their qualities and their typical uses are listed in the following table.

Materials*	Used in	Qualities
Aluminized Mild Steel	Mufflers	- Good Corrosion Resistance
	Exhaust Components	
Stainless Steel (with and without aluminized coating)	Flexible Tubing	- Stronger
	Mufflers	- Excellent Corrosion Resistance
	Exhaust Components	- Temperature Limit 1500°F
	Emissions Products	
Chrome	Accessories	- Bright Mirror Finish
Galvanized	Flexible Tubing	- Low Material Cost - Temperature Limit 600°F
Cold Rolled	Accessories	- Poor Corrosion Resistance - Low Cost

Aluminized steel is the preferred material for traditional diesel exhaust applications. Aluminized steel is a low carbon steel with a thin layer of aluminum alloyed to the surface. The aluminum provides a barrier for protection of the base material. Aluminized steel parts have an ultimate service temperature of 1500°F with a continuous duty temperature limit of 1000°F. This material closely matches the expected service temperatures of diesel engine applications and has excellent corrosion resistance to acidic diesel exhaust gases. Aluminized steel parts provide good field life at a reasonable cost. Paint adhesion issues could occur with aluminized steel parts if operating conditions produce continued surface temperatures that exceed 850°F.

Series 400 stainless steels are used for many extended service life diesel applications and often in gasoline applications due to their higher operating temperatures. This material family provides slightly better strength at exhaust system temperatures than aluminized steel.

Type 409 is the most common 400 series stainless steel used in exhaust applications. Type 409 is stronger

than aluminized but exhibits cosmetic problems at exhaust system temperature. At first exposure to high temperature it discolors. Over time it develops a nondestructive coating of surface rust. After an extended time in the field a 409 product will display external discoloration and look worse than a similar part made from aluminized steel, but will last much longer.

Another choice is 409 stainless steel with an aluminum coating. Aluminized 409 is used on diesel catalytic converter mufflers due to its excellent high temperature resistance and the corrosion protection of the aluminized coating. Aluminized 409 is found primarily on emission products or high temperature gasoline applications.

Series 300 stainless steels are also utilized in exhaust systems. The most common material is Type 304. This material has excellent corrosion resistance and very good high temperature strength and is used in some muffler applications where very high stresses occur. This is a premium material and is also used in many gasoline applications. The most prevalent use of the material in heavy-duty diesel applications is for flex pipe. Flex pipe produced from light gauge 304 stainless steel is an excellent choice considering all the factors of cost, durability and service life.

Often chrome plated cold rolled steel parts are found on exhaust system parts. This material is a reasonable choice for cosmetic applications where a bright mirror finish is desired. Corrosion from the inside of the product can still occur. Chrome parts may be very challenging to produce. It is important to produce the parts with a high level of quality because surface irregularities are very visible to the end user.

An alternate choice for chrome parts is bright annealed stainless steel. This material provides a bright mirror-like finish with excellent exhaust service life. Bright stainless steel is typically used for muffler heat shields and generally is an expensive material choice.

Five Major Sources of Noise in Trucks

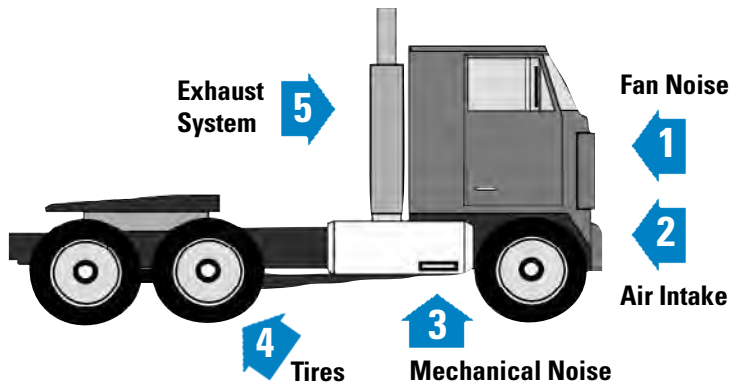

Easy Maintenance Tips Reduce Exhaust Noise

- 1 Check the exhaust tubing. Repair or replace worn or leaking components.
- 2 Make sure your exhaust system is properly supported.
- 3 Installing a resonator or wye connector muffler is an economical way to reduce noise.
- 4 Modify a single exhaust system to a dual.
- 5 Check stack and tailpipe position. A straight stack will be quieter than a curved stack on vertical exhaust systems. Turn your horizontal tailpipes toward the center of the road.

Familiar Sounds on the dBA Noise Scale

Other examples of sound levels: 70 dB Traffic jam; 90 dB Heavy machinery, 130 dB Jet engine at 10 meters.

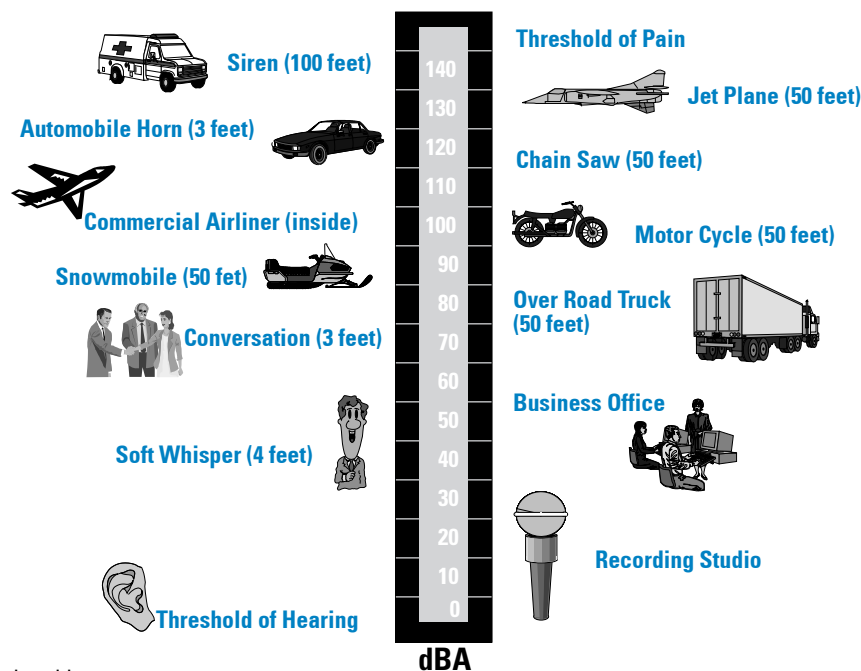

Rules of Thumb

Combining Two Equal Noise Sources Increases Sounds Level by 3 dBA

Two equal noise sources combine to create a sound level 3 dBA greater than either source.

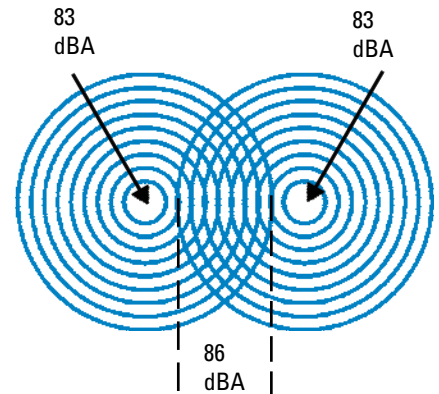

Twice the Loudness is a 10 dBA Increase

The increases are not linear! Increasing noise by 10 dB sounds twice as loud.

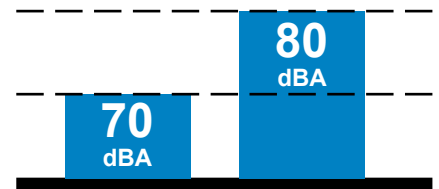

Sound Pressure Level Changes With Distance

Doubling the distance to a noise source decreases its sound level by 6 dB. Halving the distance to a noise source increases its sound level by 6 dB.

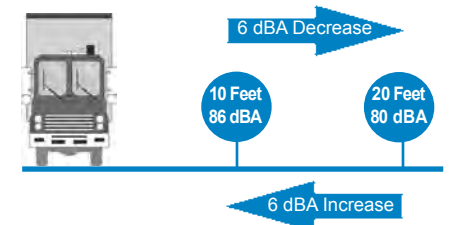

U.S. EPA Truck Noise Regulations

www.epa.gov

In the past, the Environmental Protection Agency (EPA) coordinated all federal noise control activities through its Office of Noise Abatement and Control. However, in 1981, the Administration at that time concluded that noise issues were best handled at the State or local government level. As a result, the EPA phased out the office's funding in 1982 as part of a shift in federal noise control policy to transfer the primary responsibility of regulating noise to state and local governments. However, the Noise Control Act of 1972 and the Quiet Communities Act of 1978 were not rescinded by Congress and remain in effect today, although essentially unfunded.

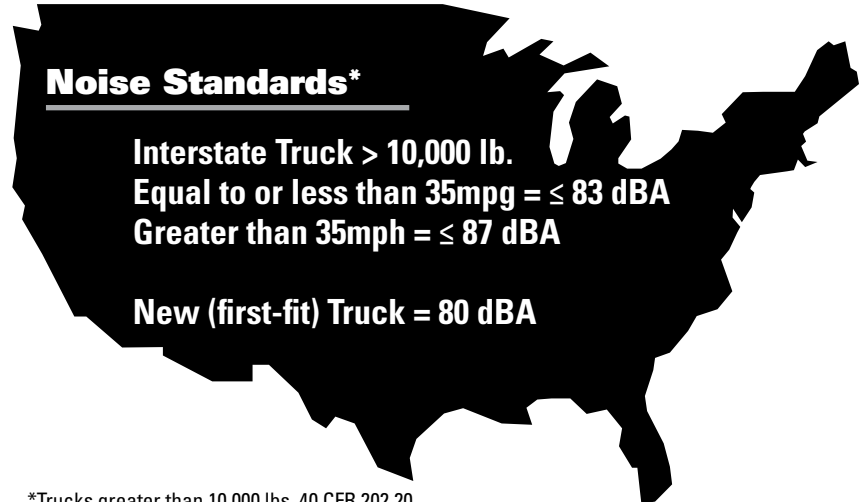

*Trucks greater than 10,000 lbs. 40 CFR 202.20

** Noise is measured at 50 feet (15.2 m) from the centerline of the lane of travel

Interstate Motor Carrier Noise

The Federal Highway Administration's Office of Motor Carrier and Highway Safety Web site includes information on the Interstate Motor Carrier Noise Emission Compliance Regulations from the Code of Federal Regulations (49 CFR 325).

Subparts for compliance of the interstate motor carrier noise emission standards

http://www.fmcsa.dot.gov/rules-regulations/administration/fmcsr/fmcsrguidedetails.aspx?rule_toc=730§ion_toc=730

Part	Regulation
Subpart A	General Provisions
Subpart B	Administrative provisions
Subpart C	Instrumentation
Subpart D	Measurement of noise emissions; highway operations
Subpart E	Measurement of noise emissions; stationary test
Subpart F	Correction factors
Subpart G	Exhaust systems and tires

Emissions Devices & Acoustic Silencing

Various emissions reduction technologies are applied to exhaust systems to meet current emissions standards. The additional components can significantly change or eliminate the traditional acoustic silencing components common in older muffler designs. Depending on the application, emissions reduction devices may totally eliminate the need for further sound control and for others, minimal acoustic silencing may be required. The sound attenuation of emissions devices varies depending on the filtering substrates and configuration of the overall system.



Typical emissions aftertreatment substrates (ceramic and metal)

Diesel Particulate Matter (PM) Allowed per Horsepower-Hour

What does "Diesel PM per Horsepower-Hour" Mean?

A 200 horsepower (HP) engine could release as much as 200 times the amount shown in one vial during one hour of operation or a 300 HP engine could release as much as 300 times the amount shown in one vial during one hour of operation.

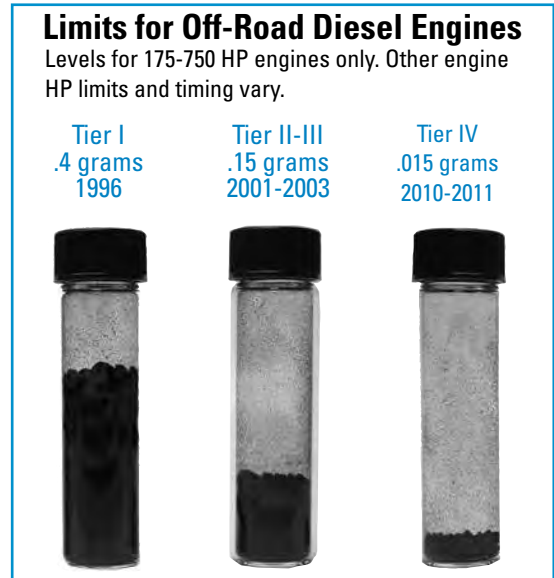
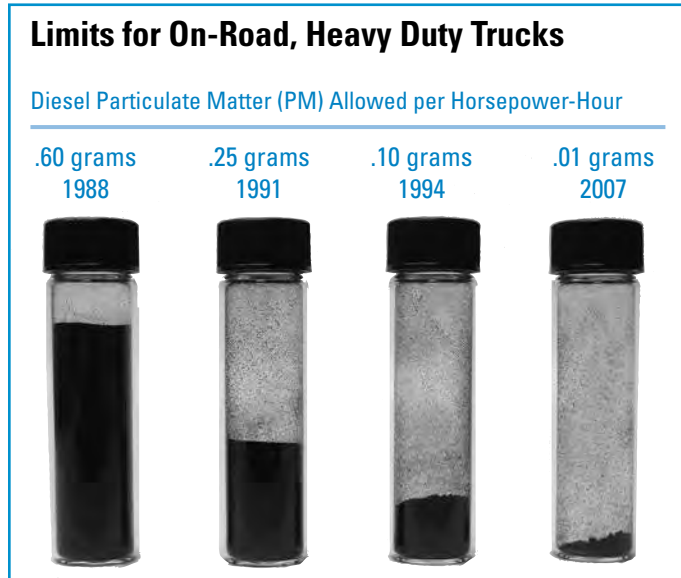

Soot vials are shown smaller than actual size (2-3/8" height).

Worldwide Emissions Mandates & Timing

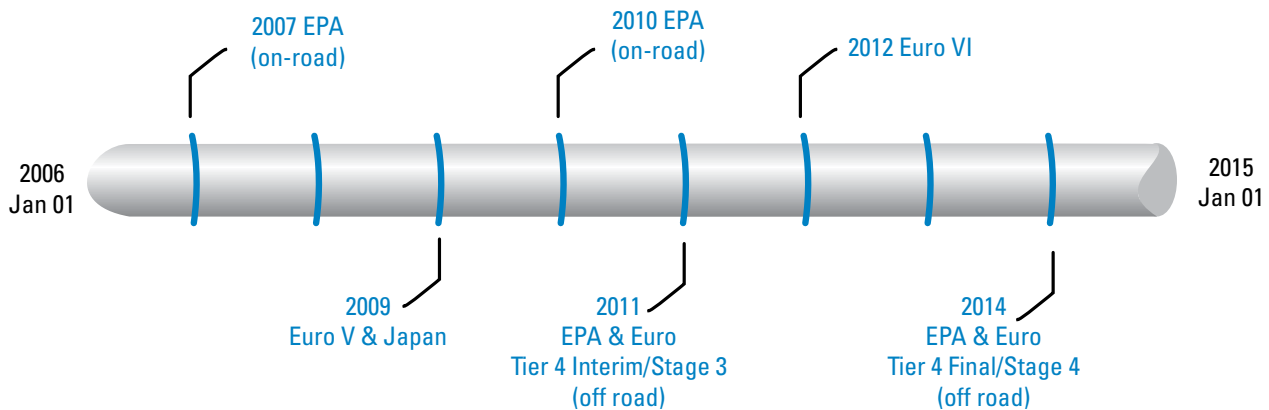

Flat Band SealClamp™ Installation Instructions



Step 1

Position 1/3 to 1/2 way onto the larger diameter tube or to completely cover slots.



May be used for butt-style joints in light duty applications



Step 2

Manually fold the clamp ends to approximately 90 degrees. Insert foil gasket in gap and insert bolts into holes.



Step 3

For all flat band seal clamps, tighten the bolt versus the nut and alternate between fasteners several times to uniformly take up the slack, beginning with the large diameter side of the connection. Tighten until the gasket is fully compressed and the mating bars' surfaces are fully touching. The grade 8 bolts and nuts are rated to 100 ft. lbs. of torque. For best results use an impact wrench.

Important Application Notes

- Use either a 9/16 inch or 14mm hex wrench and socket
- Do not use for exhaust system mounting support
- Do not use for exhaust manifold or turbocharger connections
- Do not reuse the clamps

Stepped SealClamp™ Installation Instructions



Stepped Preformed SealClamp is individually packaged with installation instructions



Unique design with fully assembled hardware!

1. Position the SealClamp over the smallest tube. Larger end of the clamp must be on the overlapping tube or flex.
2. Locate the step of the clamp to the overlapping tube at the joint.
3. Using the v-groove as a visual guide, alternately tighten bolts until the groove is approximately half closed (~50 ft. lbs). Do not exceed 70 ft. lbs. torque as clamp damage may occur.



Diseño único para un ensamble completo!

1. Colocar el SealClamp sobre el tubo más pequeño. El diámetro mayor del SealClamp debe estar sobre el tubo rígido o flexible a sobrepasar.
2. Ubicar el escalón de la abrazadera en la unión del tubo sobrepuesto.
3. Usando la ranura como guía visual, apriete alternadamente los pernos hasta que la ranura esté aproximadamente a medio cerrar. No exceda 47,5 N(m (35 lbs-pie) de par de apriete por que puede producir daños en la abrazadera.



Before / Antes / Avant



After / Después / Après

Conception unique avec pièces entièrement assemblées!

1. Placer le collier sur le tuyau de diamètre inférieur. La portion la plus grande du collier doit se trouver sur le tuyau qui chevauche.
2. Positionner la partie étagée du collier sur la portion chevauchante du tuyau en l'alignant sur le joint.
3. En utilisant la rainure comme guide visuel, serrer alternativement les boulons, jusqu'à ce que la rainure soit à moitié fermée. Ne pas dépasser une force de torsion de 35 pied-livre, cela risquerait d'endommager le serre-joint.

Flex Tubing: Cutting & Installation

Flexible tubing can twist or unravel when cut, causing its diameter to change and making installation difficult. This occurs because flexible tubing must maintain flexibility in order to function properly, and, therefore, cannot be tightly wound in the manufacturing process. However, flexible tubing can be managed for trouble-free installation by following these guidelines.



Cutting

Step 1- Prepare

Place a tack weld between convolutions on each side of the intended cut to keep ends from twisting or unraveling.

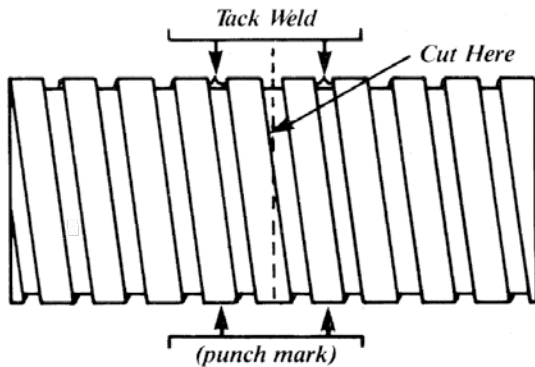

If a welder is not available, insert a mandrel or back-up pipe into the tubing and place a punch mark directly on convolutions on each side of the intended cut. Heavy-duty tape over a de-greased pair also works. Cut through tape and leave in place, clamp over tape.

Step 2 - Cut

Place the tubing securely in a vice. Cut with a metal cutting band saw or a hacksaw with 32 teeth per inch.

Step 3 - Trim

Each side of the cut will now have a spiral "tail" that must be removed to the point at which it is attached. Bend each tail until it breaks, or bend and use a cutting shears to remove.

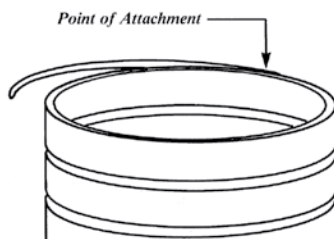

Step 4 - Deburr

Deburr both cut surfaces with a hand-operated drum sander or file.

Installation

Flexible tubing's function is to prevent excessive stress on exhaust system components by absorbing vibration and thermal expansion that would otherwise cause system components to shake loose and break.

To provide adequate flexibility, flex tubing should be installed in a half extended state. To reach half extension, place the middle of the tubing over the edge of a work bench, push down on both halves and bend as much as possible.

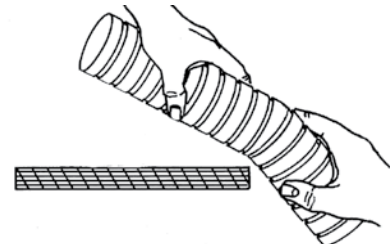

Then place the entire piece of tubing on the work bench and push the end down until straightened. The tubing is now at half extension.

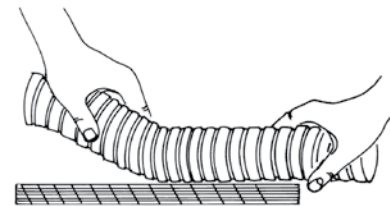

Note: Do not use flexible tubing to form an exhaust pipe bend. Use elbows instead.

Donaldson & Industry Acronyms

ATD	After Treatment Device
Bp	Backpressure
CARB	California Air Resources Board
CCM	Catalytic Converter Muffler
CCV	Crankcase Ventilation or Closed Crankcase Vent
CFM	Cubic Feet per Minute
CFS	Crankcase Filtration System
CO	Carbon Monoxide
dBA	Decibel, A scale (noise level)
DMF	Diesel Multi-stage Particulate Filter
DPF	Diesel Particulate Filter
EAT	Exhaust After Treatment
EDM	Emissions Device Monitor
EGR	Exhaust Gas Recirculation
EIEO	End In / End Out (muffler style)
EISO	End In / Side Out (muffler style)
EPA	Environmental Protection Agency
EPA Tier 4/IV	Off-road emissions standards
EPA07	U.S. EPA 2007 on-road regulation
EPA10	U.S. EPA 2010 on-road regulation
ERC	Emissions Resource Center
Euro Stage XX	European Emissions Reduction Regulations
FTP	Federal Test Procedure
HC	Hydrocarbon (unburned fuel)
HP	Horse Power
HTEF	High Temperature Exhaust Filter
ICC	Independent Catalytic Converter
ID	Inside Diameter
IOM	Installation Operation Manual
ISO	International Organization for Standardization
ISO/TS	ISO Technical Specification
LNF	Low NO ₂ Filter (muffler)
LXF	Low NO _x Filter (muffler)
LSD	Low Sulfur Diesel (fuel)
LTF	Low Temperature Filter (muffler)
NO _x	Nitrogen Oxides
OCV	Open Crankcase Ventilation
OD	Outside Diameter
PM	Particulate Matter
SC	Silicone Carbide
SCR	Selective Catalyst Reduction
SEF	Semi-active Electric Filter (muffler)
SIEO	Side In / End Out (muffler style)
SISO	Side In / Side Out (muffler style)
SRF	Standard Recirculation Filter
SS	Stainless Steel
ULSD	Ultra-Low Sulfur Diesel (fuel)
VOC	Volatile Organic Compound
VOF	Volatile Organic Fraction

Engine Brake & Exhaust Silencer



Designed to specifically address engine brake noise

- Addresses engine brake noise, silencing engine brake “bark”
- Reduces exhaust noise 66% versus a standard muffler

Silences engine brake “bark”

- Reduces driver fatigue
- Improves trucking industry image

All stainless steel construction available*

- Won't rust out like conventional mufflers

Direct replacement

- Easy installation, can be applied on existing trucks

No increase in back pressure

- Silences without engine power loss
- Maintains fuel economy

*Models available in both stainless steel and aluminized steel



Terms & Definitions

Attenuation

In an exhaust system, attenuation refers to the reduction in sound level measured between an engine without a muffler and the same engine with a muffler.

Backpressure

Backpressure is the force necessary to flow exhaust gas through the system. Backpressure reduces horsepower and fuel economy - for turbocharged diesel engines - about 0.5% decrease in horsepower and fuel economy per inch Hg backpressure. Typically measured in inches of mercury (Hg) or inches of water (H₂O) - 1.0" Hg - 13.6" H₂O

CFM

Cubic feet per minute of airflow.

dBA

The sound level measured in decibels using a sound level meter weighted for the "A" scale frequency response. It has over 82% correlation with loudness as determined by the typical human ear (dB without the "A" scale weighting overall has only 70% correlation to loudness).

Decibel (dB)

A unit used to express the relative difference in acoustic power. Whenever dB is used a reference level is implied. The reference value of 0.0002 dynes/cm² = 0dB.

DPF Muffler

Diesel Particulate Filter (DPF) Muffler. This muffler design contains a particulate filter that requires Ultra Low Sulfur Diesel fuel. The filter eliminates a greater amount of particulate matter compared to a DOC Muffler, but has a higher activation temperature (260°C). Like a DOC, it also reduces emissions while reducing exhaust noise.

Dynamometer Test

A test that allows an engine to be run to full horsepower and rated RPM while remaining stationary.

Exhaust Noise Level

Sound level of the exhaust system, typically measured in dBA.

N/A

Naturally aspirated

Resonator

A device inserted in the exhaust system ahead of the muffler that provides additional exhaust noise silencing without adding significant backpressure.

Sound Level Meter

A sound level measuring device that includes a microphone, an amplifier, an output meter and sound frequency networks for measuring sound levels in decibels,

Total Vehicle Noise

The sum of exhaust noise level measurement plus fan, intake, mechanical and tire noise. Noise levels add logarithmically (equal noise levels combined add 3 dB; example 75 dB + 75 dB = 78 dB).

Free Exhaust Accessory Poster

For mechanics and parts counter personnel, this "door width" sized poster (25"x38" / 635 mm x 965 mm) is available from Donaldson or your local Donaldson distribution outlet.

This handy visual makes it easy for your customers to identify the replacement accessories they're looking to replace.

The parts information is updated annually so if you have an old version, consider updating.

Poster Part No.
F115023

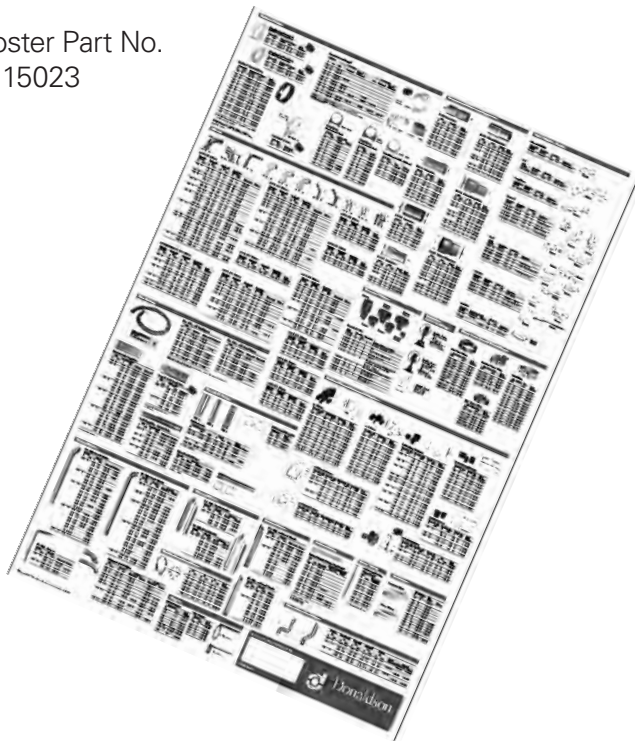

Section Index

Donaldson offers an extensive line of accessories available in a variety of materials for both vertical and horizontal exhaust systems.

Exhaust Accessories

Exhaust System Components	22
Common System Configurations.....	23
Exhaust Joint/Connections	24
Exhaust Clamps.....	24-29
Offset MaxGrip™ Bent Bolt	26
MaxGrip™ Bent Bolt	26
SealClamp™ Band Clamps	27
Torca® Clamps	28
U-Bolt Clamps.....	28
Muffler Body Band Clamps.....	29
Heavy-Duty Muffler Body Band Clamps	29
Heat Sleeves & Heat Wraps	30
Flex Tubing & Cut to Length Flex	30-31
V-Band Clamps for Large Mufflers.....	32
V-Band Clamps for Flanged Connections.....	32
V-Band Clamps	32
Flared Connectors & Adapters.....	33
Marmon Flange & Flares	33
Reducers/Expanders.....	34-35
Connectors	34
Tilt Cab Ball & Cone Connectors	35
Y or Wye Adapter Pipe.....	35
Splitter Tee Adapter.....	35
Stack Caps.....	36
Universal Swivel Hanger.....	36
Universal Mounting Bracket	36
Pipe Hangers	36
Muffler Guards & Accessories	37
Muffler Hangers.....	37
Heavy-Duty Muffler Mounting Straps.....	37
Heavy-Duty Hangers	
for Round Mufflers.....	38
for School Buses.....	39
for Oval Mufflers.....	39
Universal Applications	39
Grab Handle.....	40
Manifold Tube/Flange.....	40
Threaded Adapters	40
Universal Pipe Guards & Clamps	41
Elbows & Bent Tubes.....	41-43
Stack Pipes	44-46
Tailpipes.....	46
Spark Arrestors	47
Exhaust Ejectors & Check Valves	48-50

Intake Accessories

Rubber Elbows	51-53
Charge Air Connectors	54
Worm-Drive Hose Clamps	55
T-Bolt Clamp.....	55
Vacuator™ Valves for Air Cleaner	56
Intake Indicators & Indicator Fittings	57
Inlet Hoods	58-60
Air Ram™ Truck.....	58
Metal & Plastic Hoods.....	59-60
Moisture Eliminator & Stack Extensions	61
Air Cleaner Mounting Bands.....	62-63
Metal Bands	62
FPG Plastic & Metal	63

Common Components Of Heavy Duty Exhaust Systems

Bent Tubes & Elbows

For directional changes of exhaust flow in exhaust systems. Available in common angles (90°, 67° and 45°) for both O.D. and I.D. tube connections.



Wye Connector

For joining legs of dual manifold outlet to form a single exhaust system. Wye connectors can provide an additional 3 to 7 dBA exhaust noise reduction over that of the primary muffler and may also be used to replace conventional wye pipe.



Resonator

Secondary noise reduction component that generally provides 2 to 3 dbA additional noise reduction.



Tubing (Straight or Flexible)

Straight or flexible tubing for connection to muffler or resonator. Purchased in standard lengths and cut to size if needed.

Muffler

The primary component in an exhaust system for engine noise reduction.

Exhaust Filter or Emissions Device

Traditional exhaust systems with mufflers are transitioning from noise reduction devices to emissions reduction devices to meet federal and state regulations. The primary component in the emissions device converts or captures exhaust emissions to reduce overall engine emissions. An emissions reduction device can be an add-on installed into the existing system or a retrofit muffler replacing the original muffler.



Hanger

Secures the muffler or pipe horizontally or vertically to chassis or side of cab.



Reducers, Connectors & Expanders

Shorter length tubes used for connecting two other exhaust pipes of different diameters or the same diameter.

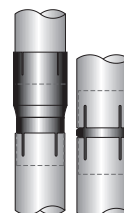

Spark Arrestor

An exhaust system add-on used to capture sparks emitted from internal combustion engines through the exhaust system. All Donaldson models are U.S. Forest Service approved.



Splitter Tee Adapter

An adapter pipe with one inlet and two outlet tubes used to convert a single exhaust system to a dual exhaust system.



Stack or Tail Pipes

Vertically mounted outlet pipe; available in curved outlet or straight squared configuration.



Note: Super stacks also available that can offer an additional 2 to 3 dBA noise reduction with no backpressure penalty.

Stack Cap

Moisture protector used on vertically mounted mufflers or stack pipes.



Clamps

Exhaust systems use a variety of exhaust clamps. Selecting the proper clamp for the job is critical to a strong, reliable joint connection. Common types include u-bolt, band clamps, bent bolt clamps and v-band clamps.



From the manifold to the exhaust stack, you'll find Donaldson can be the best source for your exhaust system accessories. The system diagrams below represent typical components found on exhaust systems.

Vertical System Components (cab or stanchion mounted)

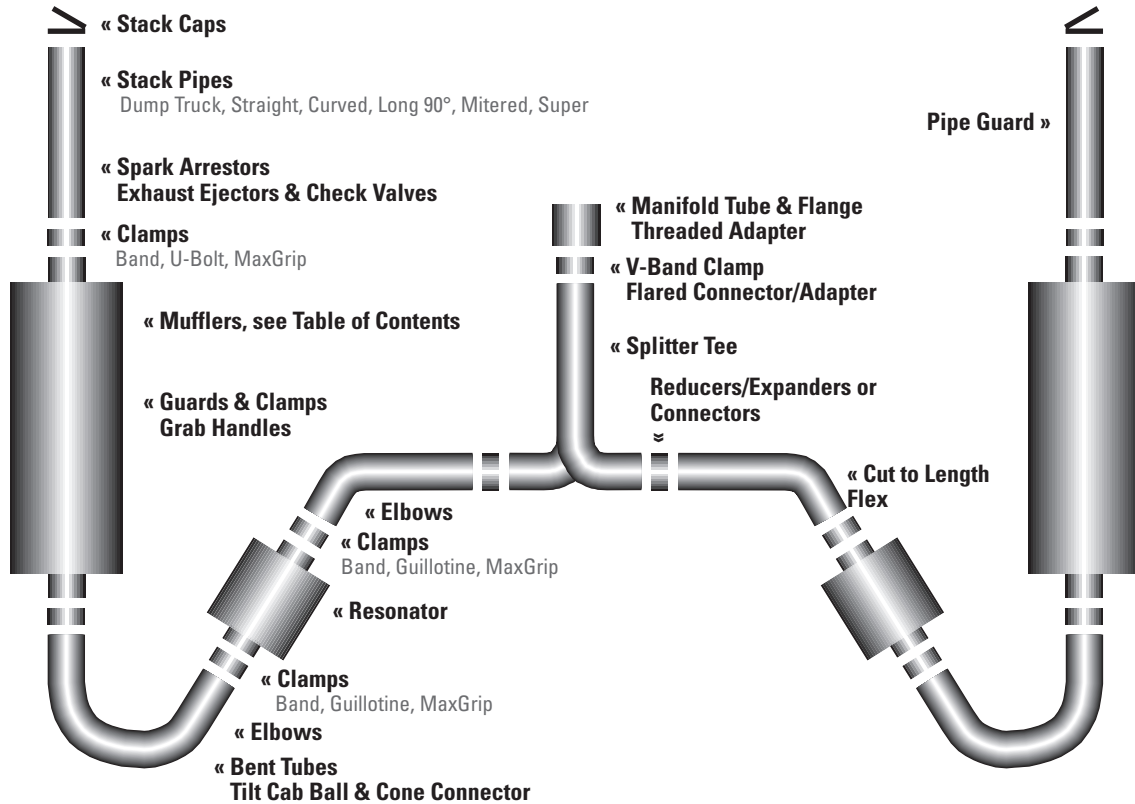

Horizontal System Components (Chassis mounted)

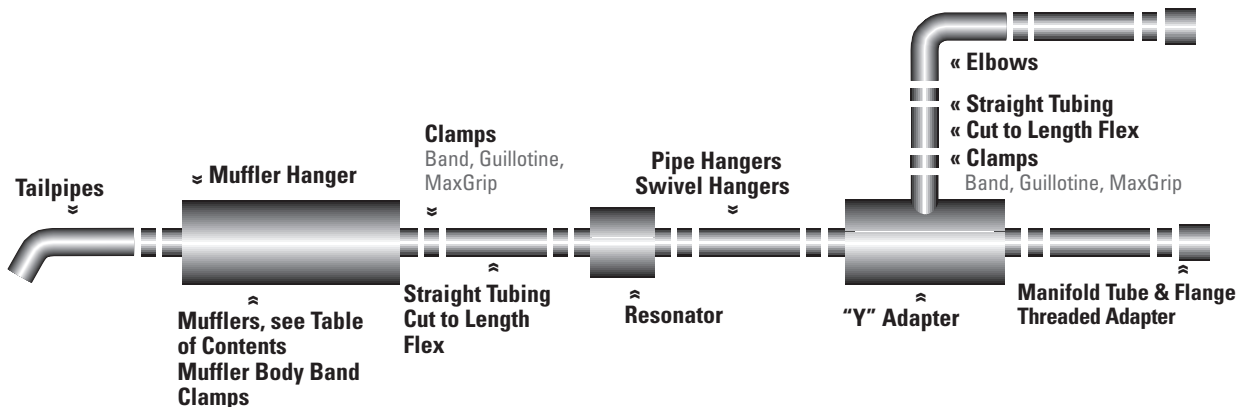

Exhaust Joint/Connections

Guide to Selecting the Best Clamp for the Exhaust Joint Connection

Type of Joint/Connection

Type of Clamp to Apply

(blue text = primary clamp recommendation)



Exhaust - tube to tube Standard OD

MaxGrip™ Bent Bolt
Stepped SealClamp™ (Aluminized or Stainless)
 Offset MaxGrip™ Bent Bolt
 SealClamp™ Flat Band (Aluminized or Stainless)
 Narrow Band (Aluminized)
 U-Bolt (any type, any material)

MaxGrip™ Bent Bolt



Offset MaxGrip™ Bent Bolt



Offset MaxGrip™ Bent Bolt (chevron design)

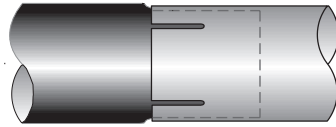

Slotted Tube to Shrunk OD

MaxGrip™ Bent Bolt
 SealClamp™ Flat Band (Aluminized or Stainless)
 Narrow Band (Aluminized)
 U-Bolt (any type, any material)

Flat Band SealClamp™

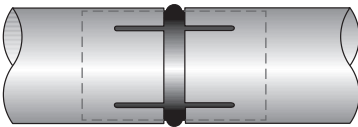

Slotted Tube to Slotted Tube (butt with internal connector)

MaxGrip™ Bent Bolt (2 required per connection)
 SealClamp™ Flat Band (Aluminized or Stainless)
 U-Bolt (any type, any material, 2 required per connection)

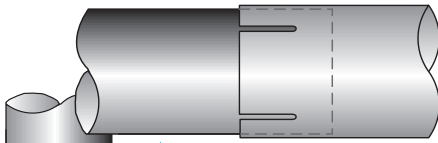

Horizontal Standard Tube to Slotted Tube (overlap)

MaxGrip™ Bent Bolt
Stepped SealClamp™ (Aluminized or Stainless)
 Offset MaxGrip™ Bent Bolt
 SealClamp™ Flat Band (Aluminized or Stainless)
 Narrow Band (Aluminized)
 U-Bolt (any type, any material)

Stepped SealClamp™

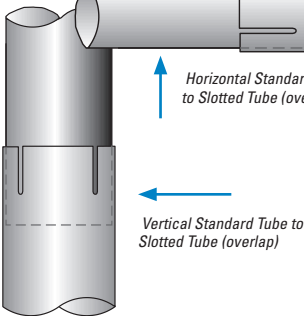

Vertical Standard Tube to Slotted Tube (overlap)

MaxGrip™ Bent Bolt
Offset MaxGrip™ Bent Bolt
 SealClamp™ Flat Band (Aluminized or Stainless)
 Stepped SealClamp™ (Aluminized or Stainless)
 U-Bolt (any type, any material)

U-Bolt Single, Round Band

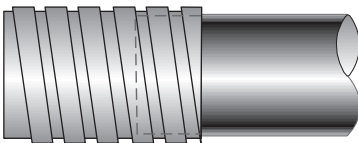

Standard Tube to Flex Tube

Stepped SealClamp™ (Aluminized or Stainless)
Offset MaxGrip™ Bent Bolt (with chevron)

U-Bolt Double, Flat Band

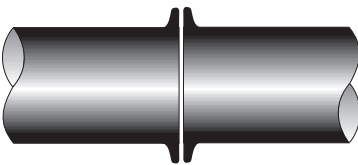

Flared, Lipped or Flange Connection

V-Band Clamps



Narrow Band Accuseal®



Based on the type of exhaust joint, your choice of clamp to apply may be limited. But, when you're looking to purchase a clamp based on specific performance features, the information below may be helpful as you try to select the proper clamp for the application.

Clamp Performance Rankings (10 high - 1 low)

Holding Force

- 10 **Offset MaxGrip™ Bent Bolt**
- 10 **V-band Clamp**
- 8 **MaxGrip™ Bent Bolt**
- 7 U-bolt (any style or material)
- 5 SealClamp™ (any style or material)
- 3 Narrow Band (aluminized)

Ease of Assembly

- 9 **MaxGrip Bent Bolt**
- 9 **Narrow Band (aluminized)**
- 8 **Offset MaxGrip Bent Bolt**
- 8 **Stepped SealClamp (aluminized or stainless)**
- 6 U-bolt (any style or material)
- 5 V-band Clamp
- 3 SealClamp Flat Band (aluminized or stainless)

Sealing Properties

- 10 **Stepped SealClamp (aluminized or stainless)**
- 9 **V-band Clamp**
- 8 **SealClamp Flat Band (aluminized or stainless)**
- 6 MaxGrip Bent Bolt
- 6 Offset MaxGrip Bent Bolt
- 5 Narrow Band (aluminized)
- 3 U-bolt (any style or material)

Appearance

- 10 **Stepped SealClamp (stainless)**
- 10 **V-band Clamp**
- 9 **Stepped SealClamp (aluminized)**
- 7 Offset MaxGrip Bent Bolt
- 7 Narrow Band (aluminized)
- 7 SealClamp Flat Band (stainless)
- 6 SealClamp Flat Band (aluminized)
- 5 MaxGrip Bent Bolt
- 5 U-bolt (double, flat band, chrome)
- 4 U-bolt (double, flat band, zinc)
- 4 U-Bolt (single, round band, chrome)
- 2 U-Bolt (double, round band, steel)
- 1 U-Bolt (single, round band, steel)

Tube Deformation

- 10 **V-band Clamp**
- 9 **Stepped SealClamp (aluminized or stainless)**
- 8 **Offset MaxGrip Bent Bolt**
- 8 **SealClamp Flat Band (aluminized or stainless)**
- 7 MaxGrip Bent Bolt
- 7 Narrow Band (aluminized)
- 2 U-bolt (double, flat band, chrome or zinc)
- 2 U-Bolt (double, round band, steel)
- 1 U-Bolt (single, round band, chrome or steel)

Price

- 10 **U-Bolt (single, round band, steel)**
- 9 **U-Bolt (double, round band, steel)**
- 8 **Narrow Band (aluminized)**
- 8 **SealClamp Flat Band (aluminized)**
- 8 **U-bolt (double, flat band, zinc)**
- 7 MaxGrip Bent Bolt
- 7 Offset MaxGrip Bent Bolt
- 7 SealClamp (other than aluminized)
- 6 U-Bolt (single, round band, chrome)
- 3 U-bolt (double, flat band, chrome)
- 1 V-band Clamp

What Features Are Most Important to You?

- _____ Holding Force
- _____ Ease of Assembly
- _____ Sealing Properties
- _____ Tube Deformation
- _____ Appearance
- _____ Price

This same information about our clamp options is available in flyer F111237.

Offset MaxGrip™ Bent Bolt Clamp

Donaldson introduces a series of bent bolt clamps for use on exhaust systems. The clamps are manufactured in heavy-duty aluminized steel to minimize corrosion.

- Clamps are reusable
- Aluminized band, stainless steel welds, deburred strap edges and finished with a heat resistance silver paint
- Self positioning for easy installation
- Protected by patents, both issued and pending



Offset MaxGrip Bent Bolt

For Muffler to Stack Connections

Nominal I.D.	Functional I.D. Range	Part Number
in mm	inches mm	
4.00 102	4.04-4.21 103-107	M002164
5.00 127	5.04-5.21 128-132	M001865



Offset MaxGrip Bent Bolt

For Tube to Flex Connections

Nominal I.D.	Functional I.D. Range	Part Number
in mm	inches mm	
4.00 102	4.04-4.21 103-107	M002134
5.00 127	5.04-5.21 128-132	M002135

Chevron design

MaxGrip™ Bent Bolt Clamp

- More holding power than any other clamp tested
- Donaldson patented technology
- Clamps are reusable
- Aluminized band, stainless steel welds and deburred strap edges finished with heat resistant black paint
- Use these clamps on slotted, lapped tube connections and manifold connections
- Ideal for use on Donaldson "captured" slots for maximum sealing
- Coated bolts and threads
- Hardened flange nuts



MaxGrip Bent Bolt Clamp

Nominal I.D.	Functional I.D. Range	Part Number
in mm	inches mm	
1.75 44	1.79-1.96 45-50	M001866
2.00 51	2.04-2.21 52-56	M001867
2.50 64	2.54-2.71 65-69	M001756
3.00 76	3.04-3.21 77-82	M001702
3.50 89	3.54-3.71 90-94	M001502
3.75 95	3.73-3.90 95-99	M001593
3.88 99	3.89-4.06 99-103	M001432
4.00 102	4.04-4.21 103-107	M001503
4.25 108	4.21-4.38 107-111	M001566
4.50 114	4.54-4.71 115-120	M001703
5.00 127	5.04-5.21 128-132	M001668
5.25 133	5.21-5.38 132-137	M001504
6.00 152	6.04-6.21 153-158	M001505
6.25 159	6.21-6.38 158-162	M001799
6.75 171	6.83-7.00 173-178	M001506

Recommended installation torque for any style bent bolt clamp:

- For clamps 3" or less - 25 ft. lbs. (34N•M)
- For clamps 3" and larger, on tube to tube connections - 35 ft. lbs. (48N•M)
- For clamps 3" and larger, on tube to casting connections - 50 ft. lbs. (68N•M)

SealClamp™ – The Original Band Clamp

Preformed & Flat Styles

Used to seal muffler inlets, outlets, elbow joints, flex pipes, and other system connections. Also minimizes noise and exhaust gas leaks.

SealClamps are easy to install! There's no need to weld or disconnect your exhaust system.

When installed, the wide band conforms to the shape of straight or flex pipe, and seals without distorting the pipe.

- For overlapping I.D. to O.D. slotted joints and flex tube
- Flat band style may be used for butt-style joints in light duty applications
- Nuts and bolts fit both 9/16" and 14mm wrenches
- Reduces noise and exhaust leaks
- Installs easily – no disconnecting or welding necessary
- Available in aluminized and stainless steel
- Stainless models have improved corrosion resistance and high temperature strength compared to aluminized

Installation instructions and torque recommendations: are available in the Shoptalk section, pages 16-17.



Stepped Preformed SealClamp

Stepped Preformed SealClamp

- Full 360° clamping area
- No flex pipe pinching
- Available in stainless and aluminized

O.D. Pipe		Stainless	Aluminized
in	mm		
2.50	64	X007829	
3.00	76	X007830	X007833
3.50	89	X007831	X007834
4.00	102	X007784	X007824
5.00	127	X007785	X007805
6.00	152	X009076	

U.S. Patent Nos. 6,116,659; 6,634,607 B2; 6,796,004 B2



Stepped Preformed SealClamp is Individually packaged with installation instructions

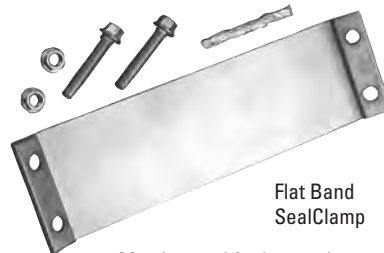

Flat Band SealClamp

May be used for butt-style joints in light duty applications

Flat Band SealClamp

O.D. Pipe		Stainless	Aluminized
in	mm		
2.00	51	X004536	
2.25	57	X004537	
2.50	64	X004476	
2.75	70	X004538	
3.00	76	X004478	
3.50	89	X004480	X006204
4.00	102	X004482	X006203
4.50	114	X004962	
5.00	127	X004484	X006202
6.00	152	X004539	



Donaldson Flat Band SealClamps are Individually packaged. Loose parts inside the shrink wrapped package.

Torcite®



Torcite® Lap Joint

O.D. Pipe in	mm	Aluminized	Donaldson SealClamp ¹	Stainless	Donaldson SealClamp ²	Polished Stainless
2.00	51			J190056		
2.25	57			J190057		
2.50	64			J190058	X007829	
2.75	70			J190059		
3.00	76	J009604	X007833	J190060	X007830	
3.50	89	J009605	X007834	J190061	X007831	
4.00	102	J009606	X007824	J009623	X007784	P222740
4.50	114	J190054		J190062		
5.00	127	J009607	X007805	J009624	X007785	P222741
6.00	152	J190055		J190063	X009076	P222742

1 - Equivalent Donaldson Aluminized Steel Stepped Preformed SealClamp™
2 - Equivalent Donaldson Stainless Steel Stepped Preformed SealClamp™

Standard U-Bolt Clamps



- Single, round band
- Cold rolled steel or Chrome
- 3/8-16" UNC-2A

O.D. Pipe in	mm	Steel	Chrome
2.00	51	P206403	
2.25	57	P206404	
2.50	64	P206405	
2.75	70	P206406	
3.00	76	P206407	
3.25	83	P206408	
3.50	89	P206409	
4.00	102	P206410	J009486
5.00	127	P206411	J009487
6.00	152	P207667	



- Double, round band
- 3/8-16" UNC-2A

Accuseal®



O.D. Pipe in	mm	Aluminized	304 Stainless
2.00	51	J000204	
2.25	57	J000205	
2.50	64	J000206	
2.75	70	J000207	
3.00	76	J000200	P238111
3.50	89	J000201	
4.00	102	J000202	P238112
4.50	114	J000208	
5.00	127	J000203	P238113
6.00	152	J000209	

Easyseal®



May be used for lap and butt-style joints

O.D. Pipe in	mm	304 Bright Stainless	Donaldson SealClamp ¹
2.00	51	J000210	X004536
2.25	57	J000212	X004537
2.50	64	J000211	X004476
2.75	70	J000213	X004538
3.00	76	J000214	X004478
3.50	89	J000215	X004480
4.00	102	J000216	X004482
4.50	114	J000219	X004962
5.00	127	J000217	X004484
6.00	152	J000218	X004539

1 - Equivalent Donaldson Stainless Steel Flat Band SealClamp™

O.D. Pipe in	mm	Steel
2.00	51	J000220
2.25	57	J000222
2.50	64	J000221
2.75	70	J000224
3.00	76	J000227
3.50	89	J000228
4.00	102	J000230
4.50	114	J000231
5.00	127	J000232
6.00	152	J000233



- Double, flat band
- 3/8-16" UNC-2A

O.D. Pipe in	mm	Zinc	Chrome
3.00	76	P206600	P206608
3.50	89	P206601	P206609
4.00	102	P206602	P206610
5.00	127	P206603	P206611
6.00	152	P207596	P207598

Torcite®, Accuseal® and Easyseal® are a registered trademarks of Torca Co.

Muffler Body Band Clamps for Traditional Mufflers



- Aluminized mild steel with high temperature black finish (matches finish on off-road mufflers)
- Band width 1.25" (32mm)
- Intended for traditional mufflers only. For emissions product needs, see Heavy-Duty Muffler Body Bands

Muffler Body Band Clamps

--- A ---		--- B ---		--- C ---		Part Number
in	mm	in	mm	in	mm	
6.00	152	3.75	95	3.75	95	M002117
6.62	168	4.00	102	4.00	102	M002118
8.50	216	5.00	127	5.00	127	M002119
9.00	229	5.50	140	5.50	140	M002120
10.08	256	6.00	152	6.00	152	M002121
11.06	281	6.50	165	6.50	165	M002122
11.84	301	7.00	178	7.00	178	M002123

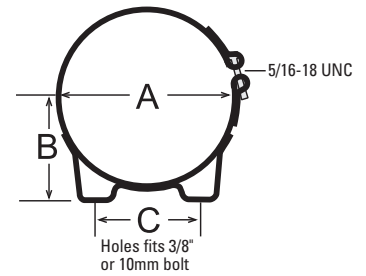

Heavy-Duty Muffler Body Band Clamps

Clamp Notes:

- Pinch bolts are not included
- Most use 3/8-1-1/2" long grade 5 or 8 grade bolts
- Band width 2.00" (unless noted)
- Reuse existing frame mounting bolts
- Materials is zinc-plated mild steel.

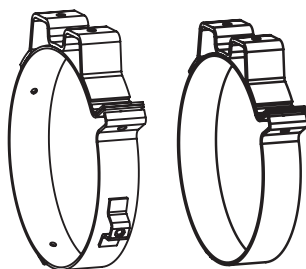

P227803

P230281
No heat shield
stand off

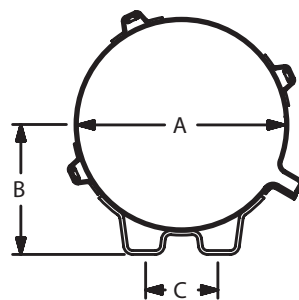

W-Foot Body Bands

- Use for vertical or horizontal mounting
- Bolts not included

For Heat Shield Applications

--- A ---		--- B ---		--- C ---		Part Number
in	mm	in	mm	in	mm	
10.00	254	6.28	160	3.5	89	P227803
11.00	269	6.50	165	6.5	165	P229513
13.00	330	7.50	191	6.5	165	P230283

No Heat Shield Applications

--- A ---		--- B ---		--- C ---		Part Number
in	mm	in	mm	in	mm	
10.00	254	6.28	160	3.50	89	P230282
11.00	269	6.50	165	6.50	165	P230281
13.00	330	7.50	191	6.50	165	P230045

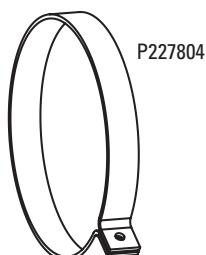

P227804

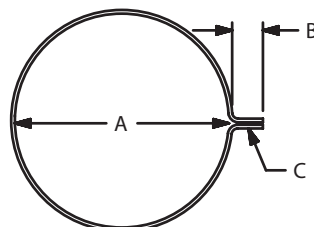

Band width 1.5" (38mm)

Muffler Body Bands for Schools Buses

--- A ---		--- B ---		--- C ---		Part Number
in	mm	in	mm	in	mm	
10.00	256	1.75	44	0.40	10	P228241 ¹
11.00	279	1.75	44	0.40	10	P227804 ²

- 1 - Bluebird conventional bus with Cat Engine Works
- 2 - Bluebird rear engine bus

Heat Sleeves & Heat Wrap Flex Tubing

ACCESSORIES

Heat Sleeves

Slips onto 3" to 5" dia. pipe



Length	Part Number
12"	P235764
18"	P235765
24"	P235766

Heat Wrap

2" wide roll, easy to install on any pipe



Length	Part Number
2"X50' (600") Roll	P235767

Sleeve & Wrap Clamps

Wrap clamps make installation easy!
No tools needed.



Length	Part Number
2 PC of 18" Long Clamp	P235768
12 PC of 18" Long Clamp	P235769

Heat sleeves or heat wrap could reduce the outside temperature of a bare pipe by up to 300°F to 400°F.

Flex Tubing

- Flex tubing (and cut lengths) should be installed in a half extended state. Donaldson flex tubing ships in the half extended state.
- Material thickness for stainless and galvanized is 0.015"

Flex Tubing

--- I.D. --- in	--- mm	10 ft. (3 m) Lengths		25 ft. (7.6 m) Lengths ¹	
		Stainless	Galvanized	Stainless	Galvanized
2.00	51	P226151	P226148		
2.50	64	P226152	P226149		
3.00	76	P226144	P226140	P226132	P226129
3.50	89	P226145	P226141	P226133	P226154
4.00	102	P226146	P226142	P226156 ²	P226155 ²
5.00	127	P226147	P226143	P226158 ²	P226157 ²
6.00	152	P226153 ¹	P226150 ¹		

¹ - Size exceeds shipping limits by North American small package carriers. This item must ship by truck.

² - Shipped on pallet, product is not boxed.

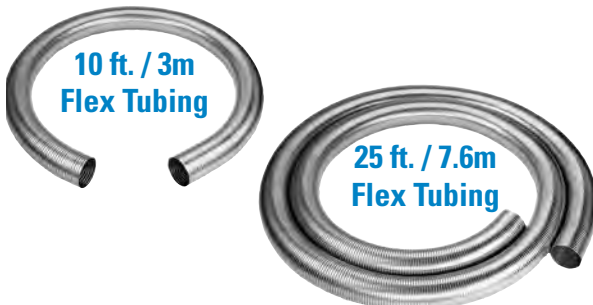

Cutting and installation instructions for Flex Tubing:

are available in the Shoptalk section, page 18.

Standard Cut to Length Flex



- Deburred ends
- Sized by flex I.D.
- Stainless and galvanized material thickness - 0.015"
- Measured fully extended



Close-up of deburred edge

Standard Cut to Length Flex

--- I.D. ---		Overall Length		Stainless	Galvanized		
in	mm	in	mm				
3.00	76	12.00	305	J240003			
		18.00	457	P206552			
		24.00	610	J240004			
3.50	89	12.00	305	J240005			
		18.00	457	P206553			
		24.00	610	J024850			
4.00	102	12.00	305	J240006	P224479		
		18.00	457	P206554	J024754		
		24.00	610	J024836	J024835		
		36.00	914	J034673	J034743		
		5.00	127	12.00	305	J240007	P224481
5.00	127	18.00	457	P206555	J024755		
		24.00	610	J024838	J024837		
		36.00	914	J034674	J034744		
		6.00	152	18.00	457	P206556	
		30.00	762	P206559			

Flex Cut Lengths with Finished Ends



- Flex tubing (and cut lengths) should be installed in a half extended state. Donaldson flex tubing ships in the half extended state.
- One end O.D., one end I.D. slotted
- Sized by flex I.D.
- Overall length includes finished ends
- Welded tube ends

Cut-to-Length Flex - Finished Ends

--- I.D. ---		Overall Length		Galvanized
in	mm	in	mm	
3.00	76	18.00	457	P206544
4.00	102	18.00	457	P206546
5.00	127	18.00	457	P206547

Long-Life Cut to Length Flex



- Improved flexibility
- Consistent product quality—optimized material choice/consistency
- Heavier gauge stainless material over standard flex (0.018" gauge)
- Up to 8 times longer life than conventional flex
- Less leakage and lower emissions during truck start up
- Simplified installation—installation strip and flow direction
- Ends square cut and deburred
- Installation length indicator
- 12 month/120,000 mile/200,000 km warranty (on-highway vehicles only)

Donaldson patented technology

Long-Life Flex

--- I.D. ---		Mid Length ¹		Stainless
in	mm	in	mm	
4.00	102	12.00	305	P224412
		15.00	381	P224415
		18.00	457	P224418
		21.00	533	P224421
5.00	127	15.00	381	P224515
		18.00	457	P224518
		21.00	533	P224521

1 - Length measured in half compressed state

Recommended clamps:
Preformed SealClamp or Offset MaxGrip Bent Bolt

V-Band Clamps

V-Band Clamps for Large Diameter Mufflers



- The unique design reduces service time creates a reliable, leak-free seal between components
- Piloted v-insert section, facilitates reassembly and alignment for clamping

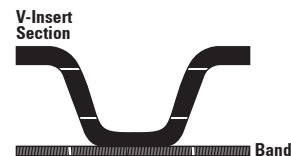
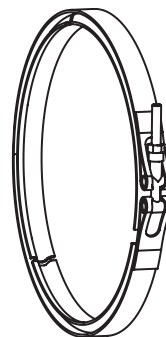

- Body Dia. - in mm	Part Number
10.0 254	P227750
11.0 279	P212925
13.0 330	P229851
14.0 356	P235305

V-Band Clamps for Pipes and Turbo Housing Flanges



- Used to connect vehicle exhaust pipe flange to turbo or engine manifold
- May also hold the turbo housing flanges
- Built to withstand high temperatures produced by heavy-duty engines/turbos
- Manufactured to the highest tolerances and meet or exceed OEM specifications for material and quality standards

Cat	Part Number	Nominal Diameter		V-Insert Sections					
		in	mm	--- A ---		--- B ---		--- C ---	
3406, 3406B, 3176	P206607	5.88	149	0.40	10	0.28	7	0.88	22
3176T	P222018	4.75	121	0.40	10	0.28	7	0.88	22

Cummins	Part Number	Nominal Diameter		V-Insert Sections					
		in	mm	-- A --		-- B --		-- C --	
B Series, #3903652	J009618	3.21	82	0.26	7	0.14	4	0.75	19
C Series	P222017	4.13	105	0.26	7	0.14	4	0.75	19
L10, M11	P222018	4.75	121	0.40	10	0.28	7	0.88	22
V555, V902, V903	J009612	3.88	99	0.40	10	0.28	7	0.88	22

Detroit Diesel	Part Number	Nominal Diameter		V-Insert Sections					
		in	mm	-- A --		-- B --		-- C --	
6-71T, 12V71, 8.2N, 8.2T	P206606	4.81	122	0.21	5	0.28	7	0.88	22
6V53, 6V71, 6V92, 8V92	P206604	3.82	97	0.21	5	0.28	7	0.88	22
8.2 N, #2069773	J009611	4.06	103	0.24	6	0.28	7	0.88	22
8V71T	P213191	5.81	148	0.21	5	0.28	7	0.88	22
8V71T, 16V-71, 16V92T, 6V92, 8V92	P210110	5.25	133	0.21	7	0.14	4	0.75	19
8V92, 8V71, 4-53, 6-71	P206605	4.5	114	0.21	5	0.28	7	0.88	22
Series 60	P206607	5.88	149	0.40	10	0.28	7	0.88	22

IH	Part Number	Nominal Diameter		V-Insert Sections					
		in	mm	-- A --		-- B --		-- C --	
DT466	J009613	4.33	110	0.21	5	0.28	7	0.88	22

Mack	Part Number	Nominal Diameter		V-Insert Sections					
		in	mm	-- A --		-- B --		-- C --	
48RU2341, 4ME21409	J009614	4.61	117	0.16	4	0.28	7	0.75	19

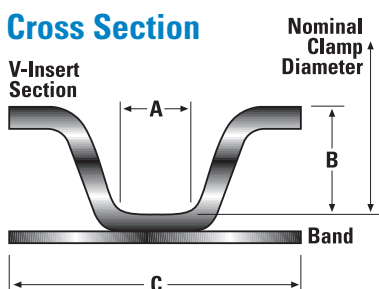

Flared Connectors - All 16 ga. Aluminized Steel

O.D. -- A -- in (mm)	I.D. -- B -- in (mm)	O.D. -- C -- in (mm)	-- D -- in (mm)	E	-- F -- in (mm)	Flared Connector	V-Band Clamp	Application
3.00 (76)	3.02 (77)	3.62 (92)	4.00 (102)	22°	0.75 (19)	P207619	P206604	DD 6V 71
3.50 (89)	3.63 (92)	4.25 (108)	4.00 (102)	22°	0.75 (19)	P207581	P206605	8V-71-VT-555
4.00 (102)	4.02 (102)	4.75 (121)	4.00 (102)	22°	0.75 (19)	P207620	P206606	6 71-12V 71

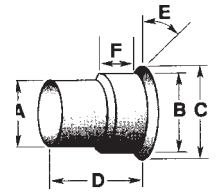

O.D. -- A -- in (mm)	I.D. -- B -- in (mm)	O.D. -- C -- in (mm)	-- D -- in (mm)	E	-- F -- in (mm)	Flared Connector	V-Band Clamp
3.50 (89)	3.52 (89)	4.19 (106)	4.75 (121)	45°	2.12 (54)	P207568	P206605
4.00 (102)	4.02 (102)	4.70 (119)	4.75 (121)	45°	2.50 (64)	P207567	P206606
5.00 (127)	5.02 (128)	5.70 (145)	4.75 (121)	45°	3.00 (76)	P207566	P206607



P207568, P207567, or P207566

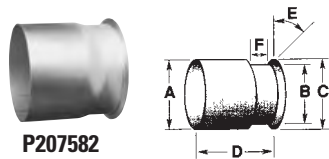

O.D. -- A -- in (mm)	I.D. -- B -- in (mm)	O.D. -- C -- in (mm)	-- D -- in (mm)	E	-- F -- in (mm)	Flared Connector	V-Band Clamp	Application
4.00 (102)	3.63 (92)	4.25 (108)	3.81 (97)	22°	0.75 (19)	P207582	P206605	8V 71

O.D. -- A -- in (mm)	O.D. -- C -- in (mm)	-- D -- in (mm)	E	Flared Connector	V-Band Clamp
3.12 (79)	3.75 (95)	1.50 (38)	20°	P206612	P206604
3.00 (96)	3.92 (100)	2.25 (57)	20°	J009479	J009611
3.75 (95)	4.19 (106)	1.50 (38)	20°	P206613	
3.50 (89)	4.29 (109)	1.50 (38)	20°	J009391	P206605
4.12 (105)	4.75 (121)	1.50 (38)	22°	P206614	P206606
5.00 (127)	5.50 (140)	5.25 (133)	45°	J009393	
	5.69 (145)	3.00 (76)	20°	P206615	P206607
	5.86 (149)	5.00 (127)	20°	J009629 ¹	

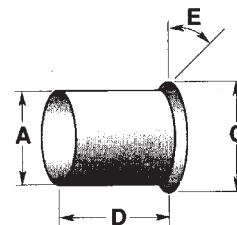

J009629
Adapter with
Pyrometer Fitting
(1/4" NPT)

1 - Adapter has pyrometer fitting

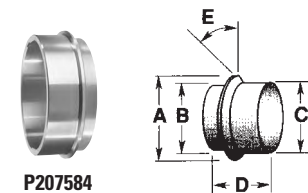

Flared Connector

O.D. -- A -- in (mm)	I.D. -- B -- in (mm)	O.D. -- C -- in (mm)	-- D -- in (mm)	E	Flared Connector	V-Band Clamp	Application
5.01 (127)	4.25 (108)	4.80 (122)	1.94 (49)	20°	P207584	P210110	Air Research Turbo

Marmon Flange & Flare Connectors



Marmon Flare
P235792
P235793

V-Band Clamp
P222018
P206607

Marmon Flange
P235796
P235797

Join parts together for leakproof and serviceable connections with a V-Band Clamp. All components made from 304 Stainless Steel.

	O.D. -- A -- in (mm)	I.D. -- B -- in (mm)	O.D. -- C -- in (mm)	-- D -- in (mm)	Part No.	V-Band Clamp
Marmon Flare	4.00 (102)	—	4.63 (118)	3.00 (76)	P235792	P222018
	5.00 (127)	—	5.63 (143)	3.00 (76)	P235793	P206607
Marmon Flange	4.72 (120)	3.80 (97)	4.00 (102)	3.00 (76)	P235796	P222018
	5.72 (145)	4.80 (122)	5.00 (127)	3.00 (76)	P235797	P206607

I.D. - I.D.

Reduces O.D. pipe of different sizes. 16 gauge aluminized steel.



-- I.D. -- in mm	-- I.D. -- in mm	Length in mm	Part Number
2.50 64	2.00 51	6.00 152	P207382
2.75 70	2.50 64	6.00 152	P207385
3.00 76	2.50 64	6.00 152	P206313
	2.75 70	6.00 152	P207386
3.50 89	3.00 76	6.00 152	P206314
4.00 102	3.00 76	6.00 152	P206315
	3.50 89	8.00 203	P206316
5.00 127	4.00 102	6.00 152	P206317
6.00 152	5.00 127	8.00 203	P206318



I.D. - O.D.

Reduces larger O.D. pipe to smaller I.D. pipe. Also used as muffler bushing or manifold outlet. 16 gauge aluminized steel.



-- I.D. -- in mm	-- O.D. -- in mm	Length in mm	Part Number
2.50 64	2.00 51	6.00 152	P207397
3.00 76	2.50 64	6.00 152	P206319
	2.75 70	6.00 152	P207401
3.50 89	3.00 76	6.00 152	P206320
4.00 102	3.00 76	6.00 152	P206321
	3.50 89	6.00 152	P206322
4.50 114	4.00 102	6.00 152	J190046
5.00 127	4.00 102	6.00 152	P206323
6.00 152	5.00 127	6.00 152	P207402



O.D. - I.D.

Reduces larger I.D. pipe to smaller O.D. pipe. 16 gauge aluminized steel.



-- O.D. -- in mm	-- I.D. -- in mm	Length in mm	Part Number
2.50 64	2.00 51	6.00 152	P207389
2.50 64	2.25 57	4.00 102	J008942
3.00 76	2.50 64	6.00 152	P206324
3.50 89	3.00 76	6.00 152	P206325
4.00 102	3.00 76	6.00 152	P206326
	3.50 89	6.00 152	P206327
4.50 114	4.00 102	6.00 152	J190041
5.00 127	4.00 102	6.00 152	P206328
6.00 152	5.00 127	6.00 152	P207394



Connectors

I.D. - I.D.

Connects O.D. pipes of the same size. 16 gauge aluminized steel.



--- I.D. --- in mm	-- Length -- in mm	Part Number
2.00 51	6.00 152	P207405
2.50 64	6.00 152	P206371
3.00 76	6.00 152	P206372
3.50 89	6.00 152	P206373
4.00 102	6.00 152	P206374
5.00 127	6.00 152	P206375
6.00 152	6.00 152	P207408

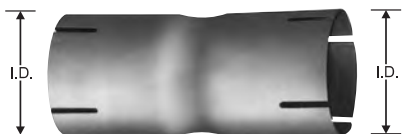

I.D. - O.D.

Connects O.D. and I.D. pipes of the same size. 16 gauge aluminized steel.



I.D.-O.D. in mm	-- Length -- in mm	Part Number
2.00 51	6.00 152	P207411
2.50 64	6.00 152	P206366
2.75 70	6.00 152	P207413
3.00 76	6.00 152	P206367
3.50 89	6.00 152	P206368
4.00 102	8.00 203	P206369
5.00 127	8.00 203	P206370
6.00 152	6.00 152	P207414



O.D. - O.D.

Connects I.D. pipes of the same size. Also used on manifold outlet. Connector has tube stop. 16 gauge aluminized steel.

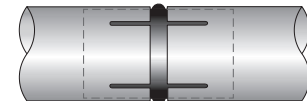

O.D.-O.D. in mm	-- Length -- in mm	Part Number
2.50 64	6.00 152	P206361
3.00 76	6.00 152	P206362
3.50 89	6.00 152	P206363
4.00 102	8.00 203	P206364
5.00 127	8.00 203	P206365

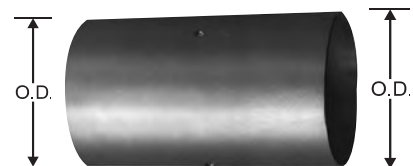

O.D. - O.D.

Reduces I.D. pipe of different sizes.
16 gauge aluminized steel.

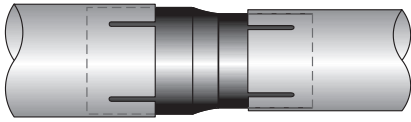

-- O.D. -- in	mm	-- O.D. -- in	mm	Length in	mm	Part Number
3.00	76	2.50	64	6.00	152	J190042
3.50	89	3.00	76	6.00	152	J190044
4.00	102	3.00	76	6.00	152	J009648
		3.50	89	6.00	152	J190045
5.00	127	4.00	102	8.00	203	J009649
6.00	152	5.00	127	8.00	203	J009650



Standard "Y" Adapter Pipe

- 16 gauge aluminized steel construction

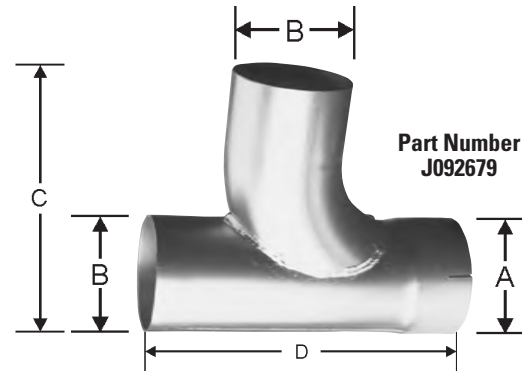

- A (I.D.) - in	mm	- B (O.D.) - in	mm	----- C ----- in	mm	----- D ----- in	mm	Part Number
4.00	102	4.00	102	10.82	275	15.75	400	J092679
5.00	127	5.00	127	10.50	267	16.00	381	J092689

Splitter Tee Adapter

- Converts single exhaust pipe to dual exhaust system
- 16 gauge aluminized steel

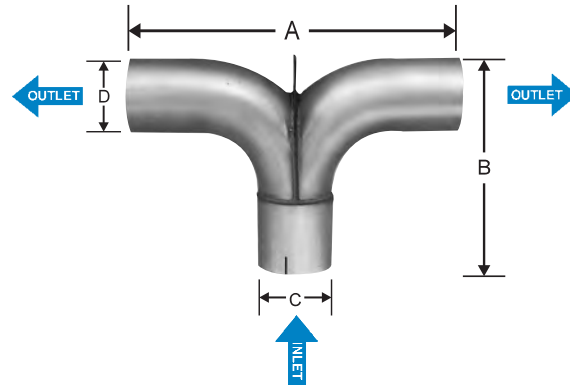

(A) in	mm	(B) in	mm	Truck ID (C) in	mm	Leg OD (D) in	mm	Part Number
17.50	445	12.00	305	4.00	102	4.00	102	P206297
26.00	660	14.00	356	5.00	127	5.00	127	P206298

Band width 1.5" (38mm)

Tilt Cab Ball & Cone Connectors

- 16 gauge aluminized steel construction



Ball Connector
P205976 - 4" Pipe I.D.
P206300 - 5" Pipe I.D.



Cone Connector
P205979 - 4" Pipe O.D.
P206299 - 5" Pipe O.D.

Stack Caps

The exhaust stack cap is designed to be mounted on top of a vertical straight exhaust stack pipe and prevents water and debris from entering the stack. The stack cap is not water-tight during pressure washes or under strong wind conditions. Use zinc plated or chrome stack caps where exhaust gas temperatures are less than 900°F/482°C. For exhaust gas temperatures above 900°F/482°C, use 304 stainless steel stack caps.

For proper installation, the exhaust cap needs clearance for counterweight rotation and should be installed at a point that allows for this without interference.

The exhaust cap should be placed on the outer diameter of the stack pipe. Allow approximately ¼" of clearance between cap and top of stack.

O.D. Pipe Size in	mm	Zinc Plated	Chrome	304 Stainless
1.50	38	P270530		
1.75	44	P270531		
2.00	51	P270532		M002480
2.25	57	P270533		
2.50	64	P270534		M002482
2.75	70	P270535		
3.00	76	P270536	P271507	M002484
3.50	89	P270538		M002485
4.00	102	P270539	P270837	M002486
4.50	114	P270540		M002487
5.00	127	P270541	P270838	M002488
5.50	140	P270542		
6.00	152	P270543	P271511	M002490
8.00	203			M002491

P270539 - Zinc Plated



P270837 - Chrome



- Single bolt mount
- Nylon stop for quiet operation (zinc and chrome only)
- All metal construction (304 stainless steel only)

Universal Swivel Hanger

- Heavy reinforced rubber pad
- Double pivot design improves flexibility and installation
- One piece construction installs in seconds
- 11 gauge cold rolled steel construction



P206507 - 9" length
J008167 - 13" length

Universal Mounting Bracket

- For 4" (102 mm) and (127 mm) pipes
- 3/8"-16 UNC-2A(4)
- Heavy gauge hot rolled steel construction
- Expands to 10" (254mm)

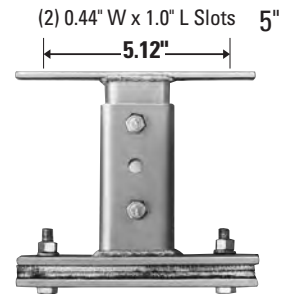

P207784

Pipe Hangers

- Pre-punched holes (0.41" dia.) for easy installation
- 12 gauge hot rolled steel construction
- 12" overall bar length, width 0.88"
- 3/8"-16 UNC bolts/nuts included

Pipe Hangers

Pipe Dia. in	mm	Part Number
3.00	76	P206523
3.50	89	P206524
4.00	102	P206525
5.00	127	P206526



Muffler Guards

- Bright stainless shipped with protective film on one side
- Order clamps separately, unless noted otherwise



Muffler Guards

-- Muffler Diameter --		Style	-- Length --		Wrap	Bright Stainless
in	mm		in	mm		
8.50 - 9.00	216-229	2	51.00	1295	180°	P206540
8.50 -10.00	216-254	1	45.00	1143	270°	X005207 ¹
		2	51.00	1295	180°	J009429
10.00-10.50	254-267	2	51.00	1295	180°	P206542

1 - Includes two (2) clamps

Muffler Guard Clamps

- Two clamps required for installation
- Clamps sold separately
- Chrome plated (unless noted)

Muffler Guard Clamps

Muffler Dia. in	mm	Part Number
8.50	216	P206510
9.00	229	P206511
10.00	254	P206512

1 - Zinc plated



Muffler Hangers

- For vertical and horizontal installations
- 11 gauge steel construction
- 12" overall bar length
- 3/8"-16 UNC bolts/nuts included

Muffler Hangers

-- Muffler Dia. -- in	mm	Part Number
6.00	152	P206515
7.00	178	P206516
8.50	216	P206517
9.00	229	P206518
10.00	254	P206519
8.25x11.50	210x292	P206520
10.00x15.00	254x381	P206521
11.00	279	P224841



Heavy Duty Muffler Mounting Straps

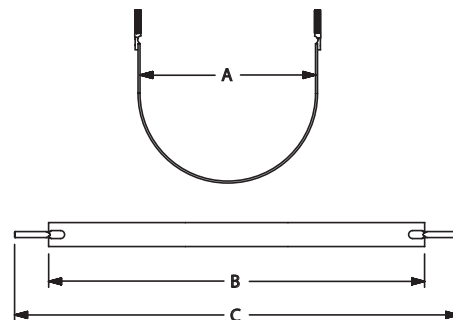
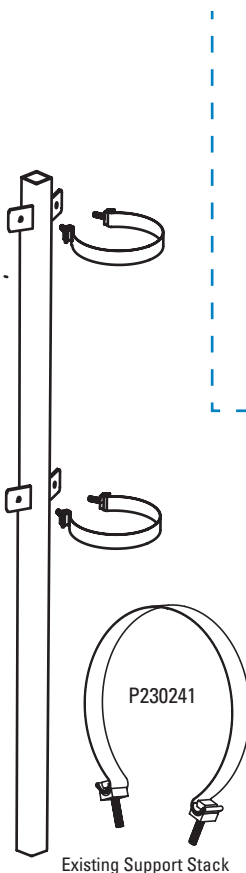

- Works with vertical mount Mack trucks when converting to a 10" diameter muffler.

	--- A ---		--- B ---		--- C ---		Part Number
in	mm	in	mm	in	mm		
10.00	256	25.40	645	30.20	767	P230241	

Horizontal Hangers for Round Mufflers

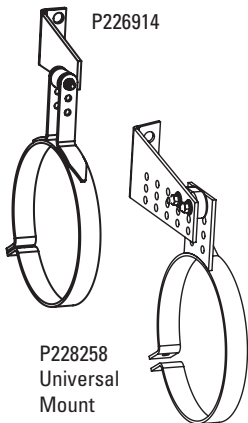

---- A ----		---- B ----		---- C ----		---- D ----		---- E ----		Part Number
in	mm	in	mm	in	mm	in	mm	in	mm	
10.00	256	9.31	236	5.75	146	1.75	44	0.38	10	P227728
11.00	279	10.16	258	6.00	152	2.50	66	0.75	19	P226914 ¹
11.00	279	6.50-10.50	165-268	5.50-9.00	140-229	1.00/2.50	25/66	0.50/0.75	13/19	P228258 ²
13.00	330	6.50-10.50	165-268	5.50-9.00	140-229	1.00/2.50	25/66	0.50/0.75	13/19	P230046 ²

1 - Works with International School bus when converting to round muffler
 2 - Universal mount

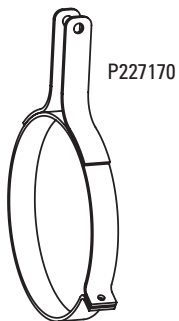

---- A ----		---- B ----		---- C ----		---- D ----		Part Number
in	mm	in	mm	in	mm	in	mm	
10.00	256	10.78	274	0.56	14	1.31	33	P230284
11.00	279	10.78	274	0.56	14	1.31	33	P227170 ¹

1 - Works with 2004 Thomas Conventional with Mercedes Benz Engine

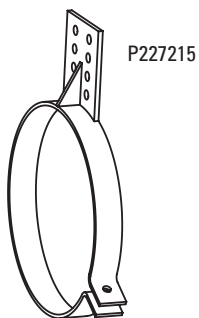

• Universal application

---- A ----		---- B ----		---- C ----		---- D ----		Part Number
in	mm	in	mm	in	mm	in	mm	
11.00	279	6.25 / 9.25	175	44	0.50	13		P227215
13.00	330	7.25 / 10.25	175	44	0.50	13		P230047

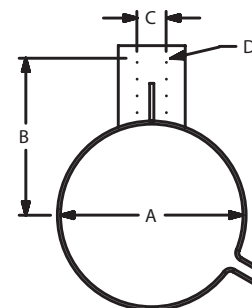
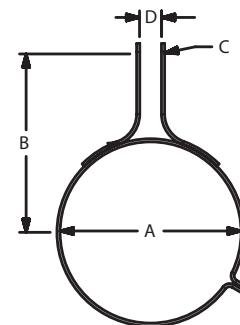
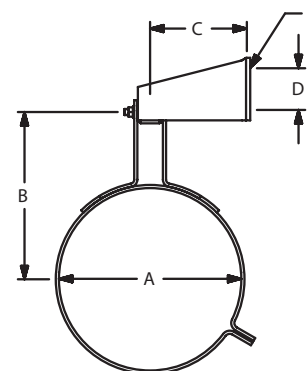

Horizontal Hanger for Oval Mufflers

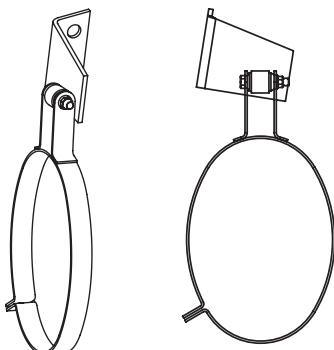

Part No. P229114

- Unique for Front Engine International School Bus with Oval DOC muffler
- Direct replacement to OE hanger
- Works with oval muffler diameter of 8.25" x 11.5"



Grab Handle

- For use with muffler and pipe guards
- Chrome plated

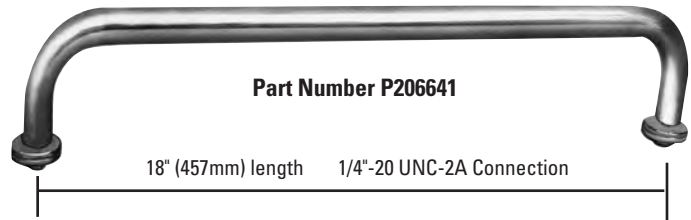

Manifold Tube

- For manifold connections
- Size: 4" (102mm) O.D.
- Basic application: Cummins NH series engines
- 16 gauge cold rolled steel



Manifold Tube
Part Number
P206617

Manifold Flange

- 16 gauge cold rolled steel



Manifold Flange
Part Number P206616

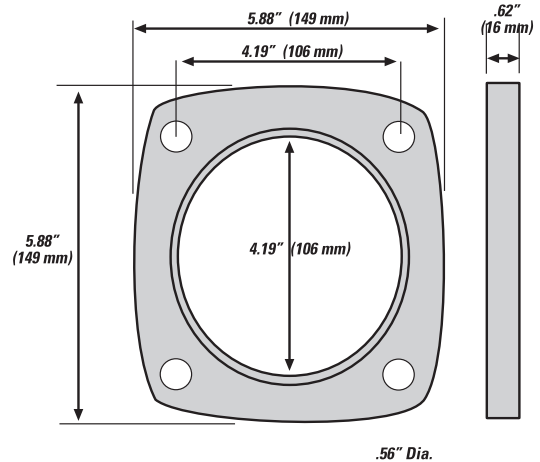

Threaded Adapter



--- O.D. ---		Thread (NPT)		Part
inch	mm	inch	mm	Number
3.00	76	3.00	76	J009514
3.50	89	3.50	89	J009516
4.00	102	4.00	102	J009518

NPT - National Pipe Thread

Universal Pipe Guards & Clamps

- 180° wrap coverage
- 48" (1219mm) length
- Polished stainless steel
- Shipped with protective film on one side
- Clamps must be ordered separately

Universal Pipe Guards & Clamps

Pipe Dia. in	mm	Stainless ¹	Clamp Kit
4.00	102	P206543	P206508
5.00	127	P206543	P206509
6.00	152	P206543	P224492

1 - Requires clamp kit for installation



Pipe Guard Clamp Kits

- Two clamps per kit
- Chrome plated
- 12 gauge cold rolled steel construction

90° O.D. - I.D.

- 16 gauge aluminized or chrome plated steel
- One end O.D., one end I.D. slotted

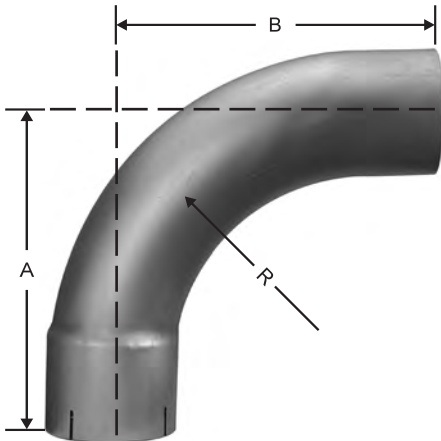

Diameter O.D.-I.D.		Leg Length (A)		Leg Length (B)		Center Line Radius (R)		Aluminized	Chrome
in	mm	in	mm	in	mm	in	mm		
2.00	51	9.00	229	9.00	229	5.00	127	P207333	
		6.38	162	6.38	162	4.00	102	J008671	
2.50	64	6.25	159	6.25	159	4.00	102	P206339	
		12.00	305	12.00	305	5.00	127	P207335	
2.75	70	6.38	162	6.38	162	5.00	127	P216172	
3.00	76	8.00	203	8.00	203	5.00	127	P206340	
		14.00	356	14.00	356	5.00	127	P206341	
3.50	89	9.00	229	9.00	229	5.00	127	P206342	
		12.00	305	12.00	305	5.00	127	P224669	
		16.00	406	16.00	406	5.00	127	P206343	
4.00	102	8.00	203	8.00	203	4.50	114		P224671
		8.00	203	8.00	203	5.00	127	J008681	
		10.00	254	10.00	254	4.50	114		P207345
		10.00	254	10.00	254	7.00	178	P206344	
		18.00	457	18.00	457	4.50	114		P206353
		18.00	457	18.00	457	7.00	178	P206345	
4.50	114	25.00	635	32.00	813	7.00	178	P207338	
		12.00	305	12.00	305	6.00	152	J190002	
5.00	127	8.50	216	8.50	216	5.50	140	J190003	J190004
		11.00	279	11.00	279	5.50	140	P207339	J009547
		15.00	381	15.00	381	7.50	191		P207346
						10.00	254	P206347	
		18.00	457	18.00	457	7.50	191		P206354
				10.00	254	P206348			
6.00	152	25.00	635	32.00	813	10.00	254	P207340	
		15.00	381	15.00	381	10.00	254	P207341	
		26.00	660	26.00	660	10.00	254	P206350	

90° O.D. - O.D.

- 16 gauge aluminized or chrome plated steel
- Both ends O.D.

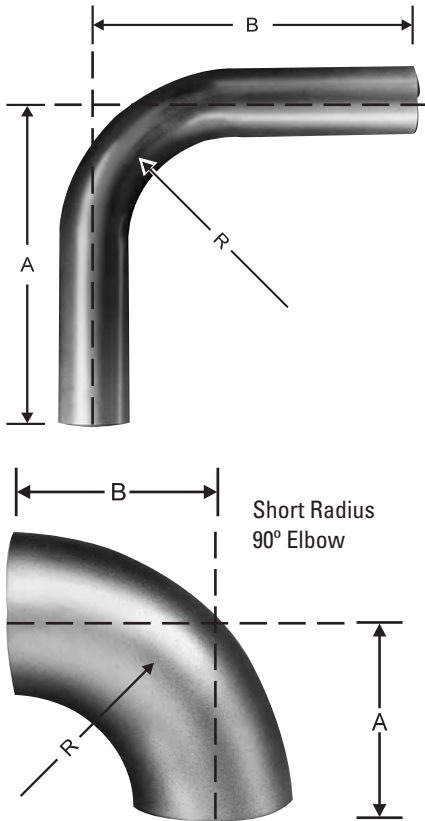

Diameter O.D.-O.D.		Leg Length (A)		Leg Length (B)		Center Line Radius (R)		Aluminized	Chrome	Stainless		
in	mm	in	mm	in	mm	in	mm					
2.00	51	9.00	229	9.00	229	5.00	127	P207322				
2.25	57	10.00	254	10.00	254	4.00	102	P216174				
2.50	64	12.00	305	12.00	305	5.00	127	P207324				
2.75	70	12.00	305	12.00	305	5.00	127	P207325				
3.00	76	3.50	89	3.50	89	3.00	76	P206397				
		6.00	152	6.00	152	4.00	102	P207362				
		10.00	254	10.00	254	5.00	127	P207326				
		14.00	356	14.00	356	5.00	127	J190013				
3.50	89	4.00	102	4.00	102	4.00	102	P206398				
		8.00	203	8.00	203	4.00	102	P207363				
		9.00	229	9.00	229	5.00	127	J190014				
		12.00	305	12.00	305	5.00	127	P207327				
		16.00	406	16.00	406	5.00	127	P207328				
4.00	102	4.50	114	4.50	114	4.00	102	P206399				
		4.50	114	4.50	114	4.50	102			P235771 ¹		
		8.00	203	8.00	203	4.00	102	P207364				
		9.00	229	15.00	381	4.00	102	P207330				
		12.00	305	12.00	305	4.00	102	P206346				
		18.00	457	18.00	457	4.50	114		J190016			
						7.00	178	P207329				
		25.00	635	25.00	635	5.00	127	J190017				
		5.00	127	5.50	140	5.50	140	5.50	140	P206400		P235772 ¹
				10.00	254	10.00	254	5.50	140	P207365		
		11.00	279	16.00	406	5.50	140	P207332				
		15.00	381	15.00	381	7.50	191		J190019			
						10.00	254	P207331				
		20.00	508	20.00	508	10.00	254	P206349				
		25.00	635	25.00	635	8.00	203	J190020				
6.00	152	6.50	165	6.50	165	6.00	152	P207361				
		10.00	254	10.00	254	6.00	152	P207366				
		23.00	584	23.00	584	10.00	254	P216175				

1- 439 Stainless Steel

67° O.D. - O.D.

- 16 gauge aluminized steel
- Both ends O.D.
- For Peterbilt Truck

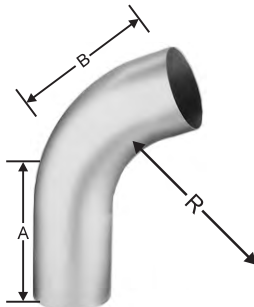

Diameter O.D.-O.D.		Leg Length (A)		Leg Length (B)		Center Line Radius (R)		Part Number
in	mm	in	mm	in	mm	in	mm	
5.00	127	7.50	191	11.00	279	8.00	203	J009560

60° O.D. - O.D.

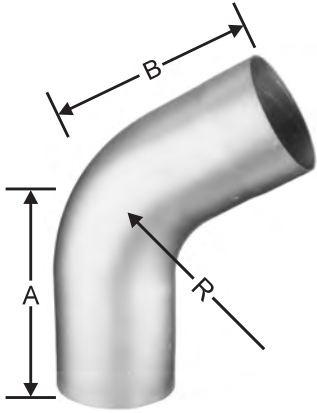

- 16 gauge aluminized steel
- Both ends O.D.

60° O.D. - I.D.

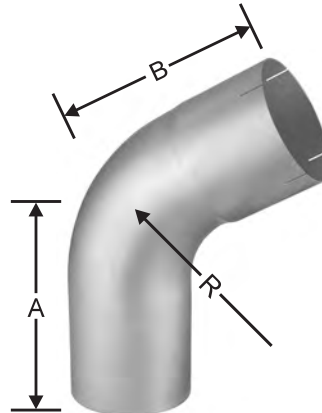

- 16 gauge aluminized steel
- One end O.D., one end I.D. slotted

Diameter O.D.-O.D.		Leg Length (A & B)		Center Line Radius (R)		Part Number
in	mm	in	mm	in	mm	
4.00	102	8.00	203	5.00	127	J009644
5.00	127	8.00	203	5.50	140	J009645

Diameter O.D.-I.D.		Leg Length (A & B)		Center Line Radius (R)		Part Number
in	mm	in	mm	in	mm	
3.50	89	8.00	203	5.00	127	J009639
4.00	102	8.00	203	5.00	127	J009640
5.00	127	8.00	203	5.50	140	J009641

45° O.D. - I.D.

Elbows

- 16 gauge aluminized or chrome plated steel
- One end O.D., one end I.D. slotted

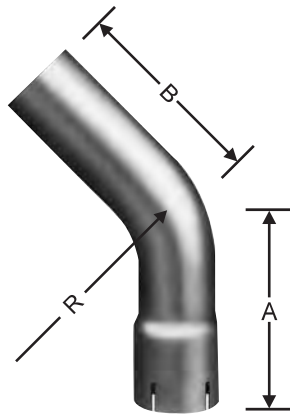

Diameter O.D.-I.D.		Leg Length (A & B)		Center Line Radius (R)		Aluminized	Chrome
in	mm	in	mm	in	mm		
2.50	64	6.00	152	4.00	102	P206279	
3.00	76	7.00	178	5.00	127	P206280	
3.50	89	8.00	203	5.00	127	P206281	
4.00	102	8.00	203	4.50	114		P206285
		9.25	235	7.00	178	P206282	
		12.00	305	5.00	127	J190023	
5.00	127	8.00	203	8.00	203	J190025	
		8.00	203	7.50	191		P206286
		12.00	305	8.00	203	P206283	
		15.00	381	5.50	140	J190027	
6.00	152	8.00	203	6.00	152	P207359	

Bent Tubes for Trucks

Kenworth Truck Bent Tubes

Kenworth Part No.	Donaldson Part No.	Dia. O.D. in	mm	Application
K180-5419	J018110	5.00	127	28° Elbow
K180-14764L	J038611	5.00	127	Left Hand Elbow
K180-14764R	J038612	5.00	127	Right Hand Elbow

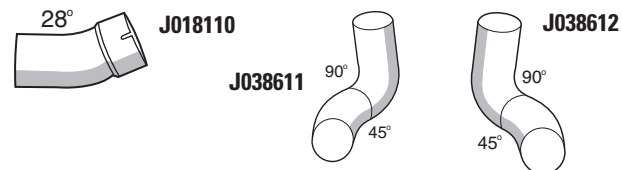

Mack Truck Bent Tubes

Mack Part No.	Donaldson Part No.	Dia. O.D. in	mm	Application
4ME21698	J028528	4.00	102	R & RD Models

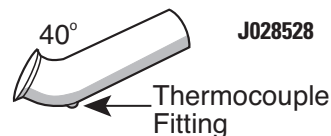

45° O.D. - O.D.

- 16 gauge aluminized or chrome plated steel
- Both ends O.D.

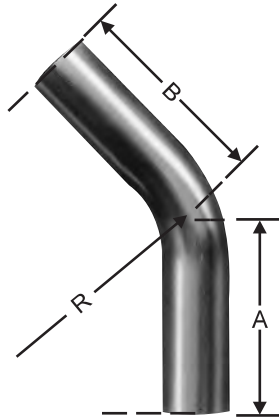

Diameter O.D.-O.D.	Leg Length (A)		Leg Length (B)		Center Line Radius (R)		Aluminized	Chrome	Stainless
	in	mm	in	mm	in	mm			
2.00	51	6.00	152	6.00	152	5.00	127	P207347	
2.50	64	6.00	152	6.00	152	5.00	127	P207349	
2.75	70	6.00	152	6.00	152	5.00	127	P207350	
3.00	76	7.00	178	7.00	178	5.00	127	P207351	
3.50	89	8.00	203	8.00	203	5.00	127	P207352	
4.00	102	8.00	203	8.00	203	4.00	102	P207353	
4.00	102	8.00	203	8.00	203	4.50	102		P235788 ¹
5.00	127	8.00	203	8.00	203	5.50	140	P207354	P216169 P235789 ¹
6.00	152	8.00	203	8.00	203	6.00	152	P207355	

1- 439 Stainless Steel

30° O.D. - O.D.

- 16 gauge aluminized steel
- Both ends O.D.

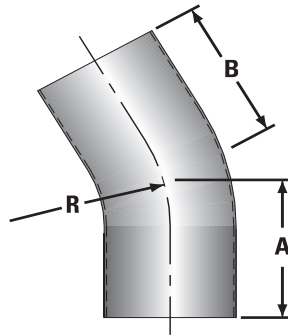

Diameter O.D.-O.D.	Leg Length (A & B)		Center Line Radius (R)		Part Number	
	in	mm	in	mm		
3.50	89	4.00	102	5.00	127	J009635
4.00	102	4.00	102	5.00	127	J009636
5.00	127	4.00	102	5.50	140	J009637

30° O.D. - I.D.

- 16 gauge aluminized steel
- One end O.D., one end I.D. slotted

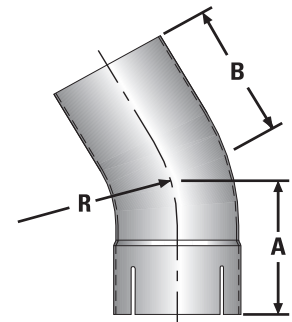

Diameter O.D.-I.D.	Leg Length (A & B)		Center Line Radius (R)		Part Number	
	in	mm	in	mm		
3.50	89	4.00	102	5.00	127	J009631
4.00	102	4.00	102	5.00	127	J009632
5.00	127	4.00	102	5.50	140	J009633

15° O.D. - O.D.

- 16 gauge aluminized steel
- For use where clearance is a problem

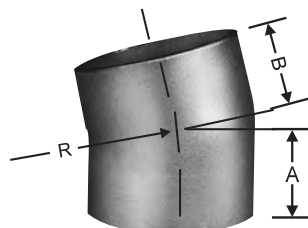

Diameter O.D.-O.D.	Leg Length (A & B)		Center Line Radius (R)		Part Number	
	in	mm	in	mm		
3.00	76	1.75	44	5.00	127	P206393
3.50	89	1.75	44	5.00	127	P206394
4.00	102	2.50	64	4.00	102	P206395
5.00	127	4.00	102	5.50	140	P206396

Dump Truck Stack Pipes

- 16 gauge aluminized steel

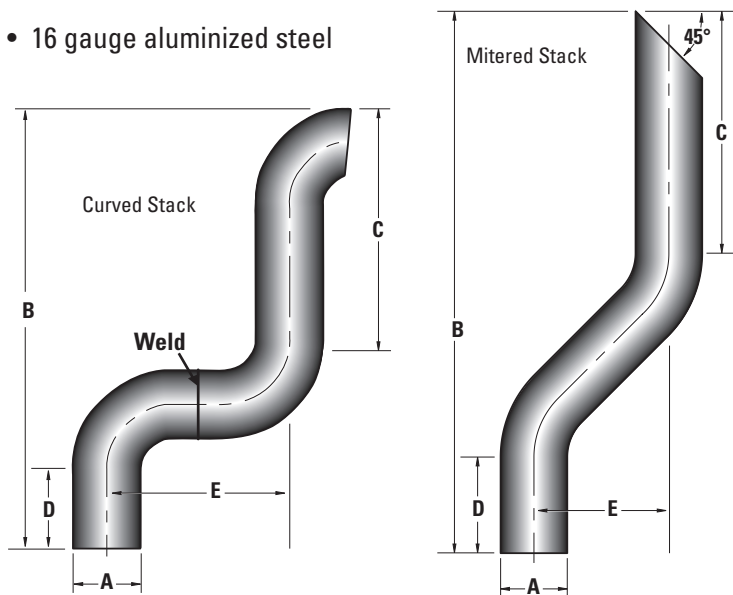

Dump Truck Stack Pipes

- O.D. Dia. -		Overall Length (B)		Leg Length (C)		Leg Length (D)		-- Offset -- (E)		Curved	Mitered
in	mm	in	mm	in	mm	in	mm	in	mm	Aluminized	Chrome
4.00	102	38.00	965	19.50	495	10.50	267	12.10	307	P224581	
		51.00	1295	32.28	820	7.67	195	8.20	208		P224692
5.00	127	38.00	965	18.00	457	9.00	229	12.10	307	P224582	
		51.00	1295	31.70	805	7.11	181	7.04	179		P224693

Super Stack

- Aluminized
- Packing inside stack will reduce exhaust noise by 2 to 3 dBA
- Mounts directly into existing system replacing the conventional stack

Part Number: M001327

O.D. Dia.	--Length--	O.D. Dia.	--Length--
in	mm	in	mm
5.00	127	35.50	902



Straight Stack Pipes

- Keeps exhaust smoke and fumes from damaging cargos or blackening van bodies
- 16 gauge aluminized steel or chrome

O.D. Style - Straight Stacks



O.D. Dia.		-- Length --		Aluminized	Chrome
in	mm	in	mm		
3.00	76	24.00	610	P208328	
		48.00	1219	P206376	
3.50	89	24.00	610	P208336	
		48.00	1219	P206377	
4.00	102	24.00	610	J240012	
		48.00	1219	P206378	P206388
		60.00	1524	J640001	
5.00	127	24.00	610	P224589	P224590
		48.00	1219	P206379	P206389
		60.00	1524	P208393	P206391

I.D. Style - Straight Stacks



I.D. Dia.		-- Length --		Aluminized	Chrome
in	mm	in	mm		
3.00	76	24.00	610	P216191	
		36.00	914	P208324	
		48.00	1219	P207285	P207314
3.50	89	18.00	457	P207281	
		24.00	610	J024735	
		36.00	914	P208348	
4.00	102	48.00	1219	P207286	
		18.00	457	P207282	
		24.00	610	J024737	P224627
		36.00	914	P208364	P224628
		48.00	1219	P207287	
5.00	127	60.00	1524	P207288	P207299
		18.00	457	P207283	
		24.00	610	J024739	J240024
		36.00	914	P208380	J340023
		48.00	1219	P207292	
6.00	152	60.00	1524	P207289	P207300
		48.00	1219	P216197	

45° Mitered Chrome Stack Pipes

- Keeps exhaust smoke and fumes from damaging cargos or blackening van bodies
- 16 gauge

O.D. Style - 45° Mitered Stacks



O.D. Dia.		-- Length --		Chrome
in	mm	in	mm	
4.00	102	18.00	457	P224696
		36.00	914	P224698
5.00	127	18.00	457	P224703
		36.00	914	P216227
		48.00	1219	P216228
		60.00	1524	J540008

I.D. Style - 45° Mitered Stacks



- I.D. Dia. -		-- Length --		Chrome
in	mm	in	mm	
4.00	102	18.00	457	P224604
		48.00	1219	P224605
5.00	127	18.00	457	P224607
		60.00	1524	P224608
		84.00	2134	P224611
		96.00	2438	P224707

Curved & Long 90° Stack Pipes

- Keeps exhaust smoke and fumes from damaging cargos or blackening van bodies
- 16 gauge aluminized steel or chrome

O.D. Style - Curved Stacks



O.D. Dia.		--- Length ---		----- Curved -----	
in	mm	in	mm	Aluminized	Chrome
3.00	76	24.00	610	P208330	
		48.00	1219	P206380	P207312
3.50	89	24.00	610	P208338	
		48.00	1219	P206381	
4.00	102	24.00	610	J024748	J024749
		36.00	914	P208358	P208359
		48.00	1219	P206382	P206386
		60.00	1524	P208388	P208389
		72.00	1829	J640005	
5.00	127	24.00	610	J024750	J024751
		36.00	914	P208374	P208375
		48.00	1219	P206383	P206387
		60.00	1524	P208394	P208395
		72.00	1829	P224600	
		96.00	2438	P209912	

I.D. Style - Curved Stacks



I.D. Dia.		-- Length --		----- Curved -----	
in	mm	in	mm	Aluminized	Chrome
3.00	76	36.00	914	P208326	
		48.00	1219	P207293	P207318
3.50	89	24.00	610	P224633	
		36.00	914	P208350	P216200
4.00	102	24.00	610	J024746	J024757
		36.00	914	P208366	J034746
		48.00	1219	P207295	P207320
		60.00	1524	P207290	P207301
		72.00	1829	P216202	
		84.00	2134	P224638	
5.00	127	24.00	610	J024747	J024758
		36.00	914	P208382	P216204
		48.00	1219	P207296	P207321
		60.00	1524	P224709	P207302
		72.00	1829	P216205	
		84.00	2134	P224638	
		96.00	2438	P209910	
6.00	152	36.00	914	P216206	



I.D. Style - Long 90°

I.D. Dia.		-- Length --		Aluminized
in	mm	in	mm	
4.00	102	60.00	1524	P224710
5.00	127	60.00	1524	P224711

Tailpipes - O.D. & I.D Styles



I.D. Style



O.D. Style

Tailpipes O.D. & I.D. Styles

-- Dia. --		-- Length --		----- O.D. Style -----		----- I.D. Style -----	
in	mm	in	mm	Aluminized	Chrome	Aluminized	Chrome
2.00	51	9.00	229	P206306		P207415	
2.50	64	12.00	305	P206308		P206301	
3.00	76	12.00	305	P206309		P206302	J014621
3.50	89	12.00	305	P206310		P206303	J014622
4.00	102	12.00	305	P206311		P206304	J014623
		18.00	457	P208386	P206384	P207297	P207308
5.00	127	12.00	305			P224617	P224618
		18.00	457	P208392	P206385	P207298	P207309
		20.00	508	P206312		P206305	
6.00	152	20.00	508	P207419		P207559	

Spark Arrestors

- U.S. Forest Service approved (80% efficiency on incendiary sparks)
- Reduces fire hazard
- Centrifugal force separates solids from exhaust gas
- Aluminized steel with stainless steel critical parts
- Can be installed vertically or horizontally (If possible, the clean out should face away from all fuel tanks, the vehicle operator's position and the air cleaner inlet.)
- Not designed to support tail or stack pipes without additional support



Selecting a Spark Arrestor

Generally, if a spark arrestor will fit on the exhaust pipe of an engine, it will also have acceptable backpressure for that engine. In some cases, a larger size spark arrestor will be required to stay within backpressure limits, and in those cases adapters will have to be used.

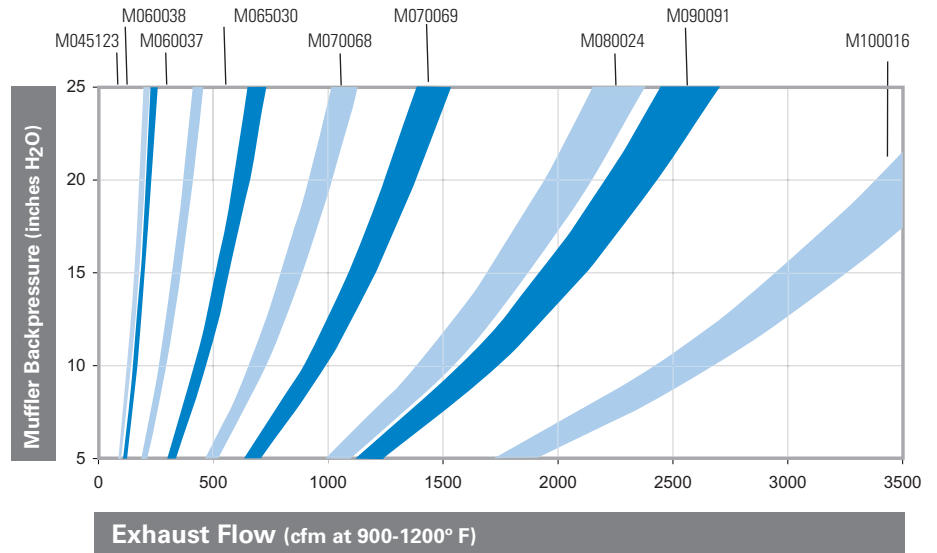

Spark Arrestor Service Tip

The spark arrestor should be inspected and cleaned out every 1,000 operating hours or three times per season. Visually inspect for holes, cracks and metal corrosion. Check the mounting clamp to make sure the spark arrestor is securely mounted. Replace the spark arrestor if your inspection reveals any of the above unsafe conditions.

Inlet I.D.		Outlet I.D.		Body Dia.		Body Length		Overall Length		Part Number
in	mm	in	mm	in	mm	in	mm	in	mm	
1.50	38	1.25 ¹	32	4.38	111	4.75	121	8.38	213	M045123
		1.50	38	6.00	152	3.75	95	9.36	241	M060038
2.00	51	2.00	51	6.00	152	5.00	127	11.10	283	M060037
2.50	64	2.50	64	6.61	168	6.25	159	13.00	330	M065030
3.00	76	3.00	76	7.00	178	7.56	194	14.63	372	M070068
3.50	89	3.50	89	7.00	178	9.00	229	16.50	419	M070069
4.00	102	4.00	102	8.00	203	10.63	270	18.19	461	M080024
5.00	127	5.00	127	9.00	229	11.75	298	20.75	527	M090091
6.00	152	6.00	152	10.00	254	13.38	340	23.50	597	M100016

1 - 1.25" is an outer diameter, not inner diameter.

Resonators

- Provides an additional 2 to 3 dBA exhaust noise reduction
- Installs in the exhaust system
- Straight-through design does not increase backpressure
- Aluminized steel
- Both ends I.D. slotted
- Common dimensions for both models:
 - Body Dia. 9" (229mm)
 - Body Length 10" (254mm)
 - Overall Length 16.5" (419mm)



5" (125mm) I.D. and O.D. - Part No. M090072
4" (102mm) I.D. and O.D. - Part No. M090362

Exhaust Ejectors

Components for Scavenged Air Systems: Exhaust Ejectors & Check Valves

Donaldson exhaust ejectors and check valves are key components to create a scavenged or aspirated air system. The ejector is used with Donaldson Donaspin™ or Strata™ Cap pre-cleaners, Strata™ systems, or PowerCore® PSD air cleaners.

A scavenged air system is typically used in off-highway equipment to extend air filter life. The exhaust ejector mounts as a stack at the end of exhaust system. It is recommended that the stack be covered with a curved exhaust stack or rain cap.

Our ejector line offers three styles, including a compact length tube for use in applications where space is limited.

----- Basic Scavenged Air System -----

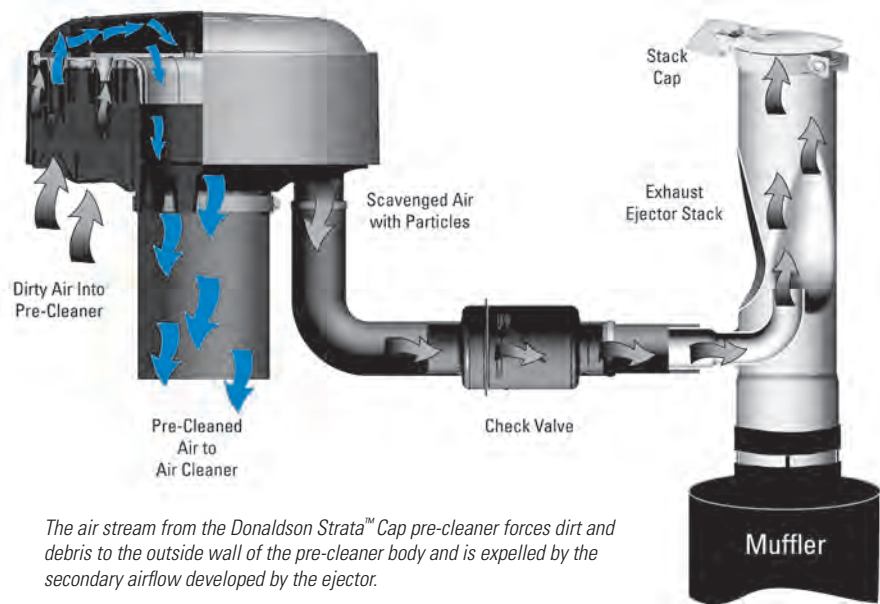

The air stream from the Donaldson Strata™ Cap pre-cleaner forces dirt and debris to the outside wall of the pre-cleaner body and is expelled by the secondary airflow developed by the ejector.

Exhaust Ejectors

- Can be used with any pre-cleaner with scavenge tube connection
- Adds only 4" (102mm) to 8" (203mm) H₂O (0.3" to 0.6" Hg.) to exhaust backpressure
- All models have a nominal OD outlet end for proper fit of stack caps and other accessories
- For proper structural support, muffler outlet tube length and stack engagement must be a minimum length of 1.5-2.0" (38-51mm)
- Finish on all models is high temperature, black, semi-gloss finish
- Can be installed horizontally or vertically

Compact Style

Part Number	Engine Intake CFM	Inlet I.D.		Scavenge Tube O.D.		Ejector Length		Exhaust Flow Rate (CFM)	
		inch	mm	inch	mm	inch	mm	Min. ¹	Max. ²
H001278 ³	165-215	2.77	70	1.25	32	9.75	248	415	545
H001279 ³	300-390	3.02	77	1.25	32	10.80	274	760	990
H001284 ³	450-590	4.02	102	1.25	32	14.38	365	1140	1500

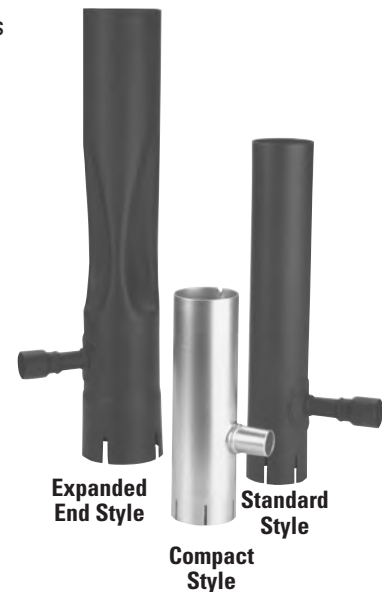

1 - Minimum exhaust flow based on 20" of water dead head vacuum
 2 - Maximum exhaust flow based on 40" of water dead head vacuum
 3 - Use 3-ply Silicone Scavenge Hose (1.25" I.D., 3 ft. length) P171376 and Lined Hose Clamp P532924

Exhaust Gas Temperature of 900° F assumed

Exhaust Ejectors & Check Valves

Exhaust Ejectors for Scavenged or Aspirated Air System

All exhaust ejectors are constructed heavy-gauge, aluminized steel, and painted with a high-temperature black paint. Select the appropriate ejector by the intake airflow or exhaust flow (CFM) of your engine.

Engine Intake CFM		Exhaust CFM @ 900° F		Standard Ejectors			Expanded I.D. Ejectors			Length		Scavenge Tube O.D.	
Low	High	Low	High	Inlet Dia.* inches	mm	Part Number	Inlet Dia.* inches	mm	Part Number	inches	mm	inches	mm
220	365	554	919	3.02	77.0	H002612	3.16	80.3	H002762	12.00	304.8	1.25	32
315	450	793	1133	4.02	102.0	H002613	4.17	105.9	H002763	18.00	457.2	1.25	32
425	600	1070	1511	4.02	102.0	H002614	4.17	105.9	H002764	18.00	457.2	1.50	38
500	740	1259	1864	5.03	127.8	H002615	5.17	131.0	H002765	22.00	558.8	1.50	38
660	950	1662	2393	5.03	127.8	H002616	5.17	131.0	H002766	22.00	558.8	1.75	44
800	1150	2015	2896	6.04	153.4	H002617	6.19	157.0	H002767	24.00	609.6	2.00	51
950	1350	2393	3400	6.04	153.4	H002618	6.19	157.0	H002768	24.00	609.6	2.00	51
1100	1500	2770	3778	6.04	153.4	H002619	6.19	157.0	H002769	24.00	609.6	2.00	51

* This dimension only applies to 2.5" /64mm of length – not the full length of the ejector.

3 ft. / .91 m Silicone Scavenge Hose & Lined Hose Clamp for:

- 1.25" / 32 mm Scavenge Tube: Hose: P171376 and Lined Hose Clamp P532924
- 1.50" / 38 mm Scavenge Tube: Hose: P171378 and Lined Hose Clamp P115200
- 1.75" / 44 mm Scavenge Tube: Hose: P171380 and Lined Hose Clamp P115200
- 2.00" / 51 mm Scavenge Tube: Hose: P171381 and Lined Hose Clamp P115200

Ejector Check Valve Prevents Exhaust Backflow

The exhaust ejector check valve prevents backflow of damaging exhaust gases by way of an internal hinge flap. Add an ejector check valve when configuring the intake system to expel filtered contaminant through the exhaust system.

- Mounts horizontally (see installation diagrams)
- Durable, non-corrosive metal construction
- No servicing required



H001023

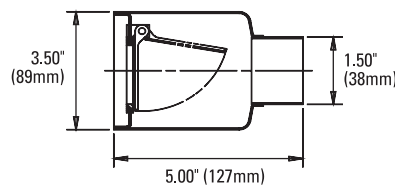

H000722

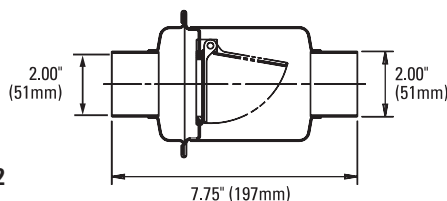

Check Valve Installation

The illustrations are side views of two-stage air cleaners, showing the position of the check valve. A 3" (76mm) inner diameter rubber reducing elbow or hump reducer is required for installation. See pages 94-96 for options.

Installation on F Series Cyclopac™

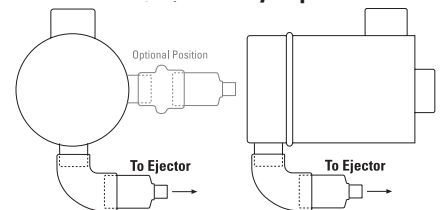

Installation on S Series Donaclone™

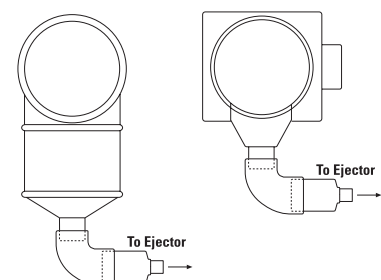

These flexible rubber adapters and elbows have smooth radii and inside surfaces to minimize flow resistance within the air intake system.

These rubber products are heavy-duty!

Larger elbows (5"/125mm) are ribbed or compounded for added strength and durability. All Donaldson rubber products meet ASTM standards.

- Resist tears, punctures and vacuum collapse

- Absorb vibration
- Reduce intake noise levels under severe conditions
- Material: EPDM rubber construction
- Temperature range: -40°F (-40°C) to +212°F (+100°C)
- Application tip: A minimum 1½" of metal piping should be inserted into the rubber fitting

90° Rubber Elbows & Reducing Elbows

90° Elbows

Inner Dia. (A) in	mm	Center Height (B) in	mm	Radius (R) in	mm	Part Number
2.00	51	3.50	76	2.00	51	P105529
2.25	57	3.75	95	2.25	57	P105530
2.50	64	4.00	102	2.50	64	P105531
3.00	76	5.25	133	3.75	95	P105532
3.50	89	5.50	140	4.00	102	P114318
4.00	102	5.75	146	4.50	114	P105533
4.50	114	5.50	140	3.50	89	P113733
5.00	127	6.12	155	4.50	114	P107844
5.50	140	6.50	171	4.63	118	P105534
6.00	152	7.00	179	5.00	127	P105535
7.00	179	7.56	192	5.56	141	P105536
8.00	203	8.50	216	6.50	165	P112605
10.00	254	10.50	267	8.50	216	P114314

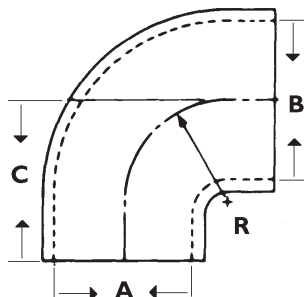
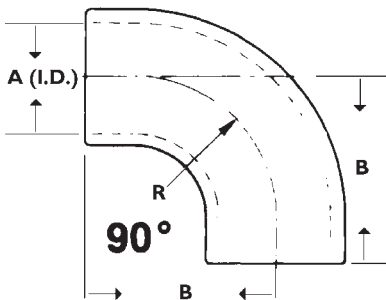

90° Elbow Reducers

Inner Dia. (A) in	mm	Inner Dia. (B) in	mm	Center Height (C) in	mm	Radius (R) in	mm	Part Number
3.00	76	3.50	89	3.50	89	2.25	57	P123462
		4.00	102	4.50	114	3.00	76	P536163
4.00	102	5.00	127	6.00	152	3.75	95	P121482
		5.00	127	6.00	152	4.25	108	P143895
		6.00	152	6.00	152	4.25	108	P159820
5.50	140	6.00	152	6.75	171	5.00	127	P117724
		7.00	179	6.25	159	4.38	111	P128990

45° Rubber Elbows, Reducing Elbows and Hump Reducers

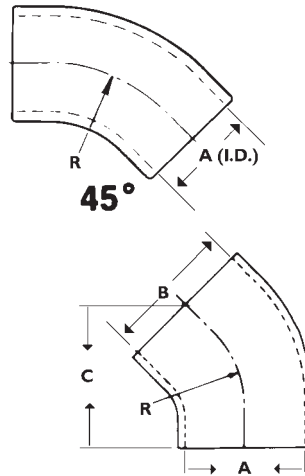

45° Elbows

Inner Dia. (A)		Radius (R)		Part Number
in	mm	in	mm	
2.00	51	2.00	51	P105541
2.25	57	2.25	57	P105542
2.50	64	2.50	64	P105543
3.00	46	3.75	95	P105544
3.50	89	3.50	89	P109331
4.00	102	4.25	108	P105545
4.50	114	3.50	89	P114316
5.00	127	4.50	114	P109021
5.50	140	4.75	121	P105546
6.00	152	5.00	127	P105547
7.00	178	5.56	141	P105548
8.00	203	6.50	165	P112606
10.00	254	8.50	216	P114313

45° Elbow Reducers

Inner Dia. (A)		Inner Dia. (B)		Center Height (C)		Radius (R)		Part Number
in	mm	in	mm	in	mm	in	mm	
5.50	140	6.00	152	6.44	164	4.88	124	P133338
6.00	152	7.00	179	7.38	187	5.31	135	P133339



Rubber Hump Reducers

Inner Dia. (A)		Inner Dia. (B)		Length (C)		Part Number
in	mm	in	mm	in	mm	
3.00	76	2.50	64	4.50	114	P102820
		2.75	70	3.50	89	P520883
3.50	87	3.00	76	5.00	127	P101290
		2.75	70	4.00	102	P520882
4.00	102	2.75	70	4.00	102	P520884
		3.00	76	5.25	133	P101291
		3.50	87	5.25	133	P101292
4.50	114	4.00	102	6.00	152	P540256
5.00	127	4.00	102	6.00	152	P101293
		4.50	114	6.25	159	P604045 ¹
5.50	140	4.00	102	6.00	152	P101891
		5.00	127	6.00	152	P103516
6.00	152	5.00	127	6.00	152	P112611
		5.50	140	6.00	152	P101294
		7.00	179	7.00	179	P136494
7.00	179	5.50	140	7.00	179	P126530
		6.00	152	6.00	152	P112610
		8.00	203	7.00	179	P129660
8.00	203	6.00	152	6.00	152	P114315
		7.00	179	6.00	152	P112609
		10.00	254	8.00	203	6.00

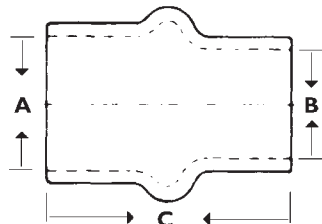

1 - Use clamp size for nominal 5" (127mm) I.D. each end



Rubber Straight Humps

Inner Dia. (A)		Length (B)		Part Number
in	mm	in	mm	
3.00	76	5.30	135	P105608
3.50	89	5.25	133	P114319
4.00	102	5.25	133	P105609
4.50	114	6.00	152	P114317
5.00	127	6.00	152	P105610
5.50	140	6.00	152	P105611
6.00	152	7.00	165	P105612
7.00	179	7.00	165	P105613
8.00	203	5.00	127	P112608
10.00	254	6.00	152	P111414

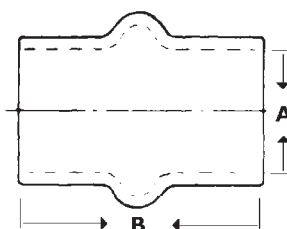

Rubber Reducers

Inner Dia. (A)		Inner Dia. (B)		Length (C)		Part Number
in	mm	in	mm	in	mm	
2.00	51	1.50	38	2.50	64	P104087
		1.75	44			
2.25	57	2.00	51	2.50	64	P104088
2.50	64	2.00	51	2.50	64	P104089
		2.25	57			



90° Cobra Adapters

Inner Dia. (A)		Inner Dia. (C)		Length (B)		(D)		Part Number
in	mm	in	mm	in	mm	in	mm	
2.75	70	4.00	102	6.50	165	1.81	46	P600328
3.00	76	3.00	76	5.22	133	1.91	49	P547694
4.00	102	4.00	102	6.44	164	2.69	68	P600325
		4.00	102	6.44	164	3.19	81	P600326
		5.00	127	6.44	164	3.19	81	P600327

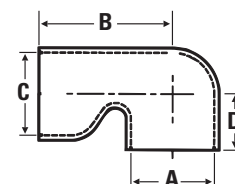

Silicone Charge Air Connectors

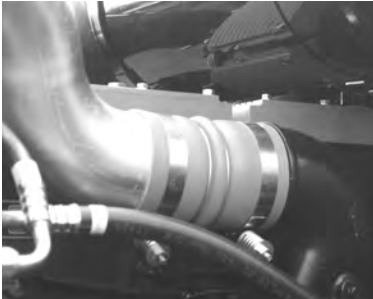

Our three styles of charge air connectors are designed to ease connections in air intake system piping: they compensate for slight misalignment and isolate vibration between hose connections. The silicone elastomer material resists chemicals, steam, ozone, coolants and aging conditions normally found in any engine operating environment.

All three charge air connectors are for installation on the pressure side with maximum operating temperatures up to 500°F (260°C.) They are orange in color to be easily identifiable as tolerant of high temperatures, and carry a one year warranty.

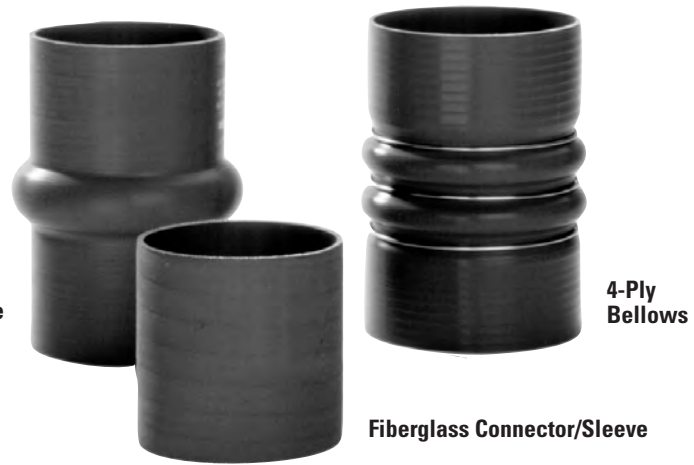

Hump Hose Connector

Fiberglass Connector/Sleeve

4-Ply Bellows

Connectors/Sleeves

Inner Dia. in	mm	Length in	mm	Part Number
2.00	51	36.00	914	P532948
2.25	57	36.00	914	P532949
2.50	64	36.00	914	P532950
3.00	76	36.00	914	P532951
3.38	86	3.50	89	P532952
		6.00	152	P532953
		36.00	914	P532954
3.50	89	3.50	89	P532956
		4.50	114	P532957
		36.00	914	P532958
4.00	102	36.00	914	P532959

Hump Hose Connectors

Inner Dia. in	mm	Length in	mm	Part Number
2.50	66	5.50	140	P532960
2.75	70	4.25	108	P532961
3.00	76	4.38	111	P532962

4-Ply Bellows

Inner Dia. in	mm	Length in	mm	No. of Rings	Part Number
3.50	89	6.00	152	3	P535572
4.00	102	6.00	152	0	P532943
		6.00	152	2	P535571
		6.00	152	3	P532944
		7.50	191	3	P532945
		8.00	203	3	P535573

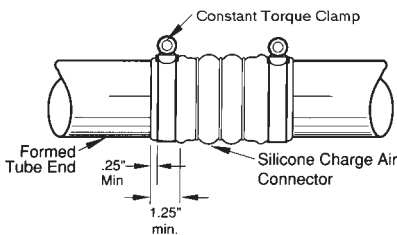

Use the illustration as a guide for installing your charge air connector. For proper installation, use Donaldson Constant Torque clamps to retain clamp load. Torque to 70-75 lbs-in.

Worm-Drive Hose Clamps

- Versatile clamps for wide size range of hose connections
- Made of strong, durable, noncorrosive stainless steel
- Inside of clamp is lined so that hose doesn't bulge through clamp holes
- Narrow band enables easy installation in confined areas



High Torque Clamp

--- Min. to Max. Size --- inch	mm	Part Number
4-1/4 - 5-1/8	108-130	P115204
5-1/4 - 6-1/8	133-156	P115205
6-1/4 - 7-1/8	159-181	P115206
7-1/4 - 8-1/8	184-206	P115207
8-1/4 - 9-1/8	210-232	P115208
10-1/4 - 11-1/8	260-286	P115209

Recommended application up to 150 lbs-in torque

This EXTRA heavy-duty clamp ensures total protection against leakage...eliminates the need for double clamping.



Constant Torque Clamp

--- Min. to Max. Size --- inch	mm	Part Number
2-1/4 - 3-1/8	57-79	P532925
2-3/4 - 3-5/8	70-92	P532926
3-1/4 - 4-1/8	83-105	P532927
3-3/4 - 4-5/8	95-117	P532928
4-1/4 - 5-1/8	108-130	P532929

Recommended application up to 90 lbs-in torque

Donaldson Constant Torque lined clamps are the best choice for systems where clamps cannot be retightened and have difficult access. Perfect for applications requiring higher torque, large diameters, temperature extremes, or where expansions and contractions within the system are common. This clamp is a good choice for critical coolant and charge-air connections.



Lined Hose Clamp

-- Min. to Max. Size -- inch	mm	Part Number
9/16 - 13/16	14-21	P532919
11/16 - 15/16	17-24	P532920
13/16 - 1-1/16	21-27	P532921
13/16 - 1-1/2	21-38	P532923
13/16 - 1-3/4	21-44	P532924
15/16 - 1-1/4	29-32	P532922
1-9/16 - 2-1/2	40-62	P115200
2-1/16 - 3	52-76	P115201
2-13/16 - 3-3/4	71-95	P143422
3-5/16 - 4-1/4	84-108	P115202
4-5/16 - 5-1/4	109-133	P115203

Recommended application up to 40 lbs-in torque

Donaldson lined hose clamps seal silicone and other soft hoses without damage. The inner liner extends under the perforations to protect the hose and prevents extrusions through the worm-gear perforations.

T-Bolt Clamps



Nominal I.D. ¹	Min. to Max. Size inch	mm	Part Number
2.00	2.25-2.53	57-64	P148337
2.25	2.50-2.78	63-70	P148338
2.50	2.81-3.09	71-78	P148339
2.75	3.06-3.34	78-85	P148340
3.00	3.31-3.59	84-91	P148341
3.50	3.81-4.09	98-104	P148342
4.00	4.31-4.59	109-116	P148343
4.50	4.81-5.09	122-129	P148344
5.00	5.31-5.59	135-142	P148345
5.50	5.94-6.21	151-158	P148346
6.00	6.38-6.65	162-169	P148347
7.00	7.38-7.78	187-198	P148348
8.00	8.25-8.56	216-226	P148349
10.00	10.50-10.91	267-277	P148350

¹ - Nominal I.D. dimension, shown in inches, corresponds to I.D. dimension of rubber part being clamped.

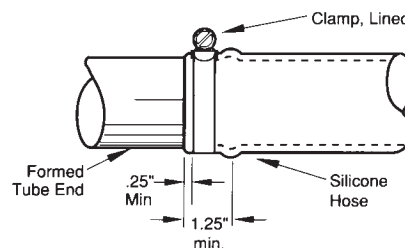

Initial torque on lined hose clamp should be 40 lbs-in. If retorquing is required, limit to 20 lbs-in.

Replacement Vacuator™ Valves

The Vacuator Valve, standard on the majority of Donaldson air cleaners, is an important part of the functionality of the air cleaner. It is an integral part of the pre-cleaning stage on two-stage air cleaners.

The dust cup, where pre-cleaned dust is collected, is normally under a slight vacuum when the engine is running. The normal engine pulsing of the vacuum causes the Vacuator Valve to open and close. This action automatically expels any collected dust and water. The Vacuator Valve also unloads when the engine is stopped.

Application Notes

For proper operation, the Vacuator Valve should be located at the lowest point on the air cleaner or dust cup pointing down.

Never paint the Vacuator Valve. Solvents and chemicals will shorten the usable life.

If the Vacuator Valve is torn, shredded or turned inside out, its durometer may be too soft for the application. Choose a model with a harder durometer (higher number). Conversely, if the Vacuator Valve doesn't empty itself properly, the durometer may be too hard. Choose one with a softer durometer (lower number.)



The Donaldson Vacuator Valve, also known as VacValve, is made in a variety of sizes and shapes to fit various applications. The Donaldson part number is molded into each part for easy identification.

Vacuator Valves

Part Number	Diameter		Durometer	Used on Air Cleaner Styles
	in	mm		
P103198	3.0	76	40	FRG 10", 12", 14" and 16"; FHG 10", 12", 14" and 16"; FTG; FWA 5"-16"; FWG 4"-16"; SRG; In-line Water Separators
P105220	3.0	76	60	FRG 18"; FHG 8"; FVG160587
P106593	3.0	76	60	FHG 6"-8", High Pulsation Models
P112803	3.0	76	40	FHG 6"-8"; PSD 10", PSD 12"; SBG 14"-16"; SDG; STG 12"-16"
P149099	1.0	25	60	ERA; EBA; EBB; ECG
P158914	2.0	51	50	XRB, FKB; PSD 8"; PSD 9"; FPG 6" and 8"; FRG 5"-9", 11"; FHG 5", FWG; FWA; Moisture Skimmers
P522958	2.0	51	60	FPG 4" -5"; FHG
P525956	1.0	25	60	EPG 11", 13", 15"
P617632	1.57	40	50	PSD 08"
P776008	2.0	51	60	FPG 9", 10" Twist-off cover; FRG 10", 13", and 15"

For the longest filter service life, replace damaged or missing Vacuator Valves immediately!

If your valve is cracked, torn, remains open or is missing, dust particles that are normally expelled can deposit themselves onto the filter and will shorten air filter service life. **Replace it!**

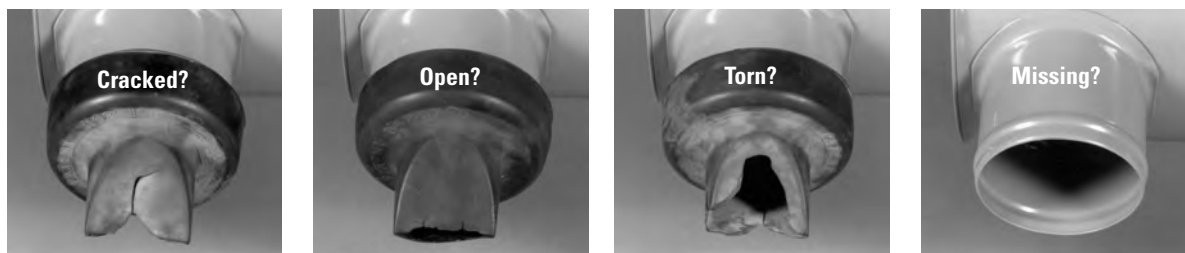

The Informer™ for Graduated, Continuous Readings



The Informer, when mounted on the air cleaner or the dashboard, provides a continuous reading whether the engine is running or is shut down. Reset button is on top. Kit includes full installation instructions and a P100089 safety filter

fitting. For remote mounting, order a P105168 flange and a P105622 90° elbow.

The Informer™

Restriction Limit	Gauge Only	Kit (gauge & fitting)
20" H ₂ O/5 kPa	X002278	X002103
25" H ₂ O/6.2 kPa	X002277	X002102
30" H ₂ O/7.5 kPa	X002275	X002101

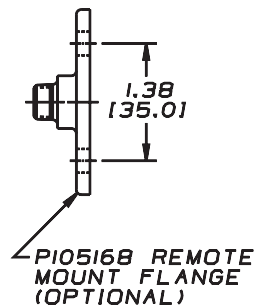
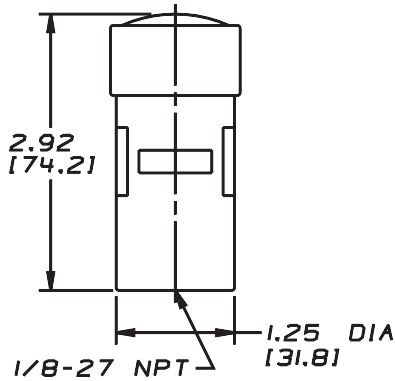

The Mini-Informer™ for Light & Medium Trucks

The Mini-Informer restriction gauge is designed to mount in the plastic air cleaners of passenger cars, light trucks, and sport utility vehicles. It's an accurate, durable, easy-to-read "go/no go" style indicator, smaller than the original Informer.



Through the clear window, a green flag shows when air filter restriction is below the service point. When the restriction reaches its limits, an orange flag imprinted with "change filter" pops up.

The Mini-Informer mounts in the air cleaner ducting in a rubber grommet.

The Mini-Informer™

Restriction Limit	Gauge & Grommet	Gauge Only
25" H ₂ O/6.2 kPa	X007276	X007335

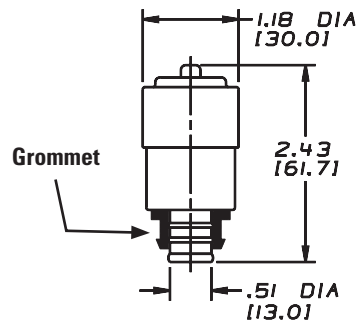

Restriction Tap Fittings

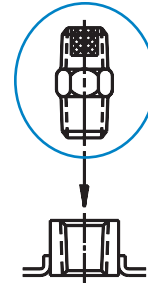

Part No. P100089

- Male threads both ends
- 1/8"-27 thread
- 0.44" (11mm) hex nut
- Internal sintered bronze safety filter

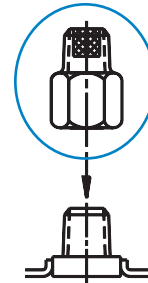

Part No. P122067

- Female threads on one end, male threads on opposite end
- 1/8"-27 thread
- Internal sintered bronze safety filter

Restriction Indicator Fitting

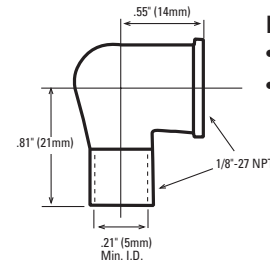

Part No. P105622

- 1/8"-27 threads
- 90° elbow with threaded end

Air Ram™ Inlet Hoods

- Primarily over-highway trucks
- For engine airflow of 700 to 1000+ cfm
- Improves intake system airflow and fuel economy by reducing restriction, examples:
 - at 33 mph, 53 kmh = 3.5" H₂O restriction
 - at 45-52mph, 72-74 kmh = 4" H₂O restriction
 - at 60 mph, 97 kmh = 5" H₂O restriction
- Lightweight, non-corrosive, and durable – no service needed!
- Inlet screen prevents large debris from entering intake ducting
- Side louvers ensure continuous airflow to intake system
- Common inlet sizes fit most installations
- Eliminates water from air intake system
 - at 700 cfm airflow = 90%
 - at 800 cfm airflow = 93%
 - at 1000 cfm airflow = 93%*

* based on item H001660



H001654
High profile model mounts on inlet stack, above and behind cab.



H001200
Low profile model designed for air cleaners mounted on the side of the cab.

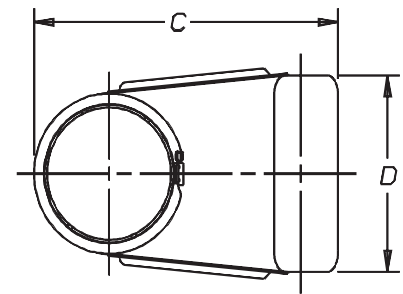
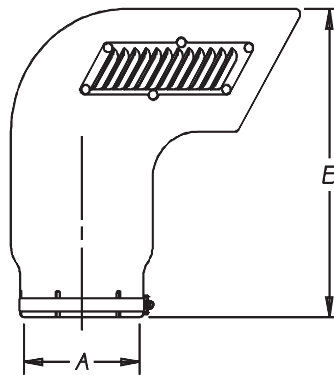

Air Ram Inlet Hood

Part Number	Inlet Diameter (A)		Height (B)		Depth (C)		Width (D)	
	in	mm	in	mm	in	mm	in	mm
MODELS WITH LOUVERS ON SIDE								
H001660	6.06	154	14.80	376	14.85	377	8.98	228
H001654	7.06	179	15.53	394	15.63	397	9.86	250
H001661	8.06	205	16.16	410	16.95	431	10.92	277
MODELS WITHOUT LOUVERS (LOW PROFILE)								
H001200	7.06	179	6.25	159	12.03	306	13.20	335

Note: One mounting band is included with each Air Ram

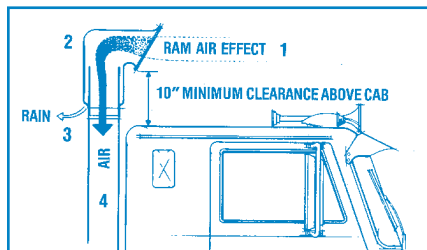

How Air Ram™ Works

- 1- Moisture-filled air enters Air Ram.
- 2- Air is naturally forced against rear wall. Moisture sticks to the wall, separating from the air.
- 3- Moisture collects on the Air Ram wall and drains down to and out of the drain hole.
- 4- Virtually moisture-free air passes into air cleaner.

Installation Note

All Air Ram inlet hoods MUST be installed with the screen facing forward to ensure best performance. Airflow restriction will not be reduced if the Air Ram faces sideways; but if it faces backwards, restriction does increase and adversely affects engine performance.

Inlet Hoods

- Protects engine air intake from rain, snow, birds, and other large contaminants
- Mounts on stack or directly to air cleaner for on-road and off-road equipment
- Four styles in a wide variety of sizes
- Installs easily with one clamp. Clamp included with hood on styles B, C and D

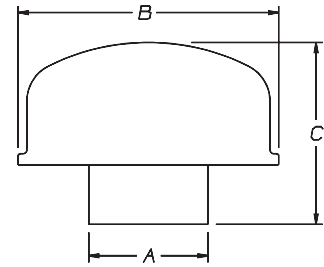

Inlet Hood - Style A¹

Fits O.D. (A)		Hood Dia. (B)		Height (C)		Add to Stack		Mat'l	Rain Shroud?	Weight		Part Number
inch	mm	inch	mm	inch	mm	inch	mm			lbs	kgs	
1.75	44	4.13	105	3.31	84	2.75	70	Metal	No	0.50	0.22	X002017
2.00	51	4.13	105	3.25	83	2.75	70	Metal	No	0.50	0.22	X002018
2.25	57	5.24	133	3.97	101	3.50	89	Metal	No	0.80	0.36	X002019
2.50	64	5.25	133	3.97	101	3.50	89	Metal	No	0.80	0.36	X001966
3.00	76	6.13	156	5.06	129	3.75	95	Metal	No	1.10	0.50	X002014
3.75	95	8.06	205	7.75	197	6.00	152	Metal	No	2.10	0.95	X001988
4.00	102	8.06	205	7.88	200	6.00	152	Metal	No	2.00	0.90	X002015

¹ - Clamps must be ordered separately for this style

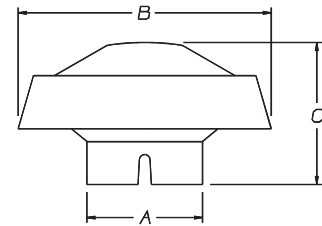

Inlet Hood - Style B

Fits O.D. (A)		Hood Dia. (B)		Height (C)		Add to Stack		Mat'l	Rain Shroud?	Weight		Part Number
inch	mm	inch	mm	inch	mm	inch	mm			lbs	kgs	
1.75	44	6.00	152	3.37	86	2.05	52	Plastic	No	0.20	0.09	H002068
2.00	51	6.00	152	3.31	84	2.50	64	Plastic	No	0.20	0.09	H001377
2.50	64	6.00	152	3.31	84	2.50	64	Plastic	No	0.20	0.09	H001378
3.00	76	6.00	152	3.31	84	2.50	64	Plastic	No	0.20	0.09	H001379

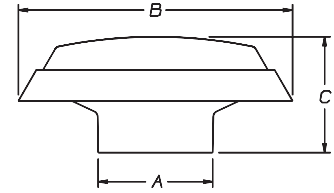

Inlet Hood - Style C

Fits O.D. (A)		Hood Dia. (B)		Height (C)		Add to Stack		Mat'l	Rain Shroud?	Weight		Part Number
inch	mm	inch	mm	inch	mm	inch	mm			lbs	kgs	
3.00	76	11.50	292	5.88	149	3.63	92	Plastic	No	1.10	0.50	H001063
3.75	95	11.50	292	5.13	130	3.63	92	Plastic	No	0.80	0.36	H000466
		11.50	292	5.13	130	3.63	92	Plastic	Yes	1.00	0.45	H000473
4.00	102	11.50	292	5.06	129	3.38	86	Plastic	No	0.90	0.40	H000467
		11.50	292	5.06	129	3.38	86	Plastic	Yes	1.00	0.45	H000472
4.50	114	11.50	292	4.88	124	3.38	86	Plastic	No	0.80	0.36	H000468
		11.50	292	4.88	124	3.38	86	Plastic	Yes	1.00	0.45	H000471
5.00	127	11.50	292	4.88	124	3.31	84	Plastic	No	0.80	0.36	H000469
		11.50	292	4.88	124	3.31	84	Plastic	Yes	1.00	0.45	H000470
		16.00	407	5.75	146	3.31	104	Plastic	Yes	1.80	0.80	H000605
5.50	140	16.00	407	5.75	146	4.94	125	Plastic	Yes	1.80	0.80	H000604
6.00	152	16.00	407	5.75	146	4.94	125	Plastic	Yes	1.80	0.80	H000606
		13.00	330	4.06	103	2.69	68	Bright	No	1.50	0.68	H001756
		16.00	406	5.69	145	4.25	108	Bright	Yes	1.50	0.68	H001948
7.00	178	12.81	325	4.81	122	3.44	87	Bright	No	1.50	0.68	H001773
		13.00	330	3.88	99	2.50	64	Bright	No	1.50	0.68	H001742
		16.00	406	5.75	146	4.09	104	Plastic	Yes	1.80	0.80	H000607
		16.00	406	5.69	145	4.25	108	Bright	Yes	1.50	0.68	H001947
8.00	203	16.00	406	6.19	157	4.69	119	Plastic	Yes	1.80	0.80	H001053
		16.00	406	6.19	157	4.60	117	Bright	Yes	1.50	0.68	H001946

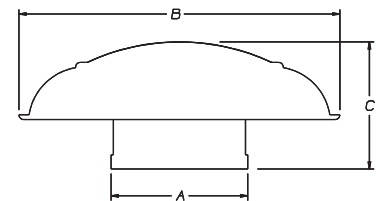

Inlet Hood - Style D

Fits O.D. (A)		Hood Dia. (B)		Height (C)		Add to Stack		Mat'l	Rain Shroud?	Weight		Part Number
inch	mm	inch	mm	inch	mm	inch	mm			lbs	kgs	
4.50	114	9.50	241	4.69	119	3.69	94	Metal	No	3.20	1.44	H000170
5.00	127	9.50	241	4.69	119	3.69	94	Metal	No	3.30	1.50	H000165
6.00	152	9.50	241	4.69	119	3.69	94	Metal	No	3.10	1.40	H000275
		9.50	241	4.69	119	3.69	94	Metal	Yes	3.20	1.44	H000276
7.03	179	17.00	432	6.75	171	5.75	146	Metal	No	4.60	2.08	H000339

Stack-Top Moisture Eliminator

- For cabover trucks, on/off road, mounted on top of an intake stack
- Over 80% water removal efficiency
- Includes clamp for installation



Part No. X003691

Airflow Range: 600-1200 cfm

I.D. 7.00" / 178mm

How It Works

- 1- Moisture-filled air enters the moisture eliminator cap.
- 2- Built-in, stationary vanes cause the air to spin.
- 3- Moisture is forced to the outside wall, where it separates from the air and collects.
- 4- Water drains out through the drain hole.
- 5- As a result, drier air (acceptable for maximum filter life and engine performance) passes to the air cleaner.

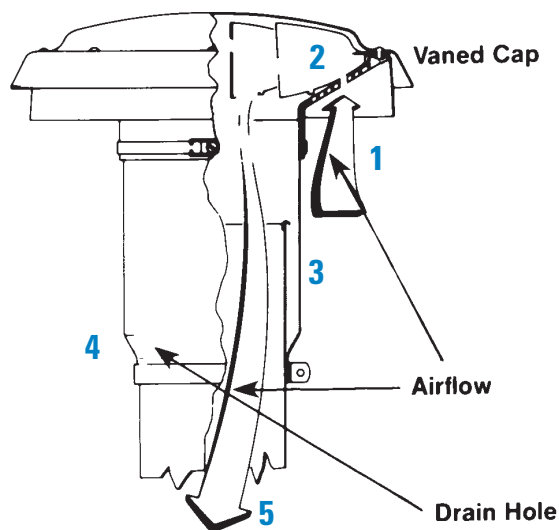

Air Stack Extensions

- For on-road and off-road trucks
- Helps extend filter life by elevating air inlet away from heavy dust concentrations and engine exhaust
- Installs easily and quickly with one clamp, which is included with unit
- Durable, corrosion-resistant steel construction

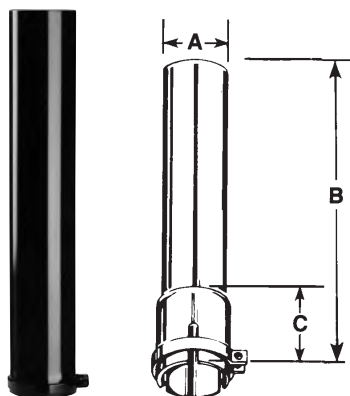

Air Stack Extensions

-(A - O.D.)-		-----(B)----		------(C)-----		Part Number
in	mm	in	mm	in	mm	
3.75	95	29.00	737	1.50	38	X001744
4.50	114	30.25	768	1.50	38	X001746
5.00	127	29.00	737	1.50	38	X001747
6.00	152	31.50	800	1.50	38	H000484
7.00	178	28.62	727	1.50	38	H000483

Air Cleaner Mounting Bands



Most of our air cleaners with metal housings require two mounting bands.

- Durable, corrosion resistant, steel construction
- Fully engineered and tested to resist the adverse effects of vibration
- Mounting band feet are designed to ensure maximum torque pressure, continuously
- Gauge of steel increases as diameter of mounting band increases
- Bright stainless models available
- Bolt and nut included with mounting band

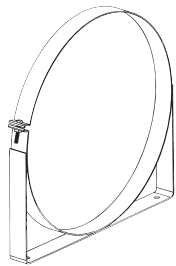

Two models (H770068, H770037) have different foot band compared to others.

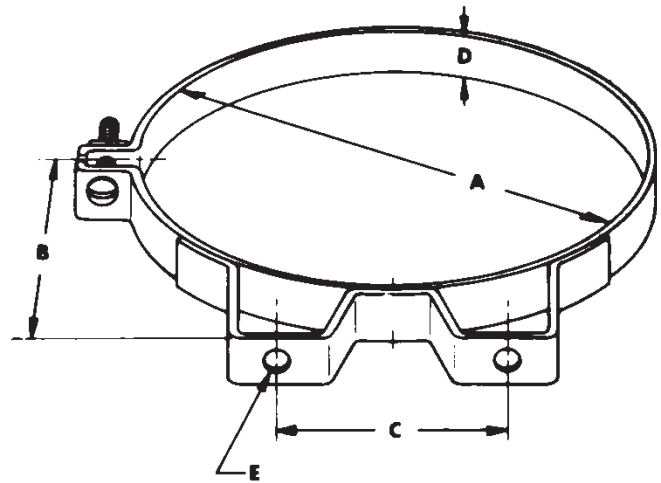

Air Cleaner Mounting Bands

A		B		C		D		E		Weight		Max. Bolt Torque		Part Number
inch	mm	inch	mm	inch	mm	inch	mm	inch	mm	lbs	kg	lbs-ft	N•m	
4.00	102	2.56	65	2.50	64	.75	19	.31	8	0.30	0.14	1.50	2.03	P007189
5.25	133	3.19	81	3.25	83	.88	22	.34	9	0.70	0.32	1.50	2.03	P002348
6.00	152	3.56	90	3.25	83	1.00	25	.34	9	0.80	0.36	1.50	2.03	P002351
6.50	165	3.88	99	3.75	95	.88	22	.41	10	0.70	0.32	2.00	2.71	P007191
7.00	178	4.13	105	4.50	114	.88	22	.30	8	0.80	0.36	3.00	4.07	P004906
7.75	197	4.44	113	4.25	108	1.00	25	.34	9	0.90	0.41	3.50	4.75	P003245
8.00	203	4.50	114	4.25	108	1.00	25	.34	9	1.10	0.50	4.00	5.42	P004307
9.00	229	5.13	130	4.5	114	1.25	32	.45	11	1.50	0.68	4.00	5.42	P004073
10.19	259	5.75	146	5.00	127	1.25	32	.45	11	1.50	0.68	4.00	5.42	P004076
11.00	279	6.13	156	5.00	127	1.25	32	.45	11	1.70	0.77	4.00	5.42	P004079
11.81	300	6.88	175	6.00	152	1.50	38	.41	10	2.50	1.13	4.00	5.42	H000349
13.00	330	7.25	184	6.00	152	1.50	38	.41	10	2.80	1.50	4.00	5.42	P013722
		7.25	184	6.00	152	1.50	38	.41	10	2.80	1.50	4.00	5.42	P522439*
14.00	356	8.13	207	8.00	203	1.50	38	.47	12	3.70	1.68	5.00	6.78	H000350
15.00	381	8.00	203	8.00	203	1.50	38	.47	12	4.10	1.86	6.00	8.14	P016845
		8.00	203	8.00	203	1.50	38	.47	12	4.10	1.86	6.00	8.14	P524552*
16.00	406	9.13	232	10.00	254	1.50	38	.47	12	4.75	2.16	5.00	6.78	H000351
18.00	457	9.2	234	15.75	400	1.96	50	.55	14	5.25	2.38	5.00	6.78	H770037
19.29	490	10.97	279	19.29	490	1.96	50	.55	14	6.39	2.9	5.00	6.78	H770068

* Bright Stainless Model

Mounting Bands Designed Exclusively for FPG Series Air Cleaners

Polymer Mounting Band

The one-piece, high tech polymer mounting band will securely hold the housing in position. The band has tabs on the inside circumference which fit exactly into notches on the FPG housing.

The band tightens around the air cleaner when the base of the band is bolted to a support, providing a fixed, stable mounting – even in high vibration applications.

Donaldson polymer bands are completely non-corrosive, lightweight, easy to install, and economical.

Application Note:

To accommodate even hard-to-fit applications, polymer bands allow the air cleaner housings to be rotated and positioned at various increments, depending upon the size:

Housing Diameter	Increment
4.80" (122mm)	11°
5.75" (146mm)	10°
6.74" (171mm)	7.5°
7.19" (183mm)	7°
8.35" (212mm)	5°

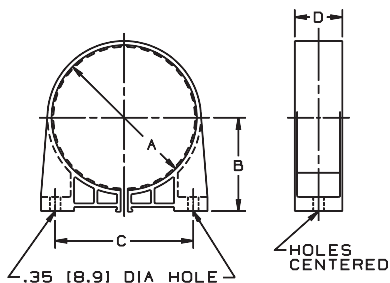

For G04 and G05 FPG Air Cleaners.

Bands for G06-G10 FPG Air Cleaners with spring loaded screws

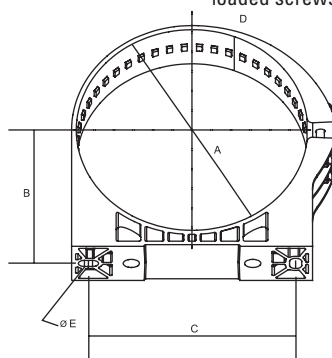

Metal Mounting Band

The metal mounting band has a spring-loaded bolt at the top to maintain a constant hold on the housing throughout high and low temperature extremes.

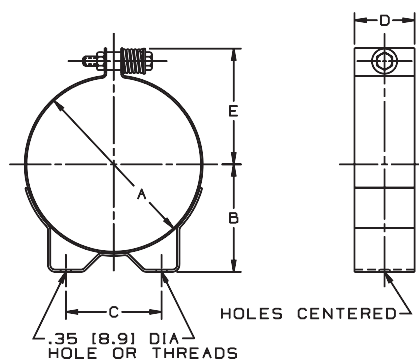

WARNING: Do not use any other mounting bands or straps with FPG air cleaners. Use of an unapproved mounting band voids warranty.

FPG Mounting Bands (Order one band per FPG air cleaner)

Part Number	A		B		C		D		E		Weight		Maximum Belt Torque	
	in	mm	in	mm	in	mm	in	mm	in	mm	lbs	kgs	lbs.-ft.	N•m
POLYMER BANDS														
P777151	4.80	122	3.09	79	4.56	116	1.57	40	n/a		0.26	118	11 lbs.-ft.	14.8 N•m
P777730	5.75	146	3.52	90	5.35	136	1.99	51	n/a		0.37	167	11 lbs.-ft.	14.8 N•m
P778810	6.79	173	3.94	100	6.00	154	1.99	51	n/a		0.40	182	11 lbs.-ft.	14.8 N•m
P777731	7.17	182	4.11	105	6.50	165	1.99	51	n/a		0.45	206	11 lbs.-ft.	14.8 N•m
P777732	8.35	212	4.70	120	7.48	190	1.99	51	n/a		0.56	253	11 lbs.-ft.	14.8 N•m
P780532 ¹	9.48	241	5.47	136	5.63	143	1.99	51	n/a					
P780594 ¹	10.55	268	5.90	150	5.63	143	3.15	80	n/a					
METAL BANDS														
H008442	4.80	122	3.07	78	2.76	70	1.57	40	3.34	85	0.70	317	12 lbs.-ft.	16.2 N•m
H008443	5.75	146	3.54	90	3.15	80	1.99	51	3.83	97	1.30	590	12 lbs.-ft.	16.2 N•m
H008441 ²	6.79	173	3.94	100	3.54	90	1.99	51	4.35	111	1.40	635	12 lbs.-ft.	16.2 N•m
H008444	6.79	173	3.94	100	3.54	90	1.99	51	4.35	111	1.40	635	12 lbs.-ft.	16.2 N•m
H002070	7.19	183	4.09	104	3.74	95	1.99	51	4.55	116	1.50	680	12 lbs.-ft.	16.2 N•m
H002023	8.13	207	4.72	120	4.33	110	1.99	51	5.14	131	1.60	726	12 lbs.-ft.	16.2 N•m

1 - Mounting bands (with spring-loaded screws) for FPG09 and FPG10 models with twist-off cover

2 - Model H008441 has 8mm threads

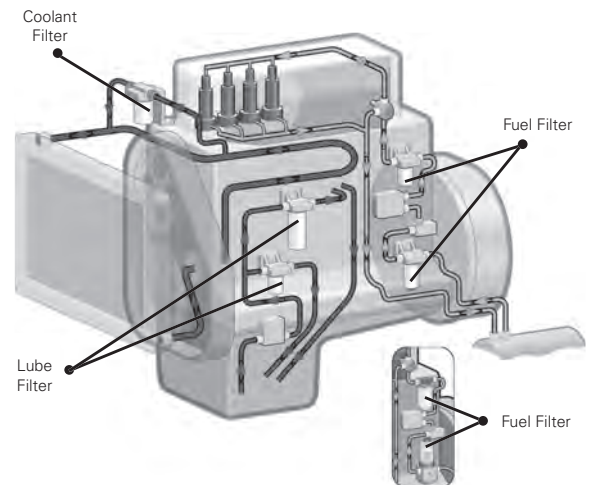
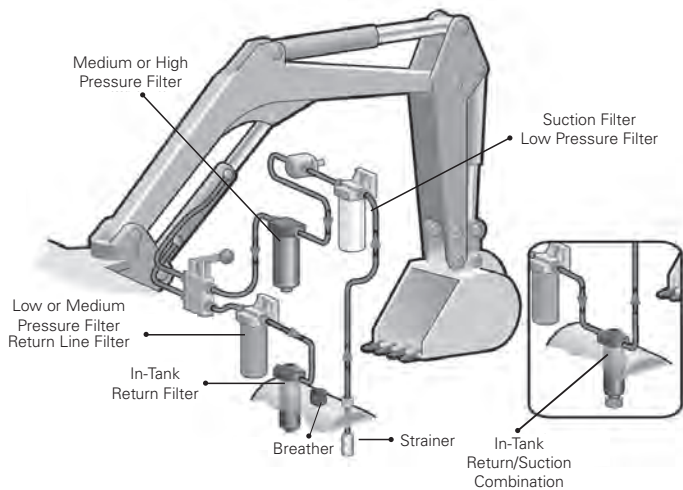
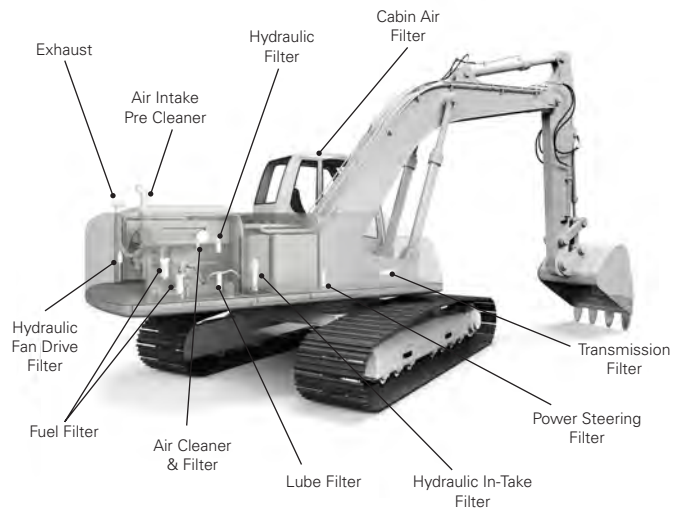
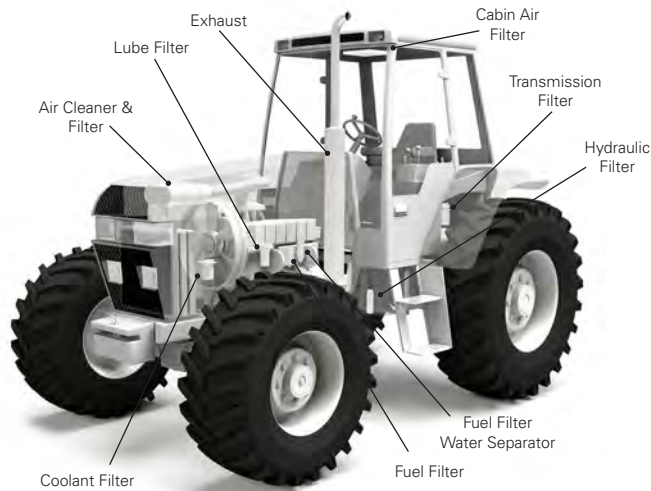
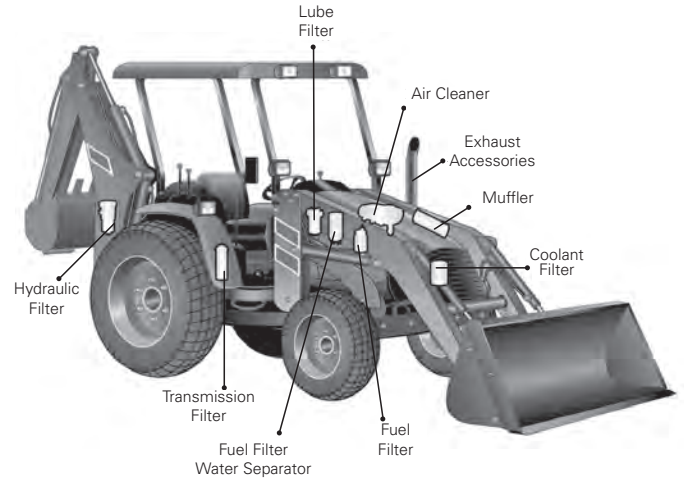
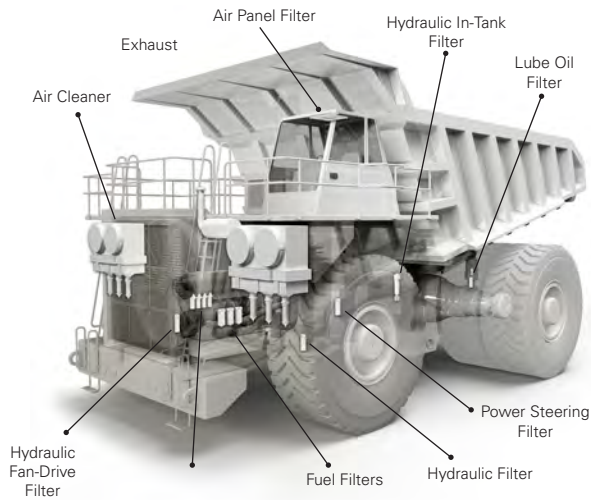



Section Index

Muffler Selection by Style & Engine Exhaust Data 66

Muffler Selection by Style with Attenuation Ranges & Exhaust Flow..... 67

Use this section to select a replacement muffler by style back pressure and attenuation range.

If you're looking for a replacement for an off-road application, consider our off-road exhaust mufflers. These newer, painted, aluminized steel mufflers have some unique features as compared to our standard line. These mufflers are the ones shown in blue text.

Style 1	67
Style 2	68
Style 2A & 3	69
Style 4 & 5.....	70
Style 6	71

Muffler Dimensions by Part Number 72

Use this section to verify the dimensional characteristics of a Donaldson muffler.

Muffler Dimensions by Style 79

Use this section to verify the dimensional characteristics of a Donaldson muffler.

Style 1	79
Style 2	82
Style 3	81
Style 4	84
Style 5	85
Style 6	86

Muffler Selection by Style & Engine Exhaust Data

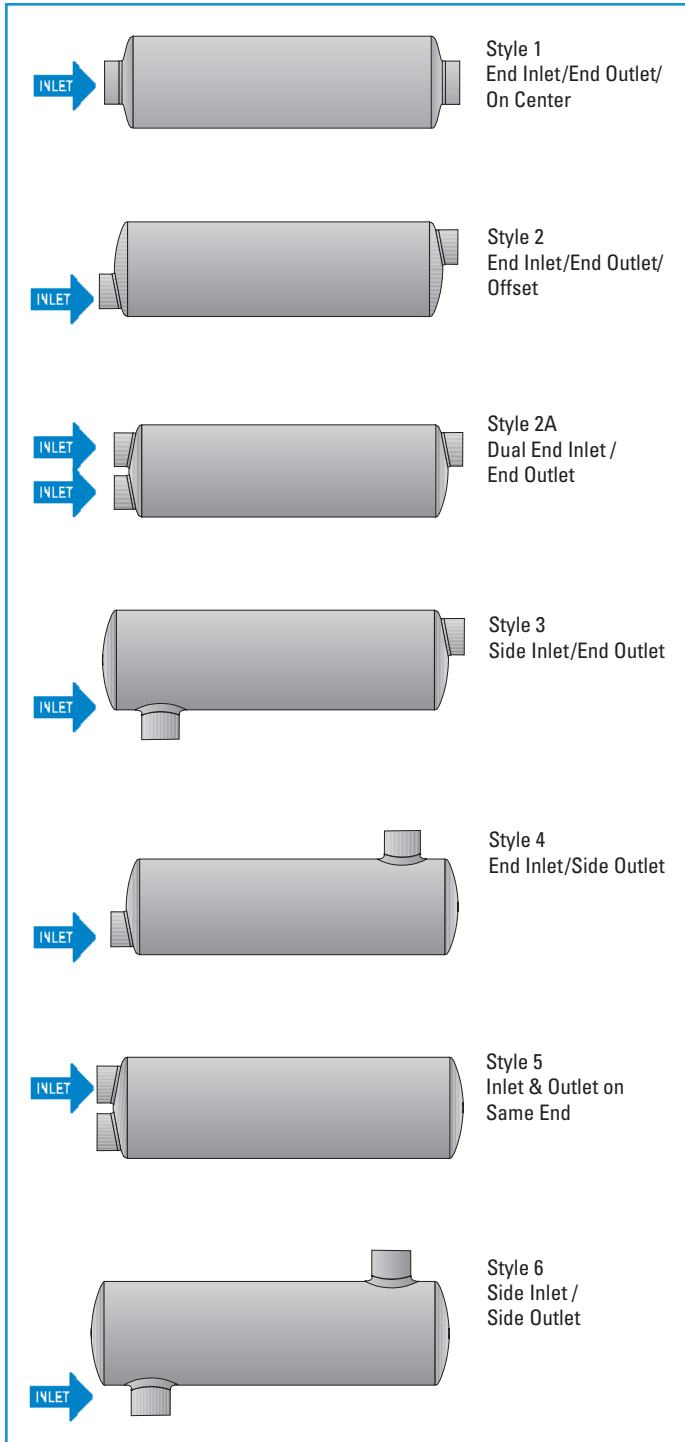

Selecting the Right Muffler for Your Engine

NOTE: Depending on your location, some diesel engines require the use of an emissions aftertreatment device to meet emissions regulations. In the United States, federal law prohibits the replacement of an emissions device (i.e., catalytic converter, combined catalytic converter/muffler, diesel particulate filter, etc.) with a non-emissions reducing (such as a straight pipe or conventional muffler) or un-approved emissions device. If operating the vehicle outside of the United States, make sure to check with and comply with any emission regulations for your locale.

Step 1

Determine the exhaust flow (CFM) and acceptable exhaust system backpressure of your engine, refer to your owners manual or contact your engine manufacturer for this information. To calculate exhaust flow, see our instructions on page 6.

Note: If you are spec'ing a dual muffler system divide engine's exhaust flow (CFM) by two.

Step 2

Find your muffler style (inlet/outlet positions and shape: round or oval) using the illustrations on the left. Proceed to the same style in page 53-57.

Step 3

Within the style, choose desired inlet diameter that is at or below your exhaust flow rate AND at or below the acceptable backpressure level.

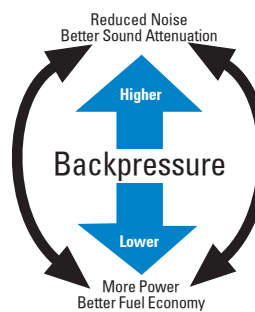

Muffler Size May Affect Backpressure:

Mufflers are key to vehicle and equipment performance because as the muffler decreases the sound, it may create more backpressure on exhaust flow. Typically, an increase in backpressure means decreased engine performance. A large muffler can be used to offset increased backpressure while maintaining overall acoustic performance.

Mufflers for Off-Road Use

Many of our mufflers are specifically designed for off-road equipment. These mufflers are shown in blue type on pages 53-59 and have the following features:

- High temperature black finish
- Mount or install in any position
- Aluminized steel construction
- All have round bodies with domed ends
- Slotted inlet/outlet connections



Choose the desired inlet diameter for the engine's air flow requirement that is at or below the acceptable backpressure level.

Style 1 - End Inlet / End Outlet / On Center

-- Inlet I.D. -- inch mm	--- Outlet I.D. --- inch mm	Body Diameter		Body Length		Attenuation Range dB(A)	Part Number	----- Exhaust Flow (cfm) @ -----		
		inch mm	inch mm	inch mm	inch mm			3" Hg 40.8" H ₂ O	2" Hg 27.2" H ₂ O	1" Hg 13.6" H ₂ O
2.00 51	2.00 51	6.00 152	15.75 400	12-18	M060479	498	393	283		
	2.10 OD 53 OD	4.38 111	12.50 318	8-12	M045237	531	433	306		
2.50 64	2.50 64	6.62 168	17.75 451	12-18	M065138	780	613	441		
	2.63 OD 67 OD	6.62 168	15.00 381	6-12	M065071	790	645	456		
2.89 73	3.16 OD 80	8.50 216	31.75 806	15-20	M085293 ⁷	1091	891	630		
3.00 76	3.00 76	8.50 216	19.75 502	12-18	M085407	1125	884	636		
	3.13 OD 80 OD	8.00 203	12.18 309	10-15	M080018	835	682	482		
	4.00 102	11.00 279	36.00 914	13-19	M111029	2193	1791	1266		
3.50 89	3.50 89	7.00 178	14.00 356	10-15	M070028	1245	1017	719		
	3.50 89	9.00 229	21.75 552	12-18	M091046	1525	1203	865		
	3.50 89	9.00 229	44.50 1130	18-25	M090146	1001	817	578		
4.00 102	4.00 102	8.50 216	34.37 873	12-18	M085421	2099	1714	1212		
	4.00 102	8.50 216	34.37 873	8-12	M085171	3119	2546	1800		
	4.00 102	9.00 229	44.44 1129	13-18	M090544	2006	1638	1158		
	4.00 102	9.00 229	20.00 508	10-15	M090594	1667	1361	962		
	4.00 102	10.33 262	44.50 1130	25-35	M100464 ¹	1420	1159	820		
	4.00 102	10.00 254	23.75 603	12-18	M101167	2000	1570	1130		
	4.00 102	10.00 254	44.44 1129	12-18	M100466	1948	1590	1125		
	4.00 OD 102 OD	9.00 229	29.31 744	10-15	M090095 ⁷	1628	1330	940		
	5.00 127	9.00 229	44.44 1129	15-20	M090781	2639	2155	1524		
	5.00 127	10.00 254	44.44 1129	19-25	M100695	1543	1260	891		
	5.00 127	5.00 127	9.00 229	20.00 508	10-15	M090595	2478	2023	1431	
5.00 127		9.00 229	44.44 1129	13-18	M090074	2887	2357	1667		
5.00 127		9.00 229	44.44 1129	12-17	M090535	3260	3100	2340		
5.00 127		10.00 254	44.44 1129	16-23	M100944	2950	2494	1765		
5.00 127		10.00 254	44.44 1129	19-25	M100582	1600	1435	1015		
5.00 127		10.00 254	44.44 1129	19-25	M101159 ⁴	1650	1465	1035		
5.00 127		10.00 254	44.44 1129	19-25	M101182 ³	1650	1465	1035		
5.00 127		10.00 254	44.44 1129	19-25	M100580	2530	2215	1565		
5.00 127		10.00 254	44.44 1129	8-12	M100465	N/A	N/A	2875		
5.00 127		10.00 254	44.44 1129	19-25	M101158 ⁴	2625	2305	1630		
5.00 127		10.00 254	44.44 1129	19-25	M101181 ³	2625	2305	1630		
5.00 127		10.00 254	44.44 1129	13-18	M100463	3260	3100	2340		
5.00 127		10.00 254	44.44 1129	16-23	M101263	2530	2215	1565		
5.00 127		10.00 254	59.95 1522	19-25	M100807	2610	2131	1507		
5.00 127		11.00 279	50.50 1283	19-25	M110849	2950	2505	1775		
5.00 127	11.84 301	25.75 654	12-18	M120747	3100	2450	1762			
2 NPT	2 NPT	6.00 152	14.50 368	8-12	M060247	776	633	448		
2.5 NPT	2.5NPT	6.00 152	15.00 381	8-12	M060005	773	631	446		
3 NPT	3 NPT	7.00 178	14.00 356	10-15	M070008	1293	1056	747		
3.5 NPT	3.5 NPT	7.00 178	18.38 467	10-15	M070050	1408	1149	813		
4 NPT	4 NPT	9.00 229	20.00 508	10-15	M090009	1767	1443	1020		

Mufflers in blue text have high temperature black finish and are designed for off-road applications.

1 - Wrapped muffler (reduces noise and surface temperature)
 3 - Silent Partner™ Exhaust & Engine Brake Silencer-Aluminized
 4 - Silent Partner™ Exhaust & Engine Brake Silencer-Stainless Steel
 7 - Face flange on inlet

Muffler Selection by Style, Attenuation & Exhaust Flow



Stated backpressure levels include muffler, average tubing lengths, and accessories.

Style 2 - End Inlet / End Outlet / Offset

-- Inlet I.D. --		--- Outlet I.D. ---		Body Diameter		Body Length		Attenuation	Part Number	----- Exhaust Flow (cfm) @ -----		
inch	mm	inch	mm	inch	mm	inch	mm	Range dB(A)		3" Hg 40.8" H ₂ O	2" Hg 27.2" H ₂ O	1" Hg 13.6" H ₂ O
2.00	51	2.00	51	6.00	152	15.75	400	12-18	M060480	498	393	283
		2.00	51	6.00	152	16.90	429	15-20	M060055	515	420	297
		2.00	51	6.00	152	24.00	610	15-20	M060232	515	420	297
2.50	64	2.50	64	6.62	168	17.75	451	12-18	M065139	780	613	441
		2.50	64	6.62	168	18.56	471	15-20	M065034	709	579	409
		2.50	64	6.62	168	27.75	705	16-22	M065065	709	579	409
3.00	76	3.00	76	8.3 x 11.5	211 x 292	26.00	660	19-25	M090170	828	676	478
		3.00	76	8.50	216	19.75	502	12-18	M085408	1125	884	636
		3.00	76	8.50	216	20.50	521	15-20	M085056	1094	894	632
		3.00	76	8.50	216	27.50	699	18-22	M085078	964	787	557
		3.00	76	8.50	216	27.75	705	18-22	M085080	964	787	557
		3.00	76	8.50	216	31.25	794	17-22	M085023	1094	894	632
		3.00	76	8.5 x 11.8	216 x 300	26.00	660	19-25	M090159 ¹	828	676	478
		3.00	76	8.50	216	38.00	965	15-20	M085008	1124	918	649
3.50	89	3.50	89	8.3 x 11.5	211 x 292	26.00	660	15-20	M090158	1325	1081	765
		3.50	89	9.00	229	21.75	552	12-18	M091047	1525	1203	865
		3.50	89	8.5 x 11.8	216 x 300	26.00	660	15-20	M090210 ¹	1325	1081	765
		4.00	102	8.2 x 11.5	208 x 292	26.00	660	13-18	M090520	1719	1403	992
		4.00	102	8.2 x 11.5	208 x 292	30.00	762	13-18	M090680	1719	1403	992
		4.00	102	8.2 x 11.5	208 x 292	26.00	660	16-21	M090538	1340	1094	773
4.00	102	4.00	102	10.00	254	23.75	603	12-18	M101168	2000	1570	1130
		4.00	102	8.2 x 11.5	208 x 292	26.00	660	12-18	M090280	1719	1403	992
		4.00	102	8.2 x 11.5	208 x 292	26.00	660	13-18	M090534	1776	1450	1025
		4.00	102	10.00	254	27.12	689	15-20	M100048	1702	1390	983
		4.00	102	10.00	254	35.38	899	15-20	M100043	1702	1390	983
		4.00	102	10 x 15	254 x 381	26.00	660	15-20	M120100	1997	1631	1153
		4.00	102	10.3 x 15.3	261 x 389	42.00	1067	22-28	M120197 ¹	1386	1131	800
		4.00	102	11.00	279	30.00	762	15-20	M110012	1730	1412	999
		4.00	102	11.00	279	36.00	914	19-25	M110189	1819	1485	1050
		4 OD	102 OD	5.00	127	11.00	279	36.00	914	13-19	M111028	2393
5.00	127	5.00	127	10 x 15	254 x 381	26.00	660	15-20	M120225	2887	2357	1667
		5.00	127	10 x 15	254 x 381	26.00	660	15-20	M120108	2329	1902	1345
		5.00	127	10 x 15	254 x 381	36.00	914	15-20	M120365	2265	1849	1307
		5.00	127	10 x 15	254 x 381	44.00	1118	13-18	M120448	2222	1814	1283
		5.00	127	11.00	279	44.00	1118	13-18	M110077	2205	1800	1273
		5.00	127	11.84	301	25.75	654	12-18	M120748	3100	2450	1762
6.00	152	6.00	152	10 x 15	254 x 381	31.75	806	10-15	M122300	3740	3054	2159
		6.00	152	12 x 18	305 x 457	30.00	762	11-16	M140048	3765	3074	2174
		6.00	152	14 x 21	357 x 533	35.00	889	12-18	M170101	4113	3358	2375
8.00	203	8.00	203	16 x 24	406 x 607	45.00	1143	11-15	M190002	6352	5186	3667

Choose the desired inlet diameter for the engine's air flow requirement that is at or below the acceptable backpressure level.



Choose the desired inlet diameter for the engine's air flow requirement that is at or below the acceptable backpressure level.

Style 2A - Dual End Inlet / End Outlet

-- Inlet I.D. --		--- Outlet I.D. ---		Body Diameter		Body Length		Attenuation	Part	----- Exhaust Flow (cfm) @ -----		
inch	mm	inch	mm	inch	mm	inch	mm	Range dB(A)	Number	3" Hg 40.8" H ₂ O	2" Hg 27.2" H ₂ O	1" Hg 13.6" H ₂ O
2.5 (2)	64 (2)	2.75	70	8.50	216	30.00	762	15-20	M085172	685	559	395
		3.00	76	8.50	216	31.25	794	15-20	M085189 ²	875	714	505
		3 OD	76 OD	8.75	222	30.12	765	19-25	M085267 ^{2,7}	1160	947	670
2.75 (2)	70 (2)	4.00	102	8.2 x 11.5	208 x 292	27.00	686	15-18	M090563	982	802	567

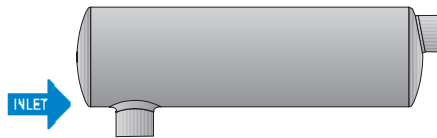

Mufflers in blue text have high temperature black finish and are designed for off-road applications.

Style 3 - Side Inlet / End Outlet

-- Inlet I.D. --		--- Outlet I.D. ---		Body Diameter		Body Length		Attenuation	Part	----- Exhaust Flow (cfm) @ -----		
inch	mm	inch	mm	inch	mm	inch	mm	Range dB(A)	Number	3" Hg 40.8" H ₂ O	2" Hg 27.2" H ₂ O	1" Hg 13.6" H ₂ O
1.68	43	1.64	42	4.38	111	13.78	350	12-18	M045193	220	180	127
2.00	51	2.00	51	6.00	152	15.75	400	12-18	M060481	498	393	283
		2.00	51	6.00	152	18.81	478	15-20	M060158	383	313	221
2.50	64	2.50	64	6.62	168	17.75	451	12-18	M065140	780	613	441
		2.50	64	6.62	168	20.89	531	15-20	M065044	564	461	326
3.00	76	3.00	76	8.50	216	19.75	502	12-18	M085409	1125	884	636
		3.00	76	8.80	224	27.12	689	15-20	M085226 ¹	808	659	466
3.02	77	3.00	76	8.50	216	26.25	667	15-20	M085090	808	659	466
3.50	89	3.00	76	8.50	216	27.00	686	12-18	M085084	801	654	462
		3.50	89	9.00	229	21.75	552	12-18	M091048	1525	1203	865
		3.50	89	8.3 x 11.5	211 x 292	26.13	664	15-20	M090301	1114	910	643
4.00	102	4.00	102	10.00	254	23.75	603	12-18	M101169	2000	1570	1130
		4.00	102	10.00	254	28.00	711	15-20	M100146	1341	1095	774
		4.00	102	11.00	279	33.00	838	15-20	M110674 ⁶	1677	1369	968
		4.00	102	11.00	279	36.00	914	19-25	M110479	1608	1313	928
		5.00	127	9.00	229	44.50	1130	15-20	M090823	2329	1902	1345
		5.00	127	11.84	301	32.13	816	12-18	M120598	2264	1848	1307
		5.00	127	10 x 15	254 x 381	21.00	533	12-17	M120566	2205	1800	1273
		3.85 OD	98 OD	10 x 15	254 x 381	15.00	381	12-18	M120382	2265	1849	1307
5.00	127	Down Spout		11.00	279	36.00	914	13-19	M111024	1702	1390	983
		5.00	127	10.00	254	44.50	1130	13-18	M100213	2415	1972	1394
		5.00	127	11.84	301	25.75	654	12-18	M120749	3100	2450	1762
5.00	127	10 x 15	254 x 381	35.87	911	15-20	M120235	2098	1713	1211		

1 - Wrapped muffler (reduces noise and surface temperature)
 2 - Stainless Steel
 6 - Band clamp on inlet tube
 7 - Face flange on inlet

Muffler Selection by Style, Attenuation & Exhaust Flow



Stated backpressure levels include muffler, average tubing lengths, and accessories.

Style 4 - End Inlet / Side Outlet

-- Inlet I.D. --		--- Outlet I.D. ---		Body Diameter		Body Length		Attenuation	Part Number	----- Exhaust Flow (cfm) @ -----		
inch	mm	inch	mm	inch	mm	inch	mm	Range dB(A)		3" Hg 40.8" H ₂ O	2" Hg 27.2" H ₂ O	1" Hg 13.6" H ₂ O
2.00	51	2.00	51	6.00	152	15.75	400	12-18	M060481	498	393	283
2.50	64	2.50	64	6.62	168	17.75	451	12-18	M065140	780	613	441
3.00	76	3.00	76	8.50	216	19.75	502	12-18	M085409	1125	884	636
		3.00	76	8.50	216	26.25	667	15-20	M085206	715	583	413
3.50	89	3.50	89	9.00	229	21.75	552	12-18	M091048	1525	1203	865
		4.00	102	8.2 x 11.5	208 x 292	32.56	827	13-18	M090547	1500	1224	866
		4.00 OD	102 OD	8.2 x 11.5	208 x 292	32.56	827	13-18	M090548	1913	1562	1105
4.00	102	4.00	102	10.00	254	23.75	603	12-18	M101169	2000	1570	1130
		4.00	102	10.00	254	27.75	705	13-18	M100052	1679	1371	969
		4.00	102	11.00	279	36.00	914	15-21	M110112	1852	1512	1069
		4.00	102	11.00	279	36.00	914	15-21	M110148	1852	1512	1069
		4.00 OD	102 OD	11.00	279	36.00	914	15-21	M110311	1852	1512	1069
		4.00	102	10 x 15	254 x 381	30.38	772	15-20	M120367	1708	1394	986
		4.00	102	10 x 15	254 x 381	23.88	556	14-19	M120135	2100	1750	1260
4.00 OD	102 OD	4.00 OD	102 OD	11.00	279	36.00	914	15-21	M111025	1976	1613	1141
5.00	127	5.00	127	11.00	279	46.00	1168	15-20	M110014	2462	2010	1421
		5.00	127	11.84	301	25.75	654	12-18	M120749	3100	2450	1762
		5.00	127	10 x 15	254 x 381	36.00	914	15-20	M120366	2400	1960	1386



Mufflers in blue text have high temperature black finish and are designed for off-road applications.

Style 5 - Inlet & Outlet on Same End

-- Inlet I.D. --		--- Outlet I.D. ---		Body Diameter		Body Length		Attenuation	Part Number	----- Exhaust Flow (cfm) @ -----		
inch	mm	inch	mm	inch	mm	inch	mm	Range dB(A)		3" Hg 40.8" H ₂ O	2" Hg 27.2" H ₂ O	1" Hg 13.6" H ₂ O
2.00	51	2.00	51	6.00	152	15.75	400	12-18	M060482	498	393	283
		2.00	51	6.00	152	16.90	429	15-20	M060250	513	419	296
2.50	64	2.50	64	6.62	168	17.75	451	12-18	M065141	780	613	441
		2.50	64	6.62	168	20.00	508	15-20	M065073	718	586	414
3.00	76	3.00	76	8.50	216	22.00	559	15-20	M085207	1087	888	628
		3.00	76	8.50	216	19.75	502	12-18	M085410	1125	884	636
3.50	89	3.50	89	9.00	229	21.75	552	12-18	M091049	1525	1203	865
4.00	102	4.00	102	10.00	254	23.75	603	12-18	M101170	2000	1570	1130
		4.00	102	10.00	254	27.75	705	15-20	M100049	1450	1184	837
		4.00	102	10 x 15	254 x 381	26.00	660	18-20	M120154	1390	1135	803
5.00	127	5.00	127	10 x 15	254 x 381	27.00	686	15-20	M120713	2069	1689	1159
		5.00	127	10 x 15	254 x 381	26.25	667	15-20	M120176	2046	1670	1181
		5.00	127	10 x 15	254 x 381	26.00	660	8-12	M120131	2913	2378	1682
		5.00	127	10 x 15	254 x 381	33.38	848	19-25	M120189	2050	1674	1184
		5.00	127	10 x 15	254 x 381	44.00	1118	13-18	M120450	2679	2188	1547
5.00	127	11.84	301	25.75	654	12-18	M120750	3100	2450	1762		

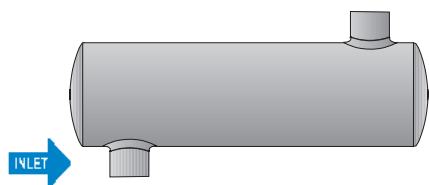

Stated backpressure levels include muffler, average tubing lengths, and accessories.

Style 6 - Side Inlet / Side Outlet

-- Inlet I.D. --		--- Outlet I.D. ---		Body Diameter		Body Length		Attenuation Range dB(A)	Part Number	----- Exhaust Flow (cfm) @ -----		
inch	mm	inch	mm	inch	mm	inch	mm			3" Hg 40.8" H ₂ O	2" Hg 27.2" H ₂ O	1" Hg 13.6" H ₂ O
2.00	51	2.00	51	6.00	152	15.50	394	12-18	M060483	498	393	283
		2.00	51	6.00	152	18.81	478	12-18	M060251	487	398	281
2.50	64	2.50	64	6.62	168	17.50	444	12-18	M065142	780	613	441
		2.50	64	6.62	168	20.81	529	15-20	M065074	692	565	400
3.00	76	3.00	76	8.50	216	19.50	495	12-18	M085411	1125	884	636
		3.00	76	8.50	216	27.00	686	15-20	M085208	1043	858	602
3.50	89	3.50	89	8.3 x 11.5	211 x 292	26.00	660	15-20	M090598	1164	950	672
		3.50	89	9.00	229	21.50	546	12-18	M091050	1525	1203	865
4.00	102	4.00	102	10.00	254	23.50	597	12-18	M101171	2000	1570	1130
		4.00	102	10.12	257	28.00	711	15-20	M100572	1659	1355	958
		4 OD	102 OD	11.00	279	36.00	914	13-19	M111026	1887	1541	1090
5.00	127	5.00	127	11.84	301	25.50	648	12-18	M120751	3100	2450	1762
		5.00	127	10 x 15	254 x 381	28.00	711	15-20	M120418	2350	1919	1357

Mufflers in blue text have high temperature black finish and are designed for off-road applications.

Choose the desired inlet diameter for the engine's air flow requirement that is at or below the acceptable backpressure level.

Style 1 - End Inlet / End Outlet / On Center

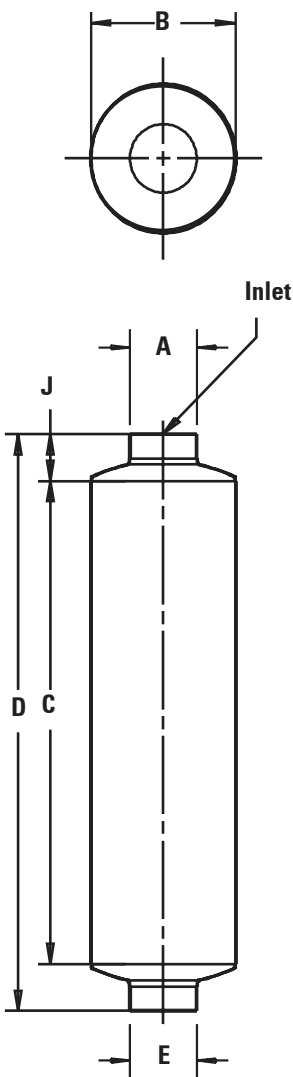

Style 2 - End Inlet / End Outlet / Offset

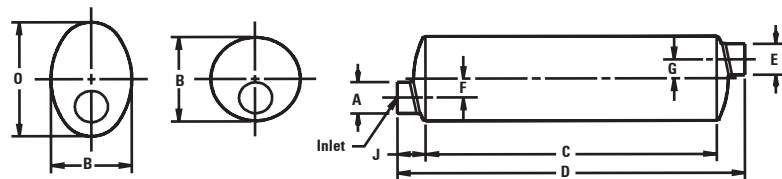

Style 2A - Dual End Inlet / End Outlet

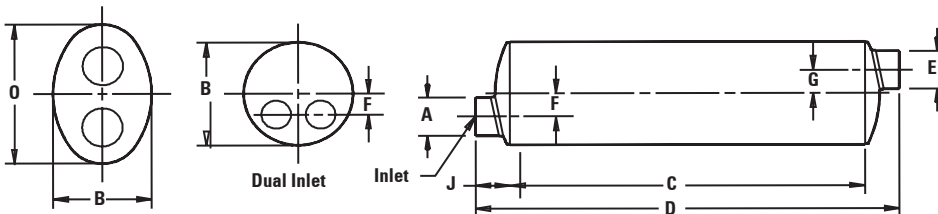

Style 3 - Side Inlet / End Outlet

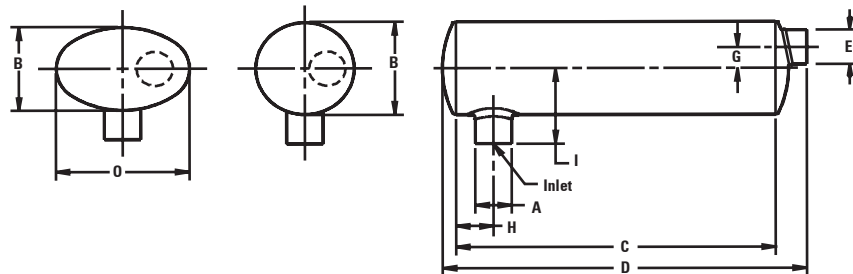

Style 4 - End Inlet / Side Outlet

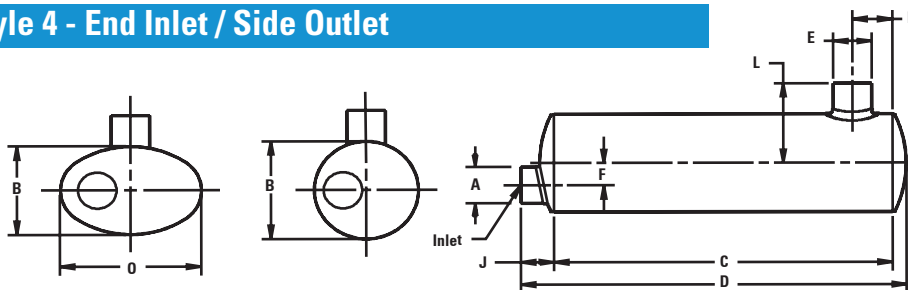

Style 5 - Inlet & Outlet on Same End

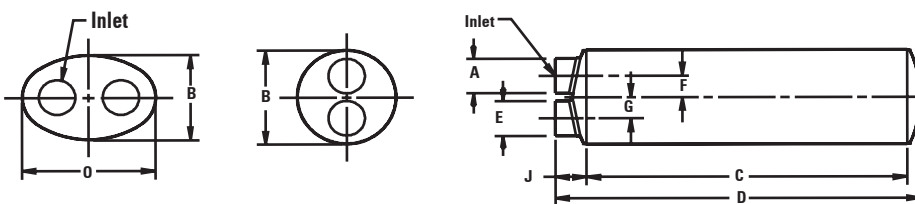

Style 6 - Side Inlet / Side Outlet

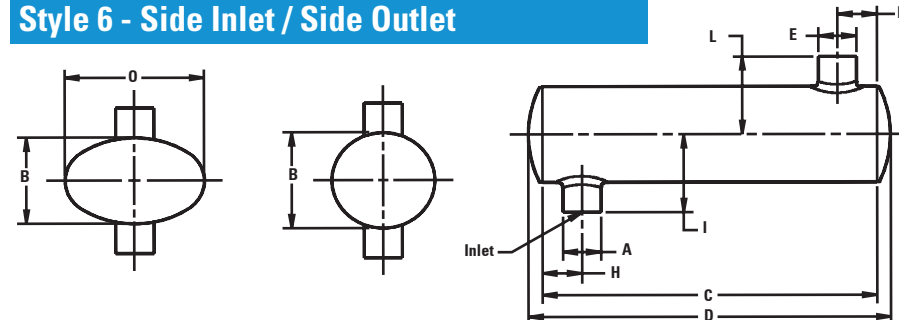

Part Number	Muffler Style	Body				Outlet I.D. (E)	Offset		Inlet Tube			Outlet Tube from End Center		Clock Position		Wgt lbs. kg
		Inlet I.D. (A)	Dia. (B) or (BxO)	Length (C)	Overall Length (D)		Inlet (F)	Outlet (G)	Loc. (H)	Length (I)	Length (J)	End Center (K)	Center (L)	Inlet	Outlet	
M045193	3	1.68 43	4.38 111	13.78 350	15.78 401	1.64 42			2.75 70	4.00 102				12:00		4 2
M045237	1	2.00 51	4.38 111	12.50 318	17.00 432	2.10 OD 53 OD					2.50 64					4 2
M060005	1	2.5 NPT	6.00 152	15.00 381	18.12 460	2.5NPT					1.56 40					9 4
M060055	2	2.00 51	6.00 152	16.90 429	21.90 556	2.00 51	1.50 38	1.50 38			2.50 64			6:00 12:00		7 3
M060158	3	2.00 51	6.00 152	18.81 478	21.50 546	2.00 51		1.50 38	3.50 89	5.00 127				3:00 6:00		9 4
M060232	2	2.00 51	6.00 152	24.00 610	29.00 737	2.00 51	1.50 38	1.50 38			2.50 64			6:00 12:00		9 4
M060247	1	2 NPT	6.00 152	14.50 368	20.00 508	2 NPT					2.75 70					7 3
M060250	5	2.00 51	6.00 152	16.90 429	19.40 493	2.00 51	1.50 38	1.50 38			2.50 64			6:00 12:00		8 4
M060251	6	2.00 51	6.00 152	18.81 478	18.81 478	2.00 51			3.50 89	5.00 127		3.50 89	5.00 127	6:00 12:00		8 4
M060479 ⁹	1	2.00 51	6.00 152	15.75 400	21.00 533	2.00 51					2.62 67					7.6 3.4
M060480 ⁸	2	2.00 51	6.00 152	15.75 400	21.00 533	2.00 51	1.50 38	1.50 38			2.62 67			6:00 12:00		7.6 3.4
M060481 ⁹	3/4	2.00 51	6.00 152	15.75 400	19.25 489	2.00 51			1.88 48	5.00 127				6:00		7.6 3.4
M060482 ⁹	5	2.00 51	6.00 152	15.75 400	19.25 489	2.00 51	1.50 38	1.50 38			2.62 67					8.4 3.8
M060483 ⁸	6	2.00 51	6.00 152	15.50 394	17.24 438	2.00 51			1.75 44	5.00 127		1.75 44	5.00 127	6:00 12:00		7.4 3.4
M065034	2	2.50 64	6.62 168	18.56 471	23.00 584	2.50 64	1.62 41	1.62 41			1.50 38			6:00 12:00		9 4
M065044	3	2.50 64	6.62 168	20.89 531	23.50 597	2.50 64		1.62 41	3.50 89	6.00 152				6:00 9:00		12 5
M065065	2	2.50 64	6.62 168	27.75 705	35.00 889	2.50 64	1.62 41	1.62 41			3.50 89			6:00 12:00		13 6
M065071	1	2.50 64	6.62 168	15.00 381	22.00 559	2.60 OD 66 OD					3.50 89					7 3
M065073	5	2.50 64	6.62 168	20.00 508	21.50 546	2.50 64	1.62 41	1.62 41			1.50 38			6:00 12:00		10 5
M065074	6	2.50 64	6.62 168	20.81 529	20.81 529	2.50 64			3.50 89	6.00 152		3.50 89	6.00 152	6:00 12:00		10 5
M065138 ⁸	1	2.50 64	6.62 168	17.75 451	24.00 610	2.50 64					3.12 79					9.8 4.5
M065139 ⁸	2	2.50 64	6.62 168	17.75 451	24.00 610	2.50 64	1.62 41	1.62 41			3.12 79			6:00 12:00		9.8 4.5
M065140 ⁹	3/4	2.50 64	6.62 168	17.75 451	22.04 560	2.50 64			2.38 60	5.75 146				6:00		10 4.5
M065141 ⁸	5	2.50 64	6.62 168	17.75 451	22.04 560	2.50 64	1.63 41	1.63 41			3.12 79			6:00 12:00		10.6 4.8
M065142 ⁸	6	2.50 64	6.62 168	17.50 444	19.84 504	2.50 64			2.50 64	5.75 146		2.25 57	5.75 146	6:00 12:00		9.4 4.2

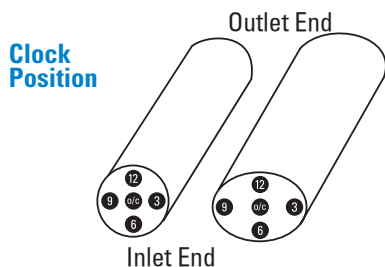

Footnotes

- 1 Wrapped muffler (reduces noise and surface temperature)
- 2 Stainless Steel
- 3 Silent Partner™ Muffler -Aluminized
- 4 Silent Partner™ Muffler -Stainless Steel
- 5 Resonator
- 6 Band clamp on inlet tube
- 7 Face flange on inlet
- 8 Made for off-road use
- 9 Made for off-road use, flows in either direction

Muffler Specification by Part Number

MUFFLER SPECS

Part Number	Muffler Style	Body				Outlet I.D. (E)	Offset		Inlet Tube			Outlet Tube from End Center		Clock Position		Wgt lbs. kg
		Inlet I.D. (A)	Dia. (B) or (BxO)	Length (C)	Overall Length (D)		Inlet (F)	Outlet (G)	Loc. (H)	Length (I)	Length (J)	End Center (K)	(L)	Inlet	Outlet	
M070008	1	3 NPT	7.00 178	14.00 356	19.75 502	3 NPT					2.38 60					13 6
M070028	1	3.50 89	7.00 178	14.00 356	19.75 502	3.50 89					2.38 60					10 5
M070050	1	3.5 NPT	7.00 178	18.38 467	25.62 651	3.5 NPT					3.00 76					18 8
M080018	1	3.00 76	8.00 203	12.18 309	17.00 432	3.13 OD 80 OD					1.38 35					10 5
M085008	2	3.50 89	8.50 216	38.00 965	43.00 1092	3.00 76	1.75 44	2.00 51			2.50 64			6:00 12:00		23 10
M085023	2	3.00 76	8.50 216	31.25 794	36.25 921	3.00 76	2.00 51	2.00 51			2.50 64			6:00 12:00		19 9
M085056	2	3.00 76	8.50 216	20.50 521	25.00 635	3.00 76	2.00 51	2.00 51			1.50 38			6:00 12:00		14 6
M085078	2	3.00 76	8.50 216	27.50 699	32.00 813	3.00 76	2.00 51	2.00 51			1.50 38			6:00 12:00		20 9
M085080	2	3.00 76	8.50 216	27.75 705	33.75 857	3.00 76	2.00 51	2.00 51			3.50 89			6:00 6:00		20 9
M085084	3	3.50 89	8.50 216	27.00 686	29.50 749	3.00 76		2.00 51	4.50 114	7.25 184				3:00 6:00		20 9
M085090	3	3.02 77	8.50 216	26.25 667	29.50 749	3.00 76		2.00 51	3.50 89	6.75 171				3:00 6:00		20 9
M085171	1	4.00 102	8.50 216	34.37 873	40.00 1016	4.00 102					2.50 64					21 10
M085172	2A	2.50 (2) 64 (2)	8.50 216	30.00 762	39.00 991	2.75 70	1.62 (2) 41 (2)	2.00 51			2.50 (2) 64 (2)			6:00(2) 6:00		24 11
M085189 ²	2A	2.50 (2) 64 (2)	8.50 216	31.25 794	36.25 921	3.00 76	1.62 (2) 41 (2)	2.00 51			2.50 (2) 64 (2)			6:00 (2) 12:00		23 10
M085206	4	3.00 76	8.50 216	26.25 667	29.50 749	3.00 76	2.00 51				3.25 83	3.50 89	6.75 171	6:00 9:00		20 9
M085207	5	3.00 76	8.50 216	22.00 559	23.50 597	3.00 76	2.00 51	2.00 51			1.50 38			6:00 12:00		16 7
M085208	6	3.00 76	8.50 216	27.00 686	27.00 686	3.00 76			3.50 89	6.75 171		3.50 89	6.75 171	6:00 12:00		17 8
M085226 ¹	3	3.00 76	8.80 224	27.12 689	29.56 751	3.00 76		2.00 51	4.56 116	6.75 171				3:00 6:00		28 13
M085267 ^{1,2}	2A	2.50 (2) ⁷ 64 (2) ⁷	8.75 222	30.12 765	38.97 990	3 OD 76 OD	1.62 (2) 41 (2)	2.00 51			5.72/3.22 146/82			6:00 (2) 12:00		32 15
M085293	1	2.89 ⁷ 73 ⁷	8.50 216	31.75 806	46.25 1175	3.16 OD 80 OD										28 12
M085407 ⁸	1	3.00 76	8.50 216	19.75 502	26.50 673	3.00 76					3.38 86					15.2 7
M085408 ⁸	2	3.00 76	8.50 216	19.75 502	26.50 673	3.00 76	2.00 51	2.00 51			3.38 86			6:00 12:00		15.2 7
M085409 ⁹	3/4	3.00 76	8.50 216	19.75 502	24.27 616	3.00 76			2.88 73	6.50 165				6:00		15.4 7
M085410 ⁸	5	3.00 76	8.50 216	19.75 502	24.27 616	3.00 76	2.00 51	2.00 51			3.38 86			6:00 12:00		17 7.7
M085411 ⁸	6	3.00 76	8.50 216	19.50 495	21.78 553	3.00 76			3.00 76	6.50 165		3.00 76	6.50 165	6:00 12:00		14.2 6.4
M085421	1	4.00 102	8.50 216	34.37 873	40.00 1016	4.00 102					2.50 64					21 10
M090009	1	4 NPT	9.00 229	20.00 508	26.00 660	4 NPT					3.00 76					23 10
M090072 ⁵	1	5.00 127	9.00 229	10.00 254	16.50 419	5.00 127					3.00 76					9 4

Part Number	Muffler Style	----- Body -----				Outlet I.D. (E)	---- Offset ----		----- Inlet Tube -----			Outlet Tube from End Center (K) (L)		Clock Position Inlet Outlet	Wgt lbs. kg
		Inlet I.D. (A)	Dia. (B) or (BxO)	Length (C)	Overall Length (D)		Inlet (F)	Outlet (G)	Loc. (H)	Length (I)	Length (J)				
M090074	1	5.00 127	9.00 229	44.44 1129	51.00 1295	5.00 127					3.00 76				29 13
M090095	1	4.00 ⁷ 102 ⁷	9.00 229	29.31 744	73.00 1854	4 OD 102 OD									33 15
M090146	1	3.50 89	9.00 229	44.50 1130	51.00 1295	3.50 89					3.00 76				32 15
M090158	2	3.50 89	8.3 x 11.5 211 x 292	26.00 660	32.25 819	3.50 89	2.50 64	2.50 64			3.12 79		3:00 9:00		24 11
M090159 ¹	2	3.00 76	8.5 x 11.8 216 x 300	26.00 660	33.75 857	3.00 76	2.50 64	2.50 64			3.88 99		3:00 3:00		29 13
M090170	2	3.00 76	8.3 x 11.5 211 x 292	26.00 660	33.75 857	3.00 76	2.50 64	2.50 64			3.88 99		3:00 3:00		20 9
M090210 ¹	2	3.50 89	8.5 x 11.8 216 x 300	26.00 660	32.25 819	3.50 89	2.50 64	2.50 64			3.12 79		3:00 9:00		34 15
M090280	2	4.00 102	8.2 x 11.5 208 x 292	26.00 660	32.25 819	4.00 102	2.50 64	2.50 64			3.12 79		3:00 9:00		22 10
M090301	3	3.50 89	8.3 x 11.5 211 x 292	26.13 664	29.25 743	3.50 89		2.50 64	3.25 83	7.00 178			6:00 9:00		23 10
M090362 ⁵	1	4.00 102	9.00 229	10.00 254	16.50 419	4.00 102					3.00 76				9 4
M090520	2	3.50 89	8.2 x 11.5 208 x 292	26.00 660	32.25 819	4.00 102	2.50 64	2.50 64			3.12 79		3:00 9:00		21 10
M090534	2	4.00 102	8.2 x 11.5 208 x 292	26.00 660	33.75 857	4.00 102	2.50 64	2.50 64			3.88 99		3:00 9:00		26 12
M090535	1	5.00 127	9.00 229	44.44 1129	51.00 1295	5.00 127					3.00 76				30 14
M090538	2	4.00 102	8.2 x 11.5 208 x 292	26.00 660	32.25 819	3.50 89	2.50 64	2.50 64			3.12 79		3:00 12:00		26 12
M090544	1	4.00 102	9.00 229	44.44 1129	51.00 1295	4.00 102					3.00 76				27 12
M090547	4	3.50 89	8.2 x 11.5 208 x 292	32.56 827	35.16 893	4.00 102	2.50 64				2.60 66	20.48 520	6.00 152	9:00 7:00	22 10
M090548	4	3.50 89	8.2 x 11.5 208 x 292	32.56 827	35.16 893	4 OD 102 OD	2.50 64				2.60 66	20.48 520	8.70 221	3:00 7:30	21 10
M090563	2A	2.75 (2) 70 (2)	8.2 x 11.5 208 x 292	27.00 686	32.75 832	4.00 102	0.15/4.00 9/102	2.50 64			2.63 (2) 67 (2)			9:00-3:00 3:00	22 10
M090594	1	4.00 102	9.00 229	20.00 508	26.50 673	4.00 102					3.00 76				14 6
M090595	1	5.00 127	9.00 229	20.00 508	26.50 673	5.00 127					3.00 76				15 7
M090598	6	3.50 89	8.3 x 11.5 211 x 292	26.00 660	26.00 660	3.50 89			3.38 86	7.00 178		3.38 86	7.00 178	6:00 12:00	20 9
M090680	2	3.50 89	8.2 x 11.5 208 x 292	30.00 762	36.25 921	4.00 102	2.50 64	2.50 64			3.12 79		3:00 9:00		25 11
M090781	1	4.00 102	9.00 229	44.44 1129	51.00 1295	5.00 127					3.00 76				30 14
M090823	3	4.00 102	9.00 229	44.50 1130	48.00 1219	5.00 127			3.81 97	6.69 170			6:00		30 13
M091046 ⁸	1	3.50 89	9.00 229	21.75 552	29.00 737	3.50 89					3.62 89				15.8 7.2

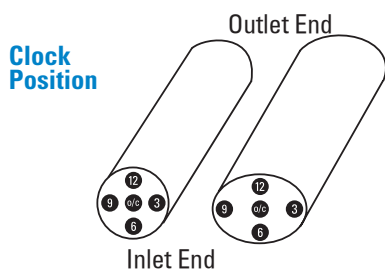

Footnotes

- 1 Wrapped muffler (reduces noise and surface temperature)
- 2 Stainless Steel
- 3 Silent Partner™ Muffler -Aluminized
- 4 Silent Partner™ Muffler -Stainless Steel
- 5 Resonator
- 6 Band clamp on inlet tube
- 7 Face flange on inlet
- 8 Made for off-road use
- 9 Made for off-road use, flows in either direction

Muffler Specification by Part Number

Part Number	Muffler Style	Body				Outlet I.D. (E)	Offset		Inlet Tube			Outlet Tube from End Center		Clock Position		Wgt lbs. kg
		Inlet I.D. (A)	Dia. (B) or (BxO)	Length (C)	Overall Length (D)		Inlet (F)	Outlet (G)	Loc. (H)	Length (I)	Length (J)	End Center (K)	End Center (L)	Inlet	Outlet	
M091047 ⁸	2	3.50 89	9.00 229	21.75 552	29.00 737	3.50 89	2.10 53	2.10 53			3.62 89			6:00	12:00	15.8 7.2
M091048 ⁹	3/4	3.50 89	9.00 229	21.75 552	26.38 670	3.50 89			3.38 86	7.25 184				6:00		15.9 7.2
M091049 ⁸	5	3.50 89	9.00 229	21.75 552	26.44 672	3.50 89	2.10 53	2.10 53			3.62 89			6:00	12:00	17.3 7.9
M091050 ⁸	6	3.50 89	9.00 229	21.50 546	23.64 600	3.50 89			3.25 83	7.25 184		3.25 83	7.25 184	6:00	12:00	15.1 6.9
M100043	2	4.00 102	10.00 254	35.38 899	41.75 1060	4.00 102	2.44 62	2.44 62			2.88 73			6:00	12:00	32 15
M100048	2	4.00 102	10.00 254	27.12 689	33.50 851	4.00 102	2.44 62	2.44 62			2.88 73			6:00	12:00	27 12
M100049	5	4.00 102	10.00 254	27.75 705	30.62 778	4.00 102	2.44 62	2.44 62			2.88 73			12:00	6:00	23 10
M100052	4	4.00 102	10.00 254	27.75 705	30.75 781	4.00 102	2.44 62				3.00 76	24.25 616	8.75 222	6:00	2:00	25 11
M100146	3	4.00 102	10.00 254	28.00 711	32.00 813	4.00 102		2.44 62	4.50 114	8.00 203				6:00	9:00	27 12
M100213	3	5.00 127	10.00 254	44.50 1130	48.00 1219	5.00 127			5.50 140	7.50 191				6:00		33 15
M100463	1	5.00 127	10.00 254	44.44 1129	51.00 1295	5.00 127					3.00 76					31 14
M100464 ¹	1	4.00 102	10.33 262	44.50 1130	51.00 1295	4.00 102					3.00 76					52 24
M100465	1	5.00 127	10.00 254	44.44 1129	51.00 1295	5.00 127					3.00 76					21 9.5
M100466	1	4.00 102	10.00 254	44.44 1129	51.00 1295	4.00 102					3.00 76					27 12
M100572	6	4.00 102	10.12 257	28.00 711	30.62 778	4.00 102			4.50 114	8.00 203		4.50 114	8.00 203	6:00	12:00	22 10
M100580	1	5.00 127	10.00 254	44.44 1129	51.00 1295	5.00 127					3.00 76					29 13
M100582	1	5.00 127	10.00 254	44.44 1129	51.00 1295	5.00 127					3.00 76					31 14
M100695	1	4.00 102	10.00 254	44.44 1129	51.00 1295	5.00 127					3.00 76					30 14
M100807	1	5.00 127	10.00 254	59.94 1522	66.50 1689	5.00 127					3.00 76					48 22
M100944	1	5.00 127	10.00 254	44.44 1129	51.00 1295	5.00 127					3.00 76					32 15
M101158 ⁴	1	5.00 127	10.00 254	44.44 1129	51.00 1295	5.00 127					3.00 76					43 20
M101159 ⁴	1	5.00 127	10.00 254	44.44 1129	51.00 1295	5.00 127					3.00 76					43 20
M101167 ⁸	1	4.00 102	10.00 254	23.75 603	32.00 813	4.00 102					4.12 105					19.3 8.8
M101168 ⁸	2	4.00 102	10.00 254	23.75 603	32.00 813	4.00 102	2.44 62	2.44 62			4.12 105			6:00	12:00	19.3 8.8
M101169 ⁹	3/4	4.00 102	10.00 254	23.75 603	29.24 743	4.00 102			3.88 99	8.00 203				6:00		19.8 9
M101170 ⁹	5	4.00 102	10.00 254	23.75 603	29.24 743	4.00 102	2.44 62	2.44 62			4.12 105			6:00	12:00	22 10
M101171 ⁸	6	4.00 102	10.00 254	23.50 597	26.24 666	4.00 102			3.75 95	8.00 203		3.75 95	8.00 203	6:00	12:00	19.1 8.7
M101181 ³	1	5.00 127	10.00 254	44.44 1129	51.00 1295	5.00 127					3.00 76					43 20
M101182 ³	1	5.00 127	10.00 254	44.44 1129	51.00 1295	5.00 127					3.00 76					43 20

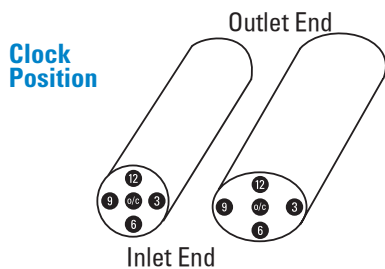
Part Number	Muffler Style	----- Body -----				Outlet I.D. (E)	---- Offset ----		----- Inlet Tube -----			Outlet Tube from End Center (L)		Clock Position		Wgt lbs. kg
		Inlet I.D. (A)	Dia. (B) or (BxO)	Length (C)	Overall Length (D)		Inlet (F)	Outlet (G)	Loc. (H)	Length (I)	Length (J)	Inlet	Outlet	Inlet	Outlet	
M101263	1	5.00 127	10.00 254	44.44 1129	53.00 1346	5.00 127					3.00 76					31 14
M110012	2	4.00 102	11.00 279	30.00 762	36.00 914	4.00 102	2.50 64	2.50 64			3.00 76			6:00	12:00	26 12
M110014	4	5.00 127	11.00 279	46.00 1168	51.75 1314	5.00 127	2.50 64				4.25 108	38.50 978	8.50 216	6:00	12:00	45 20
M110077	2	5.00 127	11.00 279	44.00 1118	50.00 1270	5.00 127	2.50 64	2.50 64			3.00 76			6:00	12:00	44 20
M110112	4	4.00 102	11.00 279	36.00 914	39.00 991	4.00 102	2.50 64				3.00 76	15.97 406	8.64 219	6:00	9:00	29 13
M110148	4	4.00 102	11.00 279	36.00 914	39.00 991	4.00 102	2.50 64				3.00 76	17.25 438	8.64 219	6:00	12:00	29 13
M110189	2	4.00 102	11.00 279	36.00 914	41.25 1048	4.00 102	2.50 64	2.50 64			2.63 67			6:00	12:00	34 15
M110311	4	4.00 OD 102	11.00 279	36.00 914	41.00 1041	4.00 102	2.50 64				5.00 127	27.10 688	8.64 219	6:00	12:00	27 12
M110479	3	4.00 102	11.00 279	36.00 914	39.00 991	4.00 102		2.50 64	4.25 108	8.64 219				6:00	3:00	31 14
M110674 ⁶	3	4.00 102	11.00 279	33.00 838	36.00 914	4.00 102			3.75 95	8.64 219				6:00		27 12
M110849	1	5.00 127	11.00 279	50.50 1283	57.00 1448	5.00 127					3.00 76					48 22
M111024	3	4.00 102	11.00 279	36.00 914	44.59 1133	Down Spout			3.75 95	8.64 219				12:00	6:00	34 15
M111025	4	4 OD 102 OD	11.00 279	36.00 914	41.00 1041	4 OD 102 OD					5.00 127	19.66 499	10.50 267		6:00	27 12
M111026	6	4.00 102	11.00 279	36.00 914	36.00 914	4 OD 102 OD			3.75 95	8.64 219		9.23 234	9.50 241	12:00	9:00	29 13
M111028	2	4 OD 102 OD	11.00 279	36.00 914	44.00 1118	5.00 127	2.50 64				5.00 127			12:00		36 16
M111029	1	3.00 76	11.00 279	36.00 914	42.00 1067	4.00 102					3.00 76					34 15
M120100	2	4.00 102	10 x15 254 x 381	26.00 660	32.50 826	4.00 102	4.25 108	4.25 108			3.25 83			3:00	9:00	30 14
M120108	2	5.00 127	10 x15 254 x 381	26.00 660	32.50 826	5.00 127	3.12 79	3.12 79			3.25 83			3:00	9:00	34 15
M120131	5	5.00 127	10 x15 254 x 381	26.00 660	29.39 747	5.00 127	3.12 79	3.12 79			3.25 83			3:00	9:00	32 15
M120135	4	4.00 102	10 x15 254 x 381	21.88 556	24.75 629	4.00 102	4.25 108				2.88 73	7.25 184	9.80 249	3:00	9:00	25 11
M120154	5	4.00 102	10 x15 254 x 381	26.00 660	28.38 721	4.00 102	4.25 108	4.25 108			2.25 57			3:00	9:00	31 14
M120176	5	5.00 127	10 x15 254 x 381	26.25 667	29.38 746	5.00 127	3.12 79	3.12 79			3.00 76			3:00	9:00	29 13
M120189	5	5.00 127	10 x15 254 x 381	33.38 848	39.50 1003	5.00 127	3.59 91	3.59 91			4.44 113			3:00	9:00	46 21
M120197 ¹	2	4.00 102	10.3 x15.3 261 x 389	36.00 914	42.00 1067	4.00 102	4.25 108	0.50 13			3.00 76			3:00	9:00	58 26
M120225	2	5.00 127	10 x15 254 x 381	26.00 660	32.50 826	5.00 127	3.12 79	3.12 79			3.25 86			3:00	9:00	31 14



Footnotes

- 1 Wrapped muffler (reduces noise and surface temperature)
- 2 Stainless Steel
- 3 Silent Partner™ Muffler -Aluminized
- 4 Silent Partner™ Muffler -Stainless Steel
- 5 Resonator
- 6 Band clamp on inlet tube
- 7 Face flange on inlet
- 8 Made for off-road use
- 9 Made for off-road use, flows in either direction

Muffler Specification by Part Number

MUFFLER SPECS

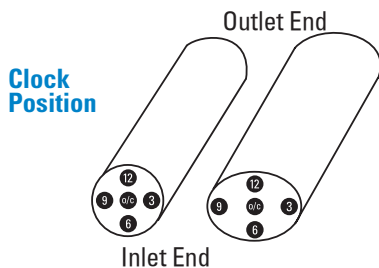
Part Number	Muffler Style	Body				Outlet I.D. (E)	Offset		Inlet Tube			Outlet Tube from End Center		Clock Position		Wgt lbs. kg
		Inlet I.D. (A)	Dia. (B) or (BxO)	Length (C)	Overall Length (D)		Inlet (F)	Outlet (G)	Loc. (H)	Length (I)	Length (J)	End Center (K)	Center (L)	Inlet	Outlet	
M120235	3	5.00 127	10 x15 254 x 381	35.87 911	39.87 1013	5.00 127		3.12 79	6.13 153	8.00 203				6:00	9:00	39 18
M120365	2	5.00 127	10 x15 254 x 381	36.00 914	42.50 1080	5.00 127	3.12 79	3.12 79			3.25 83			6:00	12:00	44 20
M120366	4	5.00 127	10 x15 254 x 381	36.00 914	39.25 997	5.00 127	3.12 79				3.12 79	28.38 721	9.50 241	3:00	9:00	48 22
M120367	4	4.00 102	10 x15 254 x 381	30.38 772	34.00 864	4.00 102	4.25 108				3.50 89	22.88 581	10.50 267	3:00	9:00	32 15
M120382	3	4.00 102	10 x15 254 x 381	15.00 381	21.57 548	3.85 OD 98 OD	4.40 112		3.25 83	10.80 274				9:00	9:00	18 8
M120418	6	5.00 127	10 x15 254 x 381	28.00 711	28.25 718	5.00 127			5.00 127	8.00 203		5.00 127	8.00 203	6:00	12:00	27 12
M120448	2	5.00 127	10 x15 254 x 381	44.00 1118	50.00 1270	5.00 127	3.59 91	3.59 91			3.00 76			3:00	9:00	50 23
M120450	5	5.00 127	10 x15 254 x 381	44.00 1118	47.38 1203	5.00 127	3.59 91	3.59 91			3.25 83			3:00	9:00	46 21
M120566	3	4.00 102	10 x15 254 x 381	21.00 533	25.25 641	5.00 127	4.25 108		3.13 80	10.80 274				3:00	3:00	25 11
M120598	3	4.00 102	11.84 301	32.13 816	35.50 902	5.00 127			4.50 114	11.02 280				6:00		30 14
M120713	5	4.00 102	10 x15 254 x 381	27.00 686	31.13 791	5.00 127	4.40 112	4.25 108			4.00 102			3:00	9:00	31 14
M120747 ⁸	1	5.00 127	11.84 301	25.75 654	34.00 864	5.00 127					4.12 105					26.7 12
M120748 ⁸	2	5.00 127	11.84 301	25.75 654	34.00 864	5.00 127	2.81 71	2.81 71			4.12 105			6:00	12:00	26.7 12
M120749 ⁹	3/4	5.00 127	11.84 301	25.75 654	31.69 805	5.00 127			4.88 124	8.75 222				6:00		27.5 12.5
M120750 ⁸	5	5.00 127	11.84 301	25.75 654	31.69 805	5.00 127	2.81 71	2.81 71			4.12 105			6:00	12:00	28.7 13
M120751 ⁸	6	5.00 127	11.84 301	25.50 648	29.14 740	5.00 127			4.75 121	8.75 222		4.75 121	8.75 222	6:00	12:00	26.4 12
M122300	2	6.00 152	10 x15 254 x 381	31.75 806	42.50 1080	6.00 152	3.59 91	3.59 91			5.38 137			3:00	9:00	43 20
M140048	2	6.00 152	12 x18 305 x 457	30.00 762	38.00 965	6.00 152	4.50 114	4.50 114			4.00 102			3:00	9:00	50 23
M170101	2	6.00 152	14 x21 357 x 533	35.00 889	47.00 1194	6.00 152	5.25 133	5.25 133			6.00 152			3:00	9:00	89 40
M190002	2	8.00 203	16 x24 406 x 607	45.00 1143	57.00 1448	8.00 203	6.00 152	6.00 152			6.00 152			3:00	3:00	124 56



Footnotes

- 1 Wrapped muffler (reduces noise and surface temperature)
- 2 Stainless Steel
- 3 Silent Partner™ Muffler -Aluminized
- 4 Silent Partner™ Muffler -Stainless Steel
- 5 Resonator
- 6 Band clamp on inlet tube
- 7 Face flange on inlet
- 8 Made for off-road use
- 9 Made for off-road use, flows in either direction

Style 1 - End Inlet / End Outlet / On Center

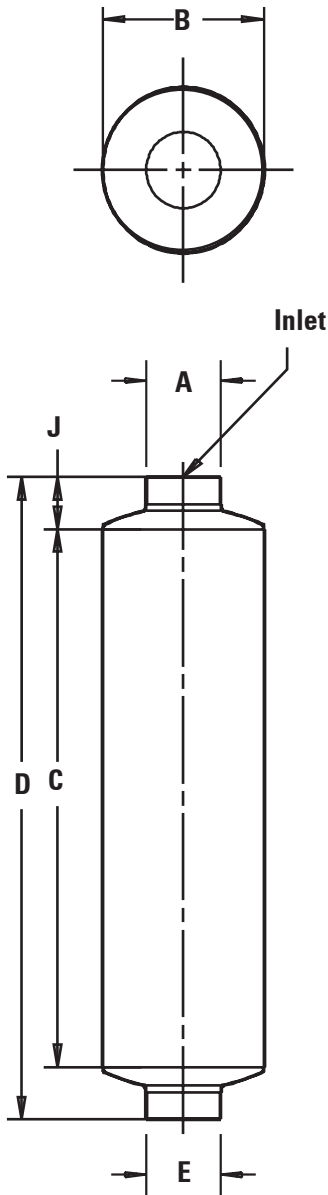

Part Number	Muffler Style	Body				Outlet I.D. (E)	Inlet Tube Length (J)	Wgt lbs. kg
		Inlet I.D. (A)	Dia. (B) or (BxO)	Length (C)	Overall Length (D)			
M060247	1	2 NPT	6.00 152	14.50 368	20.00 508	2 NPT	2.75 70	7 3
M060005	1	2.5 NPT	6.00 152	15.00 381	18.12 460	2.5 NPT	1.56 40	9 4
M070008	1	3 NPT	7.00 178	14.00 356	19.75 502	3 NPT	2.38 60	13 6
M070050	1	3.5 NPT	7.00 178	18.38 467	25.62 651	3.5 NPT	3.00 76	18 8
M090009	1	4 NPT	9.00 229	20.00 508	26.00 660	4 NPT	3.00 76	23 10
M045237	1	2.00	4.38 111	12.50 318	17.00 432	2.10 OD 53 OD	2.50 64	4 2
M060479 ⁸	1	2.00	6.00 152	15.75 400	21.00 533	2.00 51	2.62 67	7.6 3.4
M065071	1	2.50	6.62 168	15.00 381	22.00 559	2.60 OD 66 OD	3.50 89	7 3
M065138 ⁸	1	2.50	6.62 168	17.75 451	24.00 610	2.50 64	3.12 79	9.8 4.5
M085293	1	2.89 ⁷ 73 ⁷	8.50 216	31.75 806	46.25 1175	3.16 OD 80 OD		28 12
M085407 ⁸	1	3.00	8.50 216	19.75 502	26.50 673	3.00 76	3.38 86	15.2 7
M080018	1	3.00	8.00 203	12.18 309	17.00 432	3.13 OD 80 OD	1.38 35	10 5
M111029	1	3.00	11.00 279	36.00 914	42.00 1067	4.00 102	3.00 76	34 15
M070028	1	3.50	7.00 178	14.00 356	19.75 502	3.50 89	2.38 60	10 5
M090146	1	3.50	9.00 229	44.50 1130	51.00 1295	3.50 89	3.00 76	32 15
M091046 ⁸	1	3.50	9.00 229	21.75 552	29.00 737	3.50 89	3.62 89	15.8 7.2
M085171	1	4.00	8.50 216	34.37 873	40.00 1016	4.00 102	2.50 64	21 10
M085421	1	4.00	8.50 216	34.37 873	40.00 1016	4.00 102	2.50 64	21 10
M090095	1	4.00 ⁷ 102 ⁷	9.00 229	29.31 744	73.00 1854	4 OD 102 OD		33 15
M090362 ⁵	1	4.00	9.00 229	10.00 254	16.50 419	4.00 102	3.00 76	9 4
M090544	1	4.00	9.00 229	44.44 1129	51.00 1295	4.00 102	3.00 76	27 12
M090594	1	4.00	9.00 229	20.00 508	26.50 673	4.00 102	3.00 76	14 6
M090781	1	4.00	9.00 229	44.44 1129	51.00 1295	5.00 127	3.00 76	30 14
M100464 ¹	1	4.00	10.33 262	44.50 1130	51.00 1295	4.00 102	3.00 76	52 24
M100466	1	4.00	10.00 254	44.44 1129	51.00 1295	4.00 102	3.00 76	27 12
M100695	1	4.00	10.00 254	44.44 1129	51.00 1295	5.00 127	3.00 76	30 14
M101167 ⁸	1	4.00	10.00 254	23.75 603	32.00 813	4.00 102	4.12 105	19.3 8.8

Style 1 - End Inlet / End Outlet / On Center

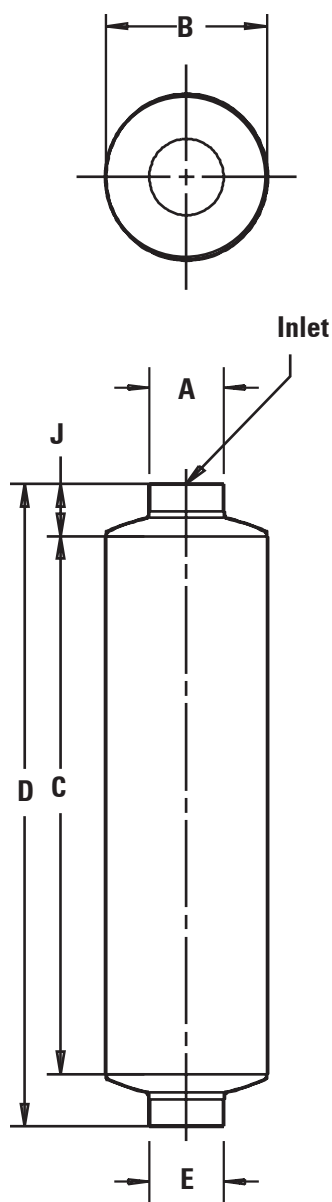

Part Number	Muffler Style	Body				Outlet I.D. (E)	Inlet Tube Length (J)	Wgt lbs. / kg
		Inlet I.D. (A)	Dia. (B) or (BxO)	Length (C)	Overall Length (D)			
M090072 ⁵	1	5.00 127	9.00 229	10.00 254	16.50 419	5.00 127	3.00 76	9 4
M090074	1	5.00 127	9.00 229	44.44 1129	51.00 1295	5.00 127	3.00 76	29 13
M090535	1	5.00 127	9.00 229	44.44 1129	51.00 1295	5.00 127	3.00 76	30 14
M090595	1	5.00 127	9.00 229	20.00 508	26.50 673	5.00 127	3.00 76	15 7
M100463	1	5.00 127	10.00 254	44.44 1129	51.00 1295	5.00 127	3.00 76	31 14
M100465	1	5.00 127	10.00 254	44.44 1129	51.00 1295	5.00 127	3.00 76	21 9.5
M100580	1	5.00 127	10.00 254	44.44 1129	51.00 1295	5.00 127	3.00 76	29 13
M100582	1	5.00 127	10.00 254	44.44 1129	51.00 1295	5.00 127	3.00 76	31 14
M100807	1	5.00 127	10.00 254	59.94 1522	66.50 1689	5.00 127	3.00 76	48 22
M100944	1	5.00 127	10.00 254	44.44 1129	51.00 1295	5.00 127	3.00 76	32 15
M101158 ⁴	1	5.00 127	10.00 254	44.44 1129	51.00 1295	5.00 127	3.00 76	43 20
M101159 ⁴	1	5.00 127	10.00 254	44.44 1129	51.00 1295	5.00 127	3.00 76	43 20
M101181 ³	1	5.00 127	10.00 254	44.44 1129	51.00 1295	5.00 127	3.00 76	43 20
M101182 ³	1	5.00 127	10.00 254	44.44 1129	51.00 1295	5.00 127	3.00 76	43 20
M101263	1	5.00 127	10.00 254	44.44 1129	53.00 1346	5.00 127	3.00 76	31 14
M110849	1	5.00 127	11.00 279	50.50 1283	57.00 1448	5.00 127	3.00 76	48 22
M120747 ⁶	1	5.00 127	11.84 301	25.75 654	34.00 864	5.00 127	4.12 105	26.7 12

Style 2 and 2A on pages 82 and 83

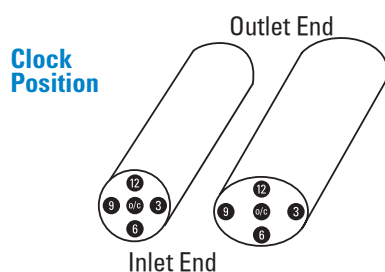

Footnotes

- | | |
|---|--|
| 1 Wrapped muffler (reduces noise and surface temperature) | 6 Band clamp on inlet tube |
| 2 Stainless Steel | 7 Face flange on inlet |
| 3 Silent Partner™ Muffler -Aluminized | 8 Made for off-road use |
| 4 Silent Partner™ Muffler -Stainless Steel | 9 Made for off-road use, flows in either direction |
| 5 Resonator | |

Style 3 - Side Inlet / End Outlet

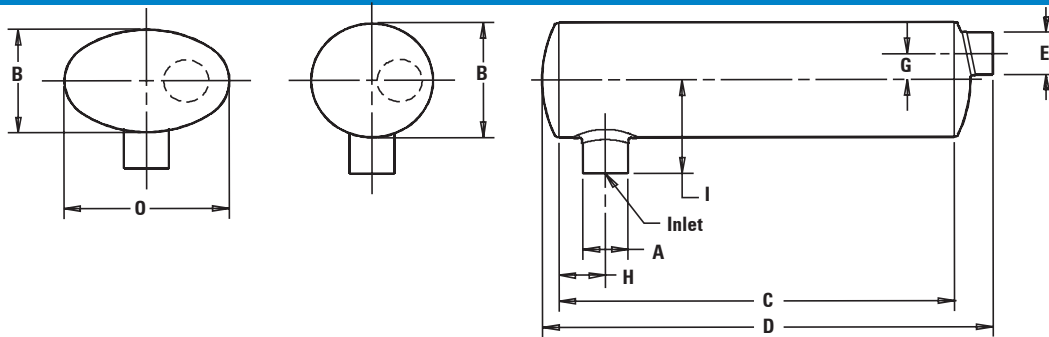

Part Number	Muffler Style	----- Body -----				---- Offset ----		----- Inlet Tube -----			Outlet Tube from End Center		Clock Position		Wgt lbs. kg
		Inlet I.D. (A)	Dia. (B) or (BxO)	Length (C)	Overall Length (D)	Inlet I.D. (E)	Outlet (G)	Loc. (H)	Length (I)	Length (J)	Inlet (K)	Outlet (L)	Inlet	Outlet	
M045193	3	1.68 43	4.38 111	13.78 350	15.78 401	1.64 42		2.75 70	4.00 102				12:00	4 2	
M060158	3	2.00 51	6.00 152	18.81 478	21.50 546	2.00 51	1.50 38	3.50 89	5.00 127				3:00 6:00	9 4	
M060481 ⁹	3/4	2.00 51	6.00 152	15.75 400	19.25 489	2.00 51		1.88 48	5.00 127				6:00	7.6 3.4	
M065044	3	2.50 64	6.62 168	20.89 531	23.50 597	2.50 64	1.62 41	3.50 89	6.00 152				6:00 9:00	12 5	
M065140 ⁹	3/4	2.50 64	6.62 168	17.75 451	22.04 560	2.50 64		2.38 60	5.75 146				6:00	10 4.5	
M085084	3	3.50 89	8.50 216	27.00 686	29.50 749	3.00 76	2.00 51	4.50 114	7.25 184				3:00 6:00	20 9	
M085090	3	3.02 77	8.50 216	26.25 667	29.50 749	3.00 76	2.00 51	3.50 89	6.75 171				3:00 6:00	20 9	
M085226 ¹	3	3.00 76	8.80 224	27.12 689	29.56 751	3.00 76	2.00 51	4.56 116	6.75 171				3:00 6:00	28 13	
M085409 ⁹	3/4	3.00 76	8.50 216	19.75 502	24.27 616	3.00 76		2.88 73	6.50 165				6:00	15.4 7	
M090301	3	3.50 89	8.3 x 11.5 211 x 292	26.13 664	29.25 743	3.50 89	2.50 64	3.25 83	7.00 178				6:00 9:00	23 10	
M090823	3	4.00 102	9.00 229	44.50 1130	48.00 1219	5.00 127		3.81 97	6.69 170				6:00	30 13	
M091048 ⁹	3/4	3.50 89	9.00 229	21.75 552	26.38 670	3.50 89		3.38 86	7.25 184				6:00	15.9 7.2	
M100146	3	4.00 102	10.00 254	28.00 711	32.00 813	4.00 102	2.44 62	4.50 114	8.00 203				6:00 9:00	27 12	
M100213	3	5.00 127	10.00 254	44.50 1130	48.00 1219	5.00 127		5.50 140	7.50 191				6:00	33 15	
M101169 ⁹	3/4	4.00 102	10.00 254	23.75 603	29.24 743	4.00 102		3.88 99	8.00 203				6:00	19.8 9	
M110479	3	4.00 102	11.00 279	36.00 914	39.00 991	4.00 102	2.50 64	4.25 108	8.64 219				6:00 3:00	31 14	
M110674 ⁶	3	4.00 102	11.00 279	33.00 838	36.00 914	4.00 102		3.75 95	8.64 219				6:00	27 12	
M111024	3	4.00 102	11.00 279	36.00 914	44.59 1133	Down Spout		3.75 95	8.64 219				12:00 6:00	34 15	
M120235	3	5.00 127	10 x 15 254 x 381	35.87 911	39.87 1013	5.00 127	3.12 79	6.13 153	8.00 203				6:00 9:00	39 18	
M120382	3	4.00 102	10 x 15 254 x 381	15.00 381	21.57 548	3.85 OD 98 OD	4.40 112	3.25 83	10.80 274				9:00 9:00	18 8	
M120566	3	4.00 102	10 x 15 254 x 381	21.00 533	25.25 641	5.00 127	4.25 108	3.13 80	10.80 274				3:00 3:00	25 11	
M120598	3	4.00 102	11.84 301	32.13 816	35.50 902	5.00 127		4.50 114	11.02 280				6:00	30 14	
M120749 ⁹	3/4	5.00 127	11.84 301	25.75 654	31.69 805	5.00 127		4.88 124	8.75 222				6:00	27.5 12.5	

Muffler Specification by Style & Inlet Size

MUFFLER SPECS

Style 2 - End Inlet / End Outlet / Offset and Style 2A - Dual End Inlet / End Outlet

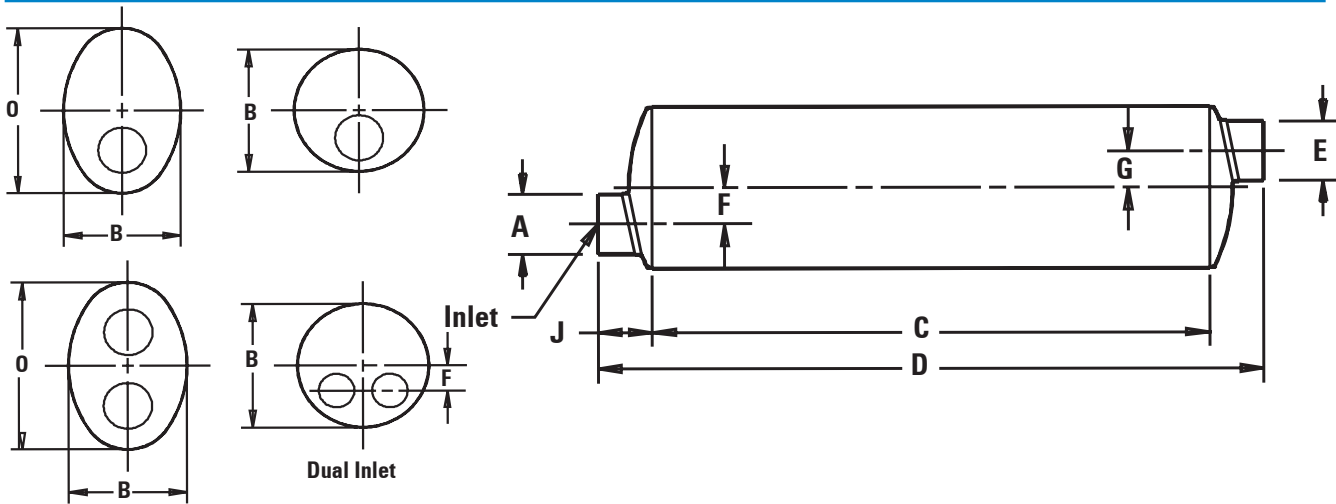

Part Number	Muffler Style	----- Body -----				Outlet I.D. (E)	---- Offset ----		----- Inlet Tube -----			Outlet Tube from End Center (K) (L)		Clock Position Inlet	Clock Position Outlet	Wgt lbs. kg
		Inlet I.D. (A)	Dia. (B) or (BxO)	Length (C)	Overall Length (D)		Inlet (F)	Outlet (G)	Loc. (H)	Length (I)	Length (J)					
M060055	2	2.00 51	6.00 152	16.90 429	21.90 556	2.00 51	1.50 38	1.50 38			2.50 64			6:00 12:00		7 3
M060232	2	2.00 51	6.00 152	24.00 610	29.00 737	2.00 51	1.50 38	1.50 38			2.50 64			6:00 12:00		9 4
M060480 ⁸	2	2.00 51	6.00 152	15.75 400	21.00 533	2.00 51	1.50 38	1.50 38			2.62 67			6:00 12:00		7.6 3.4
M065034	2	2.50 64	6.62 168	18.56 471	23.00 584	2.50 64	1.62 41	1.62 41			1.50 38			6:00 12:00		9 4
M065139 ⁸	2	2.50 64	6.62 168	17.75 451	24.00 610	2.50 64	1.62 41	1.62 41			3.12 79			6:00 12:00		9.8 4.5
M085172	2A	2.50 (2) 64 (2)	8.50 216	30.00 762	39.00 991	2.75 70	1.62 (2) 41 (2)	2.00 51			2.50 (2) 64 (2)			6:00(2) 6:00		24 11
M085189 ²	2A	2.50 (2) 64 (2)	8.50 216	31.25 794	36.25 921	3.00 76	1.62 (2) 41 (2)	2.00 51			2.50 (2) 64 (2)			6:00 (2) 12:00		23 10
M085267 ^{1,2}	2A	2.50 (2) ⁷ 64 (2) ⁷	8.75 222	30.12 765	38.97 990	3 OD 76 OD	1.62 (2) 41 (2)	2.00 51			5.72/3.22 146/82			6:00 (2) 12:00		32 15
M090563	2A	2.75 (2) 70 (2)	8.2 x 11.5 208 x 292	27.00 686	32.75 832	4.00 102	0.15/4.00 9/102	2.50 64			2.63 (2) 67 (2)			9:00-3:00 3:00		22 10
M085023	2	3.00 76	8.50 216	31.25 794	36.25 921	3.00 76	2.00 51	2.00 51			2.50 64			6:00 12:00		19 9
M085056	2	3.00 76	8.50 216	20.50 521	25.00 635	3.00 76	2.00 51	2.00 51			1.50 38			6:00 12:00		14 6
M085078	2	3.00 76	8.50 216	27.50 699	32.00 813	3.00 76	2.00 51	2.00 51			1.50 38			6:00 12:00		20 9
M085080	2	3.00 76	8.50 216	27.75 705	33.75 857	3.00 76	2.00 51	2.00 51			3.50 89			6:00 6:00		20 9
M090159 ¹	2	3.00 76	8.5 x 11.8 216 x 300	26.00 660	33.75 857	3.00 76	2.50 64	2.50 64			3.88 99			3:00 3:00		29 13
M090170	2	3.00 76	8.3 x 11.5 211 x 292	26.00 660	33.75 857	3.00 76	2.50 64	2.50 64			3.88 99			3:00 3:00		20 9
M085408 ⁸	2	3.00 76	8.50 216	19.75 502	26.50 673	3.00 76	2.00 51	2.00 51			3.38 86			6:00 12:00		15.2 7
M085008	2	3.50 89	8.50 216	38.00 965	43.00 1092	3.00 76	1.75 44	2.00 51			2.50 64			6:00 12:00		23 10
M090158	2	3.50 89	8.3 x 11.5 211 x 292	26.00 660	32.25 819	3.50 89	2.50 64	2.50 64			3.12 79			3:00 9:00		24 11
M090210 ¹	2	3.50 89	8.5 x 11.8 216 x 300	26.00 660	32.25 819	3.50 89	2.50 64	2.50 64			3.12 79			3:00 9:00		34 15

Part Number	Muffler Style	Body				Outlet I.D. (E)	Offset		Inlet Tube			Outlet Tube from End Center		Clock Position Inlet	Clock Position Outlet	Wgt lbs. kg
		Inlet I.D. (A)	Dia. (B) or (BxO)	Length (C)	Overall Length (D)		Inlet (F)	Outlet (G)	Loc. (H)	Length (I)	Length (J)	(K)	(L)			
M090520	2	3.50 89	8.2 x11.5 208 x 292	26.00 660	32.25 819	4.00 102	2.50 64	2.50 64			3.12 79			3:00	9:00	21 10
M090680	2	3.50 89	8.2 x11.5 208 x 292	30.00 762	36.25 921	4.00 102	2.50 64	2.50 64			3.12 79			3:00	9:00	25 11
M091047 ⁸	2	3.50 89	9.00 229	21.75 552	29.00 737	3.50 89	2.10 53	2.10 53			3.62 89			6:00	12:00	15.8 7.2
M090280	2	4.00 102	8.2 x11.5 208 x 292	26.00 660	32.25 819	4.00 102	2.50 64	2.50 64			3.12 79			3:00	9:00	22 10
M090534	2	4.00 102	8.2 x11.5 208 x 292	26.00 660	33.75 857	4.00 102	2.50 64	2.50 64			3.88 99			3:00	9:00	26 12
M090538	2	4.00 102	8.2 x11.5 208 x 292	26.00 660	32.25 819	3.50 89	2.50 64	2.50 64			3.12 79			3:00	12:00	26 12
M100043	2	4.00 102	10.00 254	35.38 899	41.75 1060	4.00 102	2.44 62	2.44 62			2.88 73			6:00	12:00	32 15
M100048	2	4.00 102	10.00 254	27.12 689	33.50 851	4.00 102	2.44 62	2.44 62			2.88 73			6:00	12:00	27 12
M101168 ⁸	2	4.00 102	10.00 254	23.75 603	32.00 813	4.00 102	2.44 62	2.44 62			4.12 105			6:00	12:00	19.3 8.8
M110012	2	4.00 102	11.00 279	30.00 762	36.00 914	4.00 102	2.50 64	2.50 64			3.00 76			6:00	12:00	26 12
M110189	2	4.00 102	11.00 279	36.00 914	41.25 1048	4.00 102	2.50 64	2.50 64			2.63 67			6:00	12:00	34 15
M111028	2	4 OD 102 OD	11.00 279	36.00 914	44.00 1118	5.00 127		2.50 64			5.00 127				12:00	36 16
M120100	2	4.00 102	10 x15 254 x 381	26.00 660	32.50 826	4.00 102	4.25 108	4.25 108			3.25 83			3:00	9:00	30 14
M120197 ¹	2	4.00 102	10.3 x15.3 261 x 389	36.00 914	42.00 1067	4.00 102	4.25 108	0.50 13			3.00 76			3:00	9:00	58 26
M110077	2	5.00 127	11.00 279	44.00 1118	50.00 1270	5.00 127	2.50 64	2.50 64			3.00 76			6:00	12:00	44 20
M120108	2	5.00 127	10 x15 254 x 381	26.00 660	32.50 826	5.00 127	3.12 79	3.12 79			3.25 83			3:00	9:00	34 15
M120225	2	5.00 127	10 x15 254 x 381	26.00 660	32.50 826	5.00 127	3.12 79	3.12 79			3.25 86			3:00	9:00	31 14
M120365	2	5.00 127	10 x15 254 x 381	36.00 914	42.50 1080	5.00 127	3.12 79	3.12 79			3.25 83			6:00	12:00	44 20
M120448	2	5.00 127	10 x15 254 x 381	44.00 1118	50.00 1270	5.00 127	3.59 91	3.59 91			3.00 76			3:00	9:00	50 23
M120748 ⁸	2	5.00 127	11.84 301	25.75 654	34.00 864	5.00 127	2.81 71	2.81 71			4.12 105			6:00	12:00	26.7 12
M122300	2	6.00 152	10 x15 254 x 381	31.75 806	42.50 1080	6.00 152	3.59 91	3.59 91			5.38 137			3:00	9:00	43 20
M140048	2	6.00 152	12 x18 305 x 457	30.00 762	38.00 965	6.00 152	4.50 114	4.50 114			4.00 102			3:00	9:00	50 23
M170101	2	6.00 152	14 x21 357 x 533	35.00 889	47.00 1194	6.00 152	5.25 133	5.25 133			6.00 152			3:00	9:00	89 40
M190002	2	8.00 203	16 x24 406 x 607	45.00 1143	57.00 1448	8.00 203	6.00 152	6.00 152			6.00 152			3:00	3:00	124 56

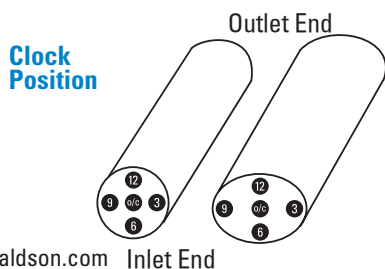
Footnotes

- 1 Wrapped muffler (reduces noise and surface temperature)
- 2 Stainless Steel
- 3 Silent Partner™ Muffler -Aluminized
- 4 Silent Partner™ Muffler -Stainless Steel
- 5 Resonator
- 6 Band clamp on inlet tube
- 7 Face flange on inlet
- 8 Made for off-road use
- 9 Made for off-road use, flows in either direction

Muffler Specification by Style & Inlet Size

Style 4 - End Inlet / Side Outlet

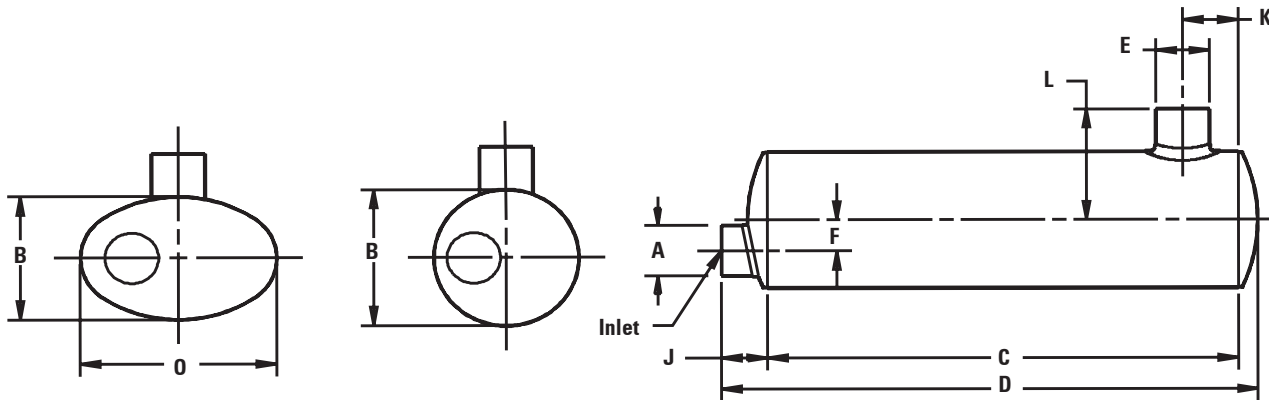

Part Number	Muffler Style	Body				Outlet I.D. (E)	Offset		Inlet Tube			Outlet Tube from End Center		Clock Position Inlet	Clock Position Outlet	Wgt lbs. kg
		Inlet I.D. (A)	Dia. (B) or (BxO)	Length (C)	Overall Length (D)		Inlet (F)	Outlet (G)	Loc. (H)	Length (I)	Length (J)	(K)	(L)			
M060481 ⁹	3/4	2.00 51	6.00 152	15.75 400	19.25 489	2.00 51			1.88 48	5.00 127				6:00		7.6 3.4
M065140 ⁹	3/4	2.50 64	6.62 168	17.75 451	22.04 560	2.50 64			2.38 60	5.75 146				6:00		10 4.5
M085206	4	3.00 76	8.50 216	26.25 667	29.50 749	3.00 76	2.00 51				3.25 83	3.50 89	6.75 171	6:00	9:00	20 9
M085409 ⁹	3/4	3.00 76	8.50 216	19.75 502	24.27 616	3.00 76			2.88 73	6.50 165				6:00		15.4 7
M090547	4	3.50 89	8.2 x 11.5 208 x 292	32.56 827	35.16 893	4.00 102	2.50 64				2.60 66	20.48 520	6.00 152	9:00	7:00	22 10
M090548	4	3.50 89	8.2 x 11.5 208 x 292	32.56 827	35.16 893	4 OD 102 OD	2.50 64				2.60 66	20.48 520	8.70 221	3:00	7:30	21 10
M091048 ⁹	3/4	3.50 89	9.00 229	21.75 552	26.38 670	3.50 89			3.38 86	7.25 184				6:00		15.9 7.2
M100052	4	4.00 102	10.00 254	27.75 705	30.75 781	4.00 102	2.44 62				3.00 76	24.25 616	8.75 222	6:00	2:00	25 11
M101169 ⁹	3/4	4.00 102	10.00 254	23.75 603	29.24 743	4.00 102			3.88 99	8.00 203				6:00		19.8 9
M110112	4	4.00 102	11.00 279	36.00 914	39.00 991	4.00 102	2.50 64				3.00 76	15.97 406	8.64 219	6:00	9:00	29 13
M110148	4	4.00 102	11.00 279	36.00 914	39.00 991	4.00 102	2.50 64				3.00 76	17.25 438	8.64 219	6:00	12:00	29 13
M120367	4	4.00 102	10 x 15 254 x 381	30.38 772	34.00 864	4.00 102	4.25 108				3.50 89	22.88 581	10.50 267	3:00	9:00	32 15
M110311	4	4.00 OD 102	11.00 279	36.00 914	41.00 1041	4.00 102	2.50 64				5.00 127	27.10 688	8.64 219	6:00	12:00	27 12
M111025	4	4 OD 102 OD	11.00 279	36.00 914	41.00 1041	4 OD 102 OD					5.00 127	19.66 499	10.50 267		6:00	27 12
M110014	4	5.00 127	11.00 279	46.00 1168	51.75 1314	5.00 127	2.50 64				4.25 108	38.50 978	8.50 216	6:00	12:00	45 20
M120366	4	5.00 127	10 x 15 254 x 381	36.00 914	39.25 997	5.00 127	3.12 79				3.12 79	28.38 721	9.50 241	3:00	9:00	48 22
M120749 ⁹	3/4	5.00 127	11.84 301	25.75 654	31.69 805	5.00 127			4.88 124	8.75 222				6:00		27.5 12.5
M060250	5	2.00 51	6.00 152	16.90 429	19.40 493	2.00 51	1.50 38	1.50 38						6:00	12:00	8 4

Style 5 - Inlet & Outlet on Same End

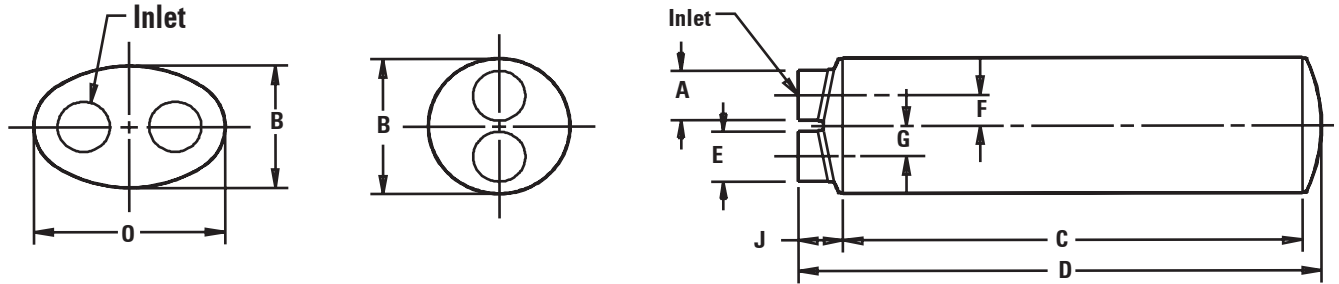

Part Number	Muffler Style	Body				Outlet I.D. (E)	Offset		Inlet Tube			Outlet Tube from End Center		Clock Position Inlet	Clock Position Outlet	Wgt lbs. kg
		Inlet I.D. (A)	Dia. (B) or (BxO)	Length (C)	Overall Length (D)		Inlet (F)	Outlet (G)	Loc. (H)	Length (I)	Length (J)	(K)	(L)			
M060482 ⁸	5	2.00 51	6.00 152	15.75 400	19.25 489	2.00 51	1.50 38	1.50 38			2.62 67					8.4 3.8
M065073	5	2.50 64	6.62 168	20.00 508	21.50 546	2.50 64	1.62 41	1.62 41			1.50 38			6:00 12:00		10 5
M065141 ⁸	5	2.50 64	6.62 168	17.75 451	22.04 560	2.50 64	1.63 41	1.63 41			3.12 79			6:00 12:00		10.6 4.8
M085207	5	3.00 76	8.50 216	22.00 559	23.50 597	3.00 76	2.00 51	2.00 51			1.50 38			6:00 12:00		16 7
M085410 ⁸	5	3.00 76	8.50 216	19.75 502	24.27 616	3.00 76	2.00 51	2.00 51			3.38 86			6:00 12:00		17 7.7
M091049 ⁸	5	3.50 89	9.00 229	21.75 552	26.44 672	3.50 89	2.10 53	2.10 53			3.62 89			6:00 12:00		17.3 7.9
M100049	5	4.00 102	10.00 254	27.75 705	30.62 778	4.00 102	2.44 62	2.44 62			2.88 73			12:00 6:00		23 10
M101170 ⁸	5	4.00 102	10.00 254	23.75 603	29.24 743	4.00 102	2.44 62	2.44 62			4.12 105			6:00 12:00		22 10
M120154	5	4.00 102	10 x15 254 x 381	26.00 660	28.38 721	4.00 102	4.25 108	4.25 108			2.25 57			3:00 9:00		31 14
M120713	5	4.00 102	10 x15 254 x 381	27.00 686	31.13 791	5.00 127	4.40 112	4.25 108			4.00 102			3:00 9:00		31 14
M120131	5	5.00 127	10 x15 254 x 381	26.00 660	29.39 747	5.00 127	3.12 79	3.12 79			3.25 83			3:00 9:00		32 15
M120176	5	5.00 127	10 x15 254 x 381	26.25 667	29.38 746	5.00 127	3.12 79	3.12 79			3.00 76			3:00 9:00		29 13
M120189	5	5.00 127	10 x15 254 x 381	33.38 848	39.50 1003	5.00 127	3.59 91	3.59 91			4.44 113			3:00 9:00		46 21
M120450	5	5.00 127	10 x15 254 x 381	44.00 1118	47.38 1203	5.00 127	3.59 91	3.59 91			3.25 83			3:00 9:00		46 21
M120750 ⁸	5	5.00 127	11.84 301	25.75 654	31.69 805	5.00 127	2.81 71	2.81 71			4.12 105			6:00 12:00		28.7 13

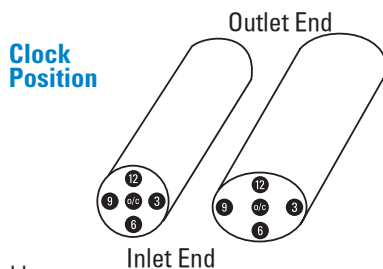

Footnotes

- 1 Wrapped muffler (reduces noise and surface temperature)
- 2 Stainless Steel
- 3 Silent Partner™ Muffler -Aluminized
- 4 Silent Partner™ Muffler -Stainless Steel
- 5 Resonator
- 6 Band clamp on inlet tube
- 7 Face flange on inlet
- 8 Made for off-road use
- 9 Made for off-road use, flows in either direction

Muffler Specification by Style & Inlet Size

MUFFLER SPECS

Style 6 - Side Inlet / Side Outlet

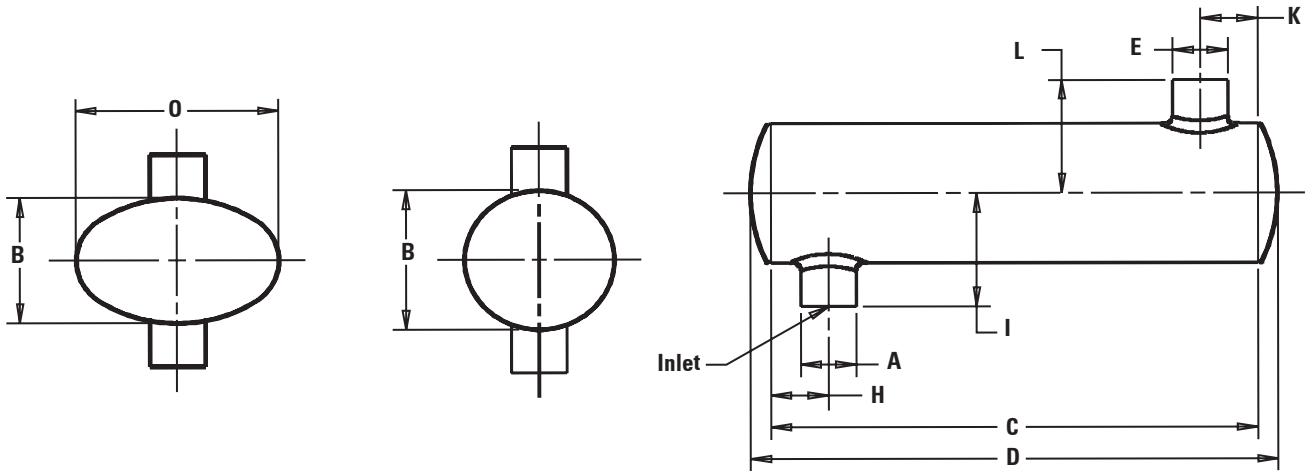

Part Number	Muffler Style	----- Body -----				Outlet I.D. (E)	---- Offset ----		----- Inlet Tube -----			Outlet Tube from End Center (L)		Clock Position Inlet Outlet		Wgt lbs. kg
		Inlet I.D. (A)	Dia. (B) or (BxO)	Length (C)	Overall Length (D)		Inlet (F)	Outlet (G)	Loc. (H)	Length (I)	Length (J)	(K)	(L)			
M060251	6	2.00 51	6.00 152	18.81 478	18.81 478	2.00 51			3.50 89	5.00 127		3.50 89	5.00 127	6:00	12:00	8 4
M060483 ⁸	6	2.00 51	6.00 152	15.50 394	17.24 438	2.00 51			1.75 44	5.00 127		1.75 44	5.00 127	6:00	12:00	7.4 3.4
M065074	6	2.50 64	6.62 168	20.81 529	20.81 529	2.50 64			3.50 89	6.00 152		3.50 89	6.00 152	6:00	12:00	10 5
M065142 ⁸	6	2.50 64	6.62 168	17.50 444	19.84 504	2.50 64			2.50 64	5.75 146		2.25 57	5.75 146	6:00	12:00	9.4 4.2
M085208	6	3.00 76	8.50 216	27.00 686	27.00 686	3.00 76			3.50 89	6.75 171		3.50 89	6.75 171	6:00	12:00	17 8
M085411 ⁸	6	3.00 76	8.50 216	19.50 495	21.78 553	3.00 76			3.00 76	6.50 165		3.00 76	6.50 165	6:00	12:00	14.2 6.4
M090598	6	3.50 89	8.3 x 11.5 211 x 292	26.00 660	26.00 660	3.50 89			3.38 86	7.00 178		3.38 86	7.00 178	6:00	12:00	20 9
M091050 ⁸	6	3.50 89	9.00 229	21.50 546	23.64 600	3.50 89			3.25 83	7.25 184		3.25 83	7.25 184	6:00	12:00	15.1 6.9
M100572	6	4.00 102	10.12 257	28.00 711	30.62 778	4.00 102			4.50 114	8.00 203		4.50 114	8.00 203	6:00	12:00	22 10
M101171 ⁸	6	4.00 102	10.00 254	23.50 597	26.24 666	4.00 102			3.75 95	8.00 203		3.75 95	8.00 203	6:00	12:00	19.1 8.7
M111026	6	4.00 102	11.00 279	36.00 914	36.00 914	4 OD 102 OD			3.75 95	8.64 219		9.23 234	9.50 241	12:00	9:00	29 13
M120418	6	5.00 127	10 x 15 254 x 381	28.00 711	28.25 718	5.00 127			5.00 127	8.00 203		5.00 127	8.00 203	6:00	12:00	27 12
M120751 ⁸	6	5.00 127	11.84 301	25.50 648	29.14 740	5.00 127			4.75 121	8.75 222		4.75 121	8.75 222	6:00	12:00	26.4 12

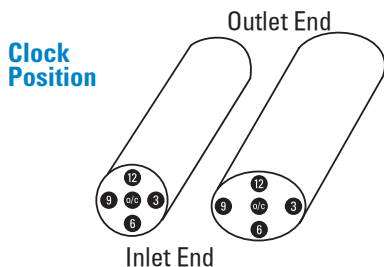

Footnotes

- 1 Wrapped muffler (reduces noise and surface temperature)
- 2 Stainless Steel
- 3 Silent Partner™ Muffler - Aluminized
- 4 Silent Partner™ Muffler - Stainless Steel
- 5 Resonator
- 6 Band clamp on inlet tube
- 7 Face flange on inlet
- 8 Made for off-road use
- 9 Made for off-road use, flows in either direction

Exhaust Configurations

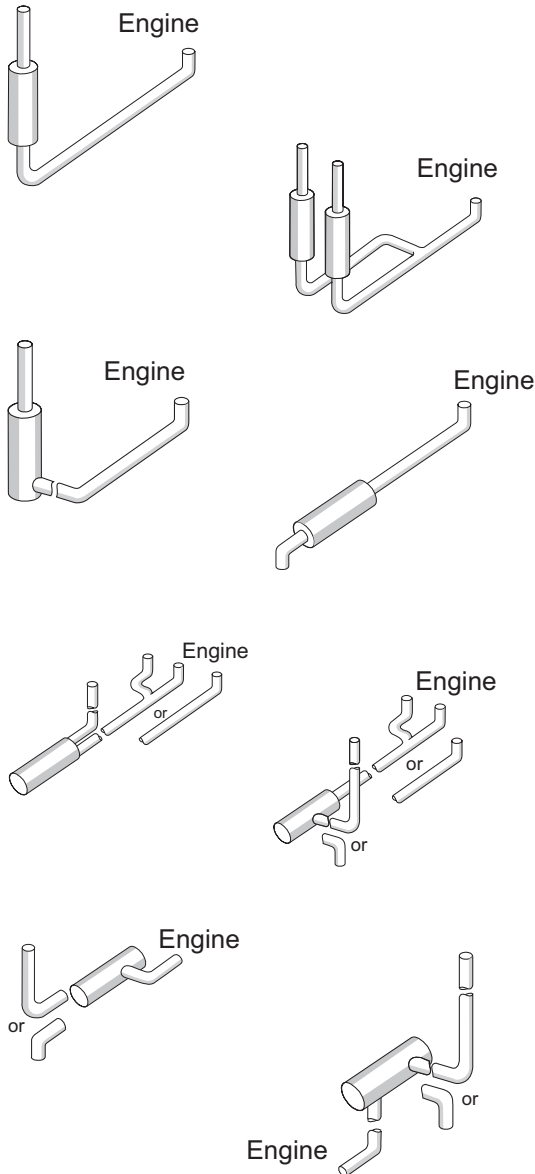

Muffler Selection Word of Caution!

Depending on your location, some diesel engines require the use of an emissions aftertreatment device to meet emissions regulations. In the United States, federal law prohibits the replacement of an emissions device (i.e., catalytic converter, combined catalytic converter/muffler, diesel particulate filter, etc.) with a non-emissions reducing (such as a straight pipe or conventional muffler) or un-approved emissions device. If operating the vehicle outside of the United States, make sure to check with and comply with any emission regulations for your locale.

Section Index

Types of Truck Exhaust Systems in this Section

This section will provide you with a series of muffler options for individual truck engines. The information is presented by engine manufacturer, exhaust system configuration, engine model and horsepower rating. Once you locate your engine, you'll be able to select from a variety of muffler sizes. In many cases, there are multiple choices for a particular application. To assist in your selection refer to the notes column.

Truck Engine Models

Caterpillar 88	Detroit Diesel 108
3116	6-71T
3176	6V-92T
3306	6V-92TA
3126B	6V-92TT
3306B	6V-92TTA
3406B	8.2T
3406E	8V-71T
C-10	8V-71TA
C-12	8V-71TT
C-15	8V-71TTA
C-16	8V-92T
	8V-92TA
Cummins 98	8V-92TT
6BT	8V-92TTA
6CT	Series 40E (7.6 LTA)
ISB	Series 40E (8.7 LTA)
ISC	Series 50 (8.7 Ltr)
ISM	Series 60 (11.1 Ltr)
ISX	Series 60 (12.7 Ltr)
L10	Series 60 (14 Ltr)
M11	
N14	
NTC	
Signature	
	International 114
	6.9L
	7.3L (T444)
	9.0L
	DT360
	DT414
	DT420
	DT466E
	DT812B
	DT817
	DT817C
	Mack 119
	E6
	E7
	E9
	ENDT673
	ENDT675
	ENDT865
	ENDT866

Truck Engine Muffler Application



Engine Make & Exhaust System Configuration	Engine Model	Engine H.P.	Muffler Dimensions inches			Muffler Dimensions mm			Backpressure inches of Hg H ₂ O		Muffler Style & Part No.	Notes
			Inlet	Body	Outlet	Inlet	Body	Outlet	Hg	H ₂ O		

Caterpillar

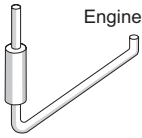

3406B	350	4.0	9.0	5.0	102	229	127	2.3	31	1	M090781	
		5.0	9.0	5.0	127	229	127	1.9	26	1	M090074	
		5.0	9.0	5.0	127	229	127	1.0	14	1	M090535	Low backpressure, off-hwy
		5.0	10.0	5.0	127	254	127	1.0	14	1	M100463	Low backpressure, off-hwy
		5.0	10.0	5.0	127	254	127	2.1	28	1	M100465	Best value, most popular
		5.0	10.0	5.0	127	254	127	2.2	30	1	M100580	OE replacement
		5.0	10.0	5.0	127	254	127	2.4	32	1	M100807	60" (1524mm) Long Body
		5.0	10.0	5.0	127	254	127	1.7	24	1	M100944	OE replacement for higher HP
		5.0	10.0	5.0	127	254	127	2.1	29	1	M101158	Silent Partner Stainless
		5.0	10.0	5.0	127	254	127	2.1	29	1	M101181	Silent Partner Aluminized
		5.0	10.0	5.0	127	254	127	2.2	30	1	M101263	Freightliner only
		5.0	11.0	5.0	127	279	127	1.7	24	1	M110849	
3406B	400	4.0	9.0	5.0	102	229	127	2.8	38	1	M090781	
		5.0	9.0	5.0	127	229	127	2.4	32	1	M090074	
		5.0	9.0	5.0	127	229	127	1.3	17	1	M090535	Low backpressure, off-hwy
		5.0	10.0	5.0	127	254	127	1.3	17	1	M100463	Low backpressure, off-hwy
		5.0	10.0	5.0	127	254	127	2.5	34	1	M100465	Best value, most popular
		5.0	10.0	5.0	127	254	127	2.7	36	1	M100580	OE replacement
		5.0	10.0	5.0	127	254	127	2.9	39	1	M100807	60" (1524mm) Long Body
		5.0	10.0	5.0	127	254	127	2.1	29	1	M100944	OE replacement for higher HP
		5.0	10.0	5.0	127	254	127	2.6	35	1	M101158	Silent Partner Stainless
		5.0	10.0	5.0	127	254	127	2.6	35	1	M101181	Silent Partner Aluminized
		5.0	10.0	5.0	127	254	127	2.7	36	1	M101263	Freightliner only
		5.0	11.0	5.0	127	279	127	2.1	28	1	M110849	
3406B	425 to 460	5.0	9.0	5.0	127	229	127	2.5	35	1	M090074	
		5.0	9.0	5.0	127	229	127	1.4	18	1	M090535	Low backpressure, off-hwy
		5.0	10.0	5.0	127	254	127	1.4	18	1	M100463	Low backpressure, off-hwy
		5.0	10.0	5.0	127	254	127	2.7	37	1	M100465	Best value, most popular
		5.0	10.0	5.0	127	254	127	2.9	39	1	M100580	OE replacement
		5.0	10.0	5.0	127	254	127	2.3	31	1	M100944	OE replacement for higher HP
		5.0	10.0	5.0	127	254	127	2.8	38	1	M101158	Silent Partner Stainless
		5.0	10.0	5.0	127	254	127	2.8	38	1	M101181	Silent Partner Aluminized
		5.0	10.0	5.0	127	254	127	2.9	39	1	M101263	Freightliner only
		5.0	11.0	5.0	127	279	127	2.3	31	1	M110849	
C-12	335 to 355	4.0	9.0	5.0	102	229	127	1.9	25	1	M090781	
		5.0	9.0	5.0	127	229	127	1.6	21	1	M090074	
		5.0	9.0	5.0	127	229	127	0.8	11	1	M090535	Low backpressure, off-hwy
		5.0	10.0	5.0	127	254	127	0.8	11	1	M100463	Low backpressure, off-hwy
		5.0	10.0	5.0	127	254	127	0.6	8	1	M100465	Best value, most popular
		5.0	10.0	5.0	127	254	127	1.8	24	1	M100580	OE replacement
		5.0	10.0	5.0	127	254	127	1.9	26	1	M100807	60" (1524mm) Long Body
		5.0	10.0	5.0	127	254	127	1.4	19	1	M100944	OE replacement for higher HP
		5.0	10.0	5.0	127	254	127	1.7	23	1	M101158	Silent Partner Stainless
		5.0	10.0	5.0	127	254	127	1.7	23	1	M101181	Silent Partner Aluminized
5.0	10.0	5.0	127	254	127	1.8	24	1	M101263	Freightliner only		
5.0	11.0	5.0	127	279	127	1.4	19	1	M110849			
C-12	380	5.0	9.0	5.0	127	229	127	1.6	22	1	M090074	
		5.0	9.0	5.0	127	229	127	0.9	12	1	M090535	Low backpressure, off-hwy
		4.0	9.0	5.0	102	229	127	1.9	26	1	M090781	
		5.0	10.0	5.0	127	254	127	0.9	12	1	M100463	Low backpressure, off-hwy
		5.0	10.0	5.0	127	254	127	0.6	8	1	M100465	Best value, most popular
		5.0	10.0	5.0	127	254	127	1.8	25	1	M100580	OE replacement
		5.0	10.0	5.0	127	254	127	2.0	27	1	M100807	60" (1524mm) Long Body
		5.0	10.0	5.0	127	254	127	1.5	20	1	M100944	OE replacement for higher HP
		5.0	10.0	5.0	127	254	127	1.8	24	1	M101158	Silent Partner Stainless
		5.0	10.0	5.0	127	254	127	1.8	24	1	M101181	Silent Partner Aluminized
		5.0	10.0	5.0	127	254	127	1.8	25	1	M101263	Freightliner only
		5.0	11.0	5.0	127	279	127	1.5	20	1	M110849	
C-12	395 to 430	4.0	9.0	5.0	102	229	127	2.1	28	1	M090781	
		5.0	9.0	5.0	127	229	127	1.8	24	1	M090074	
		5.0	9.0	5.0	127	229	127	0.9	13	1	M090535	Low backpressure, off-hwy
		5.0	10.0	5.0	127	254	127	0.9	13	1	M100463	Low backpressure, off-hwy
		5.0	10.0	5.0	127	254	127	0.6	9	1	M100465	Best value, most popular
		5.0	10.0	5.0	127	254	127	2.0	27	1	M100580	OE replacement
		5.0	10.0	5.0	127	254	127	2.1	29	1	M100807	60" (1524mm) Long Body
		5.0	10.0	5.0	127	254	127	1.6	21	1	M100944	OE replacement for higher HP
		5.0	10.0	5.0	127	254	127	1.9	26	1	M101158	Silent Partner Stainless
		5.0	10.0	5.0	127	254	127	1.9	26	1	M101181	Silent Partner Aluminized
		5.0	10.0	5.0	127	254	127	2.0	27	1	M101263	Freightliner only
		5.0	11.0	5.0	127	279	127	1.6	21	1	M110849	

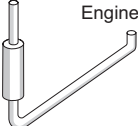
Engine Make & Exhaust System Configuration	Engine Model	Engine H.P.	Muffler Dimensions						Backpressure		Muffler Style & Part No.	Notes		
			inches			mm			inches of Hg	H ₂ O				
			Inlet	Body	Outlet	Inlet	Body	Outlet						
	C-15	355	4.0	9.0	5.0	102	229	127	2.3	32	1	M090781		
			5.0	9.0	5.0	127	229	127	2.0	27	1	M090074		
			5.0	9.0	5.0	127	229	127	1.1	14	1	M090535	Low backpressure, off-hwy	
			5.0	10.0	5.0	127	254	127	1.1	14	1	M100463	Low backpressure, off-hwy	
			5.0	10.0	5.0	127	254	127	0.7	9	1	M100465	Best value, most popular	
			5.0	10.0	5.0	127	254	127	2.2	30	1	M100580	OE replacement	
			5.0	10.0	5.0	127	254	127	2.4	33	1	M100807	60" (1524mm) Long Body	
			5.0	10.0	5.0	127	254	127	1.8	24	1	M100944	OE replacement for higher HP	
			5.0	10.0	5.0	127	254	127	2.1	29	1	M101158	Silent Partner Stainless	
			5.0	10.0	5.0	127	254	127	2.1	29	1	M101181	Silent Partner Aluminized	
			5.0	10.0	5.0	127	254	127	2.2	30	1	M101263	Freightliner only	
			5.0	11.0	5.0	127	279	127	1.8	24	1	M110849		
			C-15	375 to 435	5.0	9.0	5.0	127	229	127	1.4	20	1	M090535
5.0	10.0	5.0			127	254	127	1.4	20	1	M100463	Low backpressure, off-hwy		
5.0	10.0	5.0			127	254	127	0.9	13	1	M100465	Best value, most popular		
5.0	10.0	5.0			127	254	127	2.9	40	1	M100580	OE replacement		
5.0	10.0	5.0			127	254	127	2.4	33	1	M100944	OE replacement for higher HP		
5.0	10.0	5.0			127	254	127	2.9	40	1	M101158	Silent Partner Stainless		
5.0	10.0	5.0			127	254	127	2.9	40	1	M101181	Silent Partner Aluminized		
5.0	10.0	5.0			127	254	127	2.9	40	1	M101263	Freightliner only		
5.0	11.0	5.0			127	279	127	2.4	33	1	M110849			
C-15	455 to 500	5.0	9.0	5.0	127	229	127	1.7	23	1	M090535	Low backpressure, off-hwy		
		5.0	10.0	5.0	127	254	127	1.7	23	1	M100463	Low backpressure, off-hwy		
		5.0	10.0	5.0	127	254	127	2.8	38	1	M100944	OE replacement for higher HP		
		5.0	11.0	5.0	127	279	127	2.8	38	1	M110849			
C-16	575	5.0	9.0	5.0	127	229	127	1.8	24	1	M090535	Low backpressure, off-hwy		
		5.0	10.0	5.0	127	254	127	1.8	24	1	M100463	Low backpressure, off-hwy		
		5.0	10.0	5.0	127	254	127	2.9	40	1	M100944	OE replacement for higher HP		
		5.0	11.0	5.0	127	279	127	2.9	40	1	M110849			
C-16	600	5.0	9.0	5.0	127	229	127	1.8	25	1	M090535	Low backpressure, off-hwy		
		5.0	10.0	5.0	127	254	127	1.8	25	1	M100463	Low backpressure, off-hwy		
3406E	355 to 435	4.0	9.0	5.0	102	229	127	3.0	40	1	M090781			
		5.0	9.0	5.0	127	229	127	2.5	34	1	M090074			
		5.0	9.0	5.0	127	229	127	1.3	18	1	M090535	Low backpressure, off-hwy		
		5.0	10.0	5.0	127	254	127	1.3	18	1	M100463	Low backpressure, off-hwy		
		5.0	10.0	5.0	127	254	127	0.9	12	1	M100465	Best value, most popular		
		5.0	10.0	5.0	127	254	127	2.8	38	1	M100580	OE replacement		
		5.0	10.0	5.0	127	254	127	2.2	30	1	M100944	OE replacement for higher HP		
		5.0	10.0	5.0	127	254	127	2.7	37	1	M101158	Silent Partner Stainless		
		5.0	10.0	5.0	127	254	127	2.7	37	1	M101181	Silent Partner Aluminized		
		5.0	10.0	5.0	127	254	127	2.8	38	1	M101263	Freightliner only		
		5.0	11.0	5.0	127	279	127	2.2	30	1	M110849			
		3406E	455 to 500	5.0	9.0	5.0	127	229	127	1.7	23	1	M090535	Low backpressure, off-hwy
				5.0	10.0	5.0	127	254	127	1.7	23	1	M100463	Low backpressure, off-hwy
5.0	10.0			5.0	127	254	127	2.8	38	1	M100944	OE replacement for higher HP		
5.0	11.0			5.0	127	279	127	2.8	38	1	M110849			
3406E	575	5.0	9.0	5.0	127	229	127	1.8	25	1	M090535	Low backpressure, off-hwy		
		5.0	10.0	5.0	127	254	127	1.8	25	1	M100463	Low backpressure, off-hwy		
3406E	600	5.0	9.0	5.0	127	229	127	1.8	25	1	M090535	Low backpressure, off-hwy		
		5.0	10.0	5.0	127	254	127	1.8	25	1	M100463	Low backpressure, off-hwy		
3406B	350 to 400	4.0	9.0	4.0	102	229	102	1.2	16	1	M090544			
		4.0	10.0	4.0	102	254	102	1.2	17	1	M100466			
		4.0	10.0	5.0	102	254	127	2.0	27	1	M100695			
		4.0	10.3	4.0	102	262	102	2.3	31	1	M100464	Wrapped muffler		
		5.0	10.0	5.0	127	254	127	1.5	20	1	M100582	OE replacement		
		5.0	10.0	5.0	127	254	127	1.5	20	1	M101159	Silent Partner Stainless		
		5.0	10.0	5.0	127	254	127	1.5	20	1	M101182	Silent Partner Aluminized		
3406B	425 to 460	4.0	9.0	4.0	102	229	102	1.3	18	1	M090544			
		4.0	10.0	4.0	102	254	102	1.4	19	1	M100466			
		4.0	10.0	5.0	102	254	127	2.2	30	1	M100695			
		4.0	10.3	4.0	102	262	102	2.6	35	1	M100464	Wrapped muffler		
		5.0	10.0	5.0	127	254	127	1.7	23	1	M100582	OE replacement		
		5.0	10.0	5.0	127	254	127	1.7	23	1	M101159	Silent Partner Stainless		
C-12	335 to 355	4.0	9.0	4.0	102	229	102	0.8	10	1	M090544			
		4.0	10.0	4.0	102	254	102	0.8	11	1	M100466			
		4.0	10.0	5.0	102	254	127	1.3	18	1	M100695			

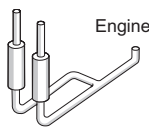

Truck Engine Muffler Application

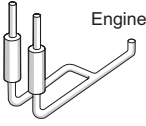

Engine Make & Exhaust System Configuration	Engine Model	Engine H.P.	Muffler Dimensions						Backpressure		Muffler Style & Part No.	Notes	
			inches			mm			inches of Hg	H ₂ O			
			Inlet	Body	Outlet	Inlet	Body	Outlet					
 C-12	380 to 430		4.0	10.3	4.0	102	262	102	1.5	21	1	M100464	Wrapped muffler
			5.0	10.0	5.0	127	254	127	1.0	14	1	M100582	OE replacement
			5.0	10.0	5.0	127	254	127	1.0	14	1	M101159	Silent Partner Stainless
			5.0	10.0	5.0	127	254	127	1.0	14	1	M101182	Silent Partner Aluminized
		4.0	9.0	4.0	102	229	102	0.9	12	1	M090544		
		4.0	10.0	4.0	102	254	102	0.9	12	1	M100466		
		4.0	10.0	5.0	102	254	127	1.5	20	1	M100695		
		4.0	10.3	4.0	102	262	102	1.7	23	1	M100464	Wrapped muffler	
		5.0	10.0	5.0	127	254	127	1.1	15	1	M100582	OE replacement	
		5.0	10.0	5.0	127	254	127	1.1	15	1	M101159	Silent Partner Stainless	
		5.0	10.0	5.0	127	254	127	1.1	15	1	M101182	Silent Partner Aluminized	
	C-15	355		4.0	9.0	4.0	102	229	102	1.0	13	1	M090544
			4.0	10.0	4.0	102	254	102	1.0	14	1	M100466	
			4.0	10.0	5.0	102	254	127	1.6	22	1	M100695	
			4.0	10.3	4.0	102	262	102	1.9	26	1	M100464	Wrapped muffler
			5.0	10.0	5.0	127	254	127	1.3	17	1	M100582	OE replacement
			5.0	10.0	5.0	127	254	127	1.3	17	1	M101159	Silent Partner Stainless
			5.0	10.0	5.0	127	254	127	1.3	17	1	M101182	Silent Partner Aluminized
C-15	375 to 435		4.0	9.0	4.0	102	229	102	1.3	18	1	M090544	
			4.0	10.0	4.0	102	254	102	1.4	19	1	M100466	
			4.0	10.0	5.0	102	254	127	2.2	30	1	M100695	
			5.0	10.0	5.0	127	254	127	1.7	23	1	M100582	OE replacement
			5.0	10.0	5.0	127	254	127	1.7	23	1	M101159	Silent Partner Stainless
			5.0	10.0	5.0	127	254	127	1.7	23	1	M101182	Silent Partner Aluminized
C-15	455 to 500		4.0	9.0	4.0	102	229	102	1.5	21	1	M090544	
			4.0	10.0	4.0	102	254	102	1.6	22	1	M100466	
			4.0	10.0	5.0	102	254	127	2.6	35	1	M100695	
			5.0	10.0	5.0	127	254	127	2.0	27	1	M100582	OE replacement
			5.0	10.0	5.0	127	254	127	2.0	27	1	M101159	Silent Partner Stainless
			5.0	10.0	5.0	127	254	127	2.0	27	1	M101182	Silent Partner Aluminized
C-16	575 to 600		4.0	9.0	4.0	102	229	102	1.7	23	1	M090544	
			4.0	10.0	4.0	102	254	102	1.8	24	1	M100466	
			4.0	10.0	5.0	102	254	127	2.8	38	1	M100695	
			5.0	10.0	5.0	127	254	127	2.2	29	1	M100582	OE replacement
			5.0	10.0	5.0	127	254	127	2.2	29	1	M101159	Silent Partner Stainless
			5.0	10.0	5.0	127	254	127	2.2	29	1	M101182	Silent Partner Aluminized
3406E	355 to 435		4.0	9.0	4.0	102	229	102	1.4	19	1	M090544	
			4.0	10.0	4.0	102	254	102	1.4	20	1	M100466	
			4.0	10.0	5.0	102	254	127	2.3	31	1	M100695	
			5.0	10.0	5.0	127	254	127	1.8	24	1	M100582	OE replacement
			5.0	10.0	5.0	127	254	127	1.8	24	1	M101159	Silent Partner Stainless
			5.0	10.0	5.0	127	254	127	1.8	24	1	M101182	Silent Partner Aluminized
3406E	455 to 475		4.0	9.0	4.0	102	229	102	1.5	20	1	M090544	
			4.0	10.0	4.0	102	254	102	1.6	21	1	M100466	
			4.0	10.0	5.0	102	254	127	2.5	34	1	M100695	
			5.0	10.0	5.0	127	254	127	1.9	26	1	M100582	OE replacement
			5.0	10.0	5.0	127	254	127	1.9	26	1	M101159	Silent Partner Stainless
			5.0	10.0	5.0	127	254	127	1.9	26	1	M101182	Silent Partner Aluminized
3406E	500 to 600		4.0	9.0	4.0	102	229	102	1.7	23	1	M090544	
			4.0	10.0	4.0	102	254	102	1.8	24	1	M100466	
			4.0	10.0	5.0	102	254	127	2.8	38	1	M100695	
			5.0	10.0	5.0	127	254	127	2.2	29	1	M100582	OE replacement
			5.0	10.0	5.0	127	254	127	2.2	29	1	M101159	Silent Partner Stainless
			5.0	10.0	5.0	127	254	127	2.2	29	1	M101182	Silent Partner Aluminized
3116	170 to 185		4.0	9.0	5.0	102	229	127	1.1	15	3	M090823	
			4.0	10.0	5.0	102	254	127	2.4	33	3	M100567	
			4.0	11.8	5.0	102	300	127	1.2	16	3	M120598	
			5.0	10.0	5.0	127	254	127	1.1	14	3	M100213	
3116	200 to 275		4.0	9.0	5.0	102	229	127	1.6	22	3	M090823	
			4.0	11.8	5.0	102	300	127	1.7	23	3	M120598	
			5.0	10.0	5.0	127	254	127	1.5	21	3	M100213	
3116	300		4.0	9.0	5.0	102	229	127	2.4	33	3	M090823	
			4.0	11.8	5.0	102	300	127	2.6	35	3	M120598	
			5.0	10.0	5.0	127	254	127	2.3	31	3	M100213	
3176	365		4.0	9.0	5.0	102	229	127	2.0	28	3	M090823	
			4.0	11.8	5.0	102	300	127	2.2	29	3	M120598	
			5.0	10.0	5.0	127	254	127	1.9	26	3	M100213	
3176	275 to 300		4.0	9.0	5.0	102	229	127	1.6	21	3	M090823	

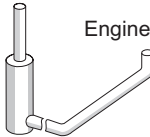

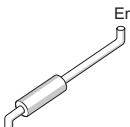
Engine Make & Exhaust System Configuration	Engine Model	Engine H.P.	Muffler Dimensions						Backpressure		Muffler Style & Part No.	Notes	
			inches			mm			inches of Hg	H ₂ O			
			Inlet	Body	Outlet	Inlet	Body	Outlet					
3176	350	350	4.0	11.8	5.0	102	300	127	1.6	22	3	M120598	
			5.0	10.0	5.0	127	254	127	1.5	20	3	M100213	
3306	300	300	4.0	9.0	5.0	102	229	127	2.0	27	3	M090823	
			4.0	11.8	5.0	102	300	127	2.1	28	3	M120598	
3306B	245	245	5.0	10.0	5.0	127	254	127	1.8	25	3	M100213	
			4.0	9.0	5.0	102	229	127	1.5	20	3	M090823	
3306B	285 to 300	285 to 300	4.0	11.8	5.0	102	300	127	1.5	21	3	M120598	
			5.0	10.0	5.0	127	254	127	1.4	18	3	M100213	
3406B	Multi-Torque 300 to 310	300 to 310	4.0	9.0	5.0	102	229	127	2.0	27	3	M090823	
			4.0	11.8	5.0	102	300	127	2.1	28	3	M120598	
3406B	330	330	5.0	10.0	5.0	127	254	127	1.8	25	3	M100213	
			4.0	9.0	5.0	102	229	127	2.8	38	3	M090823	
3126B	175 to 230	175 to 230	4.0	11.8	5.0	102	300	127	2.9	40	3	M120598	
			5.0	10.0	5.0	127	254	127	2.6	35	3	M100213	
3126B	250	250	4.0	9.0	5.0	102	229	127	1.3	18	3	M090823	
			4.0	11.8	5.0	102	300	127	1.4	19	3	M120598	
3126B	275 to 300	275 to 300	5.0	10.0	5.0	127	254	127	1.2	17	3	M100213	
			4.0	9.0	5.0	102	229	127	1.6	22	3	M090823	
3126B	330	330	4.0	11.8	5.0	102	300	127	1.7	23	3	M120598	
			5.0	10.0	5.0	127	254	127	1.5	20	3	M100213	
C-10	305 to 370	305 to 370	4.0	9.0	5.0	102	229	127	1.7	23	3	M090823	
			4.0	11.8	5.0	102	300	127	1.8	25	3	M120598	
C-12	335 to 355	335 to 355	5.0	10.0	5.0	127	254	127	1.6	22	3	M100213	
			4.0	9.0	5.0	102	229	127	2.3	31	3	M090823	
C-12	380 to 430	380 to 430	4.0	11.8	5.0	102	300	127	2.4	32	3	M120598	
			5.0	10.0	5.0	127	254	127	2.1	29	3	M100213	
C-15	355	355	4.0	9.0	5.0	102	229	127	2.5	33	3	M090823	
			4.0	11.8	5.0	102	300	127	2.6	35	3	M120598	
3116	170-185	170-185	5.0	10.0	5.0	127	254	127	2.3	31	3	M100213	
			4.0	9.0	5.0	102	229	127	2.6	36	3	M090823	
3116	200-275	200-275	4.0	11.8	5.0	102	300	127	2.8	38	3	M120598	
			5.0	10.0	5.0	127	254	127	2.5	34	3	M100213	
	3116	170-185	4.0	9.0	5.0	102	229	127	3.0	40	3	M090823	
			5.0	10.0	5.0	127	254	127	2.9	39	3	M100213	
			3.0	11.0	4.0	76	279	102	1.3	17	1	M111029	OE replacement
			3.5	8x11.5	4.0	89	203x292	102	2.0	27	2	M090680	OE replacement
			4.0	10.0	4.0	102	254	102	2.0	28	2	M100048	Aftermarket
			4.0	11.0	4.0	102	279	102	2.0	27	2	M110012	
			4.0	11.0	4.0	102	279	102	1.8	24	2	M110189	OE replacement
			4.0	11.0	5.0	102	279	127	1.1	15	2	M111028	Inlet dimension is OD
			4.0	10x15	4.0	102	254x381	102	1.5	20	2	M120100	Aftermarket, shorter than OE
			4.0	8.3x11.5	4.0	102	211x292	102	2.0	27	2	M090280	Aftermarket, shorter than OE
			4.0	8.3x11.5	4.0	102	211x292	102	1.9	26	2	M090534	Aftermarket, shorter than OE
			5.0	10x15	5.0	127	254x381	127	1.1	15	2	M120108	For off-hwy, shorter than OE
			5.0	10x15	5.0	127	254x381	127	0.8	10	2	M120225	For off-hwy, shorter than OE
			5.0	10x15	5.0	127	254x381	127	1.2	16	2	M120365	Aftermarket
			5.0	10x15	5.0	127	254x381	127	1.2	17	2	M120448	OE replacement
			3116	200-275	200-275	3.0	11.0	4.0	76	279	102	1.8	25
3.5	8x11.5	4.0				89	203x292	102	2.9	39	2	M090680	OE replacement
4.0	10.0	4.0				102	254	102	2.9	40	2	M100048	Aftermarket
4.0	11.0	4.0				102	279	102	2.9	39	2	M110012	
4.0	11.0	4.0				102	279	102	2.6	35	2	M111028	Inlet dimension is OD
4.0	11.0	4.0				102	279	102	2.6	35	2	M110189	OE replacement
4.0	10x15	4.0				102	254x381	102	2.2	30	2	M120100	Aftermarket, shorter than OE
4.0	8.3x11.5	4.0				102	211x292	102	2.9	39	2	M090280	Aftermarket, shorter than OE
4.0	8.3x11.5	4.0				102	211x292	102	2.7	37	2	M090534	Aftermarket, shorter than OE

Truck Engine Muffler Application

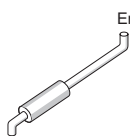

Engine Make & Exhaust System Configuration	Engine Model	Engine H.P.	Muffler Dimensions						Backpressure		Muffler Style & Part No.	Notes	
			inches			mm			inches of Hg	H ₂ O			
			Inlet	Body	Outlet	Inlet	Body	Outlet					
	3116	300	5.0	10x15	5.0	127	254x381	127	1.6	22	2	M120108	For off-hwy, shorter than OE
			5.0	10x15	5.0	127	254x381	127	1.1	15	2	M120225	For off-hwy, shorter than OE
			5.0	10x15	5.0	127	254x381	127	1.7	23	2	M120365	Aftermarket
			5.0	10x15	5.0	127	254x381	127	1.8	24	2	M120448	OE replacement
			3.0	11.0	4.0	76	279	102	2.7	37	1	M111029	OE replacement
			4.0	11.0	5.0	102	279	127	2.3	31	2	M111028	Inlet dimension is OD
			5.0	10x15	5.0	127	254x381	127	2.4	33	2	M120108	For off-hwy, shorter than OE
3176	275 to 300	5.0	10x15	5.0	127	254x381	127	1.6	22	2	M120225	For off-hwy, shorter than OE	
		5.0	10x15	5.0	127	254x381	127	2.6	35	2	M120365	Aftermarket	
		5.0	10x15	5.0	127	254x381	127	2.6	36	2	M120448	OE replacement	
		4.0	10.0	4.0	102	254	102	2.7	37	2	M100048	Aftermarket	
		4.0	11.0	4.0	102	279	102	2.6	36	2	M110012		
		4.0	11.0	4.0	102	279	102	2.4	32	2	M110189	OE replacement	
		4.0	11.0	5.0	102	279	127	1.4	19	2	M111028	Inlet dimension is OD	
		4.0	10x15	4.0	102	254x381	102	2.0	27	2	M120100	Aftermarket, shorter than OE	
		4.0	8.3x11.5	4.0	102	211x292	102	2.7	36	2	M090280	Aftermarket, shorter than OE	
		4.0	8.3x11.5	4.0	102	211x292	102	2.5	34	2	M090534	Aftermarket, shorter than OE	
		5.0	10x15	5.0	127	254x381	127	1.5	20	2	M120108	For off-hwy, shorter than OE	
3176	350 to 365	5.0	10x15	5.0	127	254x381	127	1.0	13	2	M120225	For off-hwy, shorter than OE	
		5.0	10x15	5.0	127	254x381	127	1.5	21	2	M120365	Aftermarket	
		5.0	10x15	5.0	127	254x381	127	1.6	22	2	M120448	OE replacement	
		4.0	10x15	4.0	102	254x381	102	2.6	36	2	M120100	Aftermarket, shorter than OE	
		4.0	11.0	5.0	102	279	127	1.8	25	2	M111028	Inlet dimension is OD	
		5.0	10x15	5.0	127	254x381	127	1.9	26	2	M120108	For off-hwy, shorter than OE	
		5.0	10x15	5.0	127	254x381	127	1.3	17	2	M120225	For off-hwy, shorter than OE	
		5.0	10x15	5.0	127	254x381	127	2.0	28	2	M120365	Aftermarket	
		5.0	10x15	5.0	127	254x381	127	2.1	29	2	M120448	OE replacement	
3306	300	6.0	10x15	6.0	152	254x381	152	1.1	14	2	M122300	For off-hwy, shorter than OE	
		3.0	11.0	4.0	76	279	102	2.2	30	1	M111029	OE replacement	
		4.0	11.0	5.0	102	279	127	1.8	25	2	M111028	Inlet dimension is OD	
		4.0	10x15	4.0	102	254x381	102	2.6	36	2	M120100	Aftermarket, shorter than OE	
		5.0	10x15	5.0	127	254x381	127	1.9	26	2	M120108	For off-hwy, shorter than OE	
		5.0	10x15	5.0	127	254x381	127	1.3	17	2	M120225	For off-hwy, shorter than OE	
		5.0	10x15	5.0	127	254x381	127	2.1	28	2	M120365	Aftermarket	
		5.0	10x15	5.0	127	254x381	127	2.1	29	2	M120448	OE replacement	
3306B	245	4.0	10x15	4.0	102	254x381	102	2.5	35	2	M100048	Aftermarket	
		4.0	11.0	4.0	102	279	102	2.5	34	2	M110012		
		4.0	11.0	4.0	102	279	102	2.2	30	2	M110189	OE replacement	
		4.0	11.0	5.0	102	279	127	1.3	18	2	M111028	Inlet dimension is OD	
		4.0	10x15	4.0	102	254x381	102	1.9	25	2	M120100	Aftermarket, shorter than OE	
		4.0	8.3x11.5	4.0	102	211x292	102	2.5	34	2	M090280	Aftermarket, shorter than OE	
		4.0	8.3x11.5	4.0	102	211x292	102	2.3	32	2	M090534	Aftermarket, shorter than OE	
		5.0	10x15	5.0	127	254x381	127	1.4	19	2	M120108	For off-hwy, shorter than OE	
		5.0	10x15	5.0	127	254x381	127	0.9	12	2	M120225	For off-hwy, shorter than OE	
		5.0	10x15	5.0	127	254x381	127	1.4	20	2	M120365	Aftermarket	
		5.0	10x15	5.0	127	254x381	127	1.5	20	2	M120448	OE replacement	
3306B	285 to 300	4.0	11.0	5.0	102	279	127	1.8	24	2	M111028	Inlet dimension is OD	
		4.0	10x15	4.0	102	254x381	102	2.5	34	2	M120100	Aftermarket, shorter than OE	
		5.0	10x15	5.0	127	254x381	127	1.8	25	2	M120108	For off-hwy, shorter than OE	
		5.0	10x15	5.0	127	254x381	127	1.2	16	2	M120225	For off-hwy, shorter than OE	
		5.0	10x15	5.0	127	254x381	127	2.0	27	2	M120365	Aftermarket	
3406B	Multi-Torque 300-310	5.0	10x15	5.0	127	254x381	127	2.0	28	2	M120448	OE replacement	
		4.0	11.0	5.0	102	279	127	2.1	29	2	M111028	Inlet dimension is OD	
		5.0	10x15	5.0	127	254x381	127	2.2	30	2	M120108	For off-hwy, shorter than OE	
		5.0	10x15	5.0	127	254x381	127	1.5	20	2	M120225	For off-hwy, shorter than OE	
		5.0	10x15	5.0	127	254x381	127	2.4	32	2	M120365	Aftermarket	
3406B	330	5.0	10x15	5.0	127	254x381	127	2.4	33	2	M120448	OE replacement	
		3.0	11.0	4.0	76	279	102	3.0	40	1	M111029	OE replacement	
		4.0	11.0	5.0	102	279	127	2.5	34	2	M111028	Inlet dimension is OD	
		5.0	10x15	5.0	127	254x381	127	2.6	36	2	M120108	For off-hwy, shorter than OE	
		5.0	10x15	5.0	127	254x381	127	1.7	23	2	M120225	For off-hwy, shorter than OE	
		5.0	10x15	5.0	127	254x381	127	2.8	38	2	M120365	Aftermarket	
3406B	350	5.0	10x15	5.0	127	254x381	127	2.9	39	2	M120448	OE replacement	
		4.0	11.0	5.0	102	279	127	2.7	37	2	M111028	Inlet dimension is OD	
			5.0	10x15	5.0	127	254x381	127	1.9	26	2	M120225	For off-hwy, shorter than OE

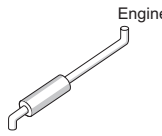
Engine Make & Exhaust System Configuration	Engine Model	Engine H.P.	Muffler Dimensions						Backpressure		Muffler Style & Part No.	Notes	
			inches			mm			inches of Hg	H ₂ O			
			Inlet	Body	Outlet	Inlet	Body	Outlet					
	3406B	400 to 460	5.0	10x15	5.0	127	254x381	127	2.5	34	2	M120225	For off-hwy, shorter than OE
	3126B	175	3.0	11.0	4.0	76	279	102	1.2	17	1	M111029	OE replacement
			4.0	8.3x11.5	4.0	102	211x292	102	2.0	27	2	M090280	Aftermarket, shorter than OE
			4.0	8.3x11.5	4.0	102	211x292	102	1.9	26	2	M090534	Aftermarket, shorter than OE
			4.0	10.0	4.0	102	254	102	2.1	28	2	M100048	Aftermarket
			4.0	11.0	4.0	102	279	102	2.0	27	2	M110012	
			4.0	11.0	4.0	102	279	102	1.8	25	2	M110189	OE replacement
			4.0	11.0	5.0	102	279	127	1.0	14	2	M111028	Inlet dimension is OD
			4.0	10x15	4.0	102	254x381	102	1.5	20	2	M120100	Aftermarket, shorter than OE
			5.0	10x15	5.0	127	254x381	127	1.1	15	2	M120108	For off-hwy, shorter than OE
			5.0	10x15	5.0	127	254x381	127	1.2	16	2	M120365	Aftermarket
	5.0	10x15	5.0	127	254x381	127	1.2	17	2	M120448	OE replacement		
	3126B	190	3.0	11.0	4.0	76	279	102	1.5	21	1	M111029	OE replacement
			4.0	10.0	4.0	102	254	102	2.5	34	2	M100048	Aftermarket
			4.0	11.0	4.0	102	279	102	2.4	33	2	M110012	
4.0			11.0	4.0	102	279	102	2.2	30	2	M110189	OE replacement	
4.0			10x15	4.0	102	254x381	102	1.8	25	2	M120100	Aftermarket, shorter than OE	
4.0			8.3x11.5	4.0	102	211x292	102	2.5	34	2	M090280	Aftermarket, shorter than OE	
4.0			8.3x11.5	4.0	102	211x292	102	2.3	31	2	M090534	Aftermarket, shorter than OE	
4.0			11.0	5.0	102	279	127	1.3	17	2	M111028	Inlet dimension is OD	
5.0			10x15	5.0	127	254x381	127	1.4	18	2	M120108	For off-hwy, shorter than OE	
5.0			10x15	5.0	127	254x381	127	1.4	19	2	M120365	Aftermarket	
5.0	10x15	5.0	127	254x381	127	1.5	20	2	M120448	OE replacement			
3126B	210 to 230	3.0	11.0	4.0	76	279	102	1.4	19	1	M111029	OE replacement	
		4.0	10.0	4.0	102	254	102	2.3	31	2	M100048	Aftermarket	
		4.0	11.0	4.0	102	279	102	2.2	30	2	M110012		
		4.0	11.0	4.0	102	279	102	2.0	27	2	M110189	OE replacement	
		4.0	11.0	5.0	102	279	127	1.2	16	2	M111028	Inlet dimension is OD	
		4.0	10x15	4.0	102	254x381	102	1.7	23	2	M120100	Aftermarket, shorter than OE	
		4.0	8.3x11.5	4.0	102	211x292	102	2.2	30	2	M090280	Aftermarket, shorter than OE	
		4.0	8.3x11.5	4.0	102	211x292	102	2.1	29	2	M090534	Aftermarket, shorter than OE	
		5.0	10x15	5.0	127	254x381	127	1.2	17	2	M120108	For off-hwy, shorter than OE	
		5.0	10x15	5.0	127	254x381	127	1.3	18	2	M120365	Aftermarket	
5.0	10x15	5.0	127	254x381	127	1.3	18	2	M120448	OE replacement			
3126B	250	3.0	11.0	4.0	76	279	102	1.7	23	1	M111029	OE replacement	
		4.0	10.0	4.0	102	254	102	2.8	38	2	M100048	Aftermarket	
		4.0	11.0	4.0	102	279	102	2.7	37	2	M110012		
		4.0	11.0	4.0	102	279	102	2.4	33	2	M110189	OE replacement	
		4.0	11.0	5.0	102	279	127	1.4	19	2	M111028	Inlet dimension is OD	
		4.0	10x15	4.0	102	254x381	102	2.0	27	2	M120100	Aftermarket, shorter than OE	
		4.0	8.3x11.5	4.0	102	211x292	102	2.7	37	2	M090280	Aftermarket, shorter than OE	
		4.0	8.3x11.5	4.0	102	211x292	102	2.6	35	2	M090534	Aftermarket, shorter than OE	
		5.0	10x15	5.0	127	254x381	127	1.5	20	2	M120108	For off-hwy, shorter than OE	
		5.0	10x15	5.0	127	254x381	127	1.6	21	2	M120365	Aftermarket	
5.0	10x15	5.0	127	254x381	127	1.6	22	2	M120448	OE replacement			
3126B	275 to 300	3.0	11.0	4.0	76	279	102	1.8	25	1	M111029	OE replacement	
		4.0	11.0	4.0	102	279	102	2.9	40	2	M110012		
		4.0	11.0	4.0	102	279	102	2.6	36	2	M110189	OE replacement	
		4.0	11.0	5.0	102	279	127	1.5	21	2	M111028	Inlet dimension is OD	
		4.0	10x15	4.0	102	254x381	102	2.2	30	2	M120100	Aftermarket, shorter than OE	
		4.0	8.3x11.5	4.0	102	211x292	102	3.0	40	2	M090280	Aftermarket, shorter than OE	
		4.0	8.3x11.5	4.0	102	211x292	102	2.8	38	2	M090534	Aftermarket, shorter than OE	
		5.0	10x15	5.0	127	254x381	127	1.6	22	2	M120108	For off-hwy, shorter than OE	
		5.0	10x15	5.0	127	254x381	127	1.7	23	2	M120365	Aftermarket	
		5.0	10x15	5.0	127	254x381	127	1.8	24	2	M120448	OE replacement	
3126B	330	3.0	11.0	4.0	76	279	102	2.3	31	1	M111029	OE replacement	
		4.0	10x15	4.0	102	254x381	102	2.7	37	2	M120100	Aftermarket, shorter than OE	
		4.0	11.0	5.0	102	279	127	1.9	26	2	M111028	Inlet dimension is OD	
		5.0	10x15	5.0	127	254x381	127	2.0	27	2	M120108	For off-hwy, shorter than OE	
		5.0	10x15	5.0	127	254x381	127	2.1	29	2	M120365	Aftermarket	
		5.0	10x15	5.0	127	254x381	127	2.2	30	2	M120448	OE replacement	
C-10	305 to 370	3.0	11.0	4.0	76	279	102	2.4	32	1	M111029	OE replacement	
		4.0	11.0	5.0	102	279	127	2.0	27	2	M111028	Inlet dimension is OD	
		4.0	10x15	4.0	102	254x381	102	2.9	39	2	M120100	Aftermarket, shorter than OE	
		5.0	10x15	5.0	127	254x381	127	2.1	29	2	M120108	For off-hwy, shorter than OE	
		5.0	10x15	5.0	127	254x381	127	2.2	30	2	M120365	Aftermarket	

Truck Engine Muffler Application

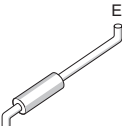
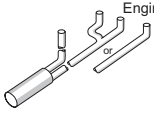

Engine Make & Exhaust System Configuration	Engine Model	H.P.	Muffler Dimensions						Backpressure		Muffler Style & Part No.	Notes	
			inches			mm			inches of Hg	H ₂ O			
			Inlet	Body	Outlet	Inlet	Body	Outlet					
 Engine	C-12	335	5.0	10x15	5.0	127	254x381	127	2.3	32	2	M120448	OE replacement
			3.0	11.0	4.0	76	279	102	2.5	35	1	M111029	OE replacement
			3.0	11.0	4.0	76	279	102	2.6	35	1	M111029	OE replacement
			4.0	11.0	5.0	102	279	127	2.1	29	2	M111028	Inlet dimension is OD
			4.0	11.0	5.0	102	279	127	2.2	30	2	M111028	Inlet dimension is OD
			5.0	10x15	5.0	127	254x381	127	2.3	31	2	M120108	For off-hwy, shorter than OE
			5.0	10x15	5.0	127	254x381	127	2.4	32	2	M120365	Aftermarket
			5.0	10x15	5.0	127	254x381	127	2.5	34	2	M120448	OE replacement
			5.0	10x15	5.0	127	254x381	127	2.3	31	2	M120108	For off-hwy, shorter than OE
			5.0	10x15	5.0	127	254x381	127	2.4	33	2	M120365	Aftermarket
			5.0	10x15	5.0	127	254x381	127	2.5	34	2	M120448	OE replacement
C-12	380 to 430	3.0	11.0	4.0	76	279	102	2.8	38	1	M111029	OE replacement	
		4.0	11.0	5.0	102	279	127	2.4	32	2	M111028	Inlet dimension is OD	
		4.0	11.0	5.0	102	279	127	2.8	38	2	M111028	Inlet dimension is OD	
		5.0	10x15	5.0	127	254x381	127	2.5	34	2	M120108	For off-hwy, shorter than OE	
		5.0	10x15	5.0	127	254x381	127	2.6	36	2	M120365	Aftermarket	
C-15	355	5.0	10x15	5.0	127	254x381	127	2.7	37	2	M120448	OE replacement	
		5.0	10x15	5.0	127	254x381	127	2.9	40	2	M120108	For off-hwy, shorter than OE	
		5.0	10x15	5.0	127	254x381	127	1.9	26	2	M120225	For off-hwy, shorter than OE	
		6.0	10x15	6.0	152	254x381	152	1.6	22	2	M122300	For off-hwy, shorter than OE	
C-15	375	5.0	10x15	5.0	127	254x381	127	2.4	33	2	M120225	For off-hwy, shorter than OE	
		6.0	10x15	6.0	152	254x381	152	2.0	27	2	M122300	For off-hwy, shorter than OE	
C-15	435 to 500	6.0	10x15	6.0	152	254x381	152	2.5	34	2	M122300	For off-hwy, shorter than OE	
C-16	575 to 600	6.0	10x15	6.0	152	254x381	152	2.7	37	2	M122300	For off-hwy, shorter than OE	
3406E	355	4.0	11.0	5.0	102	279	127	2.8	38	2	M111028	Inlet dimension is OD	
		5.0	10x15	5.0	127	254x381	127	2.9	40	2	M120108	For off-hwy, shorter than OE	
		5.0	10x15	5.0	127	254x381	127	1.9	26	2	M120225	For off-hwy, shorter than OE	
		6.0	10x15	6.0	152	254x381	152	1.6	22	2	M122300	For off-hwy, shorter than OE	
3406E	375	5.0	10x15	5.0	127	254x381	127	2.4	33	2	M120225	For off-hwy, shorter than OE	
		6.0	10x15	6.0	152	254x381	152	2.0	27	2	M122300	For off-hwy, shorter than OE	
3406E	435 to 455	5.0	10x15	5.0	127	254x381	127	2.8	37	2	M120225	For off-hwy, shorter than OE	
		6.0	10x15	6.0	152	254x381	152	2.3	31	2	M122300	For off-hwy, shorter than OE	
3406E	475 to 500	6.0	10x15	6.0	152	254x381	152	2.5	34	2	M122300	For off-hwy, shorter than OE	
3406E	575 to 600	6.0	10x15	6.0	152	254x381	152	2.7	37	2	M122300	For off-hwy, shorter than OE	
 Engine	3406B	350	5.0	10x15	5.0	127	254x381	127	1.9	26	5	M120131	For off-hwy, shorter than OE
			5.0	10x15	5.0	127	254x381	127	2.2	30	5	M120450	OE replacement
3406B	400 to 460	5.0	10x15	5.0	127	254x381	127	2.5	33	5	M120131	For off-hwy, shorter than OE	
		5.0	10x15	5.0	127	254x381	127	2.9	39	5	M120450	OE replacement	
C-12	335	5.0	10x15	5.0	127	254x381	127	1.5	20	5	M120131	For off-hwy, shorter than OE	
		5.0	10x15	5.0	127	254x381	127	2.9	40	5	M120176	Aftermarket, shorter than OE	
		5.0	10x15	5.0	127	254x381	127	2.9	40	5	M120189	Aftermarket, shorter than OE	
		5.0	10x15	5.0	127	254x381	127	1.7	24	5	M120450	OE replacement	
C-12	355 to 430	5.0	10x15	5.0	127	254x381	127	1.7	23	5	M120131	For off-hwy, shorter than OE	
		5.0	10x15	5.0	127	254x381	127	2.0	27	5	M120450	OE replacement	
C-15	355	5.0	10x15	5.0	127	254x381	127	1.9	26	5	M120131	For off-hwy, shorter than OE	
		5.0	10x15	5.0	127	254x381	127	2.2	31	5	M120450	OE replacement	
C-15	375	5.0	10x15	5.0	127	254x381	127	2.4	33	5	M120131	For off-hwy, shorter than OE	
		5.0	10x15	5.0	127	254x381	127	2.8	38	5	M120450	OE replacement	
3406E	355	5.0	10x15	5.0	127	254x381	127	1.9	26	5	M120131	For off-hwy, shorter than OE	
		5.0	10x15	5.0	127	254x381	127	2.3	31	5	M120450	OE replacement	
3406E	375	5.0	10x15	5.0	127	254x381	127	2.4	33	5	M120131	For off-hwy, shorter than OE	
		5.0	10x15	5.0	127	254x381	127	2.8	38	5	M120450	OE replacement	
3406E	435	5.0	10x15	5.0	127	254x381	127	2.7	37	5	M120131	For off-hwy, shorter than OE	
3406E	455	5.0	10x15	5.0	127	254x381	127	2.8	37	5	M120131	For off-hwy, shorter than OE	

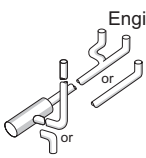
Engine Make & Exhaust System Configuration	Engine Model	Engine H.P.	Muffler Dimensions						Backpressure		Muffler Style & Part No.	Notes	
			inches			mm			inches of Hg	H ₂ O			
			Inlet	Body	Outlet	Inlet	Body	Outlet					
	3116	170-185	3.5	8.3x11.5	4.0	89	211x292	102	2.6	35	4	M090547	OE replacement
			3.5	8.3x11.5	4.0	89	211x292	102	1.6	21	4	M090548	OE replacement
			4.0	10.0	4.0	102	254	102	2.0	28	4	M100052	
			4.0	10.0	5.0	102	254	127	1.9	26	4	M100635	
			4.0	11.0	4.0	102	279	102	1.7	23	4	M110112	
			4.0	11.0	4.0	102	279	102	1.7	23	4	M110148	
			4.0	11.0	4.0	102	279	102	1.7	23	4	M110311	Inlet dimension is OD
			4.0	10x15	4.0	102	254x381	102	2.0	27	4	M120367	Aftermarket, shorter than OE
			5.0	11.0	5.0	127	279	127	1.0	13	4	M110014	OE replacement
			5.0	10x15	5.0	127	254x381	127	1.0	14	4	M120366	OE replacement
3116	220-275	3.5	8.3x11.5	4.0	89	211x292	102	2.3	31	4	M090548	OE replacement	
		4.0	10.0	4.0	102	254	102	2.9	40	4	M100052		
		4.0	10.0	5.0	102	254	127	2.7	37	4	M100635		
		4.0	11.0	4.0	102	279	102	2.4	33	4	M110112		
		4.0	11.0	4.0	102	279	102	2.4	33	4	M110148		
		4.0	11.0	4.0	102	279	102	2.4	33	4	M110311	Inlet dimension is OD	
		4.0	10x15	4.0	102	254x381	102	2.9	39	4	M120367	Aftermarket, shorter than OE	
		5.0	11.0	5.0	127	279	127	1.4	19	4	M110014	OE replacement	
3116	300	5.0	11.0	5.0	127	279	127	2.1	28	4	M110014	OE replacement	
		5.0	10x15	5.0	127	254x381	127	2.2	30	4	M120366	OE replacement	
3176	275 to 300	4.0	10.0	4.0	102	254	102	2.8	38	4	M100052		
		5.0	11.0	5.0	127	279	127	1.3	18	4	M110014	OE replacement	
		4.0	11.0	4.0	102	279	102	2.3	31	4	M110112		
		4.0	11.0	4.0	102	279	102	2.3	31	4	M110148		
		4.0	11.0	4.0	102	279	102	2.3	31	4	M110311	Inlet dimension is OD	
		4.0	11.0	4.0	102	279	102	2.0	28	4	M111025	Inlet & outlet dimension is OD	
		5.0	10x15	5.0	127	254x381	127	1.4	19	4	M120366	OE replacement	
3176	350 to 365	5.0	11.0	5.0	127	279	127	1.7	24	4	M110014	OE replacement	
		4.0	11.0	4.0	102	279	102	2.7	36	4	M111025	Inlet & outlet dimension is OD	
		5.0	10x15	5.0	127	254x381	127	1.8	25	4	M120366	OE replacement	
3306	300	5.0	11.0	5.0	127	279	127	1.8	24	4	M110014	OE replacement	
		4.0	11.0	4.0	102	279	102	2.7	37	4	M111025	Inlet & outlet dimension is OD	
		5.0	10x15	5.0	127	254x381	127	1.8	25	4	M120366	OE replacement	
3306B	245	4.0	10.0	4.0	102	254	102	2.6	36	4	M100052		
		5.0	11.0	5.0	127	279	127	1.2	17	4	M110014	OE replacement	
		4.0	11.0	4.0	102	279	102	2.2	29	4	M110112		
		4.0	11.0	4.0	102	279	102	2.2	29	4	M110148		
		4.0	11.0	4.0	102	279	102	2.2	29	4	M110311	Inlet dimension is OD	
		4.0	11.0	4.0	102	279	102	1.9	26	4	M111025	Inlet & outlet dimension is OD	
		5.0	10x15	5.0	127	254x381	127	1.3	18	4	M120366	OE replacement	
		4.0	10x15	4.0	102	254x381	102	2.5	35	4	M120367	Aftermarket, shorter than OE	
3306B	285	5.0	11.0	5.0	127	279	127	1.5	21	4	M110014	OE replacement	
		4.0	11.0	4.0	102	279	102	2.6	36	4	M110112		
		4.0	11.0	4.0	102	279	102	2.6	36	4	M110148		
		4.0	11.0	4.0	102	279	102	2.3	32	4	M111025	Inlet & outlet dimension is OD	
		5.0	10x15	5.0	127	254x381	127	1.6	22	4	M120366	OE replacement	
3306B	300	5.0	11.0	5.0	127	279	127	1.7	23	4	M110014	OE replacement	
		4.0	11.0	4.0	102	279	102	2.6	35	4	M111025	Inlet & outlet dimension is OD	
		5.0	10x15	5.0	127	254x381	127	1.8	24	4	M120366	OE replacement	
3406B	Multi-Torque 300-310	5.0	11.0	5.0	127	279	127	2.0	27	4	M110014	OE replacement	
		5.0	10x15	5.0	127	254x381	127	2.1	29	4	M120366	OE replacement	
3406B	330	5.0	11.0	5.0	127	279	127	2.4	32	4	M110014	OE replacement	
		5.0	10x15	5.0	127	254x381	127	2.5	34	4	M120366	OE replacement	

Truck Engine Muffler Application

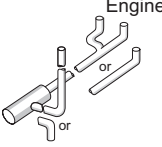

Engine Make & Exhaust System Configuration		Engine Model	H.P.	Muffler Dimensions						Backpressure		Muffler Style & Part No.	Notes		
				inches			mm			inches of Hg	H ₂ O				
				Inlet	Body	Outlet	Inlet	Body	Outlet						
	3126B	175	4.0	10.0	4.0	102	254	102	2.1	29	4	M100052			
			5.0	11.0	5.0	127	279	127	1.0	14	4	M110014	OE replacement		
			4.0	11.0	4.0	102	279	102	1.8	24	4	M110112			
			4.0	11.0	4.0	102	279	102	1.8	24	4	M110148			
			4.0	11.0	4.0	102	279	102	1.8	24	4	M110311	Inlet dimension is OD		
			4.0	11.0	4.0	102	279	102	1.5	21	4	M111025	Inlet & outlet dimension is OD		
			5.0	10x15	5.0	127	254x381	127	1.1	14	4	M120366	OE replacement		
			4.0	10x15	4.0	102	254x381	102	2.1	28	4	M120367	Aftermarket, shorter than OE		
			3126B	190	4.0	10.0	4.0	102	254	102	2.6	35	4	M100052	
					5.0	11.0	5.0	127	279	127	1.2	17	4	M110014	OE replacement
4.0	11.0	4.0			102	279	102	2.1	29	4	M110112				
4.0	11.0	4.0			102	279	102	2.1	29	4	M110148				
4.0	11.0	4.0			102	279	102	2.1	29	4	M110311	Inlet dimension is OD			
4.0	11.0	4.0			102	279	102	1.9	26	4	M111025	Inlet & outlet dimension is OD			
5.0	10x15	5.0			127	254x381	127	1.3	18	4	M120366	OE replacement			
4.0	10x15	4.0			102	254x381	102	2.5	34	4	M120367	Aftermarket, shorter than OE			
3126B	210 to 230	4.0			10.0	4.0	102	254	102	2.4	32	4	M100052		
		5.0			11.0	5.0	127	279	127	1.1	15	4	M110014	OE replacement	
		4.0	11.0	4.0	102	279	102	1.9	26	4	M110112				
		4.0	11.0	4.0	102	279	102	1.9	26	4	M110148				
		4.0	11.0	4.0	102	279	102	1.9	26	4	M110311	Inlet dimension is OD			
		4.0	11.0	4.0	102	279	102	1.7	23	4	M111025	Inlet & outlet dimension is OD			
		5.0	10x15	5.0	127	254x381	127	1.2	16	4	M120366	OE replacement			
		4.0	10x15	4.0	102	254x381	102	2.3	31	4	M120367	Aftermarket, shorter than OE			
		3126B	250	4.0	10.0	4.0	102	254	102	2.9	39	4	M100052		
				5.0	11.0	5.0	127	279	127	1.4	18	4	M110014	OE replacement	
4.0	11.0			4.0	102	279	102	2.4	32	4	M110112				
4.0	11.0			4.0	102	279	102	2.4	32	4	M110148				
4.0	11.0			4.0	102	279	102	2.4	32	4	M110311	Inlet dimension is OD			
4.0	11.0			4.0	102	279	102	2.1	28	4	M111025	Inlet & outlet dimension is OD			
5.0	10x15			5.0	127	254x381	127	1.4	19	4	M120366	OE replacement			
4.0	10x15			4.0	102	254x381	102	2.8	38	4	M120367	Aftermarket, shorter than OE			
3126B	275			4.0	10.0	4.0	102	254	102	2.8	39	4	M100052		
				5.0	11.0	5.0	127	279	127	1.3	18	4	M110014	OE replacement	
		4.0	11.0	4.0	102	279	102	2.3	32	4	M110112				
		4.0	11.0	4.0	102	279	102	2.3	32	4	M110148				
		4.0	11.0	4.0	102	279	102	2.3	32	4	M110311	Inlet dimension is OD			
		4.0	11.0	4.0	102	279	102	2.1	28	4	M111025	Inlet & outlet dimension is OD			
		5.0	10x15	5.0	127	254x381	127	1.4	19	4	M120366	OE replacement			
		4.0	10x15	4.0	102	254x381	102	2.7	37	4	M120367	Aftermarket, shorter than OE			
		3126B	300	5.0	11.0	5.0	127	279	127	1.5	20	4	M110014	OE replacement	
				4.0	11.0	4.0	102	279	102	2.6	35	4	M110112		
4.0	11.0			4.0	102	279	102	2.6	35	4	M110148				
4.0	11.0			4.0	102	279	102	2.6	35	4	M110311	Inlet dimension is OD			
4.0	11.0			4.0	102	279	102	2.3	31	4	M111025	Inlet & outlet dimension is OD			
5.0	10x15			5.0	127	254x381	127	1.5	21	4	M120366	OE replacement			
3126B	330	5.0	11.0	5.0	127	279	127	1.8	25	4	M110014	OE replacement			
		4.0	11.0	4.0	102	279	102	2.8	38	4	M111025	Inlet & outlet dimension is OD			
		5.0	10x15	5.0	127	254x381	127	1.9	26	4	M120366	OE replacement			
C-10	305 to 370	5.0	11.0	5.0	127	279	127	1.9	26	4	M110014	OE replacement			
		4.0	11.0	4.0	102	279	102	3.0	40	4	M111025	Inlet & outlet dimension is OD			
		5.0	10x15	5.0	127	254x381	127	2.0	28	4	M120366	OE replacement			
3316	170-185	4.0	10.0	4.0	102	254	102	2.1	28	6	M100572				
		4.0	10.0	4.0	102	254	102	2.1	28	6	M100865				
		4.0	11.0	4.0	102	279	102	1.6	22	6	M111026	Outlet dimension is O.D.			
		5.0	10x15	5.0	127	254x381	127	1.1	14	6	M120418	For off-hwy, shorter than OE			
3316	220-275	4.0	11.0	4.0	102	279	102	2.3	32	6	M111026	Outlet dimension is OD			
		5.0	10x15	5.0	127	254x381	127	1.5	21	6	M120418	For off-hwy, shorter than OE			
3316	300	5.0	10x15	5.0	127	254x381	127	2.3	31	6	M120418	For off-hwy, shorter than OE			
3176	365	4.0	11.0	4.0	102	279	102	2.9	40	6	M111026	Outlet dimension is OD			
		5.0	10x15	5.0	127	254x381	127	1.9	26	6	M120418	For off-hwy, shorter than OE			
3176	275 to 300	4.0	10.0	4.0	102	254	102	2.9	39	6	M100572				
		4.0	11.0	4.0	102	279	102	2.2	30	6	M111026	Outlet dimension is OD			
		5.0	10x15	5.0	127	254x381	127	1.4	20	6	M120418	For off-hwy, shorter than OE			
3176	350	5.0	10x15	5.0	127	254x381	127	1.8	25	6	M120418	For off-hwy, shorter than OE			
		4.0	11.0	4.0	102	279	102	2.8	38	6	M111026	Outlet dimension is OD			

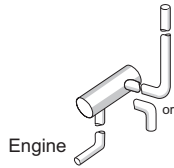

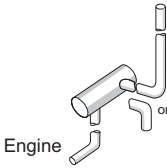
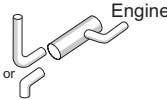
Engine Make & Exhaust System Configuration	Engine Model	Engine H.P.	Muffler Dimensions						Backpressure		Muffler Style & Part No.	Notes		
			inches			mm			inches of Hg	H ₂ O				
			Inlet	Body	Outlet	Inlet	Body	Outlet						
	3306	300	5.0 4.0	10x15 11.0	5.0 4.0	127 102	254x381 279	127 102	1.9 3.0	26 40	6 6	M120418 M111026	For off-hwy, shorter than OE Outlet dimension is OD	
	3306B	245	4.0	10.0	4.0	102	254	102	2.7	37	6	M100572		
			4.0	11.0	4.0	102	279	102	2.1	28	6	M111026	Outlet dimension is OD	
			5.0	10x15	5.0	127	254x381	127	1.4	18	6	M120418	For off-hwy, shorter than OE	
	3306B	285 to 300	4.0	11.0	4.0	102	279	102	2.8	38	6	M111026	Outlet dimension is OD	
			5.0	10x15	5.0	127	254x381	127	1.8	25	6	M120418	For off-hwy, shorter than OE	
	3406B	Multi-Torque 300-310		5.0	10x15	5.0	127	254x381	127	2.2	30	6	M120418	For off-hwy, shorter than OE
	3406B	330		5.0	10x15	5.0	127	254x381	127	2.6	35	6	M120418	For off-hwy, shorter than OE
	3126B	175	4.0	10.0	4.0	102	254	102	2.2	30	6	M100572		
			4.0	11.0	4.0	102	279	102	1.7	23	6	M111026	Outlet dimension is OD	
			5.0	10x15	5.0	127	254x381	127	1.1	15	6	M120418	For off-hwy, shorter than OE	
	3126B	190	4.0	10.0	4.0	102	254	102	2.7	36	6	M100572		
			4.0	11.0	4.0	102	279	102	2.1	28	6	M111026	Outlet dimension is OD	
			5.0	10x15	5.0	127	254x381	127	1.3	18	6	M120418	For off-hwy, shorter than OE	
	3126B	210 to 230	4.0	10.0	4.0	102	254	102	2.4	33	6	M100572		
4.0			11.0	4.0	102	279	102	1.9	25	6	M111026	Outlet dimension is OD		
5.0			10x15	5.0	127	254x381	127	1.2	16	6	M120418	For off-hwy, shorter than OE		
3126B	250	4.0	10.0	4.0	102	254	102	2.9	40	6	M100572			
		4.0	11.0	4.0	102	279	102	1.9	25	6	M111026	Outlet dimension is OD		
		5.0	10x15	5.0	127	254x381	127	1.2	16	6	M120418	For off-hwy, shorter than OE		
3126B	275	4.0	10.0	4.0	102	254	102	2.9	40	6	M100572			
		4.0	11.0	4.0	102	279	102	1.9	25	6	M111026	Outlet dimension is OD		
		5.0	10x15	5.0	127	254x381	127	1.2	16	6	M120418	For off-hwy, shorter than OE		
3126B	300	4.0	11.0	4.0	102	279	102	2.5	33	6	M111026	Outlet dimension is OD		
		5.0	10x15	5.0	127	254x381	127	1.6	22	6	M120418	For off-hwy, shorter than OE		
3126B	330		5.0	10x15	5.0	127	254x381	127	2.0	27	6	M120418	For off-hwy, shorter than OE	
C-10	305 to 335	4.0	11.0	4.0	102	279	102	2.9	39	6	M111026	Outlet dimension is OD		
		5.0	10x15	5.0	127	254x381	127	1.9	25	6	M120418	For off-hwy, shorter than OE		
C-10	350 to 370		5.0	10x15	5.0	127	254x381	127	2.1	28	6	M120418	For off-hwy, shorter than OE	
	3116	170-185	4.0	11.0	4.0	102	279	102	2.2	30	3	M110479		
			4.0	11.0	4.0	102	279	102	2.0	28	3	M110674		
			4.0	11.0		102	279	0	2.0	27	3	M111024	Outlet has down spout	
			4.0	10x15	5.0	102	254x381	127	1.2	16	3	M120566	OE replacement	
			5.0	10x15	5.0	127	254x381	127	1.3	18	3	M120235	OE replacement	
	3116	200-275	4.0	11.0	4.0	102	279	102	2.9	40	3	M110674		
			4.0	11.0		102	279	0	2.9	39	3	M111024	Outlet has down spout	
			4.0	10x15	5.0	102	254x381	127	1.7	23	3	M120566	OE replacement	
			5.0	10x15	5.0	127	254x381	127	1.9	26	3	M120235	OE replacement	
	3116	300		4.0	10x15	5.0	102	254x381	127	2.6	35	3	M120566	OE replacement
	3176	275	4.0	11.0	4.0	102	279	102	2.6	36	3	M110479		
			4.0	11.0	4.0	102	279	102	2.4	33	3	M110674	Band clamp on inlet	
			4.0	11.0		102	279		2.4	32	3	M111024	Outlet has down spout	
			5.0	10x15	5.0	127	254x381	127	1.6	21	3	M120235	OE replacement	
	3176	300	4.0	11.0	4.0	102	279	102	2.8	38	3	M110674	Band clamp on inlet	
4.0			11.0		102	279		2.7	37	3	M111024	Outlet has down spout		
5.0			10x15	5.0	127	254x381	127	1.8	25	3	M120235	OE replacement		
3176	350 to 365		5.0	10x15	5.0	127	254x381	127	2.4	32	3	M120235	OE replacement	
3306	300		5.0	10x15	5.0	127	254x381	127	2.4	33	3	M120235	OE replacement	
3306B	245	4.0	11.0	4.0	102	279	102	2.9	39	3	M110479			
		4.0	11.0	4.0	102	279	102	2.6	36	3	M110674	Band clamp on inlet		
		4.0	11.0		102	279		2.6	35	3	M111024	Outlet has down spout		
		5.0	10x15	5.0	127	254x381	127	1.7	23	3	M120235	OE replacement		
3306B	285 to 300		5.0	10x15	5.0	127	254x381	127	2.3	31	3	M120235	OE replacement	

Engine Make & Exhaust System Configuration	Engine Model	H.P.	Muffler Dimensions						Backpressure		Muffler Style & Part No.	Notes	
			inches			mm			inches of Hg	H ₂ O			
	3126B	175	4.0	11.0	4.0	102	279	102	2.3	31	3	M110479	
			4.0	11.0	4.0	102	279	102	2.1	29	3	M110674	Band clamp on inlet
			4.0	11.0		102	279		2.1	28	3	M111024	Outlet has down spout
			5.0	10x15	5.0	127	254x381	127	1.4	19	3	M120235	OE replacement
	3126B	190	4.0	11.0	4.0	102	279	102	2.8	38	3	M110479	
			4.0	11.0	4.0	102	279	102	2.6	35	3	M110674	Band clamp on inlet
			4.0	11.0		102	279		2.5	34	3	M111024	Outlet has down spout
			5.0	10x15	5.0	127	254x381	127	1.7	23	3	M120235	OE replacement
	3126B	210 to 230	4.0	11.0	4.0	102	279	102	2.6	35	3	M110479	
			4.0	11.0	4.0	102	279	102	2.4	32	3	M110674	Band clamp on inlet
			4.0	11.0		102	279		2.3	31	3	M111024	Outlet has down spout
			5.0	10x15	5.0	127	254x381	127	1.5	21	3	M120235	OE replacement
	3126B	250	4.0	11.0	4.0	102	279	102	2.9	39	3	M110674	Band clamp on inlet
			4.0	11.0		102	279		2.8	38	3	M111024	Outlet has down spout
			5.0	10x15	5.0	127	254x381	127	1.8	25	3	M120235	OE replacement
	3126B	275	4.0	11.0	4.0	102	279	102	2.8	39	3	M110674	Band clamp on inlet
			4.0	11.0		102	279		2.7	37	3	M111024	Outlet has down spout
			5.0	10x15	5.0	127	254x381	127	1.8	25	3	M120235	OE replacement
	3126B	300	5.0	10x15	5.0	127	254x381	127	2.0	27	3	M120235	OE replacement
	3126B	330	5.0	10x15	5.0	127	254x381	127	2.5	34	3	M120235	OE replacement
	C-10	305 to 370	5.0	10x15	5.0	127	254x381	127	2.6	36	3	M120235	OE replacement

Cummins

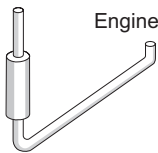

	ISM	310 to 350	4.0	8.5	4.0	102	216	102	1.2	17	1	M085171	
			4.0	9.0	5.0	102	229	127	1.7	24	1	M090781	
			5.0	9.0	5.0	127	229	127	1.5	20	1	M090074	
			5.0	9.0	5.0	127	229	127	0.8	11	1	M090535	Low backpressure, off-hwy
			5.0	10.0	5.0	127	254	127	0.8	11	1	M100463	Low backpressure, off-hwy
			5.0	10.0	5.0	127	254	127	0.5	7	1	M100465	Best value, most popular
			5.0	10.0	5.0	127	254	127	1.6	22	1	M100580	OE replacement
			5.0	10.0	5.0	127	254	127	1.8	24	1	M100807	60" (1524mm) Long Body
			5.0	10.0	5.0	127	254	127	1.3	18	1	M100944	OE replacement for higher HP
			5.0	10.0	5.0	127	254	127	1.6	22	1	M101158	Silent Partner Stainless
			5.0	10.0	5.0	127	254	127	1.6	22	1	M101181	Silent Partner Aluminized
			5.0	10.0	5.0	127	254	127	1.6	22	1	M101263	Freightliner only
			5.0	11.0	5.0	127	279	127	1.3	18	1	M110849	
				ISM	370 to 450	4.0	8.5	4.0	102	216	102	1.5	21
4.0	9.0	5.0				102	229	127	2.2	29	1	M090781	
5.0	9.0	5.0				127	229	127	1.8	25	1	M090074	
5.0	9.0	5.0				127	229	127	1.0	13	1	M090535	Low backpressure, off-hwy
5.0	10.0	5.0				127	254	127	1.0	13	1	M100463	Low backpressure, off-hwy
5.0	10.0	5.0				127	254	127	0.6	9	1	M100465	Best value, most popular
5.0	10.0	5.0				127	254	127	2.1	28	1	M100580	OE replacement
5.0	10.0	5.0				127	254	127	2.2	30	1	M100807	60" (1524mm) Long Body
5.0	10.0	5.0				127	254	127	1.6	22	1	M100944	OE replacement for higher HP
5.0	10.0	5.0				127	254	127	2.0	27	1	M101158	Silent Partner Stainless
5.0	10.0	5.0				127	254	127	2.0	27	1	M101181	Silent Partner Aluminized
5.0	10.0	5.0				127	254	127	2.1	28	1	M101263	Freightliner only
5.0	11.0	5.0				127	279	127	1.6	22	1	M110849	
	ISM	500				4.0	8.5	4.0	102	216	102	1.7	24
			4.0	9.0	5.0	102	229	127	2.5	34	1	M090781	
			5.0	9.0	5.0	127	229	127	2.1	29	1	M090074	
			5.0	9.0	5.0	127	229	127	1.1	15	1	M090535	Low backpressure, off-hwy
			5.0	10.0	5.0	127	254	127	1.1	15	1	M100463	Low backpressure, off-hwy
			5.0	10.0	5.0	127	254	127	0.8	10	1	M100465	Best value, most popular
			5.0	10.0	5.0	127	254	127	2.4	32	1	M100580	OE replacement
			5.0	10.0	5.0	127	254	127	2.5	35	1	M100807	60" (1524mm) Long Body
			5.0	10.0	5.0	127	254	127	1.9	26	1	M100944	OE replacement for higher HP
			5.0	10.0	5.0	127	254	127	2.3	31	1	M101158	Silent Partner Stainless
			5.0	10.0	5.0	127	254	127	2.3	31	1	M101181	Silent Partner Aluminized
			5.0	10.0	5.0	127	254	127	2.4	32	1	M101263	Freightliner only
			5.0	11.0	5.0	127	279	127	1.9	25	1	M110849	
				ISX	400	5.0	9.0	5.0	127	229	127	2.0	27
5.0	9.0	5.0				127	229	127	1.1	15	1	M090535	Low backpressure, off-hwy
4.0	9.0	5.0				102	229	127	2.4	32	1	M090781	
5.0	10.0	5.0				127	254	127	1.1	15	1	M100463	Low backpressure, off-hwy
5.0	10.0	5.0				127	254	127	0.7	9	1	M100465	Best value, most popular
5.0	10.0	5.0				127	254	127	2.3	31	1	M100580	OE replacement
			5.0	10.0	5.0	127	254	127	2.4	33	1	M100807	60" (1524mm) Long Body

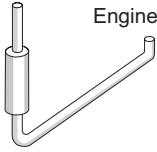
Engine Make & Exhaust System Configuration	Engine Model	H.P.	Muffler Dimensions inches			Muffler Dimensions mm			Backpressure inches of Hg / H ₂ O		Muffler Style & Part No.		Notes
			Inlet	Body	Outlet	Inlet	Body	Outlet					
			5.0	10.0	5.0	127	254	127	1.8	24	1	M100944	OE replacement for higher HP
			5.0	10.0	5.0	127	254	127	2.2	29	1	M101158	Silent Partner Stainless
			5.0	10.0	5.0	127	254	127	2.2	29	1	M101181	Silent Partner Aluminized
			5.0	10.0	5.0	127	254	127	2.3	31	1	M101263	Freightliner only
			5.0	11.0	5.0	127	279	127	1.8	24	1	M110849	
ISX	450 to 475	5.0	9.0	5.0	127	229	127	2.6	35	1	M090074		
		5.0	9.0	5.0	127	229	127	1.4	19	1	M090535	Low backpressure, off-hwy	
		5.0	10.0	5.0	127	254	127	1.4	19	1	M100463	Low backpressure, off-hwy	
		5.0	10.0	5.0	127	254	127	0.9	12	1	M100465	Best value, most popular	
		5.0	10.0	5.0	127	254	127	2.9	40	1	M100580	OE replacement	
		5.0	10.0	5.0	127	254	127	2.3	31	1	M100944	OE replacement for higher HP	
		5.0	10.0	5.0	127	254	127	2.8	38	1	M101158	Silent Partner Stainless	
		5.0	10.0	5.0	127	254	127	2.8	38	1	M101181	Silent Partner Aluminized	
		5.0	10.0	5.0	127	254	127	2.9	40	1	M101263	Freightliner only	
ISX	500	5.0	9.0	5.0	127	229	127	2.8	38	1	M090074		
		5.0	9.0	5.0	127	229	127	1.5	20	1	M090535	Low backpressure, off-hwy	
		5.0	10.0	5.0	127	254	127	1.5	20	1	M100463	Low backpressure, off-hwy	
		5.0	10.0	5.0	127	254	127	0.9	13	1	M100465	Best value, most popular	
		5.0	10.0	5.0	127	254	127	2.5	34	1	M100944	OE replacement for higher HP	
ISX	600	5.0	9.0	5.0	127	229	127	2.0	27	1	M090535	Low backpressure, off-hwy	
		5.0	10.0	5.0	127	254	127	2.0	27	1	M100463	Low backpressure, off-hwy	
L10	260 to 280	4.0	8.5	4.0	102	216	102	0.6	8	1	M085171		
		4.0	9.0	5.0	102	229	127	0.5	6	1	M090781		
		5.0	9.0	5.0	127	229	127	0.7	10	1	M090074		
		5.0	10.0	5.0	127	254	127	0.3	4	1	M100465	Best value, most popular	
		5.0	10.0	5.0	127	254	127	0.8	11	1	M100580	OE replacement	
		5.0	10.0	5.0	127	254	127	0.9	12	1	M100807	60" (1524mm) Long Body	
		5.0	10.0	5.0	127	254	127	0.8	11	1	M101158		
		5.0	10.0	5.0	127	254	127	0.8	11	1	M101181	Silent Partner Aluminized	
		5.0	10.0	5.0	127	254	127	0.8	11	1	M101263	Freightliner only	
		5.0	10.0	5.0	127	254	127	0.7	9	1	M110944		
L10	300 to 375	5.0	11.0	5.0	127	279	127	0.7	9	1	M110849		
		4.0	8.5	4.0	102	216	102	0.5	7	1	M085171		
		4.0	9.0	5.0	102	229	127	0.4	5	1	M090781		
		5.0	9.0	5.0	127	229	127	0.6	9	1	M090074		
		5.0	10.0	5.0	127	254	127	0.2	3	1	M100465	Best value, most popular	
		5.0	10.0	5.0	127	254	127	0.7	10	1	M100580	OE replacement	
		5.0	10.0	5.0	127	254	127	0.8	11	1	M100807	60" (1524mm) Long Body	
		5.0	10.0	5.0	127	254	127	0.7	9	1	M101158		
		5.0	10.0	5.0	127	254	127	0.7	9	1	M101181	Silent Partner Aluminized	
M11	400	5.0	10.0	5.0	127	254	127	0.7	10	1	M101263	Freightliner only	
		5.0	11.0	5.0	127	279	127	0.6	8	1	M110849		
		4.0	8.5	4.0	102	216	102	1.0	13	1	M085171		
		4.0	9.0	5.0	102	229	127	1.4	19	1	M090781		
		5.0	9.0	5.0	127	229	127	1.2	16	1	M090074		
		5.0	9.0	5.0	127	229	127	0.6	8	1	M090535	Low backpressure, off-hwy	
		5.0	10.0	5.0	127	254	127	0.6	8	1	M100463	Low backpressure, off-hwy	
		5.0	10.0	5.0	127	254	127	0.4	5	1	M100465	Best value, most popular	
		5.0	10.0	5.0	127	254	127	1.3	18	1	M100580	OE replacement	
		5.0	10.0	5.0	127	254	127	1.4	19	1	M100807	60" (1524mm) Long Body	
		5.0	10.0	5.0	127	254	127	1.0	14	1	M100944	OE replacement for higher HP	
		5.0	10.0	5.0	127	254	127	1.2	17	1	M101158	Silent Partner Stainless	
		5.0	10.0	5.0	127	254	127	1.2	17	1	M101181	Silent Partner Aluminized	
N14	330	5.0	10.0	5.0	127	254	127	1.3	18	1	M101263	Freightliner only	
		5.0	11.0	5.0	127	279	127	1.0	14	1	M110849		
		4.0	8.5	4.0	102	216	102	1.4	19	1	M085171		
		4.0	9.0	5.0	102	229	127	1.9	26	1	M090781		
		5.0	9.0	5.0	127	229	127	1.6	22	1	M090074		
		5.0	9.0	5.0	127	229	127	0.9	12	1	M090535	Low backpressure, off-hwy	
		5.0	10.0	5.0	127	254	127	0.9	12	1	M100463	Low backpressure, off-hwy	
		5.0	10.0	5.0	127	254	127	0.6	8	1	M100465	Best value, most popular	
		5.0	10.0	5.0	127	254	127	1.8	25	1	M100580	OE replacement	
		5.0	10.0	5.0	127	254	127	2.0	27	1	M100807	60" (1524mm) Long Body	
		5.0	10.0	5.0	127	254	127	1.5	20	1	M100944	OE replacement for higher HP	

Truck Engine Muffler Application

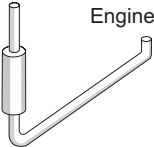
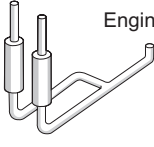

Engine Make & Exhaust System Configuration	Engine Model	H.P.	Muffler Dimensions						Backpressure		Muffler Style & Part No.	Notes			
			inches			mm			inches of Hg	H ₂ O					
			Inlet	Body	Outlet	Inlet	Body	Outlet							
 Engine	N14	350 to 435	4.0	8.5	4.0	102	216	102	2.2	30	1	M085171			
			5.0	9.0	5.0	127	229	127	2.7	36	1	M090074			
			5.0	9.0	5.0	127	229	127	1.4	19	1	M090535	Low backpressure, off-hwy		
			5.0	10.0	5.0	127	254	127	1.4	19	1	M100463	Low backpressure, off-hwy		
			5.0	10.0	5.0	127	254	127	2.9	40	1	M100580	OE replacement		
			5.0	10.0	5.0	127	254	127	0.9	12	1	M100465	Best value, most popular		
			5.0	10.0	5.0	127	254	127	2.4	32	1	M100944	OE replacement for higher HP		
			5.0	10.0	5.0	127	254	127	2.9	39	1	M101158	Silent Partner Stainless		
			5.0	10.0	5.0	127	254	127	2.9	39	1	M101181	Silent Partner Aluminized		
			5.0	11.0	5.0	127	279	127	2.4	32	1	M110849			
	N14	460	5.0	9.0	5.0	127	229	127	2.9	39	1	M090074			
			5.0	9.0	5.0	127	229	127	1.5	21	1	M090535	Low backpressure, off-hwy		
			5.0	10.0	5.0	127	254	127	1.5	21	1	M100463	Low backpressure, off-hwy		
			5.0	10.0	5.0	127	254	127	2.6	35	1	M100944	OE replacement for higher HP		
			5.0	11.0	5.0	127	279	127	2.6	35	1	M110849			
	N14	500 to 550	5.0	9.0	5.0	127	229	127	1.8	25	1	M090535	Low backpressure, off-hwy		
			5.0	10.0	5.0	127	254	127	1.8	25	1	M100463	Low backpressure, off-hwy		
	NTC	400	4.0	8.5	4.0	102	216	102	2.5	34	1	M085171			
			5.0	9.0	5.0	127	229	127	1.6	22	1	M090535	Low backpressure, off-hwy		
			5.0	10.0	5.0	127	254	127	1.6	22	1	M100463	Low backpressure, off-hwy		
5.0			10.0	5.0	127	254	127	2.7	37	1	M100944	OE replacement for higher HP			
Signature	500	4.0	8.5	4.0	102	216	102	2.2	30	1	M085171				
		5.0	9.0	5.0	127	229	127	2.6	36	1	M090074				
		5.0	9.0	5.0	127	229	127	1.4	19	1	M090535	Low backpressure, off-hwy			
		5.0	10.0	5.0	127	254	127	1.4	19	1	M100463	Low backpressure, off-hwy			
		5.0	10.0	5.0	127	254	127	0.9	12	1	M100465	Best value, most popular			
		5.0	10.0	5.0	127	254	127	2.9	40	1	M100580	OE replacement			
		5.0	10.0	5.0	127	254	127	2.3	32	1	M100944	OE replacement for higher HP			
		5.0	10.0	5.0	127	254	127	2.8	39	1	M101158	Silent Partner Stainless			
		5.0	10.0	5.0	127	254	127	2.8	39	1	M101181	Silent Partner Aluminized			
		5.0	10.0	5.0	127	254	127	2.9	40	1	M101263	Freightliner only			
Signature	565	4.0	8.5	4.0	102	216	102	2.4	33	1	M085171				
		5.0	9.0	5.0	127	229	127	2.9	39	1	M090074				
		5.0	9.0	5.0	127	229	127	1.5	21	1	M090535	Low backpressure, off-hwy			
		5.0	10.0	5.0	127	254	127	1.5	21	1	M100463	Low backpressure, off-hwy			
		5.0	10.0	5.0	127	254	127	2.6	35	1	M100944	OE replacement for higher HP			
Signature	600	4.0	8.5	4.0	102	216	102	2.7	37	1	M085171				
		5.0	9.0	5.0	127	229	127	1.8	24	1	M090535	Low backpressure, off-hwy			
		5.0	10.0	5.0	127	254	127	1.8	24	1	M100463	Low backpressure, off-hwy			
		5.0	10.0	5.0	127	254	127	2.9	40	1	M100944	OE replacement for higher HP			
		5.0	11.0	5.0	127	279	127	2.9	40	1	M110849				
 Engine	ISM	310 to 350	4.0	9.0	4.0	102	229	102	0.7	10	1	M090544			
			4.0	10.0	4.0	102	254	102	0.8	10	1	M100466			
			4.0	10.0	5.0	102	254	127	1.2	17	1	M100695			
			4.0	10.3	4.0	102	262	102	1.4	20	1	M100464	Wrapped muffler		
			5.0	10.0	5.0	127	254	127	0.9	13	1	M100582	OE replacement		
			5.0	10.0	5.0	127	254	127	0.9	13	1	M101159	Silent Partner Stainless		
			5.0	10.0	5.0	127	254	127	0.9	13	1	M101182	Silent Partner Aluminized		
			ISM	370 to 450	4.0	9.0	4.0	102	229	102	0.9	12	1	M090544	
					4.0	10.0	4.0	102	254	102	0.9	13	1	M100466	
					4.0	10.0	5.0	102	254	127	1.5	21	1	M100695	
4.0	10.3	4.0			102	262	102	1.8	24	1	M100464	Wrapped muffler			
5.0	10.0	5.0			127	254	127	1.2	16	1	M100582	OE replacement			
5.0	10.0	5.0			127	254	127	1.2	16	1	M101159	Silent Partner Stainless			
ISM	500	4.0	9.0	4.0	102	229	102	1.0	14	1	M090544				
		4.0	10.3	4.0	102	262	102	2.1	28	1	M100464	Wrapped muffler			
		4.0	10.0	4.0	102	254	102	1.1	15	1	M100466				
		5.0	10.0	5.0	127	254	127	1.3	18	1	M100582	OE replacement			
		4.0	10.0	5.0	102	254	127	1.7	24	1	M100695				
		5.0	10.0	5.0	127	254	127	1.3	18	1	M101159	Silent Partner Stainless			
ISX	400 to 500	4.0	9.0	4.0	102	229	102	1.4	19	1	M090544				
		4.0	10.0	4.0	102	254	102	1.5	20	1	M100466				
		4.0	10.0	5.0	102	254	127	2.3	31	1	M100695				
		4.0	10.3	4.0	102	262	102	2.7	37	1	M100464	Wrapped muffler			

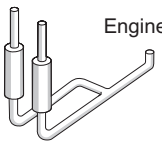
Engine Make & Exhaust System Configuration	Engine Model	Engine H.P.	Muffler Dimensions inches			Muffler Dimensions mm			Backpressure inches of Hg / H ₂ O		Muffler Style & Part No.	Notes			
			Inlet	Body	Outlet	Inlet	Body	Outlet							
 Engine	ISX	600	5.0	10.0	5.0	127	254	127	1.8	24	1	M100582	OE replacement		
			5.0	10.0	5.0	127	254	127	1.8	24	1	M101159	Silent Partner Stainless		
			5.0	10.0	5.0	127	254	127	1.8	24	1	M101182	Silent Partner Aluminized		
			4.0	9.0	4.0	102	229	102	1.8	25	1	M090544			
			4.0	10.0	4.0	102	254	102	1.9	26	1	M100466			
			5.0	10.0	5.0	127	254	127	2.4	32	1	M100582	OE replacement		
			5.0	10.0	5.0	127	254	127	2.4	32	1	M101159	Silent Partner Stainless		
			5.0	10.0	5.0	127	254	127	2.4	32	1	M101182	Silent Partner Aluminized		
			L10	260 to 280	4.0	9.0	4.0	102	229	102	0.4	5	1	M090544	
					4.0	10.0	4.0	102	254	102	0.4	5	1	M100466	
4.0	10.0	5.0			102	254	127	0.6	8	1	M100695				
4.0	10.3	4.0			102	262	102	0.7	10	1	M100464	Wrapped muffler			
5.0	10.0	5.0			127	254	127	0.5	6	1	M100582	OE replacement			
5.0	10.0	5.0			127	254	127	0.5	6	1	M101182	Silent Partner Aluminized			
5.0	10.0	5.0			127	254	127	0.5	6	1	M101159	Silent Partner Stainless			
L10	300-375	4.0			9.0	4.0	102	229	102	0.4	5	1	M090544		
		4.0	10.0	4.0	102	254	102	0.4	6	1	M100466				
		4.0	10.0	5.0	102	254	127	0.7	9	1	M100695				
		4.0	10.3	4.0	102	262	102	0.8	11	1	M100464	Wrapped muffler			
		5.0	10.0	5.0	127	254	127	0.5	7	1	M100582	OE replacement			
		5.0	10.0	5.0	127	254	127	0.5	7	1	M101182	Silent Partner Aluminized			
		5.0	10.0	5.0	127	254	127	0.5	7	1	M101159	Silent Partner Stainless			
M11	400	4.0	9.0	4.0	102	229	102	0.6	8	1	M090544				
		4.0	10.0	5.0	102	254	127	1.0	13	1	M100695				
		4.0	10.3	4.0	102	262	102	1.1	15	1	M100464	Wrapped muffler			
		5.0	10.0	5.0	127	254	127	0.7	10	1	M100582	OE replacement			
		5.0	10.0	5.0	127	254	127	0.7	10	1	M101159	Silent Partner Stainless			
		5.0	10.0	5.0	127	254	127	0.7	10	1	M101182	Silent Partner Aluminized			
N14	330 to 350	4.0	9.0	4.0	102	229	102	1.1	15	1	M090544				
		4.0	10.0	4.0	102	254	102	1.2	16	1	M100466				
		4.0	10.0	5.0	102	254	127	1.9	25	1	M100695				
		4.0	10.3	4.0	102	262	102	2.2	30	1	M100464	Wrapped muffler			
		5.0	10.0	5.0	127	254	127	1.4	19	1	M100582	OE replacement			
		5.0	10.0	5.0	127	254	127	1.4	19	1	M101159	Silent Partner Stainless			
		5.0	10.0	5.0	127	254	127	1.4	19	1	M101182	Silent Partner Aluminized			
N14	370 to 410	4.0	9.0	4.0	102	229	102	1.2	17	1	M090544				
		4.0	10.0	4.0	102	254	102	1.3	18	1	M100466				
		4.0	10.0	5.0	102	254	127	2.1	29	1	M100695				
		4.0	10.3	4.0	102	262	102	2.5	34	1	M100464	Wrapped muffler			
		5.0	10.0	5.0	127	254	127	1.6	22	1	M100582	OE replacement			
		5.0	10.0	5.0	127	254	127	1.6	22	1	M101159	Silent Partner Stainless			
		5.0	10.0	5.0	127	254	127	1.6	22	1	M101182	Silent Partner Aluminized			
N14	435 to 460	4.0	9.0	4.0	102	229	102	1.4	19	1	M090544				
		4.0	10.0	4.0	102	254	102	1.5	20	1	M100466				
		4.0	10.0	5.0	102	254	127	2.4	32	1	M100695				
		4.0	10.3	4.0	102	262	102	2.8	38	1	M100464	Wrapped muffler			
		5.0	10.0	5.0	127	254	127	1.8	25	1	M100582	OE replacement			
		5.0	10.0	5.0	127	254	127	1.8	25	1	M101159	Silent Partner Stainless			
		5.0	10.0	5.0	127	254	127	1.8	25	1	M101182	Silent Partner Aluminized			
N14	500 to 550	4.0	9.0	4.0	102	229	102	1.7	23	1	M090544				
		4.0	10.0	4.0	102	254	102	1.8	24	1	M100466				
		4.0	10.0	5.0	102	254	127	2.9	39	1	M100695				
		5.0	10.0	5.0	127	254	127	2.2	30	1	M100582	OE replacement			
		5.0	10.0	5.0	127	254	127	2.2	30	1	M101159	Silent Partner Stainless			
		5.0	10.0	5.0	127	254	127	2.2	30	1	M101182	Silent Partner Aluminized			
NTC	400	4.0	9.0	4.0	102	229	102	1.5	20	1	M090544				
		4.0	10.0	4.0	102	254	102	1.6	21	1	M100466				
		4.0	10.0	5.0	102	254	127	2.5	34	1	M100695				
		4.0	10.3	4.0	102	262	102	3.0	40	1	M100464	Wrapped muffler			
		5.0	10.0	5.0	127	254	127	1.9	26	1	M100582	OE replacement			
		5.0	10.0	5.0	127	254	127	1.9	26	1	M101159	Silent Partner Stainless			
Signature	500 to 600	4.0	9.0	4.0	102	229	102	1.6	22	1	M090544				
		4.0	10.0	4.0	102	254	102	1.7	23	1	M100466				
		4.0	10.0	5.0	102	254	127	2.7	37	1	M100695				
		5.0	10.0	5.0	127	254	127	2.1	29	1	M100582	OE replacement			
		5.0	10.0	5.0	127	254	127	2.1	29	1	M101159	Silent Partner Stainless			
		5.0	10.0	5.0	127	254	127	2.1	29	1	M101182	Silent Partner Aluminized			

Truck Engine Muffler Application

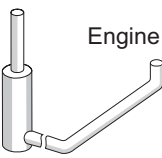
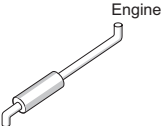

Engine Make & Exhaust System Configuration	Engine Model	H.P.	Muffler Dimensions						Backpressure		Muffler Style & Part No.	Notes			
			inches			mm			inches of Hg	H ₂ O					
			Inlet	Body	Outlet	Inlet	Body	Outlet							
 Engine	6BT	230	4.0	9.0	5.0	102	229	127	1.1	15	3	M090823			
			4.0	11.8	5.0	102	300	127	1.2	16	3	M120598			
			5.0	10.0	5.0	127	254	127	1.1	14	3	M100213			
	6CT	300	4.0	9.0	5.0	102	229	127	2.3	31	3	M090823			
			4.0	11.8	5.0	102	300	127	2.4	32	3	M120598			
			5.0	10.0	5.0	127	254	127	2.1	29	3	M100213			
	6CT	250	4.0	9.0	5.0	102	229	127	1.6	21	3	M090823			
			4.0	11.8	5.0	102	300	127	1.7	22	3	M120598			
			5.0	10.0	5.0	127	254	127	1.5	20	3	M100213			
	ISB	185 to 225	4.0	9.0	5.0	102	229	127	1.0	13	3	M090823			
			4.0	10.0	4.0	102	254	102	2.8	38	3	M100146			
			4.0	11.8	5.0	102	300	127	1.0	14	3	M120598			
			5.0	10.0	5.0	127	254	127	0.9	12	3	M100213			
	ISB	240 to 300	4.0	9.0	5.0	102	229	127	1.4	20	3	M090823			
			4.0	11.8	5.0	102	300	127	1.5	21	3	M120598			
5.0			10.0	5.0	127	254	127	1.3	18	3	M100213				
ISC	225 to 315	4.0	9.0	5.0	102	229	127	1.8	24	3	M090823				
		4.0	11.8	5.0	102	300	127	1.8	25	3	M120598				
		5.0	10.0	5.0	127	254	127	1.6	22	3	M100213				
ISC	330	4.0	9.0	5.0	102	229	127	1.8	25	3	M090823				
		4.0	11.8	5.0	102	300	127	1.9	26	3	M120598				
		5.0	10.0	5.0	127	254	127	1.7	23	3	M100213				
ISC	350	4.0	9.0	5.0	102	229	127	2.0	27	3	M090823				
		4.0	11.8	5.0	102	300	127	2.1	28	3	M120598				
		5.0	10.0	5.0	127	254	127	1.8	25	3	M100213				
ISM	310 to 330	4.0	9.0	5.0	102	229	127	1.8	24	3	M090823				
		4.0	11.8	5.0	102	300	127	1.9	25	3	M120598				
		5.0	10.0	5.0	127	254	127	1.7	23	3	M100213				
ISM	350 to 425	4.0	9.0	5.0	102	229	127	2.7	37	3	M090823				
		4.0	11.8	5.0	102	300	127	2.9	39	3	M120598				
		5.0	10.0	5.0	127	254	127	2.6	35	3	M100213				
ISM	450	4.0	9.0	5.0	102	229	127	2.9	39	3	M090823				
		5.0	10.0	5.0	127	254	127	2.7	36	3	M100213				
ISX	400		5.0	10.0	5.0	127	254	127	2.9	40	3	M100213			
L10	260 to 280	4.0	9.0	5.0	102	229	127	1.2	16	3	M090823				
		4.0	11.8	5.0	102	300	127	1.2	17	3	M120598				
		5.0	10.0	5.0	127	254	127	1.1	15	3	M100213				
L10	300 to 375	4.0	9.0	5.0	102	229	127	1.3	17	3	M090823				
		4.0	11.8	5.0	102	300	127	1.3	18	3	M120598				
		5.0	10.0	5.0	127	254	127	1.2	16	3	M100213				
M11	400	4.0	9.0	5.0	102	229	127	1.8	25	3	M090823				
		4.0	11.8	5.0	102	300	127	1.9	26	3	M120598				
		5.0	10.0	5.0	127	254	127	1.7	23	3	M100213				
NTC	255 to 290	4.0	9.0	5.0	102	229	127	1.6	21	3	M090823				
		4.0	11.8	5.0	102	300	127	1.7	23	3	M120598				
		5.0	10.0	5.0	127	254	127	1.5	20	3	M100213				
NTC	300 to 350	4.0	9.0	5.0	102	229	127	2.6	36	3	M090823				
		4.0	11.8	5.0	102	300	127	2.8	38	3	M120598				
		5.0	10.0	5.0	127	254	127	2.5	33	3	M100213				
 Engine	6BT	230	3.0	11.0	4.0	76	279	102	1.2	16	1	M111029	OE replacement		
			4.0	10.0	4.0	102	254	102	2.0	27	2	M100048	Aftermarket		
			4.0	11.0	4.0	102	279	102	1.9	26	2	M110012			
			4.0	11.0	4.0	102	279	102	1.7	24	2	M110189	OE replacement		
			4.0	11.0	5.0	102	279	127	1.0	14	2	M111028	Inlet dimension is OD		
			4.0	10x15	4.0	102	254x381	102	1.4	20	2	M120100	Aftermarket, shorter than OE		
			4.0	8.3x11.5	4.0	102	211x292	102	1.9	26	2	M090280	Aftermarket, shorter than OE		
			4.0	8.3x11.5	4.0	102	211x292	102	1.8	25	2	M090534	Aftermarket, shorter than OE		
			5.0	10x15	5.0	127	254x381	127	1.1	14	2	M120108	For off-hwy, shorter than OE		
			5.0	10x15	5.0	127	254x381	127	1.1	15	2	M120365	Aftermarket		
			5.0	10x15	5.0	127	254x381	127	1.2	16	2	M120448	OE replacement		
			6CT	250	4.0	8.3x11.5	4.0	102	211x292	102	2.7	37	2	M090280	Aftermarket, shorter than OE
					3.0	11.0	4.0	76	279	102	1.7	23	1	M111029	OE replacement
					4.0	10.0	4.0	102	254	102	2.7	37	2	M100048	Aftermarket
					4.0	11.0	4.0	102	279	102	2.7	36	2	M110012	

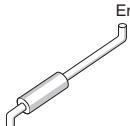
Engine Make & Exhaust System Configuration	Engine Model	Engine H.P.	Muffler Dimensions inches			Muffler Dimensions mm			Backpressure inches of Hg / H ₂ O		Muffler Style & Part No.	Notes	
			Inlet	Body	Outlet	Inlet	Body	Outlet					
	6CT	300	4.0	11.0	4.0	102	279	102	2.4	33	2	M1110189	OE replacement
			4.0	11.0	5.0	102	279	127	1.4	19	2	M111028	Inlet dimension is OD
			4.0	10x15	4.0	102	254x381	102	2.0	27	2	M120100	Aftermarket, shorter than OE
			4.0	8.3x11.5	4.0	102	211x292	102	2.5	34	2	M090534	Aftermarket, shorter than OE
			5.0	10x15	5.0	127	254x381	127	1.5	20	2	M120108	For off-hwy, shorter than OE
			5.0	10x15	5.0	127	254x381	127	1.0	13	2	M120225	For off-hwy, shorter than OE
			5.0	10x15	5.0	127	254x381	127	1.6	21	2	M120365	Aftermarket
			5.0	10x15	5.0	127	254x381	127	1.6	22	2	M120448	OE replacement
			3.0	11.0	4.0	76	279	102	2.4	33	1	M111029	OE replacement
			4.0	11.0	5.0	102	279	127	2.0	27	2	M111028	Inlet dimension is OD
4.0	10x15	4.0	102	254x381	102	2.9	39	2	M120100	Aftermarket, shorter than OE			
5.0	10x15	5.0	127	254x381	127	2.1	29	2	M120108	For off-hwy, shorter than OE			
5.0	10x15	5.0	127	254x381	127	1.4	19	2	M120225	For off-hwy, shorter than OE			
5.0	10x15	5.0	127	254x381	127	2.2	31	2	M120365	Aftermarket			
5.0	10x15	5.0	127	254x381	127	2.3	32	2	M120448	OE replacement			
6.0	10x15	6.0	152	254x381	152	1.2	16	2	M122300	For off-hwy, shorter than OE			
ISB	185 to 225	3.0	11.0	4.0	76	279	102	1.0	14	1	M111029	OE replacement	
		3.5	8.3x11.5	3.5	89	211x292	89	2.8	38	2	M090158		
		3.5	8.5x11.8	3.5	89	216x300	89	2.8	38	2	M090210	Wrapped muffler	
		4.0	10.0	4.0	102	254	102	1.7	23	2	M100048	Aftermarket	
		4.0	11.0	4.0	102	279	102	1.7	23	2	M110012		
		4.0	11.0	4.0	102	279	102	1.5	20	2	M110189	OE replacement	
		4.0	11.0	5.0	102	279	127	0.9	12	2	M111028	Inlet dimension is OD	
		4.0	10.3x15.3	4.0	102	261x389	102	2.6	35	2	M120197	Wrapped muffler, OE	
		4.0	10x15	4.0	102	254x381	102	1.2	17	2	M120100	Aftermarket, shorter than OE	
		4.0	8.3x11.5	4.0	102	211x292	102	1.7	23	2	M090280	Aftermarket, shorter than OE	
		4.0	8.3x11.5	4.0	102	211x292	102	1.6	21	2	M090534	Aftermarket, shorter than OE	
		4.0	8.3x11.5	3.5	102	211x292	89	2.8	37	2	M090538		
		5.0	10x15	5.0	127	254x381	127	0.9	12	2	M120108	For off-hwy, shorter than OE	
		5.0	10x15	5.0	127	254x381	127	1.0	13	2	M120365	Aftermarket	
		5.0	10x15	5.0	127	254x381	127	1.0	14	2	M120448	OE replacement	
ISB	240 to 300	3.0	11.0	4.0	76	279	102	1.5	21	1	M111029	OE replacement	
		4.0	10.0	4.0	102	254	102	2.5	34	2	M100048	Aftermarket	
		4.0	11.0	4.0	102	279	102	2.4	33	2	M110012		
		4.0	11.0	4.0	102	279	102	2.2	30	2	M110189	OE replacement	
		4.0	11.0	5.0	102	279	127	1.3	17	2	M111028	Inlet dimension is OD	
		4.0	10x15	4.0	102	254x381	102	1.8	25	2	M120100	Aftermarket, shorter than OE	
		4.0	8.3x11.5	4.0	102	211x292	102	2.5	34	2	M090280	Aftermarket, shorter than OE	
		4.0	8.3x11.5	4.0	102	211x292	102	2.3	32	2	M090534	Aftermarket, shorter than OE	
		5.0	10x15	5.0	127	254x381	127	1.4	18	2	M120108	For off-hwy, shorter than OE	
		5.0	10x15	5.0	127	254x381	127	1.4	20	2	M120365	Aftermarket	
		5.0	10x15	5.0	127	254x381	127	1.5	20	2	M120448	OE replacement	
		ISC	225 to 240	3.0	11.0	4.0	76	279	102	1.6	22	1	M111029
4.0	10.0			4.0	102	254	102	2.7	36	2	M100048	Aftermarket	
4.0	11.0			4.0	102	279	102	2.6	35	2	M110012		
4.0	11.0			4.0	102	279	102	2.3	32	2	M110189	OE replacement	
4.0	11.0			5.0	102	279	127	1.4	18	2	M111028	Inlet dimension is OD	
4.0	10x15			4.0	102	254x381	102	1.9	26	2	M120100	Aftermarket, shorter than OE	
4.0	8.3x11.5			4.0	102	211x292	102	2.6	35	2	M090280	Aftermarket, shorter than OE	
4.0	8.3x11.5			4.0	102	211x292	102	2.4	33	2	M090534	Aftermarket, shorter than OE	
5.0	10x15			5.0	127	254x381	127	1.4	19	2	M120108	For off-hwy, shorter than OE	
5.0	10x15			5.0	127	254x381	127	1.5	21	2	M120365	Aftermarket	
5.0	10x15			5.0	127	254x381	127	1.6	21	2	M120448	OE replacement	
ISC	260 to 300			3.0	11.0	4.0	76	279	102	1.6	22	1	M111029
		4.0	10.0	4.0	102	254	102	2.7	37	2	M100048	Aftermarket	
		4.0	11.0	4.0	102	279	102	2.6	36	2	M110012		
		4.0	11.0	4.0	102	279	102	2.4	32	2	M110189	OE replacement	
		4.0	11.0	5.0	102	279	127	1.4	19	2	M111028	Inlet dimension is OD	
		4.0	10x15	4.0	102	254x381	102	2.0	27	2	M120100	Aftermarket, shorter than OE	
		4.0	8.3x11.5	4.0	102	211x292	102	2.7	36	2	M090280	Aftermarket, shorter than OE	
		4.0	8.3x11.5	4.0	102	211x292	102	2.5	34	2	M090534	Aftermarket, shorter than OE	
		5.0	10x15	5.0	127	254x381	127	1.5	20	2	M120108	For off-hwy, shorter than OE	
		5.0	10x15	5.0	127	254x381	127	1.5	21	2	M120365	Aftermarket	
		5.0	10x15	5.0	127	254x381	127	1.6	22	2	M120448	OE replacement	

Truck Engine Muffler Application



Engine Make & Exhaust System Configuration	Engine Model	H.P.	Muffler Dimensions						Backpressure		Muffler		Notes			
			inches			mm			inches of Hg	H ₂ O	Style & Part No.					
ISC	315 to 330		3.0	11.0	4.0	76	279	102	2.0	27	1	M111029	OE replacement			
			4.0	11.0	4.0	102	279	102	2.8	39	2	M110189	OE replacement			
			4.0	11.0	5.0	102	279	127	1.6	22	2	M111028	Inlet dimension is OD			
			4.0	10x15	4.0	102	254x381	102	2.4	32	2	M120100	Aftermarket, shorter than OE			
			4.0	8.3x11.5	4.0	102	211x292	102	3.0	40	2	M090534	Aftermarket, shorter than OE			
			5.0	10x15	5.0	127	254x381	127	1.7	24	2	M120108	For off-hwy, shorter than OE			
			5.0	10x15	5.0	127	254x381	127	1.8	25	2	M120365	Aftermarket			
			5.0	10x15	5.0	127	254x381	127	1.9	26	2	M120448	OE replacement			
ISC	350		3.0	11.0	4.0	76	279	102	2.1	28	1	M111029	OE replacement			
			4.0	11.0	5.0	102	279	127	1.8	24	2	M111028	Inlet dimension is OD			
			4.0	10x15	4.0	102	254x381	102	2.5	34	2	M120100	Aftermarket, shorter than OE			
			5.0	10x15	5.0	127	254x381	127	1.9	25	2	M120108	For off-hwy, shorter than OE			
			5.0	10x15	5.0	127	254x381	127	2.0	27	2	M120365	Aftermarket			
			5.0	10x15	5.0	127	254x381	127	2.0	28	2	M120448	OE replacement			
ISM	310 to 330		3.0	11.0	4.0	76	279	102	1.9	26	1	M111029	OE replacement			
			4.0	11.0	4.0	102	279	102	2.7	37	2	M110189	OE replacement			
			4.0	11.0	5.0	102	279	127	1.6	22	2	M111028	Inlet dimension is OD			
			4.0	10x15	4.0	102	254x381	102	2.3	31	2	M120100	Aftermarket, shorter than OE			
			4.0	8.3x11.5	4.0	102	211x292	102	2.9	39	2	M090534	Aftermarket, shorter than OE			
			5.0	10x15	5.0	127	254x381	127	1.7	23	2	M120108	For off-hwy, shorter than OE			
			5.0	10x15	5.0	127	254x381	127	1.8	24	2	M120365	Aftermarket			
			5.0	10x15	5.0	127	254x381	127	1.8	25	2	M120448	OE replacement			
ISM	350 to 450		4.0	11.0	5.0	102	279	127	2.5	35	2	M111028	Inlet dimension is OD			
			5.0	10x15	5.0	127	254x381	127	2.7	37	2	M120108	For off-hwy, shorter than OE			
			5.0	10x15	5.0	127	254x381	127	1.8	24	2	M120225	For off-hwy, shorter than OE			
			5.0	10x15	5.0	127	254x381	127	2.8	39	2	M120365	Aftermarket			
			5.0	10x15	5.0	127	254x381	127	2.9	40	2	M120448	OE replacement			
			6.0	10x15	6.0	152	254x381	152	1.5	20	2	M122300	For off-hwy, shorter than OE			
ISM	500		5.0	10x15	5.0	127	254x381	127	2.0	28	2	M120225	For off-hwy, shorter than OE			
			4.0	11.0	5.0	102	279	127	2.9	40	2	M111028	Inlet dimension is OD			
			6.0	10x15	6.0	152	254x381	152	1.7	23	2	M122300	For off-hwy, shorter than OE			
ISX	400		4.0	11.0	5.0	102	279	127	2.8	38	2	M111028	Inlet dimension is OD			
			5.0	10x15	5.0	127	254x381	127	2.9	40	2	M120108	For off-hwy, shorter than OE			
			5.0	10x15	5.0	127	254x381	127	1.9	26	2	M120225	For off-hwy, shorter than OE			
			6.0	10x15	6.0	152	254x381	152	1.6	22	2	M122300	For off-hwy, shorter than OE			
ISX	450 to 500		5.0	10x15	5.0	127	254x381	127	2.7	37	2	M120225	For off-hwy, shorter than OE			
			6.0	10x15	6.0	152	254x381	152	2.2	30	2	M122300	For off-hwy, shorter than OE			
ISX	600		6.0	10x15	6.0	152	254x381	152	3.0	40	2	M122300	For off-hwy, shorter than OE			
L10	260 to 280		3.0	11.0	4.0	76	279	102	1.2	17	1	M111029	OE replacement			
			4.0	10.0	4.0	102	254	102	2.0	28	2	M100048	Aftermarket			
			4.0	11.0	4.0	102	279	102	2.0	27	2	M110012				
			4.0	11.0	4.0	102	279	102	1.8	24	2	M110189	OE replacement			
			4.0	11.0	5.0	102	279	127	1.0	14	2	M111028	Inlet dimension is OD			
			4.0	10x15	4.0	102	254x381	102	1.5	20	2	M120100	Aftermarket, shorter than OE			
			4.0	8.3x11.5	4.0	102	211x292	102	2.0	27	2	M090280	Aftermarket, shorter than OE			
			4.0	8.3x11.5	4.0	102	211x292	102	1.9	26	2	M090534	Aftermarket, shorter than OE			
			5.0	10x15	5.0	127	254x381	127	1.1	15	2	M120108	For off-hwy, shorter than OE			
			5.0	10x15	5.0	127	254x381	127	1.2	16	2	M120365	Aftermarket			
			5.0	10x15	5.0	127	254x381	127	1.2	16	2	M120448	OE replacement			
L10	300 to 375		3.0	11.0	4.0	76	279	102	1.3	18	1	M111029	OE replacement			
			4.0	10.0	4.0	102	254	102	2.2	30	2	M100048	Aftermarket			
			4.0	11.0	4.0	102	279	102	2.1	29	2	M110012				
			4.0	11.0	4.0	102	279	102	1.9	26	2	M110189	OE replacement			
			4.0	11.0	5.0	102	279	127	1.1	15	2	M111028	Inlet dimension is OD			
			4.0	10x15	4.0	102	254x381	102	1.6	22	2	M120100	Aftermarket, shorter than OE			
			4.0	8.3x11.5	4.0	102	211x292	102	2.2	30	2	M090280	Aftermarket, shorter than OE			
			4.0	8.3x11.5	4.0	102	211x292	102	2.0	28	2	M090534	Aftermarket, shorter than OE			
			5.0	10x15	5.0	127	254x381	127	1.2	16	2	M120108	For off-hwy, shorter than OE			
			5.0	10x15	5.0	127	254x381	127	1.3	17	2	M120365	Aftermarket			
			5.0	10x15	5.0	127	254x381	127	1.3	18	2	M120448	OE replacement			
			M11	400		3.0	11.0	4.0	76	279	102	1.9	26	1	M111029	OE replacement
						4.0	11.0	4.0	102	279	102	2.8	38	2	M110189	OE replacement
4.0	11.0	5.0				102	279	127	1.6	22	2	M111028	Inlet dimension is OD			
4.0	10x15	4.0				102	254x381	102	2.3	31	2	M120100	Aftermarket, shorter than OE			

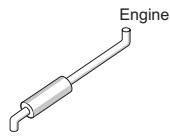

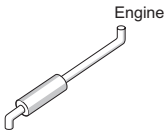
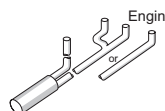
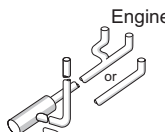
Engine Make & Exhaust System Configuration	Engine Model	H.P.	Muffler Dimensions inches			Muffler Dimensions mm			Backpressure inches of Hg / H ₂ O		Muffler Style & Part No.	Notes			
			Inlet	Body	Outlet	Inlet	Body	Outlet							
	N14	330	4.0	8.3x11.5	4.0	102	211x292	102	2.9	40	2	M090534	Aftermarket, shorter than OE		
			5.0	10x15	5.0	127	254x381	127	1.7	23	2	M120108	For off-hwy, shorter than OE		
			5.0	10x15	5.0	127	254x381	127	1.8	24	2	M120365	Aftermarket		
			5.0	10x15	5.0	127	254x381	127	1.9	25	2	M120448	OE replacement		
	N14	350 to 460	3.0	11.0	4.0	76	279	102	2.7	37	1	M111029	OE replacement		
			4.0	11.0	5.0	102	279	127	2.3	31	2	M111028	Inlet dimension is OD		
			5.0	10x15	5.0	127	254x381	127	1.6	22	2	M120225	For off-hwy, shorter than OE		
			6.0	10x15	6.0	152	254x381	152	1.3	18	2	M122300	For off-hwy, shorter than OE		
	N14	500 to 550	6.0	10x15	6.0	152	254x381	152	2.8	38	2	M122300	For off-hwy, shorter than OE		
	NTC	255 to 290	3.0	11.0	4.0	76	279	102	1.7	23	1	M111029	OE replacement		
4.0			10.0	4.0	102	254	102	2.8	37	2	M100048	Aftermarket			
4.0			11.0	4.0	102	279	102	2.7	36	2	M110012				
4.0			11.0	4.0	102	279	102	2.4	33	2	M110189	OE replacement			
4.0			11.0	5.0	102	279	127	1.4	19	2	M111028	Inlet dimension is OD			
4.0			10x15	4.0	102	254x381	102	2.0	27	2	M120100	Aftermarket, shorter than OE			
4.0			8.3x11.5	4.0	102	211x292	102	2.7	37	2	M090280	Aftermarket, shorter than OE			
4.0			8.3x11.5	4.0	102	211x292	102	2.5	34	2	M090534	Aftermarket, shorter than OE			
5.0			10x15	5.0	127	254x381	127	1.5	20	2	M120108	For off-hwy, shorter than OE			
5.0			10x15	5.0	127	254x381	127	1.6	21	2	M120365	Aftermarket			
5.0			10x15	5.0	127	254x381	127	1.6	22	2	M120448	OE replacement			
NTC			300 to 350	3.0	11.0	4.0	76	279	102	2.8	38	1	M111029	OE replacement	
				4.0	11.0	5.0	102	279	127	2.3	32	2	M111028	Inlet dimension is OD	
	5.0	10x15		5.0	127	254x381	127	2.5	34	2	M120108	For off-hwy, shorter than OE			
	5.0	10x15		5.0	127	254x381	127	2.6	36	2	M120365	Aftermarket			
	5.0	10x15		5.0	127	254x381	127	2.7	37	2	M120448	OE replacement			
Signature	500 to 565	5.0	10x15	5.0	127	254x381	127	2.8	38	2	M120225	For off-hwy, shorter than OE			
		6.0	10x15	6.0	152	254x381	152	2.3	32	2	M122300	For off-hwy, shorter than OE			
Signature	600	6.0	10x15	6.0	152	254x381	152	2.6	36	2	M122300	For off-hwy, shorter than OE			
	ISM	310 to 350	5.0	10x15	5.0	127	254x381	127	1.4	19	5	M120131	For off-hwy, shorter than OE		
			5.0	10x15	5.0	127	254x381	127	2.8	38	5	M120176	Aftermarket, shorter than OE		
			5.0	10x15	5.0	127	254x381	127	2.8	38	5	M120189	Aftermarket, shorter than OE		
			5.0	10x15	5.0	127	254x381	127	1.7	23	5	M120450	OE replacement		
ISM	400 to 500	5.0	10x15	5.0	127	254x381	127	2.0	28	5	M120131	For off-hwy, shorter than OE			
		5.0	10x15	5.0	127	254x381	127	2.4	32	5	M120450	OE replacement			
ISX	400 to 475	5.0	10x15	5.0	127	254x381	127	2.5	34	5	M120131	For off-hwy, shorter than OE			
		5.0	10x15	5.0	127	254x381	127	2.9	40	5	M120450	OE replacement			
ISX	500	5.0	10x15	5.0	127	254x381	127	2.7	37	5	M120131	For off-hwy, shorter than OE			
M11	400	5.0	10x15	5.0	127	254x381	127	1.1	15	5	M120131	For off-hwy, shorter than OE			
		5.0	10x15	5.0	127	254x381	127	2.2	30	5	M120176	Aftermarket, shorter than OE			
		5.0	10x15	5.0	127	254x381	127	2.2	30	5	M120189	Aftermarket, shorter than OE			
		5.0	10x15	5.0	127	254x381	127	1.3	18	5	M120450	OE replacement			
N14	330 to 400	5.0	10x15	5.0	127	254x381	127	2.4	33	5	M120131	For off-hwy, shorter than OE			
		5.0	10x15	5.0	127	254x381	127	2.9	39	5	M120450	OE replacement			
N14	435 to 460	5.0	10x15	5.0	127	254x381	127	2.8	38	5	M120131	For off-hwy, shorter than OE			
NTC	400	5.0	10x15	5.0	127	254x381	127	2.9	40	5	M120131	For off-hwy, shorter than OE			
Signature	500	5.0	10x15	5.0	127	254x381	127	2.5	34	5	M120131	For off-hwy, shorter than OE			
		5.0	10x15	5.0	127	254x381	127	3.0	40	5	M120450	OE replacement			
Signature	565	5.0	10x15	5.0	127	254x381	127	2.8	38	5	M120131	For off-hwy, shorter than OE			
	6BT	230	4.0	10.0	4.0	102	254	102	2.0	28	4	M100052			
			4.0	11.0	4.0	102	279	102	1.7	23	4	M110112			
			4.0	11.0	4.0	102	279	102	1.7	23	4	M110148			
			4.0	11.0	4.0	102	279	102	1.7	23	4	M110311	Inlet dimension is OD		
			4.0	11.0	4.0	102	279	102	1.5	20	4	M111025	Inlet & outlet dimension is OD		
			4.0	10x15	4.0	102	254x381	102	2.0	27	4	M120367	Aftermarket, shorter than OE		
			5.0	11.0	5.0	127	279	127	1.0	13	4	M110014	OE replacement		
			5.0	10x15	5.0	127	254x381	127	1.0	14	4	M120366	OE replacement		
			6CT	250	4.0	10.0	4.0	102	254	102	2.8	38	4	M100052	
					4.0	11.0	4.0	102	279	102	2.3	32	4	M110112	
4.0	11.0	4.0			102	279	102	2.3	32	4	M110148				
4.0	11.0	4.0			102	279	102	2.3	32	4	M110311	Inlet dimension is OD			
4.0	11.0	4.0			102	279	102	2.1	28	4	M111025	Inlet & outlet dimension is OD			
4.0	10x15	4.0			102	254x381	102	2.7	37	4	M120367	Aftermarket, shorter than OE			

Truck Engine Muffler Application

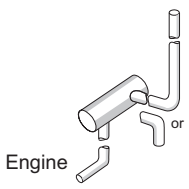
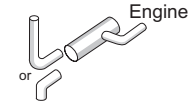

Engine Make & Exhaust System Configuration		Engine Model	H.P.	Muffler Dimensions						Backpressure		Muffler		Notes
				inches			mm			inches of Hg		Style & Part No.		
				Inlet	Body	Outlet	Inlet	Body	Outlet	H _g	H ₂ O			
	6CT	300		5.0	11.0	5.0	127	279	127	1.3	18	4	M110014	OE replacement
				5.0	10x15	5.0	127	254x381	127	1.4	19	4	M120366	OE replacement
	ISB	185 to 225		4.0	11.0	4.0	102	279	102	3.0	40	4	M111025	Inlet & outlet dimension is OD
				5.0	11.0	5.0	127	279	127	1.9	26	4	M110014	OE replacement
				5.0	10x15	5.0	127	254x381	127	2.0	27	4	M120366	OE replacement
				4.0	10.0	4.0	102	254	102	1.8	24	4	M100052	
				4.0	11.0	4.0	102	279	102	1.5	20	4	M110112	
				4.0	11.0	4.0	102	279	102	1.5	20	4	M110148	
				4.0	11.0	4.0	102	279	102	1.5	20	4	M110311	Inlet dimension is OD
	ISB	240 to 300		4.0	11.0	4.0	102	279	102	1.3	17	4	M111025	Inlet & outlet dimension is OD
			4.0	10x15	4.0	102	254x381	102	1.7	23	4	M120367	Aftermarket, shorter than OE	
			5.0	11.0	5.0	127	279	127	0.8	11	4	M110014	OE replacement	
			5.0	10x15	5.0	127	254x381	127	0.9	12	4	M120366	OE replacement	
			4.0	10.0	4.0	102	254	102	2.6	35	4	M100052		
			4.0	11.0	4.0	102	279	102	2.1	29	4	M110112		
			4.0	11.0	4.0	102	279	102	2.1	29	4	M110148		
ISC	225 to 240		4.0	11.0	4.0	102	279	102	2.1	29	4	M110311	Inlet dimension is OD	
			4.0	11.0	4.0	102	279	102	1.9	26	4	M111025	Inlet & outlet dimension is OD	
			4.0	10x15	4.0	102	254x381	102	2.5	34	4	M120367	Aftermarket, shorter than OE	
			5.0	11.0	5.0	127	279	127	1.2	17	4	M110014	OE replacement	
			5.0	10x15	5.0	127	254x381	127	1.3	17	4	M120366	OE replacement	
			4.0	10.0	4.0	102	254	102	2.7	37	4	M100052		
			4.0	11.0	4.0	102	279	102	2.3	31	4	M110112		
			4.0	11.0	4.0	102	279	102	2.3	31	4	M110148		
			4.0	11.0	4.0	102	279	102	2.3	31	4	M110311	Inlet dimension is OD	
ISC	260 to 300		4.0	11.0	4.0	102	279	102	2.0	27	4	M111025	Inlet & outlet dimension is OD	
			4.0	10x15	4.0	102	254x381	102	2.7	36	4	M120367	Aftermarket, shorter than OE	
			5.0	11.0	5.0	127	279	127	1.4	19	4	M110014	OE replacement	
			5.0	10x15	5.0	127	254x381	127	1.5	20	4	M120366	OE replacement	
			4.0	11.0	4.0	102	279	102	2.5	34	4	M110112		
			4.0	11.0	4.0	102	279	102	2.5	34	4	M110148		
			4.0	11.0	4.0	102	279	102	2.5	34	4	M110311	Inlet dimension is OD	
			4.0	11.0	4.0	102	279	102	2.2	30	4	M111025	Inlet & outlet dimension is OD	
ISC	315 to 350		4.0	10x15	4.0	102	254x381	102	2.9	40	4	M120367	Aftermarket, shorter than OE	
			5.0	11.0	5.0	127	279	127	1.4	19	4	M110014	OE replacement	
			5.0	10x15	5.0	127	254x381	127	1.5	20	4	M120366	OE replacement	
			4.0	11.0	4.0	102	279	102	2.9	40	4	M110112		
			4.0	11.0	4.0	102	279	102	2.9	40	4	M110148		
			4.0	11.0	4.0	102	279	102	2.9	40	4	M110311	Inlet dimension is OD	
			4.0	11.0	4.0	102	279	102	2.6	35	4	M111025	Inlet & outlet dimension is OD	
			5.0	11.0	5.0	127	279	127	1.7	23	4	M110014	OE replacement	
L10	260 to 300		5.0	10x15	5.0	127	254x381	127	1.8	24	4	M120366	OE replacement	
			4.0	10.0	4.0	102	254	102	2.3	31	4	M100052		
			4.0	11.0	4.0	102	279	102	1.9	26	4	M110112		
			4.0	11.0	4.0	102	279	102	1.9	26	4	M110148		
			4.0	11.0	4.0	102	279	102	1.9	26	4	M110311	Inlet dimension is OD	
			4.0	11.0	4.0	102	279	102	1.7	22	4	M111025	Inlet & outlet dimension is OD	
			4.0	10x15	4.0	102	254x381	102	2.2	30	4	M120367	Aftermarket, shorter than OE	
			5.0	11.0	5.0	127	279	127	1.1	15	4	M110014	OE replacement	
NTC	255 to 290		5.0	10x15	5.0	127	254x381	127	1.1	15	4	M120366	OE replacement	
			4.0	10.0	4.0	102	254	102	2.8	39	4	M100052		
			4.0	11.0	4.0	102	279	102	2.3	32	4	M110112		
			4.0	11.0	4.0	102	279	102	2.3	32	4	M110148		
			4.0	11.0	4.0	102	279	102	2.3	32	4	M110311	Inlet dimension is OD	
			4.0	11.0	4.0	102	279	102	2.1	28	4	M111025	Inlet & outlet dimension is OD	
			4.0	10x15	4.0	102	254x381	102	2.7	37	4	M120367	Aftermarket, shorter than OE	
			5.0	11.0	5.0	127	279	127	1.3	18	4	M110014	OE replacement	
NTC	300 to 350		5.0	10x15	5.0	127	254x381	127	1.4	19	4	M120366	OE replacement	
			5.0	11.0	5.0	127	279	127	2.5	34	4	M110014	OE replacement	
6BT	230		5.0	10x15	5.0	127	254x381	127	2.6	36	4	M120366	OE replacement	
			4.0	10.0	4.0	102	254	102	2.1	28	6	M100572		
			4.0	11.0	4.0	102	279	102	1.6	22	6	M111026	Outlet dimension is OD	
6CT	250		5.0	10x15	5.0	127	254x381	127	1.1	14	4	M120418	For off-hwy, shorter than OE	
			4.0	10.0	4.0	102	254	102	2.9	39	6	M100572		
			4.0	11.0	4.0	102	279	102	2.2	31	6	M111026	Outlet dimension is OD	
6CT	300		5.0	10x15	5.0	127	254x381	127	1.5	20	6	M120418	For off-hwy, shorter than OE	
			5.0	11.0	5.0	127	279	127	2.1	29	6	M120418	For off-hwy, shorter than OE	

Engine Make & Exhaust System Configuration	Engine Model	H.P.	Muffler Dimensions						Backpressure		Muffler Style & Part No.	Notes	
			inches			mm			inches of Hg	H ₂ O			
			Inlet	Body	Outlet	Inlet	Body	Outlet					
	ISB	185 to 225	4.0	10.0	4.0	102	254	102	1.8	25	6	M100572	
			4.0	11.0	4.0	102	279	102	1.4	19	6	M111026	Outlet dimension is OD
			5.0	10x15	5.0	127	254x381	127	0.9	12	6	M120418	For off-hwy, shorter than OE
	ISB	240 to 300	4.0	10.0	4.0	102	254	102	2.7	36	6	M100572	
			4.0	11.0	4.0	102	279	102	2.1	28	6	M111026	Outlet dimension is OD
			5.0	10x15	5.0	127	254x381	127	1.3	18	6	M120418	For off-hwy, shorter than OE
	ISC	225 to 240	4.0	10.0	4.0	102	254	102	2.8	38	6	M100572	
			4.0	11.0	4.0	102	279	102	2.2	30	6	M111026	Outlet dimension is OD
			5.0	10x15	5.0	127	254x381	127	1.4	19	6	M120418	For off-hwy, shorter than OE
	ISC	260 to 300	4.0	10.0	4.0	102	254	102	2.9	39	6	M100572	
			4.0	11.0	4.0	102	279	102	2.2	30	6	M111026	Outlet dimension is OD
			5.0	10x15	5.0	127	254x381	127	1.4	20	6	M120418	For off-hwy, shorter than OE
ISC	315 to 350	4.0	11.0	4.0	102	279	102	2.8	38	6	M111026	Outlet dimension is OD	
		5.0	10x15	5.0	127	254x381	127	1.8	25	6	M120418	For off-hwy, shorter than OE	
L10	260 to 300	4.0	10.0	4.0	102	254	102	2.3	32	6	M100572		
		4.0	11.0	4.0	102	279	102	1.8	25	6	M111026	Outlet dimension is OD	
		5.0	10x15	5.0	127	254x381	127	1.2	16	6	M120418	For off-hwy, shorter than OE	
NTC	255 to 290	4.0	10.0	4.0	102	254	102	2.9	40	6	M100572		
		4.0	11.0	4.0	102	279	102	2.3	31	6	M111026	Outlet dimension is OD	
		5.0	10x15	5.0	127	254x381	127	1.5	20	6	M120418	For off-hwy, shorter than OE	
NTC	300 to 350	5.0	10x15	5.0	127	254x381	127	2.7	37	6	M120418	For off-hwy, shorter than OE	
6BT	230	4.0	11.0	4.0	102	279	102	2.2	30	3	M110479		
		4.0	11.0	4.0	102	279	102	2.0	28	3	M110674	Band clamp on inlet	
		4.0	11.0		102	279		2.0	27	3	M111024	Outlet has down spout	
		5.0	10x15	5.0	127	254x381	127	1.3	18	3	M120235	OE replacement	
6CT	250	4.0	11.0	4.0	102	279	102	2.8	39	3	M110674	Band clamp on inlet	
		4.0	11.0		102	279		2.8	37	3	M111024	Outlet has down spout	
		5.0	10x15	5.0	127	254x381	127	1.8	25	3	M120235	OE replacement	
6CT	300	5.0	10x15	5.0	127	254x381	127	2.6	36	3	M120235	OE replacement	
	ISB	185 to 225	4.0	11.0	4.0	102	279	102	1.9	26	3	M110479	
			4.0	11.0	4.0	102	279	102	1.8	24	3	M110674	Band clamp on inlet
			4.0	11.0		102	279		1.7	23	3	M111024	Outlet has down spout
			5.0	10x15	5.0	127	254x381	127	1.1	15	3	M120235	OE replacement
ISB	240 to 275	4.0	11.0	4.0	102	279	102	2.8	38	3	M110479		
		4.0	11.0	4.0	102	279	102	2.5	35	3	M110674	Band clamp on inlet	
		4.0	11.0		102	279		2.5	34	3	M111024	Outlet has down spout	
		5.0	10x15	5.0	127	254x381	127	1.6	22	3	M120235	OE replacement	
ISB	300	4.0	11.0	4.0	102	279	102	2.8	39	3	M110479		
		4.0	11.0	4.0	102	279	102	2.6	36	3	M110674	Band clamp on inlet	
		4.0	11.0		102	279		2.5	34	3	M111024	Outlet has down spout	
		5.0	10x15	5.0	127	254x381	127	1.7	23	3	M120235	OE replacement	
ISC	225	4.0	11.0	4.0	102	279	102	2.8	38	3	M110479		
		4.0	11.0	4.0	102	279	102	2.5	35	3	M110674	Band clamp on inlet	
		4.0	11.0		102	279		2.5	34	3	M111024	Outlet has down spout	
		5.0	10x15	5.0	127	254x381	127	1.6	22	3	M120235	OE replacement	
ISC	240	4.0	11.0	4.0	102	279	102	2.7	37	3	M110674	Band clamp on inlet	
		4.0	11.0		102	279		2.7	36	3	M111024	Outlet has down spout	
		5.0	10x15	5.0	127	254x381	127	1.8	24	3	M120235	OE replacement	
ISC	260	4.0	11.0		102	279		2.9	40	3	M111024	Outlet has down spout	
		5.0	10x15	5.0	127	254x381	127	1.9	26	3	M120235	OE replacement	
ISC	285	4.0	11.0	4.0	102	279	102	3.0	40	3	M110479		
		4.0	11.0	4.0	102	279	102	2.7	37	3	M110674	Band clamp on inlet	
		4.0	11.0		102	279		2.7	36	3	M111024	Outlet has down spout	
		5.0	10x15	5.0	127	254x381	127	1.8	24	3	M120235	OE replacement	
ISC	300	4.0	11.0	4.0	102	279	102	2.8	38	3	M110674	Band clamp on inlet	
		4.0	11.0		102	279		2.7	37	3	M111024	Outlet has down spout	
		5.0	10x15	5.0	127	254x381	127	1.8	24	3	M120235	OE replacement	

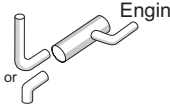
Engine Make & Exhaust System Configuration	Engine Model	H.P.	Muffler Dimensions						Backpressure		Muffler Style & Part No.	Notes	
			inches			mm			inches of Hg	H ₂ O			
 Engine	ISC	315	5.0	10x15	5.0	127	254x381	127	2.0	28	3	M120235	OE replacement
	ISC	330	5.0	10x15	5.0	127	254x381	127	2.1	29	3	M120235	OE replacement
	ISC	350	5.0	10x15	5.0	127	254x381	127	2.3	31	3	M120235	OE replacement
L10	260 to 300	4.0	11.0	4.0	102	279	102	2.5	34	3	M110479		
		4.0	11.0	4.0	102	279	102	2.3	31	3	M110674	Band clamp on inlet	
		4.0	11.0		102	279		2.2	30	3	M111024	Outlet has down spout	
		5.0	10x15	5.0	127	254x381	127	1.5	20	3	M120235	OE replacement	
NTC	255 to 290	4.0	11.0	4.0	102	279	102	2.3	31	3	M110479		
		4.0	11.0	4.0	102	279	102	2.1	28	3	M110674	Band clamp on inlet	
		4.0	11.0		102	279		2.0	27	3	M111024	Outlet has down spout	
		5.0	10x15	5.0	127	254x381	127	1.3	18	3	M120235	OE replacement	
NTC	335	5.0	10x15	5.0	127	254x381	127	2.8	38	3	M120235	OE replacement	

Detroit Diesel

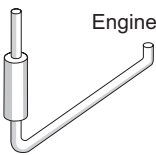

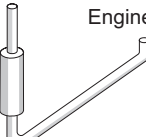
 Engine	8V-92T	430	4.0	8.5	4.0	102	216	102	2.4	33	1	M085171	
			5.0	9.0	5.0	127	229	127	2.9	40	1	M090074	
			5.0	9.0	5.0	127	229	127	1.6	21	1	M090535	Low backpressure, off-hwy
			5.0	10.0	5.0	127	254	127	1.6	21	1	M100463	Low backpressure, off-hwy
			5.0	10.0	5.0	127	254	127	2.6	36	1	M100944	OE replacement for higher HP
			5.0	10.0	5.0	127	254	127	2.9	40	1	M101158	Silent Partner Stainless
			5.0	10.0	5.0	127	254	127	2.9	40	1	M101181	Silent Partner Aluminized
			5.0	11.0	5.0	127	279	127	2.6	35	1	M110849	
8V-92TT	365	4.0	8.5	4.0	102	216	102	2.9	39	1	M085171		
		5.0	9.0	5.0	127	229	127	1.9	25	1	M090535	Low backpressure, off-hwy	
		5.0	10.0	5.0	127	254	127	1.9	25	1	M100463	Low backpressure, off-hwy	
8V-92TTA	445	4.0	8.5	4.0	102	216	102	2.7	36	1	M085171		
		5.0	9.0	5.0	127	229	127	1.7	23	1	M090535	Low backpressure, off-hwy	
		5.0	10.0	5.0	127	254	127	1.7	23	1	M100463	Low backpressure, off-hwy	
		5.0	10.0	5.0	127	254	127	2.9	39	1	M100944	OE replacement for higher HP	
		5.0	11.0	5.0	127	279	127	2.9	39	1	M110849		
Series 60 (12.7 Ltr)	350 to 400	4.0	8.5	4.0	102	216	102	1.9	26	1	M085171		
		4.0	9.0	5.0	102	229	127	2.7	37	1	M090781		
		5.0	9.0	5.0	127	229	127	2.3	31	1	M090074		
		5.0	9.0	5.0	127	229	127	1.2	17	1	M090535	Low backpressure, off-hwy	
		5.0	10.0	5.0	127	254	127	1.2	17	1	M100463	Low backpressure, off-hwy	
		5.0	10.0	5.0	127	254	127	0.8	11	1	M100465	Best value, most popular	
		5.0	10.0	5.0	127	254	127	2.6	35	1	M100580	OE replacement	
		5.0	10.0	5.0	127	254	127	2.8	38	1	M100807	60" (1524mm) Long Body	
		5.0	10.0	5.0	127	254	127	2.1	28	1	M100944	OE replacement for higher HP	
		5.0	10.0	5.0	127	254	127	2.5	34	1	M101158	Silent Partner Stainless	
		5.0	10.0	5.0	127	254	127	2.5	34	1	M101181	Silent Partner Aluminized	
		5.0	10.0	5.0	127	254	127	2.6	35	1	M101263	Freightliner only	
		5.0	11.0	5.0	127	279	127	2.1	28	1	M110849		
		Series 60 (12.7 Ltr)	430	4.0	8.5	4.0	102	216	102	2.1	28	1	M085171
5.0	9.0			5.0	127	229	127	2.5	34	1	M090074		
5.0	9.0			5.0	127	229	127	1.3	18	1	M090535	Low backpressure, off-hwy	
5.0	10.0			5.0	127	254	127	1.3	18	1	M100463	Low backpressure, off-hwy	
5.0	10.0			5.0	127	254	127	0.9	12	1	M100465	Best value, most popular	
5.0	10.0			5.0	127	254	127	2.8	39	1	M100580	OE replacement	
5.0	10.0			5.0	127	254	127	2.3	31	1	M100944	OE replacement for higher HP	
5.0	10.0			5.0	127	254	127	2.7	37	1	M101158	Silent Partner Stainless	
5.0	10.0			5.0	127	254	127	2.7	37	1	M101181	Silent Partner Aluminized	
5.0	10.0			5.0	127	254	127	2.8	39	1	M101263	Freightliner only	
5.0	11.0			5.0	127	279	127	2.2	31	1	M110849		
Series 60 (12.7 Ltr)	470 to 500	4.0	8.5	4.0	102	216	102	2.5	33	1	M085171		
		5.0	9.0	5.0	127	229	127	3.0	40	1	M090074		
		5.0	9.0	5.0	127	229	127	1.6	21	1	M090535	Low backpressure, off-hwy	
		5.0	10.0	5.0	127	254	127	1.6	21	1	M100463	Low backpressure, off-hwy	
		5.0	10.0	5.0	127	254	127	2.7	36	1	M100944	OE replacement for higher HP	
		5.0	11.0	5.0	127	279	127	2.6	36	1	M110849		
Series 60 (14 Ltr)	550 to 575	5.0	9.0	5.0	127	229	127	2.0	27	1	M090535	Low backpressure, off-hwy	
		5.0	10.0	5.0	127	254	127	2.0	27	1	M100463	Low backpressure, off-hwy	
Series 60 (12.7 Ltr)	Cruise Power 330/350 & 370/430	4.0	8.5	4.0	102	216	102	2.1	28	1	M085171		
		5.0	9.0	5.0	127	229	127	2.5	34	1	M090074		
		5.0	9.0	5.0	127	229	127	1.3	18	1	M090535	Low backpressure, off-hwy	
		5.0	10.0	5.0	127	254	127	1.3	18	1	M100463	Low backpressure, off-hwy	
		5.0	10.0	5.0	127	254	127	0.9	12	1	M100465	Best value, most popular	

Engine Make & Exhaust System Configuration	Engine Model	H.P.	Muffler Dimensions inches			Muffler Dimensions mm			Backpressure inches of Hg H ₂ O		Muffler Style & Part No.	Notes	
			Inlet	Body	Outlet	Inlet	Body	Outlet					
Series 60 (12.7 Ltr)	Cruise Power 430/470		5.0	10.0	5.0	127	254	127	2.8	39	1	M100580	OE replacement
			5.0	10.0	5.0	127	254	127	2.3	31	1	M100944	OE replacement for higher HP
			5.0	10.0	5.0	127	254	127	2.7	37	1	M101158	Silent Partner Stainless
			5.0	10.0	5.0	127	254	127	2.7	37	1	M101181	Silent Partner Aluminized
			5.0	10.0	5.0	127	254	127	2.8	39	1	M101263	Freightliner only
			5.0	11.0	5.0	127	279	127	2.2	31	1	M110849	
			4.0	8.5	4.0	102	216	102	2.2	30	1	M085171	
			5.0	9.0	5.0	127	229	127	2.6	36	1	M090074	
			5.0	9.0	5.0	127	229	127	1.4	19	1	M090535	Low backpressure, off-hwy
			5.0	10.0	5.0	127	254	127	1.4	19	1	M100463	Low backpressure, off-hwy
			5.0	10.0	5.0	127	254	127	0.9	12	1	M100465	Best value, most popular
			5.0	10.0	5.0	127	254	127	2.9	40	1	M100580	OE replacement
			5.0	10.0	5.0	127	254	127	2.4	32	1	M100944	OE replacement for higher HP
			5.0	10.0	5.0	127	254	127	2.9	39	1	M101158	Silent Partner Stainless
			5.0	10.0	5.0	127	254	127	2.9	39	1	M101181	Silent Partner Aluminized
			5.0	10.0	5.0	127	254	127	2.9	40	1	M101263	Freightliner only
			5.0	11.0	5.0	127	279	127	2.4	32	1	M110849	
			Series 60 (12.7 Ltr)	Cruise Power 470/500		4.0	8.5	4.0	102	216	102	2.5	33
5.0	9.0	5.0				127	229	127	3.0	40	1	M090074	
5.0	9.0	5.0				127	229	127	1.6	21	1	M090535	Low backpressure, off-hwy
5.0	10.0	5.0				127	254	127	1.6	21	1	M100463	Low backpressure, off-hwy
5.0	10.0	5.0				127	254	127	2.7	36	1	M100944	OE replacement for higher HP
8V-92T	430		4.0	9.0	4.0	102	229	102	2.6	35	1	M090544	
			4.0	10.0	4.0	102	254	102	2.8	37	1	M100466	
			5.0	11.0	5.0	127	279	127	1.8	25	1	M110849	
8V-92TA	435		4.0	9.0	4.0	102	229	102	2.1	28	1	M090544	
			4.0	10.0	4.0	102	254	102	2.2	30	1	M100466	
			5.0	10.0	5.0	127	254	127	2.7	37	1	M101159	Silent Partner Stainless
			5.0	10.0	5.0	127	254	127	2.7	37	1	M101182	Silent Partner Aluminized
			5.0	11.0	5.0	127	279	127	1.5	20	1	M110849	
8V-92TT	365		4.0	9.0	4.0	102	229	102	1.7	23	1	M090544	
			4.0	10.0	4.0	102	254	102	1.8	25	1	M100466	
			5.0	10.0	5.0	127	254	127	2.2	30	1	M100582	OE replacement
			4.0	10.0	5.0	102	254	127	2.9	39	1	M100695	
			5.0	10.0	5.0	127	254	127	2.2	30	1	M101159	Silent Partner Stainless
			5.0	10.0	5.0	127	254	127	2.2	30	1	M101182	Silent Partner Aluminized
8V-92TTA	445		4.0	9.0	4.0	102	229	102	1.6	22	1	M090544	
			4.0	10.0	4.0	102	254	102	1.7	23	1	M100466	
			5.0	10.0	5.0	127	254	127	2.1	28	1	M100582	OE replacement
			4.0	10.0	5.0	102	254	127	2.7	36	1	M100695	
			5.0	10.0	5.0	127	254	127	2.1	28	1	M101159	Silent Partner Stainless
			5.0	10.0	5.0	127	254	127	2.1	28	1	M101182	Silent Partner Aluminized
Series 60 (12.7 Ltr)	330 to 400		4.0	9.0	4.0	102	229	102	1.1	15	1	M090544	
			4.0	10.3	4.0	102	262	102	2.3	31	1	M100464	Wrapped muffler
			4.0	10.0	4.0	102	254	102	1.2	16	1	M100466	
			4.0	10.0	5.0	102	254	127	1.9	26	1	M100695	
			5.0	10.0	5.0	127	254	127	1.5	20	1	M100582	OE replacement
			5.0	10.0	5.0	127	254	127	1.5	20	1	M101159	Silent Partner Stainless
			5.0	10.0	5.0	127	254	127	1.5	20	1	M101182	Silent Partner Aluminized
			5.0	11.0	5.0	127	279	127	0.8	11	1	M110849	
Series 60 (12.7 Ltr)	430		4.0	9.0	4.0	102	229	102	1.2	17	1	M090544	
			4.0	10.3	4.0	102	262	102	2.5	34	1	M100464	Wrapped muffler
			4.0	10.0	4.0	102	254	102	1.3	18	1	M100466	
			4.0	10.0	5.0	102	254	127	2.1	28	1	M100695	
			5.0	10.0	5.0	127	254	127	1.6	22	1	M100582	OE replacement
			5.0	10.0	5.0	127	254	127	1.6	22	1	M101159	Silent Partner Stainless
			5.0	10.0	5.0	127	254	127	1.6	22	1	M101182	Silent Partner Aluminized
			5.0	11.0	5.0	127	279	127	0.9	12	1	M110849	
Series 60 (12.7 Ltr)	470 to 500		4.0	9.0	4.0	102	229	102	1.5	20	1	M090544	
			4.0	10.3	4.0	102	262	102	2.9	39	1	M100464	Wrapped muffler
			4.0	10.0	4.0	102	254	102	1.5	21	1	M100466	
			4.0	10.0	5.0	102	254	127	2.5	33	1	M100695	
			5.0	10.0	5.0	127	254	127	1.9	26	1	M100582	OE replacement
			5.0	10.0	5.0	127	254	127	1.9	26	1	M101159	Silent Partner Stainless
			5.0	10.0	5.0	127	254	127	1.9	26	1	M101182	Silent Partner Aluminized
			5.0	11.0	5.0	127	279	127	1.0	14	1	M110849	

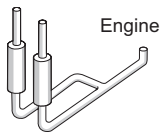

Truck Engine Muffler Application

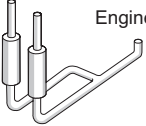
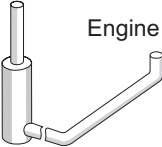
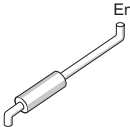
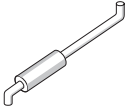

Engine Make & Exhaust System Configuration	Engine		Muffler Dimensions						Backpressure		Muffler Style & Part No.	Notes	
	Model	H.P.	inches			mm			inches of Hg	inches of H ₂ O			
 Engine	Series 60 (14 Ltr)	550 to 575	4.0	9.0	4.0	102	229	102	1.8	25	1	M090544	
			4.0	10.0	4.0	102	254	102	1.9	26	1	M100466	
			5.0	10.0	5.0	127	254	127	2.4	32	1	M100582	OE replacement
			5.0	10.0	5.0	127	254	127	2.4	32	1	M101159	Silent Partner Stainless
			5.0	10.0	5.0	127	254	127	2.4	32	1	M101182	Silent Partner Aluminized
	Series 60 (12.7 Ltr)	Cruise Power 330/350 & 370/430	4.0	9.0	4.0	102	229	102	1.2	17	1	M090544	
			4.0	10.3	4.0	102	262	102	2.5	34	1	M100464	Wrapped muffler
			4.0	10.0	4.0	102	254	102	1.3	18	1	M100466	
			4.0	10.0	5.0	102	254	127	2.1	28	1	M100695	
			5.0	10.0	5.0	127	254	127	1.6	22	1	M100582	OE replacement
			5.0	10.0	5.0	127	254	127	1.6	22	1	M101159	Silent Partner Stainless
			5.0	10.0	5.0	127	254	127	1.6	22	1	M101182	Silent Partner Aluminized
5.0			11.0	5.0	127	279	127	0.9	12	1	M110849		
 Engine	Series 60 (12.7 Ltr)	Cruise Power 430/470	4.0	9.0	4.0	102	229	102	1.3	18	1	M090544	
			4.0	10.3	4.0	102	262	102	2.6	35	1	M100464	Wrapped muffler
			4.0	10.0	4.0	102	254	102	1.4	19	1	M100466	
			4.0	10.0	5.0	102	254	127	2.2	30	1	M100695	
			5.0	10.0	5.0	127	254	127	1.7	23	1	M100582	OE replacement
	Series 60 (12.7 Ltr)	Cruise Power 470/500	4.0	9.0	4.0	102	229	102	1.5	20	1	M090544	
			4.0	10.3	4.0	102	262	102	2.9	39	1	M100464	Wrapped muffler
			4.0	10.0	4.0	102	254	102	1.5	21	1	M100466	
			4.0	10.0	5.0	102	254	127	2.5	33	1	M100695	
			5.0	10.0	5.0	127	254	127	1.9	26	1	M100582	OE replacement
			5.0	10.0	5.0	127	254	127	1.9	26	1	M101159	Silent Partner Stainless
			5.0	10.0	5.0	127	254	127	1.9	26	1	M101182	Silent Partner Aluminized
 Engine	8.2T	205	4.0	9.0	5.0	102	229	127	1.0	13	3	M090823	
			4.0	10.0	4.0	102	254	102	2.8	39	3	M100146	
			4.0	11.8	5.0	102	300	127	1.0	14	3	M120598	
			5.0	10.0	5.0	127	254	127	0.9	13	3	M100213	
	Series 50 (8.7 Ltr)	250 to 275	4.0	9.0	5.0	102	229	127	1.8	25	3	M090823	
			4.0	11.8	5.0	102	300	127	1.9	26	3	M120598	
			5.0	10.0	5.0	127	254	127	1.7	23	3	M100213	
	Series 50 (8.7 Ltr)	300 to 350	4.0	9.0	5.0	102	229	127	2.3	32	3	M090823	
			4.0	11.8	5.0	102	300	127	2.4	33	3	M120598	
			5.0	10.0	5.0	127	254	127	2.2	29	3	M100213	
	Series 60	330	5.0	10.0	5.0	127	254	127	2.9	40	3	M100213	
	Series 60 (11.1 Ltr)	350 to 365	4.0	9.0	5.0	102	229	127	2.2	30	3	M090823	
			4.0	11.8	5.0	102	300	127	2.4	32	3	M120598	
			5.0	10.0	5.0	127	254	127	2.1	28	3	M100213	
	Series 40E (7.6 LTA)	175 to 190	4.0	9.0	5.0	102	229	127	1.5	21	3	M090823	
			4.0	11.8	5.0	102	300	127	1.6	22	3	M120598	
			5.0	10.0	5.0	127	254	127	1.4	19	3	M100213	
	Series 40E (7.6 LTA)	210 to 250	4.0	9.0	5.0	102	229	127	1.8	24	3	M090823	
			4.0	11.8	5.0	102	300	127	1.9	25	3	M120598	
			5.0	10.0	5.0	127	254	127	1.6	22	3	M100213	
	Series 40E (8.7 LTA)	250 to 330	4.0	9.0	5.0	102	229	127	1.8	24	3	M090823	
			5.0	10.0	5.0	127	254	127	1.7	23	3	M100213	
			4.0	11.8	5.0	102	300	127	1.9	26	3	M120598	
	 Engine	6-71T	275	5.0	10x15	5.0	127	254x381	127	2.2	30	2	M120225
6.0				10x15	6.0	152	254x381	152	1.8	25	2	M122300	For off-hwy, shorter than OE
6V-92T		320	5.0	10x15	5.0	127	254x381	127	2.2	30	2	M120225	For off-hwy, shorter than OE
			6.0	10x15	6.0	152	254x381	152	1.8	25	2	M122300	For off-hwy, shorter than OE
6V-92TA		350	6.0	10x15	6.0	152	254x381	152	2.5	34	2	M122300	For off-hwy, shorter than OE
6V-92TA		335	6.0	10x15	6.0	152	254x381	152	2.5	34	2	M122300	For off-hwy, shorter than OE
6V-92TT		270	5.0	10x15	5.0	127	254x381	127	2.1	29	2	M120225	For off-hwy, shorter than OE
			6.0	10x15	6.0	152	254x381	152	1.8	24	2	M122300	For off-hwy, shorter than OE
6V-92TTA		270	5.0	10x15	5.0	127	254x381	127	2.2	30	2	M120225	For off-hwy, shorter than OE
			6.0	10x15	6.0	152	254x381	152	1.8	25	2	M122300	For off-hwy, shorter than OE
8.2T		205	3.0	11.0	4.0	76	279	102	1.0	14	1	M111029	OE replacement

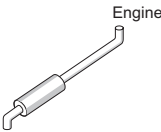
Engine Make & Exhaust System Configuration		Engine Model	H.P.	Muffler Dimensions						Backpressure		Muffler Style & Part No.	Notes	
				inches			mm			inches of Hg	H ₂ O			
				Inlet	Body	Outlet	Inlet	Body	Outlet					
				3.5	8.3x11.5	3.5	89	211x292	89	2.9	39	2	M090158	
				3.5	8.5x11.8	3.5	89	216x300	89	2.9	39	2	M090210	Wrapped muffler
				4.0	10.0	4.0	102	254	102	1.7	24	2	M100048	Aftermarket
				4.0	11.0	4.0	102	279	102	1.7	23	2	M110012	
				4.0	11.0	4.0	102	279	102	1.5	21	2	M110189	OE replacement
				4.0	11.0	5.0	102	279	127	0.9	12	2	M111028	Inlet dimension is OD
				4.0	8.3x11.5	3.5	102	211x292	89	2.8	38	2	M090538	
				4.0	8.3x11.5	4.0	102	211x292	102	1.7	23	2	M090280	Aftermarket, shorter than OE
				4.0	8.3x11.5	4.0	102	211x292	102	1.6	22	2	M090534	Aftermarket, shorter than OE
				4.0	10x15	4.0	102	254x381	102	1.3	17	2	M120100	Aftermarket, shorter than OE
				4.0	10.3x15.3	4.0	102	261x389	102	2.6	35	2	M120197	Wrapped muffler, OE
				5.0	10x15	5.0	127	254x381	127	0.9	13	2	M120108	For off-hwy, shorter than OE
				5.0	10x15	5.0	127	254x381	127	0.6	8	2	M120225	For off-hwy, shorter than OE
				5.0	10x15	5.0	127	254x381	127	1.0	13	2	M120365	Aftermarket
				5.0	10x15	5.0	127	254x381	127	1.0	14	2	M120448	OE replacement
	8V-71T		335		5.0	10x15	5.0	127	254x381	127	2.4	33	2	M120225
				6.0	10x15	6.0	152	254x381	152	2.0	27	2	M122300	For off-hwy, shorter than OE
8V-71TA		370		6.0	10x15	6.0	152	254x381	152	2.6	35	2	M122300	For off-hwy, shorter than OE
8V-71TT		305		6.0	10x15	6.0	152	254x381	152	2.6	35	2	M122300	For off-hwy, shorter than OE
8V-71TTA		305		5.0	10x15	5.0	127	254x381	127	2.2	30	2	M120225	For off-hwy, shorter than OE
				6.0	10x15	6.0	152	254x381	152	1.8	25	2	M122300	For off-hwy, shorter than OE
8V-92TT		365		6.0	10x15	6.0	152	254x381	152	2.8	38	2	M122300	For off-hwy, shorter than OE
8V-92TTA		445		6.0	10x15	6.0	152	254x381	152	2.6	35	2	M122300	For off-hwy, shorter than OE
Series 60 (11.1 Ltr)		315 to 365		3.0	11.0	4.0	76	279	102	2.4	32	1	M111029	OE replacement
				4.0	11.0	5.0	102	279	127	2.0	27	2	M111028	Inlet dimension is OD
				4.0	10x15	4.0	102	254x381	102	2.9	39	2	M120100	Aftermarket, shorter than OE
				5.0	10x15	5.0	127	254x381	127	2.1	29	2	M120108	For off-hwy, shorter than OE
				5.0	10x15	5.0	127	254x381	127	1.4	19	2	M120225	For off-hwy, shorter than OE
				5.0	10x15	5.0	127	254x381	127	2.2	30	2	M120365	Aftermarket
				5.0	10x15	5.0	127	254x381	127	2.3	31	2	M120448	OE replacement
				6.0	10x15	6.0	152	254x381	152	1.1	16	2	M122300	For off-hwy, shorter than OE
Series 50 (8.7 Ltr)		250 to 275		3.0	11.0	4.0	76	279	102	2.2	30	1	M111029	OE replacement
				4.0	11.0	5.0	102	279	127	1.9	26	2	M111028	Inlet dimension is OD
				4.0	10x15	4.0	102	254x381	102	2.7	37	2	M120100	Aftermarket, shorter than OE
				5.0	10x15	5.0	127	254x381	127	2.0	27	2	M120108	For off-hwy, shorter than OE
				5.0	10x15	5.0	127	254x381	127	1.3	18	2	M120225	For off-hwy, shorter than OE
				5.0	10x15	5.0	127	254x381	127	2.1	29	2	M120365	Aftermarket
				5.0	10x15	5.0	127	254x381	127	2.2	30	2	M120448	OE replacement
				6.0	10x15	6.0	152	254x381	152	1.1	15	2	M122300	For off-hwy, shorter than OE
Series 50 (8.7 Ltr)		300 to 350		3.0	11.0	4.0	76	279	102	2.5	33	1	M111029	OE replacement
				4.0	11.0	5.0	102	279	127	2.1	28	2	M111028	Inlet dimension is OD
				4.0	10x15	4.0	102	254x381	102	3.0	40	2	M120100	Aftermarket, shorter than OE
				5.0	10x15	5.0	127	254x381	127	2.2	30	2	M120108	For off-hwy, shorter than OE
				5.0	10x15	5.0	127	254x381	127	1.4	19	2	M120225	For off-hwy, shorter than OE
				5.0	10x15	5.0	127	254x381	127	2.3	31	2	M120365	Aftermarket
				5.0	10x15	5.0	127	254x381	127	2.4	33	2	M120448	OE replacement
				6.0	10x15	6.0	152	254x381	152	1.2	16	2	M122300	For off-hwy, shorter than OE
Series 60 (12.7 Ltr)		330 to 400		5.0	10x15	5.0	127	254x381	127	2.2	30	2	M120225	For off-hwy, shorter than OE
				6.0	10x15	6.0	152	254x381	152	1.9	25	2	M122300	For off-hwy, shorter than OE
Series 60 (12.7 Ltr)		430		5.0	10x15	5.0	127	254x381	127	2.4	33	2	M120225	For off-hwy, shorter than OE
				6.0	10x15	6.0	152	254x381	152	2.0	28	2	M122300	For off-hwy, shorter than OE
Series 60 (12.7 Ltr)		470 to 500		5.0	10x15	5.0	127	254x381	127	2.9	39	2	M120225	For off-hwy, shorter than OE
				6.0	10x15	6.0	152	254x381	152	2.4	32	2	M122300	For off-hwy, shorter than OE
Series 60 (14 Ltr)		550-575		6.0	10x15	6.0	152	254x381	152	3.0	40	2	M122300	For off-hwy, shorter than OE
Series 60 (12.7 Ltr)		Cruise Power 330/350 & 370/430		5.0	10x15	5.0	127	254x381	127	2.4	33	2	M120225	For off-hwy, shorter than OE
				6.0	10x15	6.0	152	254x381	152	2.0	28	2	M122300	For off-hwy, shorter than OE
Series 60 (12.7 Ltr)		Cruise Power 430/470		5.0	10x15	5.0	127	254x381	127	2.6	35	2	M120225	For off-hwy, shorter than OE
				6.0	10x15	6.0	152	254x381	152	2.1	29	2	M122300	For off-hwy, shorter than OE
Series 60 (12.7 Ltr)		Cruise Power 470/500		5.0	10x15	5.0	127	254x381	127	2.9	39	2	M120225	For off-hwy, shorter than OE
				6.0	10x15	6.0	152	254x381	152	2.4	32	2	M122300	For off-hwy, shorter than OE
Series 40E		175 to 190		3.0	11.0	4.0	76	279	102	1.6	22	1	M111029	OE replacement

Truck Engine Muffler Application

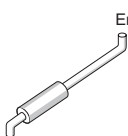
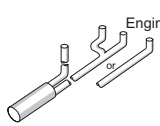
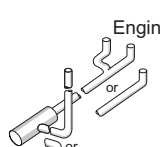

Engine Make & Exhaust System Configuration		Engine Model H.P.		Muffler Dimensions			Backpressure		Muffler Style & Part No.		Notes			
				inches			mm					inches of Hg	H ₂ O	
				Inlet	Body	Outlet	Inlet	Body	Outlet					
	(7.6 LTA)			4.0	10.0	4.0	102	254	102	2.7	36	2	M100048	Aftermarket
		4.0	11.0	4.0	102	279	102	2.6	35	2	M110012			
		4.0	11.0	4.0	102	279	102	2.3	32	2	M110189	OE replacement		
		4.0	11.0	5.0	102	279	127	1.4	18	2	M111028	Inlet dimension is OD		
		4.0	8.3x11.5	4.0	102	211x292	102	2.6	36	2	M090280	Aftermarket, shorter than OE		
		4.0	8.3x11.5	4.0	102	211x292	102	2.5	33	2	M090534	Aftermarket, shorter than OE		
		4.0	10x15	4.0	102	254x381	102	1.9	26	2	M120100	Aftermarket, shorter than OE		
		5.0	10x15	5.0	127	254x381	127	1.4	20	2	M120108	For off-hwy, shorter than OE		
		5.0	10x15	5.0	127	254x381	127	0.9	13	2	M120225	For off-hwy, shorter than OE		
		5.0	10x15	5.0	127	254x381	127	1.5	21	2	M120365	Aftermarket		
		5.0	10x15	5.0	127	254x381	127	1.6	21	2	M120448	OE replacement		
		Series 40E (7.6 LTA)	210 to 250	3.0	11.0	4.0	76	279	102	1.9	25	1	M111029	OE replacement
				4.0	11.0	4.0	102	279	102	3.0	40	2	M110012	
				4.0	11.0	4.0	102	279	102	2.7	37	2	M110189	OE replacement
				4.0	11.0	5.0	102	279	127	1.6	21	2	M111028	Inlet dimension is OD
4.0	8.3x11.5			4.0	102	211x292	102	2.8	38	2	M090534	Aftermarket, shorter than OE		
4.0	10x15			4.0	102	254x381	102	2.2	30	2	M120100	Aftermarket, shorter than OE		
5.0	10x15			5.0	127	254x381	127	1.6	22	2	M120108	For off-hwy, shorter than OE		
5.0	10x15			5.0	127	254x381	127	1.1	15	2	M120225	For off-hwy, shorter than OE		
5.0	10x15			5.0	127	254x381	127	1.7	24	2	M120365	Aftermarket		
5.0	10x15			5.0	127	254x381	127	1.8	25	2	M120448	OE replacement		
Series 40E	250 to 275	3.0	11.0	4.0	76	279	102	1.9	26	1	M111029	OE replacement		
		4.0	11.0	4.0	102	279	102	2.8	38	2	M110189	OE replacement		
		4.0	11.0	5.0	102	279	127	1.6	22	2	M111028	Inlet dimension is OD		
		4.0	8.3x11.5	4.0	102	211x292	102	2.9	40	2	M090534	Aftermarket, shorter than OE		
		4.0	10x15	4.0	102	254x381	102	2.3	32	2	M120100	Aftermarket, shorter than OE		
		5.0	10x15	5.0	127	254x381	127	1.7	23	2	M120108	For off-hwy, shorter than OE		
		5.0	10x15	5.0	127	254x381	127	1.1	15	2	M120225	For off-hwy, shorter than OE		
		5.0	10x15	5.0	127	254x381	127	1.8	25	2	M120365	Aftermarket		
		5.0	10x15	5.0	127	254x381	127	1.9	25	2	M120448	OE replacement		
		Series 40E (8.7 LTA)	300 to 330	4.0	11.0	5.0	102	279	127	1.8	24	2	M111028	Inlet dimension is OD
4.0	10x15			4.0	102	254x381	102	2.5	34	2	M120100	Aftermarket, shorter than OE		
5.0	10x15			5.0	127	254x381	127	1.9	25	2	M120108	For off-hwy, shorter than OE		
5.0	10x15			5.0	127	254x381	127	1.2	17	2	M120225	For off-hwy, shorter than OE		
5.0	10x15			5.0	127	254x381	127	2.0	27	2	M120365	Aftermarket		
5.0	10x15			5.0	127	254x381	127	2.0	28	2	M120448	OE replacement		
	Series 60 (12.7 Ltr)	330 to 400	5.0	10x15	5.0	127	254x381	127	2.2	30	5	M120131	For off-hwy, shorter than OE	
			5.0	10x15	5.0	127	254x381	127	2.6	36	5	M120450	OE replacement	
	Series 60 (12.7 Ltr)	430 to 500	5.0	10x15	5.0	127	254x381	127	2.9	39	5	M120131	For off-hwy, shorter than OE	
	Series 60 (12.7 Ltr)	Cruise Power 330/350 & 370/430	5.0	10x15	5.0	127	254x381	127	2.4	33	5	M120131	For off-hwy, shorter than OE	
5.0			10x15	5.0	127	254x381	127	2.9	39	5	M120450	OE replacement		
Series 60 (12.7 Ltr)	Cruise Power 430/470 & 470/500	5.0	10x15	5.0	127	254x381	127	2.6	35	5	M120131	For off-hwy, shorter than OE		
	Series 60 (11.1 Ltr)	350 to 365	4.0	11.0	4.0	102	279	102	2.9	40	4	M111025	Inlet & outlet dimension is OD	
			5.0	11.0	5.0	127	279	127	1.9	26	4	M110014	OE replacement	
			5.0	10x15	5.0	127	254x381	127	2.0	27	4	M120366	OE replacement	
Series 50 (8.7 Ltr)	250 to 275	4.0	11.0	4.0	102	279	102	2.7	37	4	M110112			
		4.0	11.0	4.0	102	279	102	2.7	37	4	M110148			
		4.0	11.0	4.0	102	279	102	2.7	37	4	M110311	Inlet dimension is OD		
		4.0	11.0	4.0	102	279	102	2.4	32	4	M111025	Inlet & outlet dimension is OD		
		5.0	11.0	5.0	127	279	127	1.5	21	4	M110014	OE replacement		
		5.0	10x15	5.0	127	254x381	127	1.6	22	4	M120366	OE replacement		
Series 50 (8.7 Ltr)	300	4.0	11.0	4.0	102	279	102	2.6	36	4	M111025	Inlet & outlet dimension is OD		
		5.0	11.0	5.0	127	279	127	1.7	23	4	M110014	OE replacement		
		5.0	10x15	5.0	127	254x381	127	1.8	24	4	M120366	OE replacement		
Series 50 (8.7 Ltr)	315 to 350	4.0	11.0	4.0	102	279	102	3.0	40	4	M111025	Inlet & outlet dimension is OD		
		5.0	11.0	5.0	127	279	127	2.0	27	4	M110014	OE replacement		
		5.0	10x15	5.0	127	254x381	127	2.1	28	4	M120366	OE replacement		
Series 40E (7.6 LTA)	175-195	4.0	10.0	4.0	102	254	102	2.8	38	4	M100052			
		4.0	11.0	4.0	102	279	102	2.3	31	4	M110112			
		4.0	11.0	4.0	102	279	102	2.3	31	4	M110148			
		4.0	11.0	4.0	102	279	102	2.3	31	4	M110311	Inlet dimension is OD		
		4.0	11.0	4.0	102	279	102	2.0	27	4	M111025	Inlet & outlet dimension is OD		
		4.0	10x15	4.0	102	254x381	102	2.7	36	4	M120367	Aftermarket, shorter than OE		

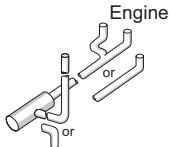
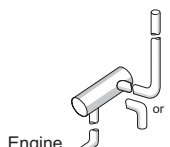
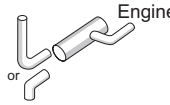
Engine Make & Exhaust System Configuration	Engine Model	H.P.	Muffler Dimensions inches			Muffler Dimensions mm			Backpressure inches of Hg / H ₂ O		Muffler Style & Part No.	Notes	
			Inlet	Body	Outlet	Inlet	Body	Outlet					
	Series 40E (7.6 LTA)	210 to 250	5.0	11.0	5.0	127	279	127	1.3	18	4	M110014	OE replacement
			5.0	10x15	5.0	127	254x381	127	1.4	19	4	M120366	OE replacement
			4.0	11.0	4.0	102	279	102	2.6	36	4	M110112	
			4.0	11.0	4.0	102	279	102	2.6	36	4	M110148	
			4.0	11.0	4.0	102	279	102	2.6	36	4	M110311	Inlet dimension is OD
			4.0	11.0	4.0	102	279	102	2.3	31	4	M111025	Inlet & outlet dimension is OD
	Series 40E (8.7 LTA)	250 to 275	5.0	11.0	5.0	127	279	127	1.5	20	4	M110014	OE replacement
			5.0	10x15	5.0	127	254x381	127	1.6	21	4	M120366	OE replacement
			4.0	11.0	4.0	102	279	102	2.7	37	4	M110112	
			4.0	11.0	4.0	102	279	102	2.7	37	4	M110148	
			4.0	11.0	4.0	102	279	102	2.7	37	4	M110311	Inlet dimension is OD
			4.0	11.0	4.0	102	279	102	2.4	32	4	M111025	Inlet & outlet dimension is OD
	Series 40E (8.7 LTA)	300 to 320	5.0	11.0	5.0	127	279	127	1.6	21	4	M110014	OE replacement
			5.0	10x15	5.0	127	254x381	127	1.6	22	4	M120366	OE replacement
			4.0	11.0	4.0	102	279	102	3.0	40	4	M110112	
4.0			11.0	4.0	102	279	102	3.0	40	4	M110148		
4.0			11.0	4.0	102	279	102	3.0	40	4	M110311	Inlet dimension is OD	
4.0			11.0	4.0	102	279	102	2.6	35	4	M111025	Inlet & outlet dimension is OD	
	8.2T	205	4.0	10.0	4.0	102	254	102	1.8	25	6	M100572	
			4.0	11.0	4.0	102	279	102	1.4	19	6	M111026	Outlet dimension is OD
			5.0	10x15	5.0	127	254x381	127	0.9	13	6	M120418	For off-hwy, shorter than OE
	Series 60 (11.1 Ltr)	350 to 365	5.0	10x15	5.0	127	254x381	127	2.1	28	6	M120418	For off-hwy, shorter than OE
	Series 50 (8.7 Ltr)	250 to 275	4.0	11.0	4.0	102	279	102	2.6	35	6	M111026	Outlet dimension is OD
			5.0	10x15	5.0	127	254x381	127	1.7	23	6	M120418	For off-hwy, shorter than OE
	Series 50 (8.7 Ltr)	300	4.0	11.0	4.0	102	279	102	2.9	39	6	M111026	Outlet dimension is OD
			5.0	10x15	5.0	127	254x381	127	1.9	26	6	M120418	For off-hwy, shorter than OE
	Series 50 (8.7 Ltr)	320 to 350	5.0	10x15	5.0	127	254x381	127	2.2	29	6	M120418	For off-hwy, shorter than OE
	Series 40E (7.6 LTA)	175 to 195	4.0	10.0	4.0	102	254	102	2.9	40	6	M100572	
			4.0	11.0	4.0	102	279	102	2.3	31	6	M111026	Outlet dimension is OD
			5.0	10x15	5.0	127	254x381	127	1.5	20	6	M120418	For off-hwy, shorter than OE
	Series 40E (7.6 LTA)	210 to 250	4.0	11.0	4.0	102	279	102	2.5	34	6	M111026	Outlet dimension is OD
5.0			10x15	5.0	127	254x381	127	1.6	22	6	M120418	For off-hwy, shorter than OE	
Series 40E (8.7 LTA)	250 to 275	4.0	11.0	4.0	102	279	102	2.6	36	6	M111026	Outlet dimension is OD	
		5.0	10x15	5.0	127	254x381	127	1.7	23	6	M120418	For off-hwy, shorter than OE	
Series 40E (8.7 LTA)	300 to 320	4.0	11.0	4.0	102	279	102	2.8	39	6	M111026	Outlet dimension is OD	
		5.0	10x15	5.0	127	254x381	127	1.9	25	6	M120418	For off-hwy, shorter than OE	
	Series 60 (11.1 Ltr)	350 to 365	5.0	10x15		127	254x381		2.6	36	3	M120235	OE replacement
	Series 50 (8.7 Ltr)	250 to 275	4.0	11.0	5.0	102	279		3.0	40	3	M111024	Outlet has down spout
			5.0	10x15	5.0	127	254x381	127	2.1	29	3	M120235	OE replacement
	Series 50 (8.7 Ltr)	300	5.0	10x15	5.0	127	254x381	127	2.3	32	3	M120235	OE replacement
	Series 50 (8.7 Ltr)	320	5.0	10x15	5.0	127	254x381	127	2.4	33	3	M120235	OE replacement
	Series 50 (8.7 Ltr)	350	5.0	10x15	5.0	127	254x381	127	2.7	37	3	M120235	OE replacement
	Series 40E (7.6 LTA)	175 to 195	4.0	11.0	4.0	102	279	102	2.6	36	3	M110479	
			4.0	11.0	4.0	102	279	102	2.4	33	3	M110674	Band clamp on inlet
			4.0	11.0		102	279		2.4	32	3	M111024	Outlet has down spout
			5.0	10x15	5.0	127	254x381	127	1.6	21	3	M120235	OE replacement
	Series 40E (7.6 LTA)	210 to 250	5.0	10x15	5.0	127	254x381	127	2.0	28	3	M120235	OE replacement
Series 40E	250	4.0	11.0	4.0	102	279	102	3.0	40	3	M110674	Band clamp on inlet	

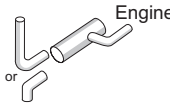
Engine Make & Exhaust System Configuration	Engine Model	H.P.	Muffler Dimensions inches			Muffler Dimensions mm			Backpressure inches of Hg H ₂ O		Muffler Style & Part No.	Notes	
			Inlet	Body	Outlet	Inlet	Body	Outlet	Hg	H ₂ O			
 Engine (8.7 LTA)			4.0	11.0		102	279		2.9	39	3	M111024	Outlet has down spout
			5.0	10x15	5.0	127	254x381	127	1.9	26	3	M120235	OE replacement
Series 40E (8.7 LTA)	275 to 300		5.0	10x15	5.0	127	254x381	127	2.2	30	3	M120235	OE replacement
Series 40E (8.7 LTA)	320		5.0	10x15	5.0	127	254x381	127	2.3	31	3	M120235	OE replacement

International

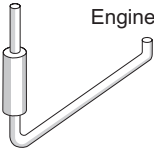
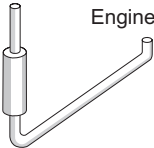
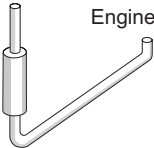
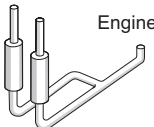
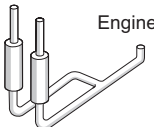
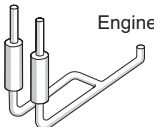
 Engine	DT817	385	4.0	8.5	4.0	102	216	102	1.7	23	1	M085171				
			4.0	9.0	5.0	102	229	127	2.4	33	1	M090781				
			5.0	9.0	5.0	127	229	127	2.0	28	1	M090074				
			5.0	9.0	5.0	127	229	127	1.1	15	1	M090535	Low backpressure, off-hwy			
			5.0	10.0	5.0	127	254	127	1.1	15	1	M100463	Low backpressure, off-hwy			
			5.0	10.0	5.0	127	254	127	0.8	10	1	M100465	Best value, most popular			
			5.0	10.0	5.0	127	254	127	2.3	31	1	M100580	OE replacement			
			5.0	10.0	5.0	127	254	127	2.5	34	1	M100807	60" (1524mm) Long Body			
			5.0	10.0	5.0	127	254	127	1.8	25	1	M100944	OE replacement for higher HP			
			5.0	10.0	5.0	127	254	127	2.2	30	1	M101158	Silent Partner Stainless			
			5.0	10.0	5.0	127	254	127	2.2	30	1	M101181	Silent Partner Aluminized			
			5.0	10.0	5.0	127	254	127	2.3	31	1	M101263	Freightliner only			
			5.0	11.0	5.0	127	279	127	1.8	25	1	M110849				
 Engine	DT812B	320	4.0	8.5	4.0	102	216	102	1.7	23	1	M085171				
			4.0	9.0	5.0	102	229	127	2.4	33	1	M090781				
			5.0	9.0	5.0	127	229	127	2.0	28	1	M090074				
			5.0	9.0	5.0	127	229	127	1.1	15	1	M090535	Low backpressure, off-hwy			
			5.0	10.0	5.0	127	254	127	1.1	15	1	M100463	Low backpressure, off-hwy			
			5.0	10.0	5.0	127	254	127	0.8	10	1	M100465	Best value, most popular			
			5.0	10.0	5.0	127	254	127	2.3	31	1	M100580	OE replacement			
			5.0	10.0	5.0	127	254	127	2.5	34	1	M100807	60" (1524mm) Long Body			
			5.0	10.0	5.0	127	254	127	1.8	25	1	M100944	OE replacement for higher HP			
			5.0	10.0	5.0	127	254	127	2.2	30	1	M101158	Silent Partner Stainless			
			5.0	10.0	5.0	127	254	127	2.2	30	1	M101181	Silent Partner Aluminized			
			5.0	10.0	5.0	127	254	127	2.3	31	1	M101263	Freightliner only			
			5.0	11.0	5.0	127	279	127	1.8	25	1	M110849				
 Engine	DT817C	420	4.0	8.5	4.0	102	216	102	1.7	23	1	M085171				
			4.0	9.0	5.0	102	229	127	2.4	33	1	M090781				
			5.0	9.0	5.0	127	229	127	2.0	28	1	M090074				
			5.0	9.0	5.0	127	229	127	1.1	15	1	M090535	Low backpressure, off-hwy			
			5.0	10.0	5.0	127	254	127	1.1	15	1	M100463	Low backpressure, off-hwy			
			5.0	10.0	5.0	127	254	127	0.8	10	1	M100465	Best value, most popular			
			5.0	10.0	5.0	127	254	127	2.3	31	1	M100580	OE replacement			
			5.0	10.0	5.0	127	254	127	2.5	34	1	M100807	60" (1524mm) Long Body			
			5.0	10.0	5.0	127	254	127	1.8	25	1	M100944	OE replacement for higher HP			
			5.0	10.0	5.0	127	254	127	2.2	30	1	M101158	Silent Partner Stainless			
			5.0	10.0	5.0	127	254	127	2.2	30	1	M101181	Silent Partner Aluminized			
			5.0	10.0	5.0	127	254	127	2.3	31	1	M101263	Freightliner only			
			5.0	11.0	5.0	127	279	127	1.8	25	1	M110849				
 Engine	DT817	385	4.0	9.0	4.0	102	229	102	1.0	14	1	M090544				
			4.0	10.3	4.0	102	262	102	2.0	27	1	M100464	Wrapped muffler			
			4.0	10.0	4.0	102	254	102	1.1	14	1	M100466				
			4.0	10.0	5.0	102	254	127	1.7	23	1	M100695				
			5.0	10.0	5.0	127	254	127	1.3	18	1	M100582	OE replacement			
			5.0	10.0	5.0	127	254	127	1.3	18	1	M101159	Silent Partner Stainless			
			5.0	10.0	5.0	127	254	127	1.3	18	1	M101182	Silent Partner Aluminized			
			5.0	11.0	5.0	127	279	127	0.7	9	1	M110849				
			 Engine	DT812B	320	4.0	9.0	4.0	102	229	102	1.0	14	1	M090544	
						4.0	10.3	4.0	102	262	102	2.0	27	1	M100464	Wrapped muffler
4.0	10.0	4.0				102	254	102	1.1	14	1	M100466				
4.0	10.0	5.0				102	254	127	1.7	23	1	M100695				
5.0	10.0	5.0				127	254	127	1.3	18	1	M100582	OE replacement			
5.0	10.0	5.0				127	254	127	1.3	18	1	M101159	Silent Partner Stainless			
5.0	10.0	5.0				127	254	127	1.3	18	1	M101182	Silent Partner Aluminized			
5.0	11.0	5.0				127	279	127	0.7	9	1	M110849				
 Engine	DT817C	420				4.0	9.0	4.0	102	229	102	1.0	14	1	M090544	
						4.0	10.3	4.0	102	262	102	2.0	27	1	M100464	Wrapped muffler
			4.0	10.0	4.0	102	254	102	1.1	14	1	M100466				
			4.0	10.0	5.0	102	254	127	1.7	23	1	M100695				
			5.0	10.0	5.0	127	254	127	1.3	18	1	M100582	OE replacement			
			5.0	10.0	5.0	127	254	127	1.3	18	1	M101159	Silent Partner Stainless			

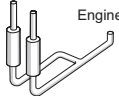
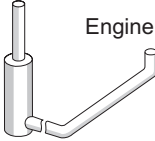
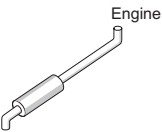
Engine Make & Exhaust System Configuration	Engine Model	H.P.	Muffler Dimensions inches			Muffler Dimensions mm			Backpressure inches of Hg / H ₂ O		Muffler Style & Part No.	Notes	
			Inlet	Body	Outlet	Inlet	Body	Outlet					
			5.0	10.0	5.0	127	254	127	1.3	18	1	M101159	Silent Partner Stainless
			5.0	10.0	5.0	127	254	127	1.3	18	1	M101182	Silent Partner Aluminized
			5.0	11.0	5.0	127	279	127	0.7	9	1	M110849	
	6.9L	170	4.0	10.0	4.0	102	254	102	1.1	15	3	M100146	
	7.3L (T444)	175	4.0	10.0	4.0	102	254	102	1.3	17	3	M100146	
	9.0L	185	4.0	9.0	5.0	102	229	127	0.6	9	3	M090823	
			4.0	10.0	4.0	102	254	102	1.8	24	3	M100146	
			4.0	11.8	5.0	102	300	127	0.7	9	3	M120598	
			5.0	10.0	5.0	127	254	127	0.6	8	3	M100213	
	DT360	190	4.0	9.0	5.0	102	229	127	1.1	15	3	M090823	
			4.0	11.8	5.0	102	300	127	1.2	16	3	M120598	
			5.0	10.0	5.0	127	254	127	1.0	14	3	M100213	
	DT466E	195 to 275	4.0	9.0	5.0	102	229	127	1.7	22	3	M090823	
4.0			11.8	5.0	102	300	127	1.7	24	3	M120598		
5.0			10.0	5.0	127	254	127	1.5	21	3	M100213		
DT414	220	4.0	9.0	5.0	102	229	127	0.7	9	3	M090823		
		4.0	10.0	4.0	102	254	102	1.9	26	3	M100146		
		4.0	11.8	5.0	102	300	127	0.7	10	3	M120598		
		5.0	10.0	5.0	127	254	127	0.6	9	3	M100213		
DT420	225	4.0	10.0	4.0	102	254	102	1.6	21	3	M100146		
	6.9L	170	3.0	8.5	3.0	76	216	76	1.6	22	2	M085023	
			3.0	8.5	3.0	76	216	76	1.6	22	2	M085056	
			3.0	8.5	3.0	76	216	76	2.0	28	2	M085078	
			3.0	8.3x11.5	3.0	76	211x292	76	2.9	39	2	M090170	
			3.0	8.5x11.8	3.0	76	216x300	76	2.9	39	2	M090159	Wrapped muffler
			3.5	8.5	3.0	89	216	76	1.5	20	2	M085008	
			3.5	8.3x11.5	3.5	89	211x292	89	1.1	15	2	M090158	
			3.5	8.3x11.5	4.0	89	211x292	102	0.7	9	2	M090680	OE replacement
			3.5	8.5x11.8	3.5	89	216x300	89	1.1	15	2	M090210	Wrapped muffler
			4.0	10.0	4.0	102	254	102	0.7	9	2	M100048	Aftermarket
			4.0	11.0	4.0	102	279	102	0.7	9	2	M110012	
			4.0	11.0	4.0	102	279	102	0.6	8	2	M110189	OE replacement
	4.0	8.3x11.5	3.5	102	211x292	89	1.1	15	2	M090538			
	4.0	8.3x11.5	4.0	102	211x292	102	0.7	9	2	M090280	Aftermarket, shorter than OE		
	4.0	8.3x11.5	4.0	102	211x292	102	0.6	9	2	M090534	Aftermarket, shorter than OE		
	4.0	10.3x15.3	4.0	102	261x389	102	1.0	14	2	M120197	Wrapped muffler, OE		
	7.3L (T444)	175	3.0	8.5	3.0	76	216	76	1.8	24	2	M085023	
			3.0	8.5	3.0	76	216	76	1.8	24	2	M085056	
			3.0	8.5	3.0	76	216	76	2.3	31	2	M085078	
			3.5	8.5	3.0	89	216	76	1.7	23	2	M085008	
3.5			8.3x11.5	3.5	89	211x292	89	1.3	17	2	M090158		
3.5			8.3x11.5	4.0	89	211x292	102	0.8	10	2	M090680	OE replacement	
3.5			8.5x11.8	3.5	89	216x300	89	1.3	17	2	M090210	Wrapped muffler	
4.0			10.0	4.0	102	254	102	0.8	10	2	M100048	Aftermarket	
4.0	11.0	4.0	102	279	102	0.7	10	2	M110012				
4.0	11.0	4.0	102	279	102	0.7	9	2	M110189	OE replacement			
4.0	8.3x11.5	3.5	102	211x292	89	1.2	17	2	M090538				
4.0	8.3x11.5	4.0	102	211x292	102	0.8	10	2	M090280	Aftermarket, shorter than OE			
4.0	8.3x11.5	4.0	102	211x292	102	0.7	10	2	M090534	Aftermarket, shorter than OE			
4.0	10.3x15.3	4.0	102	261x389	102	1.2	16	2	M120197	Wrapped muffler, OE			
9.0L	185	3.0	8.5	3.0	76	216	76	2.5	34	2	M085023		
		3.0	8.5	3.0	76	216	76	2.5	34	2	M085056		
		3.0	11.0	4.0	76	279	102	0.7	9	1	M111029	OE replacement	
		3.5	8.5	3.0	89	216	76	2.4	33	2	M085008		
		3.5	8.3x11.5	3.5	89	211x292	89	1.8	25	2	M090158		
		3.5	8.3x11.5	4.0	89	211x292	102	1.1	15	2	M090680	OE replacement	
		3.5	8.5x11.8	3.5	89	216x300	89	1.8	25	2	M090210	Wrapped muffler	
		4.0	10.0	4.0	102	254	102	1.1	15	2	M100048	Aftermarket	
		4.0	11.0	4.0	102	279	102	1.1	14	2	M110012		
		4.0	11.0	4.0	102	279	102	1.0	13	2	M110189	OE replacement	
		4.0	10x15	4.0	102	254x381	102	0.8	11	2	M120100	Aftermarket, shorter than OE	
		4.0	8.3x11.5	3.5	102	211x292	89	1.8	24	2	M090538		
		4.0	8.3x11.5	4.0	102	211x292	102	1.1	15	2	M090280	Aftermarket, shorter than OE	
		4.0	8.3x11.5	4.0	102	211x292	102	1.0	14	2	M090534	Aftermarket, shorter than OE	
		4.0	10.3x15.3	4.0	102	261x389	102	1.7	22	2	M120197	Wrapped muffler, OE	
		5.0	10x15	5.0	127	254x381	127	0.6	8	2	M120365	Aftermarket	

Truck Engine Muffler Application

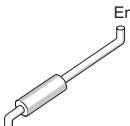

Engine Make & Exhaust System Configuration	Engine Model	Engine H.P.	Muffler Dimensions						Backpressure		Muffler Style & Part No.	Notes		
			inches			mm			inches of Hg	H ₂ O				
			Inlet	Body	Outlet	Inlet	Body	Outlet						
 Engine	DT360	190	5.0	10x15	5.0	127	254x381	127	0.6	9	2	M120448	OE replacement	
			3.0	11.0	4.0	76	279	102	1.2	16	1	M111029	OE replacement	
			3.5	8.3x11.5	4.0	89	211x292	102	1.9	26	2	M090680	OE replacement	
			4.0	10.0	4.0	102	254	102	2.0	27	2	M100048	Aftermarket	
			4.0	11.0	4.0	102	279	102	1.9	26	2	M110012		
			4.0	11.0	4.0	102	279	102	1.7	23	2	M110189	OE replacement	
			4.0	11.0	5.0	102	279	127	1.0	14	2	M111028	Inlet dimension is OD	
			4.0	10x15	4.0	102	254x381	102	1.4	19	2	M120100	Aftermarket, shorter than OE	
			4.0	8.3x11.5	4.0	102	211x292	102	1.9	26	2	M090280	Aftermarket, shorter than OE	
			4.0	8.3x11.5	4.0	102	211x292	102	1.8	24	2	M090534	Aftermarket, shorter than OE	
			4.0	10.3x15.3	4.0	102	261x389	102	2.9	40	2	M120197	Wrapped muffler, OE	
			5.0	10x15	5.0	127	254x381	127	1.1	14	2	M120108	For off-hwy, shorter than OE	
			5.0	10x15	5.0	127	254x381	127	0.7	9	2	M120225	For off-hwy, shorter than OE	
			5.0	10x15	5.0	127	254x381	127	1.1	15	2	M120365	Aftermarket	
			5.0	10x15	5.0	127	254x381	127	1.2	16	2	M120448	OE replacement	
DT466E	195 to 210	3.0	11.0	4.0	76	279	102	1.5	20	1	M111029	OE replacement		
		3.5	8.3x11.5	4.0	89	211x292	102	2.4	32	2	M090680	OE replacement		
		4.0	10.0	4.0	102	254	102	2.4	33	2	M100048	Aftermarket		
		4.0	11.0	4.0	102	279	102	2.3	32	2	M110012			
		4.0	11.0	4.0	102	279	102	2.1	29	2	M110189	OE replacement		
		4.0	11.0	5.0	102	279	127	1.2	17	2	M111028	Inlet dimension is OD		
		4.0	8.3x11.5	4.0	102	211x292	102	2.4	32	2	M090280	Aftermarket, shorter than OE		
		4.0	8.3x11.5	4.0	102	211x292	102	2.2	30	2	M090534	Aftermarket, shorter than OE		
		4.0	10x15	4.0	102	254x381	102	1.8	24	2	M120100	Aftermarket, shorter than OE		
		5.0	10x15	5.0	127	254x381	127	1.3	18	2	M120108	For off-hwy, shorter than OE		
		5.0	10x15	5.0	127	254x381	127	0.8	12	2	M120225	For off-hwy, shorter than OE		
		5.0	10x15	5.0	127	254x381	127	1.4	19	2	M120365	Aftermarket		
		5.0	10x15	5.0	127	254x381	127	1.4	19	2	M120448	OE replacement		
		DT466E	230 to 275	3.0	11.0	4.0	76	279	102	1.7	24	1	M111029	OE replacement
				3.5	8.3x11.5	4.0	89	211x292	102	2.8	39	2	M090680	OE replacement
4.0	10.0			4.0	102	254	102	2.9	39	2	M100048	Aftermarket		
4.0	11.0			4.0	102	279	102	2.8	38	2	M110012			
4.0	11.0			4.0	102	279	102	2.5	34	2	M110189	OE replacement		
4.0	11.0			5.0	102	279	127	1.5	20	2	M111028	Inlet dimension is OD		
4.0	8.3x11.5			4.0	102	211x292	102	2.8	39	2	M090280	Aftermarket, shorter than OE		
4.0	8.3x11.5			4.0	102	211x292	102	2.7	36	2	M090534	Aftermarket, shorter than OE		
4.0	10x15			4.0	102	254x381	102	2.1	29	2	M120100	Aftermarket, shorter than OE		
5.0	10x15			5.0	127	254x381	127	1.6	21	2	M120108	For off-hwy, shorter than OE		
5.0	10x15			5.0	127	254x381	127	1.0	14	2	M120225	For off-hwy, shorter than OE		
5.0	10x15			5.0	127	254x381	127	1.6	22	2	M120365	Aftermarket		
5.0	10x15			5.0	127	254x381	127	1.7	23	2	M120448	OE replacement		
DT414	220			3.0	8.5	3.0	76	216	76	2.7	37	2	M085023	
				3.0	8.5	3.0	76	216	76	2.7	37	2	M085056	
		3.0	11.0	4.0	76	279	102	0.7	10	1	M111029	OE replacement		
		3.5	8.5	3.0	89	216	76	2.6	35	2	M085008			
		3.5	8.3x11.5	3.5	89	211x292	89	2.0	27	2	M090158			
		3.5	8.3x11.5	4.0	89	211x292	102	1.2	16	2	M090680	OE replacement		
		3.5	8.5x11.8	3.5	89	216x300	89	2.0	27	2	M090210	Wrapped muffler		
		4.0	10.0	4.0	102	254	102	1.2	16	2	M100048	Aftermarket		
		4.0	11.0	4.0	102	279	102	1.1	16	2	M110012			
		4.0	11.0	4.0	102	279	102	1.0	14	2	M110189	OE replacement		
		4.0	11.0	5.0	102	279	127	0.6	8	2	M111028	Inlet dimension is OD		
		4.0	8.3x11.5	3.5	102	211x292	89	1.9	26	2	M090538			
		4.0	8.3x11.5	4.0	102	211x292	102	1.2	16	2	M090280	Aftermarket, shorter than OE		
		4.0	8.3x11.5	4.0	102	211x292	102	1.1	15	2	M090534	Aftermarket, shorter than OE		
		4.0	10x15	4.0	102	254x381	102	0.9	12	2	M120100	Aftermarket, shorter than OE		
		4.0	10.3x15.3	4.0	102	261x389	102	1.8	24	2	M120197	Wrapped muffler, OE		
		5.0	10x15	5.0	127	254x381	127	0.6	9	2	M120108	For off-hwy, shorter than OE		
		5.0	10x15	5.0	127	254x381	127	0.7	9	2	M120365	Aftermarket		
		5.0	10x15	5.0	127	254x381	127	0.7	9	2	M120448	OE replacement		
		DT420	225	3.0	8.5	3.0	76	216	76	2.2	30	2	M085023	
3.0	8.5			3.0	76	216	76	2.2	30	2	M085056			
3.0	8.5			3.0	76	216	76	2.8	39	2	M085078			
3.5	8.5			3.0	89	216	76	2.1	28	2	M085008			
3.5	8.3x11.5			3.5	89	211x292	89	1.6	21	2	M090158			
3.5	8.3x11.5			4.0	89	211x292	102	0.9	13	2	M090680	OE replacement		
3.5	8.5x11.8			3.5	89	216x300	89	1.6	21	2	M090210	Wrapped muffler		
4.0	10.0			4.0	102	254	102	1.0	13	2	M100048	Aftermarket		

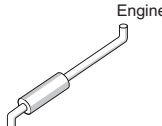
Engine Make & Exhaust System Configuration	Engine Model	H.P.	Muffler Dimensions						Backpressure		Muffler Style & Part No.	Notes				
			inches			mm			inches of Hg	H ₂ O						
			Inlet	Body	Outlet	Inlet	Body	Outlet								
			4.0	11.0	4.0	102	279	102	0.9	13	2	M110012				
			4.0	11.0	4.0	102	279	102	0.8	11	2	M110189	OE replacement			
			4.0	8.3x11.5	3.5	102	211x292	89	1.5	21	2	M090538				
			4.0	8.3x11.5	4.0	102	211x292	102	0.9	13	2	M090280	Aftermarket, shorter than OE			
			4.0	8.3x11.5	4.0	102	211x292	102	0.9	12	2	M090534	Aftermarket, shorter than OE			
			4.0	10x15	4.0	102	254x381	102	0.7	9	2	M120100	Aftermarket, shorter than OE			
			4.0	10.3x15.3	4.0	102	261x389	102	1.4	20	2	M120197	Wrapped muffler, OE			
			5.0	10x15	5.0	127	254x381	127	0.6	8	2	M120448	OE replacement			
			DT817	385		4.0	11.0	5.0	102	279	127	2.8	39	2	M111028	Inlet dimension is OD
						5.0	10x15	5.0	127	254x381	127	2.0	27	2	M120225	For off-hwy, shorter than OE
			6.0	10x15	6.0	152	254x381	152	1.6	22	2	M122300	For off-hwy, shorter than OE			
DT812B	320		4.0	11.0	5.0	102	279	127	2.8	39	2	M111028	Inlet dimension is OD			
			5.0	10x15	5.0	127	254x381	127	2.0	27	2	M120225	For off-hwy, shorter than OE			
			6.0	10x15	6.0	152	254x381	152	1.6	22	2	M122300	For off-hwy, shorter than OE			
DT817C	420		4.0	11.0	5.0	102	279	127	2.8	39	2	M111028	Inlet dimension is OD			
			5.0	10x15	5.0	127	254x381	127	2.0	27	2	M120225	For off-hwy, shorter than OE			
			6.0	10x15	6.0	152	254x381	152	1.6	22	2	M122300	For off-hwy, shorter than OE			
DT817	385		5.0	10x15	5.0	127	254x381	127	2.0	27	5	M120131	For off-hwy, shorter than OE			
			5.0	10x15	5.0	127	254x381	127	2.3	31	5	M120450	OE replacement			
DT812B	320		5.0	10x15	5.0	127	254x381	127	2.0	27	5	M120131	For off-hwy, shorter than OE			
			5.0	10x15	5.0	127	254x381	127	2.3	31	5	M120450	OE replacement			
DT817C	420		5.0	10x15	5.0	127	254x381	127	2.0	27	5	M120131	For off-hwy, shorter than OE			
			5.0	10x15	5.0	127	254x381	127	2.3	31	5	M120450	OE replacement			
6.9L	170		3.5	8.3x11.5	4.0	89	211x292	102	0.9	12	4	M090547	OE replacement			
			4.0	10.0	4.0	102	254	102	0.7	10	4	M100052				
			4.0	11.0	4.0	102	279	102	0.6	8	4	M110112				
			4.0	10x15	4.0	102	254x381	102	0.7	9	4	M120367	Aftermarket, shorter than OE			
7.3L (T444)	175		3.5	8.3x11.5	4.0	89	211x292	102	1.0	13	4	M090547	OE replacement			
			3.5	8.3x11.5	4.0 OD	89	211x292	102 OD	0.6	8	4	M090548	OE replacement			
			4.0	10.0	4.0	102	254	102	0.8	11	4	M100052				
			4.0	11.0	4.0	102	279	102	0.7	9	4	M110112				
			4.0	11.0	4.0	102	279	102	0.7	9	4	M110148				
			4.0	11.0	4.0	102	279	102	0.7	9	4	M110311	Inlet dimension is OD			
			4.0	11.0	4.0	102	279	102	0.6	8	4	M111025	Inlet & outlet dimension is OD			
			4.0	10x15	4.0	102	254x381	102	0.8	10	4	M120367	Aftermarket, shorter than OE			
9.0L	185		3.5	8.3x11.5	4.0	89	211x292	102	1.4	19	4	M090547	OE replacement			
			3.5	8.3x11.5	4.0 OD	89	211x292	102 OD	0.9	12	4	M090548	OE replacement			
			4.0	10.0	4.0	102	254	102	1.1	15	4	M100052				
			4.0	11.0	4.0	102	279	102	0.9	13	4	M110112				
			4.0	11.0	4.0	102	279	102	0.9	13	4	M110148				
			4.0	11.0	4.0	102	279	102	0.9	13	4	M110311	Inlet dimension is OD			
			4.0	11.0	4.0	102	279	102	0.8	11	4	M111025	Inlet & outlet dimension is OD			
			5.0	10x15	5.0	127	254x381	127	0.6	8	4	M120366	OE replacement			
			4.0	10x15	4.0	102	254x381	102	1.1	15	4	M120367	Aftermarket, shorter than OE			
DT360	190		3.5	8.3x11.5	4.0	89	211x292	102	2.5	34	4	M090547	OE replacement			
			3.5	8.3x11.5	4.0 OD	89	211x292	102 OD	1.6	21	4	M090548	OE replacement			
			4.0	10.0	4.0	102	254	102	2.0	27	4	M100052				
			5.0	11.0	5.0	127	279	127	0.9	13	4	M110014	OE replacement			
			4.0	11.0	4.0	102	279	102	1.7	23	4	M110112				
			4.0	11.0	4.0	102	279	102	1.7	23	4	M110148				
			4.0	11.0	4.0	102	279	102	1.7	23	4	M110311	Inlet dimension is OD			
			4.0	11.0	4.0	102	279	102	1.5	20	4	M111025	Inlet & outlet dimension is OD			
			5.0	10x15	5.0	127	254x381	127	1.0	14	4	M120366	OE replacement			
			4.0	10x15	4.0	102	254x381	102	2.0	27	4	M120367	Aftermarket, shorter than OE			
DT466E	195 to 210		3.5	8.3x11.5	4.0 OD	89	211x292	102 OD	1.9	26	4	M090548	OE replacement			
			4.0	10.0	4.0	102	254	102	2.5	34	4	M100052				
			4.0	11.0	4.0	102	279	102	2.0	28	4	M110112				
			4.0	11.0	4.0	102	279	102	2.0	28	4	M110148				
			4.0	11.0	4.0	102	279	102	2.0	28	4	M110311	Inlet dimension is OD			
			4.0	11.0	4.0	102	279	102	1.8	24	4	M111025	Inlet & outlet dimension is OD			
			4.0	10x15	4.0	102	254x381	102	2.4	33	4	M120367	Aftermarket, shorter than OE			
			5.0	11.0	5.0	127	279	127	1.2	16	4	M110014	OE replacement			
			5.0	10x15	5.0	127	254x381	127	1.2	17	4	M120366	OE replacement			

Truck Engine Muffler Application

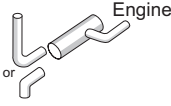

Engine Make & Exhaust System Configuration	Engine Model	H.P.	Muffler Dimensions						Backpressure		Muffler Style & Part No.	Notes	
			inches			mm			inches of Hg	H ₂ O			
	DT466E	230 to 275	3.5	8.3x11.5	4.0 OD	89	211x292	102 OD	2.3	31	4	M090548	OE replacement
			4.0	11.0	4.0	102	279	102	2.5	33	4	M110112	
			4.0	11.0	4.0	102	279	102	2.5	33	4	M110148	
			4.0	11.0	4.0	102	279	102	2.5	33	4	M110311	Inlet dimension is OD
			4.0	11.0	4.0	102	279	102	2.2	29	4	M111025	Inlet & outlet dimension is OD
			4.0	10x15	4.0	102	254x381	102	2.9	39	4	M120367	Aftermarket, shorter than OE
			5.0	11.0	5.0	127	279	127	1.4	19	4	M110014	OE replacement
			5.0	10x15	5.0	127	254x381	127	1.5	20	4	M120366	OE replacement
			3.5	8.3x11.5	4.0	89	211x292	102	1.5	21	4	M090547	OE replacement
			3.5	8.3x11.5	4.0 OD	89	211x292	102 OD	0.9	13	4	M090548	OE replacement
			4.0	10.0	4.0	102	254	102	1.2	17	4	M100052	
			4.0	11.0	4.0	102	279	102	1.0	14	4	M110112	
			4.0	11.0	4.0	102	279	102	1.0	14	4	M110148	
			4.0	11.0	4.0	102	279	102	1.0	14	4	M110311	Inlet dimension is OD
			4.0	11.0	4.0	102	279	102	0.9	12	4	M111025	Inlet & outlet dimension is OD
4.0	10x15	4.0	102	254x381	102	1.2	16	4	M120367	Aftermarket, shorter than OE			
5.0	11.0	5.0	127	279	127	0.6	8	4	M110014	OE replacement			
5.0	10x15	5.0	127	254x381	127	0.6	8	4	M120366	OE replacement			
DT420	225	3.5	8.3x11.5	4.0	89	211x292	102	1.2	17	4	M090547	OE replacement	
		3.5	8.3x11.5	4.0 OD	89	211x292	102 OD	0.8	10	4	M090548	OE replacement	
		4.0	10.0	4.0	102	254	102	1.0	13	4	M100052		
		4.0	11.0	4.0	102	279	102	0.8	11	4	M110112		
		4.0	11.0	4.0	102	279	102	0.8	11	4	M110148		
		4.0	11.0	4.0	102	279	102	0.8	11	4	M110311	Inlet dimension is OD	
		4.0	11.0	4.0	102	279	102	0.7	10	4	M111025	Inlet & outlet dimension is OD	
		4.0	10x15	4.0	102	254x381	102	1.0	13	4	M120367	Aftermarket, shorter than OE	
		5.0	11.0	5.0	127	279	127	0.6	8	4	M110014	OE replacement	
		5.0	10x15	5.0	127	254x381	127	0.6	8	4	M120366	OE replacement	
DT817	385	5.0	11.0	5.0	127	279	127	2.7	37	4	M110014	OE replacement	
		5.0	10x15	5.0	127	254x381	127	2.8	39	4	M120366	OE replacement	
		5.0	11.0	5.0	127	279	127	2.7	37	4	M110014	OE replacement	
		5.0	10x15	5.0	127	254x381	127	2.8	39	4	M120366	OE replacement	
		5.0	11.0	5.0	127	279	127	2.7	37	4	M110014	OE replacement	
		5.0	10x15	5.0	127	254x381	127	2.8	39	4	M120366	OE replacement	
		5.0	11.0	5.0	127	279	127	2.7	37	4	M110014	OE replacement	
		5.0	10x15	5.0	127	254x381	127	2.8	39	4	M120366	OE replacement	
6.9L	170	3.0	8.5	3.0	76	216	76	1.8	24	6	M085208		
		3.5	8.3x11.5	3.5	89	211x292	89	1.5	20	6	M090598		
		4.0	10.0	4.0	102	254	102	0.7	10	6	M100572		
		4.0	11.0	4.0	102	279	102	0.6	8	6	M111026	Outlet dimension is OD	
7.3L (T444)	175	3.0	8.5	3.0	76	216	76	2.0	27	6	M085208		
		3.5	8.3x11.5	3.5	89	211x292	89	1.6	22	6	M090598		
		4.0	10.0	4.0	102	254	102	0.8	11	6	M100572		
		4.0	11.0	4.0	102	279	102	0.6	9	6	M111026	Outlet dimension is OD	
9.0L	185	3.0	8.5	3.0	76	216	76	2.8	38	6	M085208		
		3.5	8.3x11.5	3.5	89	211x292	89	2.3	32	6	M090598		
		4.0	10.0	4.0	102	254	102	1.2	16	6	M100572		
		4.0	11.0	4.0	102	279	102	0.9	12	6	M111026	Outlet dimension is OD	
		5.0	10x15	5.0	127	254x381	127	0.6	8	6	M120418	For off-hwy, shorter than OE	
DT360	190	4.0	10.0	4.0	102	254	102	2.1	28	6	M100572		
		4.0	11.0	4.0	102	279	102	1.6	22	6	M111026	Outlet dimension is OD	
		5.0	10x15	5.0	127	254x381	127	1.0	14	6	M120418	For off-hwy, shorter than OE	
DT466E	195 to 210	4.0	10.0	4.0	102	254	102	2.5	35	6	M100572		
		4.0	11.0	4.0	102	279	102	2.0	27	6	M111026	Outlet dimension is OD	
		5.0	10x15	5.0	127	254x381	127	1.3	17	6	M120418	For off-hwy, shorter than OE	
DT466E	250 to 275	5.0	10x15	5.0	127	254x381	127	1.5	21	6	M120418	For off-hwy, shorter than OE	
		4.0	11.0	4.0	102	279	102	2.4	32	6	M111026	Outlet dimension is OD	
DT414	220	3.5	8.3x11.5	3.5	89	211x292	89	2.5	34	6	M090598		
		4.0	10.0	4.0	102	254	102	1.3	17	6	M100572		
		4.0	11.0	4.0	102	279	102	1.0	13	6	M111026	Outlet dimension is OD	
		5.0	10x15	5.0	127	254x381	127	0.6	9	6	M120418	For off-hwy, shorter than OE	
DT420	225	3.0	8.5	3.0	76	216	76	2.4	33	6	M085208		
		3.5	8.3x11.5	3.5	89	211x292	89	2.0	28	6	M090598		
		4.0	10.0	4.0	102	254	102	1.0	14	6	M100572		
		4.0	11.0	4.0	102	279	102	0.8	11	6	M111026	Outlet dimension is OD	
DT817	385	5.0	10x15	5.0	127	254x381	127	3.0	40	6	M120418	For off-hwy, shorter than OE	
DT812B	320	5.0	10x15	5.0	127	254x381	127	3.0	40	6	M120418	For off-hwy, shorter than OE	
DT817C	420	5.0	10x15	5.0	127	254x381	127	3.0	40	6	M120418	For off-hwy, shorter than OE	
6.9L	170	3.5	8.5	3.0	89	216	76	3.0	40	3	M085084		

Engine Make & Exhaust System Configuration	Engine Model	Engine H.P.	Muffler Dimensions inches			Muffler Dimensions mm			Backpressure inches of Hg / H ₂ O		Muffler Style & Part No.	Notes		
			Inlet	Body	Outlet	Inlet	Body	Outlet						
	7.3L (T444)	175	3.0	8.8	3.0	76	222	76	2.9	40	3	M085226	Wrapped muffler	
			3.5	8.3x11.5	3.5	89	211x292	89	1.6	22	3	M090301		
			4.0	11.0	4.0	102	279	102	0.8	10	3	M110479		
			4.0	11.0	4.0	102	279	102	0.7	10	3	M110674	Band clamp on inlet	
			4.0	11.0		102	279		0.7	9	3	M111024	Outlet has down spout	
			3.5	8.3x11.5	3.5	89	211x292	89	1.8	24	3	M090301		
		4.0	11.0	4.0	102	279	102	0.9	12	3	M110479			
		4.0	11.0	4.0	102	279	102	0.8	11	3	M110674	Band clamp on inlet		
		4.0	11.0		102	279		0.8	10	3	M111024	Outlet has down spout		
		9.0L	185	3.5	8.3x11.5	3.5	89	211x292	89	2.6	35	3	M090301	
		4.0		11.0	4.0	102	279	102	1.2	17	3	M110479		
		4.0		11.0	4.0	102	279	102	1.1	15	3	M110674	Band clamp on inlet	
	4.0	11.0			102	279		1.1	15	3	M111024	Outlet has down spout		
	5.0	10x15		5.0	127	254x381	127	0.7	10	3	M120235	OE replacement		
	DT360	190	4.0	11.0	4.0	102	279	102	2.2	30	3	M110479		
	4.0		11.0	4.0	102	279	102	2.0	27	3	M110674	Band clamp on inlet		
	4.0		11.0		102	279		2.0	27	3	M111024	Outlet has down spout		
	5.0		10x15	5.0	127	254x381	127	1.3	18	3	M120235	OE replacement		
	DT466E	195 to 210	4.0	11.0	4.0	102	279	102	2.7	37	3	M110479		
	4.0		11.0	4.0	102	279	102	2.5	34	3	M110674	Band clamp on inlet		
	4.0		11.0		102	279		2.4	33	3	M111024	Outlet has down spout		
	5.0		10x15	5.0	127	254x381	127	1.6	22	3	M120235	OE replacement		
	DT466E	250 to 275	4.0	11.0		102	279		2.9	39	3	M111024	Outlet has down spout	
	5.0		10x15	5.0	127	254x381	127	1.9	26	3	M120235	OE replacement		
	DT414	220	3.5	8.3x11.5	3.5	89	211x292	89	2.8	38	3	M090301		
	4.0		11.0	4.0	102	279	102	1.3	18	3	M110479			
	4.0		11.0	4.0	102	279	102	1.2	17	3	M110674	Band clamp on inlet		
	4.0		11.0		102	279		1.2	16	3	M111024	Outlet has down spout		
5.0	10x15		5.0	127	254x381	127	0.8	11	3	M120235	OE replacement			
DT420	225	3.5	8.3x11.5	3.5	89	211x292	89	2.2	30	3	M090301			
4.0		11.0	4.0	102	279	102	1.1	15	3	M110479				
4.0		11.0	4.0	102	279	102	1.0	13	3	M110674	Band clamp on inlet			
4.0		11.0		102	279		1.0	13	3	M111024	Outlet has down spout			
5.0		10x15	5.0	127	254x381	127	0.6	9	3	M120235	OE replacement			
Mack														
E9	500	5.0	9.0	5.0	127	229	127	1.9	26	1	M090535	Low backpressure, off-hwy		
		5.0	10.0	5.0	127	254	127	1.9	26	1	M100463	Low backpressure, off-hwy		
ENDT865	325	4.0	8.5	4.0	102	216	102	1.6	22	1	M085171			
		4.0	9.0	5.0	102	229	127	2.3	32	1	M090781			
		5.0	9.0	5.0	127	229	127	2.0	27	1	M090074			
		5.0	9.0	5.0	127	229	127	1.5	20	1	M090535	Low backpressure, off-hwy		
		5.0	10.0	5.0	127	254	127	1.1	14	1	M100463	Low backpressure, off-hwy		
		5.0	10.0	5.0	127	254	127	0.7	9	1	M100465	Best value, most popular		
		5.0	10.0	5.0	127	254	127	2.2	30	1	M100580	OE replacement		
		5.0	10.0	5.0	127	254	127	2.4	33	1	M100807	60" (1524mm) Long Body		
		5.0	10.0	5.0	127	254	127	1.8	24	1	M100944	OE replacement for higher HP		
		5.0	10.0	5.0	127	254	127	2.1	29	1	M101158	Silent Partner Stainless		
		5.0	10.0	5.0	127	254	127	2.1	29	1	M101181	Silent Partner Aluminized		
		5.0	10.0	5.0	127	254	127	2.2	30	1	M101263	Freightliner only		
		5.0	11.0	5.0	127	279	127	1.8	24	1	M110849			
ENDT866		375	4.0	8.5	4.0	102	216	102	2.0	27	1	M085171		
	4.0		9.0	5.0	102	229	127	2.8	38	1	M090781			
	5.0		9.0	5.0	127	229	127	2.4	32	1	M090074			
	5.0		9.0	5.0	127	229	127	1.3	17	1	M090535	Low backpressure, off-hwy		
	5.0		10.0	5.0	127	254	127	1.3	17	1	M100463	Low backpressure, off-hwy		
	5.0		10.0	5.0	127	254	127	0.8	11	1	M100465	Best value, most popular		
	5.0		10.0	5.0	127	254	127	2.7	36	1	M100580	OE replacement		
	5.0		10.0	5.0	127	254	127	2.9	39	1	M100807	60" (1524mm) Long Body		
	5.0		10.0	5.0	127	254	127	2.1	29	1	M100944	OE replacement for higher HP		
	5.0		10.0	5.0	127	254	127	2.6	35	1	M101158	Silent Partner Stainless		
	5.0		10.0	5.0	127	254	127	2.6	35	1	M101181	Silent Partner Aluminized		
	5.0	10.0	5.0	127	254	127	2.7	36	1	M101263	Freightliner only			
	5.0	11.0	5.0	127	279	127	2.1	29	1	M110849				
E7 or E6	300 to 350	4.0	8.5	4.0	102	216	102	0.9	12	1	M085171			

Truck Engine Muffler Application



Engine Make & Exhaust System Configuration	Engine Model	Engine H.P.	Muffler Dimensions inches			Muffler Dimensions mm			Backpressure inches of Hg H ₂ O		Muffler Style & Part No.	Notes
			Inlet	Body	Outlet	Inlet	Body	Outlet	Hg	H ₂ O		

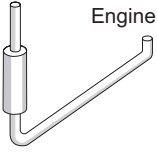

			5.0	9.0	5.0	127	229	127	1.1	15	1	M090074	
			5.0	9.0	5.0	127	229	127	0.6	8	1	M090535	Low backpressure, off-hwy
			4.0	9.0	5.0	102	229	127	1.3	17	1	M090781	
			5.0	10.0	5.0	127	254	127	0.6	8	1	M100463	Low backpressure, off-hwy
			5.0	10.0	5.0	127	254	127	0.4	5	1	M100465	Best value, most popular
			5.0	10.0	5.0	127	254	127	1.2	16	1	M100580	OE replacement
			5.0	10.0	5.0	127	254	127	1.3	18	1	M100807	60" (1524mm) Long Body
			5.0	10.0	5.0	127	254	127	1.0	13	1	M100944	OE replacement for higher HP
			5.0	10.0	5.0	127	254	127	1.2	16	1	M101158	Silent Partner Stainless
			5.0	10.0	5.0	127	254	127	1.2	16	1	M101181	Silent Partner Aluminized
			5.0	10.0	5.0	127	254	127	1.2	16	1	M101263	Freightliner only
			5.0	11.0	5.0	127	279	127	1.0	13	1	M110849	
			E7	400	4.0	8.5	4.0	102	216	102	1.1	15	1
4.0	9.0	5.0			102	229	127	1.6	22	1	M090781		
5.0	9.0	5.0			127	229	127	1.4	19	1	M090074		
5.0	9.0	5.0			127	229	127	0.7	10	1	M090535	Low backpressure, off-hwy	
5.0	10.0	5.0			127	254	127	0.7	10	1	M100463	Low backpressure, off-hwy	
5.0	10.0	5.0			127	254	127	0.5	6	1	M100465	Best value, most popular	
5.0	10.0	5.0			127	254	127	1.5	21	1	M100580	OE replacement	
5.0	10.0	5.0			127	254	127	1.7	23	1	M100807	60" (1524mm) Long Body	
5.0	10.0	5.0			127	254	127	1.2	17	1	M100944	OE replacement for higher HP	
5.0	10.0	5.0			127	254	127	1.5	20	1	M101158	Silent Partner Stainless	
5.0	10.0	5.0			127	254	127	1.5	20	1	M101181	Silent Partner Aluminized	
5.0	10.0	5.0			127	254	127	1.5	21	1	M101263	Freightliner only	
5.0	11.0	5.0			127	279	127	1.2	17	1	M110849		
E7	427 to 460	4.0	8.5	4.0	102	216	102	1.6	22	1	M085171		
		4.0	9.0	5.0	102	229	127	2.3	31	1	M090781		
		5.0	9.0	5.0	127	229	127	1.9	26	1	M090074		
		5.0	9.0	5.0	127	229	127	1.0	14	1	M090535	Low backpressure, off-hwy	
		5.0	10.0	5.0	127	254	127	1.0	14	1	M100463	Low backpressure, off-hwy	
		5.0	10.0	5.0	127	254	127	0.7	9	1	M100465	Best value, most popular	
		5.0	10.0	5.0	127	254	127	2.2	30	1	M100580	OE replacement	
		5.0	10.0	5.0	127	254	127	2.3	32	1	M100807	60" (1524mm) Long Body	
		5.0	10.0	5.0	127	254	127	1.7	24	1	M100944	OE replacement for higher HP	
		5.0	10.0	5.0	127	254	127	2.1	28	1	M101158	Silent Partner Stainless	
		5.0	10.0	5.0	127	254	127	2.1	28	1	M101181	Silent Partner Aluminized	
		5.0	10.0	5.0	127	254	127	2.2	30	1	M101263	Freightliner only	
		5.0	11.0	5.0	127	279	127	1.7	23	1	M110849		
E7	310/330 & 330/355	4.0	8.5	4.0	102	216	102	0.9	12	1	M085171		
		4.0	9.0	5.0	102	229	127	1.2	17	1	M090781		
		5.0	9.0	5.0	127	229	127	1.0	14	1	M090074		
		5.0	9.0	5.0	127	229	127	0.6	8	1	M090535	Low backpressure, off-hwy	
		5.0	10.0	5.0	127	254	127	0.6	8	1	M100463	Low backpressure, off-hwy	
		5.0	10.0	5.0	127	254	127	0.4	5	1	M100465	Best value, most popular	
		5.0	10.0	5.0	127	254	127	1.2	16	1	M100580	OE replacement	
		5.0	10.0	5.0	127	254	127	1.3	17	1	M100807	60" (1524mm) Long Body	
		5.0	10.0	5.0	127	254	127	0.9	13	1	M100944	OE replacement for higher HP	
		5.0	10.0	5.0	127	254	127	1.1	15	1	M101158	Silent Partner Stainless	
		5.0	10.0	5.0	127	254	127	1.1	15	1	M101181	Silent Partner Aluminized	
		5.0	10.0	5.0	127	254	127	1.2	16	1	M101263	Freightliner only	
		5.0	11.0	5.0	127	279	127	0.9	13	1	M110849		
E7	355/380	4.0	8.5	4.0	102	216	102	1.0	14	1	M085171		
		5.0	9.0	5.0	127	229	127	1.2	16	1	M090074		
		5.0	9.0	5.0	127	229	127	0.6	9	1	M090535	Low backpressure, off-hwy	
		4.0	9.0	5.0	102	229	127	1.4	19	1	M090781		
		5.0	10.0	5.0	127	254	127	0.6	9	1	M100463	Low backpressure, off-hwy	
		5.0	10.0	5.0	127	254	127	0.4	6	1	M100465	Best value, most popular	
		5.0	10.0	5.0	127	254	127	1.4	18	1	M100580	OE replacement	
		5.0	10.0	5.0	127	254	127	1.5	20	1	M100807	60" (1524mm) Long Body	
		5.0	10.0	5.0	127	254	127	1.1	15	1	M100944	OE replacement for higher HP	
		5.0	10.0	5.0	127	254	127	1.3	18	1	M101158	Silent Partner Stainless	
		5.0	10.0	5.0	127	254	127	1.3	18	1	M101181	Silent Partner Aluminized	
		5.0	10.0	5.0	127	254	127	1.4	18	1	M101263	Freightliner only	
		5.0	11.0	5.0	127	279	127	1.1	14	1	M110849		
E9	500	4.0	9.0	4.0	102	229	102	1.7	24	1	M090544		
		4.0	10.0	4.0	102	254	102	1.9	25	1	M100466		
		4.0	10.0	5.0	102	254	127	3.0	40	1	M100695		
		5.0	10.0	5.0	127	254	127	2.3	31	1	M100582	OE replacement	
		5.0	10.0	5.0	127	254	127	2.3	31	1	M101159	Silent Partner Stainless	
		5.0	10.0	5.0	127	254	127	2.3	31	1	M101182	Silent Partner Aluminized	
		5.0	11.0	5.0	127	279	127	1.2	17	1	M110849		
ENDT865	325		4.0	9.0	4.0	102	229	102	1.0	13	1	M090544	

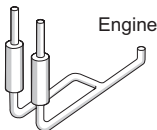

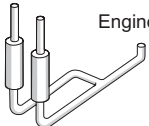
Engine Make & Exhaust System Configuration	Engine Model	H.P.	Muffler Dimensions inches			Muffler Dimensions mm			Backpressure inches of Hg / H ₂ O		Muffler Style & Part No.	Notes			
			Inlet	Body	Outlet	Inlet	Body	Outlet							
			4.0	10.3	4.0	102	262	102	1.9	26	1	M100464	Wrapped muffler		
			4.0	10.0	4.0	102	254	102	1.0	14	1	M100466			
			4.0	10.0	5.0	102	254	127	1.6	22	1	M100695			
			5.0	10.0	5.0	127	254	127	1.3	17	1	M100582	OE replacement		
			5.0	10.0	5.0	127	254	127	1.3	17	1	M101159	Silent Partner Stainless		
			5.0	10.0	5.0	127	254	127	1.3	17	1	M101182	Silent Partner Aluminized		
			5.0	11.0	5.0	127	279	127	0.7	9	1	M110849			
			ENDT866	375	4.0	9.0	4.0	102	229	102	1.2	16	1	M090544	
					4.0	10.3	4.0	102	262	102	2.3	31	1	M100464	Wrapped muffler
					4.0	10.0	4.0	102	254	102	1.2	17	1	M100466	
		4.0	10.0	5.0	102	254	127	2.0	27	1	M100695				
		5.0	10.0	5.0	127	254	127	1.5	21	1	M100582	OE replacement			
		5.0	10.0	5.0	127	254	127	1.5	21	1	M101159	Silent Partner Stainless			
		5.0	10.0	5.0	127	254	127	1.5	21	1	M101182	Silent Partner Aluminized			
		5.0	11.0	5.0	127	279	127	0.8	11	1	M110849				
E7 or E6	300 to 350	4.0	10.3	4.0	102	262	102	1.1	14	1	M100464	Wrapped muffler			
		4.0	10.0	5.0	102	254	127	0.9	12	1	M100695				
		5.0	10.0	5.0	127	254	127	0.7	9	1	M100582	OE replacement			
		5.0	10.0	5.0	127	254	127	0.7	9	1	M101159	Silent Partner Stainless			
		5.0	10.0	5.0	127	254	127	0.7	9	1	M101182	Silent Partner Aluminized			
E7	400	4.0	9.0	4.0	102	229	102	0.7	9	1	M090544				
		4.0	10.3	4.0	102	262	102	1.3	18	1	M100464	Wrapped muffler			
		4.0	10.0	4.0	102	254	102	0.7	10	1	M100466				
		4.0	10.0	5.0	102	254	127	1.1	15	1	M100695				
		5.0	10.0	5.0	127	254	127	0.9	12	1	M100582	OE replacement			
		5.0	10.0	5.0	127	254	127	0.9	12	1	M101159	Silent Partner Stainless			
		5.0	10.0	5.0	127	254	127	0.9	12	1	M101182	Silent Partner Aluminized			
E7	427 to 460	4.0	9.0	4.0	102	229	102	0.9	13	1	M090544				
		4.0	10.3	4.0	102	262	102	1.9	26	1	M100464	Wrapped muffler			
		4.0	10.0	4.0	102	254	102	1.0	14	1	M100466				
		4.0	10.0	5.0	102	254	127	1.6	22	1	M100695				
		5.0	10.0	5.0	127	254	127	1.2	17	1	M100582	OE replacement			
		5.0	10.0	5.0	127	254	127	1.2	17	1	M101159	Silent Partner Stainless			
		5.0	10.0	5.0	127	254	127	1.2	17	1	M101182	Silent Partner Aluminized			
		5.0	11.0	5.0	127	279	127	0.7	9	1	M110849				
E7	310/330 & 330/355	4.0	10.3	4.0	102	262	102	1.0	14	1	M100464	Wrapped muffler			
		4.0	10.0	5.0	102	254	127	0.9	12	1	M100695				
		5.0	10.0	5.0	127	254	127	0.7	9	1	M100582	OE replacement			
		5.0	10.0	5.0	127	254	127	0.7	9	1	M101159	Silent Partner Stainless			
		5.0	10.0	5.0	127	254	127	0.7	9	1	M101182	Silent Partner Aluminized			
E7	355/380	4.0	9.0	4.0	102	229	102	0.6	8	1	M090544				
		4.0	10.3	4.0	102	262	102	1.2	16	1	M100464	Wrapped muffler			
		4.0	10.0	4.0	102	254	102	0.6	8	1	M100466				
		5.0	10.0	5.0	127	254	127	0.8	10	1	M100582	OE replacement			
		4.0	10.0	5.0	102	254	127	1.0	14	1	M100695				
		5.0	10.0	5.0	127	254	127	0.8	10	1	M101159	Silent Partner Stainless			
		5.0	10.0	5.0	127	254	127	0.8	10	1	M101182	Silent Partner Aluminized			
ENDT865	325	4.0	9.0	5.0	102	229	127	3.0	40	3	M090823				
		5.0	10.0	5.0	127	254	127	2.9	39	3	M100213				
E7 or E6	300 to 350	4.0	9.0	5.0	102	229	127	1.7	23	3	M090823				
		4.0	11.8	5.0	102	300	127	1.8	24	3	M120598				
		5.0	10.0	5.0	127	254	127	1.6	21	3	M100213				
E7	400	4.0	9.0	5.0	102	229	127	2.2	29	3	M090823				
		4.0	11.8	5.0	102	300	127	2.3	31	3	M120598				
		5.0	10.0	5.0	127	254	127	2.0	27	3	M100213				
E7	457 to 460	4.0	9.0	5.0	102	229	127	3.0	41	3	M090823				
		5.0	10.0	5.0	127	254	127	2.8	38	3	M100213				
E7	310/330 & 330/355	4.0	9.0	5.0	102	229	127	1.6	22	3	M090823				
		4.0	11.8	5.0	102	300	127	1.7	24	3	M120598				
		5.0	10.0	5.0	127	254	127	1.5	21	3	M100213				
E7	355/380	4.0	9.0	5.0	102	229	127	1.9	26	3	M090823				
		4.0	11.8	5.0	102	300	127	2.0	27	3	M120598				
		5.0	10.0	5.0	127	254	127	1.8	24	3	M100213				
E6	350	3.0	11.0	4.0	76	279	102	2.4	33	1	M111029	OE replacement			

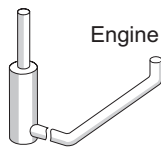

Truck Engine Muffler Application

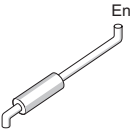

Engine Make & Exhaust System Configuration		Engine Model	H.P.	Muffler Dimensions						Backpressure		Muffler Style & Part No.	Notes			
				inches			mm			inches of Hg	H ₂ O					
				Inlet	Body	Outlet	Inlet	Body	Outlet							
				4.0	11.0	5.0	102	279	127	2.0	27	2	M111028	Inlet dimension is OD		
				4.0	10x15	4.0	102	254x381	102	2.9	39	2	M120100	Aftermarket, shorter than OE		
				5.0	10x15	5.0	127	254x381	127	2.1	29	2	M120108	For off-hwy, shorter than OE		
				5.0	10x15	5.0	127	254x381	127	1.4	19	2	M120225	For off-hwy, shorter than OE		
				5.0	10x15	5.0	127	254x381	127	2.2	31	2	M120365	Aftermarket		
				5.0	10x15	5.0	127	254x381	127	2.3	32	2	M120448	OE replacement		
				6.0	10x15	6.0	152	254x381	152	1.2	16	2	M122300	For off-hwy, shorter than OE		
				E9	500	6.0	10x15	6.0	152	254x381	152	2.9	39	2	M122300	For off-hwy, shorter than OE
				ENDT673	225	3.0	11.0	4.0	76	279	102	1.3	17	1	M111029	OE replacement
4.0	10.0	4.0	102			254	102	2.1	29	2	M100048	Aftermarket				
4.0	11.0	4.0	102			279	102	2.1	28	2	M110012					
4.0	11.0	4.0	102			279	102	1.9	25	2	M110189	OE replacement				
4.0	11.0	5.0	102			279	127	1.1	15	2	M111028	Inlet dimension is OD				
4.0	8.3x11.5	4.0	102			211x292	102	2.1	28	2	M090280	Aftermarket, shorter than OE				
4.0	8.3x11.5	4.0	102			211x292	102	1.9	26	2	M090534	Aftermarket, shorter than OE				
4.0	10x15	4.0	102			254x381	102	1.5	21	2	M120100	Aftermarket, shorter than OE				
5.0	10x15	5.0	127			254x381	127	1.1	15	2	M120108	For off-hwy, shorter than OE				
5.0	10x15	5.0	127			254x381	127	0.7	10	2	M120225	For off-hwy, shorter than OE				
5.0	10x15	5.0	127			254x381	127	1.2	16	2	M120365	Aftermarket				
5.0	10x15	5.0	127			254x381	127	1.2	17	2	M120448	OE replacement				
6.0	10x15	6.0	152			254x381	152	0.6	8	2	M122300	For off-hwy, shorter than OE				
ENDT675	235	3.0	11.0			4.0	76	279	102	1.4	19	1	M111029	OE replacement		
		4.0	10.0	4.0	102	254	102	2.3	31	2	M100048	Aftermarket				
		4.0	11.0	4.0	102	279	102	2.2	30	2	M110012					
		4.0	11.0	4.0	102	279	102	2.0	27	2	M110189	OE replacement				
		4.0	11.0	5.0	102	279	127	1.2	16	2	M111028	Inlet dimension is OD				
		4.0	8.3x11.5	4.0	102	211x292	102	2.3	31	2	M090280	Aftermarket, shorter than OE				
		4.0	8.3x11.5	4.0	102	211x292	102	2.1	29	2	M090534	Aftermarket, shorter than OE				
		4.0	10x15	4.0	102	254x381	102	1.7	23	2	M120100	Aftermarket, shorter than OE				
		5.0	10x15	5.0	127	254x381	127	1.2	17	2	M120108	For off-hwy, shorter than OE				
		5.0	10x15	5.0	127	254x381	127	0.8	11	2	M120225	For off-hwy, shorter than OE				
		5.0	10x15	5.0	127	254x381	127	1.3	18	2	M120365	Aftermarket				
		5.0	10x15	5.0	127	254x381	127	1.4	18	2	M120448	OE replacement				
		6.0	10x15	6.0	152	254x381	152	0.7	9	2	M122300	For off-hwy, shorter than OE				
		ENDT865	325	4.0	11.0	5.0	102	279	127	2.8	38	2	M111028	Inlet dimension is OD		
5.0	10x15			5.0	127	254x381	127	2.9	40	2	M120108	For off-hwy, shorter than OE				
5.0	10x15			5.0	127	254x381	127	1.9	26	2	M120225	For off-hwy, shorter than OE				
6.0	10x15			6.0	152	254x381	152	1.6	22	2	M122300	For off-hwy, shorter than OE				
ENDT866	375	5.0	10x15	5.0	127	254x381	127	2.3	31	2	M120225	For off-hwy, shorter than OE				
		6.0	10x15	6.0	152	254x381	152	1.9	26	2	M122300	For off-hwy, shorter than OE				
E7	300 to 350	3.0	11.0	4.0	76	279	102	1.8	24	1	M111029	OE replacement				
		4.0	10.0	4.0	102	254	102	3.0	40	2	M100048	Aftermarket				
		4.0	11.0	4.0	102	279	102	2.9	39	2	M110012					
		4.0	11.0	4.0	102	279	102	2.6	35	2	M110189	OE replacement				
		4.0	11.0	5.0	102	279	127	1.5	20	2	M111028	Inlet dimension is OD				
		4.0	8.3x11.5	4.0	102	211x292	102	2.9	39	2	M090280	Aftermarket, shorter than OE				
		4.0	8.3x11.5	4.0	102	211x292	102	2.7	37	2	M090534	Aftermarket, shorter than OE				
		4.0	10x15	4.0	102	254x381	102	2.2	29	2	M120100	Aftermarket, shorter than OE				
		5.0	10x15	5.0	127	254x381	127	1.6	22	2	M120108	For off-hwy, shorter than OE				
		5.0	10x15	5.0	127	254x381	127	1.0	14	2	M120225	For off-hwy, shorter than OE				
		5.0	10x15	5.0	127	254x381	127	1.7	23	2	M120365	Aftermarket				
5.0	10x15	5.0	127	254x381	127	1.7	24	2	M120448	OE replacement						
E7	400	4.0	11.0	5.0	102	279	127	1.9	26	2	M111028	Inlet dimension is OD				
		3.0	11.0	4.0	76	279	102	2.3	31	1	M111029	OE replacement				
		4.0	10x15	4.0	102	254x381	102	2.7	37	2	M120100	Aftermarket, shorter than OE				
		5.0	10x15	5.0	127	254x381	127	2.0	28	2	M120108	For off-hwy, shorter than OE				
		5.0	10x15	5.0	127	254x381	127	1.3	18	2	M120225	For off-hwy, shorter than OE				
		5.0	10x15	5.0	127	254x381	127	2.1	29	2	M120365	Aftermarket				
		5.0	10x15	5.0	127	254x381	127	2.2	30	2	M120448	OE replacement				
		6.0	10x15	6.0	152	254x381	152	1.1	15	2	M122300	For off-hwy, shorter than OE				
		E7	427	4.0	11.0	5.0	102	279	127	2.3	32	2	M111028	Inlet dimension is OD		
3.0	11.0			4.0	76	279	102	2.8	38	1	M111029	OE replacement				
5.0	10x15			5.0	127	254x381	127	2.5	33	2	M120108	For off-hwy, shorter than OE				
5.0	10x15			5.0	127	254x381	127	1.6	22	2	M120225	For off-hwy, shorter than OE				
5.0	10x15			5.0	127	254x381	127	2.6	35	2	M120365	Aftermarket				
5.0	10x15			5.0	127	254x381	127	2.7	37	2	M120448	OE replacement				
6.0	10x15			6.0	152	254x381	152	1.3	18	2	M122300	For off-hwy, shorter than OE				
E7	460	4.0	11.0	5.0	102	279	127	2.7	37	2	M111028	Inlet dimension is OD				

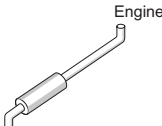
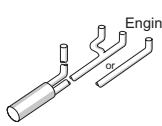
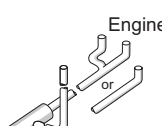
Engine Make & Exhaust System Configuration	Engine Model	H.P.	Muffler Dimensions inches			Muffler Dimensions mm			Backpressure inches of Hg / H ₂ O		Muffler Style & Part No.	Notes	
			Inlet	Body	Outlet	Inlet	Body	Outlet					
	E7	310/330 & 330/355	5.0	10x15	5.0	127	254x381	127	2.8	39	2	M120108	For off-hwy, shorter than OE
			5.0	10x15	5.0	127	254x381	127	1.9	25	2	M120225	For off-hwy, shorter than OE
			6.0	10x15	6.0	152	254x381	152	1.6	21	2	M122300	For off-hwy, shorter than OE
			3.0	11.0	4.0	76	279	102	1.7	24	1	M111029	OE replacement
			4.0	10.0	4.0	102	254	102	2.9	39	2	M100048	Aftermarket
			4.0	11.0	4.0	102	279	102	2.8	38	2	M110012	
			4.0	11.0	4.0	102	279	102	2.5	34	2	M110189	OE replacement
			4.0	11.0	5.0	102	279	127	1.5	20	2	M111028	Inlet dimension is OD
			4.0	10x15	4.0	102	254x381	102	2.1	29	2	M120100	Aftermarket, shorter than OE
			4.0	8.3x11.5	4.0	102	211x292	102	2.8	38	2	M090280	Aftermarket, shorter than OE
	4.0	8.3x11.5	4.0	102	211x292	102	2.7	36	2	M090534	Aftermarket, shorter than OE		
	5.0	10x15	5.0	127	254x381	127	1.5	21	2	M120108	For off-hwy, shorter than OE		
	5.0	10x15	5.0	127	254x381	127	1.0	14	2	M120225	For off-hwy, shorter than OE		
	5.0	10x15	5.0	127	254x381	127	1.6	22	2	M120365	Aftermarket		
	5.0	10x15	5.0	127	254x381	127	1.7	23	2	M120448	OE replacement		
	E7	355/380	3.0	11.0	4.0	76	279	102	2.0	27	1	M111029	OE replacement
			4.0	11.0	4.0	102	279	102	2.9	39	2	M110028	Laminated (double) body
			4.0	11.0	5.0	102	279	127	1.7	23	2	M111028	Inlet dimension is OD
			4.0	10x15	4.0	102	254x381	102	2.4	33	2	M120100	Aftermarket, shorter than OE
			5.0	10x15	5.0	127	254x381	127	1.8	24	2	M120108	For off-hwy, shorter than OE
		5.0	10x15	5.0	127	254x381	127	1.2	16	2	M120225	For off-hwy, shorter than OE	
		5.0	10x15	5.0	127	254x381	127	1.9	25	2	M120365	Aftermarket	
		5.0	10x15	5.0	127	254x381	127	1.9	26	2	M120448	OE replacement	
	ENDT865	325	5.0	10x15	5.0	127	254x381	127	1.9	26	5	M120131	For off-hwy, shorter than OE
			5.0	10x15	5.0	127	254x381	127	2.2	30	5	M120450	OE replacement
	ENDT866	375	5.0	10x15	5.0	127	254x381	127	2.3	31	5	M120131	For off-hwy, shorter than OE
			5.0	10x15	5.0	127	254x381	127	2.7	36	5	M120450	OE replacement
	E7 or E6	300 to 350	4.0	10x15	5.0	102	254x381	127	2.0	28	5	M120713	OE replacement
			5.0	10x15	5.0	127	254x381	127	1.0	14	5	M120131	For off-hwy, shorter than OE
			5.0	10x15	5.0	127	254x381	127	2.1	28	5	M120176	Aftermarket, shorter than OE
			5.0	10x15	5.0	127	254x381	127	2.1	28	5	M120189	Aftermarket, shorter than OE
			5.0	10x15	5.0	127	254x381	127	1.2	17	5	M120450	OE replacement
	E7	400	4.0	10x15	5.0	102	254x381	127	2.6	35	5	M120713	OE replacement
			5.0	10x15	5.0	127	254x381	127	1.3	18	5	M120131	For off-hwy, shorter than OE
			5.0	10x15	5.0	127	254x381	127	2.6	36	5	M120176	Aftermarket, shorter than OE
			5.0	10x15	5.0	127	254x381	127	2.6	36	5	M120189	Aftermarket, shorter than OE
			5.0	10x15	5.0	127	254x381	127	1.6	21	5	M120450	OE replacement
	E7	427 to 460	5.0	10x15	5.0	127	254x381	127	1.9	25	5	M120131	For off-hwy, shorter than OE
			5.0	10x15	5.0	127	254x381	127	2.2	30	5	M120450	OE replacement
	E7	310/330 & 330/355	4.0	10x15	5.0	102	254x381	127	2.0	27	5	M120713	OE replacement
			5.0	10x15	5.0	127	254x381	127	1.0	14	5	M120131	For off-hwy, shorter than OE
			5.0	10x15	5.0	127	254x381	127	2.0	27	5	M120176	Aftermarket, shorter than OE
			5.0	10x15	5.0	127	254x381	127	2.0	27	5	M120189	Aftermarket, shorter than OE
		5.0	10x15	5.0	127	254x381	127	1.2	16	5	M120450	OE replacement	
E7	355/380	4.0	10x15	5.0	102	254x381	127	2.3	31	5	M120713	OE replacement	
		5.0	10x15	5.0	127	254x381	127	1.2	16	5	M120131	For off-hwy, shorter than OE	
		5.0	10x15	5.0	127	254x381	127	2.3	31	5	M120176	Aftermarket, shorter than OE	
		5.0	10x15	5.0	127	254x381	127	2.3	31	5	M120189	Aftermarket, shorter than OE	
		5.0	10x15	5.0	127	254x381	127	1.4	18	5	M120450	OE replacement	
	E6	350	4.0	11.0	4.0	102	279	102	3.0	40	4	M111025	Inlet & outlet dimension is OD
			5.0	11.0	5.0	127	279	127	1.9	26	4	M110014	OE replacement
			5.0	10x15	5.0	127	254x381	127	2.0	27	4	M120366	OE replacement
	ENDT673	225	4.0	10.0	4.0	102	254	102	2.2	30	4	M100052	
			4.0	11.0	4.0	102	279	102	1.8	24	4	M110112	
			4.0	11.0	4.0	102	279	102	1.8	24	4	M110148	
			4.0	11.0	4.0	102	279	102	1.8	24	4	M110311	Inlet dimension is OD
			4.0	11.0	4.0	102	279	102	1.6	21	4	M111025	Inlet & outlet dimension is OD
			4.0	10x15	4.0	102	254x381	102	2.1	29	4	M120367	Aftermarket, shorter than OE
			5.0	11.0	5.0	127	279	127	1.0	14	4	M110014	OE replacement
			5.0	10x15	5.0	127	254x381	127	1.1	15	4	M120366	OE replacement
	ENDT675	235	4.0	10.0	4.0	102	254	102	2.4	32	4	M100052	
			4.0	11.0	4.0	102	279	102	1.9	26	4	M110112	
			4.0	11.0	4.0	102	279	102	1.9	26	4	M110148	

Truck Engine Muffler Application

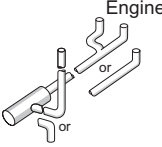
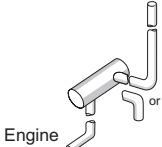
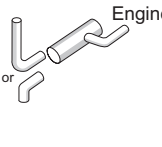

Engine Make & Exhaust System Configuration	Engine Model	H.P.	Muffler Dimensions						Backpressure		Muffler Style & Part No.	Notes			
			inches			mm			inches of Hg	H ₂ O					
	ENDT865	325	4.0	11.0	4.0	102	279	102	1.9	26	4	M110311	Inlet dimension is OD		
			4.0	11.0	4.0	102	279	102	1.7	23	4	M111025	Inlet & outlet dimension is OD		
			4.0	10x15	4.0	102	254x381	102	2.3	31	4	M120367	Aftermarket, shorter than OE		
			5.0	11.0	5.0	127	279	127	1.1	15	4	M110014	OE replacement		
			5.0	10x15	5.0	127	254x381	127	1.2	16	4	M120366	OE replacement		
			5.0	11.0	5.0	127	279	127	2.6	36	4	M110014	OE replacement		
			5.0	10x15	5.0	127	254x381	127	2.8	38	4	M120366	OE replacement		
			E7	300 to 350	4.0	10.0	4.0	102	254	102	2.7	36	4	M100052	
					4.0	11.0	4.0	102	279	102	2.2	30	4	M110112	
					4.0	11.0	4.0	102	279	102	2.2	30	4	M110148	
4.0	11.0	4.0			102	279	102	2.2	30	4	M110311	Inlet dimension is OD			
4.0	11.0	4.0			102	279	102	1.9	26	4	M111025	Inlet & outlet dimension is OD			
4.0	10x15	4.0			102	254x381	102	2.6	35	4	M120367	Aftermarket, shorter than OE			
5.0	11.0	5.0			127	279	127	1.3	17	4	M110014	OE replacement			
5.0	10x15	5.0			127	254x381	127	1.3	18	4	M120366	OE replacement			
	E6	350	5.0	10x15	5.0	127	254x381	127	2.1	29	6	M120418	For off-hwy, shorter than OE		
	ENDT673	225	4.0	10.0	4.0	102	254	102	2.2	30	6	M100572			
			4.0	11.0	4.0	102	279	102	1.7	24	6	M111026	Outlet dimension is OD		
			5.0	10x15	5.0	127	254x381	127	1.1	15	6	M120418	For off-hwy, shorter than OE		
	ENDT675	235	4.0	10.0	4.0	102	254	102	2.4	33	6	M100572			
			4.0	11.0	4.0	102	279	102	1.9	26	6	M111026	Outlet dimension is OD		
			5.0	10x15	5.0	127	254x381	127	1.2	17	6	M120418	For off-hwy, shorter than OE		
	ENDT865	325	5.0	10x15	5.0	127	254x381	127	2.9	39	6	M120418	For off-hwy, shorter than OE		
	E7	300	4.0	10.0	4.0	102	254	102	2.7	37	6	M100572			
			4.0	11.0	4.0	102	279	102	2.1	29	6	M111026	Outlet dimension is OD		
5.0			10x15	5.0	127	254x381	127	1.4	19	6	M120418	For off-hwy, shorter than OE			
E7	350	4.0	11.0	4.0	102	279	102	2.4	33	6	M111026	Outlet dimension is OD			
		5.0	10x15	5.0	127	254x381	127	1.6	21	6	M120418	For off-hwy, shorter than OE			
	E6	350	4.0	10x15	5.0	102	254x381	127	2.4	32	3	M120566	OE replacement		
			5.0	10x15	5.0	127	254x381	127	2.6	36	3	M120235	OE replacement		
	ENDT673	225	4.0	11.0	4.0	102	279	102	2.4	32	3	M110479			
			4.0	11.0	4.0	102	279	102	2.2	30	3	M110674	Band clamp on inlet		
			4.0	11.0		102	279		2.1	29	3	M111024	Outlet has down spout		
			5.0	10x15	5.0	127	254x381	127	1.4	19	3	M120235	OE replacement		
	ENDT675	235	4.0	11.0	4.0	102	279	102	2.6	35	3	M110479			
			4.0	11.0	4.0	102	279	102	2.4	32	3	M110674	Band clamp on inlet		
			4.0	11.0		102	279		2.3	31	3	M111024	Outlet has down spout		
			5.0	10x15	5.0	127	254x381	127	1.5	21	3	M120235	OE replacement		
			4.0	10x15	5.0	102	254x381	127	1.4	19	3	M120566	OE replacement		
	E7	300 to 350	4.0	11.0		102	279		3.0	40	3	M111024	Outlet has down spout		
			4.0	10x15	5.0	102	254x381	127	1.8	24	3	M120566	OE replacement		
			5.0	10x15	5.0	127	254x381	127	2.0	27	2	M120235	OE replacement		

This catalog section contains equipment manufacturers' and competitive manufacturers' part numbers cross referenced to the Donaldson part number. The manufacturers' names are abbreviated in the catalog.

The data in this catalog is also available from our website at donaldson.com. This cross reference information was compiled from available Donaldson data and should be used as a guide for choosing the proper replacement part. Check the product specifications BEFORE purchasing a part.

Manufacturers' Code Listing

Mfg. Code	Manufacturers' Name	Mfg. Code	Manufacturers' Name	Mfg. Code	Manufacturers' Name	Mfg. Code	Manufacturers' Name
AA	AMERICAN AUGERS	BATI	BENATI	COLT	COLT	EAC	ENGINE AND ACCESSORY INC
ABG	ABG	BDER	BOMBARDIER	COMP	COMPAC EQUIPMENT	EAGL	EAGLE TRUCK PRODUCTS
ABPS	AIRBORNE PRODUCT	BEQP	BELL EQUIPMENT	COMPAC	COMPACT TECHNOLOGIES	EAGP	EAGLE PICHER
AC	AC	BIAM	BUS INDUSTRIES	CONK	CONEK	EARN	EARNEST MACHINE
ACFT	ACRAFIT	BLDY	BLUE BIRD BODY	COUG	COUGLAR INDUSTRIES	EATN	EATON
ACMS	ALLIS CHALMERS	BLNT	BLOUNT	CRAN	CRANE CARRIER	ECLD	EUCLID
ADUM	ADVANCE MIXER	BLWL	BLACKWELDERS	CRMY	CHAMPION ROAD	ECS	ENGINE CONTROL SYSTEMS
AECW	A E C WHITLOCK	BMY	BMY WHEELED VEHICLES	CRPD	CEDARAPIDS	EGLE	EAGLE CRUSHER
AFC	AL FILTER CO	BNTA	BANTA ASSOCIATES	CRQT	CARQUEST	EIMC	EIMCO
AGCA	ACTIVE GEAR	BOMA	BOMAG	CSND	CROSLAND	EINT	EAGLE INTERNATIONAL
AGCO	AGCO	BORG	BORG-WARNER CHEMICALS	CTRY	CENTURY II	ELECT	ELECTROLUX
AGEM	AG CHEM EQUIPMENT	BOSS	BOSS INDUSTRIES	CUCC	CUB CADET	ELGN	ELGIN
AJMC	AUTO JET	BRED	BREDA COSTRUZIONI	CUMS	CUMMINS	EMOI	EMERGENCY ONE, INC.
ALMD	ALLMAND BROS	BRLEE	B R LEE INDUSTRIES	CYPR	CYPRESS	EMSN	EMERSON ELECTRIC
ALMN	AHLMANN	BROD	BRODERSON	DACR	DAVEY COMPRESSOR	ENGL	ENGELHARD CORP
ALP	ALLIANCE PARTS	BROW	BROWN DESIGN	DAEW	DAEWOO	ENGL	ENGLEHARD CORP
ALSN	ALLISON	BRWY	BROCKWAY	DART	DART	ENGN	ENGINES INC
ALSY	ALLIED SYSTEM	BVER	BUHLER VERSATILE SERVICE	DCOA	DYNAMICS CORP OF AMERICA	ENMT	ENMTP CPG
AMBC	AMBAC			DCVG	DANA CORP	ENTW	ENTWISTLE COMPANY
AMC	AMC			DD	DETROIT DIESEL	ERIC	ERICKSON
AMEC	AM GENERAL			DENY	DENYO	ESSEX	ESSEX ELECTRO ENGES
AMERIC	AMERICAN CRANE CORP	CABT	CABOT CORP	DETZ	DEUTZ	FAS	FASTENAL
AMFGI	AURORA MFG INC	CALD	CARRIER TRANSICOLD	DFLX	DYNAFLEX	FAST	FASTENWARE
AMHO	AMERICAN HOIST & DERRICK	CAM	CAMOPLAST INDUSTRIAL	DIA	DIAMANT BOART INC	FAUN	FAUN
AMLF	AMERICAN LAFRANCE	CAME	COMPACTION AMERICA	DINA	DINA SA	FDEN	FODEN
AMTK	AMTRAK	CANF	CANADIAN FILTER	DIND	DIAMOND	FDQN	FIELD QUEEN
AP	A P PARTS	CASE	CASE	DLEQ	DIGITAL EQUIPMENT	FEDM	FEDERAL MOTORS
APE	APE INDUSTRI AB	CAT	CATERPILLAR	DLTC	DRILTECH	FEDR	FEDERAL-MOGUL
ARDCO	ARDCO	CBM	CBM	DMAG	DEMAG	FENT	FENDT
ARRO	ARROW-MASTER	CC	COUNTRY COACH	DMI	DMI	FIAT	FIAT
ARV	ARVIN	CCML	CORNELL CRANES	DMON	DOMINION	FILTER	FILTER SUPPLY CO
AST	ASTEC UNDERGROUND	CDIV	CONTINENTAL DIVERSIFIED	DMT	DMT CORP	FIVE	FIVE STAR MFG LLC
ASTEC	ASTEC	CEDAR	CEDARRAPIDS INC	DRBG	DRONNINGBORG	FLPW	FLUID POWER
ASV	ASV INC	CETCO	CETCO INC	DRDT	DROTT	FLTR	FILTER INC
ATCO	ATLAS COPCO	CHAMP	CHAMPION INDUSTRIES	DREO	DIAMOND REO	FLYR	FLYER INDUSTRIES
ATHEY	ATHEY/FIVE STAR PRODUCTS	CHAP	CHAMP	DRSS	DRESSER	FMC	FMC
ATHM	ALSTHOM	CHARD	CHARDONNET	DSL	DIESEL DIVISION	FMCO	FORD
ATHP	ATHEY	CHLN	CHICAGO PNEUMATIC	DWCH	DITCH WITCH	FMHD	FARMHAND
AUST	AUSTOFT	CHLR	CHRYSLER	DYPC	DYNAPAC	FMNT	FERMONT DIV
AUTM	AUTO MARINE	CLAC	CADILLAC & LAKE CITY ROADWAY			FNEQ	FINN FILTER
AUXI	AUXIFLOW	CLJL	CLARK, J.L.			FOREM	FOREMOST INDUSTRIES
		CLMP	CLAMPS INC.			FPCO	FAPCO INC
BABR	BARBER GREENE	CLRK	CLARK			FRAM	FRAM
BADG	BADGER	CMCO	CAMECO			FREQ	FRANKLIN
BAESYS	BAE SYSTEMS	CMI	CMI			FRHF	FATE ROOT HEATH FASTEN
BAKO	BARKO HYDRAULICS	CMPR	COMPAIR			FRTL	FREIGHTLINER
BAR	BAUER	CMWK	CHARLES MACHINE				
		CNLC	CURTIS NOLL				

Mfg. Code	Manufacturers' Name	Mfg. Code	Manufacturers' Name	Mfg. Code	Manufacturers' Name
RTWC	RAILWAY TRACK WORK	TJAK	TIMBERJACK	WLDN	WALDON
RVI	RENAULT VI	TJMG	T & J MFG	WLKR	WALKER MFG
RWMF	RAINBOW MFG	TKNG	THERMO KING	WPOW	WINPOWER
RXRD	REXNORD	TMCO	TYMCO	WRNR	WARNER & SWASEY
RYCO	RYCO	TMLS	TEXTRON MARINE AND LAND SYSTEM	WRTH	WORTHINGTON
RYGO	RAYGO	TMPO	TAMPO	WSTI	WESTERN STAR TRUCK
RYKE	RYKEN TUBE	TMRK	TAMROCK	WTLK	WHITLOCK
SABI	SABIEX INTERNATIONAL	TMTR	TOWMOTOR	XAIR	EX AIR
SAKR	SAKURA	TORCA	TORCA PRODUCTS	XMN	EXMAN
SAME	SAME	TPORT	TUNED PORT INDUCTION SPEC	YALE	YALE
SCHAE	SCHAEFF LIFT TRUCK INC	TRAK	TRAK INTERNATIONAL	YOUNM	YOUNG MACHINE COMPANY
SCNA	SCANIA	TREX	TEREX	YPEI	YORK PUMP & EQPT
SCOMP	SUPERIOR COMPRESSOR	TRJN	TROJAN		
SCOMPA	SUPERPAK COMPACTION	TRMF	TRANSPORTATION MFG		
SCRD	SICARD	TRUX	TRUCKEX		
SCRM	SCHRAMM	TYLE	TYLER POWER PRODUCTS		
SDMO	SDMO	TYLR	TAYLOR		
SDVK	SANDVIK	TYMC	TAYMECH		
SEDD	SEDDON-ATKINSON				
S-FIRE	SEAGRAVE FIRE APPARATUS	U C	UNITED CENTRAL INDUSTRIAL SUPP		
SHBR	SCOTT HUBER	UAC	UNITED AIR CLEANER		
SHUT	SHUTTLELIFT INC	UCP	UNIVERSAL COACH PARTS		
SIGM	SIGMA AIR CONDITIONING	UNCT	UNION CITY BODY		
SISU	SISU	UNIP	UNIPART		
SKYJ	SKYJACK	UNVL	UNIVERSAL		
SLAR	SULLAIR	UPFR	UP FRONT TECHNOLOGIES		
SLIC	SELLICK EQPT LTD	UPRH	UP-RIGHT HARVESTER		
SLVN	SULLIVAN	UPTI	UPTME PARTS LLC		
SMCI	SAFARI MOTOR COACHES INC	URIG	UNIT RIG EQUIPMENT		
SNBL	SNOWBLAST-SICARD				
SNKL	SNORKEL	VACT	VECTOR MFG		
SOFI	SOFIMA	VALM	VALMET		
SPCH	SPARTAN CHASSIS	VANAI	VANAIR MFG		
SPRT	SPARTAN MOTORS	VCOR	VERSATUBE		
SRC	SRC	VENCH	VENCHURES PACKAGING INC		
SRSO	SAUER SUNDSTRAND	VH	VAN HOOL		
STEW	STEWART & STEVENSON	VIC	VIC		
STGR	STEIGER	VLVO	VOLVO		
STIL	STILL	VME	VME		
STMC	STEMCO	VMER	VERMEER		
SUSN	SUSAN	VOEG	VOEGELE		
SWEE	SWEEPSTER JENKINS	VSTL	VERSATILE		
SYNER	SYNERGY INTERNATIONAL				
TAC	TRANSPORTATION ACCESSORIES	WALMO	WALGAHN- MOTORENTECHN		
TBBI	THOMAS BUILT BUSES	WBCO	WABCO		
TBCR	TUBE CRAFT	WGMC	WHITEGMC		
TCLD	TRANSICOLD	WGNR	WAGNER MINING EQPT		
TDSC	TRACKMOBILE	WHCO	WHITING		
TDYN	TELEDYNE	WHITE	WHITE		
TENT	TENNANT	WHMS	WESTINGHOUSE MFG SERVICES		
TERN	TERNESS PROCUREMENT SERVICES	WILM	WILMAR		
TESSI	TESSI TRUCK EXHAUST INC	WIMC	WIMCO LTD		
THOM	THOMAS DENNIS CO INC	WIRG	WIRTGEN		
TIM	TIM	WIX	WIX		
TIPP	TIPPECANOE	WKSA	WAUKESHA		

Cross Reference

(See the first page of this section for the Manufacturer's Code Listing)



CROSS REFERENCE

Mfgs. No.	Our No.	Mfg. Code	Mfgs. No.	Our No.	Mfg. Code	Mfgs. No.	Our No.	Mfg. Code	Mfgs. No.	Our No.	Mfg. Code	Mfgs. No.	Our No.	Mfg. Code
0														
000	P206309 TESSI	00642050	M065030 FWD	00811194	P206345	WALMO	0158454000	M001865 GILB	022066001	H002132 DLTC
0000001	M080024 MNTW	007587001	M120225SDVK	00811195	P206347	WALMO	0158454001	M002135 GILB	022086001	M001505DLTC
0000136929	M100043CASE	007824	X007824RWMF	00811196	P206367	WALMO	0166395	M085023GRDL		M001505SDVK
00008223	M085090HAVA	008024001	M120131DLTC	00811197	P206368	WALMO	0170019323	X004538CMCO	02250158064	M100016SLAR
00011101	M100049DYPC		M120131TMRK	00811198	P206369	WALMO	01719323	X004538CMCO	02250162449	M090362SLAR
00023267	P206407DYPC		M120131TMRK	00811199	P206552	WALMO	017385	X004482KRES	02250164249	M090362SLAR
00023275	P206409DYPC	0080831	M120450DLTC	00811200	P206553	WALMO	0175550004	X004484WHMS	02250168659	M080024SLAR
00023374	M090210DYPC	00810204	H001032WALMO	00811201	P206554	WALMO		X004484SLVN	02250169088	J008681SLAR
00023481	P208338DYPC	00810205	H001033	WALMO	00811202	P206555	WALMO	01805756	M120598	MONAC	02250171832	M065139SLAR
00035006	X004480DYPC	00810206	H001034	WALMO	00811203	P206556	WALMO	019003760008	P207408PALA	02250183598	M120713SLAR
0009555007	X004538LNDE	00810207	H001035	WALMO	00811204	J024836	WALMO	019012000015	P207394PALA	02250184033	M090072SLAR
001482001	P206403DLTC	00810228	H001278	WALMO	00811205	J024838	WALMO	019012000017	P206323PALA	02250186513	M090594SLAR
001487001	M122300TMRK	00810229	H001279	WALMO	00811206	P206559	WALMO	019015690044	P206395PALA	02250186652	P206304SLAR
	M122300SDVK	00810234	H001284	WALMO	00811207	P206600	WALMO	020002804155	P206405VLVO	027076523	M085023WGMC
	M122300DLTC	00810259	M045123	WALMO	00811208	P206603	WALMO	020004343116	X004478VLVO	027076528	M085189VLVO
0015012	P207335DLTC	00810260	M045193	WALMO	00811209	P206608	WALMO	020004343154	X004482VLVO		M085023WGMC
0015013	P206341DLTC	00810261	M045237	WALMO	00811210	P206610	WALMO	020004362138	P206614VLVO	027076533	M090159WGMC
0015017	P206350DLTC	00810262	M045193	WALMO	00811211	P206611	WALMO	020006	M060158LOES	027076535	M120197WGMC
0016459000	P206601CUMS	00810263	M060037	WALMO	00811212	P206641	WALMO	0200317	M120598SMCI	027076537	M100049WGMC
0019273	P206410CMCO	00810264	M060038	WALMO	00811213	P207353	WALMO	0201101	M100213SMCI	027076541	M120100WGMC
00197721	M085023FWD	00810268	M060232	WALMO	00811214	P207364	WALMO	020138	P270542LOES	027076542	M120365VLVO
0024008800	M100016RVI	00810270	M060158	WALMO	00811216	P207402	WALMO	020147	M065044LOES		M120365WGMC
0024008900	P207596RVI	00810271	M065065	WALMO	00811218	P270531	WALMO	020177	M065044LOES	027076544	M090074WGMC
00265445	M060037NH	00810272	M065030	WALMO	00811219	P270532	WALMO	020176	P206405LOES	027076545	M100048WGMC
0028017544	P270535VLVO	00810274	M065044	WALMO	00811220	P270533	WALMO	020183	M085084LOES	027076560	X004480WGMC
0028041569	P206337VLVO	00810281	M070008	WALMO	00811221	P270534	WALMO	020243	M090158LOES		X004480WHITE
0028041585	P206408VLVO	00810283	M070068	WALMO	00811222	P270535	WALMO	020293	M090158LOES		X004480WSTI
003056003	X004476DLTC	00810284	M070069	WALMO	00811223	P270536	WALMO	020321	P206544LOES	027076561	X004482WSTI
003056007	X004482DLTC	00810285	M070008	WALMO	00811225	P270538	WALMO	020323	P206407LOES		X004482WGMC
003056008	X004484DLTC	00810287	M080018	WALMO	00811226	P270539	WALMO	020332	H001035LOES		X004482WHITE
0032941	X004478CUMS	00810288	M080024	WALMO	00811227	P270540	WALMO	020345	M060037LOES		X004482VLVO
003466001	M120225DLTC	00810290	M080018	WALMO	00811228	P270541	WALMO	020390118	M065034HARL	027076562	X004484WSTI
004002728000	M090280CMI	00810293	M085078	WALMO	00811229	P270542	WALMO	020395	P206408LOES		X004484WHITE
004002746000	P207667CMI	00810295	M085084	WALMO	00811230	P270543	WALMO	020519	P270538LOES		X004484VLVO
004002764000	P207667CMI	00810297	M085023	WALMO	00811683	X004476	WALMO	020563	M085208LOES		X004484WGMC
004002768000	M120131CMI	00810298	M085008	WALMO	00811684	X004478	WALMO	020566001	M140048SDVK	027076626	X004476WSTI
004002833000	P270535CMI	00810300	M085090	WALMO	00811685	X004480	WALMO		M140048DLTC		X004476VLVO
004002938000	P206408CMI	00810301	M085056	WALMO	00811686	X004482	WALMO	020566002	M190002DLTC		X004476WGMC
004002958000	P270538CMI	00810304	M090091	WALMO	00811687	X004484	WALMO	020570	M060038LOES	027076627	X004478WHITE
004002977000	P206342CMI	00810305	M090158	WALMO	00811688	X004536	WALMO	021021	P206406LOES		X004478VLVO
004003012000	M122300CMI	00810306	M090535	WALMO	00811689	X004537	WALMO	021022	P206410LOES		X004478WGMC
004003020000	P270543CMI	00810311	M090535	WALMO	00811690	X004538	WALMO	021100	M090091LOES		X004478WSTI
004003036000	M100213CMI	00810313	M090146	WALMO	00811691	X004539	WALMO	021453	P206409LOES	0270825	X004476HSTR
004003064000	M120225CMI	00810314	M090301	WALMO	00811696	X004962	WALMO	021475	X004536LOES		X004476CAME
004013140000	M085207CMI	00810315	M090099	WALMO	00811706	P207339	WALMO	021478	X004539LOES		X004476NACO
004013174000	M085207CMI	00810318	M090170	WALMO	0081383318	P207414CMCO	021480	X004478LOES	02708250000	X004476HSTR
004013195000	M120418CMI	00810319	M090538	WALMO	0091327799	H001039CMCO	021482	X004482LOES	0270826	X004478HSTR
004013216000	P206328CMI	00810320	M090535	WALMO	00L02468011	M070008PTBN	021483	X004484LOES		X004478NACO
004013287000	M170101CMI	00810321	M100016	WALMO	010150202000	P206319DYPC	021576	P270530LOES	027136876	X004482WGMC
004013309000	P206304CMI	00810322	M100043	WALMO	0111379931	P207402CMCO	021636	H001278LOES		X004482WHITE
004013311000	M090594CMI	00810325	M100048	WALMO	0116043541	P270543SAME	021673	P226148LOES	027137738	M100464WGMC
004013368000	P207292CMI	00810327	M100213	WALMO	011781	P270540LOES	021769	M070068LOES	027138775	M100146VLVO
004013453000	M190002CMI	00810328	M100146	WALMO	012411006	J190063SPCH	021785	P270543LOES		M100146WGMC
004094239160	P206607CMI	00810334	M120365	WALMO		J190063SPRT	021835	P206603LOES	0303234	P207415ASV
004192730004	M070068PALA	00810335	M120225	WALMO	01290055	M122300SCRM	021843	P270534LOES	030495	M070008KSHA
00420920	M080024FWD	00810336	M120131	WALMO	01290056	M120108SCRM	021857	M080018LOES	031005070	M120108CAME
0043621341	H001278VLVO	00810337	M120197	WALMO	013706	M045237RIKL	021859	P270532LOES	031984001	P206318DLTC
00496696	M090091FWD	00810339	M120131	WALMO	01409T	M080018NLSN	021885	P270536LOES	0323479000	H001034FRTL
00502571	M085056DYPC	00810341	M120176	WALMO	01522291	M100465BLDY	021886	M085078LOES		H001034MERS
005191020001	M070028PALA	00810344	M120365	WALMO	0152826000	X007830GILB	021915	H001279LOES	037281	M070050DRDT
005191360009	P270541PALA	00810345	M120189	WALMO	0152826001	X007784GILB	021919	H001284LOES	03830005	P206603SCRM
005192730004	M070068PALA	00810346	M120197	WALMO	0152826002	X007785GILB	021921	P270539LOES	03830008	X004476SCRM
	M070068SLVN	00810347	M120225	WALMO	0153025	M085056CAME	021946	P206552LOES	03830009	X004478SCRM
005194700012	P206411PALA	00810348	M120100	WALMO	0154799N000	J240003GILB	021978	P270541LOES	03861	P206282DMT
00531742	M120100FWD	00810349	M080018	WALMO	01552235	M065065ONAN	021987	M100213LOES	039263	M085008DRDT
00533938	M090544FWD	00810352	M170101	WALMO	01552305	M026410ONAN	021990	P226149LOES	03B0985A0	P206400JNDR
00538885F00	X004480CONK	00810354	M190002	WALMO	0155304N000								

Mfgs. No.	Our No.	Mfg. Code	Mfgs. No.	Our No.	Mfg. Code	Mfgs. No.	Our No.	Mfg. Code	Mfgs. No.	Our No.	Mfg. Code	Mfgs. No.	Our No.	Mfg. Code
0417179006	M100944	MERS	050174500006	P270532	PALA	0522291321	P207326	FOREM	0573202020	M085410	CAME	0777306	M070008	RYGO
	M100944	FRTL	050174500010	P270534	PALA	0522292598	P207353	FOREM	05735409	M085078	BOMA		M070008	CAT
0417979000	M101263	MERS	050174500014	P270536	PALA	0522294388	P207341	FOREM		M085078	CAME	0779548	P206407	RYGO
0418334002	M111029	MERS	050174500020	P270539	PALA	0523282276	M120131	FOREM	05735602	P207326	CAME		P206407	CAT
	M111029	FRTL	050187500029	M090595	PALA	0523284133	P206517	FOREM		P207326	BOMA	079434	M065034	WLDN
0418814000	M111028	FRTL	050187550009	M002119	PALA	0523286128	M100213	FOREM		P207326	KOEH		M065034	MOB
	M111028	MERS	050187550011	M002118	PALA	0525091758	J000212	FOREM	05735603	P208324	BOMA	0795570C1	M120108	NAVI
0418814003	M111028	FRTL	050187550014	M002120	PALA	0525258059	P207339	FOREM		P208324	CAME	080304	P213191	LOES
	M111028	MERS	05018785	M100049	PALA	0529LL1001	M001865	SPRT	05735604	P208326	CAME	080315	P206309	LOES
0418814007	M111025	FRTL	050187850019	M120176	PALA		M001865	SPCH		P208326	BOMA	080324	P206280	LOES
	M111025	MERS	050187850023	M100049	PALA	053117778	M085008	WGMC	057482	P270539	MOXY	080325	P206600	LOES
041889	M100048	GEHL	050187850027	M100048	PALA	0532603	M070028	ECLD	05910121	M045193	CAME	080326	P207326	LOES
0419131004	M111029	FRTL	050187850028	M085208	PALA	053394	H001039	KRES	059584	X004484	MOXY	080335	P207415	LOES
	M111029	MERS	050187850029	M090595	PALA	0536951	X004476	CONK	059617	M001432	AGEM	080341	P206403	LOES
0419131007	M111029	FRTL	050187850033	M085207	PALA		X004476	CAT	0596LL1001	P206606	SPRT	080342	P206607	LOES
	M111029	MERS	050187850035	M080018	PALA		X004476	EAGP		P206606	SPCH	080357	P206308	LOES
0422667000	M110014	MERS	050187850039	M120131	PALA		X004476	DAEW	0596LL1002	P206607	SPCH	080359	P206334	LOES
	M110014	FRTL	050187850041	M065140	KLTC	053791	X004484	FLYR	06005G	M120100	OKSH	080375	P207382	LOES
04320102	M090544	DRSS		M065140	PALA		X004484	NEWFLY	060094217	M085090	BROD	080376	P206339	LOES
	M090544	KTSU	050187850042	M085411	PALA	0538885	X004480	RYGO	060094406	M080018	BROD	080378	P206346	LOES
043405	M090538	SLAR	050187850043	M091050	PALA		X004480	MBSI	060094519	M090301	BROD	080387	P226142	LOES
04402011	M085056	SISU	0501878533	M085207	SLVN		X004480	CAT	060094529	M085409	BROD	080388	P206340	LOES
04402574	M080018	KTSU	050729403	M085080	EINT	0550019272	P206407	CMCO	060094542	P224669	BROD	080389	P206297	LOES
	M080018	SISU	0511351409	M001703	CMCO	0550019273	P206410	CMCO	060774429	X004484	BIAM	080390	P206336	LOES
044095	M085084	KSHA		M001703	CMCO	0550019275	X004482	CMCO	061514083	M085078	CLRK	080395	P206302	LOES
04450	M070028	DMON		M001503	CMCO	0550020843	P206309	CMCO	061548	J190003	AGEM	080397	P206344	LOES
044630	M070069	SLAR	0511375295	M001703	CMCO	0550038022	M070068	CMCO		J190003	LORAL	080398	P206321	LOES
044751	M090210	KSHA	05136151	M080019	DD	0550038023	M085090	CMCO	06200	X004536	VCOR	080400	P206546	LOES
045074	M070068	KSHA	051368	M100043	MOXY	0550038382	M100146	CMCO	06212	X004476	VCOR	080404	P206411	LOES
0452276	P206411	BADG	051513	X004482	MOXY	0550041602	M085056	CMCO	06214	X004537	VCOR	080405	P207667	LOES
045564	M070008	SLAR	051514	P226156	MOXY	0550046	X007831	CRAN	06231070	M065065	CLRK	080408	P226140	LOES
04710038	P206410	TMRK	051521	P206641	MOXY	0550057	P206607	CRAN	062321070	M065065	CLRK	080409	P206313	LOES
	P206410	SDVK	051522	P206543	MOXY	0550118	M002134	CRAN	06234	X004538	VCOR	080424	P207350	LOES
04710078	P206411	SDVK	051524	P206410	MOXY	0550119	M002135	CRAN	062519859	M120189	CLRK	080425	P207350	LOES
	P206411	TMRK	05179058	M090009	DD	0551306996	M090170	CMCO	062635	P207341	LORAL	080426	P207325	LOES
04710300	M100048	TMRK	05179206	M070008	DD	0551321424	P206411	CMCO	062789	J190025	LORAL	080427	X004538	LOES
	M100048	SDVK	0520197	M065065	BADG	0551322079	M090072	CMCO		J190025	AGEM	080429	P206927	LOES
04710302	M120131	TMRK	0520249521	J024750	FOREM	0551326623	M090362	CMCO	062790	P207331	LORAL	080431	P207386	LOES
	M120131	SDVK	0520285021	P208394	FOREM	0551327795	M140048	CMCO		P207331	AGEM	080432	P207385	LOES
04879001	X004480	TREX	0520325	M080018	BADG	0551327796	P207341	CMCO	06300	X004478	VCOR	080434	P207326	LOES
049014270	M090544	VLVO	0520331	M090158	BADG	0551327797	P270543	CMCO	0630361	P270838	CRAN	080471	P226144	LOES
049014271	M090544	VLVO	0520340	M100048	BADG	0551327798	P206556	CMCO	0630895	P270541	CRAN	080477	P207351	LOES
049014272	M100464	VLVO	0520371	M120100	BADG	0551331975	P207366	CMCO	06312	X004480	VCOR	080479	J024836	LOES
049014273	M090544	VLVO	0520372	M120225	BADG	0551331976	X004539	CMCO	06312	X004480	VCOR	080480	P206602	LOES
049015280	M100464	VLVO	0520379	M085023	BADG	0551339700	P206344	CMCO	0631911	P270543	CRAN	080481	X007784	LOES
049033350	M090535	WGMC	052179	P206603	NEWFLY	0551346685	M120225	CMCO	063676064	X004478	CLRK	080482	P206612	LOES
049034037	M120131	WGMC		P206603	FLYR	0551356249	P226158	CMCO	06400	X004482	VCOR	080482	P206612	LOES
	M120131	WSTI	0522005282	P206405	FOREM	0551368096	M170101	CMCO	06444	X007784	VCOR	080483	P206604	LOES
049034554	M090535	WGMC	0522052132	P207324	FOREM	0551369882	P206547	CMCO	0644LL1001	M170101	SPRT	080488	P206634	LOES
049039300	M090535	VLVO	0522053864	P206407	FOREM	0551389997	J008681	CMCO	06500	X004484	VCOR	080490	P206331	LOES
	M090535	WGMC	0522054178	J009486	FOREM	0551390004	P206374	CMCO	06555	X007785	VCOR	0815014	P270534	CAT
049039304	M120365	WGMC	0522126985	J009487	FOREM	0551390009	P208366	CMCO	06600	X004539	VCOR	0816406	X004484	CAT
	M120365	VLVO	0522184276	P206397	FOREM	0551391960	P206552	CMCO	067496	M060158	WLDN	0816407	X004476	CAT
049039307	M120189	WSTI	0522255178	J009624	FOREM	0551392182	P206346	CMCO	067819	J009648	FLYR	0818035	M120131	RYGO
049039308	M100464	VLVO	0522258089	P207339	FOREM	0551392616	P206525	CMCO		J009648	NEWFLY		M120131	CAT
049044073	M100465	VLVO	0522259555	P206324	FOREM	0551392617	P206543	CMCO	0680009	M060005	NAVI	0819056	M090301	BABR
049044343	M100463	VLVO	0522260136	P207584	FOREM	0551392618	M06508	CMCO	0680015	M090009	NAVI		M090301	CAT
049045022	M100465	VLVO	0522262510	P207331	FOREM	0551394610	P206540	CMCO	06973	M090009	DMON	0823452	M085208	EIMC
049045722	X007784	WSTI	0522264637	P207326	FOREM	0551394657	P206511	CMCO	0700715572	J240004	AGCO	083816	M060055	MOB
049045723	X007785	WSTI		P207329	FOREM	05519272	P206407	CMCO	0700716743	P206552	AGCO		M060055	WLDN
049045724	X004478	WSTI	0522266576	P207349	FOREM	05519273	P206410	CMCO	07024938	P206410	DETZ	085058	P207330	GNRC
049045727	X004482	WSTI		P207543	FOREM	05519274	X004478	CMCO		P206410	AGCO	0851375286	H001034	CMCO
049046709	X004484	WSTI	0522268168	P207349	FOREM	05519275	X004482	CMCO	072380	P206347	SWEE	0868829	M091046	LETO
049047016	M100464	VLVO	0522269207	P207322	FOREM	05520843	P206309	CMCO	0724132	M120100	GRVE	089275	X004482	NEWFLY
049660	X004478	SLAR	0522271102	P207351	FOREM	05538022	M070068	CMCO	07704600000	M060055	PTBN	09013928	M120108	TREX
049787	X004476	SLAR	0522276826	P226147	FOREM	05538023	M085090	CMCO	0773465	M085056	CAT	0906031007	M100146	TREX
050170900009	M065030	PALA	0522280285	P207359	FOREM	05538382	M100146	CMCO	0773905	M090170	RYGO	0906040713	J009606	TREX
	M065030	SLVN	0522283780	J009623	FOREM	05541602	M085056	CMCO		M090170	CAT	0906040715	P206364	TREX
050170900010	M070069	PALA	0522284743	J190055	FOREM	056005	M090544	PACC	0775683	M090074	CAT	09079368	M170101	TREX
050170900012	M100016	PALA	0522285082	P207402	FOREM	0561649	M100048	PACC		M090074	RYGO	09214205	M100016	TREX
	M100016	PALA	052228											

Cross Reference

(See the first page of this section for the Manufacturer's Code Listing)



CROSS REFERENCE

Mfgs. No.	Our No.	Mfg. Code	Mfgs. No.	Our No.	Mfg. Code	Mfgs. No.	Our No.	Mfg. Code	Mfgs. No.	Our No.	Mfg. Code	Mfgs. No.	Our No.	Mfg. Code	
0937019	J000209	CAME	10002040	P206337	BLNT	1008681	P206508	Marine	10310	P206350	TRUX			P206301	CRMY
09385100	P206328	KRON		P206337	CAT	100870	P206411	AGEM	1031049	X004480	ELGN	1055295	M100463	AMHO	
09385630	P206605	KRON		P206337	COLT	1009109	J000206	Marine	1031066	P206409	ELGN	10553	P207338	TRUX	
09385660	P207582	KRON	10002043	P206309	HDMA	1009187	J000205	Marine	1031067	P206410	ELGN	10554	P206347	TRUX	
09385690	X006203	KRON	10002214	M045237	SCRD	1009243	M090538	TDSC	1031068	P206507	ELGN	10555	P207340	TRUX	
09386890	X006202	KRON	1000269	X004482	URIG	1009244	P206327	TDSC	10312	P206279	TRUX	10556	P207341	TRUX	
09386900	P208374	KRON	1000270	X004484	URIG	1009526	P206850	Marine	10313	P206280	TRUX		P207341	GOE	
09386910	J190003	KRON	1000384	M002164	BADG	1010136	M090538	TDSC	10314	P206281	TRUX	10557	P207339	TRUX	
09386920	M100213	KRON	1000389	M120108	CUMS	101085302A	M085008	GRST	10315	P206282	TRUX	10559	P207354	TRUX	
09401290	P207394	KRON		M120108	URIG	10114310	P206333	BOSS	10317	P206283	TRUX	105596A	X007805	OKSH	
09401300	P206318	KRON	100043	M100043	PDCI	1011592	M060232	GRST	1032550	M065030	GRST	10560	J009560	TRUX	
09401310	X004539	KRON	10004693	P206326	BLNT		M060232	HRCN	10329	J190014	TRUX	10562	P207347	TRUX	
0944128	X004478	TREX		P206326	CAT	10116406	P206851	HRCN	10330	P207361	TRUX	10564	P207351	TRUX	
	X004478	OK	100052	M100052	WSTI	1012004B	P207415	GRDL	10337	P206397	TRUX	10565	P207352	TRUX	
09673152	M001702	BVER	10008	M100466	RKRM	10135094	M065044	OMNI	10338	P206398	TRUX	10566	P207353	TRUX	
0970432484	P207355	CEDAR	10008012	P270538	BLNT		M065044	JLGI	10339	P206399	TRUX	10567	P207354	TRUX	
097470	M120154	DRDT		P270538	CAT	1015551	M120108	TDSC	10340	P206400	TRUX	1059203	P207364	TDSC	
0980240	M085090	RYGO	10008318	P206334	CAT	1017391	M085078	ELGN	1034001282	X004482	FAS	1059205	X004480	TDSC	
	M085090	CAT	10008343	P270541	BLNT	10175432	M070008	FWD	1034633	M060055	ELGN	1059997	M070028	TDSC	
0A6290	M101170	GEHL		P270541	OMML	10175510	M090544	FWD	1034635	X004536	ELGN	1060	P206338	XAIR	
	M101170	GNRC		P270541	CAT	10175576	M085008	FWD	1034636	P206403	ELGN	10600	P206338	HDMI	
0D5745	P210110	GNRC	10008352	P206411	OMML	10175581	M090074	FWD	1034712	P207364	GRST		P207340	DFLX	
0D6667R	P206615	GEHL		P206411	BLNT	10175617	M090544	FWD	1034713	P270532	ELGN	1060073	P206325	TDSC	
	P206615	GNRC		P206411	CAT	10175623	M070028	FWD	1035	P206335	XAIR	1060074	P206363	TDSC	
0D8473	M085090	GNRC	1000882	M091048	BADG	10175624	M090146	FWD	10350	P206342	DFLX	10600A	P206338	HDMI	
0D9906B	P207584	GNRC	1000883	M002120	BADG	101865	M120100	KTSU		P206335	HDMI	1060213	P207363	TDSC	
0E4264	J000228	GNRC	10009625	P206333	BLNT		M120100	DRSS	1035000247	M090091	FAS	1060909	M080024	TDSC	
0E5955	M070068	GNRC		P206333	CAT	101877	M100048	DRSS	1035000248	P206511	FAS	1061246	P206320	TDSC	
0F0904	M090091	GNRC	10009862	M100463	SPCH		M100048	KTSU	1035000322	X004484	FAS	10620	P206344	TRUX	
	M070069	PTBN		M100463	SPRT	1018783	X004478	ELGN	1035000323	X004482	FAS	10626452	J000203	DSL	
0L102468017	M070069	PTBN	1001080429	P206306	JLGI	10190018	P206331	BOSS	1035000328	M100463	FAS		J000203	GDSL	
0L102468019	M070069	PTBN	1001080490	P226152	JLGI	1020	P206331	XAIR	1035000790	P206385	FAS	106275	M085172	ARV	
0LA00124007	P270538	PTBN	10010990004	P207317	PIE	10200	J008671	DFLX	10350A	P206335	HDMI	10631	J009631	TRUX	
0LA00998016	P206344	PTBN	10020	M100465	RKRM	10200AZ	J008671	DFLX	10350AZ	P206342	DFLX	10632	J009632	TRUX	
0LA01145000	M080024	PTBN	10021	M100807	RKRM	1020997	M090091	TDSC	1035924	M120365	URIG	10633	J009633	TRUX	
0NG18020	P206367	AA	10023	M100466	RKRM	1021711	M120100	GRST	1036008	M190002	URIG	10635	J009635	TRUX	
0OR017765000	M070008	PTBN	10023028	M080018	BLNT	1025	P206333	XAIR	1036808	M065044	GRST	10636	J009636	TRUX	
0OR017765000	M070008	PTBN		M080018	CAT	10250	P206339	DFLX	1036983	P206327	ELGN	10637	J009637	TRUX	
0RO23180028	M085023	PTBN	10023109	P206544	BLNT	10253	M080024	CRMY	1040	P206336	XAIR	10639	J009639	TRUX	
0RO23180037	M085008	PTBN		P206544	CAT		M080024	DMON	10400	P206336	HDMI	10640	J009640	TRUX	
0RO23180065	M070069	PTBN	10024	M100048	RKRM	1026178	M100146	GRST		P206344	DFLX	10641	J009641	TRUX	
0RO23180076	M085090	PTBN	10028	M100465	RKRM	1026921A	J190042	GRDL	10400A	P206336	HDMI	10644	J009644	TRUX	
0RO23180090	M100048	PTBN	10029	M100463	RKRM	1026921B	P206339	GRDL	10400AZ	P206344	DFLX	10645	J009645	TRUX	
			1003146	M070068	Marine	1026921E	P207349	GRDL	10400CP	P207345	DFLX	1065376	P224710	ELGN	
				M070068	GRVE	1026921F	P207397	GRDL	104128	M085023	MJPR	106591	X004539	EIMC	
				M070068	SHUT	102732	M110012	ARV	1042175	M090091	CAT	10671	J008671	TRUX	
				M070068	MTWC	10275	P216172	DFLX		M090091	CAT	10672	P206339	TRUX	
						10275AZ	P216172	DFLX	1047721	M080024	AMHO	10674	P216172	TRUX	
						1027Z225	M090074	PH	104851A	X004478	OKSH	10675	P206340	TRUX	
						102838	M090538	ARV	104852A	X004482	OKSH	10676	P206342	TRUX	
						102894	M090280	ARV	1050	P206337	XAIR	1067766	P226143	AMHO	
						102895	M090563	ARV	10500	P206337	HDMI	1067767	P206338	Americ	
						102899	M090534	ARV		P206347	DFLX	10678	P206344	TRUX	
						102902	M090544	ARV	10500A	P206337	HDMI	10680	P207339	TRUX	
						102905	P270531	Marine	10500CP	P207346	DFLX	10681	J008681	TRUX	
						102969	M085267	ARV	10501390	J000206	CAT	10683	P206394	TRUX	
						102974	M090520	ARV		J000206	BLNT	10684	P206395	TRUX	
						102BB16	P206411	SPRT	1050221	M100464	WSTI	10685	P206396	TRUX	
						1030	P206334	XAIR	1051350	M001756	CMWK		P206396	GOE	
						10300	P206342	DFLX	105211	P206544	GEHL	1069179	P206322	TDSC	
						1030039	X004478	ELGN	10532	P207324	AP	1069203	P207282	TDSC	
						10300A	P224684	HDMI	10534	P207326	TRUX	106926	X004482	EIMC	
						10301	P207333	TRUX	10535	P207327	TRUX	106B4943	M085023	EIMC	
						103021	M090547	ARV	1053578	M070069	FREQ	1070735	X004482	Americ	
						103022	M120154	ARV	10536	P207328	TRUX	107113	P206301	Marine	
						10303	P207335	TRUX	10537	P207329	TRUX	10719262	M085078	OMNI	
						10304	P206341	TRUX	10538	P207330	TRUX	10719871	M060158	LULL	
						10305	P206343	TRUX	10539	P206346	TRUX		M060158	JLGI	
						10306	P206345	TRUX	10540	P207331	TRUX	1072037	P206366	ELGN	
						10308	P206348	TRUX	10541	P207332	TRUX	10724	P206339	AP	
						10309	P206349	TRUX	10542	P206349	TRUX		P206339	GOE	
									105441	P206301	CHAMP	1072425	P206369	TDSC	

1

Mfgs. No.	Our No.	Mfg. Code	Mfgs. No.	Our No.	Mfg. Code	Mfgs. No.	Our No.	Mfg. Code	Mfgs. No.	Our No.	Mfg. Code	Mfgs. No.	Our No.	Mfg. Code
10725	P206368	AP	10837799	M065073	LULL	10PL400	P207329	DFLX	111137A	M002121	CMWK	114646800	M065044	CAM
10726	P206282	TRUX		M065073	JLGI	10PL400AZ	P207329	DFLX	111138	M001432	CMWK		M065044	BDER
1072696	J008671	ELGN	1087288	P226145	ELGN	10PL500	P206349	DFLX	111138A	M001432	CMWK	11464680044	M065044	PRIN
10727	J190023	TRUX	1087289	X007831	ELGN	10PL500AZ	P206349	DFLX	11127	M090538	PDCI		M065044	CAM
10728	P206282	TRUX	1087292	P206363	ELGN	10PL600AZ	P216175	DFLX	1113731	P206543	GEFCO	114656200	M065074	CAM
10728181	P270539	JLGI	108818620	P206603	PRIN	10T30015	P206393	DFLX	11137351	P206508	GEFCO		M065074	PRIN
10729	J190025	TRUX	108935H45	M085056	DRSS	10T30090	P206397	DFLX	1114702	P222750	GEFCO	114661200	M002118	CAM
1072980	J009648	ELGN		M085056	KTSU	10T35015	P206394	DFLX	1114917	M100463	VLVO		M002118	PRIN
10730	J190025	TRUX	108936	M100048	DMI	10T35030	J009635	DFLX	1116418	M090091	OKSH	114666460	M120749	PRIN
10731	P206283	TRUX		M100048	KTSU	10T35090	P206398	DFLX	111641B	M090091	OKSH	114666469	M002123	CAM
10732	J190027	TRUX	1089600051	P205976	FAS	10T40015	P206395	DFLX	11165	M100463	PDCI		M002123	PRIN
10741	P207350	TRUX	1089600052	P205979	FAS	10T40030	J009636	DFLX	1116639	M100213	VLVO	114666604	P207298	CAM
10742	P207351	TRUX	1089600169	X004962	FAS	10T40060	J009644	DFLX	11172962	J190061	VLVO		P207298	PRIN
1074277	P207364	ELGN	1089600300	P270540	FAS	10T40090	P206399	DFLX	1119466	X006203	VLVO	114666634	P206323	PRIN
1074283	J009618	ELGN	1089600675	X007785	FAS	10T50015	P206396	DFLX	11197	M122300	PDCI		P206323	CAM
10743	P207353	TRUX	1089600676	M001668	FAS	10T50030	J009637	DFLX	1120408	P270536	JLGI	114666743	M065034	CAM
10744	P207353	TRUX	1089600677	X007784	FAS	10T50060	J009645	DFLX	1120421	P206399	GEFCO		M065140	CAM
10745	P207353	TRUX	1089600678	M001503	FAS	10T50090	P206400	DFLX	1120471	P207582	GEFCO		M065034	PRIN
10746	P207354	TRUX	1089601305	J000209	FAS	10T60090	P207366	DFLX	1120481	P206349	GEFCO	114666796	M085407	CAM
10748	P207355	TRUX	108973	M120365	FMC	10UH2	P206519	ACFT	1120482	P207326	GEFCO		M085407	PRIN
10749	P207355	TRUX	108980	P206409	FMC	1100010	M060055	Marine	1120581	P206340	GEFCO	11466693744	M085421	CAM
1075321	P270534	ELGN	108982	P206411	FMC		M060055	CASE	11209	M170101	PHCO		M085421	PRIN
10755	J009560	AP	10908	M100464	RKRM		M060055	SHUT	11223	M085172	HDMI	114667017	M002117	CAM
1075550004	X004484	WHMS	10915	M100048	RKRM	11000419	M002119	CUMS	11224	M100465	PDCI		M002117	PRIN
10756	P206340	TRUX	10918	M100043	RKRM	11000420	M002120	CUMS	11227	M090520	PDCI	114667539	M085208	PRIN
10758	P206341	TRUX	109185A1	M001756	MCC	11000475	M002117	CUMS	112273	X004484	AMTK	114667565	J000200	PRIN
1075836	M001702	ELGN		M001756	PTN	11000476	M002118	CUMS		X004484	AUTM	11500	P207339	DFLX
10759	P206342	TRUX		M001756	CASE	11000487	P206325	CUMS	11228	M090544	JHEI	1150045	P206283	HDMI
10761	P206344	TRUX	10920	M100463	RKRM	11000488	P206520	CUMS		M090544	PDCI	1150045A	P206283	HDMI
1076118	P206362	ELGN	10921	P206306	AP	11000509	M002121	CUMS	112351	M085056	FXBL	11500AZ	P207339	DFLX
107619001	X004482	VMER	10922	M100807	RKRM	11000504	P206344	TIPP	112352	M120100	FXBL	11518	P207283	XAIR
1076190011	X004482	VMER	10925	M101169	NH	11000880	M002123	CUMS	1130045	P206280	HDMI	1151918	M120131	Americ
107619003	X004480	VMER	1092788	P207281	BABR	1100101	P206340	TIPP	1130045A	P206280	HDMI		M120131	AMHO
1076190031	X004480	VMER	10928	M100582	RKRM	1100279	M085023	TIPP	11335	J000221	NH	11524	J024739	XAIR
10762	P206345	TRUX	10929	P206311	NH	1100382	P206345	TIPP	11336	M065142	NH	11536	P208380	XAIR
10763	J190002	TRUX	10930	M100052	RKRM	1100440	X004478	OMNI	11337	M002118	NH	11548	P207292	XAIR
	P206345	GOE	10931	M100049	RKRM		X004478	JLGI	11338	P206310	NH	11550045	J190025	HDMI
10764	J190003	TRUX	10932	M100572	RKRM	1100689	M070028	TIPP	1135045	P206281	HDMI	1155262	M100464	AMHO
10765	P206347	TRUX	10945	M100695	RKRM	11008	J000231	NH	1135045A	P206281	HDMI	11560	P207289	XAIR
10766	P206348	TRUX	10961	M100213	RKRM	110105	P206340	TIPP	113536	P208348	XAIR	115841	M120176	KRES
10767	P207341	TRUX	1097987	X004476	CAT	11015	M085023	HDMI	11382	J000233	TMCO	1160045	P207359	HDMI
	P207364	GOE		X004476	TIM	11019	M085080	PRVT		P207596	TMCO	1160045A	P207359	HDMI
1077286	P216174	ELGN	1097LL2001	M120131	SPRT	110219	P206326	TIPP	11400	J008681	DFLX	116370001	M085090	VMER
10773	P207322	TRUX	109820B	M100465	OKSH	11023	M090535	PDCI	1140045	P206282	HDMI	1163700011	M085090	VMER
10774	P207324	TRUX	10L200	P207333	DFLX		M090535	FRAM	1140045A	P206282	HDMI	116949	P206410	EIMC
10775	P207325	TRUX	10L250	P207335	DFLX		M090535	ALSY	114008	P207366	AUTM	117544	M120225	WIRG
10776	P207362	TRUX	10L300	P206341	DFLX	1102LL2001	M120225	SPRT	114014	P207332	AUTM	118073	P270536	ME
10777	P207362	TRUX	10L300AZ	P206341	DFLX	11035	M120365	PHCO	11411300	M080024	BDER	118359	P208326	CHAMP
10778	J190013	TRUX	10L350	P206343	DFLX	11038	M080018	YPEI	114143800	M085084	BDER	11850495	M001756	VLVO
107789B	M100465	OKSH	10L350AZ	P206343	DFLX		M080018	PKNS	114144400	M090210	BDER	1185900	M120108	TREX
10780	P207364	TRUX	10L400	P206345	DFLX	11058	M002121	NH	11415068	P206552	VLVO		M120108	OK
1078066	P206370	ELGN	10L400AZ	P206345	DFLX	11068196	P207394	ECLD	11415070	M002121	VLVO	11870553	M001702	VLVO
10781	P207364	TRUX	10L400CP	P206353	DFLX	11075	M045193	HDMI	11415098	P206321	VLVO	11872	M100464	CRMY
10782	J190009	TRUX	10L500	P206348	DFLX	11076	M065071	YPEI	11415101	M001503	VLVO	11873	M100464	CRMY
10783	P206346	TRUX	10L500AZ	P206348	DFLX	11096	M085171	PDCI	11415189	M001702	VLVO	11875	M090170	CRMY
1078581	M120135	TDSC	10L500CP	P206354	DFLX	1110H070120	P206602	WSTI	11415198	M002119	VLVO	11876	M090158	DMON
1078582	P206521	TDSC	10L600	P206350	DFLX	11101	M100049	TMPO	11415205	J190009	VLVO		M090158	CRMY
10786	P207365	TRUX	10L600AZ	P206350	DFLX	1110389	M090210	BABR	11415206	J009648	VLVO	11877	M100043	CRMY
10787	P207365	TRUX	10P225AZ	P216174	DFLX		M090210	CAT	11415207	M085208	VLVO	1189A01G01	X004536	TKNG
10789	P207365	TRUX	10P300	P207326	DFLX	11104	M085056	PKNS	11415208	P206544	VLVO	11901	M110189	RKRM
10790	P207332	TRUX	10P350	J190014	DFLX	1111110	M100465	UPTI	11415273	P206326	VLVO	11901Q	M110189	RKRM
10791	P207365	TRUX	10P350AZ	P207327	DFLX		M100465	VLVO	11415373	M002118	VLVO	11908	M045237	WILM
10792	P207366	TRUX	10P400AZ	P206346	DFLX	1111111	M090544	VLVO	11418	P207282	XAIR	119242	P206347	EIMC
	P207366	GOE	10P500	P207331	DFLX	1111112	M090535	VLVO	114212	M065030	CHAMP	119353	P207354	CHAMP
	P207366	AP	10P500AZ	P207331	DFLX	1111114	M100464	VLVO		M065030	CRMY	11A30045	P207351	HDMI
10794	P207363	TRUX	10P600	P216175	DFLX	11112	M090009	LCD	11424	J024737	XAIR	11A30045A	P207351	HDMI
10796	P207331	TRUX	10PL200	P207322	DFLX	111122	P270536	CMWK	114271	M085023	TMLS	11A35030	J009635	HDMI
10797	P207329	AP	10PL225	P216174	DFLX	111122A	P270536	CMWK	114289	M090170	DRSS	11A35030A	J009635	HDMI
	P207329	TRUX	10PL250	P207324	DFLX	111123	P270543	CMWK	114338	M085023	KTSU	11A40015	P206395	HDMI
1079866	P206344	ELGN	10PL300	P207326	DFLX	111130	P206603	CMWK		M085023	DRSS	11A40015A	P206395	HDMI
108019	P206411	DRSS	10PL350	P207328	DFLX	111136	P206512	CMWK	11436	P208364	XAIR	11A40030	J009636	HDMI
	P206411	KTSU	10PL350AZ	P207328	DFLX	111136A	P206512	CMWK	11448	P207287	XAIR	11A40030A	J009636	HDMI
1081770	M001593	CAT												

Cross Reference

(See the first page of this section for the Manufacturer's Code Listing)



CROSS REFERENCE

Mfgs. No.	Our No.	Mfg. Code	Mfgs. No.	Our No.	Mfg. Code	Mfgs. No.	Our No.	Mfg. Code	Mfgs. No.	Our No.	Mfg. Code	Mfgs. No.	Our No.	Mfg. Code
11A40045	P207353	HDMI	12250	P206279	DFLX	1240142	X004478	KOEH	12512	P207339	HDMI	12969629	P206364	ECLD
11A40045A	P207353	HDMI	122614	M120749	AGEM	124066080	P206407	KOEH	12512A	P207339	HDMI		P206364	VALM
11A50015	P206396	HDMI	1226244	P207335	SLVN	12408	P206407	TREX	12512CP	J009547	HDMI		P206364	SISU
11A50015A	P206396	HDMI	12266600	J190020	HRCN	12408880	M120225	CAT	12514222	X004484	ECLD	12969630	X007784	ECLD
11A50030	J009637	HDMI	12266659	P207354	HRCN	124089	P206409	KOEH	125158	M001702	AGEM	12969930	M090538	VLVO
11A50030A	J009637	HDMI	12266744	X007785	GRST	12410	P206344	HDMI	125159	M085409	AGEM		M090538	ECLD
11L200	J008671	DFLX	122707	P208394	AGEM	12410A	P206344	HDMI	125160	P206544	AGEM	12998713500	M065074	NEWS
11L275	P216172	DFLX	12275	P207350	DFLX	12414634	P206606	LINMR	125161	P206380	AGCO	12998713500	P270535	NEWS
11L300	P206340	DFLX	12275AZ	P207350	DFLX		P206606	STEW		P206380	AGEM	12998713540	P206405	NEWS
11L400	J008681	DFLX	122807	M100465	COLT		P206606	OKSH	12518	P207298	XAIR	12A300	P207352	HDMI
11L500	P207339	DFLX	122939	M001327	COLT		P206606	AMEC	12524	J024747	XAIR	12A300A	P207352	HDMI
11M830040	X004536	HYUN	12300	P206280	DFLX	12418	P207297	XAIR	12548	P207296	XAIR	12A330	J190013	HDMI
11ME228	X007831	MACK		P206341	HDMI	12421711	M120100	GRST	12549	M045193	TMCO	12A330A	J190013	HDMI
11ME229	X004480	MACK	12300A	P206341	HDMI		M120100	HRCN	1256106	M080024	KOEH	12A350	P207327	HDMI
11ME348M	M001865	MACK	12300F	P206341	HDMI	12424	P207297	XAIR	12562	X004482	FLYR	12A350A	P207327	HDMI
11P300	P207362	DFLX	12300FA	P206341	HDMI	12427178	M100146	HRCN	125625	M085008	KOEH	12A350F	P207363	HDMI
11P300AZ	P207362	DFLX	12300FS	P206341	HDMI		M100146	GRST	125626	P206407	KOEH	12A350FA	P207363	HDMI
11P350AZ	P206398	DFLX	12300FSA	P206341	HDMI	1242847	M045123	GRST	125648	M065034	KOEH	12A3513	M100464	FMC
11P400	P207364	DFLX	123137	M120100	COLT	12428471	M045123	GRST	125653	M065065	KOEH	12A3569	M090146	FMC
11P400AZ	P207364	DFLX	12322837	M060232	GM		M045123	HRCN	125656	M100048	KOEH	12A400	P206346	HDMI
11P500	P207365	DFLX	12322838	M065065	GM	124312241	M090594	FURU	125657	M070069	KOEH	12A400A	P206346	HDMI
11P500AZ	P207365	DFLX	12322841	M085172	GM	1243122H1	M090594	CETCO	125658	M090544	KOEH	12A440	P207364	HDMI
11P600	P207366	DFLX	12322842	M085171	GM		M090594	KTSU	125666	M100464	KOEH	12A440A	P207364	HDMI
11PL350AZ	P207363	DFLX	12322844	M085023	GM		M090594	DRSS	125668	M085078	KOEH	12A550	P207365	HDMI
11PL400	P206346	DFLX	12322845	M085189	GM		M090594	FURU	125669	M090091	KOEH	12A550A	P207365	HDMI
11PL500	P207332	DFLX	12322846	M090534	GM	1243226H1	M070068	DRSS	125670	M085023	KOEH	12A555	P207332	HDMI
11PL500AZ	P207332	DFLX	12322847	M090535	GM		M070068	KTSU	125672	M100048	TREX	12A555A	P207332	HDMI
11S50045	J190025	HDMI	12322848	M100464	GM	1243327H1	M085090	KTSU	125675	M100463	KOEH	12B300	J190013	HDMI
11S50045A	J190025	HDMI		M100464	ALSN		M085090	DRSS	125684	M090158	KOEH	12B300A	J190013	HDMI
11S50045CP	P206286	HDMI	12322849	M090538	GM	12436	P208366	XAIR		M090158	TREX	12B300F	J190013	HDMI
11T30015	P206393	DFLX	12322850	M090544	GM	12440471	M090091	PTN	125695	M085090	KOEH	12B300FA	J190013	HDMI
11T30090	P206397	DFLX	12322851	M090781	GM		M090091	CASE	12574828	P207596	ECLD	12B350	P207328	HDMI
11T35015	P206394	DFLX	12322852	M090547	GM	12448	P207295	XAIR	12583808	X004538	ECLD	12B350A	P207328	HDMI
11T35090	P206398	DFLX	12322853	M090548	GM	12450F	J190002	HDMI	12584634	M140048	ECLD	12B350F	P207327	HDMI
11T400	P206399	DFLX	12322854	M090563	GM	12450FA	J190002	HDMI	125925	M090210	KTSU	12B400	P207329	HDMI
11T40015	P206395	DFLX	12322855	M100463	GM	12462838	M065030	HRCN		M090210	DRSS	12B400A	P207329	HDMI
11T40090	P206399	DFLX	12322856	M100464	GM	124644413	M085056	SCOMP	12600	P206350	HDMI	12B400CP	J190016	HDMI
11T500	P206396	DFLX	12322857	M100465	GM		M085056	HRCN	12600A	P206350	HDMI	12B400F	P206346	HDMI
11T50015	P206396	DFLX	12322858	M100466	ALSN		M085056	GRST	12600CP	P207359	DFLX	12B400FA	P206346	HDMI
11T50090	P206400	DFLX		M100466	GM	12465589	M065034	BOSS	12615933	X004962	ECLD	12B500	P206349	HDMI
11T600	P207361	DFLX	12322859	M110012	GM		M065034	SCOMP	126170	M065065	KTSU	12B500A	P206349	HDMI
11T60090	P206361	DFLX	12322860	M110014	GM		M065034	HRCN	126174	X004482	IRT	12B500F	P207331	HDMI
1200	P207333	XAIR	12322863	M120365	GM		M065034	GRST	1261996	M101181	PIE	12B500FA	P207331	HDMI
12000277	P270539	PERK	12322864	M120366	GM	12465802	M060037	SCOMP	126417	M060158	TMPO	12B500FCP	J190019	HDMI
12006	M080024	PWRT	12322865	M120367	ALSN		M060037	BOSS	126501	M002123	AGEM	12H0020	M085023	LKBT
12010	M080024	PETTI	12322867	M120382	GM		M060037	GRST	126558	M001668	AGEM		M085023	FMC
120167A	M100043	OKSH	12336	P208326	XAIR	12466144	M065073	GRST	1265974H1	P206410	FURU	12H0411	J009514	LKBT
12021898	P206326	BOSS	1234	M001756	FLPW	12468776	M085189	HRCN		P206410	DRSS	12H20	M070008	FMC
12022083	P207362	HRCN	1234226H1	M070068	DRSS	12470463	M080024	HRCN	12680001	X004536	STMC	12K14764LA	J038611	HDMI
12024	M090072	PCDI		M070068	KTSU	12470842	M065073	HRCN	12680002	X004537	STMC	12K14764RA	J038612	HDMI
12027435	P207361	GRST	12350	P206281	HDMI	12471558	M101169	HRCN	12680003	X004476	STMC	12K5419A	J018110	HDMI
	P207361	HRCN		P206281	DFLX	12471752	M060479	HRCN	12680004	X004538	STMC	12L275	P207350	DFLX
12034712	P207364	HRCN	12350A	P206343	HDMI	12486	J008681	HDMI	12680005	X004478	STMC	12L300	P206280	DFLX
	P207364	GRST	12350FSA	P224669	NLSN	12488	J008681	HDMI	12680006	X004480	STMC	12L300AZ	P206280	DFLX
12047E49	M045193	LEBR	123674	M100016	NAT	1248880	M120225	CAT	12680007	X004482	STMC	12L350	P206281	DFLX
1205914	M065030	AMHO	123684	M120235	AGCO		M120225	TIM	12680008	X004484	STMC	12L350AZ	P206281	DFLX
12061422	P206403	ICAB	123921	P208392	AGEM	12488A	J008681	HDMI	12680009	X004539	STMC	12L400	J190023	DFLX
12061426	P206407	ICAB	12400	P206282	DFLX	1249281H1	M045237	KTSU	127026R92	M085023	NAVI		P207338	HDMI
12066600	J190020	HRCN		P206345	HDMI		M045237	DRSS	12723327	P226145	CRMY	12L400A	P207338	HDMI
12067300	P207322	HRCN	12400A	P206345	HDMI	1250	P207335	XAIR	12726548	X004478	CRMY	12L400AZ	P206282	DFLX
12068615	P206366	HRCN	12400CP	P206285	DFLX	12500	P206283	DFLX	12726581	X004482	CRMY	12L400CP	P206285	DFLX
12069320	P207322	HRCN		P206353	HDMI		P206348	HDMI	12754	P270542	WIRG	12L500	P206283	DFLX
1207032	M085090	AMHO	12400F	J190002	HDMI	12500A	P206348	HDMI	1279133	M001506	CAT		P207340	HDMI
	M085090	RYGO	12400FA	P206344	HDMI	12500CP	P206286	DFLX	1282347	M090594	PIE	12L500A	P207340	HDMI
1207032A	M085090	RYGO	12400FS	P206344	HDMI		P206354	HDMI	12826	M060158	TMCO	12L500AZ	P206283	DFLX
12109	M090362	YPEI	12400FSA	P206344	HDMI	12500F	P206347	HDMI	12827	P207333	TMCO	12L500CP	P206286	DFLX
12158602	M065034	ICCMFG	1240106	X004482	TREX	12500FA	P206347	HDMI	128453	M002119	AGEM	12L600AZ	P207359	DFLX
	M065034	ICAB		X004538	KOEH	12500FA	P206347	HDMI	12855	M065044	TMCO	12M21698A	J028528	HDMI
12158905	P270534	ICAB	1240118	X004480	KOEH	12500FCP	P207346	HDMI	128974	P207325	IRT	12P1726A	J009560	HDMI
1222204	P270539	TREX	1240122	X004484	KOEH	12510	J190003	HDMI	129434C	M100146	OKSH	12P200	P207347	DFLX
1222282	P270541	TREX		X004484	TREX	12510A	J190003	HDMI	12967141	H001039	VLVO	12P250	P207349	DFLX
122382	P271507	ME	1240124	P206411	KOEH	12510CP	J190004	HDMI		H001039	ECLD	12P275	P207350	DFLX
									12969628	M090534	ECLD			

Mfgs. No.	Our No.	Mfg. Code	Mfgs. No.	Our No.	Mfg. Code	Mfgs. No.	Our No.	Mfg. Code	Mfgs. No.	Our No.	Mfg. Code	Mfgs. No.	Our No.	Mfg. Code
12P300	P207351	DFLX	1305433H1	P224617	KTSU	135018	P207281	HDMI	14050	P206370	XAIR	1446498	P206512	SCNA
12P400	P207353	DFLX	1305839	P270539	NACO	135018A	P207281	HDMI	14060	P207414	XAIR	1446499	J009429	SCNA
12P400AZ	P207353	DFLX		P270539	HSTR	135024	J024735	HDMI	140760801	M090594	HOIST	1446501	P206641	SCNA
12P500	P207354	DFLX	13082374	M090158	KTSU	135024A	J024735	HDMI	140761801	P206316	HOIST	1446502	X007785	SCNA
12P500AZ	P207354	DFLX		M090158	DMAG	135036	P208348	HDMI	140762806	P206369	HOIST	1446504	P226147	SCNA
12P500CP	P216169	DFLX		M090158	MH	135036A	P208348	HDMI	1408383	M070069	PIE	14500	P206298	HDMI
12PL200	P207347	DFLX	13093075	J009604	IR	135036CP	P208348	HDMI	1408389	P270538	PIE	14500A	P206298	HDMI
12PL300	P207351	DFLX		J009604	SKYJ	135048	P207286	HDMI	1408390	P207363	PIE	14534	M100465	ADUM
12PL300AZ	P207351	DFLX		J009604	VLVO	135048A	P207286	HDMI	1408396	J190044	PIE	14537	M100213	ADUM
12PL350AZ	P207352	DFLX		J009604	CUMS	13500D	P207328	XAIR	140852A	X004482	OKSH	145777001	M085207	VMER
1300	P206341	XAIR	13093083	J009605	IR	1350PE	J190014	XAIR	140930808	P226156	HOIST	14601	P206372	TRUX
13000011	P207324	PERK	13094974	P208326	KTSU	13535	M070008	HAWK	14099	X004478	EIMC		P206372	AP
13000065	P206335	PERK		P208326	MH	135511	M100465	ECSI	1410384	M001703	CAT	14602	P206373	TRUX
13000066	P206334	PERK		P208326	DMAG		M100465	TESSI	1411039	P213191	PBLT	14603	P206374	TRUX
13000077	P270531	PERK	130DD3A4	M065030	EIMC	135513	P206409	MACD	1411480	M001668	CAT	14605	P206375	TRUX
13000080	P206336	PERK		M065030	ATCO	1358326	H001279	NACO		M001668	DCVG		P206375	AP
13000111	M065030	PERK	1310030702	J009514	ATCO		H001279	HSTR	1413209	M110028	PBLT	14618	P206302	TRUX
13000154	P207324	PERK	1310032059	X004537	ATCO	1361200	P270536	NACO	1413313	M120365	PBLT		P206302	TRUX
13000177	M065074	PERK	1310032133	P206410	ATCO		P270536	HSTR	1413371	P206521	PBLT	14619	P206303	TRUX
13000214	P206339	PERK	1310032134	P270539	ATCO	136200	P270536	NACO	1413371	P206521	PBLT		P206303	TRUX
13000243	M065044	PERK	1310032512	M080024	ATCO	1362100	P270536	NACO	1413842001	M100580	PBLT		P206303	AP
13000271	M100572	PERK	1310033307	P270543	ATCO	136332	J008671	ELECT	1413842002	M100582	PBLT	14620	P206304	TRUX
13000275	J000216	PERK	1310033673	X007784	ATCO		J008671	DIA	1413842003	M100944	KW		P206304	TRUX
13000277	P270539	PERK	131048	P206411	CAT	1366LL2001	M101181	SPRT		M100944	PACC	14621	J014621	AP
13000284	P206279	PERK		P206411	BLNT	1375330	M100213	OKSH	141385001	P206398	VMER	14622	J014622	AP
	P207349	PERK	1310484800	J000204	ATCO		M100213	MNLS	1413927	P206521	PBLT	14623	J014623	AP
13000361	P207347	PERK		J000204	MH	1386049	X004476	NH		P206521	IMP	14625	C0NN	DMT
13000380	P206336	PERK	13112374	M090301	MH		X004476	NH		P206521	KW	14634	P206927	AP
13000402	M045237	PERK		M090301	KTSU		X004476	FMCO		P206521	PACC	1463763	X004482	CAT
13000403	P206403	PERK	131204	M090594	DMAG		X004476	CASE	1413972	M110143	PACC	146654001	P207363	VMER
13000404	P270532	PERK		M090594	CLAC	13861232	P270543	IR		M110143	KW	14694ELBOW1	P206340	DMT
13000451	M065074	PERK	1312885H1	M001702	CETCO	13902	P207405	XAIR	1416	M110143	PBLT	14694ELBOW2	P206339	DMT
13000494	M045193	PERK		M001702	KTSU	13903	P206372	XAIR	141674R91	M085008	NAVI	14694REDUCER	P206324	DMT
13000502	P206338	PERK	1313106	P270532	NACO	13904	P206374	XAIR	1416PE1	P207329	XAIR	14737	J240007	TRUX
13000509	P206337	PERK	13145271	M085207	IR	13905	P206375	XAIR	14189	X004480	EIMC	14738	P224479	TRUX
13000511	J000203	PERK	131539	P206410	AUST	13906	P207408	XAIR	1421026	H002129	SCNA	14739	J240006	TRUX
13000514	M120108	PERK	13157078	M100049	IR	13925	P206371	XAIR	1421027	H001035	SCNA	14740	P224481	TRUX
13000518	J000217	PERK	1316600	P226156	HSTR	1392697	P207362	PIE	1421027	H001035	SCNA	14759	ELBOW	DMT
13000521	P206336	PERK	13166871	M101169	IR	1392703	P206341	PIE	142531	P207332	KRES	147887001	P206556	VMER
13000522	P206346	PERK	13169552	P206323	IR	13935	P206373	XAIR	142572	M100049	KTSU	14817ELBOW	P206340	DMT
13000523	P207362	PERK		P206323	VLVO	1394219	P207325	CAT	142650	X004484	KSHA	1485AL	P206540	RKRM
13000529	M085409	PERK	13195474	M060158	DMAG	1396482	X004478	PIE	1427684	M101158	PIE	1487001	M122300	DLTC
13000530	M002119	PERK		M060158	MH	13P400	P207353	DFLX	1430391H1	M065034	DRSS	1488910	M100465	OKSH
13000532	P206324	PERK		M060158	BAR	13P500	P207354	DFLX		M065034	KTSU	149054	M080024	KSHA
13000534	P207365	PERK		M060158	IR	13PL400	P207353	DFLX	1430469	X007785	CAT	1490AL	P206540	RKRM
13000535	P270541	PERK	13198074	P270533	MH	13PL500	P207354	DFLX	1432461H1	M090594	KTSU	149111001	P207366	VMER
13000539	J000232	PERK		P270533	KTSU	13PS4174	M120225	RCHD		M090594	DRSS	149126001	P207366	VMER
13000543	M065140	PERK		P270533	DMAG	1400	P206344	XAIR	1432462H1	M085056	KTSU	1495014M1	M070008	MF
13000544	M120566	PERK	1320103	J000227	JLGI	140018	P207282	HDMI		M085056	DRSS	14B400	J092679	HDMI
13000560	M002120	PERK	1320128	X004478	JLGI	140018A	P207282	HDMI	14335ELBOW1	P207322	DMT	14B400A	J092679	HDMI
13000561	M002121	PERK	1320129	X004482	JLGI	140018CP	P224627	HDMI	14335ELBOW2	P207328	DMT	14B500	J092689	HDMI
13000562	M002118	PERK	1320129	X004482	JLGI	140024	J024737	HDMI	14339	P206372	TRUX	14B500A	J092689	HDMI
13000571	M101171	PERK	132016	M090074	TESSI	140024A	J024737	HDMI	14340	P206373	AP	14MK1696AZ	J028528	DFLX
13000573	M065142	PERK	132016	M090074	TESSI	140036	P208364	HDMI	14341	P206374	TRUX	14Z4D104	P2070536	PH
13000578	J000206	PERK	132038	M100582	TESSI	140036A	P208364	HDMI	14343	P206308	AP		P270536	CTRY
13000579	M002118	PERK	13271606	M091047	IR	1400458	P206282	OTWA		P206308	TRUX	14Z4D118	P270541	CTRY
13000580	J000206	PERK		M091047	VLVO	140048	P207287	HDMI	14344546	P270539	VLVO		P270541	PH
13000622	J190044	PERK	1331909	J240006	HSTR	140048A	P207287	HDMI	14344547	P270536	VLVO	14Z4D16	P270543	PH
13000637	J190017	PERK	13339189	J009648	IR	140060	P207288	HDMI	14354	M100465	ADUM	150003	M060037	TESSI
13000650	M065071	PERK	13339213	M070325	IR	140060A	P207288	HDMI	1437118H91	H001035	KTSU	150004	M065030	TESSI
13000652	P270534	PERK	13393566	P226152	IR	140060CP	P207299	HDMI	1437119H91	H001034	KTSU	150005	M070068	TESSI
130024	P216191	HDMI	1341259	M001702	CAT	140136CP	P224628	HDMI	1437125H1	J009648	KTSU	150006	M070068	TESSI
130024A	P216191	HDMI	134203	M090074	CLAC	140148CP	P224605	HDMI	1437128H1	J009649	KTSU		M070069	TESSI
130036	P208324	HDMI		M090074	TMLS	14017ELBOW	P206282	DMT	1437164H1	P270539	KTSU	150007	M080024	TESSI
130036A	P208324	HDMI	134226	P222750	AGEM	14020	P207411	XAIR	1437165H1	P270541	KTSU	150008	M090091	TESSI
130048	P207285	HDMI	134227	M090072	AGEM	14025	P206366	XAIR	143876	J000220	AGEM	15001	M120154	RKRM
130048A	P207285	HDMI	1342569	M080018	PIE	1402841	M120365	GRDL	14400	P206297	HDMI	150018	P207283	HDMI
130048A	P207285	HDMI	1342571	P270536	PIE	14030	P206367	XAIR	14400A	P206297	HDMI	150018A	P207283	HDMI
130048CP	P207314	HDMI	1344554	P207326	PIE	14035	P206368	XAIR	1444251	P206405	TIM	150018CP	P207283	HDMI
1300670	P206327	PIE	1344555	P206340	PIE	140359804	P207282	HOIST		P206405	CAT	150024	J024739	HDMI
1300PE	P207326	XAIR	1344558	P206367	PIE	1403748	M090146	PLOC	144634	M090535	KSHA	150024A	J024739	HDMI
13013	M100572	TMCO	134591	M090544	TESSI	1403778	M060158	PLOC	1446492	P224600	SCNA	150024CP	J240024	HDMI
130245	J000232	AGEM	1350	P206342	XAIR	14040	P206369	XAIR	1446494	P206611	SCNA	15003	M120100	RKRM
									1446495	M100582	SCNA			

Cross Reference

(See the first page of this section for the Manufacturer's Code Listing)



CROSS REFERENCE

Mfgs. No.	Our No.	Mfg. Code	Mfgs. No.	Our No.	Mfg. Code	Mfgs. No.	Our No.	Mfg. Code	Mfgs. No.	Our No.	Mfg. Code	Mfgs. No.	Our No.	Mfg. Code
150036	P208380	HDMI		M090091	CLJL	1545546	M090074	ECLD	1609419C1	M090535	NAVI	16500M	P226157	HDMI
150036A	P208380	HDMI	1517516	M170101	CLRK	1547250	M045193	OK	1615618901	P270540	ATCO	16500S	P226158	HDMI
150036CP	J340023	HDMI	1518	P206348	XAIR		M045193	TREX	161565700	P270539	ATCO	1650800	M001327	MNLS
150048	P207292	HDMI	151826	P206509	MOXY	1547275	P270532	TREX	1615695500	P270533	ATCO		M001327	OKSH
150048A	P207292	HDMI	1518317C1	M100695	NAVI		P270532	OK	1615704200	P270535	ATCO	165530	P206298	XAIR
150048CP	P207317	HDMI	151849479	H001035	NH	15503803	M100464	GM	1615721400	P270536	ATCO	16555	P206298	XAIR
15005	M120225	RKRM		H001035	FIAT	1550817	M060005	CLRK	1615736600	P270532	ATCO	16562	M070069	CRMY
15006	M120365	RKRM		H001035	CASE	1552235	M065065	ONAN	1615793200	M170101	ATCO	16563	M080236	CRMY
150060	P207289	HDMI	15186939	P270541	GM	1552305	P206410	ONAN	1615881700	P270541	ATCO	1657433C1	M090548	NAVI
150060A	P207289	HDMI		P270541	FPCO	1552734	X007830	ONAN	1616106	P270532	NACO	1657434C1	M090547	NAVI
150060CP	P207300	HDMI	1518825	M120154	CLRK	1552736	X007784	ONAN	1616488100	M070069	ATCO	1657436C1	M100695	NAVI
15007	M120382	RKRM		M120154	VLVO	15541	P270532	WIRG	1616710C1	M120100	NAVI	1657436C2	M100695	NAVI
1500831	M070008	CLRK	1518PE	P206349	XAIR	15552174	M110479	GM	16193981	M100043	ATCO	1658850	H001284	NACO
15010	M120235	RKRM	1519325	M090535	CLRK	15557637	M110479	GM	1619398100	M100043	KTSU	1658855	P270539	NACO
1501052	M100463	AMHO	1522201	M090146	JJI	15560	P206318	XAIR		M100043	ATCO	1660010M	P226150	HDMI
1501053	M090535	AMHO	15225291	M100465	BLDY	15600	P206515	HDMI	16193984	M100043	ATCO	1660010S	P226153	HDMI
15011	M120418	RKRM	15251993	M100463	TREX	1560203	M070028	CAT	1619508200	M120365	ATCO	167627	M060037	KSHA
1501108CP	P224707	HDMI	15253	P206313	XAIR	15609879	M110479	GM	1619621002	P270535	ATCO	167650	M065071	FMCO
150160CP	P224608	HDMI	15253991	M120225	TREX	156251	X004484	DRSS	1619621004	P270539	ATCO	16850024	M090072	UCP
150184CP	P224611	HDMI	15257794	M090538	TREX		X004484	KTSU	1619631801	M090091	ATCO	1688662C1	M100580	NAVI
15019056	M120176	HRSN	15267	P206605	RWMF	15638767	M085267	GM	1619631802	M100016	ATCO	16921	P270540	WIRG
1502168	P226158	HSTR	15271	M001503	RWMF	1568	J009560	XAIR	1619631803	M070069	ATCO	16980	X004484	CC
15023916	M120225	TREX	15272	M001702	RWMF	156815	M090544	CUMS	1619631804	M080024	ATCO	16F92	M090159	BABR
15026229	M111026	GMCT	152952	M070008	HSTR	15700	P206516	HDMI	1619631805	M065030	ATCO		M090159	CAT
	M111026	GM	153025	M085056	HSTR	157082	M120100	CUMS	161WA0601	M085008	CLRK	16H40043	M045237	FMC
1503535	M090210	FREQ	15311000	H001034	TREX	1572181	P270541	PNJK	161WA533	M085023	CLRK	16P2501200	P206308	DFLX
1503578	M070069	FREQ	15335	P206314	XAIR	1572191	M120235	JJI	161WA599	M080018	CLRK	16R48	M090210	BABR
1503898	M085084	FREQ	153353	J190044	XAIR		M120235	PNJK	16208	P207362	HOIST	17011	P206411	LEVN
1504069	M070068	FREQ	15340	P206315	XAIR	15723	J008681	RWMF	162443	H001279	KSHA	17053	X004536	MPOW
1504415	M090091	FREQ	15340PE	J009648	XAIR	15726	J008681	RWMF	162941001	M060038	VMER	17055	X004476	GBKE
1504913	M080024	FREQ	15345	P206316	XAIR	15738	P206339	RWMF	1630010M	P226140	HDMI	17057	X004478	GBKE
1504924	M100146	FREQ	15354	P206316	XAIR		P207335	RWMF	1630010S	P226144	HDMI	17058	X004480	LEVN
1505943	M085023	CLRK	153543	J190045	XAIR	15743	P206340	RWMF	163001256CP	J014621	DFLX	17060	X004482	IRT
15060400	J190061	LINK	153612111	M090158	NH		P206341	RWMF	16300M	P226129	HDMI		X004482	LEVN
15060401	J190060	LINK		M090158	CASE	15747	P207335	RWMF	16300S	P226132	HDMI		X004482	PDCI
15060402	J190058	LINK		M090158	FIAT		P206339	RWMF	16312	X006204	VCOR	17061	X004484	PDCI
15060406	P222756	LINK	153612123	M065044	CASE	157864	P270539	CMWK	1635010M	P226141	HDMI		X004484	MOGU
15060407	P222755	LINK		M065044	NH	157864A	P270539	CMWK	1635010S	P226145	HDMI		X004484	LEVN
1506827	P206394	FREQ		M065044	FIAT	158116	H001034	ECLD	16350M	P226154	HDMI	17074	X006203	PDCI
1508	P207339	XAIR	153612125	M120100	NH	1583528	M001799	CAT	16350S	P226133	HDMI	17075	X006202	PDCI
15090915	P270536	BOSS		M120100	FIAT	15850	P206517	HDMI	163513	P206407	KTSU	170797	M120235	KSHA
15091158	M060158	BOSS		M120100	CASE	1585116	H001034	ECLD		P206407	DRSS	17220PC0003	P206303	HNDA
151000	P206519	HDMI	153612127	P270538	CASE	1587517	X004962	VLVO		P206409	KTSU	17220PE8600	P206303	HNDA
151015	P206521	HDMI		P270538	NH	15900	P206518	HDMI		P206409	DRSS	17220PE8601	P206303	HNDA
1510461	M065030	FREQ		P270538	FIAT	15901	M120154	RKRM	163580	P270532	DIA	1728	J000230	NH
1510991	M085023	JJI	153612136	P270533	FIAT	15902	M120131	RKRM		P270532	ELECT	1730018	P206544	HDMI
1511657	M090594	FREQ		P270533	CASE	15903	M120100	RKRM	163621528	X004539	VMER	1730018SS	P206544	HDMI
1511658	P206399	FREQ		P270533	NH	15903Q	M120100	RKRM	163621530	M100016	VMER	17301	P206516	HGMP
1511719	M070028	FREQ	153612138	P270539	CASE	15904W	M120197	RKRM	163627673	M001502	VMER	17324	P208330	XAIR
1511946	P206398	FREQ		P270539	FIAT	15905	M120108	RKRM	163642518	M101169	VMER	173548	P206381	XAIR
1512	P206347	XAIR	153612153	P270532	CASE	15906	M120365	RKRM	163642783	M002121	VMER	17369	P208364	CRMY
1512238	M100049	CLRK		P270532	FIAT	15906Q	M120365	RKRM	163642784	P207364	VMER	1736900	M120235	OKSH
1512PE	P207331	XAIR		P270532	NH	15909	M120235	RKRM	163642854	M101167	VMER	17370	P208348	CRMY
1513792	M100048	CLRK	153612157	P270541	CASE	15909Q	M120235	RKRM	16400	X006203	VCOR	173838	M065034	NH
1513902	P270541	HSTR		P270541	FIAT	15911	M120418	RKRM	1640010M	P226142	HDMI		M065034	FMCO
1514079	P207414	FREQ		P270541	NH	15913	M122300	RKRM	1640010S	P226146	HDMI	17390F	M085023	OKSH
1514083	M085078	CLRK	153612171	M100043	FIAT	15913	M120100	RKRM	164001450CP	J014623	DFLX	17390FX	M085023	OKSH
151443	P206508	MOXY		M100043	CASE	159349	M120100	NACO	16400M	P226155	HDMI	1740018	P206546	HDMI
15149659	M111024	GM		M120100	HSTR		M120100	HSTR	16400S	P226156	HDMI	1740018SS	P206546	HDMI
1515	J190003	XAIR	153612177	M060251	NH	1594147	P206280	PIE	164034	M080018	CUMS	17402	P270534	WIMC
1515089	P207402	FREQ		M060251	FIAT	1594200	P206372	PIE	16404	P206297	XAIR	17403	P270536	WIMC
15152	P270531	RWMF		M060251	CASE	159842001	P226153	VMER	1644490	M100580	OKSH	17405	P270539	FILTER
15153	P270536	RWMF	153612182	M120365	NH	1599218	X004539	CAT		M100580	MNLS		P270539	LEAR
15155	P270539	RWMF		M120365	FIAT	1599219	P207366	CAT	1644500	M100582	OKSH		P270539	FLTR
15161	P270534	RWMF		M120365	CASE	1599220	P270543	CAT	164653	M100146	KSHA		P270539	WIMC
15163	P270541	RWMF	1536521	P206410	PNJK	160002	M090072	TESSI	1647375C1	M100580	NAVI	17418	P208386	XAIR
15164	P270543	RWMF	1541350	M060037	WHITE	16002	X005207	FRAM		M100580	DINA	17424	J024748	XAIR
151712	P206606	MOXY	1543567	M120108	CLRK		X005207	ALSY	1647998C1	M090520	NAVI	17436	P208358	XAIR
1517514	M100016	CLRK		M120108	ECLD	1604316600	P270542	ATCO	1648000C2	M090547	KTSU	17448	P206382	XAIR
	M100016	CLJL	154477	X004478	DRSS	16043541	P270543	SAME	16500	X006202	VCOR	1744959	M085008	CLRK
1517515	M090091	CLRK		X004478	KTSU	160692	M060158	FEDR	1650010M	P226143	HDMI	1750018	P206547	HDMI
	M090091	ECLD	15450	P206317	XAIR		M060158	DIA	1650010S	P226147	HDMI	1750018SS	P206547	HDMI
			154503	J009649	XAIR		M060158	ELECT						
						160713	M120100	KTSU						

Mfgs. No.	Our No.	Mfg. Code	Mfgs. No.	Our No.	Mfg. Code	Mfgs. No.	Our No.	Mfg. Code	Mfgs. No.	Our No.	Mfg. Code	Mfgs. No.	Our No.	Mfg. Code	
17518	P208392	XAIR	18375	P207353	RWMF	190044	J190044	AP	1903193M91	H001278	MF	1909526	M090301	STMC	
17524	P208338	XAIR	18376	J009636	RWMF	190045	J190045	AP		H001278	DETZ	1909528	M090538	STMC	
17536	P208374	XAIR	18377	J009648	RWMF	190046	J190046	AP		H001278	AGCO	1909532	M090520	STMC	
17548	P206383	XAIR	18400	P206410	HDMI	190054	J190054	AP	19035	P206370	CAT	1909537	M090563	STMC	
1755012	M085090	GRDL	18400CP	J009486	HDMI	190055	J190055	AP		P206370	BLNT	1909538	M090280	STMC	
17560	P208394	XAIR	18409	M065071	RWMF	190056	J190056	AP	1903842M91	H001284	DETZ	1909542	M090538	STMC	
176066740	P206321	BADG	18410	M100464	RWMF	190057	J190057	AP		H001284	AGCO	1909545	M090280	STMC	
176080988	J034673	BADG	18411	M065034	RWMF	190058	J190058	AP		H001284	MF	1909548	M090563	STMC	
176321	P207367	CAT	18416	M101167	RWMF	190059	J190058	AP	19043388	J024836	DLTC	1909550	M090534	STMC	
	P207367	BLNT	18420	M080018	RWMF	190060	J190060	AP	1906407	X007805	Marine	1909551	M090280	STMC	
17692	X004484	ADUM	18421	M090594	RWMF	190061	J190061	AP		X007805	SHUT	1909553	M090680	STMC	
17693	X007784	ADUM	18422	M085171	RWMF	190062	J190062	AP	190699	M085090	SLIC	1909700	M065065	STMC	
1769937	P206516	PIE	18427	P206318	RWMF	190063	J190063	AP	190704	P226151	SLIC	1909702	M065065	STMC	
17765	M070008	PETTI	18429	M001505	RWMF	1901107	M100465	STMC	1908250	M065065	STMC	1909703	M065065	STMC	
1796899	M090538	CLRK	18434	P207366	RWMF	1901125	M120382	STMC	190849	P208330	SLIC	1909801	M085171	STMC	
17B30012SS	J240003	HDMI	18440	P206411	RWMF	1901126	M110189	STMC	190851	X004536	SLIC	1909809	M090544	STMC	
17B30018SS	P206552	HDMI	1848432	H001284	FIAT	1901134	M120418	STMC	190861	P207596	SLIC	1909855	M100049	STMC	
17B30024SS	J240004	HDMI		H001284	CASE	1901140	M110077	STMC	190876	J000231	SLIC	1909858	M110014	STMC	
17B35012SS	J240005	HDMI	1849425	X004480	CASE	1901150	M110012	STMC	190889	J190013	SLIC	1909860	M100052	STMC	
17B35018SS	P206553	HDMI		X004480	FIAT	1901157	M090280	STMC	1909004	M065071	STMC	1909869	M100464	STMC	
17B35024SS	J024850	HDMI	1849471	H001278	FIAT	1901160	M1090158	STMC	1909006	M060232	STMC	1909870	M100464	STMC	
17B40012	P224479	HDMI		H001278	CASE	1901180	M085023	STMC	1909007	M065065	STMC	1909872	M100580	STMC	
17B40012SS	J240006	HDMI	1849473	H001034	FIAT	1901181	M090547	STMC	1909010	M060232	STMC	1909877	M100048	STMC	
17B40018	J024754	HDMI		H001034	CASE	1901187	M100466	STMC	1909018	M065065	STMC	1909882	M100465	STMC	
17B40018SS	P206554	HDMI	1849479	H001035	FIAT	190120012	J190044	PALA	1909057	M060055	STMC	1909898	M100463	STMC	
17B40024	J024835	HDMI		H001035	CASE	190120015	P207394	PALA	1909063	M065065	STMC	1909926	M120382	STMC	
17B40024SS	J024836	HDMI	18500	P206411	HDMI	1901204	M100213	STMC	1909065	M060232	STMC	1912400	X007829	CAT	
17B40036	J034743	HDMI	18500CP	J009487	HDMI	1901205	M100695	STMC	1909121	M080018	STMC	191419	P207415	DIA	
17B40036SS	J034673	HDMI	18571	M090072	URIG	1901208	M110189	STMC	1909122	M070028	STMC		P207415	ELECT	
17B40048	P226142	HDMI	18600	P207667	HDMI	1901220	M120566	STMC	1909123	M090362	STMC	1920915	X004539	FAUN	
17B50012	P224481	HDMI	186548	M070008	GRDL	1901221	M090547	STMC	1909131	M065065	STMC	192256	P206508	SLIC	
17B50012SS	J240007	HDMI	1878529	M090595	PALA	1901231	M100807	STMC	1909135	M070008	STMC	192257	P206543	SLIC	
17B50018	J024755	HDMI	188347	J240006	ELECT	1901234	M100695	STMC		M070008	FIAT	192258	P207290	SLIC	
17B50018SS	P206555	HDMI		J240006	DIA	1901289	M100052	STMC	1909146	M070050	STMC	1925199	X004480	SISU	
17B50024	J024837	HDMI		J240006	FEDR	1901292	M090548	STMC	1909207	M085008	STMC		X004480	ECLD	
17B50024SS	J024838	HDMI	18838	P206345	BVER	1901299	M065065	STMC	1909208	M085023	STMC		X004480	VALM	
17B50036	J034744	HDMI	188383	P206345	BVER	1901302	M065034	STMC	1909218	M085207	STMC	1928766	X004482	ECLD	
17B50036SS	J034674	HDMI	18940	M120131	CC	1901303	M090170	STMC	1909230	M085207	STMC	19298108	J000233	IR	
180005348	M090595	VMER	18A0557	M070050	LKBT	1901304	M085056	STMC	1909234	M085171	STMC	19298116	P206411	IR	
180006147	P206602	VMER		M070050	FMC	1901305	M085207	STMC	1909241	M085189	STMC	19300	P206600	HDMI	
180006149	P206603	VMER	18A23165S	M120108	FMC	1901311	M090563	STMC	1909245	M085172	STMC	19300Z	P206600	HDMI	
180009	J000202	NOVA	18A2316S	M120108	FMC	1901314	M111026	STMC	1909248	M090563	STMC	1930115	H001278	FIAT	
180011547	M002120	VMER	18A300	J000200	HDMI	1901331	M060247	STMC	1909250	M085172	STMC		H001278	CASE	
180011827	P270538	VMER	18A350	J000201	HDMI	1901332	M085090	STMC	1909300	M090544	STMC		H001278	NH	
180124	M060158	SLIC	18A3784	M120108	LKBT	1901334	M045193	STMC	1909303	M090362	STMC	19350	P206601	HDMI	
180316	M065034	SLIC		M120108	FMC	1901335	M065044	STMC	1909306	M090544	STMC	19350CP	P206609	HDMI	
180363	M045237	SLIC		M120108	LBX	1901336	M090595	STMC	1909310	M090072	STMC	19350Z	P206601	HDMI	
180697	X004478	CASE	18A400	J000202	HDMI	1901337	M100572	STMC	1909316	M090594	STMC	19400	P206602	HDMI	
18077	P206366	GOE	18A4305	X004484	FMC	1901342	M120135	STMC	1909327	M090535	STMC	19400CP	P206610	HDMI	
180864	P215307	CASE		X004484	LKBT	1901343	M085008	STMC	1909333	M090009	STMC	19400Z	P206602	HDMI	
	P215307	AUST	18A500	J000203	HDMI	1901345	M090544	STMC	1909336	M100464	STMC	194027	M001503	DWCH	
1810110	X004539	OKSH	18A557	M070050	FMC	1901346	M100582	STMC	1909341	M090146	STMC		M001503	CMWK	
18110	J018110	AP	18H0419	M120100	FMC	1901348	M122300	STMC	1909344	M090544	STMC	194027A	M001432	CMWK	
181338	P270531	DIA	190002	J190002	AP	1901351	M120235	STMC	1909348	M090544	STMC	194049	M001702	CMWK	
	P270531	FEDR	190003	J190003	AP	1901352	M100465	STMC	1909349	M090544	STMC		M001702	DWCH	
	P270531	ELECT	190004	J190004	AP	1901353	M100465	STMC	1909350	M100464	STMC	194064	J008671	CMWK	
18144	P270542	AP	190009	J190009	AP	1901358	M090544	STMC	1909351	M090146	STMC	194137A	M060158	CMWK	
	P206368	AP	190011	P207332	AP	1901360	M090074	STMC	1909352	M090544	STMC	194181	M001703	DWCH	
18154F	M085008	OKSH	1900120015	P207394	PALA	1901361	M090781	STMC	1909353	M090544	STMC		M001703	CMWK	
18154FX	M085008	OKSH	190013	J190013	AP	1901362	M120100	STMC	1909354	M090535	STMC	194181A	M001703	DWCH	
181DGE005E0523	P206508	AGEM	190014	J190014	AP	1901362	M120100	STMC	1909376	M090146	STMC		M001703	CMWK	
18200	P206403	HDMI	190016	J190016	AP	1901373	M100049	WLKR	1909377	M090781	STMC	194202	M001504	CMWK	
18225	P206404	HDMI	190017	J190017	AP	1901378	M100695	WLKR	1909400	M120100	STMC		M001504	DWCH	
18250	P206405	HDMI	190019	J190019	AP	1901382	M100465	STMC	1909401	M120108	STMC	194284A	J008681	CMWK	
18275	P206406	HDMI	190020	J190020	AP	1901383	M090595	STMC	1909416	M120154	STMC	194375	J024748	CMWK	
18300	P206407	HDMI	190023	J190023	AP	1901384	M090544	STMC	1909427	M120176	STMC	194375A	P208330	CMWK	
18325	P206408	HDMI	190025	J190025	AP	1902490	M070069	CLJL	1909428	M120131	STMC	194451	M001668	CMWK	
1834224	M001566	CAT	190026	P206286	AP		M070069	SISU	1909437	M120365	STMC	194456	M101168	CMWK	
	M001566	EAGP	190027	J190027	AP		M070069	ECLD	1909451	M120367	STMC	194456A	M101168	CMWK	
183422400	M001566	CAT	190037688	P207408	PALA		M070069	VALM	1909500	M090158	STMC	194479A	M060251	CMWK	
18350	P206409	HDMI	1900401	M060232	STMC	1902493	M085008	CLRK	1909505	M090280	STMC	194625	X004484	PRVT	
183670	J009612	CUMS	190041	J190041	AP	19030	M100052	RKRM	1909515	M120382	STMC	194843	X004482	PRVT	
			190042	J190042	AP										

Cross Reference

(See the first page of this section for the Manufacturer's Code Listing)



CROSS REFERENCE

Mfgs. No.	Our No.	Mfg. Code	Mfgs. No.	Our No.	Mfg. Code	Mfgs. No.	Our No.	Mfg. Code	Mfgs. No.	Our No.	Mfg. Code	Mfgs. No.	Our No.	Mfg. Code
19500	P206603	HDMI	1ME19301	M090544	MACK	2010005	P207405	STMC	2020249	M100463	GM	204035	X004482	BEQP
19500043	P206602	PRVT	1ME19301P1	M090544	MACK	2010014	P206372	STMC	2020250	P270534	STMC	2042783	M070028	EATN
19500183	J000203	PRVT	1ME19301P10	M090535	MACK	2010041	P206373	STMC	2020275	P270535	STMC	2043027	P206600	CAT
19500186	J009606	PRVT	1ME19301P2	M090074	MACK	2010061	P206374	STMC	2020300	P270536	STMC	2045555	M002117	ASV
19500260	X004480	PRVT	1ME19301P5	M090544	MACK	2010069	P206375	STMC	2020350	P270538	STMC	2046609	M090534	GM
19500278	P207667	PRVT	1ME19301P7	M090544	MACK	2010114	P207408	STMC	2020384	P270540	STMC	2046900	M065071	TRJN
19500467	X006203	PRVT	1ME19301P8	M100464	MACK	2010768	X004476	GM	2020385	P270543	STMC	204690000	M065071	TRJN
19500505	P206411	PRVT	1ME19301P9	M100464	MACK	2010769	X004538	GM	2020400	P270539	STMC	20477610	M001865	MACK
19500529	X009624	PRVT	1MEA19301P5	M090544	MACK	2010770	X004478	MTRC	2020406	P270837	STMC		M001865	VLVO
19500530	X007785	PRVT	1NPN90506	M100944	MACK		X004478	MOCH	2020415	P270837	STMC	20500	X004484	HDMI
19500534	P206607	PRVT	1P2035	M070008	CHLN	2010771	X004480	GM	2020417	P270838	STMC	2050002	P206297	STMC
19500581	P206408	PRVT	1X39440007	M065044	HAY		X004480	MOCH	2020450	P270540	STMC	2050010	P206297	WLKR
19500585	P206409	PRVT	1X6442	X004538	FMC		X004480	MTRC	2020500	P270541	STMC		P206297	STMC
19500586	P213191	PRVT		X004538	LKBT	2010772	X004482	GM	2020550	P270542	STMC	2050019	P206297	STMC
19500659	P206407	PRVT				2010773	X004484	UCP		P270542	WLKR	2050029	M045237	ASV
19500781	P206603	PRVT					X004484	GM	2020600	P270543	AMBC	2050032	P206298	STMC
19500862	J000230	PRVT				2011273	P206371	STMC		P270543	STMC	20500A	X006202	HDMI
19500CP	P206611	HDMI	200	J000220	AP	2011274	P206373	STMC	2021028	P270837	STMC	20500B	X004484	HDMI
19500Z	P206603	HDMI	20000145	J009644	ASTEC	2011275	P206374	STMC	2021029	P270838	STMC	20500ES	J000217	HDMI
19501529	P206507	PRVT		J009644	AST	2011276	P206375	STMC	2021300	P271507	STMC	205001	X004484	HDMI
19502069	P206410	PRVT	20000152	P207366	AST	2011280	P206375	STMC		P271507	WLKR	205012	X004478	BEQP
19502386	X004478	PRVT		P207366	ASTEC	201210	M065030	BEQP	2021400	P270837	STMC	2050657	J092689	STMC
1951025	M085056	CMWK	200002	P206279	TESSI	2013323	M100213	GM	2021500	P270838	STMC	2051892	M060055	ASV
1951026	M085078	CMWK	200004232	X006202	CAT		M100213	VLVO	2021600	P271511	STMC	205229	M090158	SHBR
1951315	M0850024	CMWK	20000646	P206398	AST	2015210C1	M100582	NAVI		P271511	WLKR	20580000	M065065	UPRH
1951468	M001502	CMWK		P206398	ASTEC	20153T	M080018	NLSN	2022400	P270539	STMC	20580001	M065044	UPRH
1951510	P270538	CMWK	20000651	J190003	AST	201550N	M060479	NLSN		P270539	WLKR	205996	M085090	CRMY
195617	J009607	PRVT		J190003	ASTEC	201551N	M060480	NLSN	20225	X004537	HDMI	20600	X004539	HDMI
195N949	M070008	OKSH	200014	P207351	TESSI	201552N	M060481	NLSN	2022500	P270541	STMC	2060001	P207667	STMC
19600	P207596	HDMI	200024	P206389	TESSI	201553N	M060482	NLSN		P270541	WLKR	2060004	P206403	STMC
19600CP	P207598	HDMI	200027	P207333	TESSI	201554N	M060483	NLSN	20225ES	J000212	HDMI	2060011	P206404	STMC
19600Z	P207596	HDMI	200028	P207335	TESSI	201555N	M065138	NLSN	202265	M060158	KSHA	2060016	P206405	STMC
196103	P270531	CMWK	200029	P206340	TESSI	201556N	M065139	NLSN	2022825	M100465	GM	2060025	P206406	STMC
196224	P206410	FMC	200035	P206343	TESSI	201557N	M065140	NLSN	2024270	X004536	GM	2060030	P206407	STMC
196332A	M100048	CMWK	2000393	M085056	RYGO	201558N	M065141	NLSN	2024271	X004537	GM	2060036	P206408	STMC
196350	P207402	CMWK	200043	P206348	TESSI	201559N	M091050	NLSN	20250	X004476	HDMI	2060042	P206409	STMC
196351	P206304	CMWK	200048	P207324	TESSI	201559N	M091050	NLSN	20250ES	J000211	HDMI	2060063	P206410	STMC
196373	P206309	CMWK	200052	J190016	TESSI		M065142	NLSN	20275	X004538	HDMI	2060070	P206282	STMC
196381	P270530	CMWK	200063	P206393	TESSI	201560N	M085407	NLSN	20275ES	J000213	HDMI	2060072	P206411	STMC
19745	P207339	CC	200068	P216174	TESSI	201561N	M085408	NLSN	2028001	P270535	STMC	206001	X004539	HDMI
197700	M045237	FMCO	200070	P207325	TESSI	201562N	M085409	NLSN	202SPT063	M170101	GRDL	2061063	J009486	WLKR
197721	M085023	FWD	200071	J190013	TESSI	201563N	M085410	NLSN	20300	X004478	HDMI	2061072	J009487	STMC
199254	M045237	FMCO	20007402	M065044	NH	201564N	M060483	NLSN	20300ES	J000214	HDMI		J009487	WLKR
199386R91	M085008	NAVI		M065044	FIAT		M085411	NLSN	203010820	X004536	WHITE	20619T	M070325	NLSN
19A200	J000220	HDMI	200079	P207350	TESSI	201565N	M091046	NLSN	2030195	P207382	STMC	206204	X004478	CRMY
19A225	J000222	HDMI	200095003	J190003	CAT	201566N	M091047	NLSN	2030202	P206313	STMC	206212	J240004	CRMY
19A250	J000221	HDMI	200095301	P206547	CAT	201567N	M091048	NLSN	2030208	P206314	STMC	206337	P206337	DD
19A275	J000224	HDMI	200095705	P208394	CAT	201568N	M091049	NLSN	2030212	P206316	STMC	2063420	M085056	TRJN
19A300	J000227	HDMI	200095811	P206509	KIMBLE	201569N	M091050	NLSN	2030213	P206317	STMC	206342000	M085056	OK
19A350	J000228	HDMI	2000SEU063	M090009	GRDR	201570N	M101167	NLSN	2030214	P206318	STMC		M085056	TRJN
19A400	J000230	HDMI	2001103	M060251	TYLR	201571N	M101168	NLSN	2030401	P206315	STMC		M085056	EATN
19A500	J000232	HDMI	200114	J190004	TESSI	201572N	M101169	NLSN	2030812	M100464	GM	206346	P206346	GNRC
19H0340	X004482	FMC	2002206	M100463	GM	201574N	M101171	NLSN	2031274	P207386	STMC	206466100	P206607	TRJN
	X004482	LKBT	200238N	M090595	FTGD	201575N	M120747	NLSN	2031276	P206317	STMC		P206607	TREX
	X004482	LBX		M090595	NLSN	201576N	M120748	NLSN	2031279	P207385	STMC	206615	P206615	DD
19TN726	M060005	OKSH	2002655	M090280	GM	201577N	M120749	NLSN	2031281	P206318	STMC	2067739	M001503	CAT
19X1442	M120135	STMC	2005340	M090159	GM	201578N	M120750	NLSN	2032269	M100465	GM	206773900	M001503	CAT
1D22101	M045237	FMHD	2006718	M100463	GM	201579N	M120751	NLSN	2033410	M100213	OKSH	2068063	J009486	WLKR
1G5192	P206411	RYGO	200827R91	M100049	NAVI	2016573	M120108	GRDL	2033626	M070008	EATN		J009486	STMC
	P206411	CAT	2009207	M090534	GM	20200	X004536	HDMI	20350	X004480	HDMI	2068072	J009487	WLKR
1G5679	P206409	TIM	200A1014	P206331	AP	2020001	P270532	STMC	20350A	X006204	HDMI		J009487	STMC
	P206409	CAT	200A1016	P226140	AP	2020006	P270533	STMC	20350ES	J000215	HDMI	2069207	M090534	GM
1G8122	M170101	RYGO	200A7516	P206331	AP	2020009R1	M100049	NAVI	20354626	M100944	VLVO	2069773	J009611	GM
	M170101	CAT	200K1014	P206331	AP	2020012	P270534	STMC	2038095	M090009	TRJN	2070196	P206609	STMC
1H0859	M070008	FMC	200K1016	P206331	AP	2020022	P270535	STMC	2039105	M090534	GM	2070201	P206603	STMC
	M070008	LKBT	200K7016	P206331	AP	2020083	P270536	STMC	203981100	P206342	TRJN	2070209	P206373	STMC
1H2180	M090158	LBX	200K7514	P206331	AP	20200ES	J000210	HDMI	20400	X004482	HDMI	2070215	P207596	STMC
	M090158	FMC	200K7516	P206331	AP	2020108	P270538	STMC	20400A	X006203	HDMI	2071275	P206609	STMC
	M090158	LKBT	200SEU063	M090009	GRDL	2020134	P270539	STMC	20400B	X004482	HDMI	2071276	P206610	STMC
1JD916	X007830	OKSH	200SP1063	M120100	GRDL	2020144	P270541	STMC	20400ES	J000216	HDMI	2071277	P206611	STMC
	X007830	ONAN	200SP063	M120100	GRDL	2020200	P270532	STMC	204001	X004482	HDMI	2071283	P207598	STMC
1M13284800	M045193	WHITE	2010003	P206371	STMC	2020225	P270533	STMC						

(See the first page of this section for the Manufacturer's Code Listing)

Mfgs. No.	Our No.	Mfg. Code	Mfgs. No.	Our No.	Mfg. Code	Mfgs. No.	Our No.	Mfg. Code	Mfgs. No.	Our No.	Mfg. Code	Mfgs. No.	Our No.	Mfg. Code
2071284	P206608	WLKR	20A500	J009607	HDMI			P207326	AST	21124	M060232	WLKR	2132540	P226155
	P206608	STMC	20C300	X007830	HDMI	2100988	P206508	STMC	21125	M065065	WLKR		P226155	STMC
2071285	P206600	STMC	20C350	X007831	HDMI	2100989	P206509	STMC		P210110	HDMI	2132550	P226157	STMC
	P206600	WLKR	20C400	X007784	HDMI	2100991	P206510	STMC	21126	M060232	WLKR	21328	M065065	WLKR
2071286	P206601	STMC	20C500	X007785	HDMI	2100992	P206511	STMC	21127	M060232	WLKR	21331	M060232	WLKR
	P206601	WLKR	20E01K1520	P270536	KTSU	2100993	P206512	STMC	21136	M065044	KUTK	2133640	J034743	WLKR
2072019	M120108	TRJN	20S200	J190056	HDMI	2100995	P206511	STMC	21137	P206405	KUTK		J034743	STMC
207201900	M120108	EATN	20S225	J190057	HDMI	2101000	P206512	STMC	21151	M065065	WLKR	2133650	J034744	STMC
2073181	M065034	EATN	20S250	J190058	HDMI	2101116	M120448	CRAN	211516500	M090210	TREX		J034744	WLKR
207335	P207335	ENGN	20S275	J190059	HDMI	210121	M070028	CRAN	2115188	P206408	TREX	2134056	P207331	CAT
207366	P207366	YOUNM	20S300	J190060	HDMI	21013	M090544	CRAN		P206408	OK	2134083	M100582	CAT
207368	P207368	VMER	20S350	J190061	HDMI	21016	M070028	CRAN	211618R91	M085023	NAVI	2134840	P226142	STMC
2076550	M085023	TRJN	20S400	J009623	HDMI	21018	M085023	WLKR	21169	M060232	WLKR	21365	M065065	WLKR
207655000	M085023	TRJN	20S500	J009624	HDMI		M120100	CRAN	21174	M120100	WLKR	21372	M060232	WLKR
	M085023	EATN	2100002	P206520	STMC	21021	M065065	WLKR	2117521	X004476	BLDY	21374	P222018	HDMI
20779	P206408	QUIN	2100003	P206521	STMC	21022	P206408	WLKR	2117539	X004480	BLDY	21384	J009611	HDMI
2078196	P206602	STMC	21000038	P207329	ASTEC	21023	M085023	CRAN	21188	M045237	WLKR	2139921	M090158	BLWL
	P206602	WLKR		P207329	AST	21024	M120365	CRAN	212	J000221	AP	214	J000222	AP
2078201	P206603	WLKR	21000039	P206336	ASTEC	21025	M045237	WLKR	2120401292	M090535	REX	2140057	P226142	STMC
	P206603	STMC		P206336	AST	21026	M100049	CRAN	2120402592	M090170	RXRDR	2140071	P226143	STMC
2078215	P207596	WLKR	2100004	P224481	STMC	21028	M060232	WLKR	2120403292	M060158	MIIN	2140530	P226129	STMC
	P207596	STMC	21000042	P206399	ASTEC	21030	M100049	CRAN		M060158	RXRDR	2140535	P226154	STMC
2079903	M090534	GM		P206399	AST		M065065	WLKR	2120403492	M070069	RXRDR	2140540	P226155	STMC
2080012	P222748	STMC	21000043	P207353	AST	2103006	M090301	GRDL	2120979	J009429	STMC	2140550	P226157	STMC
2080102	J000224	STMC		P207353	ASTEC	21035	M090544	CRAN	2120980	J009429	STMC	2140562	J024835	STMC
2080103	J000227	STMC	21000044	P206395	AST	21037	M090535	CRAN	2120981	J009429	STMC	2140563	J034743	STMC
2080105	J000228	STMC		P206395	ASTEC	21038	M085008	CRAN	2120982	X005207	STMC	2140564	P226142	STMC
2080107	J000230	STMC	21000048	J008671	ASTEC	21042	M100048	CRAN	2120986	P206543	STMC	2140566	J024837	STMC
2080109	J000232	STMC		J008671	AST	21046	M120100	CRAN	2120995	P206540	STMC	2140567	J034744	STMC
2081801	M090170	FMC	21000085	M090074	AST	21047	M120108	CRAN	2121006	X005207	WLKR	214059001	M065034	VMER
20824	P206306	TRUX		M090074	ASTEC	21048	M120131	CRAN	21213	J009612	HDMI	2140590011	M065034	VMER
208522	M080018	DRDT	21000090	J009636	ASTEC	210486	P206309	Scompa	2121405	J024758	STMC	2140804	J024754	STMC
2088102	J000224	WLKR		J009636	AST	21054	M120154	CRAN	21215	P206607	HDMI	2140806	J024755	STMC
	J000224	STMC	2100017	P206523	STMC	21055	M080024	CRAN	212361	M085008	CUMS	2142445	P270543	TREX
2088103	J000227	WLKR	2100019	P206526	STMC	2105576	M120131	TRJN	212362	M085023	CUMS	2143292	M120225	TREX
	J000227	STMC	21000195	P206393	AST	210557600	M120131	EATN	2124312	J009613	HDMI		M120225	OK
2088105	J000228	STMC		P206393	ASTEC		M120131	TRJN	212507592	M090538	CLRK	21439	M065065	WLKR
	J000228	WLKR	21000198	P207362	AST	21057	M100464	CRAN	21259	M065065	WLKR	21464	M090362	WLKR
2088107	J000230	WLKR		P207362	ASTEC	21058	P206319	GTMN	21287	M060232	WLKR	21465	M100049	WLKR
	J000230	STMC	2100022	P206524	STMC	21059	M065065	WLKR	212A1014	P206333	AP	21470	M070028	WLKR
2088109	J000232	STMC	2100023	P206525	STMC	2106001	M090301	VMER	212A1016	P206333	TRUX	21475	M065065	WLKR
	J000232	WLKR	21000360	P207363	ASTEC	21060011	M090301	VMER		P206333	AP	21476	M085023	WLKR
208852	M070028	DRDT		P207363	AST	21066	M090538	CRAN	212K1014	P206333	AP	21495	M060232	WLKR
2089167	M085008	TRJN	2100048	M120131	CRAN	21067	M100464	CRAN	212K7514	P206333	AP	2150066	P226146	STMC
208916700	M085008	TRJN	21000793	P207326	AST	21068	M065065	WLKR	2130010	P226148	STMC	2150400	P226147	STMC
	M085008	EATN		P207326	ASTEC		P207394	PDCI	2130015	P226149	STMC	2150651	P226145	STMC
2089643	M070068	EATN	2100083	M120197	CRAN	2106828	M002121	CAT	2130020	P226148	STMC	2150671	P226144	STMC
	M070068	TRJN	21001004	P207324	AST	2106829	M002121	CAT		P226148	WLKR	2150735	P226133	STMC
	M070068	YALE		P207324	ASTEC	21070	M090535	CRAN	2130026	P226141	STMC	2150740	P226156	STMC
208964300	M070068	TRJN	2100116	M120448	CRAN	21072	M120197	CRAN	2130530	P226129	STMC	2150750	P226158	STMC
2090008	P207784	STMC	2100128	M120131	CRAN	21074	M090547	WLKR	2130535	P226154	STMC	2150808	P206552	STMC
2090696	P206507	STMC	21001321	M120225	ASTEC		M120365	CRAN	2130540	P226155	STMC	2150809	P206553	STMC
2090987	J008167	STMC		M120225	AST	21078	P206303	LEVN	2130550	P226157	STMC	2150810	P206554	STMC
209115	J000230	Scompa	21001330	J009648	ASTEC		M100465	CRAN	2131025	P226149	STMC	2150812	P206555	STMC
2091176	M120365	GM		J009648	AST	21079	P206304	LEVN		P226149	WLKR	2150867	P226152	STMC
2092903	M070069	EATN	21001385	J190042	ASTEC	21082	M120189	CRAN	2131030	P226140	WLKR	2151020	P226151	WLKR
	M070069	TRJN		J190042	AST	21083	M120197	CRAN		P226140	STMC		P226151	STMC
209290300	M070069	YALE	2100146	P206515	STMC	21090	M100463	CRAN	2131035	P226141	STMC	2151025	P226152	STMC
	M070069	TJAK	2100150	M085207	CRAN	21091	M100213	CRAN		P226141	WLKR		P226152	WLKR
2093622	M085023	EATN	2100153	P206516	STMC	21092	M100048	CRAN	2131040	P226142	STMC	2151030	P226144	STMC
2094047	M065065	TRJN	2100164	M090091	CRAN	21093	M100463	CRAN	2131050	P226143	STMC		P226144	WLKR
209500200	M090158	TJAK	2100165	M120225	CRAN	21094	M120235	CRAN	2131060	P226150	WLKR	2151035	P226145	STMC
	M090158	EATN	2100167	P206517	STMC	21095	M090091	CRAN		P226150	STMC		P226145	WLKR
209802	X004476	WKSA	2100169	M100016	CRAN	21097	M065065	WLKR	21314	J009614	HDMI	2151040	P226146	STMC
209802B	X004536	WKSA	2100171	M140048	CRAN	21099	M120235	CRAN	2131840	J024754	WLKR	2151050	P226147	STMC
209802C	X004482	WKSA	2100180	P206518	STMC	21101	M085008	WLKR		J024754	STMC	2151060	P226153	WLKR
209802D	X004478	WKSA	2100338	P206519	STMC	2110221	P206616	STMC	2131850	J024755	STMC		P226153	STMC
209802E	X004484	WKSA	2100360	P207363	AST	21113	P206604	HDMI	2132440	J024835	WLKR	2151240	J240006	STMC
20A300	J009604	HDMI		P207363	ASTEC	2111312	P206605	HDMI		J024835	WLKR		J240006	WLKR
20A350	J009605	HDMI	21004	M065065	WLKR	211197	M090544	CUMS	2132450	J024837	STMC	2151250	J240007	STMC
20A400	J009606	HDMI	21007	M060232	WLKR	211206	M100049	CUMS	21325	M060232	WLKR	2151830	P206552	WLKR
			2100793	P207326	ASTEC	211213	M090072	CUMS	2132530	P226129	STMC		P206552	STMC
									2132535	P226154	STMC	2151835	P206553	WLKR

Cross Reference

(See the first page of this section for the Manufacturer's Code Listing)



CROSS REFERENCE

Mfgs. No.	Our No.	Mfg. Code	Mfgs. No.	Our No.	Mfg. Code	Mfgs. No.	Our No.	Mfg. Code	Mfgs. No.	Our No.	Mfg. Code	Mfgs. No.	Our No.	Mfg. Code
	P206553	STMC	2170966	P216175	STMC	21835	M090072	WLKR	21969	M100146	WLKR	22300AZ	P206334	DFLX
2151840	P206554	WLKR	2170971	P207329	STMC	21837	M100049	WLKR	21971	M120382	WLKR	22300S	P224685	DFLX
	P206554	STMC	2170972	P206349	STMC	218371	P205834	KSHA	219802	M065034	DRDT	2230745	M085056	FMC
2151850	P206555	STMC	2170973	P207327	STMC	21838	M085171	WLKR	21998	M065034	WLKR	22320220	M065044	IR
	P206555	WLKR	2170974	P206346	STMC	218439	H001284	KSHA	21H0145	J240012	LKBT	22320246	M100048	IR
2152440	J024836	WLKR	2170975	P207331	STMC	2185	P206343	NAPA	2200	M002164	MOB	22320253	M085090	IR
	J024836	STMC	2170992	P207331	STMC	21850	M060232	WLKR	22000214	M100463	AST	22332	M060251	TMCO
2152450	J024838	STMC	2171004	J190019	STMC	2188030	J008681	STMC		M100463	ASTEC	2233448	X004478	FMC
	J024838	WLKR	2171006	P207364	STMC	2190093	P206331	STMC	2200086	P207367	STMC	22337	M120366	WLKR
2152530	P226132	WLKR	2171009	P207362	STMC	2190106	P206333	STMC	2200087	P206849	STMC	22340350	M090301	IR
	P226132	STMC	2171010	P207366	STMC	2190110	J000127	STMC	2200092	P207368	STMC	22344816	P206520	IR
2152535	P226133	STMC	2171011	P207362	STMC	2190113	P206334	STMC	2200098	P206850	STMC	22350	P206335	DFLX
2152540	P226156	STMC	2171013	P206346	STMC	2190118	P206335	STMC	22004	M090280	WLKR	22350AZ	P206335	DFLX
215254001	M085208	VMER	2171014	P207362	STMC	2190125	P206336	STMC	22005	M100016	WLKR	2235724	M085023	FMC
2152540011	M085208	VMER	2171015	P207332	STMC	2190143	P206338	STMC	2200815613	M100464	BLDY	223599	P206323	GRVE
2152550	P226158	STMC	2171016	P207332	STMC	2190345	P206337	STMC	2201032	P206851	STMC	22362	M060250	TMCO
2153640	J034673	STMC	2171188	P207363	STMC	2191J000218	J000218	MACK	2201080	P207369	STMC	2236206001	M100016	HRCN
	J034673	WLKR	217149	M090544	HSTR	2191J008681	J008681	MACK	22016	P206344	LEAR	2236206186	J190002	HRCN
2153650	J034674	STMC	21722	M045237	WLKR	2191J009605	J009605	MACK		P206344	FLTR	2236206238	J009648	HRCN
	J034674	WLKR	21723	M065071	WLKR	2191J038612	J038612	MACK		P206344	FILTER	2236209022	P207333	HRCN
21540	M065065	WLKR	217326	M090544	RYGO	2191J090003	J190003	MACK	22029	P206555	MOGU	22364008	M100048	FMC
21578	M060037	WLKR	21745	M065065	WLKR	2191KYX004476	X004476	MACK	22046	P207339	LEVN	2236410	X004482	FMC
21579	M065030	WLKR	2177	P206546	NAPA	2191KYX004478	X004478	MACK	22056	P206286	WLKR	22367007	M085056	IR
21580	M070068	WLKR	2178014	P207364	STMC	2191KYX004480	X004480	MACK	220817	M085023	DRDT	22373179	M101170	IR
21581	M070069	WLKR	2180003	P207335	STMC	2191KYX004482	X004482	MACK	220847	P270532	SLIC	22376255	M090158	IR
21582	M080024	WLKR	2180004	P207333	STMC	2191KYX004484	X004484	MACK	220861	M001505	DLTC	22381	M120131	WLKR
21584	M090091	WLKR	2180040	P207333	STMC	2191KYX004536	X004536	MACK	2210112	P207415	STMC	22382550	M060482	IR
2160001	P206279	STMC	2180049	P207335	STMC	2191KYX004537	X004537	MACK	2210126	P206927	STMC	22391	M090548	WLKR
2160004	P207350	STMC	2180054	P216172	STMC	2191KYX004539	X004539	MACK	2210131	P206302	STMC	22395867	M120750	IR
2160048	P206279	STMC	2180058	P206341	STMC	2191M080018	M080018	MACK	2210141	P206303	STMC	22400	P206336	DFLX
2160053	P207350	STMC	2180062	P206343	STMC	2191M080024	M080024	MACK	2210148	P206304	STMC	22400AZ	P206336	DFLX
2160056	P206280	STMC	2180064	P206345	STMC	2191M085171	M085171	MACK	2210154	P207298	WLKR	22400S	P224686	DFLX
2160065	P206281	STMC	2180067	P206348	STMC	2191M090072	M090072	MACK		P207298	STMC	2240164	P208388	STMC
2160070	P206282	STMC	2180075	P206340	STMC	2191M090091	M090091	MACK	2210695	P206301	STMC	2240176	P208358	STMC
2160074	J190025	STMC	2180079	P206342	STMC	2191M090535	M090535	MACK	2210696	P206303	STMC	2240463	P208374	STMC
2160506	P207359	STMC	2180081	P206344	STMC	2191M090544	M090544	MACK	2210697	P206304	STMC	2240470	P206383	STMC
2161012	P206286	STMC	2180084	P206347	STMC	2191M090559	M090559	MACK	2210698	P207298	STMC	224063	P270539	FMC
2161126	P206280	STMC	2180096	P207338	STMC	2191M090595	M090595	MACK	221303	M045123	KSHA	2240878	P208388	STMC
2161127	P206281	STMC	2180381	P207339	STMC	2191M100052	M100052	MACK	221322	M090158	DRDT	2240880	P208394	STMC
2161128	P206282	STMC	2180488	J008681	STMC	2191M100465	M100465	MACK	22139455	M122300	IR	2240882	J024748	STMC
2161129	J190025	STMC		P206344	CRMY	2191M100580	M100580	MACK	22139544	M122300	IR	2240883	J024750	STMC
2161144	P207346	STMC	2180508	P207341	STMC	2191M100582	M100582	MACK	22139555	M122300	IR	22436794	P207285	IR
2161146	J190023	STMC	2181002	P207345	STMC	2191M101158	M101158	MACK	221499	M100049	DRDT	2244018	P208386	WLKR
2161147	J190027	STMC	2181003	P206353	STMC	2191M120382	M120382	MACK	22163	P216200	WLKR	22445	M060480	WLKR
2161153	J190023	STMC	2181006	P207346	STMC	2191MFM090544	M090544	MACK	22167	P216204	WLKR	22449	M090534	WLKR
2161154	J190025	STMC	2181007	P206354	STMC	2191MPM090535	M090535	MACK	22168	P208359	WLKR	22452	M120418	WLKR
2161155	P207359	STMC	2181124	P207340	STMC	2191MPM100463	M100463	MACK	22169	P208375	WLKR	22453039	P206327	IR
2161158	P206283	STMC	2181125	P206341	STMC	2191P206282	P206282	MACK	221694	M060232	DRDT	22453047	P206328	IR
21627	P206341	KUTK	2181126	P206343	STMC	2191P206283	P206283	MACK	2218000	P207559	STMC	22453625	M110479	IR
2169001	M085056	VMER	2181127	P206345	STMC	2191P206318	P206318	MACK	2220111	P206306	STMC	22456172	M120235	IR
21690011	M085056	VMER	2181128	P206348	STMC	2191P206333	P206333	MACK	2220119	P206308	STMC	22456198	J190003	IRCR
216931	M060055	DRDT	2181129	P206340	STMC	2191P206336	P206336	MACK	2220122	P206927	STMC		J190003	TKNG
2170003	P207322	STMC	2181130	P206342	STMC	2191P206344	P206344	MACK	2220124	P206309	STMC		J190003	IR
2170005	P207324	STMC	2181131	P206344	STMC	2191P206347	P206347	MACK	2220130	P206310	STMC	22456701	P206521	IR
2170006	P207325	STMC	2181132	P206347	STMC	2191P206375	P206375	MACK	2220133	P206311	STMC	224620	M090210	DRDT
2170067	P206348	STMC	2181153	P207341	WLKR	2191P206400	P206400	MACK	2220136	P208392	STMC	2246593	M110189	CAT
2170147	P207322	STMC	2181154	P207339	STMC	2191P206410	P206410	MACK	2220967	P208386	STMC	2247830	H001279	FMC
2170151	P216174	STMC	2181182	P206344	STMC	2191P206615	P206615	MACK	2220979	P206310	STMC	22500	P206337	DFLX
2170156	P207324	STMC	2181183	P206340	STMC	2191P207339	P207339	MACK	2220981	P206311	STMC	2250006	P206612	WLKR
2170160	P207325	STMC	2181185	P206344	STMC	2191P207408	P207408	MACK	2220982	P208338	STMC	225002	M090535	RIMP
2170166	J190013	STMC	2181186	P206344	STMC	2191P207414	P207414	MACK	2220984	P206309	STMC	22500AZ	P206337	DFLX
2170171	P207328	STMC	2181187	P206341	STMC	2191P207596	P207596	MACK	2220985	P208358	STMC	22500S	P224687	DFLX
2170174	P207329	STMC	2181191	P206347	STMC	2191P208394	P208394	MACK	2220989	P208392	STMC	225010	P206542	RIMP
2170179	P206349	STMC	2181194	P207339	STMC	2191P216197	P216197	MACK	22214	M090547	WLKR	225012	M090074	RIMP
2170182	P207326	STMC	2181195	P206350	STMC	2191P270541	P270541	MACK	22231	M090563	WLKR	2250190	P207568	STMC
2170188	P207327	STMC	2181196	J190004	STMC	2191WZM100464	M100464	MACK	222434	M100463	IVECO	2250205	P207567	STMC
2170194	P206346	STMC	2181201	P206340	STMC	2191X004482	X004482	MACK	22250	P206333	DFLX	2250207	P207566	STMC
2170203	P207331	STMC	2181202	P206342	STMC	21923	M120154	WLKR	22254965	P207341	IRCR	225021	M100465	RIMP
2170380	P207330	STMC	2181203	P206344	STMC	219567	P206406	NH		P207341	IR	225029	M120101	RIMP
2170494	P206346	STMC	2181204	P206344	STMC		P206406	CASE	222578	M120154	DRDT	225039	M122300	RIMP
2170507	P216175	STMC	21832	M090520										

Mfgs. No.	Our No.	Mfg. Code	Mfgs. No.	Our No.	Mfg. Code	Mfgs. No.	Our No.	Mfg. Code	Mfgs. No.	Our No.	Mfg. Code	Mfgs. No.	Our No.	Mfg. Code
2250943	P207566	STMC	22789	M110012	WLKR	2298024	J009636	STMC	2320002	P206300	STMC	2387440011	M100048	VMER
2250944	P207620	STMC	22808	M085008	WLKR	2298026	J009644	STMC	23207269	M170101	IR	2388025	P206410	TYLR
2251095	P207619	STMC	2280806	J000127	STMC	2298036	J009637	STMC	2320939	P205979	STMC	238884	P207324	KSHA
2251096	P207581	STMC	22809	M090544	WLKR	2298037	P207354	STMC	2320940	P205976	STMC	2390713	J000227	WLKR
2251097	P207620	STMC	22823	M090535	WLKR	2298038	J009645	STMC	2320941	P206299	STMC		J000227	STMC
2251098	P207582	STMC	22828	M090544	WLKR	22984056	M090538	KOEH	2321070	M065065	CLRK	2390714	J000228	WLKR
2251254	P207567	WLKR	22829	M090535	WLKR	22991	M111029	WLKR		M065065	TREX		P206601	STMC
	P207567	STMC	22833	M120365	WLKR	22H0492	M080024	LKBT	2323080	M085407	MRBR	2390715	J000230	STMC
2251259	J009393	STMC	22834	M090544	WLKR		M080024	FMC	23275	P206409	TMPO	2390716	J000232	STMC
2251261	P207581	STMC	22835	M100464	WLKR	22H0644	P207332	LKBT	23374	M090210	TMPO	2390728	J000233	STMC
2251262	P207567	STMC	228355	M090544	HSTR	2300010669	M120108	UPTI	2339654	M065034	FMC		J000233	WLKR
2251264	P207581	STMC	22836	M100582	WLKR	230010002	M090544	VLVO	23400	P206299	HDMI	2390850	P206525	TYLE
2251265	P207568	STMC	22837	P206388	WLKR		M090544	WGMC	23419686	M065065	DD	2391621	P207282	TYLE
2251275	P207581	STMC	22838	P206389	WLKR	230010003	M100464	WGMC	23423601	M080024	PETB	2392079	P206382	TYLE
	P207581	WLKR	22843	M120197	WLKR	230010004	M090535	VLVO	23426	P206546	HAVA	2393084	M065065	CAT
2251277	P207568	WLKR	22844	M090146	WLKR	230010005	M090544	VLVO	2345	P206280	XAIR	2393341	P206508	TYLE
2251279	P207581	WLKR	22845	P206386	WLKR		M090544	WGMC	2345PE	P207351	XAIR	2398713	J000227	WLKR
22551	M090158	WLKR	22846	P206387	WLKR	230010008	M100463	WGMC	234A1014	J000127	AP		J000227	STMC
22552	M120225	WLKR	22847	P206390	WLKR	230010009	M100464	VLVO	234A1016	J000127	AP	2398714	J000228	STMC
22566	M085267	WLKR	22848	P206391	WLKR	230010010	M100464	WGMC		J000127	TRUX		J000228	WLKR
22572	M090594	WLKR	22851	M100463	WLKR		M100464	VLVO	234A1414	J000127	AP	2398715	J000230	WLKR
22583	M065065	WLKR	22856	P216228	WLKR		M100464	UPTI	234C1016	J000127	AP		J000230	STMC
22600	P206338	DFLX	22863	P208389	WLKR	230010011	M100463	VLVO		J000127	DFLX	2398716	J000232	WLKR
22600AZ	P206338	DFLX	22864	P208395	WLKR	230010021	M120365	WGMC	23500	P206299	HDMI		J000232	STMC
22604	M090547	WLKR	22866	M085172	WLKR		M120365	WSTI	235024	P208336	HDMI	23991	M060005	KOEH
2260801	M045237	FMC	2288000	P207419	STMC		M120365	VLVO	235024A	P208336	HDMI	2399991	M070068	VME
2261697	M065065	FMC	22882	P207320	WLKR	230010027	M120100	WGMC	235040011	X004482	VLVO		M070068	CLRK
22628	M065034	WLKR	22885	P207321	WLKR		M120100	VLVO	235043430	X009076	WSTI	240001	P206544	AP
22630	M070008	WLKR	22888	M110189	WLKR	230010047	M100463	WGMC		X009076	FRTL	240003	J240003	AP
22632	M090158	WLKR	22891	P216202	WLKR		M100463	VLVO	235043814	X007785	WSTI	240004	J240004	AP
22633	M090170	WLKR	22892	P207299	WLKR	230010051	M120197	WGMC		X007785	VLVO	240005	J240005	AP
22634	M100146	WLKR	22894	P207300	WLKR	230010052	M100464	WGMC	235043815	X007784	VLVO	240006	J240006	AP
22636	M085056	WLKR	22896	M090781	WLKR	230010054	M120365	VLVO	235048	P206377	HDMI	240007	J240007	AP
22637	M085207	WLKR	22897	M110189	WLKR		M120365	WGMC	235048A	P206377	HDMI	240012	J240012	AP
22663	M090563	WLKR	22899	M110189	WLKR	230010056	M100465	VLVO	235048A	P206377	HDMI	240018	P207297	HDMI
22665	M120367	WLKR	22902	P207302	WLKR	230010064	M100465	VLVO	23507610	P210110	ALSN	240018	P207297	HDMI
22691640	M100463	KTSU	2290220	P206397	STMC	230010066	M100043	VLVO		P210110	DD	24001965	P207051	CMJ
	M100463	DMAG	2290221	P207364	STMC	230010069	M120108	VLVO	23507611	X006202	ALSN	240024	J240012	HDMI
	M100463	MH	2290224	P206398	STMC		M120108	UPTI		X006202	DD		J240024	AP
2269681	M060232	STMC	2290227	P206399	STMC	230010070	M100465	VLVO	23507616	P206403	ALSN		P206389	TESSI
2270257	P207281	STMC	2290229	P206400	STMC	230010072	M120100	WGMC		P206403	DD	240024A	J240012	HDMI
2270260	P207282	STMC	2290230	J009635	STMC	230010073	M090544	VLVO	23507629	P213191	DD	240048	P207295	HDMI
2270271	P207283	STMC	2290231	J009639	STMC	230010077	M120365	VLVO		P213191	ALSN	240048A	P206378	HDMI
2270542	J024737	STMC	2290232	J009641	STMC	230010078	M100582	VLVO	2351588	M065030	CLRK	240048CP	P206388	HDMI
2270544	P216191	STMC	2290232	J009641	STMC	230010081	M100580	VLVO		M065030	CLJL	240060	P207290	HDMI
2270547	J024735	STMC	2290660	P207361	STMC	230010084	M100582	MACK		M065030	VME	240060CP	P206390	HDMI
2270551	J024739	STMC	22907	M122300	WLKR		M100582	VLVO	23519686	M065065	ALSN	240065	P208358	TESSI
2270565	P208324	STMC	22909055	P206350	IRCR	230013215	M100582	VLVO		M065065	DD	240072	J640001	HDMI
2270566	P208364	STMC		P206350	IR	230013221	M120100	VLVO	235200015	X007784	UPTI	240072A	J640001	HDMI
2270573	P208348	STMC	2291361	M085008	MRTZ	230013409	M100463	VLVO	23545	P206281	XAIR	2400749	P207282	STMC
2270574	P208380	STMC	22915	M100213	WLKR	230013410	M100465	VLVO	23570001	M085056	RYGO	240083	P208350	TESSI
2270577	P207285	STMC	22916	M100466	WLKR	230013411	M100465	VLVO	23570002	M070008	RYGO	2400860	J009648	STMC
2270578	P207287	STMC	22917	M120235	WLKR	230013417	M100463	VLVO	23570014	M090280	RYGO	2400865	J009650	STMC
2270579	P216197	STMC	22920	M100465	WLKR	230013420	M100465	VLVO	23570016	M060055	RYGO	240103	J014621	TESSI
2270585	P207286	STMC	22924	M100465	WLKR		M100465	WSTI	23570018	M090170	RYGO	240114	P206309	TESSI
2270586	P207292	STMC	22925	M100465	WLKR	230013428	M085171	WSTI	23570031	M090301	RYGO	240118A	P224696	HDMI
2270590	P207288	STMC	22936	M090544	WLKR	230013441	M100582	WSTI	23570049	M065044	CMJ	240136CP	P224696	HDMI
2270598	P207289	STMC	22937	M100695	WLKR	230013455	M100463	WSTI	2362507	M002120	CAT	240224	M100146	SLAR
2270951	P206376	STMC	22938	M100807	WLKR	230013463	M100944	WSTI	23641	P270538	CRMY	2403029	M065034	TYLR
2270952	P206376	STMC	22940	M090074	WLKR	230013474	M101182	FRTL	23642	P270539	CRMY	2403031	M085023	TYLR
2270955	P206377	STMC	22941	M090781	WLKR		M101182	WSTI	2370035	M170101	RYGO	2403032	M070008	TYLR
2270958	P206378	STMC	22943	M120100	WLKR	230013807	M100465	VLVO	237010001	M090091	VLVO	2403033	M085008	TYLR
2270961	P206379	STMC	22963	M100465	WLKR	230013815	M100464	VLVO	237010002	M080024	VLVO	2403034	M090544	TYLR
2270962	P208393	STMC	22965	M090544	WLKR	230024	P208328	HDMI	237013407	M090091	WSTI	2403036	M090009	TYLR
22766	M060247	WLKR	2296531	P206344	TYLE	230024A	P208328	HDMI	237013601	M090091	VLVO	2403037	M120100	TYLR
22767	M085090	WLKR	2296533	P206345	TYLE	230036	P206376	HDMI	237779A1	P206369	CASE	2403039	M090538	TYLR
22769	M045193	WLKR	2296557	J008681	TYLE	230036A	P206376	HDMI	2380904	P207314	STMC	2403044	M090210	TYLR
22770	M065044	WLKR	22966	M100695	WLKR	230048	P206376	HDMI	2380906	P224628	STMC	2403046	M090159	TYLR
22771	M090595	WLKR	2296712	P206543	TYLE	230048A	P206376	HDMI	2380908	P207299	STMC	2403049	M090535	TYLR
22774	M100016	WLKR	2297136	M080018	FMC	2306635	M085172	GM	2380909	J340023	STMC	2403052	M090146	TYLR
22775	M100572	WLKR	2297365	M120225	MRTZ	230848	M060232	DRDT	2380910	P207317	STMC	2403054	M100464	TYLR
22786	M120135	WLKR	2297959	P206407	FMC	2310254	P206547	STMC	2380911	P207300	STMC	2403057	M070069	TYLR
			2298016	J009631	STMC	23162	M100049	HAVA	2380912	J240024	STMC	2403076	M120365	TYLR
									238744001	M100048	VMER			

Cross Reference

(See the first page of this section for the Manufacturer's Code Listing)



CROSS REFERENCE

Mfgs. No.	Our No.	Mfg. Code	Mfgs. No.	Our No.	Mfg. Code	Mfgs. No.	Our No.	Mfg. Code	Mfgs. No.	Our No.	Mfg. Code	Mfgs. No.	Our No.	Mfg. Code
2403077	M120197	TYLR	2430277	P207350	STMC	2450724	P206333	STMC	24758	J024758	AP	250010865	M120131	SLAR
2403144	M100465	TYLR	2430278	P207351	STMC	2450726	P206334	STMC	248280	M090301	SLAR	250024779	M100016	SLAR
2403151	M090544	TYLR	2430283	P207352	STMC	2450727	P206334	STMC	2482970	M090544	GM	250024780	P270543	SLAR
2403184	M085207	TYLR	2430286	P207353	STMC	2450728	P206335	STMC	2482972	M100048	GM	250024CP	P224589	HDMI
2403359	M085078	TYLR	2430301	P207354	STMC	2450729	P206336	STMC	248337	J009649	ALSY	250030884	M100146	SLAR
2403518	M100572	TYLR	2430492	P207353	STMC		P206336	CRMY		J009649	FRAM	2500355	P206405	DMT
2403666	P206614	TYLE	2430493	P207354	STMC	2450730	P206336	STMC	24835	J024835	TRUX		P206405	SYNER
2403714	P207419	TYLR	2430613	P216169	STMC	2450732	P206337	STMC		J024835	AP	2500357		DMT
2403783	M065073	TYLR	2430614	P207353	STMC	2450736	P206337	STMC	24836	J024836	AP		P206407	SYNER
2404031	M085023	TYLR	2430618	P207354	STMC	2451261	P226140	STMC		J024836	TRUX	2500361	P206411	DMT
240806	M080024	SLAR	2430621	P216169	STMC	2451282	P206338	STMC	24837	J024837	AP		P206411	SYNER
241260	X004484	SLAR	24344	P206309	TRUX	2460048	P216197	DFLX		J024837	TRUX	2500362		DMT
241415	X004482	SLAR		P206309	AP	2460048AZ	P216197	DFLX	2483764	M100048	GM		P207667	SYNER
2419264	X007784	CAT	24345	P206310	TRUX	24609	P206547	HAVA	24838	J024838	AP	250048	P206379	HDMI
2419265	X007785	CAT		P206310	AP	24658	P206547	TRUX		J024838	TRUX	250048A	P206379	HDMI
241970	P226144	SLAR	24346	J024748	TRUX		P206547	AP	24850	J024850	AP	250048CP	P206389	HDMI
242029	X004480	SLAR	24347	P206312	TRUX	24672	P206305	AP		J024850	TRUX	250060	P208393	HDMI
24205	P206301	TRUX		P206312	AP		J024747	TRUX	2485787	M085023	GM	250060A	P208393	HDMI
2421143	J014623	STMC	2435018	P207281	DFLX	24675	P206552	TRUX	2488074	M065065	GM	250060CP	P206391	HDMI
2421144	P207309	STMC	2435018AZ	P207281	DFLX	24676	P206553	TRUX	2488076	M085023	GM	2500638		STMC
2421281	P206384	STMC	2435024	J024735	DFLX	24677	P206554	TRUX	248888	M085056	FMCO	2500639	J009613	STMC
2421282	P207308	STMC	2435036	P208348	DFLX	24678	P206555	TRUX	24908	M080018	WILM	2500640	P206606	STMC
2421283	P206385	STMC	2435036AZ	P208348	DFLX	24696	P207559	AP		M080018	AGEM	2500900	P206604	STMC
2421285	P216200	STMC	2435048	P207286	DFLX	24697	P207419	GOE	24921330	M085023	GRDL	2500901	P206605	STMC
	P216200	WLKR	2435048AZ	P207286	DFLX		P207419	AP		M085023	WRNR	2500930	J009612	STMC
2421286	P208359	STMC	24400	P205976	HDMI	24697Q	P207419	AP	24938	P224633	TRUX	2500931	P206607	STMC
2421287	J034746	STMC	2440001	P207411	STMC	24708	P208328	AP	24939	P208338	TRUX	2500970	P213191	STMC
2421288	P208375	STMC	2440018	P207282	DFLX	24709	P208336	AP	24941	P216191	TRUX	2501017	P210110	STMC
2421289	P216204	STMC	2440024	J024737	DFLX	24710	P207281	AP	24MP50036CP	P216227	DFLX	2501102	P270543	SYNER
2421291	P207319	STMC	244002R91	M085008	NAVI	24711	P207282	TRUX	24MP50048CP	P216228	DFLX	2501153	P206341	SYNER
2421292	P206386	STMC	2440036	P208364	DFLX		P207282	AP	24P30024	P208328	DFLX		P206341	DMT
2421293	P207320	STMC	2440036AZ	P208364	DFLX	24712	P207283	TRUX	24P30024AZ	P208328	DFLX	2501164	P206340	DMT
2421294	P206387	STMC	2440048	P207287	DFLX		P207283	AP	24P30036	P206376	DFLX		P206340	SYNER
2421295	P207321	STMC	2440048AZ	P207287	DFLX	24713	P207297	GOE	24P30036AZ	P206376	DFLX	250118CP	P224703	HDMI
2421296	P208389	STMC	2440060	P207288	DFLX		P207297	AP	24P30048	P206376	DFLX	250136CP	P216227	HDMI
2421297	P207301	STMC	2440060AZ	P207288	DFLX	24714	P207297	TRUX	24P30048AZ	P206376	DFLX	250148CP	P216228	HDMI
2421298	P208395	STMC	2440060CP	P207299	DFLX		P207298	AP	24P35024	P208326	DFLX	250160CP	J540008	HDMI
2421299	P207302	STMC	244007R91	M085023	NAVI	24715	P207308	AP	24P35024AZ	P208336	DFLX	2501710	M090538	CLRK
2421300	J640005	STMC	2440191	P206367	STMC	24716	P207309	AP	24P35036	P208324	DFLX	250172CP	P224609	HDMI
2421301	P216202	STMC	2440192	P206368	STMC	24717	P208386	AP	24P35048	P206377	DFLX	2501775	P206301	DIND
2421302	P224600	STMC	2440200	P206369	STMC		P208386	TRUX	24P35048AZ	P206377	DFLX	2501787	P207397	DIND
2421303	P216205	STMC	2440204	P206370	STMC	24718	P208392	TRUX	24P40024	J240012	DFLX	2501803	M090170	VLVO
2421305	P224635	STMC	2440602	P207414	STMC		P208392	AP	24P40048	P206378	DFLX		M090170	CLRK
2421307	P224638	STMC	2440753	P207411	STMC	24719	P208330	AP	24P40048CP	P206388	DFLX	2503736	M060480	DIND
2421308	P209913	STMC	2440754	P206366	STMC	24720	P208338	AP	24P40060CP	P206390	DFLX	2503737	P206306	DIND
2421310	P209912	STMC	2440755	P206369	STMC	24721	P206384	AP	24P40072	J640001	DFLX	2503776	M060158	DIND
2421311	P209910	STMC	2440756	P206370	STMC	24722	P206385	AP	24P40096CP	P206391	DFLX	2503777	M002117	DIND
2421317	P224636	STMC	2440758	P207413	STMC	24723	P206385	AP	24P50048	P206379	DFLX	25048810	M090074	MACK
2421402	J024749	STMC	2440762	P206367	STMC	24731	P216191	TRUX	24P50048AZ	P206379	DFLX	2505781	X004484	PNJK
2421403	J024757	STMC	2440763	P206368	STMC	24735	J024735	TRUX	24P50048CP	P206389	DFLX	25069983	M100043	MACK
2421404	J024751	STMC	2444889	M065065	GM		J024735	AP	24P50060	P208393	DFLX	2508001	J009614	STMC
2421405	J024758	STMC	244511	P206282	XAIR	24737	J024737	TRUX	24P50060AZ	P208393	DFLX	25084209	M085171	MACK
242367	M120225	SLAR	2445PE	P207353	XAIR	24739	J024739	TRUX	2500001	J009611	STMC	25092	M001327	CRMY
2423714	M085023	GM	2446593	M110028	CAT		J024739	AP	2500002	P210110	STMC	2509461	M100146	JJI
2426018	P207559	STMC	244951001	X007824	VMER	24745	P224633	TRUX	2500003	P270534	SYNER		M100146	PNJK
24270004	M060037	SCRM	2449510011	X007824	VMER	24746	J024746	AP		P270534	DMT	2510883	M090210	CLRK
24270006	M100016	SCRM	24500	P206300	HDMI		J024746	TRUX	2500005	J009612	STMC		M090159	ECLD
2427177	M065065	GM	2450001	P206331	STMC	24747	J024747	TRUX	2500006	J009611	STMC	2511251	M085090	PNJK
2427277	M085023	GM	2450003	P206333	STMC		J024747	AP	2500007	P270538	SYNER	25114233	X004480	BNNTA
2428242	M065065	GM	2450004	J000127	STMC	24748	J024748	AP		P270538	DMT	251210	M090072	CUMS
2430001	P207349	STMC	2450018	P207283	DFLX		J024748	TRUX	2500012	P270543	SYNER	251211	M090074	CUMS
2430002	P207347	STMC	2450018AZ	P207283	DFLX	24749	J024749	AP		P270543	DMT	2512224	M170101	VLVO
2430004	P207350	STMC	2450024	J024739	DFLX	24750	J024750	AP	2500016	J009613	STMC	2513322	X004484	ECLD
2430024	P216191	DFLX	2450024AZ	J024739	DFLX		J024750	TRUX	2500018	P222745	STMC	251601	X004539	MOXY
2430024AZ	P216191	DFLX	2450036	P208380	DFLX	2475010	P224412	CAT	2500020	J009618	STMC	25175546	J190059	AMC
2430036	M208324	DFLX	2450036AZ	P208380	DFLX	2475011	M002134	CAT	2500021	J009612	WLKR		J190059	XMN
2430036AZ	P208324	DFLX	2450048	P207292	DFLX	24751	J024751	AP	2500022	P222018	WLKR	251765	P206607	MOXY
2430048	P207285	DFLX	2450048AZ	P207292	DFLX	24754	J024754	TRUX		P222018	STMC	251766	P206607	MOXY
2430048AZ	P207285	DFLX	2450048CP	P207317	DFLX		J024754	AP	2500023	P222018	WLKR	2519859	M120189	CLRK
2430048CP	P207314	DFLX	2450060	P207289	DFLX	24755	J024755	AP		P222018	WLKR		M120189	TREX
2430263	P207347	STMC	2450060AZ	P207289	DFLX		J024755	TRUX	250004198	P206405	VANAIR	2520560	M070068	VME
2430273	P207349	STMC	2450060CP	P207300	DFLX	24757	J024757	AP	250007741	M080024	SLAR		M070068	ECLD
									250009843	X004539	SLAR	2520844	P206388	STMC

Mfgs. No.	Our No.	Mfg. Code	Mfgs. No.	Our No.	Mfg. Code	Mfgs. No.	Our No.	Mfg. Code	Mfgs. No.	Our No.	Mfg. Code	Mfgs. No.	Our No.	Mfg. Code
2520845	P206390	STMC	2550018CP	P207309	DFLX	25P30012	P206309	DFLX	2621064	M090091	STGR	2681550	J009624	STMC
2520847	P206389	STMC	2550024	J024747	DFLX	25P30012AZ	P206309	DFLX		M090091	STMC	2681560	J190063	STMC
2520848	P206391	STMC	2550024CP	J024758	DFLX	25P30024	P208330	DFLX	2621065	M100016	STMC	2681830	X007833	STMC
252293	M065034	FRAM	2550048	P207296	DFLX	25P30024AZ	P208330	DFLX	262190	P208366	VANAIR	2681835	X007834	STMC
	M065034	ALSY	2550048AZ	P207296	DFLX	25P30048	P206380	DFLX	2622015	M060038	STMC	2681840	X007824	STMC
252317	P206410	EMSN	2550048CP	P207321	DFLX	25P30048AZ	P206380	DFLX	2622020	M060037	STMC	2681850	X007805	STMC
2527050	M120108	VLVO	2550060CP	P207302	DFLX	25P30048CP	P207312	DFLX	2622025	M065030	STMC	2681925	X007829	STMC
2528407	M090159	ECLD	2550072CP	P216205	DFLX	25P35012	P206310	DFLX	2622030	M070068	STMC	2681927	X004538	STMC
	M090159	VLVO	2550096CP	P209910	DFLX	25P35012AZ	P206310	DFLX	2622035	M070069	STMC	2681930	X007830	STMC
2530012	P206302	DFLX	2550145	P207389	STMC	25P35024	P208338	DFLX	2622040	M080024	STMC	2681935	X007831	STMC
2530012AZ	P206302	DFLX	2550152	P206324	STMC	25P35024AZ	P208338	DFLX	2622050	M090091	STMC	2681940	X007784	STMC
2530036	P208326	DFLX	2550157	P206325	STMC	25P35048	P206381	DFLX	2622060	M100016	STMC	2681950	X007785	STMC
2530036AZ	P208326	DFLX	2550162	P206327	STMC	25P35048AZ	P206381	DFLX	2623030	M070068	STMC	2681960	X009076	STMC
2530048	P207293	DFLX	2550168	P206328	STMC	25P40012	P206311	DFLX	26355A	P207568	HDMI	2682425	X004476	STMC
2530048AZ	P207293	DFLX	255026	P226157	XAIR	25P40018	P208386	DFLX	263574	M065030	FMCO	2682430	X004478	STMC
2530048CP	P207318	DFLX	2550898	P207386	STMC	25P40018AZ	P208386	DFLX		M065030	NH	2682435	X004480	STMC
2530189	P207295	STMC	2550902	P207402	STMC	25P40018CP	P206384	DFLX	264387001	M045193	VMER	2682450	X004484	STMC
2530193	P208350	WLKR	2550903	P206324	STMC	25P40024	J024748	DFLX	265445	M060037	NH	2682460	X004539	STMC
	P208350	STMC	2550929	M120100	CHLR	25P40024CP	J024749	DFLX		M060037	FMCO	2682840	P222748	STMC
2530198	P208366	STMC	255119	X004480	KOHL	25P40036	P208358	DFLX	266223	M080024	NH		X007784	CRMY
253026	P226140	XAIR	25530140	M085078	DMAG	25P40036AZ	P208358	DFLX	26623	M080024	FMCO	2682845	P222749	STMC
2530468	P207296	STMC		M085078	MH	25P40036CP	P208359	DFLX		M080024	VSTL	2682850	P222750	STMC
2530894	P207290	STMC		M085078	KTSU	25P40048	P206382	DFLX	26624	M090091	FMCO	2682940	X004482	STMC
2530976	J024746	STMC	25530240	P206309	KTSU	25P40048AZ	P206382	DFLX		M090091	VSTL	2682950	P222759	STMC
2530977	J024747	STMC	25530340	P206407	KTSU	25P40048CP	P206386	DFLX	2672155	M065065	FMC	2682960	X004539	STMC
2531093	P208350	STMC	2554030	P206326	STMC	25P40060	P208388	DFLX	2672157	M085008	FMC	2683331000	M170101	PRLP
2531311	M120189	VLVO	25558740	M085056	MH	25P40060AZ	P208388	DFLX	2672158	M085023	PRLP	26834	P207282	CRMY
253191	P270536	KOHL		M085056	DMAG	25P40060CP	P208389	DFLX		M085023	FMC	2683520	J000210	STMC
253237	M085090	KOHL		M085056	KTSU	25P40096CP	P209913	DFLX	2672159	M100048	FMC	2683522	J000212	STMC
253265	M085056	KOHL	255651	P207408	FRAM	25P50018	P208392	DFLX	2672160	M090544	PRLP	2683525	J000211	STMC
2534018	P207297	STMC		P207408	ALSY	25P50018AZ	P208392	DFLX	2679303	M090074	FMC	2683527	J000213	WLKR
	P207297	WLKR	2558162	P206322	STMC	25P50018CP	P206385	DFLX		M090074	PRLP	2683530	J000214	WLKR
2535012	P206303	DFLX	2558168	P206323	STMC	25P50024	J024750	DFLX	2680001	X004536	STMC		X004478	STMC
2535036	P208350	DFLX	255LL21	P206328	SPRT	25P50024CP	J024751	DFLX	2680002	X004537	WLKR	2683535	J000215	STMC
2535036AZ	P208350	DFLX	2560002	P206361	STMC	25P50036	P208374	DFLX	2680002	X004537	STMC	2683540	J000216	STMC
2535036CP	P216200	DFLX	2560024AZ	P207559	DFLX	25P50036AZ	P208374	DFLX	2680003	X004476	WLKR	2683545	J000219	STMC
2535048CP	P207319	DFLX	2560036	P216206	DFLX	25P50036CP	P208375	DFLX	2680003	X004476	STMC	2683550	J000217	STMC
2535072	P224709	STMC	2560036AZ	P216206	DFLX	25P50048	P206383	DFLX	2680004	X004538	WLKR	2683560	J000218	STMC
253526	P226154	XAIR	256017C91	M100052	NAVI	25P50048AZ	P206383	DFLX	2680004	X004538	STMC	2683630	J000214	WLKR
25358571	M060037	IR	2560635	P206362	STMC	25P50048CP	P206387	DFLX	2680005	X004478	STMC		J000214	STMC
2536036	P216206	WLKR	2560636	P206363	STMC	25P50060	P208394	DFLX	2680006	X004480	WLKR	2683635	J000215	STMC
	P216206	STMC	2560637	P206364	STMC	25P50060AZ	P208394	DFLX	2680006	X004480	STMC	2683640	J000216	WLKR
253614	M100146	KOHL	2560752	P206365	STMC	25P50060CP	P208395	DFLX	2680007	X004482	WLKR	2683650	J000217	WLKR
253990	P270539	KOHL	2570199	P206617	STMC	25P50072	P224600	DFLX	2680008	X004482	STMC	2683650	J000217	WLKR
2540012	P206304	DFLX	2580994	P206641	STMC	25P50096CP	P209912	DFLX	2680008	X004484	WLKR	2683660	J000217	STMC
2540012CP	J014623	DFLX	2581172	P206334	STMC	25P60024AZ	P207419	DFLX	2680008	X004484	STMC	2683660	J000218	WLKR
2540018	P207297	DFLX	2585714C1	J000216	NAVI	25PLS	J190058	ACFT	2680009	X004539	WLKR	2684040	J000202	WLKR
2540018AZ	P207282	DFLX	2585715C1	J000217	NAVI	25T1520	M080018	PH	2681135	X006204	WLKR		J000202	STMC
2540018CP	P207308	DFLX	2585716C1	J009605	NAVI	260024	P206336	TESSI	2681140	X006203	STMC	2684050	J000203	WLKR
2540024	J024746	DFLX	2585717C1	J009606	NAVI	2602022	P206411	TDYN	2681150	X006202	WLKR		J000203	STMC
2540024CP	J024757	DFLX	2585718C1	J009607	NAVI		P206411	GEDY		X006202	STMC	268590960	X007824	SAME
2540036	P208366	DFLX	2585719C1	J009623	NAVI	26020231	P206555	GEDY	2681430	J009604	STMC	2686840	P222748	STMC
2540036AZ	P208366	DFLX	2585720C1	J009624	NAVI		P206555	TDYN	2681435	J009605	STMC	2690018	M120365	PRLP
2540036CP	J034746	DFLX	2585721C1	J190061	NAVI	26020232	X007785	TDYN	2681440	J009606	STMC	2690019	M170101	PRLP
2540048	P207295	DFLX	2585723C1	M090534	NAVI		X007785	GEDY	2681445	J190054	STMC	2690035	P206394	STMC
2540048AZ	P207295	DFLX	2585724C1	M090535	NAVI	260382	P206279	VANAIR	2681450	J190054	WLKR	2690040	P206395	STMC
2540048CP	P207320	DFLX	2585725C1	M090544	NAVI	260424V11	M045237	FMCO	2681460	J190055	WLKR	2690044	P206396	STMC
2540060	P207290	DFLX	2585726C1	M090680	NAVI		M045237	VSTL		J190055	STMC	2690044	P206396	STMC
2540060AZ	P207290	DFLX	2585727C1	M100465	NAVI	2609013	P206601	VMER	2681520	J190056	STMC	2690044	P206396	STMC
2540060CP	P207301	DFLX	2585728C1	M100695	NAVI	261315	P270539	SLAR	2681520	J190056	WLKR	2690044	P206396	STMC
2540072CP	P216202	DFLX	2585729C1	M110189	NAVI		P270539	VANAIR	2681520	J190056	WLKR	2690044	P206396	STMC
254026	P226155	XAIR	2585735C1	P206410	NAVI	2614907B	M045237	BORG	2681520	J190056	WLKR	2690044	P206396	STMC
25404	P206617	HDMI	2585736C1	P206411	NAVI	2615509	M001867	CAT	2681522	J190057	STMC	2690044	P206396	STMC
2545814	P206283	XAIR	2585737C1	P226158	NAVI	2621058	M060038	STMC	2681525	J190057	WLKR	2690044	P206396	STMC
25458PE	P207354	XAIR	2585746C1	X006202	NAVI	2621059	M060037	STMC	2681525	J190058	WLKR	2690044	P206396	STMC
254621001	J000206	VMER	2585747C1	X006203	NAVI	2621060	M065030	STMC	2681527	J190059	WLKR	2690044	P206396	STMC
25497948	M100213	MACK	2585748C1	X007805	NAVI	2621061	M070068	STMC	2681530	J190059	STMC	2690044	P206396	STMC
2550001	P207394	STMC	25971800	P270534	JCB	2621062	M070068	STGR	2681530	J190060	STMC	2690044	P206396	STMC
2550002	P206321	STMC	25EST	J000211	ACFT	2621062	M070069	STMC	2681535	J190061	STMC	2690044	P206396	STMC
2550003	P207402	STMC	25H0218	M120154	LBX	2621063	M070069	STGR	2681540	J009623	STMC	2690044	P206396	STMC
2550005	J008942	STMC	25P20012	P206306	DFLX		M080024	STGR	2681540	J009623	VSTI	2695850	X007805	STMC
2550018AZ	P207298	DFLX	25P25012	P206308	DFLX		M080024	STMC	2681545	J190062	STMC	26S12	X004480	BABR
												2700608	P270534	DIND
												2700747	P270532	FEDR

Mfgs. No.	Our No.	Mfg. Code	Mfgs. No.	Our No.	Mfg. Code	Mfgs. No.	Our No.	Mfg. Code	Mfgs. No.	Our No.	Mfg. Code	Mfgs. No.	Our No.	Mfg. Code
29430	P206326	HDMI	2994719M1	X004482	HNMGM	2ME395A	M085171	MACK	3014052031	P207341	AST	304067	M085409	BOSS
29430A	P206326	HDMI	29A430	P206321	HDMI	2ME399	M090544	MACK		P207341	ASTEC	304068	P206308	BOSS
29435	P206327	HDMI	29A430A	P206321	HDMI	2ME49301	M090544	MACK	3014052056	M090595	AST	304069	P206309	BOSS
29435A	P206327	HDMI	29A435	P206322	HDMI	2ME49301P11	M100465	MACK		M090595	ASTEC	304070	M002118	BOSS
29500	P206390	WLKR	29A435A	P206322	HDMI	2ME49301P2	M100465	MACK	3014052240	P207354	ASTEC	304071	M002119	BOSS
29501	P206391	WLKR	29A540	P206323	HDMI	2ME49301P3	M100463	MACK		P207354	AST	304254	P207283	TYLE
29502	P208389	WLKR	29A540A	P206323	HDMI	2ME49301P4	M100465	MACK	3014052260	P206283	ASTEC	304605066	P206341	ASTEC
29503	P208395	WLKR	29A650A	P207402	HDMI	2ME49301P5	M100463	MACK		P206283	AST		P206341	AST
29506	P207299	WLKR	29H77	M100048	BABR	2ME49301P6	M090535	MACK	3014052313	P207324	AST	304605097	M085090	AST
29507	P207300	WLKR	29L16	M065071	BABR	2ME49301P7	M100465	MACK		P207324	ASTEC		M085090	ASTEC
29508	P207301	WLKR	2MD236	M120108	MACK	2ME49601P7	M100465	MACK	3014052592	P207335	AST	30495	M070008	KSHA
29509	P207302	WLKR	2MD337AP3	M090280	MACK	2MEX328	M120100	MACK		P207335	ASTEC	305367	P207326	BOSS
29510	P209912	WLKR	2ME153	M080024	MACK				3016051005	M190002	ASTEC	305605056	M085208	ASTEC
29511	J540008	WLKR	2ME229	M090009	MACK					M190002	AST		M085208	AST
29512	P224641	WLKR	2ME235	M170101	MACK				3016377	M120365	CUMS	30600A	P207414	HDMI
29540	P206328	HDMI	2ME236	M120108	MACK				3018051102	M120225	CAT	3061656	M085023	ACMS
29540A	P206328	HDMI	2ME236P1	M100463	MACK					M120225	KIMBLE	3061668	M085023	ACMS
2955550	M085008	CHLR	2ME236P2	M120365	MACK				3018051104	P207328	ASTEC	306245027	M080018	AST
29600	P216202	WLKR	2ME236P3	M120225	MACK					P207328	AST		M080018	ASTEC
29603	P216205	WLKR	2ME247	M090091	MACK				301999	M090362	BOSS	306245029	P206340	AST
29604	P224600	WLKR	2ME248	M100463	MACK				3024020	P226156	XAIR		P206340	ASTEC
29605	J640005	WLKR	2ME251	M085171	MACK				302402018	P206554	XAIR	306245030	P207351	ASTEC
2962280907	M091048	VMER	2ME29301P1	M100465	MACK				302423	P270539	BOSS		P207351	AST
296274651	M091050	VMER	2ME29301P2	M100464	MACK				302423080	P270532	BOSS	306245151	P270539	ASTEC
296277847	M091046	VMER	2ME29301P3	M100465	MACK				302423100	P270534	BOSS		P270539	AST
296277910	X007834	VMER	2ME29301P4	M100465	MACK				302423150	P270530	BOSS	306245207	M100048	AST
296280907	M091048	VMER	2ME29301P7	M100463	MACK				302423175	P270531	BOSS		M100048	ASTEC
296318775	P207361	VMER	2ME29301P8	M100463	MACK				30245265	P207364	ASTEC	306245262	M100572	AST
29650	P207394	HDMI	2ME29301P19	M100463	MACK					P207364	AST		M100572	ASTEC
296505065	J000232	VMER	2ME29301P20	M100463	MACK				302465	J009648	BOSS	306245264	P206546	ASTEC
296505066	P206607	VMER	2ME29301P21	M090072	MACK					P206326	BOSS		P206546	AST
296505067	P206338	VMER	2ME29301P22	M100465	MACK				302478	J190042	BOSS	306245433	P206410	AST
29650A	P207394	HDMI	2ME29301P3	M100464	MACK				3025020	P226158	XAIR		P206410	ASTEC
29701	P224638	WLKR	2ME29301P5	M100464	MACK				302502018	P206555	XAIR	306605183	P206326	ASTEC
29702	P224635	WLKR	2ME29301P6	M090535	MACK				302543	P206378	BOSS		P206326	AST
2974081	M085008	CHLR	2ME29302	M120131	MACK				302698	P206345	BOSS	306942	P207363	CMWK
2975915	M085023	CHLR	2ME3101	M085171	MACK				302984	P206302	BOSS	306945	P207364	CMWK
2976411M91	H001033	HNMGM	2ME3102	M090781	MACK					P206303	BOSS	306945A	P206398	CMWK
2977819M91	H001032	HNMGM	2ME3104	M100580	MACK				30300	P206367	HDMI	307099	P216206	FOREM
2980009147	P206407	CMR	2ME3104P3	M100582	MACK				30300A	P206368	HDMI	3071352M91	H001034	HNMGM
29801	P209910	WLKR	2ME3104P5	M100582	MACK				303145	M080018	BOSS	3073102M91	H001035	HNMGM
2980508392	M085008	RXRDR	2ME3106A	M120566	MACK				303194744	M065030	WHITE	307335	X007833	BOSS
2980518292	P206374	CMI	2ME3112	M120713	MACK				303257001	H001279	VMER	307345	P206544	BOSS
2980518392	M090538	REX	2ME3118	M090823	MACK				3032570011	H001279	VMER	307577	M060481	BOSS
	M090538	CMI	2ME3118A	M090823	MACK				303303	M002117	BOSS	307578	P206515	BOSS
2980518592	M100464	RXRDR	2ME3119	M100213	MACK				303327728	P207282	AGCO	307708	M085411	BOSS
2980518692	M085023	RXRDR	2ME3132M	M101181	MACK				303454	P207339	TYLE	30781	M090781	HDMI
2980519892	M060232	RXRDR	2ME3136M	M090074	MACK				303455	P206375	TYLE	30805333	M090009	TREX
	M060232	MIIN	2ME3339	M090544	MACK				303456	P206547	TYLE	30805L1106	M120365	ASTEC
2980522392	P207330	CMI	2ME335AP2	M090280	MACK					P206547	CASE		M120365	AST
2980526297	P206612	MIIN	2ME336B	M085171	MACK				303457	P207331	TYLE	30805L1107	P207365	ASTEC
2980527892	P270541	CMI	2ME336P2	M120365	MACK				303458	P206337	TYLE		P207365	AST
2980528892	P206280	MIIN	2ME337AP2	M090158	MACK				303459	J000203	CASE	30805L1280	P207339	ASTEC
2980532692	J009606	CMI	2ME337AP3	M090534	MACK					J000203	TYLE		P207339	AST
2980533392	P206603	CMI	2ME361P3	M120382	MACK				303460	J000202	TYLE	30805L1368	P206411	ASTEC
2980535392	J190063	CMI	2ME361P5	M120382	MACK				303461	P206322	TYLE		P206411	ASTEC
2980535892	P207332	CMI	2ME366	M090074	MACK				3012605231	P206603	ASTEC	308486	P206350	FOREM
2980535992	P207596	CMI	2ME371	M100464	MACK					P206603	AST	3093978	P226152	CAT
2980536192	P206318	CMI	2ME372	M090538	MACK				3012605258	P270541	AST	309540	P206553	TYLE
298053692	P206318	CMI	2ME373	M100464	MACK					P270541	ASTEC	309541	P206398	TYLE
29806	P209913	WLKR	2ME374	M090535	MACK				3012605289	P207402	ASTEC	309542	J190014	TYLE
29807	P209912	WLKR	2ME374P1	M090535	MACK					P207402	AST		J190014	CASE
298508392	M085008	REX	2ME374P2	M090535	MACK				3012605321	P206603	AST	309543	P206342	TYLE
298510192	M080018	REX	2ME375	M090544	MACK					P206603	ASTEC	3095893	M101158	VLVO
	M080018	RXRDR	2ME376	M100464	MACK				3012605356	P206603	ASTEC	3095900	M101182	VLVO
298517292	M120100	REX	2ME377	M100043	MACK					P206603	AST	3095906	M101181	VLVO
2987580M91	P270542	HNMGM	2ME378	M100049	MACK				3012605614	P216175	AST	309605013	P206281	ASTEC
29900	P224636	WLKR	2ME384	M090091	MACK					P216175	ASTEC		P206281	AST
2990392	M085056	CAT	2ME38482	M100016	MACK				3014051362	M170101	AST	309605014	P206409	ASTEC
2991610	J009640	STMC	2ME384P2	M100016	MACK					M170101	ASTEC		P206409	AST
2991735	J009632	STMC	2ME384P3	M080024	MACK				3014051363	P207366	AST	309605333	P206323	ASTEC
299456A1	P206600	KBCO	2ME395	M085171	MACK					P207366	ASTEC		P206323	AST
	P206600	CASE							3014051442	P207667	AST	309605337	P208380	ASTEC
										P207667	ASTEC			

Cross Reference

(See the first page of this section for the Manufacturer's Code Listing)



CROSS REFERENCE

Mfgs. No.	Our No.	Mfg. Code	Mfgs. No.	Our No.	Mfg. Code	Mfgs. No.	Our No.	Mfg. Code	Mfgs. No.	Our No.	Mfg. Code	Mfgs. No.	Our No.	Mfg. Code
		P208380.....AST	31112.....	M090009....HDMI		31243.....	M085207....HDMI		31566.....	M120566....HDMI		3227Q16D1....	M090091....CTRY	
309605366.....	P207330.....AST		31119.....	M090544....HDMI		31245.....	M060251....HDMI		31580.....	M100580....HDMI		3227Q3.....	M120235....KOEH	
	P207330...ASTEC		31123.....	M090280....HDMI		31246.....	M065074....HDMI		31582.....	M100582....HDMI			M120235....CTRY	
30AA.....	J000200....ACFT		31125.....	M090159....HDMI		312461780....	P206410....AGCO		31584.....	M085084....HDMI		3227Z25.....	M090530....CTRY	
30EL45101A....	P206280....ACFT		31126.....	M090170....HDMI			P206410...WHITE		31600.....	P207414....DFLX		32305.....	M090301...CRMY	
30EL45200A....	P207351....ACFT		31127.....	M090538....HDMI		31247.....	M085208....HDMI		31600A....	P207408....HDMI		32343.....	P206363....CRMY	
30EL90111A....	P206340....ACFT		31129W.....	M090210....HDMI		31248.....	M090598....HDMI		31680.....	M090680....HDMI		3234765.....	M090544....OKSH	
30EL90112A....	P206341....ACFT		31136.....	M090301....HDMI		31249.....	M100572....HDMI		316977.....	P207282....TYLE			M090544....MNL5	
30EL90211A....	P207326....ACFT		31139.....	M100052....HDMI		31250.....	M120418....HDMI		31805003703..	M001756....SDMO		32350.....	P206373....DFLX	
30EL90212A....	J190013....ACFT		3114112501....	M090594....CMI		31251.....	M060247....HDMI		31805003704..	M001702....SDMO		3235459R1....	M120154....NAVI	
30EL90239A....	P207362....ACFT		3114118101....	P206340....CMI		31252.....	M090594....HDMI		31805003705..	M001502....SDMO			M120154....CUCC	
30EL90240A....	P206397....ACFT		3114118201....	P206326....CMI		31253.....	M090595....HDMI		31805003710..	M001703....SDMO		32381080.....	P207397...ASTEC	
30EST.....	J000214....ACFT		3114118401....	P207330....CMI		312625830....	H001284...WHITE		318141.....	J008681....TYLE			P207397...AST	
30FBC.....	P206608....ACFT		3114118601....	P270539....CMI		312626.....	P206516....TENT		318142.....	J024737....TYLE		324207.....	M065044....KOH	
30FBZ.....	P206600....ACFT		3114119201....	P206540....CMI		312627.....	J008167....TENT		319404.....	P206346....RDRL		32441.....	P206321....AGEM	
30GZ.....	P206407....ACFT		3114119301....	P206511....CMI		31280.....	M090280....HDMI		31A300.....	P206362....HDMI		324601.....	P270541....KOH	
30HD.....	J000227....ACFT		31142.....	M100146....HDMI		31293.....	M085293....HDMI		31A300A....	P206362....HDMI		324937C1....	M090534....NAVI	
30PLA.....	J009604....ACFT		31143.....	M110143....HDMI		312955.....	P206540....TENT		31A350.....	P206363....HDMI		324937C91....	M090280....NAVI	
30PLS.....	J190060....ACFT		311432.....	X004478....CASE		312968.....	P206510....TENT		31A350A....	P206363....HDMI		32500.....	P206375....DFLX	
30RCZ.....	P270536....ACFT		31148.....	M100464....HDMI		312A1016....	P206335....TRUX		31A400.....	P206364....HDMI		3252257M91..	M060037...HNMG	
30STA120.....	P206334....ACFT		31149.....	M100464....HDMI			P206335....AP		31A400A....	P206364....HDMI		32564204391..	M120235....KOEH	
30TS112A....	P206302....ACFT		31150.....	M100213....HDMI		312K1014....	P206335....AP		31A500.....	P206365....HDMI		32564206302..	M120131....KOEH	
30TS212A....	P206309....ACFT		311593170....	M100049...WHITE			P206335....TRUX		31A500A....	P206365....HDMI		3256420V4391	M120235....KOEH	
31001518.....	M120108....BLNT		31163.....	M100807....HDMI		312S1016....	P224685....TRUX		31AS400.....	P206364....HDMI		32600.....	P207408....DFLX	
	M120108....CAT		31164.....	M100466....HDMI		31300.....	P206367....DFLX		31AS400A....	P206364....HDMI		3262770.....	M070008....SNBL	
310017.....	P270838....TESSI		31165.....	M100465....HDMI			P206372....HDMI		31AS500.....	P206365....HDMI		3279482.....	X006202....OKSH	
31002.....	M060232....HDMI		31166.....	M100466....HDMI		31300A....	P206372....HDMI		31AS500A....	P206365....HDMI			X006202....AMFGI	
31002486....	P216172....CAME		311685010....	M070068....AGCO		313015.....	P206540....TENT		31H0104....	M100043....FMC		3270690.....	M140048....PH	
31004.....	M065065....HDMI			M070068...WHITE		3130888....	P206328....VLVO			M100043....LKB		32821.....	X004478....AGEM	
31005070....	M120108....CAME		31173.....	M120135....HDMI		3130889....	P206387....VLVO			M100043....LBX			X004478....WILM	
31015.....	M085023....HDMI		31179.....	M120154....HDMI		3130890....	P206405....VLVO		31L400.....	P206369....DFLX		32822.....	P226144....AGEM	
31018.....	M085008....HDMI		31181.....	M120131....HDMI		3130891....	P206407....VLVO		31L500.....	P206370....DFLX		3282957.....	X006203....CUMS	
31019.....	M085080....HDMI		311816010....	H001279....DETZ		3130892....	P206410....VLVO		31L600.....	P207414....DFLX		3283435.....	P206553....CUMS	
31020.....	M090544....HDMI			H001279...WHITE		3130893....	P206411....VLVO		31S400.....	P206374....HDMI		3283436.....	X004480....CUMS	
31021.....	M090074....HDMI		31183.....	M120135....HDMI		3130894....	P206507....VLVO		31S400A....	P206374....HDMI		32C65.....	P207281....BABR	
31022.....	M090544....HDMI		31189.....	M110189....HDMI		3130895....	P206555....VLVO		31S500.....	P206375....HDMI		32H0511.....	M120197....LKB	
31023.....	M090535....HDMI		311890.....	P206543....TENT		3130896....	J024838....VLVO		31S500A....	P206375....HDMI		32H511.....	M120197....FMC	
31024.....	M090072....HDMI		311891.....	P206508....TENT		3130897....	P206601....VLVO		320014.....	P206606....TESSI		32L300.....	P206372....DFLX	
31025.....	M090146....HDMI		31191.....	M120235....HDMI		3130898....	P206602....VLVO		320015.....	P213191....TESSI		32L350.....	P206373....DFLX	
31026.....	M090158....HDMI		31197.....	M122300....HDMI		3130899....	P206603....VLVO		320037.....	J009614....TESSI		32L400.....	P206374....DFLX	
31028.....	M110028....HDMI		31199.....	M120225....HDMI		3130900....	P206607....VLVO		320110.....	X004476....TESSI		32L500.....	P206375....DFLX	
31031.....	M100048....HDMI		31200.....	M120225....HDMI		3130901....	P206611....VLVO		320111.....	X004538....TESSI		32L600.....	P207408....DFLX	
31032.....	M100049....HDMI		31202.....	M120382....HDMI		3130902....	P207339....VLVO		320112.....	X004478....TESSI		32Z2631.....	P206411....PH	
31034.....	M065034....HDMI		31204.....	M120197....HDMI		3130903....	P208375....VLVO		320114.....	X004482....TESSI			P206411....CTRY	
31035.....	M120365....HDMI		31209.....	M170101....HDMI		3130904....	P208395....VLVO		320115.....	X004484....TESSI		32Z27X52.....	X004484....PH	
31036.....	M120100....HDMI		31211.....	M190002....HDMI		3130905....	P270541....VLVO		320116.....	X004536....TESSI			X004484....CTRY	
31037.....	M120108....HDMI		31211062....	X004484....KOE		3130909....	J000224....DYP		320117.....	X004537....TESSI		3300.....	P207362....XAIR	
31038.....	M080018....HDMI			X004484...CAME		3131441....	P206347....FRTL		320123.....	X004539....TESSI			P207362....HDMI	
31043.....	M100043....HDMI		31211063....	X004539....CAME		3131445....	P206383....VLVO		320287.....	P206342....ARV		330006004....	X004478....FDEN	
31045.....	M100695....HDMI			X004484...BOMA		31350.....	P206368....DFLX		320289.....	P206344....ARV		330007.....	P206410....TESSI	
310484800....	J000204....ATCO		31211063....	X004539....KOE			P206373....HDMI		321007255....	H001278....NH		330027.....	P206611....TESSI	
31063.....	M100463....HDMI			X004539...CAME		31350A....	P206373....HDMI			H001278....CASE		330036.....	P208326....HDMI	
310689.....	M001702....TYLE		31212.....	M085189....HDMI		313592.....	M001668....TYLE		321852150....	H001284....NH		330036A....	P208326....HDMI	
310690.....	P270539....TYLE		31214.....	M090547....HDMI		31367.....	M120367....HDMI			H001284....CASE		3300391R91..	M120189....SEDD	
31074.....	M045237....HDMI		31215.....	M090548....HDMI		313712.....	P207351....TENT			H001284....FIAT		330048.....	P207293....HDMI	
31075.....	M045193....HDMI		31218.....	M120366....HDMI		31400.....	P206374....HDMI			H001284....FIAT		330048A....	P207293....HDMI	
31076.....	M065071....HDMI		31223.....	M085172....HDMI		31400A....	P206374....HDMI		32200.....	P207405....DFLX		330048CP....	P207318....HDMI	
31077.....	M060005....HDMI		31224.....	M100463....HDMI		31407.....	M085407....HDMI		3220009.....	M060038....JLGI		330124.....	P208330....HDMI	
31078.....	M085078....HDMI		312241.....	J009648....TENT		31479.....	M110479....HDMI		3220010.....	M065030....JLGI		330148.....	P206380....HDMI	
31080.....	M060158....HDMI			J009648...GRVE		3150.....	M085189....TRUX		3220033.....	M045237....JLGI		330148CP....	P207312....HDMI	
31081.....	M065044....HDMI		31225.....	M090534....HDMI			M085189....AP		3220035.....	M090158....JLGI		3305.....	P207329....WILM	
31082.....	M060055....HDMI		31226.....	M090563....HDMI		31500.....	P206375....HDMI		3220036.....	M060037....JLGI			P207329....AGEM	
31083.....	M090823....HDMI		31227.....	M090563....HDMI		31500A....	P206375....HDMI		3220039.....	M090210....JLGI		33160445....	P207394....MJPR	
31084.....	M070008....HDMI		31230.....	M110012....HDMI		3150Q.....	M085189....AP		3220049.....	M100048....JLGI		33170013....	P206317....MJPR	
31085.....	M070028....HDMI		31231.....	M110014....HDMI		315120C91....	M100052....NAVI		3220076.....	M045123....JLGI		33170018....	M090535....MJPR	
31086.....	M070050....HDMI		31234.....	M140048....HDMI		31514.....	M090781....HDMI		3220079.....	M085409....JLGI		33170026....	M090823....MJPR	
31096.....	M085171....HDMI		31235.....	M060481....HDMI		3154065R91..	P270531....FUR		322035.....	M090158....JLGI		33170033....	M100048....MJPR	
31102.....	M085090....HDMI		31237.....	M085206....HDMI			P270531...DRSS		3224136....	M100580....OKSH		33170039....	M085409....MJPR	
31104.....	M085056....HDMI		31238.....	M090301....HDMI		3154070R91..	P270535....FUR		32250.....	P206371....DFLX		33170049....	P206540....MJPR	
311061.....	X004484....STGR		31241.....	M060250....HDMI			P270535...DRSS		322622.....	M090594....FOREM		33170050....	P206543....MJPR	
31107.....	M085080....HDMI		31242.....	M065073....HDMI		31558.....	P207352....WLKR		322656.....	P208392....U C				

Mfgs. No.	Our No.	Mfg. Code	Mfgs. No.	Our No.	Mfg. Code	Mfgs. No.	Our No.	Mfg. Code	Mfgs. No.	Our No.	Mfg. Code	Mfgs. No.	Our No.	Mfg. Code
33170099.....	M100043	MJPR	33328.....	P222751	WLKR	340148A.....	P206382	HDMI	34723.....	M060055	ERIC	3501CP.....	P206385	HDMI
33170108.....	M090535	MJPR	333476C91.....	M090072	NAVI	340148CP.....	P206386	HDMI	35036.....	P222018	WLKR	35036.....	P222018	WLKR
33170150.....	P226143	MJPR	3334818.....	P206515	CAT	340160.....	P208388	HDMI	350503.....	X004484	WGNR	350503.....	X004484	WGNR
33170406.....	P206615	MJPR	33400.....	P206297	DFLX	340160A.....	P208388	HDMI	35097.....	X004482	CRMY	35097.....	X004482	CRMY
33170407.....	P206607	MJPR	3350.....	P207363	XAIR	340160CP.....	P208389	HDMI	34724.....	P208374	TRUX	35100015.....	P206511	MJPR
33170408.....	P206400	MJPR	33500.....	P206298	DFLX	340172CP.....	J640005	HDMI	34727.....	P208359	AP	35100016.....	P206509	MJPR
33170409.....	P207354	MJPR	33500109.....	J000228	PERK	340189.....	P206555	SCNA	34728.....	P208375	AP	35100203.....	X004482	MJPR
33170411.....	P207402	MJPR	335024A.....	P224633	HDMI	340190.....	J024838	SCNA	34743.....	J034743	TRUX	35100210.....	X004484	MJPR
33170413.....	P206350	MJPR	335036.....	P208350	HDMI	340196CP.....	P209913	HDMI	34744.....	J034744	TRUX	35100506.....	P206512	MJPR
33170414.....	P270543	MJPR	335036A.....	P208350	HDMI	34028.....	M060232	BRLEE	34746.....	J034746	AP	351012.....	X004480	WGNR
33170419.....	P226150	MJPR	335036CP.....	P216200	HDMI	340283.....	M060158	BRLEE	34747.....	M065065	ERIC	35101203.....	X004539	MJPR
33170424.....	P207394	MJPR	335048CP.....	P207319	HDMI	34074.....	M060158	RSCO	348022.....	M065034	FMC	35100220.....	X004482	MJPR
33170426.....	P206345	MJPR	335124.....	P208338	HDMI	34110.....	M065044	BRLEE	348025.....	M065030	FMC	35100210.....	X004484	MJPR
33170428.....	P206321	MJPR	335124A.....	P208338	HDMI	34112.....	M060037	ERIC	348027.....	M090594	FMC	35100506.....	P206512	MJPR
33170447.....	P206323	MJPR	335148.....	P206381	HDMI	34128.....	M045237	ERIC	34818.....	M065044	WILM	351012.....	X004480	WGNR
33170483.....	P206375	MJPR	335148A.....	P206381	HDMI	34137.....	P222748	WLKR	34825.....	M065044	AGEM	35113530.....	M085023	IR
33170487.....	M080024	MJPR	33576.....	P270538	BRLEE	34137.....	M085056	ERIC	34827.....	J240004	TRUX	35113539.....	M085023	IR
33170508.....	M120235	MJPR	33576.....	P270538	RSCO	34191.....	M060363	CRMY	34828.....	P208350	TRUX	35113646.....	P206407	IR
33200.....	J000220	WLKR	335A.....	P207363	HDMI	34191.....	M060055	ERIC	34828.....	P206380	TRUX	351170.....	X004478	WGNR
33212.....	J000221	WLKR	3377215R1.....	P270538	FURU	34229.....	M060038	ERIC	34830.....	P224581	TRUX	35164.....	P270542	WLKR
33214.....	J000222	WLKR	3377344R1.....	P270536	DRSS	34233.....	M060038	ERIC	34831.....	P224582	TRUX	35194.....	P270539	WLKR
33220.....	X007829	WLKR	338614C1.....	J009613	NAVI	342578.....	M120100	PACC	34853.....	M090158	ERIC	35195.....	P270541	WLKR
33221.....	J190059	WLKR	33958.....	J000211	WLKR	3426003.....	M065030	EIMC	34862.....	M045237	RSCO	352025.....	P207382	DFLX
33222.....	X007830	WLKR	33959.....	J000214	WLKR	3426023.....	M065030	EIMC	34880.....	M090170	ERIC	35225.....	P270530	WLKR
33223.....	J190061	WLKR	33959.....	J000214	WLKR	3426049.....	M100146	LGMF	34892.....	P207389	CRMY	35226.....	P270531	WLKR
33224.....	X007784	WLKR	33960.....	J000215	WLKR	3426403.....	M065030	EIMC	3494639.....	M080018	HSTR	35227.....	J000202	WLKR
33225.....	X007785	WLKR	33961.....	J000216	WLKR	34335.....	P226156	AGEM	34957.....	M065065	CRMY	35228.....	J000203	WLKR
33226.....	X007829	WLKR	33961.....	P206393	CMRPR	34335A.....	P226156	AGEM	3500.....	P207365	XAIR	352530.....	P206313	DFLX
33227.....	J190059	WLKR	33962.....	P206393	LROI	34370.....	M065065	ERIC	35001.....	P207784	TESSI	35290.....	P222018	WLKR
33228.....	P222752	WLKR	33963.....	J000217	WLKR	34453.....	M120154	ERIC	350011.....	P206511	TESSI	35291.....	X006204	WLKR
33231.....	J190057	WLKR	33963.....	J000218	WLKR	3454640.....	P206409	MNTW	350018.....	P207298	HDMI	35292.....	X006203	WLKR
33239.....	M065034	RSCO	33964.....	J000213	WLKR	345481.....	X004539	MNTD	350018A.....	P207298	HDMI	35293.....	X006202	WLKR
33240.....	P222753	WLKR	33964.....	X007833	WLKR	3454810.....	X004539	MNTW	350018CP.....	P207309	HDMI	35293059.....	X004478	IRCR
3324009.....	P270534	CAT	33967.....	X007833	WLKR	345507.....	X004484	MNTD	350024.....	J024747	HDMI	35293059.....	X004478	IR
3324011.....	M065071	CAT	33968.....	X007834	WLKR	3455070.....	X004484	MNTW	350024A.....	J024747	HDMI	35293067.....	X004480	IR
33241.....	P222754	WLKR	33969.....	J009606	WLKR	345512.....	P206337	U C	350024CP.....	J024758	HDMI	35294305.....	X004478	IR
33244.....	P222744	WLKR	33970.....	J009607	WLKR	345525.....	X007339	U C	350036CP.....	P216204	HDMI	35296060.....	X004476	IR
33245.....	P222745	WLKR	33973.....	P207353	CMRPR	3455300.....	X004482	MNTW	350048.....	P207296	HDMI	353035.....	P206314	DFLX
33246.....	P222752	WLKR	33993.....	P206507	TRUX	3455530.....	P206512	GRVE	350048A.....	P207296	HDMI	353035AZ.....	P206314	DFLX
33248.....	P222753	WLKR	3400.....	P207364	XAIR	3455970.....	P206512	MNTW	350048CP.....	P207321	HDMI	35304.....	P206315	DFLX
33249.....	P222754	WLKR	3400.....	P207297	HDMI	34587.....	M085078	ERIC	35006.....	X004480	TMPO	353040.....	P206315	DFLX
33264.....	P222755	WLKR	340005.....	J240004	AP	34589.....	H001032	ERIC	350060CP.....	P207302	HDMI	35304310.....	M090146	IR
33266.....	P222757	WLKR	3400108CP.....	P224636	HDMI	3459884.....	M085023	CHLR	350072A.....	P224709	HDMI	35307131.....	X004482	TKNG
33268.....	P222759	WLKR	340018A.....	P207297	HDMI	34667.....	M065030	CRMY	350072CP.....	P216205	HDMI	35313303.....	X004484	TKNG
33272.....	X007830	WLKR	340023.....	J340023	AP	34673.....	J034673	AP	350084CP.....	P224638	HDMI	35313303.....	X004484	TKNG
33273.....	X007831	WLKR	340024.....	J024746	HDMI	34674.....	J034674	TRUX	350096CP.....	P209910	HDMI	35325.....	P222748	WLKR
33274.....	X007784	WLKR	340024A.....	J024746	HDMI	34679.....	X004476	RSCO	3500A.....	P207298	HDMI	35328871.....	X004536	IR
33275.....	J190062	WLKR	340024CP.....	J024757	HDMI	34682.....	M065034	ERIC	3500A.....	P207298	HDMI	35335.....	J000220	WLKR
33276.....	X007785	WLKR	340036.....	P208366	HDMI	34691.....	M090210	ERIC	350124.....	J024750	HDMI	35336.....	J000222	WLKR
33278.....	P222755	WLKR	340036A.....	P208366	HDMI	34709.....	P206376	AP	350124A.....	J024750	HDMI	35337.....	J000221	WLKR
33279.....	P222756	WLKR	340036CP.....	J034746	HDMI	34713.....	P208324	AP	350124CP.....	J024751	HDMI	3535382.....	P207596	OKSH
33280.....	P222757	WLKR	340048A.....	P207295	HDMI	34714.....	P208324	TRUX	350136.....	P208374	HDMI	35354.....	J000221	WLKR
33281.....	P222758	WLKR	340048CP.....	P207320	HDMI	34715.....	P208348	AP	350136A.....	P208374	HDMI	353540.....	P206316	DFLX
33282.....	P222759	WLKR	340060A.....	P207290	HDMI	34716.....	P208348	TRUX	350136CP.....	P208375	HDMI	353540AZ.....	P206316	DFLX
33285.....	J009605	WLKR	340060CP.....	P207301	HDMI	34717.....	P208364	TRUX	350148.....	P206383	HDMI	35358571.....	M060037	IR
33288.....	X007805	WLKR	340060LA.....	P224710	HDMI	34718.....	P208364	AP	350148A.....	P206383	HDMI	35369120.....	M090009	MNTW
33293.....	X007824	WLKR	340060LCP.....	P224641	HDMI	34719.....	P208380	AP	350148CP.....	P206387	HDMI	35373.....	J000231	WLKR
33294.....	X007805	WLKR	340072CP.....	P216202	HDMI	34719.....	P208380	TRUX	350160.....	P208394	HDMI	35392.....	P271511	WLKR
33300.....	J000227	WLKR	340084CP.....	P224635	HDMI	347170.....	P208326	AP	350160CP.....	P208395	HDMI	35393.....	P270543	WLKR
33304.....	J000230	WLKR	3400A.....	P207297	HDMI	34718.....	M085056	ERIC	350172.....	P224600	HDMI	35401.....	J009612	WLKR
33305.....	J000232	WLKR	3400CP.....	P207308	HDMI	34719.....	P208366	TRUX	350172A.....	P224600	HDMI	354050.....	P206317	DFLX
33310.....	P222746	WLKR	340118.....	P208386	HDMI	34720.....	P208366	AP	350172CP.....	P224600	HDMI	354050AZ.....	P206317	DFLX
33311.....	P222747	WLKR	340118CP.....	P206384	HDMI	34721.....	P216204	TRUX	350196CP.....	P209912	HDMI	35408.....	J000220	WLKR
33312.....	P222748	WLKR	340124.....	J024748	HDMI	34721.....	M070068	ERIC	3501A.....	P208392	HDMI	35409.....	P207667	WLKR
33313.....	P222749	WLKR	340124A.....	J024748	HDMI									
33314.....	P222750	WLKR	340124CP.....	J024749	HDMI									
33315.....	P222751	WLKR	340136.....	P208358	HDMI									
33323.....	P222746	WLKR	340136A.....	P208358	HDMI									
33324.....	P222747	WLKR	340136CP.....	P208359	HDMI									
33325.....	P222748	WLKR	340148.....	P206382	HDMI									
33327.....	P222750	WLKR												

Cross Reference

(See the first page of this section for the Manufacturer's Code Listing)



CROSS REFERENCE

Mfgs. No.	Our No.	Mfg. Code	Mfgs. No.	Our No.	Mfg. Code	Mfgs. No.	Our No.	Mfg. Code	Mfgs. No.	Our No.	Mfg. Code	Mfgs. No.	Our No.	Mfg. Code
35413	J000222	WLKR	35786	P206407	WLKR	35935	P206512	WLKR	3612157	P270541	FIAT	3632066M1	X004484	AGCO
35414	J000221	WLKR	35787	P206409	WLKR	35936	X004480	WLKR		P270541	CASE	36323277	M065044	IR
354170	X004482	WG NR	35788	P206410	WLKR	35937	X004482	WLKR	3612162	M120197	FIAT	3632Q	M090280	AP
	X004482	ATCO	35789	P206411	WLKR	35938	X004484	WLKR		M120197	CASE	3633	M090159	AP
35423	J000219	WLKR	35790	P206511	WLKR	35939	X004539	WLKR	3612171	M100043	CASE	3633Q	M090159	AP
35424	J000231	WLKR	35791	P206512	WLKR	359696A1	M001503	CASE		M100043	FIAT	3634	M090210	AP
35433	P271507	WLKR	35792	P206512	WLKR	35972	P206518	WLKR	3612177	M060251	CASE	3634560	M090544	CHLR
35444	P206608	WLKR	35793	J000224	WLKR	35973	P207345	WLKR		M060251	FIAT	3634620	M120131	CHLR
35445	P206408	WLKR	35794	J000227	WLKR	35974	P207346	WLKR	3612180	M065074	FIAT	3634Q	M090210	AP
35449	P206604	WLKR	35795	J000233	WLKR	35975	J000217	WLKR		M065074	CASE	36352672	M045193	IR
35456	J009486	WLKR	35796	P207784	WLKR	35976	J000216	WLKR	3612182	M120365	FIAT	363540	P206322	DFLX
354562	P270534	DOHL	35797	M090210	IR	35977	J000215	WLKR		M120365	CASE	363540AZ	P206322	DFLX
35457	J009487	WLKR	35799	P206602	WLKR	35978	J000214	WLKR	3614	M120100	AP	3636	M090301	TRUX
354612	M120131	ATCO	35800	P206603	WLKR	35979	J000211	WLKR		M120100	TRUX		M090301	AP
	M120131	WG NR	35804	P206605	WLKR	35980	J000218	WLKR	36145	P206403	WLKR		M090301	GOE
35494	J009613	WLKR	35805	P206606	WLKR	35983	P206519	WLKR	36146	P206404	WLKR	3636Q	M090301	AP
35495	J009611	WLKR	35806	P206607	WLKR	35984	P206521	WLKR	36147	P206406	WLKR	3637	M100146	TRUX
35496	J009613	WLKR	35807	M060038	WLKR	35988	P207308	WLKR	36148	P222744	WLKR		M100146	AP
35497	P207598	WLKR	35829944	M090535	IR	35989	P207309	WLKR	36149	P222745	WLKR		M100146	GOE
35498	J009614	WLKR	35844117	M085056	IR	35997	P206353	WLKR	3614Q	M120100	AP	3637Q	M100146	AP
35499	P210110	WLKR	35852	P206524	WLKR	35AA	J000201	ACFT	3615	M060055	AP	3638397	M090074	CHLR
35500	P213191	WLKR	35853	P206525	WLKR	35EL90114A	P206342	ACFT	3615Q	M060055	AP	363881	M002121	FOREM
3550036CP	P216204	DFLX	35854	P206515	WLKR	35EL90115A	P206343	ACFT	3616	M090170	GOE	3640	M100463	TRUX
355060	P206318	DFLX	35855	P206516	WLKR	35EL90214A	J190014	ACFT		M090170	AP		M100463	GOE
355060AZ	P206318	DFLX	35856	P206517	WLKR	35EL90215A	P207328	ACFT	3616Q	M090170	AP		M100463	AP
35512	P270532	WLKR	3587471	M111026	OKSH	35EL90241A	P206398	ACFT	3617	M045193	AP	364050	P206323	DFLX
35513	P270533	WLKR	35886	P206510	WLKR	35EST	J000215	ACFT		M045193	GOE	364050AZ	P206323	DFLX
35514	P270534	WLKR	35887	P206511	WLKR	35FBC	P206609	ACFT		M045193	TRUX	3640908	M100464	CHLR
35514629	M085084	IR	358921C1	M090280	NAVI	35FBZ	P206601	ACFT	3617Q	M045193	AP	3640Q	M100463	AP
35539238	P270534	IR	35898	J008167	WLKR	35GZ	P206409	ACFT	3618	M070028	AP	3641507	M002122	OKSH
35576271	M085090	IR	35899	P224841	WLKR	35HD	J000228	ACFT		M070028	HDMI	3643	M120176	AP
35584499	M120131	IR	35907	P270539	WLKR	35P2530	J190042	DFLX		M070028	GOE	3643Q	M120176	AP
35595834	M070068	IR	3590812	M100049	HRSN	35P3035	J190044	DFLX	3618Q	M070028	AP	364406	M170101	FOREM
35599834	M070068	IR	3590813	M090535	HRSN	35P3040	J009648	DFLX	3620	M120108	AP	364443	P222751	FOREM
35606	P206523	WLKR	3590814	M100464	HRSN	35P3540	J190045	DFLX	362025	P207397	DFLX	3645	M120235	TRUX
356153C1	M090072	NAVI	3590815	M120131	HRSN	35P4050	J009649	DFLX	3620Q	M120108	AP		M120235	AP
35617	P270535	WLKR	3590816	M090544	HRSN	35P5060	J009650	DFLX	3621	M065071	AP		M120235	GOE
35618	P270536	WLKR	3590823	M090544	HRSN	35PLA	J009605	ACFT		M065071	GOE	3645Q	M120235	AP
35619	P270538	ROSS	3590824	M090534	HRSN	35PLS	J190061	ACFT	3621Q	M065071	AP	3646	M122300	AP
	P270538	WLKR	3590825	M100464	HRSN	35RCZ	P270538	ACFT	3622	M060158	AP	3646Q	M122300	AP
35620	J000210	WLKR	3590826	M090544	HRSN	35STA120	P206335	ACFT	3622Q	M060158	AP	3647	M120108	TRUX
35621	J000212	WLKR	3590827	M085023	HRSN	35TS112A	P206303	ACFT	3624	M065034	TRUX		M120225	AP
35622	J000213	WLKR	3590829	M090538	HRSN	35TS212A	P206310	ACFT		M065034	GOE	3647Q	M120225	AP
35624	P206600	WLKR	3590831	M100043	HRSN	35X30R303A	P206314	ACFT		M065034	AP	3648	M120131	AP
35636	J009618	WLKR	3590834	M100464	HRSN	3600	P207361	NAIR	362455	M140048	FOREM	3648Q	M120131	AP
35660	J009479	WLKR	3590837	M100463	HRSN	360001	P206543	TESSI	362467	P207596	FOREM	3649	M170101	AP
35673022	M060005	JAGR	3590838	M120176	HRSN	360014	P206508	TESSI	3624Q	M065034	AP	3649Q	M170101	AP
35673580	M070008	JAGR	3590841	M090091	HRSN	360015	P206509	TESSI	3625	M085171	GOE	3650	M190002	AP
35673585	M070050	JAGR	3590842	M100465	HRSN	3610	M090563	TRUX		M085171	AP	365060	P207402	DFLX
356808	P208388	FOREM	3590844	M100464	HRSN		M090563	GOE	362530	P206319	DFLX	365060AZ	P207402	DFLX
35690	J009612	WLKR	3590845	M100464	HRSN		M090563	AP	3625Q	M085171	AP	3650Q	M190002	AP
35692	P207598	WLKR	3590846	M120197	HRSN	3610Q	M090563	AP	3626	M085084	TRUX	3653	M085421	TRUX
35693	P207596	WLKR	3590850	M090072	HRSN	3611	M090520	GOE		M085090	AP	3654	M065065	AP
35694	P206609	WLKR	3590853	M120365	HRSN		M090520	AP		M085090	GOE		M065065	AP
35696	P206601	WLKR	3590855	M120108	HRSN		M090520	TRUX		M085090	TRUX		M065065	TRUX
35733	P206520	WLKR	3590856	M100463	HRSN	3611Q	M090520	AP		M085090	AP	3654Q	M065065	AP
35734	P206526	WLKR	3590861	M100146	HRSN	3612111	M090158	CASE	3626Q	M085090	AP	3655	M085023	TRUX
35746	P210110	WLKR	3590863	M100463	HRSN		M090158	FIAT	3627	M085056	AP	3662	M085008	AP
35749	J000232	WLKR	3590868	M100463	HME	3612123	M065044	CASE		M085056	GOE		M085008	AP
35752	J000230	WLKR		M100463	HRSN		M065044	FIAT		M085056	TRUX		M085008	AP
35753	J000228	WLKR	359087	M120154	HRSN	3612125	M120100	FIAT	3627Q	M085056	AP		M085008	GOE
35757	J000232	WLKR	359089	M090544	HRSN		M120100	CASE	3629	M085078	AP		M085008	TRUX
35758	J000231	WLKR	35909	P270540	WLKR	3612127	P270538	FIAT	3629Q	M085023	AP	3662Q	M085008	AP
35760	P206408	WLKR	35910	P270541	WLKR		P270538	CASE	36300100	P206518	MJPR	366303C1	M090146	NAVI
357686A1	X009076	CASE	35924	X004536	WLKR	3612136	P270533	CASE		P206518	DFLX	3664	M090544	AP
35772	J000227	WLKR	35926	X004537	WLKR		P270533	FIAT	363035AZ	P206320	DFLX	3665	M100464	AP
35773	J000228	WLKR	35927	X004476	WLKR	3612138	P270539	FIAT	363040	P206321	DFLX	3666	M090544	TRUX
35774	J000230	WLKR	35930	X004538	WLKR	3612145	P270543	FIAT	363040AZ	P206321	DFLX		M090544	AP
35775	J000232	WLKR	35931	P270837	WLKR		P270543	CASE	36319	H001284	CRMY		M090544	GOE
35776	P206610	WLKR	35932	P270838	WLKR	3612151	M070068	CASE	3632	M090280	AP	3666Q	M090544	AP
35777	P206611	WLKR	35933	P206512	WLKR		M070068	FIAT		M090280	TRUX	3667	M090535	AP
35778	P206616	WLKR	35934	X004478	WLKR	3612153	P270532	FIAT		M090280	GOE		M090535	GOE
							P270532	CASE						

Mfgs. No.	Our No.	Mfg. Code	Mfgs. No.	Our No.	Mfg. Code	Mfgs. No.	Our No.	Mfg. Code	Mfgs. No.	Our No.	Mfg. Code	Mfgs. No.	Our No.	Mfg. Code
	M090535	APE	3686Q	M060005	AP		X004539	WGNR	3780187M1	M001756	AGCO	3912	M120448	TRUX
	M090535	TRUX	3687	M080018	GOE	3708	M110189	AP	3781125M1	X004962	AGCO	3912069	M085023	TIPP
3667Q	M090535	AP		M080018	AP	3710	M090534	GOE	3784627	M120365	CHLR	391210084	H001284	CASE
3668	M090538	GOE		M080018	TRUX		M090534	AP	38017	P206281	BRLEE		H001284	NH
	M090538	TRUX	36876076	M090091	IR		M090280	TRUX		P206281	RSCO		H001284	FIAT
	M090538	AP	3687Q	M080018	AP	3711	M110012	AP	3820392	M100464	CHLR	3913	M122300	TRUX
3668Q	M090538	AP	3688	M085080	AP		M110012	GOE	38228126	M090535	CHLR	391343	P206281	RSCO
3669	M100048	AP	3688Q	M085080	AP		M110012	TRUX	3828126	M090535	CHLR		P206281	BRLEE
	M100048	GOE	3689	M090158	TRUX	3712	M090781	AP	38303111110	M120100	FURU	3915	M090547	TRUX
	M100048	APE		M090158	AP		M090781	GOE		M120100	DRSS	3918	M100052	TRUX
3669Q	M100048	AP		M090158	GOE		M090781	TRUX	38303111140	P206521	FURU	3919708	X006202	VLVO
3670	M100049	AP	3689Q	M090158	AP	3712Q	M090781	AP		P206521	DRSS	3921	M120367	TRUX
	M100049	GOE	3690	M060037	AP	3713	M110189	TRUX	38359	H001032	CRMY		M120367	AP
3670Q	M100049	AP		M060037	GOE	3714	M100466	AP	384001	P205979	DFLX		M120367	GOE
3671	M100464	AP		M060037	TRUX		M100466	GOE	38401	P205976	DFLX	3923	M110014	TRUX
3672170	M001503	OKSH		M060037	APE		M100466	TRUX	3840235	P222751	OKSH	3925	M065044	TRUX
3672170DX1	M001503	OKSH	3690Q	M060037	AP	3714Q	M100466	AP	384786	M065034	HSTR		M065044	GOE
3673	M100464	AP	3691	M065030	APE	3715	M100695	TRUX	385001	P206299	DFLX		M065044	AP
3674	M120154	AP		M065030	GOE		M100695	GOE	38501	P206300	DFLX	3927	M110479	AP
3674Q	M120154	AP		M065030	AP		M100695	AP	3850424	M065065	GM		M110479	GOE
3675	M120197	GOE		M065030	TRUX	3715Q	M100695	AP	38603111110	M100146	JURA		M110479	TRUX
	M120197	AP	3691Q	M065030	AP	3716	M090680	GOE	38611	J038611	AP	3931	M120566	GOE
	M120197	APE	3692	M070068	GOE		M090520	TRUX		J038611	TRUX		M120566	TRUX
	M120197	TRUX		M070068	AP		M090520	AP	38612	J038612	TRUX		M120566	AP
36752707	M065074	VLVO		M070068	TRUX	3718	M120566	AP		J038612	AP	3933	M120235	TRUX
3675Q	M120197	AP		M070068	APE	3719	M085267	TRUX	38669	X004482	EIMC	3937	M100572	AP
3676	M120365	GOE	3692Q	M070068	AP		M085267	AP	3872	M090544	AP		M100572	GOE
	M120225	TRUX	3693	M070069	APE		M085267	GOE	3873	M100807	AP		M100572	TRUX
	M120365	AP		M070069	TRUX	3719Q	M085267	AP		M100807	TRUX	393997	M100043	HSTR
	M120365	APE		M070069	GOE	3722	M100582	AP		M100807	GOE	39401	P205979	DFLX
3676064	X004478	CLRK	3693Q	M070069	AP		M100582	TRUX	38737	J009618	CMI	3941	M120418	TRUX
	X004478	ECLD	3694	M080024	TRUX	37224213	M090535	MJPR		J009618	BRLEE		M120418	GOE
	X004478	CLJL		M080024	APE	37225562	X005207	MJPR		J009618	RSCO	3945417	M085267	VLVO
3676Q	M120365	AP		M080024	AP	37229139	P206328	MJPR	38772	M065030	RSCO	394639	M080018	HSTR
3677	M100052	GOE		M080024	AP	3722918	X007805	OKSH		M065030	BRLEE	3948159	P206311	VLVO
	M100052	AP	3694918	H001034	OKSH		X007805	MNLS		M060038	RSCO	3948308	P208394	VLVO
	M100052	TRUX	3694Q	M080024	AP	3723	M100580	AP	3878	M060247	GOE	3948309	P207298	VLVO
3677450	P206411	CLRK	3695	M090091	GOE	3725	M085172	TRUX		M060247	TRUX	3948357	P206554	VLVO
3677Q	M100052	AP		M090091	APE	372852	M085172	GOE		M060247	AP	39501	P206299	DFLX
3678	M120382	TRUX		M090091	TRUX		P207389	DFLX	3879	M060005	AP	395333	M065030	HSTR
	M120382	AP		M090091	AP		X004536	ATCO		M060005	GOE	39617	M090170	RDRL
3678Q	M120382	AP		M090091	TRUX		X004536	WGNR		M060005	TRUX	3981941	M065065	GM
3679	M090146	TRUX	3695Q	M090091	AP	3729	M090547	AP	3880	M065138	TRUX	3981948	M060232	GM
	M090146	GOE	3696	M100016	APE	3729Q	M090547	AP	3884	M080018	GOE	3983244	M060251	BLDY
	M090146	AP		M100016	AP	373025	P206324	DFLX		M080018	AP	3B7914	M065030	RYGO
36790	M085090	RSCO	3697	M085172	TRUX	3731	M090781	AP	3888	M090594	AP		M065030	CAT
	M085090	BRLEE		M085172	GOE	3731Q	M090781	AP		M090594	TRUX	3B7942	M070068	CAT
36799807	X004539	IR		M085172	AP	373530	P206325	DFLX		M090594	GOE	3B7964	M080024	CAT
3679Q	M090146	AP	3697Q	M085172	AP	373530AZ	P206325	DFLX	3890	M090781	AP	3EB01F2740	P207411	KTSU
3680	M060232	AP	3698	M120366	TRUX	374030	P206326	DFLX		M090781	TRUX	3HS880	M085090	OKSH
	M060232	APE		M120366	AP	374030AZ	P206326	DFLX	38903111110	M120176	FURU	3K3124	M080018	CAT
3680Q	M060232	AP		M120366	GOE	374035AZ	P206327	DFLX	3891	M090074	GOE		M080018	TIM
3681	M090362	TRUX	3698Q	M120366	AP	374540	J190041	DFLX		M090074	AP		M080018	TESSI
	M090362	GOE	3699	M100465	TRUX	375040	P206328	DFLX		M090544	TRUX	3PS4174	M085008	CHLN
3681Q	M090362	AP		M100465	AP	375040AZ	P206328	DFLX	3892	M085421	TRUX	3R0682	M085023	CAT
3682	M090072	AP	3699M	M100465	TRUX	375447	J190014	DYPC	3893	M100695	TRUX	3T4894	P207414	CAT
	M090072	TRUX		M100465	AP	375448	P207362	DYPC	3895	M090595	GOE			
	M090072	GOE	36A2273	M090535	LKBT	375450	P226140	DYPC		M090595	TRUX			
3682Q	M090072	AP	3700	M110012	AP	375493	P206342	DYPC		M090595	AP			
3683	M070008	GOE		M110189	TRUX	375496	P206320	DYPC	3897	M090535	AP	400005007	M065044	HERC
	M070008	AP		M110189	GOE	375499	P206340	DYPC		M090535	TRUX	40008	P226129	WLKR
	M070008	TRUX	37006	M070008	KTSU	375501	X004478	DYPC		M090074	TRUX	40009	M045237	SLAR
	M070069	GOE		M070008	DRSS	375503	M090158	DYPC		M090535	GOE		P226129	WLKR
3683Q	M070008	AP	3700Q	M110189	AP	375553	M090158	DYPC	3898	M120154	TRUX	40010	P226154	WLKR
3684	M090009	TRUX		M100213	TRUX	376050	P207394	DFLX		M120154	AP	40011	P226155	WLKR
	M090009	AP	3702	M100213	AP	376304	P226140	DYPC		M120154	GOE	40012	P226157	WLKR
	M090009	GOE		M100213	AP	3764910140	P206521	FRTL	38A1007	M100464	FMC	4001225	M060055	ARRO
3684Q	M090009	AP	3702321	P224479	OKSH	3764920640	X007785	FRTL	3900	M120131	AP	4001319500	M120418	CMI
3685	M070050	AP	3703	M090548	AP	3764921940	X007830	FRTL		M120131	GOE	4001905	M060037	ARRO
	M070050	TRUX		M090548	TRUX	37700X	M065044	LULL		M120131	TRUX	40020	P226132	WLKR
3685Q	M070050	AP	3703Q	M090548	AP	3774734	P222750	OKSH	3910420A	P206410	TIPP	40021	P226133	WLKR
3686	M060005	AP	3704	M090547	AP	3774737	P222750	OKSH	3910469	X007830	TIPP	40022	P226156	WLKR
36865285	M070069	IR		M090547	GOE	3779771	H001034	OKSH	3911	M100043	TRUX	40023	P226158	WLKR
			3704Q	M090547	AP	37799X	M065073	LULL				40024	P226154	WLKR
			370571	X004539	ATCO									

Cross Reference

(See the first page of this section for the Manufacturer's Code Listing)



CROSS REFERENCE

Mfgs. No.	Our No.	Mfg. Code	Mfgs. No.	Our No.	Mfg. Code	Mfgs. No.	Our No.	Mfg. Code	Mfgs. No.	Our No.	Mfg. Code	Mfgs. No.	Our No.	Mfg. Code
40025	P226155	WLKR	402966	H001284	OXBOI	4088683	M120225	VME	41189	P206279	WLKR	41536	P207362	WLKR
40026	P226157	WLKR		H001284	OXBO	409186012	P206526	FMNT	41204	P206395	WLKR	41537	P207363	WLKR
4002735000	H001034	CMI	403001S	J009612	DFLX	409300	P271507	XAIR	41205	P206617	WLKR	41538	P207365	WLKR
4002746000	P207667	CMI	40300G	P226155	ACFT	409400	P270837	XAIR	412052AA	P206311	SKYJ	41539	P206299	WLKR
4002768000	M120131	CMI	40300S	P206604	DFLX	4094239160	P206607	CMI	412053AA	P206326	SKYJ	41540	P206300	WLKR
4002827000	M100463	CMI		P226156	ACFT	409500	P270838	XAIR	41217	P206396	WLKR	41557	P207408	WLKR
4002833000	P270535	CMI	4030S	J024836	ACFT	409812	H001279	SLAR	41221	P206397	WLKR	41558	P207333	WLKR
4002935000	M065044	CMI	403100001	M060158	HERC	409828C1	M090544	NAVI	41222	P206398	WLKR	41560	P207366	WLKR
4002958000	P270538	CMI	403100953	X004478	HERC	40AA	J000202	ACFT	41223	P206399	WLKR	41563	P206321	WLKR
4002975000	M090301	CMI	403503S	P222017	DFLX	40CN104	P206369	PACC	41224	P206400	WLKR	41582	P207339	WLKR
400298000	M085090	CMI	403505S	P206605	DFLX	40CN104A5A	P206328	ACFT	41233	P206927	WLKR	41583	P207361	HDMI
4002980000	M085090	CMI	40350S	P206605	DFLX	40CN304	P206374	PACC	4124051	M100463	LETO		P207361	WLKR
4003	M090009	KSHA	40364	P206298	WLKR	40CS224A	J024748	ACFT	41249026	X007831	DAEW	41583Q	P207361	HDMI
4003012000	M122300	CMI	404002S	P222018	DFLX	40CS224C	J024749	ACFT	41251	P206344	WLKR		P207361	WLKR
4003031000	M085023	CMI	404005	P206606	DFLX	40CS236A	P208358	ACFT	41252	P206342	WLKR	416001355910	P206600	IRKA
4003036000	M100213	CMI	40400S	P206606	DFLX	40CS236C	P208359	ACFT	41256	P207364	WLKR	416001401902	X004484	NABI
4003064000	M120225	CMI	4041463	X004539	ECLD	40CS248A	P206382	ACFT	413001S	J009612	DFLX		X004484	IRKA
4003064111	M120225	CMI		X004539	VLVO	40CS248C	P206386	ACFT	41300S	P206604	DFLX	416001401907	P206603	IRKA
400A1014	P206336	TRUX		X004539	VME	40CS260A	P208388	ACFT	413162	M085056	CMI		P206603	NABI
	P206336	AP	4043701	X004482	ECLD		P208338	PACC	413174	M085207	CMI	416001401925	P206375	IRKA
400A1016	P206336	AP		X004482	VME	40CS260C	P208389	ACFT	413195	M120418	CMI	416001530914	P206337	IRKA
	P206336	TRUX	404380001	J190055	VMER	40EL45104A	J190023	ACFT	413196	P208374	CMI	416021401905	M120108	NABI
400A1414	P206336	AP	40438001	J190055	VMER	40EL45203A	P207353	ACFT	413216	P206328	CMI		M120108	IRKA
	P206336	TRUX	4044382	M085410	TYLR	40EL90116A	P206344	ACFT	413224	M085090	CMI	416021401909	P206410	IRKA
400C1016	P206336	TRUX	40447	P206409	HAWK	40EL90117A	P206345	ACFT	413225	M090301	CMI	416061530906	P206602	NABI
	P206336	AP	40448	P206388	XAIR	40EL90117C	P206353	ACFT	413253	X007785	CMI	41612	P207354	WLKR
400S1016	P224686	TRUX	4044942	P207566	TYLR	40EL90217A	P207329	ACFT		X007785	CMCO	41614	J009635	WLKR
40100G	P226142	ACFT	404508R1	M070068	CASE	40EL90219A	P206346	ACFT	413287	M170101	CMI	41615	J009636	WLKR
40100S	P226146	ACFT		M070068	FURU	40EL90242A	P207364	ACFT	413309	P206304	CMI	41616	J009637	WLKR
401116	X007829	SKYJ		M070068	DRSS	40EL90243A	P206399	ACFT	413311	M090594	CMI	41618	J009631	WLKR
401117	X007830	SKYJ		M070068	NAVI	40EST	J000216	ACFT	41338S	J009611	DFLX	41619	J009632	WLKR
401132	X007784	SKYJ	404595003	X004478	FMNT	40FBC	P206610	ACFT	41365	P206340	WLKR	41620	J018110	WLKR
4011460	P207299	XAIR	40460	P206390	XAIR	40FBZ	P206602	ACFT	41366	P206342	WLKR	41623	J009644	WLKR
4011548	P207317	XAIR	4047421	X004484	VLVO	40GZ	P206410	ACFT	41367	P206344	WLKR	41624	J009645	WLKR
4011560	P207300	XAIR		X004484	ECLD	40HD	J000230	ACFT	413678A1	M001865	TYLE	41626	J009639	WLKR
4012448	P207320	XAIR		X004484	VME	40PLA	J009606	ACFT		M001865	CASE	41627	J009640	WLKR
4012518	P207309	XAIR	404812100	M120108	LETO	40PLS	J009623	ACFT	41378	P206344	WLKR	41628	J009641	WLKR
4012548	P207321	XAIR		M120108	MARA	40RCC	P270837	ACFT	41400S	J009614	DFLX	41629	P207331	WLKR
4012560	P207302	XAIR		M080018	LETO	40RCZ	P270539	ACFT	4141106	X004482	LETO	41630	J008681	WLKR
4012596	P209912	XAIR	405	P206849	HDMI	40STA120	P206336	ACFT	41428	P207351	WLKR	41631	P207322	WLKR
4012S	J240006	ACFT	4050	M100465	PHOE	40TA	P206297	ACFT	41429	P207352	WLKR	41633	P206342	WLKR
401400	P207345	XAIR		M100580	INDIP	40TS118A	P207297	ACFT	41430	P207353	WLKR	41634	J008681	WLKR
401512	P207346	XAIR		M100465	INDIP	40TS118C	P207308	ACFT	41431	P207354	WLKR	41635	P206344	WLKR
401518	P206354	XAIR	40500	M100580	INDIP	40TS124A	J024746	ACFT	41432	P207324	WLKR	41636	P207362	WLKR
401666	M045237	FMC	40500S	P206607	DFLX	40TS128A	P208386	ACFT	41433	P207325	WLKR	41638	P206346	WLKR
401716	M080018	SKYJ	405094	M170101	SLAR	40TS218C	P206384	ACFT	41434	P207326	WLKR	41641	P207351	WLKR
4017418	P206384	XAIR	405097	M090535	SLAR	40X30R104A	P206321	ACFT	41435	P207327	WLKR	41645	P206612	WLKR
4017436	P208359	XAIR	4050UMB	P207784	ACFT	40X30R304A	P206315	ACFT	41436	P207332	WLKR	41646	P207619	WLKR
4017448	P206386	XAIR	4054049	X004480	VME	40X35R104A	P206322	ACFT	41437	P206279	WLKR	41647	P207581	WLKR
4017518	P206385	XAIR	40548	P206389	XAIR	40X35R305A	P206316	ACFT	41438	P207349	WLKR	41648	J009391	WLKR
4017536	P208375	XAIR	4055	P207368	HDMI	40X35R404A	P206327	ACFT	41439	P207350	WLKR	41649	P207568	WLKR
4017548	P206387	XAIR	40560	P206391	XAIR	40YTUBE	J092679	ACFT	41440	P207350	WLKR	4165	P206850	INDIP
4017560	P208395	XAIR	4058502	X004484	VME	41001	J008671	WLKR	41441	P207335	WLKR	41650	P207620	WLKR
4018G	J024754	ACFT	406	P206850	HDMI	41002	P206339	WLKR	41442	P216172	WLKR	41652	P207620	WLKR
4018S	P206554	ACFT	406240	P206610	XAIR	41003	P206340	WLKR	41450S	P210110	DFLX	41653	P207567	WLKR
402445	P206285	XAIR	406250	P206611	XAIR		P206340	ROSS	414714	M085090	MOB	41654	J009393	WLKR
40247	P206297	WLKR	406303	M065074	MOB	41004	P206342	WLKR		M085090	WLDN	41655	P207566	WLKR
4024G	J024835	ACFT	4068782	M090146	LETO	41005	P206344	WLKR	41472	P206344	WLKR	41657	P207568	WLKR
4024S	J024850	ACFT	407	P206851	HDMI	41013	P206306	WLKR	41473	P206346	WLKR	41658	P207566	WLKR
402545	P206286	XAIR	4071524	X004484	LETO	4101398	P207363	HDMC	41474	P207364	WLKR	41662	J009479	WLKR
40256	J092679	WLKR	4073731	H001034	LETO	4102049	M190002	LETO	41475	P207353	WLKR	41663	P207581	WLKR
40257	J092689	WLKR	4073737	M100464	MJPR		M190002	MARA	414755	X004478	WLDN	41685	P207362	WLKR
402592003	X004478	FMNT		M100464	MARA	410354	M120235	SLAR		X004478	MOB	41687	P207386	WLKR
402592004	X004480	FMNT	407573001	M060055	FMNT	4103898	M100463	MARA	41476	P207354	WLKR	41691	J240006	WLKR
402595001	X004536	FMNT		M060055	DCOA	41058	P206306	WLKR	41477	J190025	WLKR	41692	P224479	WLKR
402595002	X004476	FMNT	408	P207369	HDMI	410650	M065065	CRMY	41479	P205979	WLKR	41693	J240007	WLKR
402595005	X004482	FMNT	4080072	M120365	VME	4108511A	M085078	ALMN	41480	P205976	WLKR	41694	P224481	WLKR
402595006	X004484	FMNT	40801	M090009	DACR	41094	P206308	WLKR	41514	P207394	WLKR	4170	M085411	NH
402595007	X004539	FMNT	4081853	P207359	LETO	41095	P206309	WLKR	41515	J009650	WLKR		X004482	INDIP
402744	M101169	OXBOI	4081866	X004539	LETO	41096	P206310	WLKR	41532	P207339	WLKR	4171	P207368	INDIP
	M101169	OXBO	4082047	X004478	CBM	41097	P206311	WLKR	41534	P206341	WLKR	4173	P206312	INDIP
40282	M070028	SLAR	4085865	M080024	MARA	41099	P216172	WLKR	41535	P206341	WLKR	41730	P206312	INDIP
				M080024	LETO	41154	J008671	WLKR						

Mfgs. No.	Our No.	Mfg. Code	Mfgs. No.	Our No.	Mfg. Code	Mfgs. No.	Our No.	Mfg. Code	Mfgs. No.	Our No.	Mfg. Code	Mfgs. No.	Our No.	Mfg. Code
41751	M060005	SLAR	41992	P206365	WLKR	420V1373	M085023	KOEH	4243	P222018	INDIP	429619C1	M090146	NAVI
41768	P224669	WLKR	41993	P206370	WLKR	420V3912	X004482	KOEH	42445	P206341	SLAR	42977	P206342	CMJ
41769	J190003	WLKR	41994	P206328	WLKR		X004482	TREX		P206341	WLKR	42978	J028528	WLKR
418195A1	M001756	CASE	41995	P206317	WLKR	420V4349	M120100	KOEH	42447	P206304	WLKR	42E4036	P207582	DFLX
4182268	M090159	FMC	41996	P206375	WLKR	420V4351	M085023	KOEH	42448	P206302	WLKR	42F400	P206616	DFLX
41832	P206400	WLKR	41997	P207402	WLKR	420V4360	M100049	KOEH	42449	P206303	WLKR	42P350	J009391	DFLX
4185027	M190002	LETO	41998	P206318	WLKR	420V4375	M100464	KOEH	424504	P206346	RDRL	42P400	P206614	DFLX
41862	P207568	WLKR	41999	P206324	WLKR	420V4376	M100464	KOEH	42451	P206280	WLKR	42P500	P206615	DFLX
4186214A	P226148	ALMN	41A300466A1	P207667	GE	420V4382	M090170	KOEH	42452	P206281	WLKR	42P50045	J009393	DFLX
41865	P206605	WLKR	41A300466ABP1	P207667	GE	420V4383	M100043	KOEH	42453	P206283	WLKR	42R0210060YF	P206406	HNMG
41889	M100048	GEHL		P207667	GEPA		M100043	TREX	42455	P206553	WLKR	42R300	J009393	DFLX
	P207414	WLKR	41A300466P1	P206411	GE	420V4386	M100464	KOEH	424760	P206519	INDIP	42R350	P207581	DFLX
41890	J009648	WLKR		P206411	PRTCTR	420V4387	M090158	KOEH	424857C1	M090544	NAVI	42R35045	P207568	DFLX
41891	J009649	WLKR		P206411	GEPA	420V4388	M090535	KOEH	424858C1	M090544	NAVI	42R400	P207620	DFLX
41892	P206372	WLKR	41A300470P1	M120108	AUTM	420V4390	M090538	KOEH	42492	P206552	WLKR	42R40045	P207567	DFLX
41893	P206373	WLKR		M120108	AMTK	420V4391	M120235	KOEH	42500	P207329	WLKR	42R50045	P207566	DFLX
41895	P206374	WLKR		M120108	ATHM	420V4393	M120154	KOEH	42500C	P206615	DFLX	42T400	P206617	DFLX
41896	P206369	WLKR		M120108	GE		M120154	TREX	425137C91	M090074	NAVI	43012	M122300	CMJ
41897	P206370	WLKR	41A300754P1	P207394	GEPA	420V6300	M170101	KOEH	42515	P206347	XAIR		M122300	POWER
41898	P206317	WLKR	41A301438P1	P270541	GEPA	420V6302	M120131	TREX	42518	P206348	XAIR	4302	P207362	XAIR
41899	P206375	WLKR		P270541	GE	420V6308	M100463	KOEH	42530	J024739	WLKR	43020	P270543	CMJ
41902	P207411	WLKR		P270541	ATHM	42104	M001668	KW	42531	J024737	WLKR	43030	M090158	RDRL
41909	P206323	WLKR	41A312661P1	X004484	GE		M001668	PACC	42534	P206308	WLKR	4303076	M120365	TYLR
41939003	J240005	DAEW		X004484	GEPA	42125	P207332	WLKR	42536	P207415	WLKR	43036	M100213	CMJ
4194	P206411	INDIP	41B590490P1	M170101	GE	42126	P207283	WLKR	42543	J024750	WLKR	43064	M120225	CMJ
41940	P207405	WLKR		M170101	ATHM	42127	P207281	WLKR	42544	J024748	WLKR	43064111	M120225	CMJ
41944	P207411	WLKR	420039	M090535	PIE	42128	P207559	WLKR	425507C1	M090544	NAVI	4310560	P208393	XAIR
41947	P207411	WLKR	420225	M120100	PIE	42129	P208386	WLKR	42562	P216175	WLKR	4311460	P207288	XAIR
4194907045	P270536	FRTL	420256	M120225	PIE	42130	P208392	WLKR	42570007	P270539	AGCA	4311560	P207289	XAIR
4194927029	M070068	FRTL	4203267	M070008	KOEH	42132	P208338	WLKR	425937C1	M090074	NAVI	43115U	M060038	NLSN
	M070068	MERS	4203914	X004484	KOEH	4214	P208649	INDIP	42594	P207419	WLKR	4312448	P207295	XAIR
419499	M065071	WLDN		X004484	TREX	421436	P270534	CLJL	426428C91	M090538	NAVI	4312460	P207290	XAIR
	M065071	MOB	4204307	M090009	KOEH		P270534	CLRK	42715	P207297	WLKR	431256C1	M100464	NAVI
41957	P206371	WLKR	4204310	M120100	KOEH	42147	P207332	WLKR	42716	P207298	WLKR	431517R91	M090544	NAVI
41958	P207382	WLKR	4204349	M120100	KOEH	4215972M91	H001279	HNMG	427170	M090009	CLRK	43171003	M140048	MJPR
41959	P207397	WLKR	4204351	M085023	KOEH	4215997	M100580	LETO	42728	M090280	CMJ	4317560	P208394	XAIR
41960	P207389	WLKR	4204360	M100049	KOEH	42175	P206544	WLKR	42735	H001034	CMJ	4317572	P224600	XAIR
4196234	P207341	LETO	4204373	M085023	KOEH	42178	P216191	WLKR	42746	P207667	POWER	431792C1	M100464	NAVI
4196273	M120154	ABPS	4204375	M100464	KOEH	4218	M090781	AP		P207667	CMJ	43202	J034673	WLKR
41963	J008942	WLKR	4204376	M100464	KOEH	42185	P206343	WIX	427470	P207530	PIE	43203	J034673	WLKR
41964	P206361	WLKR	4204378	M090538	KOEH		P206343	WLKR	42748	P206350	CMJ	4324836	X004476	BLDY
41966	P206366	WLKR	4204388	M090535	KOEH	422032	M100049	CRMY	42755	H001034	CMJ	4324844	X004538	BLDY
41968	P206324	WLKR	4204391	M120235	KOEH	4223	M060038	TRUX	42756	P207667	CMJ	4324851	X004478	BLDY
41969	P206372	WLKR	4204408	M085208	KOEH	4224488	M120131	LETO	42758	P206282	WLKR	4324869	X004480	BLDY
41970	P206367	WLKR	4204754	H001279	KOEH	42246	J190023	WLKR	4276	P206519	INDIP	4324877	X004482	BLDY
41971	P206362	WLKR		H001279	TJAK	42247	P207353	WLKR	42760	P206280	WLKR	4327869	X004480	BLDY
41972	P206324	WLKR		H001279	HSTR	4225	M110189	TRUX		P206519	INDIP	43319	P208364	WLKR
41973	P206313	WLKR	4204757	H001284	KOEH	422509	M100048	PIE	42761	P206281	WLKR	43320	P208366	WLKR
41974	P206319	WLKR	4205	M120450	AP	42252	J009560	WLKR	42762	M190002	CMJ	43328	M100463	RDRL
41975	P207386	WLKR		M120450	TRUX	42253	P207332	WLKR	42763	P207339	WLKR	43348	P206347	WLKR
41976	P206367	WLKR		M120450	G0E	42272	P206347	WLKR	42768	M120131	CMJ	43366	P208348	WLKR
41977	P206373	WLKR	420560	J540008	XAIR	42288	P207328	WLKR	427704	J190004	PIE	43381	J034743	WLKR
41978	P206368	WLKR	4206	M101181	AP	422930C1	M090544	NAVI	428193	M100463	PIE	43382	J034744	WLKR
4197837A	M065044	ALMN		M101181	TRUX	42300	P206612	DFLX	4284330	J240006	BAESYS	43405	M090538	SLAR
41979	P206363	WLKR		M101181	G0E	42300C	P206612	DFLX	42855	P206286	WLKR	4342589	P270536	CLRK
41980	P206325	WLKR	4206022	M120131	KOEH	42317	P206547	WLKR	42856	J009560	WLKR		P270536	CLJL
41981	P206314	WLKR	4206302	M120131	KOEH	42320	P208366	WLKR	42857	P207329	WLKR	4343150	P206410	VLVO
41982	P206320	WLKR	42066302	M120131	KOEH	42336	P206282	WLKR	42858	P206347	WLKR	4343154	X004482	VLVO
41983	P206368	WLKR	42067	J024754	WLKR	42338	J024836	WLKR	4288	J009487	INDIP	43438	P207340	WLKR
419838	M080018	WLDN	42068	J024755	WLKR	42339	J024838	WLKR	42880	J009487	INDIP	434386C1	M100464	NAVI
	M080018	MOB	42069	J024835	WLKR	42344	J190013	WLKR	4289	P206385	INDIP	434847C1	M090535	NAVI
41984	P206322	WLKR	4207	M101182	AP	42350C	P206613	DFLX	42891	P207282	WLKR	4352	P207363	XAIR
419843	J009645	RDRL		M101182	G0E	42355	J190025	WLKR	4291	P206512	INDIP	43582	P208380	WLKR
419844	M120225	RDRL		M101182	TRUX	42356	P206345	WLKR	42910	P206512	INDIP	43601	P206343	WLKR
41985	P206374	WLKR	42070	J024837	WLKR	42377	P206305	WLKR	42936	P207330	WLKR	43602	P206345	WLKR
41986	P206369	WLKR	42071	J024746	WLKR	4239	P206410	INDIP	42937	P206345	WLKR	436021401902	X004482	IRKA
41987	P206364	WLKR	42072	J024747	WLKR	42400C	P206614	DFLX	42938	P206408	CMJ	43606	P208324	WLKR
41988	P206326	WLKR	420801	M090544	PIE	4241	P207332	INDIP		P206348	WLKR	436198C1	M090146	NAVI
4198828	P207354	LETO	42081	P207332	WLKR	42410	P207332	INDIP	42939	P207331	WLKR	4362138	P206614	VLVO
41989	P206315	WLKR	4209	X004484	INDIP		P207332	CAT	42940	P206349	WLKR	4362139	P270541	VLVO
41990	P206316	WLKR	420920	M080024	FWD	42423	P206554	WLKR	42944	P207341	WLKR	43668	P207359	WLKR
41991	P206327	WLKR	420C4361	M100048	KOEH	42424	P206555	WLKR	42958	P270538	CMJ	43698	P207329	WLKR

Cross Reference

(See the first page of this section for the Manufacturer's Code Listing)



CROSS REFERENCE

Mfgs. No.	Our No.	Mfg. Code	Mfgs. No.	Our No.	Mfg. Code	Mfgs. No.	Our No.	Mfg. Code	Mfgs. No.	Our No.	Mfg. Code	Mfgs. No.	Our No.	Mfg. Code
43699	P207331	WLKR	447124C1	M090146	NAVI	45727	P208394	WLKR	467364C1	M100464	NAVI	47G500CP	J009487	DFLX
43718	P208358	WLKR	447125C1	M090146	NAVI	45795531	M001702	VLVO	467614C1	M090170	NAVI	47G600	P207667	DFLX
43719	P208374	WLKR	44725	P207314	AP	459M	M001702	IR	46778	P207289	WLKR	480489C1	M090170	CASE
437790C1	M090538	NAVI	44728	P206376	AP	459M	M100466	VCOR	469801C1	M090535	NAVI		M090170	NAVI
43800135	P222755	IR	44728Q	P206376	AP	45A0154X	M090158	FMC	46A1020	M085056	FMC	4812727C2	M090547	NAVI
43846716	M065141	IR	44730	P207285	AP	45A1238	M100146	FMC		M085056	LKBT	481445C2	M090548	NAVI
	M065073	IR	44731	P207285	GOE	45EST	J000219	ACFT	46G300	P206600	DFLX	481727C2	M090547	NAVI
43846880	M001756	IR	44732	P207286	TRUX	45PLS	J190062	ACFT	46G350	P206601	DFLX	482167C1	M090520	NAVI
	M002118	IR	44734	P207286	AP	45R40	P270543	CASE	46G400	P206602	DFLX	482739C91	X004476	NAVI
43849355	M001756	IR	44735	P207318	AP	460303	M065074	MOB	46G500	P206603	DFLX	482894C1	M120365	NAVI
	M002118	IR	44736	P206380	AP	4603865H1	M090544	DRSS	46G600	P207596	DFLX	48450275	H001284	FMCO
43876716	M065141	IR	44737	P207312	AP	460568	M090544	KTSU	46U303	M065074	MOB		H001284	CASE
43897180	P207596	IR	44762C1	M100052	NAVI		M090544	WLDN		M065074	WLDN		H001284	NH
43904515	P222744	IR	44786	P226142	AP	460742000	J024757	WLDN	4700921989	M045237	DYPC		H001284	FIAT
	P222744	VLVO	44853	P206381	TRUX	460C119	P270540	TRJN	470263M91	M070068	MF	48450419	H001279	FIAT
43919646	M090210	IR	44854	P206381	TRUX	460C129	P207367	SIGM	470836C91	X004538	NAVI		H001279	FMCO
439248R91	M100049	NAVI	44863	P216197	TRUX	460742000	P270540	TRJN	470837C91	X004478	NAVI		H001279	NH
43927623	P206325	IR	44GH96	P207667	GTMN	460C119	P206850	CASE	470838C91	X004480	NAVI		H001279	CASE
439797C1	M100052	NAVI	44J000233	J000233	PPOW	460C129	P207367	SIGM	470839C91	X004482	NAVI	48488SC1	M090538	NAVI
43B25	M045237	GRDL	44M001505	M001505	PPOW	460V6301	M100146	KOEH	4710519	M065074	MILR	485123C91	X004478	NAVI
440377C1	M100052	NAVI	44M122300	M122300	PPOW	461091900	P270538	TRJN	47129001005720	M100572	SUSN	485124C91	J009604	NAVI
44045	M085090	PETTI	450275	H001284	CASE	462513C91	M090544	NAVI	47129002066000	P206600	SUSN	485934C1	M100465	NAVI
440737C1	M085023	WLKR	450362	H001278	FIAT	46300	P206608	DFLX	47129002066020	P206602	SUSN	486089C1	M100463	NAVI
44126	P207287	WLKR	450362	H001278	CASE	46300CP	P206600	DFLX	471382C1	M085023	NAVI	486109R91	M100465	NAVI
44127	P207292	WLKR	450362	H001278	FMCO	46300Z	P206600	DFLX	47150	P222748	DFLX	486110C1	M100465	NAVI
44280	P206311	WLKR	450362	H001278	NH	463026C1	M090544	NAVI	47200	P206403	DFLX	486118C1	M100465	NAVI
442926C1	M100464	NAVI	450362	H001279	CASE	46346	P206410	HAWK	47225	P206404	DFLX	48756	P270536	CRMY
442928C1	M090535	NAVI	450362	H001279	FMCO	46350	P206609	DFLX	4724170	P206542	GRVE	48710C2	M085189	NAVI
442930C1	M090544	NAVI	450362	H001279	FMCO	46350CP	P206609	DFLX	47250	P206405	DFLX	489737C91	X004476	NAVI
442937C1	M100464	NAVI	450362	H001279	NH	46350Z	P206601	DFLX	47275	P206406	DFLX	489790C91	X004537	NAVI
44299	P207295	WLKR	450362	H001278	CASE	463541C1	M065065	NAVI	47300	J000227	DFLX	48992	P206317	VACT
44300	P207296	WLKR	450362	H001278	NH	463765C1	M090170	CUCG	47350	J000228	DFLX	48992	P206317	VACT
44301	P207285	WLKR	450362	H001278	FMCO	46400	M090170	NAVI	47400	J000230	DFLX	48BM5120	P206369	AA
44302	P206380	WLKR	450362	H001279	CASE	46400CP	P206610	DFLX	474403	P208330	MOB	48BM5121	P207364	AA
444229C1	M100052	NAVI	450362	H001279	FMCO	46400Z	P206610	DFLX	47450	J000231	DFLX	48BM5122	P206326	AA
44456	P206378	WLKR	450362	H001279	NH	4644400	M001035	DRBG	47500	J000232	DFLX	48BM5123	M100048	AA
44457	P206379	WLKR	450362	H001279	FMCO	46445800	P270539	DRBG	475354C1	M100463	NAVI	48C300	P206523	DFLX
4450	M070028	CRMY	450362	H001279	NH	46445800	P270539	DRBG	47600	J000233	DFLX	48C350	P206524	DFLX
4452	P206409	CRMY	450362	H001279	FMCO	4644643C1	M085023	NAVI	476349C91	J009606	NAVI	48C400	P206525	DFLX
445454L	J038611	XAIR	450362	H001279	FMCO	464483200	P270540	DRBG	476663	M045193	MOB	48C500	P206526	DFLX
445454R	J038612	XAIR	450362	H001279	NH	464484400	H001035	DRBG	47786B	M090544	OKSH	48C600	P206515	DFLX
44569	P206350	WLKR	450362	H001279	FMCO	464484500	M001504	DRBG	47786BX	M090544	OKSH	48CH300	P206523	DFLX
44630	M070069	SLAR	450362	H001279	NH	464485200	P208392	DRBG	4784	J000227	NH	48CH350	P206524	DFLX
44634	P206381	WLKR	450362	H001279	FMCO	464485300	P206411	DRBG	479002	P270532	AA	48CH400	P206525	DFLX
44637	P206382	WLKR	450362	H001279	FMCO	464486400	P270541	DRBG	47972	P206331	WLKR	48CH500	P206526	DFLX
44638	P206383	WLKR	450362	H001279	FMCO	46500	P206611	DFLX	47976	P206331	WLKR	48G200	J009633	DFLX
44653	P206379	WLKR	450362	H001279	FMCO	46500CP	P206611	DFLX	47978	P206333	WLKR	48RU2341	J009614	MACK
44654	P206378	WLKR	450362	H001279	FMCO	46500Z	P206603	DFLX	47984	P206331	WLKR	49006	P206331	WLKR
44656	P207287	TRUX	450362	H001279	FMCO	465971C1	M085023	NAVI	47987	P206333	WLKR	49008	P206333	WLKR
	P207287	AP	450362	H001279	FMCO	46600	P207598	DFLX	47988	P206333	WLKR	49009	J000127	WLKR
44657	P206378	TRUX	450362	H001279	FMCO	46600CP	P207598	DFLX	47989	P206331	WLKR	49010	P206334	WLKR
	P206378	TRUX	450362	H001279	FMCO	46600Z	P207596	DFLX	47993	P206331	WLKR	49011	P206335	WLKR
44658	P207292	AP	450362	H001279	FMCO	46634150	M065073	IR	47996	P206331	WLKR	49012	P206336	WLKR
	P207292	TRUX	450362	H001279	FMCO	46651026	M100463	RSNB	47A0978	M090301	FMC	4901271	M090544	WSTI
446583	M100048	FMCO	450362	H001279	FMCO	46651029	M120108	RSNB		M090301	LKBT	49014272	M100464	VLVO
44659	P206379	AP	450362	H001279	FMCO	46651044	M120131	RSNB	47A978	M090301	FMC	49015280	M100464	WSTI
44661	P206388	AP	450362	H001279	FMCO	46651050	M100463	RSNB	47D200	P206403	DFLX		M100464	VLVO
44662	P207317	AP	450362	H001279	FMCO	46652000	M090544	RSNB	47DG250	P206405	DFLX	49016	P206331	WLKR
44663	P206389	AP	450362	H001279	FMCO	46653350	M120100	TREX	47DG300	P206407	DFLX	49024	P206331	WLKR
44664	P207295	TRUX	450362	H001279	FMCO		M120100	RSNB	47DG350	P206409	DFLX	49026	P206333	WLKR
	P207295	AP	450362	H001279	FMCO	46653365	M120131	RSNB	47DG400	P206410	DFLX	49027	P206338	WLKR
44665	P206382	AP	450362	H001279	FMCO	46664250	M060005	RSNB	47DG500	P206411	DFLX	49028	P226140	WLKR
	P206382	TRUX	450362	H001279	FMCO	46665250	M070008	RSNB	47DG600	P207667	DFLX	49029	P226141	WLKR
44666	P207296	TRUX	450362	H001279	FMCO	46665770	M120154	RSNB	47G200	P206403	DFLX	49030	P226142	WLKR
	P207296	AP	450362	H001279	FMCO	46665796	M090535	RSNB	47G225	P206404	DFLX	49031	P226143	WLKR
44667	P206383	AP	450362	H001279	FMCO	46665797	M090009	RSNB	47G250	P206405	DFLX	49032	P226144	WLKR
	P206383	TRUX	450362	H001279	FMCO	46665797M	M090009	RSNB	47G300	P206407	DFLX	49032190	M120176	WGMC
44668	P207320	AP	450362	H001279	FMCO	46665799	M090072	RSNB	47G350	P206409	DFLX	49033	P226145	WLKR
44669	P206386	AP	450362	H001279	FMCO	466817C1	M090170	NAVI	47G400	P206410	DFLX	4903350	M090535	VLVO
44670	P207321	AP	450362	H001279	FMCO	466984C1	M085023	NAVI	47G400CP	J009486	DFLX	49034	P226146	WLKR
44671	P206387	AP	450362	H001279	FMCO	466984C91	M085023	NAVI	47G500	P206411	DFLX	49034037	M120131	WGMC
44682	P206377	AP	450362	H001279	FMCO								M120131	WSTI
44684	P206381	AP	450362	H001279	FMCO									

Mfgs. No.	Our No.	Mfg. Code	Mfgs. No.	Our No.	Mfg. Code	Mfgs. No.	Our No.	Mfg. Code	Mfgs. No.	Our No.	Mfg. Code	Mfgs. No.	Our No.	Mfg. Code
49034554	M090535	VLVO	4PS4174	M120100	CHLN	5014439	M120189	NABI				50EL90224A	P206349	ACFT
49035	P226147	WLKR	4W5119	P206409	CAT	501462C1	M090535	NAVI	505898	P207419	GASP	50EL90243A	P207365	ACFT
49036	P226150	WLKR				501463C1	M100463	NAVI		P207419	VOEG	50EL90244A	P207332	ACFT
49037185	M100464	WSTI				501464C1	M100465	NAVI	505899	P207596	GASP	50EST	J000217	ACFT
	M100464	WGMC				501471C91	J009606	NAVI		P207596	VOEG	50FBC	P206611	ACFT
49037199	M090535	VLVO				5017090	M070069	SLVN	5066011	X004482	NABI	50FBZ	P206603	ACFT
49037885	M120154	WSTI				501709012	M100016	SLVN	506960	P207341	GASP	50GZ	P206411	ACFT
49039302	M090072	WGMC					M100016	PALA		P207341	VOEG	50H0072	X004480	FMC
49039303	M100463	VLVO				50170907	M070069	PALA	507036R1	M100016	CUCC		X004480	LKBT
	M100463	WSTI				50170909	M065030	SLVN	507064	M070008	CLRK	50HD	J000232	ACFT
	M100463	WGMC				50174500010	P270534	SLVN	507101	M060158	PDEL	50MP3401	P206338	AA
49039309	M100465	VLVO				501745010	M100465	SLVN		M060158	OTWA	50MS236C	P216227	ACFT
49041	P206334	WLKR				50175250002	X004539	SLVN		M060158	TDYN	50MS248C	P216228	ACFT
49042	P226148	WLKR				50175550004	X004484	SLVN	507120	M060251	OTWA	50MS260C	J540008	ACFT
49043	P206331	WLKR				50175700003	X004482	SLVN	507122	M045193	PDEL	50PLA	J009607	ACFT
49043656	M090535	VLVO				501803	M090170	CLRK	507218	M045193	PDEL	50PLS	J009624	ACFT
49044	P226152	WLKR				50187850011	M120365	SLVN		M045193	TDYN	50RCC	P270838	ACFT
49044073	M100465	WSTI					M120365	JOY	508223	X004962	VOEG	50RCZ	P270541	ACFT
	M100465	WGMC				50187850015	M065044	JOY	508420	M090158	DRDT	50S248C	P206389	ACFT
49044082	M080024	VLVO					M065044	SLVN	508699	M090170	DRDT	50S260C	P206391	ACFT
	M080024	WSTI				50187850019	M120176	PALA	508705	M085023	WGMC	50STA120	P206337	ACFT
	M100463	WSTI					M120176	SLVN	508708	M085023	WGMC	50TA	P206298	ACFT
	M100463	VLVO				50187850023	M100049	SLVN	50871714	M070028	IR	50TQ300AZ	J009604	DFLX
49045022	M100465	VLVO				50187850028	M085208	SLVN	508793C91	X007829	NAVI	50TQ350AZ	J009605	DFLX
	M100465	WSTI				501878507	M100048	SLVN	508795C91	X007830	NAVI	50TQ400AZ	J009606	DFLX
49047	P226140	WLKR				501878515	M065044	SLVN	508796	P207324	MOB	50TQ500AZ	J009607	DFLX
49049	P206333	WLKR				501878523	M100049	SLVN		P207324	WLDN	50TS118A	P207298	ACFT
49050	J000127	WLKR				501878527	M100048	SLVN	508796C91	X007831	NAVI	50TS118C	P207309	ACFT
49051	P206334	WLKR				501878528	M085208	SLVN	508797C91	X007784	NAVI	50TS200	X004536	DFLX
49052	P206336	WLKR					M085208	PALA	508798C91	X007785	NAVI	50TS218A	P208392	ACFT
49056	P206337	WLKR				501878529	M090595	SLVN	508804C1	M090548	NAVI	50TS218C	P206385	ACFT
49060	P226151	WLKR				501878533	M085207	PALA	508887C91	X004482	NAVI	50TS225	X004537	DFLX
49062	P206338	WLKR				501878535	M080018	PALA	508903C91	X004480	NAVI	50TS250	X004476	DFLX
49063	P226153	WLKR				5018935	X004482	GRDR	50901719	M085090	IR	50TS275	X004538	DFLX
49064	P206337	WLKR					X004482	GRDL	5092237	X007831	VLVO	50TS300	X004478	DFLX
49065	P206334	WLKR				5018G	J024755	ACFT	50AA	J000203	ACFT	50TS350	X004480	DFLX
49066	P206334	WLKR				5018S	P206555	ACFT	50CN305A	P206375	ACFT	50TS400	X004482	DFLX
49077	P226148	WLKR				50191021	M070028	SLVN	50CS118C	P207309	ACFT	50TS400AZ	X006203	DFLX
49091	P226141	WLKR				502393	P206309	IR	50CS124C	J024758	ACFT	50TS450	X004962	DFLX
49092	P226148	WLKR					P206309	GASP	50CS136C	P216204	ACFT	50TS500	X004484	DFLX
4910020	P226151	ELGN					P206309	VOEG	50CS148A	P207296	ACFT	50TS600	X004539	DFLX
4910021	P226152	ELGN				502492	M085056	IR	50CS148C	P207321	PACC	50X40R105A	P206323	ACFT
49110U	M045123	NLSN					M085056	VOEG		P207321	ACFT	50X40R306A	P206317	ACFT
49120A	M060037	NLSN					M085056	CRMY	50CS160C	P207302	ACFT	50X40R405A	P206328	ACFT
49120B	M060037	NLSN					M085056	GASP	50CS172C	P216205	ACFT	50YTUBE	J092689	ACFT
49125A	M065030	NLSN				502494	P206362	IR	50CS196C	P209910	ACFT	5100006	P206334	TIPP
49130A	M070068	NLSN					P206362	CRMY	50CS218A	P208392	ACFT	51008	P207667	WILM
49135A	M070069	NLSN				5024G	J024837	ACFT	50CS218C	P206385	ACFT	510112	P222748	ARV
49140A	M080024	NLSN				5024S	J024838	ACFT	50CS224A	J024750	ACFT	5102	M090544	TBCR
49146	P206333	WLKR				502527	P270536	IR	50CS224C	J024751	ACFT	510205	X004536	MRMT
49150A	M090091	NLSN					P270536	CRMY	50CS236A	P208374	ACFT		X004536	MARE
49159	P206334	WLKR				50266964	M085056	IR	50CS236C	P208375	ACFT	510205CQ	X004536	MARWIL
49160A	M100016	NLSN				50266972	P206407	IR	50CS248A	P206383	ACFT	510230	X004537	MRMT
49161	P206336	WLKR				502852	M080024	TMCO	50CS248C	P206387	ACFT		X004537	MARE
49162	P206337	WLKR				502879	P270543	TMRK	50CS260A	P208394	ACFT	510230CQ	X004537	MARWIL
492894C1	M120365	CUCC				502882	P207667	TMRK	50CS260C	P208395	ACFT	510234	J000224	ARV
494239160	P206607	CMI				502997	P208328	IR	50CS272A	P224600	ACFT	510255	X004476	MRMT
49540	M090538	SLAR				50300G	P226157	ACFT	50EL15260A	P206396	ACFT		X004476	MARE
49660	X004478	SLAR				50300S	P226158	ACFT	50EL45105A	J190025	ACFT	510255CQ	X004476	MARWIL
496696	M090091	FWD				5030S	J024838	ACFT	50EL45106A	J190027	ACFT	510270	J009612	ARV
49688	M060005	KTSU				504808	M100463	TMRK	50EL45205A	P207354	ACFT	510280	X004538	ARV
	M060005	DRSS				504886C1	M100465	NAVI	50EL67250A	J009560	ACFT		X004538	MRMT
49786	X004537	SLAR				504926C1	M090563	NAVI	50EL90120A	P206347	ACFT		X004538	MARE
49787	X004476	SLAR				504943C1	M090535	NAVI		P206347	PACC	510280CQ	X004538	MARWIL
499373	P207326	CMWK				504959C91	J009604	NAVI	50EL90120C	P207346	ACFT	510295	J009611	ARV
499495C1	M100464	NAVI				504960C91	J009605	NAVI	50EL90121A	P206348	ACFT	510300	J000227	ARV
499528C1	M085023	NAVI				505110	M060483	PDEL	50EL90122A	J190003	ACFT	510305	X004478	MRMT
4E13463	M070008	SHBR				505491	M090520	VOEG	50EL90122C	J190004	ACFT		X004478	MARE
4H0243	P206344	LKBT				505533	X006203	VOEG	50EL90123A	P207339	ACFT	510305CQ	X004478	MARWIL
4ME21698	J028528	MACK				50579085	M090170	IR	50EL90123C	J009547	ACFT	510312	J000228	ARV
4P5575	P207667	CAT				505881	M100048	DRDT	50EL90124C	P206354	ACFT	510355	X006204	MRMT
						505897	P216197	GASP	50EL90220A	J190019	ACFT			

Mfgs. No.	Our No.	Mfg. Code	Mfgs. No.	Our No.	Mfg. Code	Mfgs. No.	Our No.	Mfg. Code	Mfgs. No.	Our No.	Mfg. Code	Mfgs. No.	Our No.	Mfg. Code
547379C1	M120176	CUCC	55098	P270541	CRMY	56774953	M120197	IR	583977C91	J009605	NAVI	59939	P270533	GNRC
54764105	M100016	IR	551032	M120108	JHEI	56776198	M120100	IR	583978C91	J009606	NAVI	59940	P270538	GNRC
54826	M090280	ECS	551045	M100465	XAIR	56778699	X004482	IR	5840015	M090535	GRDL	59A2283	P206311	LKBT
548287C1	M100463	NAVI		M100465	JHEI	56785983	P206410	IR	584173C1	M090781	NAVI		P206311	FMC
54831	J034744	TRUX	5510M	M100465	VCOR	56793318	P206345	IR	585171	M085171	JHEI	5E2100	P206309	RYGO
548450	P206372	ARV	55132	P206403	CRMY	56897978	M120225	IR	585CP	P206510	HDMI		P206309	CAT
	P206372	MRMT	55133	P207333	CRMY	56927973	P270541	IR	586606C1	M100465	NAVI	5E7868	P270535	CAT
548540	M085171	JHEI	55134	P206328	CRMY	56936396	M170101	IR	586607C1	M100465	NAVI		P270535	TIM
548804C1	M090548	NAVI	552046608	P270541	LEBR	5695144	P206508	XAIR	58711B	M080024	KTSU	5M090595	M090595	JHEI
54906B	M090544	OKSH		P270541	ENMT	56951510	P206512	XAIR	58861444	M090598	IR		M090595	ECS
549340	M120108	WGMC	5520476	P270540	ENMT	56951585	P206510	XAIR		M090598	VLVO	5040A	P207394	GRMC
54945	M090544	JHEI		P270540	LEBR	5695159	P206511	XAIR		M090598	ABG	5PS4174	M120108	CHLN
549464C1	M060232	CUCC	552047608	P270540	ENMT		P206511	ECS	58877952	J009606	VLVO		M120108	RCHD
	M060232	NAVI		P270540	LEBR	569818	P206641	XAIR		J009606	IR	5Q7026	P270540	CAT
549465C1	M065065	CUCC	552070714	H001039	LEBR	56CP	P224492	HDMI	588897896	M085023	UNCT		P270540	TIM
	M065065	NAVI		H001039	ENMT	57031403	M090535	IR	588897898	X007830	UNCT	5Q7623	H001279	CAT
549468C1	M085008	CUCC	552596	P206309	CMPR	57037558	M100465	IR	588897899	P206407	UNCT		H001279	TIM
549469C1	M085023	NAVI		P206309	LROI	57049116	P206339	IR	58932450	P206603	UNCT	5Q7626	P270536	CAT
	M085023	CUCC	5525961	P206301	LROI	57165268	X007784	IR	58933623	M085056	SKYJ		P270536	TIM
549470C1	M085023	NAVI		P206301	CMPR	57165276	X007785	IR		M085056	IR	5Q8753	M100572	CAT
549471C1	M100043	CUCC	5529992000	P207366	GILB	5717377	P206378	FIVE	58933631	P206340	IR	5Q8788	P206327	CAT
549472C1	M100048	CUCC	55336	P206410	FNEQ	57200B	M090146	OKSH	59075CP	P206511	HDMI	5XA601	M085208	COUG
549475C1	M090158	CUCC	553832	M100146	CMCO	57200BX	M090146	OKSH	590CP	P206511	HDMI	5XA605	P270536	COUG
549479C1	M120176	CUCC	5540004200	X004539	ATCO	57201B	M070028	OKSH	5910121	M065193	KOEH			
549480C1	M120189	CUCC		X004539	WGNR	5720341	M065071	FIVE	59137851	P206600	IR			
549483C1	M100464	NAVI	5540175500	M122300	ATCO		M065071	ATHEY		P206600	SKYJ			
549511C91	X004539	NAVI		M122300	WGNR	5720547	P207347	ELGN	59157701	P206324	IR	600058001	P270543	VMER
549555C91	X004476	NAVI	5540210200	P206607	WGNR	5721119	P207333	ELGN	59189100	M085090	IR	6000580011	P270543	VMER
	X004476	CUCC		P206607	ATCO	5721121	P270532	ELGN	5931173	X004484	AMEC	600103001	X006202	VMER
	X004476	FURU	5540483400	X004962	ATCO	57284	J000202	CRMY	5931174	X004482	AMEC	6002355	M100048	CLRK
	X004476	DRSS		X004962	WGNR	57285	J000203	CRMY	593120081	M001327	KTSU	60026	M065044	GRST
549556C91	X004478	CUCC	5541095600	P206606	ATCO	57304743	P206280	IR		M001327	CETCO		M065044	HRCN
	X004478	FURU	5541602	M085056	CMCO	5733008	P206407	KOEH	593121085	P224617	CETCO	6003255	M100464	CLRK
	X004478	DRSS	5541746600	P206314	ATCO	5735602	P207326	KOEH		P224617	KTSU	6006049	M090072	CLRK
	X004478	NAVI	5542	X004537	CRAN	5735603	P207326	KOEH	5931971	X004480	AMEC		M090072	VME
549557C91	X004480	FURU	5542015000	P206328	ATCO	574554401	M085411	ELECT	59372599	P207281	IR	60090ETR	P207366	AJMC
	X004480	DRSS	5545	X004478	CRAN	574554601	P206408	ELECT	59372615	P206409	IR	60094217	M085090	BROD
	X004480	CUCC	5546	X004480	CRAN	574554801	P207362	ELECT	594070	M085056	GTMN	60094381	M045237	BROD
	X004480	NAVI	5547	X004482	CRAN	574594701	M002119	ELECT	594270	P206374	GTMN	60094406	M080018	BROD
549558C91	X004482	DRSS	5550035	X004536	OMNI	575480	P206543	ECS	594271	P206410	GTMN	60094519	M090301	BROD
	X004482	FURU		X004536	COMPAC	5758068C1	M090563	NAVI	594308	P206370	GTMN	60094542	P224669	BROD
	X004482	NAVI	555005016001	P206555	CMI	5759513	P206542	XAIR	594309	P206322	GTMN	600A1016	P206338	AP
	X004482	KTSU	555005018000	P207283	CMI	579711	X005207	XAIR	594317	P206282	GTMN		P206338	TRUX
	X004482	CUCC	55528	M090595	JHEI	57991408	J190003	IR	594329	P207326	GTMN	600C1016	P206338	AP
549559C91	X004484	DRSS	5554373	X007829	SNKL	57991416	J009645	IR	59450254	M060055	SKYJ		P206338	TRUX
	X004484	NAVI	5557	P206607	CRAN	57A0936	M100466	FMC		M060055	IR	6010469	M085056	ECLD
	X004484	FURU	555M045193	M045193	ALMD		M100466	LKBT	59450262	M065034	IR		M085056	SISU
549563C91	X004536	DRSS	557686	M100463	VLVO	580136	H001279	HDMA		M065034	VLVO		M085056	VALM
	X004536	FURU	55945	M090535	JHEI	58167925	M100463	IR	59456103	P206406	IR	601354	P270538	Marine
	X004536	NAVI	559903	P206410	AGEM	58173378	X004484	IR	594610	X004478	GTMN	601355	M090158	Marine
549564C91	X004537	DRSS	55CP	P206509	HDMI	58173386	P206411	IR	594647	P207362	GTMN	601356	P270538	Marine
	X004537	CUCC	5605586	M120131	ENMT	58195751	P207322	EIMC	594979	M060055	GTMN	602499001	P207332	VMER
	X004537	NAVI		M120131	LEBR	58195777	P206507	EIMC	59512814	M080018	IR	6024990011	P207332	VMER
	X004537	FURU	5606629	M120176	LEBR	58198235	M100213	IR	595182	M085207	GTMN	602588	P270534	Marine
549565C91	X004538	NAVI		M120176	ENMT	582122C1	M090781	NAVI	595234	M100146	GTMN	602616	M065044	Marine
	X004538	FURU	56109	H001035	VLVO	582123C1	M090781	NAVI	59534321	M085008	IR	6031328	M100146	DUHR
	X004538	DRSS		H001035	CRMY	58259321	P207355	IR	59536524	M090159	IR	603165	P270539	Marine
549611C91	X004539	DRSS	5611585	X004482	ENMT	58259329	P207341	IR	59548594	M045193	IR	603923001	M001503	VMER
	X004539	NAVI		X004482	LEBR	5826466	X004480	GRDR		M045193	VLVO	603924001	M001505	VMER
	X004539	FURU	563023	P270536	CAT		X004480	GRDL	595707M91	M090091	AGCO	6039240011	M001505	VMER
54962	M090544	FWD		P270536	BLNT	5826861	M120365	GRDL	59595	P270540	GEHL	604129	P207362	MTWC
54984	P206390	TRUX	563109	P206407	CAT	5826864	M120225	GRDL		P270540	GNRC	604470	P206372	GTMN
54985	P208393	TRUX		P206407	OMML	5827462	M090158	GRDL	5959768	M100049	FLYR	604476	P206321	GTMN
54991	P207288	TRUX		P206407	BLNT	5829628	M120108	GRDL	59626663	M080024	IR	604477	P206345	GTMN
54993	P224710	TRUX	565231	M120131	WGMC	583200338	M080024	CETCO	59626671	M070068	IR	604534	P206341	GTMN
54CP	P206508	HDMI	565243	P206410	OMML	583964C91	X004537	NAVI		M070068	VLVO	604631	P270541	Marine
550038022	M070068	CMCO		P206410	BLNT	583965C91	X004476	NAVI	59656553	M060037	IR	604809	P206397	GTMN
550038023	M085090	CMCO	5652480	P206385	MNTW	583966C91	X004538	NAVI	59700534	M120108	IR	604964	X004396	GTMN
550038382	M100146	CMCO	565477	M065071	BLNT	583967C91	X004478	NAVI	597126	M120131	EMOI	604965	P206306	GTMN
55006	P226142	WLKR		M065071	CAT	583968C91	X004480	NAVI	597256	M120225	EMOI	604966	M045237	GTMN
55016620	X004482	TMRK	565478	P270534	CAT	583969C91	X004482	NAVI	597286	M120225	EMOI	605042	P207364	GTMN
5504	M170101	CYPR		P270534	BLNT	583975C91	J009604	NAVI	59801860	H001039	IR	605091	P207324	GTMN
55049	M080024	PTBN	5672	P206546	CNLC				5987323	M090074	AMEC	605323	M065044	GTMN
									59902	P270536	GNRC			

Cross Reference

(See the first page of this section for the Manufacturer's Code Listing)



CROSS REFERENCE

Mfgs. No.	Our No.	Mfg. Code	Mfgs. No.	Our No.	Mfg. Code	Mfgs. No.	Our No.	Mfg. Code	Mfgs. No.	Our No.	Mfg. Code	Mfgs. No.	Our No.	Mfg. Code
605337	P206328	GTMN	62182	M080018	HRCN			P206410	SDVK	6535	P206409	XAIR		M120448
605338	M065034	GTMN	62183	M070068	HRCN			P206410	EIMC	6540	P206410	XAIR		M120448
605358	P206308	GTMN	6222668	P207389	LNDL	64118734		P206603	SDVK	6550	P206411	XAIR	6814910700	M120450
605405	M090544	AGEM	622362	P207341	EMOI			P206603	EIMC	65760001	P208338	VMER		M120450
605409	P206410	AGEM	62244	J190058	HRCN			P206603	TMRK	657600011	P208338	VMER		M120450
605441	P206407	AGEM	6224934	M065073	LNDL	64119242		P206347	EIMC	65805	P270541	GNRC	6815	M090009
605457	P206319	GTMN	6230	P206600	XAIR	642050		M065030	FWD	65806	P270543	GNRC	682684	P270538
605477	J009640	GTMN	6232815	M120131	ECLD	6426225		X004482	LEBR	65901	M065065	RKRM	685217	M090544
606740	P226149	Marine		M120131	VME	6426229		X004484	LEBR	660098	M120100	GM	685350L1	M100049
6067122	M065071	FMCO		M120131	VLVO	6426600		M070068	LEBR	66200	X004536	JHEI	685478	M100213
60857703	M085078	LEAR	62332	P207414	HRCN	6427162		X004480	LEBR		X004536	XAIR	685703L1	M120100
60901	M060232	RKRM	6235	P206601	XAIR	64400606		P207667	EIMC	66225	X004537	XAIR	685946	M101182
60BM1357	P270541	AA	623631226X1	P270538	FURU	64544223		P206407	SDVK	66250	X004476	JHEI	686072	P206603
60EST	J000218	ACFT		P270538	DRSS			P206407	EIMC		X004476	XAIR	686082	P270541
60FBC	P207598	ACFT	6240	P206602	XAIR	64558024		M090091	SDVK	66275	X004538	JHEI	686420	M060055
60FBZ	P207596	ACFT	6250	P206603	XAIR	64572841		M045237	SDVK		X004538	XAIR	686424	M090074
60GZ	P207667	ACFT	62548	M090091	HRCN	64673		P216202	TRUX	66300	X004478	XAIR	687820	P206283
60PLA	J190055	ACFT	6260	P207596	XAIR	64804136		M100146	EIMC		X004478	JHEI	687824	P206312
60PLS	J190063	ACFT	62712	J190042	HRCN	64804786		M065071	EIMC	663283	M090074	GM	687828	P206344
60RCZ	P270543	ACFT	6299	J190014	NH	64806596		M080018	SDVK	6633766	P270532	CLRK	687832	P206348
60STA120	P206338	ACFT	62W2269	M090159	KOOT			M080018	SDVK	66350	X004480	TESSI	687836	P206407
60X50CS148C	P207321	PACC	62W9012	M080018	KOOT	648808		X004536	MCHC		X004480	XAIR	687840	P206410
60X50CS160C	P207302	PACC	6300	P207363	NH	648810		X004537	MCHC		X004480	JHEI	687844	P206411
60X50CS196C	P209910	PACC	631204500	X004482	VH	648812		X004476	MCHC	66362	X007829	NOBEL	687860	P206602
60X50CS248C	P206387	PACC	631204510	J024836	VH	648814		X004538	MCHC		X007829	SCHAE	687864	P206850
60X50CS260C	P208395	PACC	6317331	P206328	NABI	648816		X004478	MCHC	66400	X004482	TESSI	687868	P207361
60X50R106A	P207402	ACFT	6320	J000220	XAIR	648820		X004482	MCHC		X004482	JHEI	687876	P207596
610	M065065	AP	63229	M120418	HRCN	648822		X004484	MCHC	66496	P207362	TYLE	687884	P208393
6100481	P206282	TIPP	63238	M060037	WKSA			X004484	CNLC	66500	X004484	XAIR	687888	P206603
61192	P270531	GNRC	63239	P270533	GNRC	64955		P206315	HRCN		X004484	XAIR	688557	M090301
61225	X004537	TBCR	6325	J000221	XAIR	64956		P206317	HRCN		X004484	JHEI	689132	X004484
61240007	M120154	TBBI	6330	J000227	XAIR	65013S1		M120365	SEDD		X004484	TESSI	689136	X004536
61240011	M110674	NAVI	6335	J000228	XAIR	65119192		M060037	CLJL	66500F	X007785	JHEI	689164	X006202
	M110674	FRTL	63361	P270838	CRAN			M060037	CLRK	66600	X004539	TESSI	689168	X004484
	M110674	TBBI	6340	J000230	XAIR	651562		J190042	LROI		X004539	XAIR	689172	X004539
61240015	M085171	TBBI	63407	P206369	HRCN			J190042	CMPR	669473	P206404	CLJL	689176	X006203
61240016	M085078	TBBI	63462	P207355	HRCN	651563		P207326	CMPR	66U13753	X004478	TCLD	69000400	X006849
61240169	M120713	TBBI	6350	J000232	XAIR			P207326	LROI		X004478	CALD	69008773	X004537
61240385	P206311	TBBI	63510	M060250	EAGP	651567		P206280	LROI	66U1375301	X004536	TCLD		X004537
61250	X004476	TBCR		P206374	HRCN	651570		P206280	CMPR		X004536	CALD	69008774	M170101
61275	X004538	TBCR	63552040	P206556	KTSU			P207362	LROI	66U21491	M045237	CALD	69008926	P222751
61300	X004478	TBCR		P206556	MH	651571		P207362	CMPR		M090158	TMRK	69013569	X004476
61350	X004480	TBCR		P206556	DMAG			J008681	CMPR	671732	M090158	TMRK	69015849	X004536
61400	X004482	TBCR	63552140	X004539	MH	651575		P207366	LROI	671733	M120225	TMRK		X004536
614042724	P226152	CAM		X004539	DMAG			P207366	CMPR	67362	M080024	ATHP		X004536
	P226152	PRIN		X004539	KTSU	651581		P207408	CMPR	67496	M060158	WLDN	69033512	P207366
61500	X004484	TBCR	63586	P206370	HRCN			P207408	LROI	6751378	M120100	AMLF		EIMC
61573	P216175	HRCN	63696S1	M070069	SEDD	6519192		M060037	CLJL	676533	M100464	GM		SDVK
61574	P206338	HRCN	63898	P207282	HRCN			M060037	CLRK	6772134	X004480	VLVO	69040237	P206340
61599	P207408	HRCN	640001	J640001	AP			M060037	VME	6772734	X004480	VME	690420R91	M120100
61600	X009076	HRCN	640008	P224600	AP	651997		M100049	GM		X004480	ECLD		M120100
	X004539	TBCR	64045	P207402	HRCN	652468		P207365	LROI	6779670	X004478	ECLD		CASE
617890001	M001668	VMER	64101298	P206408	EIMC			P207365	CMPR		X004478	VME		M120100
6181929	M100572	ELGN		P206408	TMRK	6524682		P207365	LROI		X004478	VLVO	691318	M100464
	M100572	ATHEY		P206408	SDVK	652469		P207283	CMPR	680013	M070008	NAVI	69427B	M100463
6187303	M085023	ATHEY	64106179	X004478	EIMC			P207283	LROI	680033	M070050	NAVI	69445089	M045237
	M085023	ELGN		X004478	SDVK	652474		P206346	CMPR	680033	M070050	NAVI	6953201	M065030
6202245	M060037	FMC	64106591	X004539	EIMC			P206346	LROI	68010	M100464	NAVI	695423	M100464
62027	M065030	HRCN		X004539	SDVK	652475		P207282	CMPR	680400	M065065	TMTR	695424	M100048
6202728	M065030	FMC		X004539	TMRK			P207282	LROI	680401	M100048	TMTR	69941B	M100465
6203000009	X004484	MLS	64106592	X007785	TMRK	652490		P206344	LROI	680402	M120100	TMTR	69A0122	M085056
6203000013	M090595	MLS		X007785	EIMC			P206362	LROI	6804900201	M110148	MERS		FMC
6203577	P270536	ELGN	64106599	X004480	SDVK	652491		P206362	LROI		M110148	FRTL	6A1145	M080024
6206115910	X007829	KTSU		X004480	EIMC	6524911		P206361	LROI	6804900401	M110112	MERS	6HD247	P206410
62104449200	P206603	KOEH	64106926	X004482	EIMC			P206361	CMPR	68106374	P207596	TMRK	6I0144	X007805
6210451550	M120365	NWEG		X004482	SDVK	652492		P206554	LROI		P207596	SDVK		X007805
62104524	M090009	NWEG		X004482	TMRK	652493		P206326	CMPR	6811502	M080018	CDIV		CAT
62104526	M090091	NWEG	64108268	P206411	SDVK			P206326	LROI	6811503	P206600	CDIV	6PS4174	M090535
62104527	M100016	NWEG		P206411	EIMC	652504		P207322	LROI		P206600	CDIV		RCHD
62104543	M120225	NWEG		P206411	TMRK	652535		P207341	LROI	68122680	P226140	EIMC		
6211458	P206519	FMC	64116798	P206407	EIMC			P207341	CMPR	68122681	X004478	SDVK		
62169	M065030	HRCN	64116949	P206410	TMRK	65297S1		M100043	SEDD	6814910400	M120448	MERS		
						6530		P206407	XAIR					

7

7000073228... M060247... KBTA
7000302389... X004482... IKRS

Cross Reference

(See the first page of this section for the Manufacturer's Code Listing)



CROSS REFERENCE

Mfgs. No.	Our No.	Mfg. Code	Mfgs. No.	Our No.	Mfg. Code	Mfgs. No.	Our No.	Mfg. Code	Mfgs. No.	Our No.	Mfg. Code	Mfgs. No.	Our No.	Mfg. Code
	M090158	GRVE	78254	M100464	LROI	8			809547	J009547	TRUX	82082010026	P206851	MAN
7642000068	M120235	GRVE	78268	M060158	CMPR	80	M045237	AP	809621	P207345	TRUX	82082010027	P207361	MAN
	M120235	MTWC		M060158	LROI		M045237	AP	80973013	M101169	GRDL	82082010028	P206338	MAN
7642000075	M065044	GRVE	78272	M080024	LROI	80000415	J000231	CUMS	809736	P206282	TRUX	8213187000	X004484	GILB
	M065044	MTWC	78273	M100580	LROI	80013034	P207367	MTWC	809737	J190023	TRUX	8213187001	X004482	GILB
7642000080	M070028	GRVE	78283	M100016	CMPR	80015981	M110479	GRVE	809738	P206286	TRUX	82151010021	M090535	MAN
	M070028	MTWC		M100016	LROI	80015984	M120176	GRVE	809739	P206283	TRUX	82152010054	P206400	MAN
7642000088	M090544	GRVE	782862	M085056	CMPR	8001648	H001279	BATI	809750	P207353	TRUX	82152010056	P206337	MAN
	M090544	MTWC		M085056	LROI	8001649	H001284	BATI	809752	P216169	TRUX	82152010060	P208375	MAN
7642000099	M100048	GRVE	78287	M090091	LROI	80018129	P206311	GRVE	809769	P206343	TRUX	82152016012	P270838	MAN
7642000093	M090594	MTWC	78294	M100146	CMPR	80022125	X007785	GRVE	809770	P207345	TRUX	82152100003	P226143	MAN
	M090594	GRVE		M100146	LROI	80082	X007785	RSNBR	809771	J009547	TRUX	82152150017	P206540	MAN
764200056	M120176	GRVE	78295	M085208	LROI		X007785	ROSEN	809793	P207364	TRUX	82155016001	P206611	MAN
7642000603	M100465	GRVE	78300C	P206604	DFLX	801852	M120225	DYPC	809796	J190019	TRUX	82155016002	P206511	MAN
	M100465	MTWC	78312	M065044	CMPR	80273060	M070068	JLGI	8100075	X007784	TIPP	82155016003	X006202	MAN
7642000609	M120100	GRVE		M065044	LROI		M070068	GRDL	81004	M090074	RKRM	8225975000	M090072	GILB
7642000610	M090146	GRVE	78314	M120225	LROI	80373183	M080024	GRDL	81005	M090158	RKRM	8227489000	P206369	GILB
7642000640	M080018	GRVE	78318	M085090	LROI	80483121	M002121	JLGI		P206336	ROSS	8229364000	X004480	GILB
	M080018	MTWC	783181	M085090	LROI		M002121	GRDL	81006	M090158	RKRM	8238488000	P206602	GILB
764200068	M120235	GRVE	78325	M100146	LROI	8049	P206507	TRUX	81008	M090280	RKRM	8238889000	P206328	GILB
764210000	M045237	GRVE	784120014X1	M085208	CETCO	8050	P206507	TRUX	810090220	X007829	MNTW	8239673000	P206507	GILB
7642100001	M060055	GRVE	7842001825	M100146	GRVE	8052	J008167	TRUX	810803400	M090210	TJAK	824001	J014622	TRUX
7642100004	M110479	MTWC		M100146	MTWC	805333	M090009	Americ		M090210	JNDR	824002	P224633	TRUX
	M110479	GRVE	78491	M065044	PBRN	805335	M090009	AMHO	8108214	M080024	EATN	824004	P208338	TRUX
7642100007	M065030	MTWC	78500C	P206604	DFLX		M090009	Americ	810821400	M080024	TJAK	824006	J240024	TRUX
	M065030	GRVE	78626181	M045193	AGCO		M090009	WHITE	810821600	M100146	EATN	824607	P206405	CLJL
7642100008	M060037	GRVE		M045193	DETZ	8056472	X004962	VLVO		M100146	JNDR	824701	P207283	TRUX
7642100009	M120566	GRVE	788022C1	M120131	NAVI	806237	M120100	AMHO	810850800	M070068	TJAK	824715	J024757	TRUX
	M120566	MTWC	78M065044	M065044	HARLEY	806556	M045237	LONG	811175700	M070028	JNDR	824716	J0247309	TRUX
7642100013	M120382	GRVE	78M100572	M100572	HARLEY	80683303	M120751	GRDL		M070028	TJAK	824721	J024749	TRUX
	M120382	MTWC	78M120225	M120225	HARLEY	80683304	M002123	GRDL	8112017	X004478	FLYR	824722	J024751	TRUX
7642100021	M120225	MTWC	79018666	P270535	NH	807002	M070008	AMHO		X004478	NEWFLY	824738	P224627	TRUX
	M120225	GRVE		P270535	FIAT		M070008	Americ	8112018	X004480	FLYR	824749	J024749	TRUX
7642100022	M100213	GRVE		P270535	CASE	8070241	M100695	UPTI		X004480	NEWFLY	824751	J024751	TRUX
7642100024	M101181	GRVE	79028227	H001032	CASE		M100695	VLVO	81152046054	P270541	MAN	824757	J024757	TRUX
7642100026	M101158	GRVE		H001032	NH	8070281	X007805	VLVO	81152046060	P270540	MAN	824758	J024758	TRUX
	M101158	MTWC		H001032	HTHI	8070282	X007824	UPTI	81155016001	P206611	MAN	8249296000	X004539	GILB
7642100035	M120450	GRVE	7905	P270534	WIRG		X007824	VLVO	811870600	X007784	CAT	826337	P206410	Americ
7642100042	M085409	MTWC	790758	P206406	CLJL	807348	X004539	FMNT		X007784	TJAK	827125	P206411	AMHO
	M085409	GRVE	79076459	H001034	NH	80783048	P206395	GRDL	811870700	J190062	BLNT		P206411	Americ
7642800000	M100048	GRVE		H001034	HTHI	80783049	P206328	GRDL		J190062	JNDR	8275035	M065073	TRAK
7642995001	M100146	GRVE		H001034	FIAT	808164	M170101	AMHO	811870700	J190062	CAT	827745	P206409	TREX
76685A	M100049	OKSH		H001034	CASE	80856	P207361	WIRG		X004962	TJAK	82976411	H001033	TREX
769184	P270536	TENT	7910009098	P207354	GRVE	809275	X004482	FLYR	81377789	M085078	TMRK	831012S	P206542	DFLX
7697000164	P206345	GRVE		P207354	MTWC		X004482	NEWFLY		M085078	EIMC	832419	H001284	AGEM
7700054646B	M001503	RVI	794299	M100213	IVECO	809299	X005207	TRUX		M085078	DLTC	834002	P224698	TRUX
7700054689	X004482	RVI	79434	M065034	WLDN	809300	X005207	TRUX	814051	M065034	DYPC	834004	P224628	TRUX
7700059654A	M001702	RVI	794982	M090158	IVECO	809302	J009429	TRUX	814204	M070050	AMHO	834005	J340023	TRUX
7700062689	M001502	RVI	795570C1	M120108	CUCC	809303	J009429	TRUX	81421009	M090158	DLTC	834006	P224581	TRUX
7701030196	P206343	AMC		M120108	NAVI	809304	J009429	TRUX	814621	J014621	TRUX	83471074	M070069	GRDL
	P206343	XMN	798803	M090538	GM	809305	J009429	TRUX	814622	J014622	TRUX	834727	P208359	TRUX
770460000	M060055	PETTI	799118	M080018	DYPC	809306	J009429	TRUX	814623	J014623	TRUX	834728	P208375	TRUX
770512A05	M085023	GRDL	799121	X004478	DYPC	809307	P206543	TRUX	814623	J014623	TRUX	834746	J034746	TRUX
77118	M080018	DYPC	7C1377	X007831	CAT	809308	P206543	TRUX	814623	J014622	TRUX	834747	P216204	TRUX
77173007	M100146	GRDL		X007831	RYGO	809309	P206543	TRUX	815014	P270534	CAT	83476	P206409	LROI
7718810	X004484	HRSN	7C4500	X007830	CAT	809404	P206341	TRUX		P270534	TIM	834779	P216227	TRUX
7734000685	J190042	GRVE	7C7009	X007784	CAT	809406	P206353	TRUX	815743	X007829	CAT	834779	P216227	TRUX
7734000686	P206319	GRVE	7E0114	M080019	CAT	809408	P206354	TRUX		X007829	BROW	8355742	M085078	DUHR
77383601	H001034	GRDL	7E1397	M001505	CAT	809415	P206282	TRUX	81589079	X005207	LORR	8355910	M100043	DUHR
77383778	M100572	GRDL		M001505	CAT	809427	P206543	TRUX		X005207	LRAN	835866	M090074	WGMV
	M100572	JLGI	7E3870	M001503	TIM	809428	P206543	TRUX	81653289	H001032	DLTC		M090544	VLVO
7806300	X004539	KARP		M001503	CAT	809429	J009429	TRUX	8167	X008167	AP	83610	P206410	LROI
78103131	M100048	BADG		M001503	EAGP	809458	P206543	TRUX	8167807	X004484	VLVO		P206410	CMPR
78111	M090009	LROI	7E6455	M001504	CAT	809498	J009429	TRUX	8182600	M002164	UPTI	836309	M080024	AMHO
781111	M090009	LROI		M001668	CAT	809500	X005207	TRUX	81906	M090158	RKRM	836310	M100048	AMHO
78140	M070008	LROI	7E9506	M001504	CAT	809530	J009560	TRUX	81908	M090280	RKRM	83671042	M090210	GRDL
78147	M060005	LROI	7GB010	M100464	WGMV	809544	P206342	TRUX	81922	M090538	RKRM	83671149	X004480	GRDL
78152	M045237	LROI		M090544	VLVO	809545	P207345	TRUX	81923	M090563	RKRM	83671225	M070069	GRDL
78157	M070028	LROI	7LT400	M090362	RKRM	809545	P207345	TRUX	81923	M090563	RKRM	83683097	X007785	GRDL
78158	M070050	LROI	7N1087	M001566	CAT		P207345	AP	8198	J009649	BLNT	83683175	P206405	GRDL
781670	P206319	DYPC	7TU01112	P206851	AA	809546	P207346	TRUX	82033810	P224589	GRDL	83713009	X007784	GRDL
			7TU01113	P226148	AA				82034108	M070068	CASE		X004482	WRNR
									82034547	M090159	BADG			

(See the first page of this section for the Manufacturer's Code Listing)

Mfgs. No.	Our No.	Mfg. Code	Mfgs. No.	Our No.	Mfg. Code	Mfgs. No.	Our No.	Mfg. Code	Mfgs. No.	Our No.	Mfg. Code	Mfgs. No.	Our No.	Mfg. Code
8374280546	H001033	KAEL	844663	P206389	TRUX	85500CP	P206509	DFLX	86132M	M090074	NLSN	86503M	M120366	NLSN
83746	P206409	CMRP	844668	P207320	TRUX	85803795	M065030	NH	86133M	M100049	NLSN	86507M	M065065	NLSN
83747	P207667	LROI	844669	P206386	TRUX		M065030	CASE	86134M	M085008	NLSN	86510M	M090547	NLSN
	P207667	CMRP	844670	P207321	TRUX	85804014	P270534	NH	86136M	M060055	NLSN	86511573	P206409	NH
83816	M060055	WLDN	844671	P206387	TRUX		P270534	CASE		M060232	NLSN		P206409	CASE
83890	P206411	LROI	844734	P207318	TRUX		P270534	FIAT	86137M	M065065	NLSN	86511M	M090548	NLSN
	P206411	CMRP	844735	P207319	TRUX	85805478	M065030	NH		M065034	NLSN	86512M	M090520	NLSN
83931	X007785	LROI	844737	P207312	AP		M065030	FIAT	86139M	M085023	NLSN	86513M	M090563	NLSN
839312	X007829	LROI		P207312	TRUX		M065030	CASE	8613U	M090544	TYLR	86514M	M090781	NLSN
839313	X006204	LROI		P207312	GOE	85821055	M085084	CASE	86144M	M090362	NLSN		M090781	GRMC
83947685	X004536	CASE	845100207	M070008	KOEH		M085084	NH	86145M	M090072	NLSN	86515M	M065065	NLSN
	X004536	FMCO	84546	P209913	AP	85821060	X004478	FIAT	86147M	M120225	NLSN	86518M	M065065	NLSN
	X004536	FIAT	84584	P206302	AP		X004478	CASE		M120108	NLSN	86521M	M085023	NLSN
	X004536	NH	84585	J000127	AP	85821061	X004480	CASE	86148M	M100146	NLSN	86522M	M085172	NLSN
83AX1039	P206603	MACK	846100205	M060005	CAME		X004480	FIAT	86149M	M120382	NLSN	86525M	M085189	NLSN
840031	M090280	TREX		M060005	KOEH	859003CP	P206511	DFLX	86150	M060038	DFLX	86526M	M100213	NLSN
	M090280	AMHO	846100207	M070008	KOEH	85900RCP	P206511	DFLX	86150M	M070028	NLSN	86529M	M110189	NLSN
841041S	X005207	DFLX		M070008	CAME	85901	M085171	RKRM	86151M	M100052	NLSN	86530M	M110311	NLSN
841074700	X007831	TJAK	846100209	M045237	KOEH	85903	M085008	RKRM	86152M	M100464	NLSN	86531M	M100580	NLSN
	X007831	JNDR	846100243	M085023	KOEH	85904	M085080	RKRM	86153M	M090523	NLSN	86533M	M100580	NLSN
	X007831	CAT	846100247	M085023	BRLEE	85923	M085172	RKRM		M090280	NLSN	86535M	M100695	NLSN
	X007831	BLNT		M085023	KOEH	85924	M085189	RKRM	86163M	M065065	NLSN	86536M	M090680	NLSN
841076000	X004478	CAT		M085023	RSCO	85925	M085023	RKRM	86168M	M100048	NLSN	86537M	M090547	NLSN
	X004478	BLNT	846100273	M065065	KOEH	85925	M085023	RKRM	86172M	M060005	NLSN	86538M	M090563	NLSN
	X004478	JNDR		M065065	RSCO	85GH18CP	P206641	DFLX	86173M	M070008	NLSN	86539	M065065	NLSN
	X004478	TJAK		M065065	RSCO	85SC6003Z	P224492	DFLX	86174M	M070050	NLSN	86541M	M110012	NLSN
841087100	X004482	TJAK	846100279	M100464	KOEH	86025101	X007784	NH	86175M	M090009	NLSN	86542M	M120566	NLSN
	X004482	JNDR		M100464	KOEH		X007784	BVER	86177M	M045237	NLSN	86543M	M120713	NLSN
841389	P206407	Americ	846100283	P206311	CAME		X007784	CASE	86178M	M065071	NLSN	86544M	M100466	NLSN
841600207	M070008	KOEH		P206304	CAME	86025102	X007785	BVER	86179M	M090280	NLSN	86545M	M090548	NLSN
842167	X004538	AMHO	846100287	P206302	CAME		X007785	EARN	86180M	M122300	NLSN	86547M	M100695	NLSN
	X004539	Americ	846100292	M090158	BRLEE	86032538	P207596	BVER	86183M	M085172	NLSN	86548M	M090547	NLSN
84217668	M001502	CASE		M090158	RSCO	86034576	M090072	BVER	86184M	M085189	NLSN	86560M	M090594	NLSN
842434	M190002	Americ		M090158	CAME	8605331	M002122	CASE	86185M	M090563	NLSN	86563M	M090158	NLSN
842954800	P206325	TJAK	846100328	J024748	CAME	8608	J000224	AP	86186M	M085407	NLSN	86571015	M070050	WRNR
842964800	P206325	BLNT	846100344	X004484	CAME	8609	J000227	AP	86190M	M060481	NLSN		M070050	GRDL
	P206325	JNDR		X004484	KOEH	86102M	M090535	NLSN		M060158	NLSN	86571017	M080024	GRDL
	P206325	CAT	846100359	M090146	CAME	86106M	M090158	NLSN	86191M	M065044	NLSN		M080024	GRDL
	P206325	TJAK	846100379	M100464	KOEH	86108M	M090544	NLSN	86192M	M085084	NLSN	86571018	P206410	GRDL
842973900	M090301	JNDR	84656	M001668	KTSU	861108M	M100464	NLSN		M085098	NLSN	86624M	M090544	NLSN
	M090301	CAT	846850	M090158	AMHO	86111M	M100464	NLSN		M085206	NLSN	86626M	M100807	NLSN
	M090301	TJAK	848101164	H001278	KTSU	86113M	M090146	NLSN	86193M	M090301	NLSN	86631M	M090680	NLSN
	M090301	BLNT	8483	P206507	AP	86115M	M120154	NLSN	86194M	M120235	NLSN	86643883	X007784	CASE
842974000	P206310	BLNT	85071213	M070008	GRDL	86116	J000228	AP	86195M	M100465	NLSN	86644K	M110189	NLSN
	P206310	TJAK		M070008	WRNR	86116M	M120131	NLSN	86196M	M100582	NLSN	86644M	M110189	NLSN
	P206310	CAT	850982	P270532	AGEM	86117M	M120365	NLSN	86200	M060037	DFLX	86650M	M110012	NLSN
	P206310	JNDR	85106083	X007785	VLVO	86118M	M100043	NLSN	86200M	M100464	NLSN	86653M	M110012	NLSN
	P206601	BLNT	85107180	M090544	VLVO	86119M	M085080	NLSN	86203M	M120197	NLSN	86657M	M090170	NLSN
	P206601	TJAK	85107544	X007805	VLVO	861206M	M085078	NLSN	86206M	M090210	NLSN	86660M	M110189	NLSN
842974200	P206600	JNDR	85131016	M085008	WRNR	8612	J000230	AP	86213M	M090538	NLSN	86661M	M090280	NLSN
	P206600	BLNT		M085008	GRDL	86121M	M120131	NLSN	86215M	M100464	NLSN	86662M	M100043	NLSN
	P206600	CAT	851SA1930	M070050	CLRK		M120176	NLSN	86216M	M090146	NLSN	86668M	M090563	NLSN
	P206600	TJAK	853030041	M100572	CETCO	86125M	M120100	NLSN	86220M	M120367	NLSN	86669M	M090520	NLSN
843006400	P206311	JNDR	853030072	P207559	CETCO	86127M	M085171	NLSN	862265	M120197	AMHO	86671417	M070050	WRNR
	P206311	TJAK	8533345	X004484	FMNT	8612910	P206327	CAT	86240012	P206397	TBBI		M070050	GRDL
843006500	P206602	JNDR	854000	P207318	TRUX		P206327	BLNT	86240013	P206326	TBBI	86671583	P206601	GRDL
	P206602	TJAK	854001	J540008	TRUX	8612944	M070069	NLSN	86250	M065030	DFLX	86671607	M070068	GRDL
844000	P206381	TRUX	854002	P207299	TRUX		M070069	BLNT	8626181	M045193	DETZ	86672M	M110014	NLSN
844001	P216228	TRUX	854003	P207300	TRUX		M070069	OMML		M045193	KTSU	86681083	M060232	GRDL
844002	P207314	TRUX	854004	P224692	TRUX	8612947	P206403	CAT		M045193	KLMA		M060232	WRNR
844003	P207287	TRUX	854005	P224693	TRUX		P206403	BLNT	86300	M070068	DFLX	86682M	M100465	NLSN
844004	P207317	TRUX	854006	P224641	TRUX	8612965	P206410	NLSN	86350	M070069	DFLX	86705M	M110077	NLSN
84437	X004536	LAWSON	854006	P224641	TRUX		P206410	CAT	86371225	M070069	GRDL	8671	J008671	AP
84438	X004537	LAWSON	85400CP	P206508	DFLX	8612966	M080024	BLNT	86400	M080024	DFLX	86713M	M090544	NLSN
84439	X004476	LAWSON	854003160	M100464	GRDL		M080024	CAT	864000	J640005	TRUX	86722M	M085267	NLSN
84440	X004538	LAWSON	85403161	M090091	GRDL	8612986	P206406	BLNT	864001	P224600	TRUX	86724M	M110479	NLSN
84441	X004478	LAWSON	854715	P206390	TRUX		P206406	CAT	864671	P216202	TRUX	86725M	M100572	NLSN
84442	X004480	LAWSON	854723	P207301	TRUX	8612988	P206409	CAT	864672	P216205	TRUX	86739M	M090074	NLSN
84443	X004482	LAWSON	854724	P207302	TRUX		P206409	BLNT	86500	M090091	DFLX	8674	P216172	AP
84444	X004484	LAWSON	854727	P208389	TRUX	86130M	M100463	NLSN	86500M	M110012	NLSN	86740M	M090781	NLSN
84466	X004539	LAWSON	854728	P208395	TRUX		M100465	NLSN	86502M	M110189	NLSN	8675	P206340	AP
844661	P206388	TRUX	854830	P224693	TRUX	86131M	M090544	NLSN	865034C91	M100049	NAVI	8675034C91	M100049	CUCC

Cross Reference

(See the first page of this section for the Manufacturer's Code Listing)



CROSS REFERENCE

Mfgs. No.	Our No.	Mfg. Code	Mfgs. No.	Our No.	Mfg. Code	Mfgs. No.	Our No.	Mfg. Code	Mfgs. No.	Our No.	Mfg. Code	Mfgs. No.	Our No.	Mfg. Code
86752M	M120100	NLSN	87400108Q	M090544	DFLX	8857720	X004478	DUHR	89045C	P206386	NLSN	89113A	P207326	NLSN
86753M	M120100	NLSN	87400115	M120154	DFLX	8867719	X004482	DUHR	89046A	J024750	NLSN	89114A	P207328	NLSN
8676	P206342	AP	87400115Q	M120154	DFLX	8868	P226148	TRUX	89046C	J024751	NLSN	89115A	P207329	NLSN
86771M	M090823	NLSN	87400120	M090544	DFLX	8869067	M120365	DUHR	89047A	P208374	NLSN	89115C	J190016	NLSN
8678	P206344	AP	87400127	M085171	DFLX	8872	P226149	TRUX	89047C	P208375	NLSN	89116A	P206346	NLSN
8680	P207339	AP	87400127Q	M085171	DFLX	8875	P226129	TRUX	89048A	P206383	NLSN	89117A	P207331	NLSN
8681	J008681	AP	87400131	M090544	DFLX	8877	P226157	TRUX	89048C	P206387	NLSN	89117C	J190019	NLSN
8683	P206394	AP	87400131Q	M090544	DFLX	8878	P226156	TRUX	89049A	P208394	NLSN	89118A	P206349	NLSN
8684	P206395	AP	87400144	M090362	DFLX	8879	P226158	TRUX	89049C	P208395	NLSN	89119A	P216175	NLSN
8685	P206396	AP	87400144Q	M090362	DFLX	8880	P226129	AP	89050A	P208326	NLSN	89123A	P207332	NLSN
86871209	M070069	GRDL	87400594	M090594	DFLX	8881	P226129	TRUX	89051A	P207293	NLSN	89124A	J190009	NLSN
86880066	M080024	GRDL	87400594Q	M090594	DFLX	8882	P226154	TRUX	89051C	P207318	NLSN	89125A	J190017	NLSN
86881083	M060232	WRNR	874050205	M100695	DFLX	8882	P226155	TRUX	89052A	P224633	NLSN	89126A	P207365	NLSN
86881375	X004478	WRNR	874050514	M090781	DFLX	8883	P226151	TRUX	89053A	P208350	NLSN	89127A	J190020	NLSN
	X004478	GRDL	8740505140Q	M090781	DFLX	8884	P226152	TRUX	89053C	P216200	NLSN	8913	P207397	AP
86883066	M080024	GRDL	874050514Q	M090781	DFLX	8885	P226152	AP	89054C	P207319	NLSN	89130A	P206393	NLSN
86883067	M100043	GRDL	87406803	P222018	EARN	8885	P226144	TRUX	89055A	J024746	NLSN	89131A	P206394	NLSN
	M100043	JLGI	87406903	M002135	CASE		P226144	AP	89055C	J024757	NLSN	89132A	P206395	NLSN
8688D066	M080024	GRDL		M002135	ISERVI	8886	P226145	TRUX	89056A	P208366	NLSN	89133A	P206396	NLSN
86981541	M120365	GRDL		M002135	EARN	8887	P226146	TRUX	89056C	J034746	NLSN	89140A	P207415	NLSN
86983714	M090594	GRDL	87427885	M002134	CASE	8888	P226147	TRUX	89057A	P207295	NLSN	89141A	P206301	NLSN
87048600055	P213191	FXBL	87449404	M001503	CASE	8895	P226153	TRUX	89057C	P207320	NLSN	89142A	P206927	NLSN
	P213191	UCP	8745050514Q	M090781	DFLX	88H168193	M045193	DFLX	89058A	J024747	TRUX	89143A	P206302	NLSN
87052700003	X004484	FXBL	874608	P224635	TRUX	88H200190	M060158	DFLX		J024747	NLSN	89143C	J014621	NLSN
87052700004	X004482	FXBL	874609	P224638	TRUX	88H250191	M065044	DFLX	89058C	J024758	NLSN	89144A	P206303	NLSN
87052700005	X004480	FXBL	87500102	M090535	DFLX	88H300102	M085090	DFLX	89059C	P216204	NLSN	89144C	J014622	NLSN
87052700006	X004536	FXBL	87500102Q	M090535	DFLX	88H300192	M085090	DFLX	8906	P207411	TRUX	89145A	P207297	NLSN
870876C91	M100049	NAVI	87500130	M100465	DFLX	88H400148	M100146	DFLX	89060A	P207296	NLSN	89145C	P207308	NLSN
8708876C91	M100049	NAVI	87500130Q	M100465	DFLX	89005A	P208328	NLSN	89060C	P207321	NLSN	89146A	P206305	NLSN
871834R91	M090544	NAVI	87500132	M090074	DFLX	89006A	P206376	NLSN	89072A	P206279	NLSN		P207298	NLSN
87185	P206343	CRQT	87500132Q	M090074	DFLX	89007A	P206376	NLSN	89073A	P206280	NLSN	89146C	P207309	NLSN
872001177	M060232	DFLX	87500145	M090072	DFLX	89010A	P208336	NLSN	89073C	P206280	NLSN	89147A	P207559	NLSN
872001177Q	M060232	DFLX	87500145Q	M090072	DFLX	89011A	P208324	NLSN	89074A	J190023	NLSN	89147C	P207559	NLSN
87250186	M065065	DFLX	87500674	M090595	DFLX	89012A	P206377	NLSN	89075A	P206283	FTGD	89150A	P206306	NLSN
87250186Q	M065065	DFLX	87500674Q	M090595	DFLX	89013A	J240012	NLSN		J190027	NLSN	89151A	P206308	NLSN
	M065071	DFLX	875390	M100464	IVECO	89015A	P206378	NLSN	89077A	P206281	NLSN	89152A	P206927	NLSN
87300004	M060005	LKWD	875480	P206543	ECS	89015C	P206388	NLSN	89081A	P207347	NLSN	89153A	P206309	NLSN
87300018	M080018	DFLX	87674684	P224515	RYKE	89016A	P224589	NLSN	89082A	P207349	NLSN	89154A	P206310	NLSN
87300018Q	M080018	DFLX	87674852	M002123	CASE	89016C	P224590	NLSN	89083A	P207351	NLSN	89155A	P208386	NLSN
87301605	M002120	CASE		M002123	NH	89018A	P206379	NLSN	89084A	P207353	NLSN	89155C	P206384	NLSN
	M002120	NH	8771	P206328	NH	89018C	P206389	NLSN	89090A	P207362	NLSN	89156A	P208392	NLSN
	M002120	ISERVI	8776	P216175	NH	89019A	P208393	NLSN	89091A	P206397	NLSN	89156C	P206385	NLSN
87309100001	M090595	FXBL	8777	P206365	NH	89019C	P206391	NLSN	89092A	P207363	NLSN	89157A	P207419	NLSN
87314920	M001503	NH	87NPT350174	M070008	DFLX	89020A	P208324	NLSN	89093A	P206398	NLSN	89160A	P206372	NLSN
	M001503	CASE	880L1	M090074	DREO	89021A	P207285	NLSN	89094A	P207364	NLSN	89161A	P206373	NLSN
87319252	M002119	KBCO		M090074	WGMC	89021C	P207314	NLSN	89095A	P206399	NLSN	89162A	P206374	NLSN
	M002119	CASE		M090074	DLEQ	89022A	J024735	NLSN	89096A	P207365	NLSN	89163A	P206375	NLSN
8733	M065071	LKWD	8814	P206333	AP	89023A	P208348	NLSN	89097A	P206400	NLSN	89164A	P206367	NLSN
8734	M060005	LKWD	8815	P206334	AP	89024A	P207286	NLSN	89098A	P207333	NLSN	89165A	P206368	NLSN
87350028	M070028	DFLX	8816	P206335	AP	89025A	J024737	NLSN	89099A	P207335	NLSN	89166A	P206369	NLSN
87350028Q	M070028	DFLX	8821116	P206605	MCII	89025C	P224627	NLSN	89101A	P206340	NLSN	89167A	P206370	NLSN
87350113	M090146	DFLX		P206605	L3COM	89026A	P208364	NLSN	89101C	P206340	NLSN	89168A	P206319	NLSN
87350113Q	M090146	DFLX	8821116REVD	P206605	L3COM	89026C	P224628	NLSN	89102A	P206341	NLSN	89169A	P207401	NLSN
87350345	M090146	DFLX	8821974	P206409	LIBB	89027A	P207287	NLSN	89103A	P206342	NLSN	89170A	P206320	NLSN
87352	X004536	CNLC		P206409	MCII	89028A	J024739	NLSN	89103C	P206342	NLSN	89171A	P206321	NLSN
87352X	X004536	CNLC	88300	P206612	XAIR	89028C	J240024	NLSN	89104A	P206343	NLSN	89172A	P206322	NLSN
87353	X004537	CNLC	88300218	M085207	DFLX	89029A	P208380	NLSN	89104C	P206343	NLSN	89173A	P206323	NLSN
87353X	X004537	CNLC	88306	P206604	XAIR	89029C	J340023	NLSN	89105A	P206344	NLSN	8918	P206526	NH
87354	X004476	CNLC	88316	J009612	XAIR	89030A	P207292	NLSN		P206344	FTGD	89180A	P207389	NLSN
87354X	X004476	CNLC	88350	P206613	XAIR	89030C	P207317	NLSN	89105C	P207345	NLSN	89181A	P206324	NLSN
87355	X004538	CNLC	88356	P206605	XAIR	89031A	P207289	NLSN	89106A	P206345	FTGD	89182A	P206324	NLSN
87355X	X004538	CNLC	884000	P209913	TRUX	89031C	P207300	NLSN		P206345	NLSN	89183A	P207386	NLSN
87356	X004478	CNLC	88400133	M100049	DFLX	89035A	P208330	NLSN	89106C	P206353	NLSN	89184A	P206325	NLSN
87356X	X004478	CNLC	88406	P206606	XAIR	89037A	P206380	NLSN	89107A	P206347	FTGD	89185A	P206326	NLSN
87357	X004480	CNLC	884250191	M065044	DFLX	89037C	P207312	NLSN		P206347	NLSN	89186A	P206327	NLSN
87358	X004482	CNLC	884548	P224636	TRUX	89040A	P208338	NLSN	89107C	P207346	NLSN	89187A	P206328	NLSN
87358X	X004482	CNLC	884550	P209910	TRUX	89042A	P206381	NLSN	89108A	P206348	NLSN	89194U	M001327	NLSN
87359	X004484	CNLC	88456	P210110	XAIR	89043A	J024748	NLSN		P206348	FTGD	89205C	P206390	NLSN
87359X	X004484	CNLC	88487	P207584	XAIR	89043C	J024749	NLSN	89108C	P206354	NLSN	89212A	P216191	NLSN
87380522	P206304	TYLE	88500121	M120131	DFLX	89044A	P208358	NLSN	89109A	P206350	NLSN	89214A	P207281	NLSN
874001	P209912	TRUX	88500428	M120176	DFLX	89044C	P208359	NLSN	89110A	P207322	NLSN	89216A	P207282	NLSN
87400108	M090544	DFLX	88506	P206607	XAIR	89045A	P206382	NLSN	89111A	P207324	NLSN	89217A	P207288	NLSN

Mfgs. No.	Our No.	Mfg. Code	Mfgs. No.	Our No.	Mfg. Code	Mfgs. No.	Our No.	Mfg. Code	Mfgs. No.	Our No.	Mfg. Code	Mfgs. No.	Our No.	Mfg. Code
89217C	P207299	NLSN	89425A	P270534	NLSN	89529W20	X004539	FTGD	89626K	P226153	NLSN	89748A	P206542	NLSN
89218A	P207283	NLSN	89425C	P270534	NLSN	8953	P206313	AP	8963	P206321	TRUX	89749C	X005207	NLSN
89220A	P216197	NLSN	89427A	P270535	NLSN		P206313	TRUX		P206321	AP	8975	P206367	AP
89222A	P208388	NLSN	89430A	P270536	NLSN	89533K	J009614	TRUX	8964	P206322	AP	8976	P206368	AP
89222C	P208389	NLSN	89430C	P271507	NLSN		J009614	NLSN		P206322	TRUX	89761K	P206510	NLSN
89223A	P216206	NLSN	89435A	P270538	NLSN	89534K	P206515	NLSN	89641K	P226149	NLSN	89762K	P206511	NLSN
89226A	P207290	NLSN	89440A	P270539	NLSN	89535K	P206516	NLSN	89642K	P226140	NLSN	89763K	P206512	NLSN
89226C	P207301	NLSN	89440C	P270837	NLSN	89537K	P206520	NLSN	89643K	P226141	NLSN	89766K	P206511	NLSN
89227C	P207302	NLSN	89440E	P270539	NLSN	89538K	P206517	NLSN	89644K	P226142	NLSN	89770K	P206508	NLSN
89231A	P216174	NLSN	89445A	P270540	NLSN	89539K	P206518	NLSN	89645K	P226143	NLSN	89771K	P206509	NLSN
89232A	P216172	NLSN	89450A	P270541	NLSN	8954	P207386	AP	89646K	P226150	NLSN	89775K	P205834	NLSN
89233A	P207325	NLSN	89450C	P270838	NLSN		P207386	TRUX	8965	P206323	AP		P206641	NLSN
89234A	J190013	NLSN	89450E	P270541	NLSN	89540K	P206519	NLSN		P206323	TRUX	89775K20	P206641	FTGD
89235A	J190014	NLSN	89455A	P270542	NLSN	89541K	P206403	NLSN	89660K	P224684	NLSN	8978	P206375	TRUX
89236A	P207366	NLSN	89460A	P270543	NLSN	89542K	P206404	NLSN	89661K	P207367	NLSN	89780A	P206282	NLSN
	P207361	NLSN	89460C	P271511	NLSN	89543K	P206405	NLSN	89662K	P206849	NLSN	89780C	P206285	NLSN
89242A	P207350	NLSN	8947	P207382	TRUX	89544K	P206406	NLSN	89663K	P207368	NLSN	89781A	J190025	NLSN
89243A	P207350	NLSN	89487	M170101	DLTC	89545K	P206407	NLSN	89664K	P206850	NLSN	89781C	P206286	NLSN
89243C	J014621	NLSN	89500117	M120365	DFLX	89546K	P206408	NLSN	89665K	P206851	NLSN	89782A	P207353	NLSN
89244A	P206361	NLSN	89500147	M120225	DFLX	89547K	P206409	NLSN	89666K	P207369	NLSN	89783A	P207354	NLSN
89245A	P206362	NLSN	89500K	J009612	NLSN	89548C	J009486	NLSN	89667K	P206331	NLSN	89784A	P207339	NLSN
89246A	P206363	NLSN	89501K	P206605	NLSN	89548K	P206410	NLSN	89670K	P206331	NLSN	89784C	J009547	NLSN
89247A	P206364	NLSN	89502K	P206605	NLSN	89549C	J009487	NLSN	89671K	P206333	NLSN	8979	P207414	AP
89248A	P206365	NLSN	89503K	P206607	NLSN	89549K	P206411	NLSN	89672K	P206334	NLSN		P207414	TRUX
89249A	P207411	NLSN	89505K	P206604	NLSN	8955	P206314	TRUX	89673K	P206335	NLSN	8982	P226132	AP
89250137	M065065	DFLX	89506K	P206605	NLSN		P206314	AP	89674K	P206336	NLSN		P226132	TRUX
89250137Q	M065065	DFLX	89507K	P206606	NLSN	89550K	P207667	NLSN	89676K	P206338	NLSN	8983	P226133	TRUX
89250A	P206366	NLSN	89508K	J009611	NLSN	89551K	P206521	NLSN	89678K	P206337	NLSN		P226133	AP
89251A	P207413	NLSN	89510K	P210110	NLSN	89556K	P206600	NLSN	89681K	P226140	NLSN	8984	P226148	TRUX
89252A	P207414	NLSN	89511K	P206604	NLSN	89557K	P206601	NLSN	89683K	P206333	NLSN	8985	P226149	TRUX
89253A	J190042	NLSN	89512K	J009613	TRUX	89558K	P206602	NLSN	89685K	P206334	NLSN	89850218	P207540	CASE
89254A	J190044	NLSN		J009613	NLSN	89559K	P206603	NLSN	89686K	P206335	NLSN	8986	P226140	TRUX
89255A	J190045	NLSN	89513K	P206606	NLSN	89559K	P206315	AP	89688K	P206337	NLSN	8987	P226141	TRUX
89256A	J009649	NLSN	89514K	P213191	NLSN		P206315	TRUX	8969	P207394	AP	8988	P226142	TRUX
89257A	P206362	NLSN	89518K	P207784	NLSN	89560K	P207596	NLSN		P207394	TRUX	89881A	J009648	NLSN
89258A	P206363	NLSN	89519K	P206507	NLSN	89566K	P206608	NLSN	89698K	P206338	NLSN	89883A	J009650	NLSN
89259A	P206364	NLSN	8952	P207385	AP	89567K	P206609	NLSN	8970	P206362	TRUX	8989	P226143	TRUX
8925K	J000219	NLSN	89520K	P222018	NLSN	89568K	P206610	NLSN		P206362	AP	89897A	J028528	NLSN
89260A	P206365	NLSN	89521K	X004536	NLSN	89569K	P206611	NLSN	8971	P206363	TRUX	89899A	P224581	NLSN
89261A	P207405	NLSN	89521W	X004536	NLSN	8957	P206316	AP		P206363	AP	8990	P226150	TRUX
89263A	P206371	NLSN	89521W20	X004536	FTGD		P206316	TRUX	89712K	P226129	NLSN	8991	P206369	TRUX
89266A	P207408	NLSN	89522K	J000212	NLSN	89570K	P207598	NLSN	89713K	P226154	NLSN	89910C	P224607	NLSN
89268A	P207382	NLSN	89522W	X004537	NLSN	89571K	J009618	NLSN	89714K	P226155	NLSN	89916A	J640001	NLSN
89270A	P207385	NLSN	89522W20	X004537	FTGD	89573K	P222018	NLSN	89715K	P226157	NLSN	89921C	P224696	NLSN
89271A	P206313	NLSN	89523B	J000211	NLSN	8958	P206317	AP	8972	P206364	AP	89922C	P224703	NLSN
89273A	P207386	NLSN	89523K	X004478	GRMC		P206317	TRUX		P206364	TRUX	89923A	J008681	NLSN
89274A	P206314	NLSN		X004476	NLSN	8959	P206324	AP	89721K	P226132	NLSN	89923C	P224671	NLSN
89275A	P206315	NLSN	89523W	X004476	NLSN	8960	P206319	AP	89722	P226133	NLSN	89924A	J190003	NLSN
89276A	P206316	NLSN	89523W20	X004476	FTGD		P206319	TRUX	89722K	P226133	NLSN	89924C	J190004	NLSN
89277A	P206317	NLSN	89524B	X004538	FTGD	89606K	J024754	NLSN	89723K	P226156	NLSN	89925A	P207330	NLSN
89278A	P206318	NLSN	89524K	P226146	NLSN	89607K	J024835	NLSN	89724K	P226158	NLSN	89926A	P207332	NLSN
89279A	J008942	NLSN		X004538	NLSN	89608K	J034743	NLSN	89726K	J240006	NLSN	89926K	P207365	NLSN
89283A	P207402	NLSN	89524W	X004538	NLSN	89609K	J024755	NLSN	89727K	P206554	NLSN	89940A	P206297	NLSN
89293C	J640005	NLSN		X004538	FTGD	8961	P207401	TRUX	89728K	J024836	NLSN	89940C	P206297	NLSN
89295C	P209913	NLSN	89525B	J000214	NLSN		P207401	AP	89729K	J024836	NLSN	89941A	J092679	NLSN
89296A	P224600	NLSN	89525K	X004478	NLSN	89610K	J024837	NLSN		J034673	NLSN	89950A	P206298	NLSN
89296C	P224600	NLSN	89525W	X004478	NLSN	89611K	J034744	NLSN	8973	P206365	AP	89950C	P206298	NLSN
89298C	P209912	NLSN	89525W20	X004478	FTGD	89612K	J240003	NLSN		P206365	TRUX	89951A	J092689	NLSN
89300139	M085023	DFLX	89526K	X004480	NLSN	89613K	P206552	NLSN	89730K	J240007	NLSN	89955K	P207619	NLSN
89313K	J024755	NLSN	89526W	X004480	NLSN	89614K	J240004	NLSN	89731K	P206555	NLSN	89957K	P207568	NLSN
89350106	M090158	DFLX	89526W20	X004480	FTGD	89615K	J240004	NLSN	89732K	J024838	NLSN	89958K	P207581	NLSN
89354051	M090520	DFLX	89527B	J000216	NLSN	89616K	J240005	NLSN	89733K	J024838	NLSN	89959K	P207567	NLSN
89354055	M090520	DFLX	89527K	X004482	NLSN	89617K	P206553	NLSN		J034674	NLSN	89960K	P207620	NLSN
89400125	M120100	DFLX	89527W	X004482	NLSN	89618K	J024850	NLSN	89736K	P206544	NLSN	89961K	P207566	NLSN
89400153	M090280	DFLX	89527W20	X004482	FTGD	8962	P206320	AP	8974	P207408	TRUX	89962K	J009391	NLSN
8941	P207389	TRUX	89528B	J000217	NLSN		P206320	TRUX		P207408	AP	89964K	P206614	NLSN
	P207389	AP	89528K	X004484	NLSN	89620K	P226151	NLSN	89740K	P206546	NLSN	89965K	P207567	NLSN
89417A	P270531	NLSN	89528W	X004484	NLSN	89621K	P226152	NLSN	89742K	P206547	NLSN	89966K	J009393	NLSN
8942	J008942	TRUX	89528W20	X004484	NLSN	89622K	P226144	NLSN	89744C	P206543	NLSN	89967K	P206615	NLSN
	J008942	AP		X004484	FTGD	89623K	P226145	NLSN	89745C	J009429	NLSN	89969K	P207582	NLSN
89420A	P270532	NLSN	89529K	X004539	NLSN	89624K	P226146	NLSN	89747C	J009429	NLSN	89971K	P207584	NLSN
89422A	P270533	NLSN	89529W	X004539	NLSN	89625K	P226147	NLSN		P206542	NLSN	89973K	P206616	NLSN
										P206540	NLSN			

Cross Reference

(See the first page of this section for the Manufacturer's Code Listing)



CROSS REFERENCE

Mfgs. No.	Our No.	Mfg. Code	Mfgs. No.	Our No.	Mfg. Code	Mfgs. No.	Our No.	Mfg. Code	Mfgs. No.	Our No.	Mfg. Code	Mfgs. No.	Our No.	Mfg. Code
89974K	P206617	NLSN	8NG281072	P271511	AA	90077A	P206524	NLSN	9045722	X007784	WSTI	90875A	J000202	NLSN
89985C	P216202	NLSN	8NG28118	P206407	AST	90079A	P206525	NLSN	9045723	X007785	WSTI	90876A	J000208	NLSN
89986C	P224635	NLSN		P206407	AA	90080A	P206526	NLSN		X007785	FRTL	90877A	J000203	NLSN
89988A	P224709	NLSN		P206407	ASTEC	90092A	J000231	NLSN	90459A			90878A	J000209	NLSN
89988C	P216205	NLSN	8NG28119	P206409	ASTEC	9013928	M120108	GM	90460A	P270538	DYPC	90889A	J190009	NLSN
89989C	P224638	NLSN		P206409	AST		M120108	TREX	90463A	P207340	NLSN	90902K	P224481	NLSN
89990C	P209910	NLSN		P206409	AA	9014271	M090544	WGMC	90464K	J190002	NLSN	90903K	P224479	NLSN
89991C	P224698	NLSN	8NG3100024	M101171	AA	901866	P206347	U C	90465A	J009560	NLSN	90909A	P206304	NLSN
89993C	P216227	NLSN	8NG3100025	M101171	AA	901867	P207289	U C	90466	X004482	MCHC	90909C	J014623	NLSN
89994C	P216228	NLSN	8NG3100026	J009648	AA	901868	P206347	U C	90468K	J009514	NLSN	90910	M090594	RKRM
89996C	J009429	NLSN	8NG3100125	P270539	AA	902353	M090210	U C	90469K	J009516	NLSN	90910A	P224617	NLSN
8A4282	M090544	FMC	8NG48009	J024755	AA	90285	P206334	HRCN	90470K	J009518	NLSN	90910C	P224618	NLSN
8A5098	M085023	CRAN	8NG48010	P226150	AA	90298	P206338	TYLE	90510	P206299	XAIR	90913A	P206311	NLSN
8A5566A	M080024	FMC	8NG60001105	P206556	AA	90300	P224684	DFLX	905154	X004482	U C	90915	M090146	RKRM
8A5810	M120197	FMC	8NG60001106	X004539	AA	903059	M085056	U C	905200	P206300	XAIR	90915K	J000222	NLSN
8A6256	M100464	FMC	8NG80007	P206543	AA	90354A	X007833	NLSN	90521K	P226151	NLSN	90916K	J000221	NLSN
	M100464	LKBT	8NG800071	P206509	AA		J009604	NLSN	90527K	J009612	NLSN	90917	M090074	RKRM
8A6256A	M100464	FMC	8XD448	M090544	RKRM	90355A	X007834	NLSN	90528K	J009611	NLSN	90929K	J000220	NLSN
8C1110	P207596	CAT					J009605	NLSN	90529K	J009613	NLSN	90945	M090781	RKRM
8C8123	M085078	RYGO					X006204	NLSN	90532A	P205979	NLSN	90958A	P207330	NLSN
	M085078	CAT				90356A	J009606	NLSN	90533A	P206299	NLSN	90975A	J018110	NLSN
	M085078	BABR					X007824	NLSN	90538A	P205976	NLSN	90979A	J038612	NLSN
	M085078	CAT					X006203	NLSN	90539A	P206300	NLSN	90980A	J038611	NLSN
8CL17228	P206517	AA				90357A	J190054	NLSN	90546K	P222740	NLSN	90993	M041714	HRCN
8EG1000403	M101167	AA	900040K	J000224	NLSN	90358A	J009607	NLSN	90547K	P222741	NLSN	90HL70R60	P215307	CASE
8HB463	P206321	OKSH	900041K	J000227	NLSN		X007805	NLSN	90554K	P222742	NLSN	90UH1	P206518	ACFT
8I5743	X007829	TIM	900042K	J000228	NLSN		X006202	NLSN	90560A	J190046	NLSN	910033	P207354	U C
	X004476	BROW	900043K	J000230	NLSN		X006202	FTGD	90561A	J190041	NLSN	9103074	M045193	MOB
	X004476	CAT	900044K	J000232	NLSN	90359A	J190055	NLSN	90562A	P206344	NLSN		M045193	WLDN
8I5746	X004482	BROW	900045K	J000233	NLSN	903604	P206319	U C	90569A	P206615	NLSN	910807	P207283	U C
	X004482	CAT	900046A	J008671	NLSN	90360A	J190056	NLSN	905722	M065034	U C	91083101	M085056	GRDL
	X004482	TIM	900048A	P206339	NLSN	90361A	J190057	NLSN	90589C	P224609	NLSN	91083250	M065034	JLGI
8LT400	M090362	RKRM	900049A	P207335	NLSN	90362A	J190058	NLSN	90593C	P224699	NLSN		M065034	GRDL
8NG1000501	M085056	AA	900050A	P216172	NLSN		X007829	NLSN	90595C	P224605	NLSN		M065034	KLGI
8NG1000503	P206324	AA	900052A	P206340	NLSN	90363A	J190059	NLSN	90597C	P224707	NLSN	91094960	P226140	DTMAG
8NG1000504	X004476	AA	900053A	P224669	NLSN	90364A	J190060	NLSN	90600413	M100146	IR		P226140	MH
8NG100081	P206519	AA	900055A	J008681	NLSN		X007830	NLSN	90600424	M100048	IR	91095	P206399	HRCN
8NG1001506	M091050	AA	900056A	P206344	NLSN	90365A	X007831	NLSN	90600435	X005207	IRT	91096	P207353	HRCN
8NG1001507	P270538	AA	900057A	P207341	NLSN		J190061	NLSN		X005207	IR	91108	P207351	HRCN
8NG1001508	P206342	AA	900058A	P207327	NLSN	90366A	J009623	NLSN	90604C	P224707	NLSN	91109	P207322	HRCN
8NG1001602	P207322	AA	900059A	P206346	NLSN		X007784	NLSN	90615K	J000127	NLSN	91126	P207366	HRCN
8NG1001604	P270532	AA	900061A	P207332	NLSN	90367A	J190062	NLSN	90624A	P206299	NLSN	9126937	M100213	GM
8NG1001608	M060251	AA	900062A	P207365	NLSN	9036810011	M120235	VMER	90624A	P206299	NLSN	911349	M045237	U C
8NG1002302	M091048	AA	900063A	P207366	NLSN	903682001	P206347	VMER	9063047	M085293	TREX	911613	M170101	U C
8NG1002303	P226145	AA	900064A	P206282	NLSN	9036820011	P206347	VMER	90631	J009631	TRUX	911614	X004539	U C
8NG18000	M085206	AA	900065C	P206283	NLSN	90368A	J009624	NLSN	90691505	M100016	NAT	911615	P2070543	U C
8NG18001	P207362	AA	900066A	P207359	NLSN		X007785	NLSN		M100016	IRT	911616	P207667	U C
8NG18002	P207361	AA	900067A	P207359	NLSN	90369A	X009076	NLSN	906922	M090301	U C	911617	P206559	U C
8NG18003	P207366	ASTEC	900068A	P207352	NLSN		J190063	NLSN	90786	J190003	HRCN	911618	P206338	U C
	P207366	AA	900069A	P207354	NLSN	90372A	P222744	NLSN	9079368	M170101	TREX	911619	P207341	U C
	P207366	AST	900070A	P207354	NLSN	90373A	P222745	NLSN	907996	P207566	U C	911624	P206851	U C
8NG20011105	P206544	AA	900072A	J009631	NLSN	90374A	P222746	NLSN	907997	P206607	U C	91163035	M085056	JLGI
8NG20011107	X005207	AA	900073A	J009632	NLSN	90375A	P222747	NLSN	90822A	P207364	NLSN		M085056	GRDL
8NG20011112	P206362	AA	900074A	J009633	NLSN	90376A	P222748	NLSN	908319T1	X007784	CASE	911733	P206400	HRCN
8NG20011113	P206397	AA	900076A	J009635	NLSN	90377A	P222749	NLSN	908320T1	X007785	CASE	911753	M122300	IR
8NG20011114	P206309	AA	900077A	J009636	NLSN	90378A	P222750	NLSN	90847A	P206344	NLSN		M170101	CABT
8NG2002002	P224628	AA	900078A	J009637	NLSN	90379A	P222751	NLSN	90847C	P207345	NLSN	911778	M090009	CABT
8NG28016	P206340	AA	900080A	J009639	NLSN	90380A	P222752	NLSN	90857K	P224492	NLSN		M090009	IRT
8NG28023	X004484	AA	900081A	J009640	NLSN	90382A	P222753	NLSN	90859A	P207339	NLSN	911782	M070050	CABT
8NG28027	P206602	AA	900082A	J009641	NLSN	90383A	P222754	NLSN	90859C	J009547	NLSN	911784	M070008	IRT
8NG28030	X004482	AA	900085A	J009644	NLSN	90384A	P222755	NLSN	90866A	J000227	NLSN		M070008	CABT
8NG2803035	X004480	AA	900086A	J009645	NLSN	90385A	P222756	NLSN	90868A	J000232	NLSN	911948	P207349	U C
8NG28042	P206410	AST	900089C	P224636	NLSN	90386A	P222757	NLSN	90869A	J000204	NLSN	911949	P207351	U C
	P206410	ASTEC	90009	M085008	RKRM	90387A	P222758	NLSN	90870A	J000205	NLSN	911950	P207324	U C
	P206410	AA	900091A	P224582	NLSN	90410	P205979	XAIR	90871A	J000206	NLSN	911951	P207362	U C
8NG28044	P206411	AA	900098A	J190002	NLSN	90420	P205976	XAIR	90872A	J000207	NLSN	911952	P207326	U C
8NG28080	P207667	AA	90109004004	X007785	MRMN	90438C	J540008	NLSN	90873A	J000200	NLSN	91203058	M045237	GRDL
8NG28081	P207341	AA	90109009003	X007784	MRMN	90439C	P224608	NLSN	90874A	J000201	NLSN	91203087	P206306	GRDL
8NG28090	P206403	ASTEC	90109009004	X007785	MRMN	90441C	P224611	NLSN						
	P206403	AST	901190A	J009479	NLSN	90444A	P224710	NLSN						
	P206403	AA	90139006	P206337	FMNT	90444C	P224641	NLSN						
8NG280908	P206850	AA	900201	P270539	DYPC	90446A	P224711	NLSN						
8NG28091	P206405	AA	900424	M085407	MRBR									
8NG28092	P206333	AA	900426	M085408	MRBR									
			90076A	P206523	NLSN									

Mfgs. No.	Our No.	Mfg. Code	Mfgs. No.	Our No.	Mfg. Code	Mfgs. No.	Our No.	Mfg. Code	Mfgs. No.	Our No.	Mfg. Code	Mfgs. No.	Our No.	Mfg. Code
91233003	M065071	GRDL		J092689	AP	9337	P206397	AP		P270535	DFLX	94507	M120365	RKRM
912361	P206370	U C	92695	P206297	TRUX	9338	P206398	AP	9379	P270535	AP	9451	P206510	TRUX
91267	P206346	HRCN	92696	P206298	TRUX	9339	P206399	AP	9381	X004536	TRUX		P206510	AP
	P206346	GRST	92697	P206298	TRUX	9340	P206400	AP		X004536	GOE	9452	P206511	TRUX
91279	J009649	HRCN	927002	P206851	TRUX	934001	P205976	DFLX		X004536	AP		P206511	AP
	J009649	GRST	92701012391	M090158	GRVE	9341	P205979	TRUX	9382	X004537	AP	9453	P206512	TRUX
91301	M065030	GNRC	9270102391	M090158	GRVE	9342	P206299	GOE		X004537	TRUX		P206512	AP
9141094	P206546	VLVO	9275	P270535	HDMI	934270	X004484	IVECO		X004537	GOE	945530011	P270541	VMER
91410944	P206546	VLVO		P270535	XAIR	934285	X004482	IVECO	9383	X004476	AP	9456	P206508	AP
91410947	P206546	VLVO	92794437	H001035	IR	934286	X004480	IVECO		X004476	TRUX		P206508	TRUX
91413140	P206371	JLGI	928002	P207369	TRUX	9343	P205976	TRUX	9384	X004478	AP	94569	P206602	CMI
9150	P270530	ECS	9283113008	M122300	EIMC	9343	P205976	TRUX		X004478	TRUX	9457	P206509	GOE
9155711	P206546	VLVO	9284749	M100146	GRVE	9344	P206300	TRUX		X004478	TRUX		P206509	AP
91557116	P206546	VLVO	929002A	P206331	NLSN	9345	P206617	AP	9385	X004480	TRUX	9458	P206543	TRUX
916833	X004482	U C	929004A	P206333	NLSN	9346	P206616	AP		X004480	AP	945946	X004484	TREX
916834	P206346	U C	929005A	P206333	NLSN	934766	X005207	IVECO		X004480	GOE		X004484	OK
916864	P206346	U C	929006A	P206334	NLSN	9350	P270538	HDMI	9386	X004482	GOE	946100325	P206280	RSCC
9186262	P206546	VLVO	929007A	P206336	NLSN		P270538	XAIR		X004482	TRUX		P206280	BRLEE
9186269	J000220	GDLS	929014K	P206333	NLSN		P270538	ECS		X004482	AP	9470	P207619	AP
91910	M090594	RKRM	929015K	P206334	NLSN	935001	P206300	DFLX	9386890	X004484	KRON		P207619	GOE
919206	P208394	U C	929022K	P206335	NLSN	9350Z	P270538	HDMI	9386900	P208374	KRON		P207619	TRUX
9200	P270532	HDMI	929023K	P206336	NLSN	9354	P206515	TRUX	9386910	J190003	KRON	9472	P207582	AP
	P270532	XAIR	929024A	J000127	NLSN	9355	P206516	TRUX	9386920	M100213	KRON	9473	P207581	TRUX
920007402	M065044	CASE	929025A	P206334	NLSN	935598	P270838	IVECO	9387	X004484	AP	9474	P207581	AP
920018271	P206409	CASE	929026A	P206335	NLSN	9357	P206518	TRUX		X004484	GOE	9474	P206614	AP
920018376	P206407	CASE	929027A	P206336	NLSN	9357	P206518	TRUX	9388	X004539	AP		P206614	TRUX
920019350	P206408	CASE	929030A	P206335	NLSN		P206518	AP		X004539	GOE	9474Q	P206614	AP
920019377	P206406	CASE	929034S	P224685	NLSN		P206518	AP		X004539	TRUX	9475	P207567	AP
920019473	M001702	NH	929035S	P224686	NLSN	9358	P206519	TRUX	9389	X004538	GOE	9476	P207620	TRUX
920019547	M001502	NH	929036S	P224687	NLSN		P206519	AP		X004538	AP	9476	P207620	AP
920019550	M001756	NH	9300	P270536	XAIR	9359	P206521	AP	9390	X004538	TRUX	9478	P206615	TRUX
920034AA	J009604	SKYJ	9300CP	P271507	HDMI		P206521	TRUX		P206612	AP	9478	P206615	TRUX
9202940451	M100146	EIMC	9303	P207335	AP	935952	M090091	IVECO	9391	P206612	TRUX	9479	P206615	AP
920507	P207282	U C	9304	P206341	AP	9360	P206520	AP		J009391	AP	9479	J009479	TRUX
9206602	P206602	NEWFLY	9305	P206343	AP		P206520	TRUX		J009391	TRUX		J009479	AP
9206960019	P270540	KLMA	9306	P206345	AP	93610450	X004478	DMAG	9392	P207568	AP	9486	J009486	TRUX
921097	P206409	DYPC	9308	P206348	AP		X004478	KTSU		P207568	TRUX		J009486	AP
921098	P206604	DYPC	9308052	P226146	ELGN	93610500	P206409	MH	9393	J009393	TRUX	9487	J009487	TRUX
9214205	M100016	TREX	9308053	X004482	ELGN		P206409	KTSU		J009393	AP		J009487	TRUX
	M100016	VME	9309	P206349	AP		P206409	DMAG	9394	P207566	TRUX	9490	P206608	TRUX
9218031	M090095	TREX	9310	P206350	AP	936203	M120189	IVECO		P207566	AP		P206608	AP
	M090095	VME	9312	P206279	AP	9363	P206523	TRUX	9395	P206604	TRUX	9491	P206609	TRUX
	M090095	ECLD	9313	P206280	AP		P206523	AP		P206604	AP	9492	P206609	AP
921989	M045237	DYPC	931359AA	M060055	SKYJ	9364	P206524	AP	9396	P206605	AP	9492	P206610	TRUX
921997	P206301	DYPC	9314	P206281	AP		P206524	TRUX		P206605	TRUX		P206610	AP
92234	P206321	HRCN	9314C094115	X004480	ENTW	9365	P206525	AP	9397	P213191	AP	94927	P207394	CMI
9225	P270533	HDMI	9314C094120	P206408	ENTW		P206525	TRUX		P213191	TRUX	9493	P206611	AP
	P270533	XAIR	9315	P206282	AP	9366	P206526	TRUX	9398	P206604	AP	9495	P206611	TRUX
922701	P270536	U C	9317	P206283	AP		P206526	AP		P206604	TRUX		P206611	TRUX
9228310001	X004537	KLMA	9318	P207350	AP	93671042	M090210	GRDL	9399	P206606	TRUX	9500	P207598	TRUX
9228310002	X004538	KLMA	931900	P226142	SAME	9368	P270542	AP		P206606	AP		P207598	AP
9228310004	X004482	KLMA	931SA0393	M120100	CLRK		P270543	AP	9400	P206606	TRUX	9500	P207598	AP
9228310005	X004480	KLMA	931SA185	M120100	CLRK	9369	P270543	TRUX		P206606	TRUX	9500CP	P270838	HDMI
923002	P224684	TRUX	931SB0393	M090072	CLRK		P270543	TRUX	94006	M100049	RKRM	9500Z	P270541	HDMI
924002	P207367	TRUX	932367	M080024	IVECO	9370	P270533	AP	94007	M090538	RKRM	9501	P206600	AP
924465	P207331	U C	9329	P207363	AP		P270533	TRUX	9400CP	P270837	HDMI		P206600	TRUX
924466	P207365	U C	9330	P207361	AP	9371	P270532	TRUX		P270539	HDMI	9502	P206601	AP
9250	P270534	XAIR	9330C09102101	P206410	ENTW		P270532	TRUX	9400Z	P270539	HDMI	950250016	M045237	EIMC
	P270534	HDMI	9331	P206328	AP	9372	P270534	TRUX	9406	P206353	AP	9503	P206602	TRUX
925002	P206849	TRUX		P206328	TRUX		P270534	AP	9408	P206354	AP		P206602	AP
925262AA	M085056	SKYJ	9332	P206327	TRUX	9373	P270536	TRUX	94238001	P270539	VMER	9504	P206603	AP
925502	P207368	GOE		P206327	AP	9374	P270538	TRUX	942380011	P270539	VMER		P206603	TRUX
	P207368	TRUX	9333	P206325	AP		P270538	AP	94286	P207359	CMI	9506	P207596	TRUX
926002	P206850	TRUX		P206325	TRUX	9375	P270539	TRUX	9429	J009429	WLKR		P207596	AP
926123	P270531	HSTR	9334	P206339	AP		P270539	AP		J009429	AP	9514	J009514	TRUX
9265	P207352	AP	9335	P206318	AP	9376	P270540	TRUX	9430	P206641	TRUX		J009514	AP
92659	M080018	DRSS		P206318	TRUX		P270540	AP	94307	M085008	RKRM	9516	J009516	AP
	M080018	KTSU	9336	P207402	TRUX	9377	P270541	AP		X004536	OK		J009516	TRUX
92673	P206297	TRUX		P207402	AP		P270541	TRUX	944130	X004536	TRUX	9518	J009518	AP
92674	P206298	TRUX	93368	P206321	CRMY	9378	P270535	TRUX	9450	P270540	HDMI		J009518	TRUX
92679	J092679	TRUX		P206321	TRUX		P270535	AP		P270540	ECS	9531	P207322	AP
92689	J092689	TRUX												

Cross Reference

(See the first page of this section for the Manufacturer's Code Listing)



CROSS REFERENCE

Mfgs. No.	Our No.	Mfg. Code	Mfgs. No.	Our No.	Mfg. Code	Mfgs. No.	Our No.	Mfg. Code	Mfgs. No.	Our No.	Mfg. Code	Mfgs. No.	Our No.	Mfg. Code
9532	P207324	AP		P210110	AP	9698	X007824	GOE	99487900034	X004482	FXBL	A04106170	M090544	FRTL
9533	P207325	AP	9617	J009614	TRUX	9699	X007805	GOE	9949979	M090544	KOEH	A04106171	M090544	FRTL
9534	P207326	AP	9618	J009618	TRUX	9701300001	M090535	BRED	997722C1	M090538	NAVI	A0410618	M100464	FRTL
9535	P207327	AP		J009618	AP	9704	P270542	TRUX	998025C1	M085171	NAVI	A04106180	M090544	FRTL
9536	P207328	AP	9620	P206344	AP	9706292	X007824	NH	998580	M090544	VLVO	A04106181	M100464	FRTL
9537	P207329	AP	96206	P207402	CMI		X007824	VSTL		M090544	WGMC	A0410879	M090535	FRTL
9538	P207330	AP	96207	M120751	CMI	9706293	X007785	CASE	9989101A	P206340	ENGN	A04108790	M090535	FRTL
9539	P206346	AP	96208	P206365	CMI		X007805	NH	9990000767	P206602	BIAM	A04108791	M090535	FRTL
9540	P207331	AP	96223	M001505	CMI	9706674	P207298	NH		P206602	ONTB	A04109610	M100464	FRTL
9541	P207332	AP	9623	X007784	TRUX		P207298	VSTL	9999	M060251	TMCO	A04114470	M100464	FRTL
9542	P206349	AP	9623618	P206407	MCII	9707490	P207297	NH	99M090362	M090362	HARLEY	A041144700	M100464	FRTL
9545	P207345	AP	9624	X007785	TRUX		P207297	VSTL	99M100464	M100464	HARLEY	A04114471	M100464	FRTL
9546	P207346	AP	9628	P224841	TRUX	9713	P207582	TRUX	9F6433	M120100	CAT	A04116940	M100465	FRTL
9547	J009547	AP	9629	J009629	TRUX	9714	P207567	TRUX	9H0047	M120100	LKBT	A04116941	M100464	FRTL
9550	P270542	HDMI		J009629	AP	9715	P207584	AP		M120100	FMC	A04117170	M100463	FRTL
9554	P206347	AP	9630	X004962	GOE		P207584	GOE	9H0547	P207339	LKBT	A04117171	M100463	FRTL
9557	P207339	AP		X004962	TRUX	9722	P206326	TRUX	9H0554	M090538	FMC	A04118400	M100465	FRTL
9559	P207354	AP	9631	J009631	AP	972204010	P206336	BOSS		M090538	LKBT	A0411843	M100465	FRTL
9560	J009560	AP	9632	J009632	AP	972303010	P206334	BOSS	9H47	M120100	FMC	A04118430	M100465	FRTL
9561	P207347	AP	9633	J009633	AP	972335010	P206335	BOSS	9H554	M090538	FMC	A0412094	M100465	FRTL
9562	P207349	AP	9635	J009635	AP	9724	P206512	TRUX	9HB910	M100463	OKSH	A04120940	M100465	FRTL
9563	P207350	AP	9636	J009636	AP	9725	P206511	TRUX	9LT400	M090362	RKRM	A0412096000	X007785	MERS
9564	P207351	AP	9637	J009637	AP	9726292	X007824	VSTL	9LT500	M090072	RKRM	A0412096001	X007784	MERS
9566	P207353	AP	9639	J009639	AP	9730	M190060	TRUX	9N8185	M190002	CAT	A04122700	M100463	FRTL
9567	P207354	AP	9640	J009640	AP	9731	J190061	TRUX	9N8198	M065044	CAT	A04125560	M100465	FRTL
9571	P271507	TRUX	9641	J009641	AP	9732	J009623	TRUX		M065044	RYGO	A0412966	M100465	FRTL
	P271507	AP	9642100072	M100464	MTWVC	9733	X007785	TRUX	9S0038	P208326	CAT	A04129660	M100465	FRTL
9573	P270837	AP		M100464	GRVE	97342400232	M120108	FXBL	9S200	P270532	HDMI	A04129660	M100465	FRTL
	P270837	TRUX	9642100076	M085078	GRVE	9737	J009612	TRUX	9S225	P270533	HDMI	A04140750	M100580	FRTL
9575	P270838	TRUX		M085078	MTWC	97496413	P206409	IVECO	9S250	P270534	HDMI	A0414075000	M100580	FRTL
	P270838	AP	9644	J009644	AP	97926300001	M120189	UCP	9S275	P270535	HDMI	A04164220	M120365	MERS
9577	P271511	AP	9645	J009645	AP		M120189	FXBL	9S300	P270536	HDMI	A0416422000	M120365	CAT
9581	P206521	TRUX	9648	J009648	AP	979541R91	M090544	NAVI	9S300CP	P271507	HDMI	A0416704002	M110311	MERS
9587	P206617	GOE		J009648	TRUX	97977600026	P206403	FXBL	9S350	P270538	HDMI		M110311	FRTL
	P206617	TRUX	9649	J009649	TRUX	97977600238	P210110	FXBL	9S400	P270539	HDMI	A0495200	P206410	FRTL
	P206617	AP		J009649	AP	9798	P206511	TRUX	9S400CP	P270837	HDMI	A0534253	P206403	WTLK
9598	P206367	GOE	964L1	M085008	WGMC	9799	P206512	TRUX	9S450	P270540	HDMI		P206403	AECW
	P206367	AP		M085008	DLEQ	980001350	X004539	GAME	9S500	P270541	HDMI		P206403	AECW
9599	P207281	TRUX	9650	J009650	AP	980011834	J190045	GAME	9S500CP	P270838	HDMI	A0534254	P206409	WTLK
9600	P270543	HDMI	9652	P222018	TRUX	9801	P206508	TRUX	9S550	P270542	HDMI	A0546090	P206405	AECW
	P206324	AP	9653	P222018	TRUX	9803	P206509	TRUX	9S600	P270543	HDMI	A0574901CJ	P213191	ONTB
	P270543	XAIR	9656	J009611	TRUX	9804	P206508	TRUX	9S600CP	P271511	HDMI		P213191	BIAM
	P206324	TRUX	96600512	M060037	GRDL	9805	P206510	TRUX	9XD354	M085008	RKRM	A07849P05	M120108	GRDL
	P206324	GOE	9664	J190056	TRUX	9806	P206511	TRUX	9XD358	M090146	RKRM	A118960	J190062	MNTW
9600CP	P271511	HDMI	9665	J190057	TRUX	9807	P206512	TRUX	9XD400	M090544	RKRM		J190062	MTWVC
96014149	P206327	DLTC	9666	X007829	TRUX	9810	P224492	TRUX	9XD403	M090544	RKRM	A118960	J190054	MNTW
96028649	P207667	DLTC	9667	J190059	TRUX	9811	P205834	TRUX	9XD404	M090544	RKRM	A1204214	M100464	PETTI
9604	J009604	TRUX	9668	X007830	TRUX	982438003	X004539	CMPR	9XD405	M090544	RKRM	A1204227	M090535	PETTI
	X007824	AP	9669	X007831	TRUX	982438004026	P207596	CMPR	9XD408	M090544	RKRM	A1204265	M120225	PETTI
96047289	X007784	DLTC	9670	J190062	TRUX	9824380090004	X004476	CMPR	9XD448	M090544	RKRM	A1204277	M120365	PETTI
96047309	P226155	DLTC	9671	X009076	TRUX	9824380090006	X004478	CMPR	9XD500	M090074	RKRM	A134171	X004478	AMHO
96047569	P206410	DLTC	9673152	M001702	CASE	9824380090009	X004480	CMPR	9XD505	M090074	RKRM	A135428	M060037	GRVE
9605	J009605	TRUX		M001702	NH	9837	M070028	CRMY	9XD508	M090535	RKRM		M060037	Marine
	J009605	AP		M001702	KBCO	98423	M065065	CRMY	9XD508W	M090535	RKRM		M060037	MTWC
96057001	M065044	VMER	9674	P222744	TRUX	985250008	M080018	EIMC	9XD548	M090074	RKRM		M060037	SHUT
960570011	M065044	VMER	9675	P222745	TRUX	985250008	M080018	EIMC	9Y0176	P206407	CAT		M060037	CASE
9606	J009606	AP	9676	P222746	TRUX	986055	M060158	CHAMP	9Y0177	P206408	CAT	A135430	M070068	CASE
	X007824	TRUX	9678	P222747	TRUX	986063	P207596	CHAMP	9Y1561	X004484	CAT	A139977	X004482	LRAN
9607	X007805	AP	9680	P222748	TRUX	9896	P270530	TRUX	9Y3815	M001502	CAT	A14105	P206601	IR
	X007805	TRUX	9681	P222749	TRUX	9897	P270531	TRUX	9Y8315	M001502	CAT	A14105X1	P206602	IR
9610	J009612	TRUX	9682	P222750	TRUX	990023	X004478	TPORT				A141843	X004480	LRAN
	J009612	AP	9683	P222751	TRUX	9901	P222748	AP				A147178	X004482	MCC
9611	J009611	AP	9684	P222752	TRUX	9913	P206403	AP					X004482	CASE
	J009611	TRUX	9686	P222753	TRUX	9914	P206404	AP	A004482	X004482	CRAN	A14789	X004476	IR
9612	J009612	AP	9687	P222754	TRUX	9915	P206405	AP	A017851	P206409	CASE	A162292	X004484	CASE
	P206604	TRUX	9688	P222755	TRUX	9921	M100464	DREO	A0409520000	P206410	FRTL	A1636	P206303	SAKR
9613	J009613	TRUX	9690	P222756	TRUX	9921L1	M090535	DREO	A0410342	M090535	FRTL	A166072	P207397	ELECT
	J009613	AP	9692	P222757	TRUX	9921L11	M090544	DREO	A04103420	M090535	FRTL	A173381	M001703	CASE
9614	J009614	TRUX	9693	P222758	TRUX	9921L12	M100464	DREO	A0410561	M100464	FRTL	A17851	P206409	CASE
	J009614	AP	9694	P222759	TRUX	9941436	J190003	ENGN	A04105610	M100464	FRTL		P206409	MJPR
9615	P206607	TRUX	9696	X007784	GOE	9948	P206331	ICAB	A04105620	M090544	FRTL	A19563	M070008	CASE
	P206607	AP	9697	X007785	GOE	994819	X004536	TKNG	A0410617	M090544	FRTL	A199510	P206509	GRVE
96156	M080018	JNDR											P206509	MNTW
9616	P210110	TRUX												

Mfgs. No.	Our No.	Mfg. Code	Mfgs. No.	Our No.	Mfg. Code	Mfgs. No.	Our No.	Mfg. Code	Mfgs. No.	Our No.	Mfg. Code	Mfgs. No.	Our No.	Mfg. Code	
A200.....	P207415	RKRM	A40036.....	P208366	RKRM	AA300.....	P206309	RKRM	AD404.....	P206617	RKRM			P207367	PDCI
A2036926.....	P206411	CASE	A40036PL.....	J034746	RKRM	AA30024.....	P208330	RKRM	AD455.....	P207582	RKRM	AT4863.....	M120100	GRDL	
	P206411	PTN	A40048.....	P207295	RKRM	AA30048PL.....	P207312	RKRM	AD500.....	P206615	RKRM	AT500.....	P206849	RKRM	
A20AF.....	J000205	TORCA	A40048PL.....	P207320	RKRM	AA33992.....	M090544	HRSN	AD506.....	P206615	RKRM			PDCI	
	J000204	TORCA	A40060.....	P207290	RKRM	AA350.....	P206310	RKRM	AE12380.....	P206303	XMN	AT550.....	P207368	PDCI	
A21464.....	M065071	CASE	A40060PL.....	P207301	RKRM	AA35024.....	J024748	RKRM		P206303	AMC			P207368	RKRM
A215675.....	M120100	JOY	A40072PL.....	P216202	RKRM	AA35024PL.....	P206385	RKRM	AE15200.....	P206303	AMC	AT55914.....	X004480	JNDR	
A22AF.....	J000205	TORCA	A400PL.....	P207308	RKRM	AA35036.....	P208358	RKRM		P206303	XMN	AT600.....	P206850	RKRM	
A2300003.....	M120131	UPTI	A40801.....	M090009	ROUS	AA35036PL.....	P208359	RKRM	AE20595.....	P206407	JNDR	AT6501101.....	M100016	HRSN	
A23000030001.....	M120131	UPTI		M090009	DACR	AA35048.....	P206382	RKRM		P206407	CMCO			M100016	CABT
A2300003A001M120131.....	UPTI		A40AF.....	J000202	TORCA	AA35048PL.....	P206386	RKRM	AE20595P221454P206407.....	JNDR		AT650111.....	M100016	HRSN	
A2300051001.....	M090823	UPTI	A41210A.....	P206344	EAGL	AA400.....	P206311	RKRM	AE20601.....	M085023	JNDR	AT65079.....	X004480	JNDR	
A2318028.....	M085023	PETTI	A41212A.....	P206344	EAGL	AA40024.....	J024748	RKRM	AE31390.....	P206343	XMN	AT700.....	P206851	RKRM	
A2318037.....	M085008	PETTI	A41818A.....	P206345	EAGL	AA40024PL.....	J024749	RKRM		P206343	AMC	AT800.....	P207369	RKRM	
A2318051.....	M090544	PETTI	A4194907045.....	P2070536	FRTL	AA40036.....	P208358	RKRM	AE56777.....	P206601	JNDR	AU100240.....	M101169	AST	
A2320050001.....	M001505	UPTI	A4194927029.....	M070068	FRTL	AA40036PL.....	P208359	RKRM	AE56778.....	P206602	CMCO			M101169	ASTEC
A23476.....	M065071	CASE	A42229.....	M065030	CASE	AA40048.....	P206382	RKRM		P206602	JNDR	AU100263.....	M002121	AST	
A2350040001.....	P222017	UPTI		M065030	MCC	AA40048PL.....	P206386	RKRM	AEC03276B.....	M120365	OBIL			M002121	ASTEC
A2350179001.....	M001865	UPTI	A44332.....	P206343	AMC	AA40060.....	P208388	RKRM	AEM001327.....	M001327	PBLT	AU100265.....	P206311	ASTEC	
A2350217001.....	M002164	UPTI		P206343	XMN	AA40060PL.....	P208389	RKRM	AF5108.....	P206546	XMN			P206311	AST
A2370001001.....	M100016	UPTI	A45AF.....	J000208	TORCA	AA40072PL.....	J064005	RKRM		P206546	AMC	AU100481.....	P208386	AST	
A2416.....	P206546	SAKR	A4957.....	M085023	CRAN	AA40096PL.....	P209913	RKRM	AF9844901.....	X004962	RVI			P208386	ASTEC
A24314.....	M065071	CASE	A500.....	P206305	RKRM	AA400PL.....	P206384	RKRM	AG059617.....	M001432	AGCO	AU100482.....	M101170	ASTEC	
A250.....	P206301	RKRM		X006202	AP	AA400PL.....	P206384	RKRM	AG123684.....	M120235	AGCO			M101170	AST
A250179001.....	M001865	UPTI		X006202	TRUX	AA500.....	P206312	RKRM		M120235	AGEM	AU100484.....	J008681	ASTEC	
A2522.....	P206343	SAKR		X006202	GOE	AA50024.....	J024751	RKRM	AG123921.....	P208392	AGCO			J008681	AST
A25AF.....	J000206	TORCA	A50024.....	J024747	RKRM	AA50036.....	P208374	RKRM	AG126501.....	M002123	AGCO	AU100771.....	P206546	ASTEC	
A275.....	P206927	RKRM	A50024PL.....	J024758	RKRM	AA50036ALZ.....	P208374	RKRM	AG126558.....	M001668	AGCO			P206546	AST
A27AF.....	J000207	TORCA	A50036.....	P216204	RKRM	AA50036PL.....	P216204	RKRM	AG418A.....	P208386	EAGL	AU100772.....	P206602	ASTEC	
A300.....	P206302	RKRM	A50036PL.....	P216204	RKRM	AA50048.....	P206383	RKRM	AG418K.....	P208386	EAGL			P206602	AST
	X004478	TRUX	A50048.....	P207296	RKRM	AA50048ALZ.....	P206383	RKRM	AG514228.....	M085078	AGCO	AU103095.....	P206304	ASTEC	
A30024.....	P208326	RKRM	A50048PL.....	P207321	RKRM	AA50048PL.....	P206387	RKRM	AG514354.....	X004538	AGCO			P206304	AST
A30024PL.....	P207318	RKRM	A50060PL.....	P207302	RKRM	AA50060.....	P208394	RKRM	AG518A.....	P208392	EAGL	AU103151.....	M090594	ASTEC	
A30036.....	P208326	RKRM	A50072PL.....	P216205	RKRM	AA50060ALZ.....	P208394	RKRM	AG522580.....	P207282	AGCO			M090594	AST
A30048.....	P207293	RKRM	A50084PL.....	P209912	RKRM	AA50060PL.....	P208395	RKRM	AG522726.....	P206409	AGCO	AU103152.....	M002120	AST	
A30048PL.....	P207318	RKRM	A50096.....	P209910	RKRM	AA50060PL.....	P208395	RKRM	AG522729.....	M001503	AGCO			M002120	ASTEC
A300PL.....	J014621	RKRM	A50096PL.....	P209910	RKRM	AA50072.....	P224600	RKRM	AG524K.....	J024751	EAGL	AU104372.....	M002118	AST	
A306.....	P206303	UNVL	A500PL.....	P207309	RKRM	AA50096PL.....	P209912	RKRM	AG524K.....	J024751	EAGL			M002118	ASTEC
A30AF.....	J000200	TORCA	A500PL.....	P207309	RKRM	AA500PL.....	P206385	RKRM	AG536K.....	P208375	EAGL	AU104419.....	P206301	AST	
A31191.....	M120235	HDMI	A500Q.....	X006202	AP	AA600.....	P207419	RKRM	AG555185.....	P206407	AGCO			P206301	ASTEC
A312.....	X006204	TRUX	A503A.....	P207339	EAGL	AB3511K.....	J014622	EAGL	AG605405.....	M090544	AGCO	AU104420.....	M001756	AST	
	X006204	GOE	A508A.....	P207339	EAGL	AB418A.....	P206384	EAGL	AH6019.....	M090538	FMC			M001756	ASTEC
	X006202	GOE	A508K.....	J009547	EAGL	AB518A.....	P207298	EAGL	AI1000.....	P206519	EAGL	AU104421.....	M065142	ASTEC	
	X006204	AP	A50AF.....	J000203	TORCA	AB518K.....	P207309	EAGL	AI400.....	P206525	EAGL			M065142	AST
A3345404.....	M100043	AUXI	A51515A.....	P206347	EAGL	AB524K.....	J024758	EAGL	AI900.....	P206518	EAGL	AU104425.....	X007829	AST	
A350.....	P206303	RKRM	A51515K.....	P207346	EAGL	ABPN3535PLA.....	J009605	ALP	AJ40A.....	P206336	EAGL			X007829	AST
	P206303	RYCO	A52020A.....	P206348	EAGL	ABPN3540EST.....	J000216	ALP	AJ50A.....	P206337	EAGL	AU105143.....	M090280	ASTEC	
	P206303	VIC	A5540.....	X007785	CRAN	ABPN3540PLA.....	J009606	ALP	ALG9047.....	J190059	AFC			M090280	AST
A35036.....	P208350	RKRM	A5544.....	X007829	CRAN	ABPN3540PLB.....	P222740	ALP	AP41818A.....	P207329	EAGL	AU106006.....	M045193	ASTEC	
A35036PL.....	P216200	RKRM	A5544.....	X004538	CRAN	ABPN3540PLB.....	P222740	ALP	AP51515K.....	J190019	EAGL			M045193	AST
A35048PL.....	P207319	RKRM	A5545.....	X007830	CRAN	ABPN3550EST.....	J000217	ALP	AP52020A.....	P206349	EAGL	AU106185.....	M001702	ASTEC	
A350PL.....	J014622	RKRM	A5546.....	X007831	CRAN	ABPN3550PLA.....	J009607	ALP	AR70100.....	P206411	JNDR			M001702	AST
A35108.....	P206546	PUPR	A5547.....	X007784	CRAN	ABPN3550PLB.....	P222741	ALP		P206411	CMCO	AU106186.....	M001593	ASTEC	
A35AF.....	J000201	TORCA	A5548.....	X004539	CRAN	ABPN3550PLS.....	J009624	ALP	AS25A.....	J000206	GRMC			M001593	AST
A36280.....	M070050	DACR	A56029.....	M070028	CASE	AC412.....	P206374	EAGL	AS2A.....	J000204	GRMC	AU106262.....	P207295	ASTEC	
A3764910140.....	P206521	FRTL	A600.....	P207559	RKRM	AC504.....	P206375	EAGL	AS300.....	J000200	AP			P207295	AST
A3764910240.....	P206519	FRTL	A602499001.....	P207332	VMER	ACU5266.....	X004478	ROVR	AS350.....	J000201	AP	AU106263.....	M001503	AST	
A3764920159.....	P206554	FRTL	A60AF.....	J000209	TORCA		X004478	MULTI	AS35A.....	J000201	GRMC			M001503	ASTEC
A3764920259.....	P206555	FRTL	A6290.....	M101170	GNRC		X004478	UNIP	AS3A.....	J000200	GRMC	AU106905.....	P206304	ASTEC	
A3764920640.....	X007785	FRTL	A6814910400.....	M120448	FRTL		X004478	LEYL	AS400.....	J000202	TRUX			P206304	AST
A3764921340.....	X007784	FRTL	A7471.....	P206303	XMN	ACU5267.....	X004480	MULTI		J000202	AP	AU109775.....	M085409	AST	
A3764921440.....	P206602	FRTL		P206303	AMC		X004480	UNIP	AS4A.....	J000202	GRMC			M085409	ASTEC
A3764921940.....	X007830	FRTL	A8593386.....	X006203	RNDR		X004480	ROVR	AS500.....	J000203	AP	AU110235.....	M002119	ASTEC	
A3764922104.....	P206311	FRTL	A8596162.....	P226148	RNDR		X004480	LEYL		J000203	TRUX			M002119	AST
A3764922204.....	P208388	FRTL	A859672.....	P206403	RNDR	AD300.....	P207619	RKRM	AS5A.....	J000203	GRMC	AU110242.....	P208330	AST	
A3764922604.....	P207290	FRTL	A8599673.....	X004536	RNDR	AD302.....	P206612	RKRM	ASKS191521.....	M080024	HSTR			P208330	ASTEC
A3964920040.....	X004480	MERS	A8599674.....	P206306	RNDR	AD308.....	J009393	RKRM	ASKS477902.....	M060037	HSTR	AU110244.....	J009604	AST	
A400.....	P206304	RKRM	A8605649.....	P2070543	RNDR	AD351.....	P206605	RKRM	AT10646.....	M045237	JNDR			J009604	ASTEC
	X006203	AP	A8605660.....	X004539	RNDR	AD352.....	P206613	RKRM	AT177974.....	M001702	JNDR	AU110306.....	P206379	AST	
	X006203	GOE	A8891.....	M060250	GNRC	AD354.....	P207582	RKRM		M001702	CMCO			P206379	ASTEC
	X006203	TRUX	AA200.....	P206306	RKRM	AD358.....	P207581	RKRM	AT182928.....	M001503	JNDR	AU110479.....	P207394	ASTEC	
A40024.....	J024746	RKRM	AA2												

Cross Reference

(See the first page of this section for the Manufacturer's Code Listing)



CROSS REFERENCE

Mfgs. No.	Our No.	Mfg. Code	Mfgs. No.	Our No.	Mfg. Code	Mfgs. No.	Our No.	Mfg. Code	Mfgs. No.	Our No.	Mfg. Code	Mfgs. No.	Our No.	Mfg. Code
AU111497	P206370	AST	B50SA	P222759	TORCA	C28A1475	M100463	CCML	CB01487844	M002117	CMCO	D0HT5225CLA	M100465	FMCO
	P206370	ASTEC	B600	J000218	TRUX	C27A5230A	M100049	FMCO	CB11472557	X006202	CMCO	D0HZ5230F	M120135	FMCO
AU111507	P206370	ASTEC		J000218	AP	C27Z5230A	M100049	FMCO	CDD000009	X004482	CUMS	D0HZ5230J	M090538	FMCO
	P206370	AST	B60AA	P222751	TORCA	C300	P206544	RKRM	CDD000010	X004484	CUMS	D0HZ5230K	M120135	FMCO
AU111640	P206400	AST	B7T5230A	M060232	FMCO	C3440411	M080024	PTN	CDD000012	M120100	CUMS	D0HZ5230L	M090074	FMCO
	P206400	ASTEC	B8091034	P206407	ESSEX		M080024	CASE	CDD000013	M120235	CUMS	D0HZ5230N	M120154	FMCO
AU111836	J000221	AST	BACU5261	X004480	ROVR	C350SS	P206544	RKRM	CDD000029	P206315	CUMS	D0HZ5230S	M120135	FMCO
	J000221	ASTEC		X004480	LEYL	C35148	P206546	AMC	CDD000028	P206323	CUMS	D100312	M090009	GALN
AU111838	J000220	AST		X004480	UNIP		P206546	XMN	CDD000030	P206328	CUMS		M090009	DRSS
	J000220	ASTEC	BB212	J000211	AP	C37A5230S	M090544	FMCO	CDD000031	P206554	CUMS	D100725	M085056	DRSS
AU111840	J000227	AST	BB234	J000213	AP	C37S5230H	M120100	FMCO	CDD000115	X004478	CUMS		M085056	GALN
	J000227	ASTEC	BB300	J000214	AP	C37Z5230B	M065065	FMCO	CDD000118	P206552	CUMS	D101865	M120100	DRSS
AU112635	M001432	AST	BB312	J000215	AP	C37Z5230F	M090544	FMCO	CDD000122	M120225	CUMS	D101877	M100048	GALN
	M001432	ASTEC	BB400	J000216	AP	C400	P206546	RKRM	CDD000123	P206555	CUMS	D114289	M090170	DRSS
AU113915	M085056	ASTEC	BC200FLAT	X004536	TESSI	C4000035	M100464	VLVO	CDD000433	P226142	CUMS	D114338	M085023	GALN
	M085056	AST	BC225FLAT	X004537	TESSI	C43328	M085008	PETTI	CDD000468	P206283	CUMS	D117248	M090158	DRSS
AU118505	P207347	AST	BC250FLAT	X004476	TESSI	C4342589	P270536	CLRK	CDD000668	J009648	CUMS		M090158	GALN
	P207347	ASTEC	BC275FLAT	X004538	TESSI	C4P206347	P206347	VLVO	CDD000669	P206344	CUMS	D126170	M085065	GALN
AU119660	P222746	ASTEC	BC300FLAT	X004478	TESSI	C4P206602	P206602	VLVO	CE200	P207411	RKRM	D132016	M090535	ECS
AX1630	P207308	SRSD	BC400FLAT	X004482	TESSI	C4P206603	P206603	VLVO	CE250	P206366	RKRM		M090074	TESSI
AY2582	M085023	ELGN	BC500FLAT	X004484	TESSI	C4TS5230A	M085023	FMCO	CE275	P207413	RKRM	D132038	M100582	ECS
			BC600FLAT	X004539	TESSI	C4TZ5230B	M085023	FMCO	CE300	P206367	RKRM	D134590	M090544	ECS
			BCU2364	X004482	LEYL	C500	P206547	RKRM	CE350	P206368	RKRM	D134591	M090544	ECS
				X004482	ROVR	C500SS	P206547	RKRM	CE400	P206369	RKRM	D135511	M100465	ECS
				X004482	MULTI	C5668	J000232	GNRC	CE500	P206370	RKRM	D137594	M070008	TESSI
				X004482	UNIP	C57S5230A	M100048	FMCO	CE600	P207414	RKRM	D137739	M090781	ECS
			BCU7273	X004476	UNIP	C57Z5230C	M060232	FMCO	CL1352	M070028	MARA	D142572	M100049	DRSS
				X004476	LEYL	C6119	J000222	GNRC		M070008	DRSS	D150003	M060037	ECS
				X004476	ROVR	C6H0006	M100572	FMC		M070008	WBBCO	D150004	M065030	ECS
			BE3510	P226141	EAGL		M100572	LKBT	CMP00290	P206409	ATCO	D150005	M070068	TESSI
			BN2391621	P207282	CASE		M100572	LBX	CMP00417	X004480	ATCO		M070068	ECS
			BN303454	P207339	CASE	C67Z5230AH	M090544	FMCO	CMV07108X0	P206326	BMY	D150006	M070069	TESSI
				P207339	TYLE	C67Z5230F	M090544	FMCO	CMV07109X0	X004482	BMY		M070069	ECS
			BN303457	P207331	TYLE	C67Z5230G	M060232	FMCO	CMV07110X0	X004478	BMY	D150007	M080024	ECS
			BN303461	P206322	CASE	C67Z5230H	M060232	FMCO	CN356A	P206368	GRMC		M080024	TESSI
			BN303465	P206336	TYLE	C7S4995	P270538	NH	CN36A	P206367	GRMC	D150008	M090091	TESSI
			BN303467	J024754	TYLE	C77Z5230A	M100048	FMCO	CN46A	P206369	GRMC		M090091	ECS
			BN309540	P206553	TYLE	C77Z5230E	M060232	FMCO	CN56A	P206370	GRMC	D150009	M100016	ECS
			BN310689	M001702	CASE	C77Z5230K	M060232	FMCO	CN66A	P207414	GRMC		M100016	TESSI
				M001702	TYLE	C77Z5230M	M065065	FMCO	CO200	P207405	RKRM	D160002	M090072	ECS
			BN310690	P270539	TYLE	C8F5714	J000228	NH	CO250	P206371	RKRM	D1NN5C208A	P270536	FIAT
				P270539	CASE	C8HS5230G	M120108	FMCO	CO300	P206372	RKRM		P270536	FMCO
			BN313592	M001668	TYLE	C8HS5230H	M090074	FMCO	CO350	P206373	RKRM		P270536	CASE
				M001668	VENCH	C8HZ5230C	M090534	FMCO	CO400	P206374	RKRM		P270536	NH
				M001668	CASE	C8TA5230M	M090280	FMCO	CO500	P206375	RKRM	D2950144	H001278	CASE
			BN318141	J008681	CASE	C8TZ5230C	M090280	FMCO	CO500PL	P207408	RKRM		H001278	PTN
			BN66496	P207362	CASE	C9HA5225A	M070008	FMCO	CO600	P207408	RKRM	D2HA5230AA	M090544	FMCO
			BN7146489	P270541	CASE	C9TZ5230A	M060232	FMCO	CP358A	P206373	GRMC	D2HS5230KA	M090158	FMCO
				P270541	TYLE	CA7462SY	M208338	FRAM	CP38A	P206372	GRMC	D2HZ5230A	M090544	FMCO
			BNP206507	P206507	WSTI	CA8014	P206546	FRAM	CP48A	P206374	GRMC	D2NKYX004478	X004478	EIMC
			BSK477902	M060037	HSTR	CB01419342	P207361	CMCO	CP58A	P206375	GRMC	D2NKYX004480	X004480	EIMC
			BST117A	P206326	CMWK	CB01419346	P216197	CMCO	CP68A	P207408	GRMC	D2NKYX004482	X004482	EIMC
			BULK400	X004482	PDCI	CB01419347	P207359	CMCO	CSP40024	J024748	RKRM	D2NKYX004484	X004484	EIMC
			BULK500	X004538	PDCI	CB01419348	P207559	CMCO	CSP40048	P206382	RKRM	D2NKYX004537	X004537	EIMC
				X004484	PDCI	CB01419350	M001505	CMCO	CSP50024PL	J024751	RKRM	D2NM0M170101	M170101	EIMC
			BW151712	P206606	KTSU	CB01423279	P206400	CMCO	CT250	P206361	RKRM	D3HA5225AAA	M090146	FMCO
			BX0376	M085023	ELGN	CB01423280	P206318	CMCO	CT300SS	P206544	RKRM	D3HA5230FA	M090535	FMCO
						CB01424452	M001504	CMCO	CX162830	M065030	AMC	D3HS5230GA	M100048	FMCO
						CB01424458	M001504	CMCO		M065030	XMN	D3HS5230HA	M120365	FMCO
			C1341	M065044	GNRC	CB01472552	P206370	CMCO		M065030	AGCO	D3HZ5230D	M090146	FMCO
			C138018	M090210	LRAN	CB01476929	M090595	CMCO		M065030	FENT	D3HZ5230M	M090535	FMCO
				M090210	TREX	CB01477039	P207354	CMCO		M065030	MF	D3HZ5255A	M090146	FMCO
			C13941	P206343	AMC	CB01477040	J024837	CMCO	CY5018	P206410	HOBT	D3TZ5230D	M065065	FMCO
				P206343	XMN	CB01477041	J190003	CMCO	CY5046	J009487	HOBT	D45000242	M090091	KW
			C1555230BD	M100048	FMCO	CB01477042	M002120	CMCO		M065044	CMR	D45000248	M100016	KW
			C1591	M120367	GNRC	CB01477127	M002120	CMCO				D45000259	M120450	KW
			C18A3779	P206411	CCML	CB01477133	J190025	CMCO				D45000266	M101182	KW
			C1TT5230AT	M100049	FMCO	CB01481031	P207332	CMCO				D45000282	M100944	KW
			C1TT5230BD	M100464	FMCO	CB01486387	J024838	CMCO				D45000307	M100463	KW
			C1TT5230DB	M100048	FMCO	CB01486531	M002134	CMCO				D45009558	M110849	KW
			C2519859	M120189	URIG	CB01486532	P206554	CMCO				D49456	M070008	LRAN
			C2785030	M090362	URIG	CB01486535	P206323	CMCO				D4HA5225EA	M090146	FMCO
			C2785032	P206410	URIG	CB01486536	M001865	CMCO				D4HZ5230C	M090146	FMCO

C

D

Mfgs. No.	Our No.	Mfg. Code	Mfgs. No.	Our No.	Mfg. Code	Mfgs. No.	Our No.	Mfg. Code	Mfgs. No.	Our No.	Mfg. Code	Mfgs. No.	Our No.	Mfg. Code
D4NN5230F	M085078	NH	DC350	X004480	UCP	E20ST	J000210	TORCA	E8A0617	M002119	LKBT			P206334
	M085078	CASE	DC400	X004482	UCP	E22ST	J000212	TORCA	E8A0618	P206315	LKBT	ENE0229		P207367
D5443	J190003	GNRC	DL0201001	M120189	NPRT	E230	M065065	EAGL	E8A0619	M001503	LKBT			P207367
D5443R	J190003	GNRC		M120189	NEPN	E2355	M085008	EAGL	E8A0620	M001702	LKBT	ENE0292		P206397
D5HA5225HA	M100464	FMCO		M120189	NPLN	E25ST	J000211	TORCA	E8HT5225LA	M100807	FMCO	ENE0298		P207361
D5HS5230EA	M120225	FMCO	DOHZ5230F	M120135	FRTL	E27ST	J000213	TORCA	E8HZ5230H	M100807	FMCO	ENE0299		P206556
D5HZ5230G	M100464	FMCO		M120135	FMCO	E2HS5225EA	M100146	FMCO	E9218031	M090095	ECLD	ENE0300		P207419
D5NN5N202A	M070068	NH	DP51654	M060250	DFLX	E2HT5225AZB	M120366	FMCO	EB5665	M120418	HOBT	ENE0308		P206489
	M070068	FMCO	DP51654Q	M060250	DFLX	E2HT5225BCA	M100465	FMCO	EB5728	P206399	HOBT	ENE0337		M070068
D5TA5225BDA	M090538	FMCO	DSC200	X004536	TAC	E2HT5225BGA	M100465	FMCO	EB5792	P208364	HOBT	ENE0340		P206336
D5TA5225BDA1	M090538	FMCO	DSC250	X004476	TAC	E2HT5225BHA	M100464	FMCO	EB5922	M120418	HOBT	ET5048		M065071
D5TQ5225BDA	M090538	FMCO	DSC275	X004538	TAC	E2HT5225BIA	M100465	FMCO	EB5933	P206326	HOBT	EX002000800000		P206407
D5TZ5230AC	M065065	FMCO	DSC300	X004478	TAC	E2HT5225BIM	M100465	FMCO	EB5944	P206510	HOBT	EX0030000100000		P206507
D5TZ5230AF	M065065	FMCO	DSC300N	J000214	TAC	E2HT5225L	M100465	FMCO	EB5945	P206411	HOBT	EX300017		M060037
D5TZ5230AH	M090538	FMCO	DSC350	X004480	TAC	E2HT5230ANA	M085172	FMCO	EB5946	P207619	HOBT	EX300021		M1060158
D5TZ5230AJ	M065065	FMCO	DSC400	X004482	TAC	E2HZ5225AFB	M110012	FMCO	EB5954	P206315	HOBT	EX300040		M100146
D5TZ5230CM	M065065	FMCO	DSC500	X004484	TAC	E2HZ5230G	M085189	FMCO	EB5955	P206365	HOBT	EX302240		P208366
D5TZ5230J	M065065	FMCO	DWM4410	M100464	PDCI	E2HZ5230L	M100465	FMCO	EB5959	P206407	HOBT	EX305528		P270531
D6667R	P206615	GNRC	DX004482	X004482	DD	E2HZ5230R	M085172	FMCO	EB5960	P206320	HOBT	EX306040		P206410
D6HS5230AA	M100464	FMCO	DX004484	X004484	DD	E2HZ5230S	M085172	FMCO	EB5967	P207354	HOBT	EX306140		P206525
D6HS5230DA	M090072	FMCO	DX3590812	M100049	HRSN	E2HZ5230Y	M090544	FMCO	EB5969	P207328	HOBT	EX306190		P206519
D6NN5C208A	P270534	NH	DX3590813	M090535	HRSN	E2HZ5230Z	M110012	FMCO	EB5972	P206335	HOBT	EZ3		J000214
	P270534	FIAT	DX359089	M090544	HRSN	E301	M090538	EAGL	EB5975	J009649	HOBT	EZ35		J000215
	P270534	CASE				E302	M120100	EAGL	EB5982	P207352	HOBT	EZ4		J000216
	P270534	FMCO				E303	M120365	EAGL	EB6010	M065044	HOBT	EZ5		J000217
D71668	M085023	LRAN				E30ST	J000214	TORCA	EB6017	P206851	HOBT			
D7204	P206369	GNRC				E31505	M120108	EAGL	EB6025	P226157	HOBT			
D7HT5225AJA	M100464	FMCO				E32841	M090159	MJPR	EB6071	P206339	HOBT			
D7HT5225BEA	M100463	FMCO							EB6073	M002118	HOBT			
D7HT5225BNA	M120197	FMCO							EBC200	X004536	CLMP			
D7HT5225CLA	M100465	FMCO							EBC225	X004537	CLMP			
D7HT5230BEA	M100465	FMCO							EBC250	X004476	CLMP			
D7HT5230FRA	M100465	FMCO							EBC275	X004538	CLMP			
D7HT5230FYA	M100463	FMCO							EBC300	X004478	CLMP			
D7HT5230GEA	M100465	FMCO							EBC350	X004480	CLMP			
D810093	M060037	DAEW							EBC350ALZ	X006204	CLMP			
D810150	M070068	DAEW							EBC400	X004482	CLMP			
D810174	M065030	DAEW							EBC400ALZ	X006203	CLMP			
D830151	M070069	DAEW							EBC500	X004484	CLMP			
D8HS5225CA	M100464	FMCO							EBC500ALZ	X006202	CLMP			
D8HS525EA	M100463	FMCO							EBC600	X004539	CLMP			
D8HT5230BA	M100465	FMCO							ECL1828	X004482	PAI			
D8HT5230CA	M100465	FMCO							ECL1829	X004484	PAI			
D8HZ5230AB	M100463	FMCO							EE100601	M120225	OKSH			
D8HZ5230AE	M100464	FMCO							EEM1879	M090544	PAI			
D8HZ5230AF	M100465	FMCO							EEM1895	M090781	PAI			
D8HZ5230AT	M100465	FMCO							EEM1896	M090823	PAI			
D8HZ5230AV	M100463	FMCO							EEM1899	M120566	PAI			
D8HZ5230B	M100465	FMCO							EEM1901	M090535	PAI			
D8HZ5230F	M100465	FMCO							EEM1917	M120382	PAI			
D8TZ5230AC	M090538	FMCO							EF9518	P206641	EAGL			
D8TZ5230CF	M065065	FMCO							EF9520	P206512	EAGL			
D9HS5225JA	M100464	FMCO							EG0938	M045237	EGLE			
D9HZ5230A	M085172	FMCO							EH0201001	M100048	NPLN			
D9HZ5A231J	J009612	FMCO							EH11068196	P207394	ECLD			
DA0796	M065034	WBBCO							EH6232815	M120131	ECLD			
DA2638	M065034	WBBCO								M120131	VME			
	M065034	KTSU								M120131	VLVO			
	M065034	DRSS												
DA3580811	M120100	HRSN												
DA3590811	M120100	HRSN												
DA3590823	M090544	HRSN												
DA3590824	M100464	HRSN												
DA3590825	M100464	HRSN												
DA3590827	M085023	HRSN												
DA3590829	M090538	HRSN												
DA359088	M090074	HRSN												
DA81670	M120108	WRNR												
DC200	X004536	UCP												
DC225	X004537	UCP												
DC250	X004476	UCP												
DC275	X004538	UCP												
DC300	X004478	UCP												

Cross Reference

(See the first page of this section for the Manufacturer's Code Listing)



CROSS REFERENCE

Mfgs. No.	Our No.	Mfg. Code	Mfgs. No.	Our No.	Mfg. Code	Mfgs. No.	Our No.	Mfg. Code	Mfgs. No.	Our No.	Mfg. Code	Mfgs. No.	Our No.	Mfg. Code
FB388.....	M001432....	TRUX	FS40018.....	P206554....	RKRM	GD7144099...	P270536....	LROI				HD2502.....	M065065...	RKRM
FB400.....	M002164....	TRUX	FS40024.....	J024836....	RKRM	GD98J11.....	P206411....	LROI	H500P.....	P206411....	TRUX	HD2503.....	M065065...	RKRM
FB400C.....	M002164....	TRUX	FS40030.....	J024836....	RKRM		P206411....	CMPR	H500Z.....	J000232....	TRUX	HD25037...	M065065...	RKRM
FB450.....	M001703....	TRUX	FS40036.....	J034673....	RKRM	GD98J14.....	P206407....	LROI	H556.....	M002121....	RKRM	HD25039...	M065065...	RKRM
FB4C.....	P206610....	GRMC	FS50012.....	J240007....	RKRM	GD98J3.....	P206410....	LROI	H580.....	P206517....	RKRM	HD2510.....	M065065...	RKRM
FB42N.....	P206602....	GRMC	FS50018.....	P206555....	RKRM	GD98J8.....	P206404....	LROI	H600.....	J000233....	AP	HD25739...	M065065...	RKRM
FB500.....	M001865....	TRUX	FS50024.....	J024838....	RKRM	GF3120.....	P226140....	GRMC		J000233....	TRUX	HD278.....	M065065...	RKRM
FB500C.....	M001865....	TRUX	FS50036.....	J024837....	RKRM	GF35120.....	P226141....	GRMC		P206515....	RKRM	HD3078.....	M085023...	RKRM
FB5C.....	P206611....	GRMC	FT300.....	P226129....	RKRM	GF35300.....	P226154....	GRMC	H700.....	P206516....	RKRM	HD325.....	M065065...	RKRM
FB52N.....	P206603....	GRMC	FT300SS.....	P226132....	RKRM	GF412.....	P224479....	GRMC	H811.....	P206520....	RKRM	HD350.....	M070028...	RKRM
FB600.....	M001505....	TRUX	FT350.....	P226154....	RKRM	GF4120.....	P226142....	GRMC	H850.....	P206517....	RKRM	HD3530...	M085008...	RKRM
FB6C.....	P207598....	GRMC	FT350SS.....	P226133....	RKRM	GF418.....	J024754....	GRMC	H900.....	P206518....	RKRM	HD357.....	M085008...	RKRM
FB62N.....	P207598....	GRMC	FT400.....	P226155....	RKRM	GF424.....	J024835....	GRMC	H92659....	M080018...	GALN	HD358.....	M085008...	RKRM
FBC200.....	X004536....	PDCI	FT400SS.....	P226156....	RKRM	GF4300.....	P226155....	GRMC	HC2738.....	M070069....	FMC	HD359.....	M070028...	RKRM
FBC225.....	X004537....	PDCI	FT500.....	P226157....	RKRM	GF436.....	J034743....	GRMC		M070068....	LKBT	HD363.....	M070028...	RKRM
FBC250.....	X004476....	PDCI	FT500SS.....	P226158....	RKRM	GF512.....	P224481....	GRMC	HD0714.....	X004536....	HAVA	HD3631...	M070028...	RKRM
FBC275.....	X004538....	PDCI	FTG2001925..	P226148....	RKRM	GF5120.....	P226143....	GRMC	HD0716.....	P206279....	HAVA	HD3810...	X004478...	HAVA
FBC300.....	X004478....	PDCI	FTG2501925..	P226149....	RKRM	GF518.....	J024755....	GRMC	HD0718.....	P206280....	HAVA	HD3811...	X004480...	HAVA
FBC350.....	X004480....	PDCI	FTG30015.....	P226129....	RKRM	GF524.....	J024837....	GRMC	HD0732.....	P206313....	HAVA	HD3812...	X004482...	HAVA
FBC350A.....	X006204....	PDCI	FTG3001925..	P226129....	RKRM	GF5300.....	P226157....	GRMC	HD0736.....	P206315....	HAVA	HD3815...	X004484...	HAVA
FBC400.....	X004482....	PDCI	FTG35015.....	P226154....	RKRM	GF536.....	J034744....	GRMC	HD0738.....	P206316....	HAVA	HD3995...	M085084...	HAVA
FBC400A.....	X006203....	PDCI	FTG3501925..	P226154....	RKRM	GF6120.....	P226150....	GRMC	HD0740.....	P206317....	HAVA	HD4012...	M100146...	HAVA
FBC450.....	X004962....	PDCI	FTG40015.....	P226155....	RKRM	GF668.....	J190059....	AC	HD0746.....	P206340....	HAVA	HD4020...	M045237...	HAVA
FBC500.....	X004484....	PDCI	FTG4001925..	P226155....	RKRM	GH0201001..	M100048....	NPRT	HD0748.....	P206342....	HAVA	HD4025...	M070008...	HAVA
FBC500A.....	X006202....	PDCI	FTG50015.....	P226157....	RKRM		M100048....	NEPN	HD0750.....	P206344....	HAVA	HD403.....	M085171...	RKRM
FBC600.....	X004539....	PDCI	FTG5001925..	P226157....	RKRM		M100048....	NPLN	HD0766.....	P226141....	HAVA	HD4035...	M080018...	HAVA
FCM060037...	M060037....	PITC	FTS35019.....	P226133....	RKRM	GH115PL.....	P205834....	RKRM	HD0768.....	P226142....	HAVA	HD404.....	M085171...	RKRM
FCM080024...	M080024....	DART	FTS40019.....	P226156....	RKRM	GH121PL.....	P205834....	RKRM	HD0770.....	P226143....	HAVA	HD4040...	M090009...	HAVA
	M080024....	KW	FTS50019.....	P226158....	RKRM	GH124PL.....	P205834....	RKRM	HD0780.....	P207333....	HAVA	HD405.....	M085171...	RKRM
FCM090091...	M090091....	PBLT				GH18C.....	P206641....	PDCI	HD0782.....	P207339...	HAVA	HD4070...	M090170...	HAVA
	M090091....	DART				GH18S.....	P206641....	GRMC	HD0794.....	P207382....	HAVA	HD4075...	M090158...	HAVA
	M090091....	KW				GH24S.....	P205834....	GRMC	HD0804.....	P208348....	HAVA	HD4080...	M120100...	HAVA
FCM100016...	M100016....	KW	G1007513.....	P210110....	UCP	GR91083250..	M065034....	PTBN	HD0806.....	P208364....	HAVA	HD4090...	M120365...	HAVA
FF2391368...	M085409....	NH	G1007514.....	X006202....	UCP	GVMA4191927029	M070068....	FRTL	HD0808.....	P208380....	HAVA	HD4095...	M170101...	HAVA
FF2391369...	M002119....	NH	G1007531.....	P213191....	TRMF	GVMA4194927029	M070068....	FRTL	HD0810.....	P270530....	HAVA	HD4130...	M090535...	HAVA
FF2393512...	P206341....	NH	G1007778.....	P206404....	PRVT				HD0812.....	P270531....	HAVA	HD414.....	M090594...	HDMI
FF2393513...	J190013....	NH	G12322838...	M065065....	VLVO				HD0814.....	P270532....	HAVA	HD4170...	M100043...	HAVA
FF2405090...	P206544....	NH	G12322863...	M120365....	VLVO	H00454.....	P207397....	HOIST	HD0818.....	P270534....	HAVA	HD4230...	M090535...	HAVA
FF2410384...	P206407....	NH	G153300.....	P226129....	GRMC	H0047013....	M001866....	JNDR	HD0820.....	P270535....	HAVA	HD4310...	M060232...	HAVA
FF2417954...	P208326....	NH	G1535300.....	P226154....	GRMC	H0047014....	M001867....	JNDR	HD0822.....	P270536....	HAVA	HD4315...	M060232...	HAVA
FF3043171...	P206280....	NH	G154300.....	P226155....	GRMC	H037006.....	M070008....	DRSS	HD0824.....	P270538....	HAVA	HD4320...	M065065...	HAVA
FG1133.....	M070008....	PETTI	G155300.....	P226157....	GRMC	H092659....	M080018...	DRSS	HD0826.....	P270539....	HAVA	HD4380...	M085056...	HAVA
FG400120.....	P226142....	RKRM	G2013323.....	M100213....	VLVO	H10.....	P206507....	GRMC	HD0828.....	P270540....	HAVA	HD449.....	M085171...	RKRM
FG40018.....	J024754....	RKRM	G2036932.....	X004484....	CASE	H1000.....	P206519....	RKRM	HD0830.....	P270541....	HAVA	HD500.....	M090074...	RKRM
FG40018.....	J024755....	RKRM		X004484....	PTN	H1015.....	P206521....	RKRM	HD0834.....	P270543....	HAVA	HD6017...	M100048...	RKRM
FG50024.....	J024837....	RKRM	G2584801.....	M002121....	GRDL	H1510.....	P206521....	RKRM	HD0841.....	P206605....	HAVA	HD7034...	M090538...	RKRM
FG40036.....	J034743....	RKRM	G2957.....	J190059....	CHAP	H200.....	J000220....	AP	HD0842.....	P206606....	HAVA	HD9000...	P206407...	HAVA
FG40048.....	P226142....	RKRM	G33505.....	X004478....	PTBM	H212.....	J000221....	TRUX	HD0843.....	P206607....	HAVA	HD9002...	P206409...	HAVA
FG500120.....	P226143....	RKRM	G6442.....	J190059....	FRAM	H214.....	J000222....	TRUX	HD0845.....	P206612....	HAVA	HD9004...	P206410...	HAVA
FG50018.....	J024755....	RKRM	G695424.....	M100048....	VLVO	H234.....	J000222....	AP	HD0860.....	P207567....	HAVA	HD9006...	P206411...	HAVA
FG50024.....	J024837....	RKRM	G717214.....	M100464....	VLVO	H300.....	J000222....	AP	HD0865.....	P206615....	HAVA	HD9035...	P206406...	HAVA
FG50036.....	J034744....	RKRM	G798803.....	M090538....	VLVO	H312P.....	P206409....	TRUX	HD200.....	M060232....	RKRM	HD9830...	M120197...	HAVA
FI46070.....	J190059....	XMN	G9013928.....	M120108....	VLVO	H312P.....	P206409....	TRUX	HD201.....	M060232....	RKRM	HH404X...	P207567...	EAGL
	J190059....	AMC	GD125065.....	P270539....	LROI	H350.....	P206524....	RKRM	HD2014.....	H001032....	HAVA	HH505X...	P207566...	EAGL
FL2.....	X004536....	GRMC	GD1402841...	M120365....	LROI	H360339430..	X004536....	KTSU	HD2015.....	H001033....	HAVA	HT0549...	P270539...	LKBT
FL225.....	X004537....	GRMC	GD1406486...	X004484....	LROI	H37006.....	M070008....	GALN	HD2016.....	H001034....	HAVA	HT0739...	M090009...	FMC
FL25.....	X004476....	GRMC	GD1413616...	M090009...	LROI	H400.....	J000230....	AP	HD2017.....	H001035....	HAVA	HT739.....	M090009...	FMC
FL275.....	X004538....	GRMC	GD1417607...	P207365....	LROI		J000230....	TRUX	HD2030.....	H001278....	HAVA	HW0449...	M090544...	WBCCO
FL3.....	X004478....	GRMC	GD1417608...	M120365....	LROI		J000228....	TRUX	HD2031.....	H001279....	HAVA		M090544...	DRSS
FL35.....	X004480....	GRMC	GD1422024...	M060037....	LROI		J000228....	TRUX	HD2036.....	H001284....	HAVA			
FL4.....	X004482....	GRMC	GD169026.....	P206407....	LROI		P206409....	TRUX	HD2190.....	M045123....	HAVA			
FL4A.....	X006203....	GRMC	GD1717017...	M085090....	LROI		P206524....	RKRM	HD2200.....	M060037....	HAVA			
FL5.....	X004484....	GRMC	GD183184.....	P206411....	CMPR		H360339430..	X004536....	HD2210.....	M060038....	HAVA			
FL5A.....	X006202....	GRMC		P206411....	LROI		H400.....	J000230....	HD2220.....	M065030....	HAVA			
FL6.....	X004539....	GRMC	GD200SPQ063	M120100....	LROI			J000230....	HD2230.....	M070068....	HAVA			
FMC090091...	M090091....	KW	GD2016573...	M120108....	LROI			J000230....	HD2240.....	M070069....	HAVA			
FP1503535...	M090210....	PTBN	GD202SPT063	M122300....	LROI			P206525....	HD2250.....	M080024....	HAVA			
FS1719.....	J190059....	SAKR	GD302650.....	X004539....	LROI			P206410....	HD2260.....	M090091....	HAVA			
FS30018.....	P206552....	RKRM	GD5000268...	P206410....	LROI			J000231....	HD2265.....	M100016....	HAVA			
FS35012.....	J240005....	RKRM	GD5826466...	X004480....	LROI			J000231....	HD250.....	M065065....	RKRM			
FS35018.....	P206553....	RKRM	GD5827462...	M090158....	LROI			J000232....	HD2500.....	M065065....	RKRM			
FS35024.....	J024850....	RKRM	GD5840015...	M090535....	LROI			J000232....	HD2501.....	M065065....	RKRM			

Mfgs. No.	Our No.	Mfg. Code	Mfgs. No.	Our No.	Mfg. Code	Mfgs. No.	Our No.	Mfg. Code	Mfgs. No.	Our No.	Mfg. Code	Mfgs. No.	Our No.	Mfg. Code
I10007	P207367	HOIST	K460EXC	P207301	GRMC	KYX006203	X006203	FRTL	L35901616SA	P207328	GRMC	L50045SR	P207354	RKRM
I100036	P206849	HOIST	K460SBA	P208388	GRMC		X006203	WSTI	L35AA	J009605	TORCA	L50045SRPL	P216169	RKRM
I100037	P206850	HOIST	K460SBC	P208389	GRMC	KYX004484	X004484	CRAN	L35SA	J190061	TORCA	L50060	J009641	RKRM
I100038	P206336	HOIST	K472EXC	P216202	GRMC				L3900606SA	P207362	GRMC	L50060NE	J009645	RKRM
IPS0848	M090544	CHLN	K472SBC	J640005	GRMC				L3900707A	P206340	GRMC	L500F	P206347	RKRM
IPS2453	M070050	CHLN	K484EXC	P224635	GRMC				L3901010SA	P207326	GRMC	L500FCR	P206347	RKRM
IPS4174	M060232	CHLN	K496EXC	P224636	GRMC				L3901414A	P206341	GRMC	L500FNE	P207331	RKRM
IPS41742	M065065	CHLN	K524BC	J024751	GRMC				L3901414SA	J190013	GRMC	L500FPL	P207346	RKRM
IPS4586	M120154	CHLN	K524EXA	J024747	GRMC				L400	P206345	RKRM	L500NE	P206349	RKRM
			K524EXC	J024758	GRMC				L40015	P206395	RKRM	L500PL	P206354	RKRM
			K524SBC	J024751	GROCK				L40030	J009632	RKRM	L500SB	P206400	RKRM
			K536EXC	P216204	GRMC				L40030NE	J009636	RKRM	L500SR	P207365	RKRM
			K536SBA	P208374	GRMC				L40045	P206282	RKRM	L500AA	J009607	TORCA
			K536SBC	P208375	GRMC				L40045F	P206282	RKRM	L50BA	P222741	TORCA
			K548EXA	P207296	GRMC				L40045FPL	P206285	RKRM	L50SA	J009624	TORCA
			K548EXC	P207321	GRMC				L40045NE	P207353	RKRM	L510	P207339	RKRM
			K548SBA	P206383	GRMC				L40045SR	P207354	RKRM	L510PL	J009547	RKRM
			K548SBC	P206387	GRMC				L40060	J009640	RKRM	L512	P207339	RKRM
			K560EXC	P207302	GRMC				L40060NE	J009644	RKRM	L512CR	P207339	RKRM
			K560SBA	P208394	GRMC				L400CR	P206345	RKRM	L512NE	P207332	RKRM
			K560SBC	P208395	GRMC				L400F	P206282	RKRM	L512NEPL	J190019	RKRM
			K572EXC	P216205	GRMC				L400FNE	P206346	RKRM	L512PL	J009547	RKRM
			K572SBC	P224600	GRMC				L400FNEPL	J190016	RKRM	L5150404SA	P206396	GRMC
			K584EXC	P224638	GRMC				L400FPL	P207345	RKRM	L5300404A	J009633	GRMC
			K596EXC	P209910	GRMC				L400FS	P206344	RKRM	L5300404SA	J009637	GRMC
			K596SBC	P209912	GRMC				L400FSPL	P207345	RKRM	L5450808A	J190025	GRMC
			KC3015	M065071	WBCCO				L400NE	P207329	RKRM	L5450808C	P206286	GRMC
			KCY238A	J008681	CMWVK				L400NECR	J190016	RKRM	L5450808SA	P207354	GRMC
			KCY239A	J009649	CMWVK				L400PL	P206353	RKRM	L5450808SC	P216169	GRMC
			KHH0199	X004476	JCB				L400SB	P206399	RKRM	L5451212A	P206283	GRMC
			KM3103	M085189	RKRM				L400SR	P207364	RKRM	L5601010A	J009641	GRMC
			KPFA015	P224684	KBCO				L401	P206345	RKRM	L5601010SA	J009645	GRMC
			KW14764L	J038611	GRMC				L40AA	J009606	TORCA	L5901010A	J190003	GRMC
			KW14764R	J038612	GRMC				L40BA	P222740	TORCA	L5901010C	J190004	GRMC
			KYX004476	X004476	EIMC				L40SA	J009623	TORCA	L5901010SA	P207365	GRMC
				X004476	DART				L4150404SA	P206395	GRMC	L5901011A	J190003	GRMC
				X004476	NFC				L4300404A	J009632	GRMC	L5901212A	P207339	GRMC
			KYX004478	X004478	MUNCIE				L4300404SA	J009636	GRMC	L5901212C	J009547	GRMC
				X004478	NFC				L4450909A	P206282	GRMC	L5901212SA	P207332	GRMC
				X004478	DART				L4450909C	P206285	GRMC	L5901515A	P206347	GRMC
			KYX004478210	X004478	DART				L4450909SA	P207353	GRMC	L5901515C	P207346	GRMC
			KYX004480	X004480	SLAR				L4451212A	J190023	GRMC	L5901515SA	P207331	GRMC
				X004480	VANAI				L450F	J190002	RKRM	L5901515SC	J190019	GRMC
				X004480	NFC				L45AA	J190054	TORCA	L5901818A	P206348	GRMC
				X004480	DART				L45SA	J190062	TORCA	L5901818C	P206354	GRMC
				X004480	CNLC				L4600808A	J009640	GRMC	L5901818SA	P206349	GRMC
			KYX004480016	X004480	TAC				L4600808SA	J009644	GRMC	L600	P206350	RKRM
			KYX004482	X004482	DART				L46279	M080018	CASE	L60045	P207359	RKRM
				X004482	NFC				L488	J008681	RKRM	L600F	P207341	RKRM
				X004482	VANAI				L4900606SA	P206399	GRMC	L600FNE	P216175	RKRM
				X004482	NAVI				L4900808A	J008681	GRMC	L600NE	P216175	RKRM
				X004482	SLAR				L4900808C	P224671	GRMC	L600SB	P207366	RKRM
				X004482	FRTL				L4900808SA	P207364	GRMC	L600SR	P207365	RKRM
				X004482	PRVT				L4901010A	P206344	GRMC	L60AA	J190055	TORCA
			KYX004482210	X004482	DART				L4901010C	P207345	GRMC	L60BA	P222742	TORCA
			KYX004484	X004484	DART				L4901010SA	P207330	GRMC	L60SA	J190063	TORCA
				X004484	UCP				L4901212SA	P206346	GRMC	L6451515A	P207359	GRMC
				X004484	STEW				L4901818A	P206345	GRMC	L6451515SA	P207355	GRMC
				X004484	MARWIL				L4901818C	P206353	GRMC	L6656	M080018	PETTI
				X004484	FRTL				L4901818SA	P207329	GRMC	L67657	P207362	GEHL
				X004484	CRAN				L4901818SC	J190016	GRMC	L6901313A	P207341	GRMC
				X004484	SWEE				L490181A	P206345	GRMC	L847141	M060232	PETTI
			KYX004484210	X004484	DART				L500	P206348	RKRM	LA1247	P270538	PTBN
			KYX004536	X004536	FRTL				L50015	P206396	RKRM	LA9816	P206344	PTBN
				X004536	DART				L50030	J009633	RKRM	LBP5510	M100463	PDCI
				X004537	WSTI				L50030NE	J009637	RKRM	LE0201001	M120108	NPRT
				X004537	DART				L50045	P206283	RKRM		M120108	NPLN
			KYX004538	X004538	NFC				L50045ALZ	P206283	RKRM	LG0203015	P206516	NPLN
				X004538	DART				L50045F	J190025	RKRM	LG503791	M100466	BADG
			KYX004539	X004539	DART				L50045FPL	P206286	RKRM	LG76402	P270539	BADG
				X005207	DART				L50045NEPL	P216169	RKRM	LG77619	P206410	BADG
			KYX005833	X007785	DART				L50045PL	P206286	RKRM	LG77625	M100464	BADG
			KYX006202	X006202	FRTL									

Cross Reference

(See the first page of this section for the Manufacturer's Code Listing)



CROSS REFERENCE

Mfgs. No.	Our No.	Mfg. Code	Mfgs. No.	Our No.	Mfg. Code	Mfgs. No.	Our No.	Mfg. Code	Mfgs. No.	Our No.	Mfg. Code	Mfgs. No.	Our No.	Mfg. Code
LG78701	P270541	BADG	LT350	M070028	RKRM	M12429	P207326	HOIST	M20147	M120108	ACFT	M512	M090520	GRMC
LI246819	M070069	PTBN	LT359	M070028	RKRM	M127	M085171	GRMC	M20153	M090280	ACFT	M514	M090781	GRMC
LL240518	P226132	PTBN	LT400	M090362	RKRM	M12967141	H001039	ECLD	M20183	M085172	ACFT	M5209443	P207282	ECLD
LL3690391	P206341	PTBN	LT409	M090072	RKRM	M12969628	M090534	ECLD	M20185	M090563	ACFT	M5209756	M090158	CLRK
LL400	P207338	RKRM	LT509	M090362	RKRM	M12969629	P206364	ECLD	M20213	M090538	ACFT		M090158	ECLD
LL500	P207340	RKRM	LVA13826	M001866	JNDR	M12969630	X007784	ECLD	M20512	M090520	ACFT	M525	M085189	GRMC
LL847117	M085056	PTBN	LVA13827	M001867	JNDR	M12969930	M090538	ECLD	M20529	M110189	ACFT	M526	M100213	GRMC
LL847120	M120100	PTBN				M130	M100580	GRMC	M22260	M060232	PDCI	M529	M110189	GRMC
	M120100	PETTI				M13035	M085411	HOIST	M2244	M045237	PDCI	M5294859	X004482	ECLD
LL847127	M090158	PTBN				M13069	J000200	HOIST	M22525662	M065065	PDCI	M530	M110112	GRMC
	M090158	PETTI				M13070	P206340	HOIST	M23385	M085023	PDCI	M537	M090547	GRMC
LL847141	M060232	PTBN				M131	M090544	GRMC	M23385X32	M085078	PDCI	M5384540	P270534	CLJL
LL847156	M120154	PETTI				M132	M090074	GRMC	M235358X11	M090158	PDCI	M542	M120566	GRMC
	M120154	PTBN				M13207	J009648	HOIST	M235385	M085008	PDCI	M54410	M100049	PDCI
LL847160	M100048	PTBN				M13209	P207353	HOIST	M23548X11	M090520	PDCI	M54410X15	M120154	PDCI
LL847181	M090146	PETTI				M13326	J008681	HOIST	M24358X11	M090538	PDCI	M5510	M100465	PDCI
LL847245	M090210	PTBN				M13327	P206346	HOIST	M24410	M100048	PDCI	M5510SP	M100465	TESSI
LL84726	M070008	PETTI				M13328	P222757	HOIST	M24410X15	M120100	PDCI	M5510X67	M100807	PDCI
LL84729	M070008	PTBN				M13329	P270539	HOIST	M24411	M110012	PDCI	M551X67	M100807	PDCI
	M070008	PETTI				M13653	P206399	HOIST	M24411X36	M110189	PDCI	M55510X15	M120131	PDCI
LL847307	M080024	PTBN				M139	M085023	GRMC	M2448X11	M090534	PDCI	M5590	M090535	PDCI
LL847322	M070068	PTBN				M144	M090362	GRMC	M250170	M090538	RXRD	M595	M090595	GRMC
LL847325	M090362	PTBN				M14410	P207318	HOIST	M2501803	M090170	VLVO	M6002355	M100048	MIIN
LL84735	M120100	PETTI				M145	M090072	GRMC	M2510883	M090159	ECLD	M6006049	M090072	ECLD
LL84736	M120100	PETTI				M147	M120108	GRMC	M2512224	M170101	VLVO	M6010469	M085056	ECLD
LL84737	M085023	PETTI				M149	M120382	GRMC	M2513322	X004484	ECLD	M669473	P206404	CLJL
	M085023	PTBN				M14954	P206410	HOIST	M2520560	M070068	ECLD	M70069	M070069	VMER
LL847372	X007831	PETTI				M14958	M090594	HOIST	M252666	M065071	PDCI	M724	M110479	GRMC
LL847373	X004480	PTBN				M150	M070028	GRMC	M2527050	M120108	VLVO	M790758	P206406	CLJL
LL847375	P207281	PTBN				M15035	P206346	HOIST	M2528407	M090159	VLVO	M824607	P206405	CLJL
LL847381	H001284	PTBN				M15036	J009644	HOIST	M2531311	M120189	VLVO	MA399C	X004480	ALMD
LL847386	X004482	PTBN				M1512238	M100049	ECLD	M25510X15	M120108	PDCI	MAM110014	M110014	DART
LL847410	P206325	PTBN					M100049	VLVO	M25510X36	M120365	PDCI	MAN090598	M090598	DENY
LL847413	M085207	PTBN				M1517515	M090091	ECLD	M25511	M110077	PDCI	MB0715	M090091	WBBCO
LL847414	X004478	PTBN				M1518825	M120154	VLVO	M2A252785	M085172	PDCI		M090091	DRSS
	X004478	ARDCO				M152238	M120154	ECLD	M2A25385	M085189	PDCI	MBT032479000	H001034	FRTL
LL847427	M090598	PTBN				M152238	M100049	CLRK	M2A2748X11	M090563	PDCI	MBTA0416422000	M120365	FRTL
LL847428	X004476	PTBN				M153	M090280	GRMC	M30510	M090547	ACFT	MBTA0416704002	M110311	FRTL
LL847429	M065044	PTBN				M1543567	M120108	ECLD	M30511	M090548	ACFT	MBTA3764920159	P206554	FRTL
LL847430	J190058	PTBN				M1545546	M090074	ECLD	M30537	M090547	ACFT	MBTA3764921340	X007784	FRTL
LL847437	M090280	PTBN					M090074	CLRK	M3380	M080018	PDCI	MBTA3764921940	X007830	FRTL
LL847450	M085056	PTBN				M15456	M085407	HOIST	M34410X15	M120382	PDCI	MBTA3764922104	P206311	FRTL
LL847451	P207362	PTBN				M15467	P206315	HOIST	M344116X3	M110479	PDCI	MD820228	X004478	GM
LL847458	M101169	PTBN				M15469	P206374	HOIST	M34411X36	M110479	PDCI	MDM120131	M120131	KW
LL847462	P207329	PTBN				M15470	P206386	HOIST	M34510X15	M120566	PDCI	ME355M	M065071	ALMD
LL847463	M101168	PTBN				M15542	P208389	HOIST	M34590	M090823	PDCI	ME421M	M065044	ALMD
LL847464	M002121	PTBN				M15620	P206512	HOIST	M353570	M070028	PDCI	ME423MH	M002118	ALMD
LL847469	P206849	PTBN				M15660	P206395	HOIST	M353590	M090146	PDCI	ME431M	M070028	ALMD
LL847474	J009648	PTBN				M15661	P206311	HOIST	M35510	M100213	PDCI	ME439M	M060158	ALMD
LL847481	P207338	PTBN				M15666	P206543	HOIST	M3612123	M065044	KRAM	ME444B	X004536	ALMD
LL847482	M091048	PTBN				M15667	P206508	HOIST	M3676064	X004478	ECLD	ME450MB	M002117	ALMD
LL847483	M002120	PTBN				M15679	J009486	HOIST	M4010	M100466	RKRM	ME454M	M091048	ALMD
LL847485	P207352	PTBN				M15698	M002120	HOIST	M4047421	X004484	ECLD	ME455C	M002120	ALMD
LL847493	P207402	PTBN				M1585116	H001034	ECLD	M4090	M090544	RKRM	ME458M	M090595	ALMD
LL847506	P206544	PTBN				M15877	M100580	HOIST	M435408X11	M090548	PDCI	ME459ES	P207298	ALMD
LL84771	M085008	PTBN				M15883	P207332	HOIST	M435418X11	M090547	PDCI	ME460C	J000232	ALMD
	M085008	PETTI				M15884	P206396	HOIST	M4410	M100466	PDCI	MH0811	P206520	PDCI
LL84786	M045237	PETTI				M15888	P206375	HOIST	M44410	M100052	PDCI	MH1000	P206519	PDCI
LL84788	M065065	PETTI				M15894	P222759	HOIST	M44410X15	M120367	PDCI	MH1015	P206521	PDCI
LL84796	M070028	PETTI				M159851	J024739	HOIST	M4485	M085171	PDCI	MH600	P206515	PDCI
	M070028	PTBN				M16208	P207362	HOIST	M4490	M090544	PDCI	MH700	P206516	PDCI
LN4590	M090781	PDCI				M16307	J009645	HOIST	M4510	M100695	PDCI	MH850	P206517	PDCI
LN5590	M090074	PDCI				M16323	P206509	HOIST	M451051	M100695	PDCI	MH900	P206518	PDCI
LND5510	M100582	PDCI				M16557	P206508	HOIST	M45510X15	M120366	PDCI	MIS6223	P224515	RYKE
LNS5510	M100580	PDCI				M180	M122300	GRMC	M45511	M110014	PDCI	Miy0001	X004478	ARDCO
LP35095B	M065140	PTBN				M185	M090563	GRMC	M4590	M090781	PDCI	Miy0017	P270538	ARDCO
LPP00200	P206544	PTBN				M1902490	M070069	ECLD	M4590SP	M090544	TESSI	Miy0028	P206600	ARDCO
LPP12169	P206405	PTBN					M070069	CLRK	M465	M100944	GRMC	Miy0042	P207326	PTBN
LPP19262	M085078	PTBN				M1925199	X004480	ECLD	M5010	M100465	RKRM	Miy0067	P206397	ARDCO
LPP32697	M085207	PTBN				M20125	M120110	ACFT	M503	M120366	GRMC		P206397	PTBN
						M20137	M065065	ACFT	M5090	M090535	RKRM	Miy0119	P206336	ARDCO
						M20139	M085023	ACFT	M511	M090548	GRMC	Miy0136	P206310	PTBN

Mfgs. No.	Our No.	Mfg. Code	Mfgs. No.	Our No.	Mfg. Code	Mfgs. No.	Our No.	Mfg. Code	Mfgs. No.	Our No.	Mfg. Code	Mfgs. No.	Our No.	Mfg. Code
MK160668	M060251	KOEH	NX14152064	M065071	CASE	P17581	M060232	LULL	P48094	M070008	ATHP	PH350	P206524	PDCI
MK21698	J028528	GTRC	NX14152065	P270535	CASE	P1906	M090009	CHLN	P49375	M065034	ATHP	PH400	P206525	PDCI
MM313	M045237	PETTI	NX14152067	M070028	CASE	P19262	M085078	LULL	P50170910	M070069	SLVN	PH500	P206526	PDCI
MM322	M065034	PETTI	NX14152068	P270538	CASE	P19871	M060158	LULL	P50170912	M100016	SLVN	PP0191	M070068	RTWC
M090159	M090159	IR	NX14152069	P206601	CASE	P1997770	M120131	S-FIRE	P50170909	M065030	SLVN	PR0102	P206323	AGEM
MOM120367	M120367	DART	NX14152072	P270535	CASE	P20352	M085023	CHLN	P501878533	M085207	SLVN	PR10002435	M085023	PTBN
MOM120382	M120382	DART				P204190	P206304	ATHEY	P525873	P206344	ATHP	PR10008010	P206342	PTBN
MOM120450171	M120450	KW					P206304	ATHP	P26344	P206344	ATHP	PS21834	P206411	RCHD
MPT20	M060247	PDCI							P532697	M085207	LULL	PS417413	M120225	RCHD
MPT25	M060005	PDCI							P536SBC	P216227	GRMC	PS417415	M100463	RCHD
MPT30	M070008	PDCI							P548SBC	P216228	GRMC	PS41745	M120108	RCHD
MPT35	M070050	PDCI							P560EXC	P224608	GRMC	PS41746	M090535	RCHD
MPT40	M090009	PDCI							P560SBC	J540008	GRMC	PS67251	X004482	RCHD
MR200	M060037	RKRM							P572SBC	P224609	GRMC	PS67252	X004484	RCHD
MR250	M065030	RKRM							P584EXC	P224611	GRMC	PS67253	X004539	RCHD
MR300	M070068	RKRM							P596EXC	P224707	GRMC	PS67681	P207365	RCHD
MR350	M070069	RKRM							P64615	P206410	ATHEY	PS67682	P207332	RCHD
MR40	M090362	PDCI								P206410	ATHP	PS7331	P270541	RCHD
MR400	M080024	RKRM							P70638	M090158	ATHP	PS73322	P270543	RCHD
MR50	M090072	PDCI							P720047	P206327	ROSS			
MR500	M090091	RKRM							P720048	P206398	ROSS			
MR55	M090072	PDCI							P720071	P207363	ROSS			
MRSC225	X004537	MEDINA							P85523	M085023	ATHP			
MRSC250	X004476	MEDINA								M085023	ATHEY			
MRSC275	M04538	MEDINA							P9A0243	P208392	LKBT			
MRSC300	X004478	MEDINA							P9A0348	P213191	LKBT			
MRSC350	X004480	MEDINA							P9A0349	P222753	LKBT			
MRSC400	X004482	MEDINA							PB01726	J009560	GRMC			
MUF20006	M045237	WRTH							PB1182	M120108	DRSS			
MUF57	M070008	WRTH							PB1481	M170101	KTSU			
MX251766	P206607	DAEW								M170101	DRSS			
MY365946	P206303	MBSI								M170101	WBCO			
									PB1913	M190002	KTSU			
										M190002	DRSS			
									PB2414	M090535	DRSS			
										M090535	KTSU			
									PB3205	M120108	DRSS			
										M120108	WBCO			
									PB3239	X004539	KTSU			
										X004539	DRSS			
									PB4233	X004484	KTSU			
									PB4590	X004480	DRSS			
										X004480	KTSU			
									PB4890	M120225	DRSS			
										M120225	KTSU			
									PB8490	M120225	KTSU			
									PBC400	X007784	PDCI			
									PBC400A	X007824	PDCI			
									PBC500	X007785	PDCI			
									PBC500A	X007805	PDCI			
									PF2	J190056	GRMC			
									PF25	J190058	GRMC			
									PF255	J190057	GRMC			
									PF275	J190059	GRMC			
									PF3	J190060	GRMC			
									PF35	J190061	GRMC			
									PF4	J009623	GRMC			
									PF4A	X007824	GRMC			
									PF5	J009624	GRMC			
									PF5P	P222741	GRMC			
									PF6P	P222742	GRMC			
									PFC250	J190058	TAC			
									PFC275	J190059	TAC			
									PFC300	X007830	TAC			
										J190060	TAC			
									PFC300S	X007830	TAC			
									PFC350	J190061	TAC			
									PFC350S	X007831	TAC			
									PFC400	J009623	TAC			
										X007784	TAC			
									PFC400S	X007784	TAC			
									PFC500	X007785	TAC			
									PH300	P206523	PDCI			

Cross Reference

(See the first page of this section for the Manufacturer's Code Listing)



CROSS REFERENCE

Mfgs. No.	Our No.	Mfg. Code	Mfgs. No.	Our No.	Mfg. Code	Mfgs. No.	Our No.	Mfg. Code	Mfgs. No.	Our No.	Mfg. Code	Mfgs. No.	Our No.	Mfg. Code	
RC300C	P271507	GRMC	RMH85	P206517	GRMC	S505881	M100048	CASE			P206303	XMN	SPO35824	P208336	RKRM
RC300PL	P271507	RKRM	RMH9	P206518	GRMC	S508420	M090158	CASE	SFA4332	P206343	XMN	SPO35836	P208324	RKRM	
RC350	P270538	RKRM	RO430	P206321	RKRM	S508699	M090170	CASE			P206343	AMC	SPO35848	P206377	RKRM
RC400	P270539	GRMC	RO43075	M090158	CASE	S5120SBA	P206337	GRMC	SFA5108	P206546	XMN	SPO40024	J024737	RKRM	
RC400C	P270539	RKRM	RO435	P206322	RKRM	S518EXA	P207283	GRMC			P206546	AMC	SPO40036	P208364	RKRM
RC400C	P270837	GRMC	RO540	P206323	RKRM	S524EXA	J024737	GRMC	SFA8601	P206303	XMN	SPO40048	P207287	RKRM	
RC400PL	P270837	RKRM	RO650	P207402	RKRM		J024739	GRMC			P206303	AMC	SPO40060	P207288	RKRM
RC450	P270540	RKRM	S			S524EXC	J240024	GRMC	SFSN378	J190059	AMC	SPO40060PL	P207299	RKRM	
RC500	P270541	RKRM	S0029002	M080024	HSTR	S524SBA	P224589	GRMC		J190059	XMN	SPO40824	J240012	RKRM	
RC500C	P270541	GRMC	S00290020002	M080024	HSTR	S524SBC	P224590	GRMC	SI1517	M090091	GM	SPO40824PL	J240012	RKRM	
RC500PL	P270541	RKRM	S0068322	P226140	HSTR	S536EXA	P208380	GRMC	SI1914	M080024	GM	SPO40848	P206378	RKRM	
RC600	P270543	GRMC	S0068525	H001278	HSTR	S536EXC	J340023	GRMC	SK326022	M090158	HSTR	SPO40848PL	P206388	RKRM	
RC600C	P271511	GRMC	S008481502	M070068	HSTR	S548EXA	P207292	GRMC	SKA1710	P206512	RKRM	SPO40860PL	P206390	RKRM	
RC600PL	P271511	RKRM	S008481503	P270536	HSTR	S548EXC	P207317	GRMC	SKA1740	P206508	RKRM	SPO40872	J640001	RKRM	
RCG200	P270532	RKRM	S008481505	P206600	HSTR	S548SBA	P206379	GRMC	SKA1750	P206509	RKRM	SPO50024	J024739	RKRM	
RCG225	P270533	RKRM	S00848153	P270536	HSTR	S560EXA	P207289	GRMC	SKA1760	P224492	RKRM	SPO50024PL	J240024	RKRM	
RCG250	P270534	RKRM		P270536	NACO	S560EXC	P207300	GRMC	SKA1785	P206510	RKRM	SPO50036	P208380	RKRM	
RCG275	P270535	RKRM	S00848155	P206600	NACO	S560SBA	P208393	GRMC	SKA1790	P206511	RKRM	SPO50036PL	J340023	RKRM	
RCG300	P270536	RKRM	S00848155	P206600	NACO	S560SBC	P206391	GRMC	SKB800935	M060158	GRVE	SPO50048	P207292	RKRM	
RCG350	P270538	RKRM	S008706004	X004476	NACO	S58SBA	P206365	GRMC	SKB800936	M060037	GRVE	SPO50048PL	P207317	RKRM	
RCG400	P270539	RKRM	S008706005	M065030	NACO	S6120SBA	P206338	GRMC	SKB830246	M070069	GRVE	SPO50060	P207289	RKRM	
RCG400PL	P270837	RKRM	S008706006	P270534	NACO	S99911	M080024	CASE	SKB830318	M090091	GRVE	SPO50060PL	P207300	RKRM	
RCG450	P270540	RKRM	S008850805	P270532	NACO	SA150	M060038	PDCI	SKC851446	M065030	GRVE	SPO50848	P206379	RKRM	
RCG500	P270541	RKRM	S00933950010	M070068	HSTR	SA200	M060037	RKRM	SKC852108	M080024	GRVE	SPO50848PL	P206389	RKRM	
RCG500PL	P270838	RKRM	S00965700030	P206326	NACO	SA2009	M060037	RKRM	SKC862037	M070069	GRVE	SPO50860	P206391	RKRM	
RDK8970	X004962	RDVR	S00976760055	M100016	NACO	SA250	M065030	PDCI	SKS191521	M080024	HSTR	SPO50860PL	P206391	RKRM	
	X004962	LEYL	S00976760056	P207394	NACO	SA2509	M065030	RKRM	SKS326022	M090158	HSTR	SS53600A	M001327	PDCI	
	X004962	UNIP	S00976760058	P271511	NACO	SA300	M070068	PDCI	SKS477902	M060037	HSTR	ST7410136	M090538	WHCO	
RDK9144	X004484	MULTI	S00977470041	P206365	NACO	SA300	M070068	PDCI	SKS554702	M060037	HSTR	ST95068	P206333	CLRK	
RE20223	M001432	JNDR	S00977470042	M090091	NACO	SA3009	M070068	RKRM	SM4490	M090594	PDCI	ST95069	P206334	CLRK	
	M001432	CMCO	S010168452	M100572	NACO	SA3500	M070068	RKRM	SMB	P207784	GRMC				
RE223454	X007784	JNDR	S01262720005	P270532	NACO	SA350	M070069	RKRM	SP030024	P216191	RKRM	T0260	P206411	ROSS	
RE223455	X007785	JNDR	S0126272005	P270532	NACO	SA3509	M070069	RKRM	SP13SS	P206543	RKRM	T0262	P270541	ROSS	
RE35655	X007830	JNDR	S01351990029	P270533	NACO	SA400	M080024	PDCI	SP1410AL	P206542	RKRM	T0263	M100463	ROSS	
RE42815	X007784	JNDR	S033660	P206334	HOIST	SA400	M080024	PDCI	SP1410SS	X005207	RKRM	T0263	M100463	ROSS	
RE42816	X007785	JNDR	S03775	P206337	HOIST	SA4009	M080024	RKRM	SP1485AL	P206540	RKRM	T0936444	J000203	CAME	
RE52768	M001668	JNDR	S099911	M080024	CASE	SA408	M080024	RKRM	SP1485SS	X005207	RKRM	T120287	P206342	MRMT	
RH049688	M060005	DRSS	S11732	M060005	LEC	SA408	M080024	RKRM	SP1490AL	P206540	RKRM	T120289	P206344	MRMT	
RH100260	X004484	OKSH	S1671B	J190059	SOFI	SA500	M090091	PDCI	SP1490SS	X005207	RKRM	T13762	M070008	PH	
RH49688	M060005	GALN	S209070	M080018	MJPR	SA5009	M090091	RKRM	SP14SS	X005207	RKRM	T1407	P206315	ROSS	
RI250	P207382	RKRM	S219802	M065034	CASE	SA600	M100016	PDCI	SP18	P206543	RKRM	T1408	P206340	ROSS	
RI275	P207385	RKRM	S222578	M120154	CASE	SA6009	M100016	RKRM	SP1836SS	P206543	RKRM	T1409	P206408	ROSS	
RI350	P206313	RKRM	S224620	M090210	MJPR	SC015041039	H001039	URIG	SP18SS	P206543	RKRM	T1411	P206353	ROSS	
RI353	P206314	RKRM	S226198	M070069	CASE	SC015042039	H001039	URIG	SP19SS	P206543	RKRM	T1412	P270837	ROSS	
RI375	P207386	RKRM	S228668	M120189	CASE	SC015042057	P270543	URIG	SP200A	P206331	PDCI	T1430	P206336	ROSS	
RI430	P206315	RKRM	S228672	M090091	CASE	SF3120	P226144	GRMC	SP250A	P206333	PDCI	T200	P206403	AP	
RI435	P206316	RKRM	S230848	M060232	CASE	SF3300	P226132	GRMC	SP275A	J000127	PDCI	T212	P206405	AP	
RI540	P206317	RKRM	S231674	M090301	CASE	SF35120	P226145	GRMC	SP5201	M120100	WBCO	T214	P206404	AP	
RI650	P206318	RKRM	S237009	M100146	CASE	SF3518	P206553	GRMC	SPA1485PL	P206510	RKRM	T234	P206406	AP	
RI650PL	P206318	RKRM	S3120SBA	P206334	GRMC	SF3524	J024850	GRMC	SPA1710PL	P206512	RKRM		P206406	TRUX	
RJ430	J009648	RKRM	S358SBA	P206335	GRMC	SF35300	P226133	GRMC	SPA1750PL	P206509	RKRM	T2340474	P270539	CASE	
RJ540	J009649	RKRM	S3637	P208374	HRBR	SF412	P226146	GRMC	SPF5500	P207784	RKRM		P270539	PTN	
RM13093075	J009604	IR	S38SBA	P206362	GRMC	SF418	P206554	GRMC	SP140060PL	P224605	RKRM	T300	P206407	TRUX	
RM13271606	M091047	IR	S39263	M085008	MJPR	SF424	J024836	GRMC	SP150136PL	P216227	RKRM		P206407	TRUX	
RM13861232	P270543	IR	S4120SBA	P206366	GRMC	SF436	P226156	GRMC	SP150148PL	P216228	RKRM	T300Z	P206407	TRUX	
RM43846880	M001756	IR	S418EXA	P207282	GRMC	SF512	J240007	GRMC	SP150160PL	J540008	RKRM	T303602	M100572	COUG	
RM43849355	M002118	IR	S424EXC	P224627	GRMC	SF5120	P226147	GRMC	SPO30024	P216191	RKRM	T303710	P206849	COUG	
RM43897180	P207596	IR	S424SBA	J240012	GRMC	SF518	P206555	GRMC	SPO30048	P207285	RKRM	T304042	P206851	COUG	
RM43904515	P222744	IR	S436EXA	P208364	GRMC	SF524	J024838	GRMC	SPO30048PL	P207314	RKRM	T312	P206409	AP	
RM43919646	M090210	IR	S436EXC	P224628	GRMC	SF524	J024838	GRMC	SPO30824	P208328	RKRM		P206409	TRUX	
RM43927623	P206325	IR	S448EXA	P207287	GRMC	SF5300	P226158	GRMC	SPO30836	P206376	RKRM	T312Z	P206409	TRUX	
RM46634150	M065073	IR	S448SBA	P206378	GRMC	SF536	J034674	GRMC	SPO30836PL	P206376	RKRM	T314	P206408	TRUX	
RM4664150	M065073	IR	S448SBC	P206388	GRMC	SF6120	P226153	GRMC	SPO30848	P206376	RKRM		P206408	AP	
RM59801860	H001039	IR	S460EXA	P207288	GRMC	SFA1214	P206303	AMC	SPO35024	J024735	RKRM	T3626ID	P207619	GRMC	
RMH10	P206519	GRMC	S472SBA	J640001	GRMC				SPO35048	P208348	RKRM	T378801	M060055	HSTR	
RMH11	P224841	GRMC	S48SBA	P206364	GRMC							T384786	M065034	HSTR	
												T400	P205979	RKRM	
													P206410	TRUX	
													P206410	AP	
													P206410	TRUX	

Mfgs. No.	Our No.	Mfg. Code	Mfgs. No.	Our No.	Mfg. Code	Mfgs. No.	Our No.	Mfg. Code	Mfgs. No.	Our No.	Mfg. Code	Mfgs. No.	Our No.	Mfg. Code
T412Z	J000231	TRUX	TFS500	X007785	RKRM	UF500	P206603	RKRM	W			X141520270	M090301	SRC
T4256ID	P207581	GRMC	TJ700293000	P206340	PTBN	UF500PL	P206611	RKRM	W0M090159	M090159	FRAM	X14152028	P206342	ISZU
T4756ID	P207620	GRMC	TJ841074700	X007831	PTBN	UF600PL	P207598	RKRM	W2440435	P270538	CASE	X141520280	P206342	SRC
T50	M045237	COMP	TJ841076000	X004478	PTBN	UH100	P206507	RKRM		P270538	PTN	X14152029	P270538	ISZU
T500	P206299	RKRM	TJF122164	J000202	PTBN		P206507	PDCI	WFC3	X007830	GRMC	X141520290	P270538	SRC
	P206411	AP	TOHD2427	M070069	SCRM	UH340	P270543	RKRM	WFC4	X007784	GRMC	X14152030	P206409	ISZU
	P206411	TRUX	TP4001015	M120100	TAC	UH450	P207784	RKRM	WFC4A	X007824	GRMC	X141520300	P206409	SRC
T500Z	P206411	TRUX	TP8275240	J009618	PTBN	UT46661	M090158	UAC	WFC5	X007785	GRMC	X141520430	P2070539	ISZU
T5XA601M	M085208	COUG	TSC400	X007784	RKRM	UV250	P206606	RKRM	WFC5A	X007805	GRMC	X14152048	P270532	ISZU
T5XA605M	P270536	COUG	TSC500	X007785	RKRM	UV277	J009618	RKRM	WM26002	M070069	TDSC	X141520480	P270532	SRC
T5XB601M	M085208	COUG	TTA300	X007833	RKRM	UV300	P206604	RKRM	WR125158	M001702	AGCO	X150	P222748	MRMT
T600	P207667	TRUX	TTA350	X007834	RKRM	UV350	P206605	RKRM	WR125159	M085409	AGCO	X1750597	H001279	PTN
	P207667	AP	TTA400	X007824	RKRM	UV400	P206606	RKRM	WR125161	X006380	AGCO		H001279	CASE
T600Z	P207667	TRUX	TTA500	X007805	RKRM	UV401	J009614	RKRM	WR128453	M002119	AGCO	X205	X004536	MRMT
TAA400	J000202	RKRM	TTA600	J190055	RKRM	UV478	P206605	RKRM	WR24908	M080018	AGCO	X230	X004537	MRMT
TAC360	M090680	TAC	TTS200	J190056	RKRM	UV500	P206607	RKRM	WR28656	X004482	AGCO	X2440436	M070069	CASE
TAC370	M085172	TAC	TTS225	J190057	RKRM	UV501	P206607	RKRM	WR28658	P207297	AGCO		M070069	PTN
TAC400BB	M090544	TAC	TTS250	X007829	RKRM	V			WR32441	P206321	AGCO	X255	X004476	MRMT
TAC427	M090146	TAC	TTS275	J190059	RKRM	V1091149	X006202	VLVO	WR32821	X004478	AGCO	X270	J009612	MRMT
TAC466	M090520	TAC	TTS300	X007830	RKRM	V111111	M090535	VLVO	WR34818	M065044	AGCO	X275	J000224	MRMT
TAC800	M090280	TAC	TTS350	X007831	RKRM	V1111110	M100465	VLVO	WR34821	J240004	AGCO	X280	X004538	MRMT
TAC800L	M090534	TAC	TTS400	X007784	RKRM	V1111110	M100465	VLVO	WR37234	J014623	AGCO	X295	J009611	MRMT
TAC801	M110189	TAC	TTS500	X007785	RKRM	V1111111	M090544	VLVO		P206311	AGEM	X300	J000227	MRMT
TAC900	M090563	TAC	TTS600	X009076	RKRM	V1111112	M090535	VLVO	WR37235	P206311	WILM	X305	X004478	MRMT
TBA350	X006204	RKRM	U			V1111112	M090535	VLVO		M100048	AGCO	X350	J000228	MRMT
TBA4	P205976	GRMC	U112	P222748	AP	V1111113	M100464	VLVO		M100048	AGEM	X355	X006204	MRMT
TBA400	X006203	RKRM	U200	P206403	RKRM	V1111114	M100464	VLVO	WT200	P206331	RKRM	X370	P206605	MRMT
TBA5	P206300	GRMC	U200Z	P206403	RKRM	V1114917	M100463	VLVO	WT200CR	P206331	RKRM	X400	J000230	MRMT
TBA500	X006202	RKRM	U212	P206405	TRUX	V1116639	M100213	VLVO	WT250	P206333	RKRM	X405	X006203	MRMT
TBB61240011	M110674	FRTL	U225	P206404	RKRM	V1119466	X006203	VLVO	WT250CR	P206333	RKRM	X505	X006202	MRMT
TBB61240169	M120713	FRTL	U225Z	P206404	RKRM	V6772734	X004480	VLVO	WT275CR	J000127	RKRM	X5103064	M090091	GRDL
TBE4	P205979	GRMC	U250	P206405	RKRM	V8056009	M100465	VLVO	WT300	P206334	RKRM	X5103065	J009649	GRDL
TBE5	P206299	GRMC	U250Z	P206405	RKRM	V8056472	X004962	VLVO	WT300CR	P206334	RKRM	X5103066	P207354	GRDL
TBS400	X007784	RKRM	U275	P206406	RKRM	V98HA5225AA	M100580	MERS	WT350	P206335	RKRM	X5103067	J009637	GRDL
TBS500	X007785	RKRM	U275Z	P206406	RKRM	VA21040004A	P270538	GRDL	WT350CR	P206335	RKRM	X5103068	J024750	GRDL
TCBH084	M070028	PTBN	U300	P206407	RKRM	VA21040034A	P270541	GRDL	WT400	P206336	RKRM	X8821116	P206605	LIBB
TCBH087	P206507	PTBN	U300PL	P206407	RKRM	VA21270018A	P206409	GRDL	WT400CR	P206336	RKRM	XA58300	M070028	CASE
TCBH135	M070325	PTBN	U300Z	P206407	RKRM	VA21270020A	P206407	GRDL	WT500	P206337	RKRM	XD200	J000220	MRMT
TD001	M065065	MRMT	U325	P206408	RKRM	VA22750032	P206397	GRDL	WT600	P206338	RKRM	XD225	J000222	MRMT
TD002	M085023	MRMT	U325Z	P206408	RKRM	VA22750032A	P206397	GRDL	WT600CR	P206338	RKRM	XD250	J000221	MRMT
TD017	M090535	MRMT	U350	P206409	RKRM	VA22750033A	P206372	GRDL	WTM100104	M100464	DART	XD275	J000224	MRMT
TD019	M085008	MRMT	U350Z	P206409	RKRM	VA22750563	P206340	GRDL	WZM100464	M100464	FRTL	XD350	M085008	RKRM
TD022	M060232	MRMT	U400	P206410	RKRM	VA25990014	M090210	GRDL		M100464	DART	XD355	M085008	RKRM
TD1	M065065	MRMT	U400PL	P206410	RKRM	VA25990015	M090210	GRDL	X			XD4019	M100049	RKRM
TD17	M090535	MRMT	U450Z	J000231	RKRM	VA34160003	P270541	GRDL	X004482016147	X004482	AJMC	XD414	M090594	RKRM
TD19	M085008	MRMT	U450Z	P206409	RKRM	VA34240209	P206543	GRDL	X005164	X007831	TIPP	XD415	M085171	RKRM
TD2	M085023	MRMT	U500	P206411	RKRM	VA34240210	P206508	GRDL	X005265	X007829	SCRM	XH4M2	M090680	NFC
TD22	M060232	MRMT	U500PL	J009487	RKRM	VA34240339	P206508	GRDL	X1034633	M060055	ELGN	XH4MD1	M090563	NFC
TD22	M060232	MARE	U500Z	P206411	RKRM	VA40250001	P207596	GRDL	X12209	M060247	RKRM	XSC212	X004476	NFC
TDA400	P206304	TAC	UA300	J000227	RKRM	VA48950705A	P206372	GRDL	X12259	M060005	RKRM	XSC214	X004537	NFC
TE840001	M080024	TREX	UA350	J000228	RKRM	VA48951215	P206379	GRDL	X12309	M070008	RKRM	XSC234	X004538	NFC
TEC200	J000210	RKRM	UA400	J000230	RKRM	VA601343	P206325	GRDL	X12309	M070008	RKRM	XSC312	X004480	NFC
TEC225	J000212	RKRM	UA400PL	J009486	RKRM	VA602286	M070028	GRDL	X12359	M070050	RKRM	XSC4	X004482	NFC
TEC250	J000211	RKRM	UA400Z	P206410	RKRM	VA604749	J024735	GRDL	X12409	M090009	RKRM	XX0070721	P206312	SABI
TEC275	J000213	RKRM	UA500	J000232	RKRM	VB475C	P222018	GRMC	X14152004	P270531	ISZU	XX0070722	P207332	SABI
TEC300	J000214	RKRM	UA600	J000233	RKRM	VB475D	P206606	GRMC	X14152005	M085090	ISZU	XX0070724	J024838	SABI
TEC350	J000215	RKRM	UAF300	P206600	RKRM	VB588C	P206607	GRMC	X141520050	M085090	SRC	XX0071216	X004484	SABI
TEC400	J000216	RKRM	UAF300PL	P206608	RKRM	VF140V	P206546	VLVO	X14152007	P270536	ISZU	Y		
TEC450	J000219	RKRM	UAF350	P206601	RKRM	VP0644	M090009	FRHF	X141520070	P270536	SRC	Y05667000	X004482	FDEN
TEC500	J000217	RKRM	UAF350PL	P206608	RKRM	VP0673	M070008	FRHF	X14152014	P270531	ISZU	Y05667111	X004484	FDEN
TEC600	J000218	RKRM	UAF400	P206602	RKRM	VP19332	X004482	FRHF	X141520140	P270531	ISZU	Y0602300162	M085208	DENY
TEL40090	P206344	TAC	UAF400PL	P206610	RKRM	VP20093	M120154	FAST		P270531	SRC	Y0602300395	M090598	DENY
TFC200	X004536	RKRM	UAF500	P206603	RKRM		M120154	FRHF	X14152019	M065034	ISZU	Y0602325066	M001432	DENY
TFC225	X004537	RKRM	UAF500PL	P206611	RKRM	VP20096	M120197	FAST	X14152022	M065044	ISZU	Y0602325088	X004476	DENY
TFC250	X004476	RKRM	UAF600	P207596	RKRM		M120197	FAST	X141520220	M065044	SRC	Y0602325089	X004478	DENY
TFC275	X004538	RKRM	UAF600PL	P207598	RKRM	VP20097	M120365	PLOC	X14152023	P207324	ISZU	Y0602325097	X004536	DENY
TFC300	X004478	RKRM	UF300PL	P206608	RKRM	VP20098	M070068	FRHF	X141520230	P207324	SRC	Y400	P206297	RKRM
TFC350	X004480	RKRM	UF400	P206602	RKRM	VP644	M090009	FAST	X14152024	P270534	ISZU	Y401NPA	P206297	GRMC
TFC400	X004482	RKRM	UF400PL	P206602	RKRM	VP673	M070008	FAST	X141520240	P270534	SRC	Y500	P206298	RKRM
TFC500	X004484	RKRM	UF500	P206603	RKRM	VT71457	M060037	UAC		P270534	ISZU	Y500NPA	P206298	GRMC
TFC600	X004539	RKRM	UF400PL	P206610	RKRM	YV6771	M085056	WBCC	X14152027	M090301	ISZU	YB400A	J092679	GRMC

Cross Reference

(See the first page of this section for the Manufacturer's Code Listing)



CROSS REFERENCE

Mfgs. No.	Our No.	Mfg. Code
YB500A.....	J092689....	GRMC
YS400.....	J092679....	RKRM
YS500.....	J092689....	RKRM

Z

Z1540470	P270541	CASE
	P270541	PTN
Z1750597	H001279	CASE
	H001279	PTN
Z3036919	X004478	PTN
	X004478	CASE
ZDNP206336..	P206336	NAVI
ZF305	M060037 ..	MRMT
ZF306	M065030 ..	MRMT
ZF307	M070068 ..	MRMT
ZF308	M070069 ..	MRMT
ZF604	M080024 ..	MRMT
ZF605	M090091 ..	MRMT
ZF606	M090072 ..	MRMT
ZF615	M085172 ..	MRMT
ZF665	M085267 ..	MRMT
ZF855	M120100 ..	MARE
	M120100 ..	MRMT
ZF860	M090538 ..	MRMT
ZF868	M090280 ..	MRMT
ZF869	M090563 ..	MARE
	M090563 ..	MRMT
ZF895	M110012 ..	MRMT
ZF917	M090534 ..	MRMT
ZF947	M090520 ..	MRMT
ZF955	M090547 ..	MRMT
ZF956	M120154 ..	MRMT
ZH002	M120365 ..	MRMT
ZH003	M120197 ..	MRMT
ZH012	M110189 ..	MRMT
ZH201	M100464 ..	MARE
	M100464 ..	MRMT
ZH202	M090544 ..	MRMT
ZH203	M090544 ..	MRMT
ZH206	M090535 ..	MRMT
ZH209	M090146 ..	MRMT
ZZ8002001	P206400	NPRT
	P206400	NEPN

When all you have is a Donaldson part number, this section will lead you to the proper page in the catalog where specific information on that part number can be found.

In some cases you will find multiple page numbers listed, for products such as: mufflers (with references to the specifications section and the muffler selection by engine performance section); and clamps (with references to both dimensional and application information).

Part No.	Page(s)	Part No.	Page(s)	Part No.	Page(s)	Part No.	Page(s)	Part No.	Page(s)
H000165	60	H002070	63	J000219	28	J009639	43	J190014	42
H000170	60	H002612	50	J000220	28	J009640	43	J190016	42
H000275	60	H002613	50	J000221	28	J009641	43	J190017	42
H000276	60	H002614	50	J000222	28	J009644	43	J190019	42
H000339	60	H002615	50	J000224	28	J009645	43	J190020	42
H000349	62	H002616	50	J000227	28	J009648	35	J190023	43
H000350	62	H002617	50	J000228	28	J009649	35	J190025	43
H000351	62	H002618	50	J000230	28	J009650	35	J190027	43
H000466	60	H002619	50	J000231	28	J014621	47	J190041	34
H000467	60	H002762	50	J000232	28	J014622	47	J190042	35
H000468	60	H002763	50	J000233	28	J014623	47	J190044	35
H000469	60	H002764	50	J008167	36	J018110	43	J190045	35
H000470	60	H002765	50	J008671	41	J024735	46	J190046	34
H000471	60	H002766	50	J008681	41	J024737	46	J190054	28
H000472	60	H002767	50	J008942	34	J024739	46	J190055	28
H000473	60	H002768	50	J009391	33	J024746	47	J190056	28
H000483	61	H002769	50	J009393	33	J024747	47	J190057	28
H000484	61	H008441	63	J009429	37	J024748	47	J190058	28
H000604	60	H008442	63	J009479	33	J024749	47	J190059	28
H000605	60	H008443	63	J009486	28	J024750	47	J190060	28
H000606	60	H008444	63	J009487	28	J024751	47	J190061	28
H000607	60	H770037	62	J009514	40	J024754	31	J190062	28
H000722	50	H770068	62	J009516	40	J024755	31	J190063	28
H001023	50			J009518	40	J024757	47	J240003	31
H001053	60	J000127	45	J009547	41	J024758	47	J240004	31
H001063	60	J000200	28	J009560	42	J024835	31	J240005	31
H001200	58	J000201	28	J009604	28	J024836	31	J240006	31
H001278	49	J000202	28	J009605	28	J024837	31	J240007	31
H001279	49	J000203	28	J009606	28	J024838	31	J240012	46
H001284	49	J000204	28	J009607	28	J024850	31	J240024	46
H001377	59	J000205	28	J009611	32,33	J028528	43	J340023	46
H001378	59	J000206	28	J009612	32	J034673	31	J540008	46
H001379	59	J000207	28	J009613	32	J034674	31	J640001	46
H001654	58	J000208	28	J009614	32	J034743	31	J640005	47
H001660	58	J000209	28	J009618	32	J034744	31		
H001661	58	J000210	28	J009623	28	J034746	47	M001327	45
H001742	60	J000211	28	J009624	28	J038611	43	M001432	26
H001756	60	J000212	28	J009629	33	J038612	43	M001502	26
H001773	60	J000213	28	J009631	44	J092679	35	M001503	26
H001946	60	J000214	28	J009632	44	J092689	35	M001504	26
H001947	60	J000215	28	J009633	44	J190002	41	M001505	26
H001948	60	J000216	28	J009635	44	J190003	41	M001506	26
H002023	63	J000217	28	J009636	44	J190004	41	M001566	26
H002068	59	J000218	28	J009637	44	J190013	42	M001593	26

Part No.	Page(s)	Part No.	Page(s)	Part No.	Page(s)	Part No.	Page(s)	Part No.	Page(s)
M001668.....	26	M070068.....	48	M100043.....	68,76,83	M120598.....	69,78,81	P105611.....	53
M001702.....	26	M070069.....	48	M100048.....	68,76,83	M120713.....	70,78,85	P105612.....	53
M001703.....	26	M080018.....	67,74,79	M100049.....	70,76,85	M120747.....	67,78,80	P105613.....	53
M001756.....	26	M080024.....	48	M100052.....	70,76,84	M120748.....	68,78,83	P105622.....	57
M001799.....	26	M085008.....	68,74,82	M100146.....	69,76,81	M120749... 69,70,78,81,84		P106593.....	56
M001865.....	26	M085023.....	68,74,82	M100213.....	69,76,81	M120750.....	70,78,85	P107844.....	51
M001866.....	26	M085056.....	68,74,82	M100463.....	67,76,80	M120751.....	71,78,86	P109021.....	52
M001867.....	26	M085078.....	68,74,82	M100464.....	67,76,79	M122300.....	68,78,83	P109331.....	52
M002117.....	29	M085080.....	68,74,82	M100465.....	67,76,80	M140048.....	68,78,83	P111414.....	53
M002118.....	29	M085084.....	69,74,81	M100466.....	67,76,79	M170101.....	68,78,83	P112605.....	51
M002119.....	29	M085090.....	69,74,81	M100572.....	71,76,86	M190002.....	68,78,83	P112606.....	52
M002120.....	29	M085171.....	67,74,79	M100580.....	67,76,80			P112607.....	52
M002121.....	29	M085172.....	69,74,82	M100582.....	67,76,80	P002348.....	62	P112608.....	53
M002122.....	29	M085189.....	69,74,82	M100695.....	67,76,79	P002351.....	62	P112609.....	52
M002123.....	29	M085206.....	70,74,84	M100807.....	67,76,80	P003245.....	62	P112610.....	52
M002134.....	26	M085207.....	70,74,85	M100944.....	67,76,80	P004073.....	62	P112611.....	52
M002135.....	26	M085208.....	71,74,86	M101158.....	67,76,80	P004076.....	62	P112803.....	56
M002164.....	26	M085226.....	69,74,81	M101159.....	67,76,80	P004079.....	62	P113733.....	51
M002480.....	36	M085267.....	69,74,82	M101167.....	67,76,79	P004307.....	62	P114313.....	52
M002482.....	36	M085293.....	67,74,79	M101168.....	68,76,83	P004906.....	62	P114314.....	51
M002484.....	36	M085407.....	67,74,79	M101169... 69,70,76,81,84		P007189.....	62	P114315.....	52
M002485.....	36	M085408.....	68,74,82	M101170.....	70,76,85	P007191.....	62	P114316.....	52
M002486.....	36	M085409... 69,70,74,81,84		M101171.....	71,76,86	P013722.....	62	P114317.....	53
M002487.....	36	M085410.....	70,74,85	M101181.....	67,76,80	P016845.....	62	P114318.....	51
M002488.....	36	M085411.....	71,74,86	M101182.....	67,76,80	P100089.....	57	P114319.....	53
M002490.....	36	M085421.....	67,74,79	M101263.....	67,77,80	P101290.....	52	P115200.....	50,55
M002491.....	36	M090009.....	67,74,79	M110012.....	68,77,83	P101291.....	52	P115201.....	55
M045123.....	48	M090072.....	48,74,80	M110014.....	70,77,84	P101292.....	52	P115202.....	55
M045193.....	69,73,81	M090074.....	67,75,80	M110077.....	68,77,83	P101293.....	52	P115203.....	55
M045237.....	67,73,79	M090091.....	48	M110112.....	70,77,84	P101294.....	52	P115204.....	55
M060005.....	67,73,79	M090095.....	67,75,79	M110148.....	70,77,84	P101891.....	52	P115205.....	55
M060037.....	48	M090146.....	67,75,79	M110189.....	68,77,83	P102820.....	52	P115206.....	55
M060038.....	48	M090158.....	68,75,82	M110311.....	70,77,84	P102948.....	53	P115207.....	55
M060055.....	68,73,82	M090159.....	68,75,82	M110479.....	69,77,81	P103198.....	56	P115208.....	55
M060158.....	69,73,81	M090170.....	68,75,82	M110674.....	69,77,81	P103516.....	52	P115209.....	55
M060232.....	68,73,82	M090210.....	68,75,82	M110849.....	67,77,80	P104087.....	53	P117724.....	51
M060247.....	67,73,79	M090280.....	68,75,83	M111024.....	69,77,81	P104088.....	53	P121482.....	51
M060250.....	70,73	M090301.....	69,75,81	M111025.....	70,77,84	P104089.....	53	P122067.....	57
M060251.....	71,73,86	M090362.....	48,75,79	M111026.....	71,77,86	P104090.....	53	P123462.....	51
M060479.....	67,73,79	M090520.....	68,75,83	M111028.....	68,77,83	P105220.....	56	P126530.....	52
M060480.....	68,73,82	M090534.....	68,75,83	M111029.....	67,77,79	P105529.....	51	P128990.....	51
M060481... 69,70,73,81,84		M090535.....	67,75,80	M120100.....	68,77,83	P105530.....	51	P129660.....	52
M060482.....	70,73,85	M090538.....	68,75,83	M120108.....	68,77,83	P105531.....	51	P133338.....	52
M060483.....	71,73,86	M090544.....	67,75,79	M120131.....	70,77,85	P105532.....	51	P133339.....	52
M065030.....	48	M090547.....	70,75,84	M120135.....	70,77	P105533.....	51	P136494.....	52
M065034.....	68,73,82	M090548.....	70,75,84	M120154.....	70,77,85	P105534.....	51	P143422.....	55
M065044.....	69,73,81	M090563.....	69,75,82	M120176.....	70,77,85	P105535.....	51	P143895.....	51
M065065.....	68,73	M090594.....	67,75,79	M120189.....	70,77,85	P105536.....	51	P148337.....	55
M065071.....	67,73,79	M090595.....	67,75,80	M120197.....	68,77,83	P105541.....	52	P148338.....	55
M065073.....	70,73,85	M090598.....	71,75,86	M120225.....	68,77,83	P105542.....	52	P148339.....	55
M065074.....	71,73,86	M090680.....	68,75,83	M120235.....	69,78,81	P105543.....	52	P148340.....	55
M065138.....	67,73,79	M090781.....	67,75,79	M120365.....	68,78,83	P105544.....	52	P148341.....	55
M065139.....	68,73,82	M090823.....	69,75,81	M120366.....	70,78,84	P105545.....	52	P148342.....	55
M065140... 69,70,73,81,84		M091046.....	67,75,79	M120367.....	70,78,84	P105546.....	52	P148343.....	55
M065141.....	70,73,85	M091047.....	68,76,83	M120382.....	69,78,81	P105547.....	52	P148344.....	55
M065142.....	71,73,86	M091048... 69,70,76,81,84		M120418.....	71,78,86	P105548.....	52	P148345.....	55
M070008.....	67,74,79	M091049.....	70,76,85	M120448.....	68,78,83	P105608.....	53	P148346.....	55
M070028.....	67,74,79	M091050.....	71,76,86	M120450.....	70,78,85	P105609.....	53	P148347.....	55
M070050.....	67,74,79	M100016.....	48	M120566.....	69,78,81	P105610.....	53	P148348.....	55

Part No.	Page(s)	Part No.	Page(s)	Part No.	Page(s)	Part No.	Page(s)	Part No.	Page(s)
P148349	55	P206343	41	P206508	41	P207290	47	P207394	34
P148350	55	P206344	41	P206509	41	P207292	46	P207397	34
P149099	56	P206345	41	P206510	37	P207293	47	P207401	34
P158914	56	P206346	42	P206511	37	P207295	47	P207402	34
P159820	51	P206347	41	P206512	37	P207296	47	P207405	34
P171376	50	P206348	41	P206515	37	P207297	47	P207408	34
P171378	50	P206349	42	P206516	37	P207298	47	P207411	34
P171381	50	P206350	41	P206517	37	P207299	46	P207413	34
P205976	35	P206353	41	P206518	37	P207300	46	P207414	34
P205979	35	P206354	41	P206519	37	P207301	47	P207415	47
P206279	43	P206361	34	P206520	37	P207302	47	P207419	47
P206280	43	P206362	34	P206521	37	P207308	47	P207559	47
P206281	43	P206363	34	P206523	36	P207309	47	P207566	33
P206282	43	P206364	34	P206524	36	P207312	47	P207567	33
P206283	43	P206365	34	P206525	36	P207314	46	P207568	33
P206285	43	P206366	34	P206526	36	P207318	47	P207581	33
P206286	43	P206367	34	P206540	37	P207319	47	P207582	33
P206297	35	P206368	34	P206542	37	P207320	47	P207584	33
P206298	35	P206369	34	P206543	41	P207321	47	P207596	28
P206299	35	P206370	34	P206544	31	P207322	42	P207598	28
P206300	35	P206371	34	P206546	31	P207324	42	P207619	33
P206301	47	P206372	34	P206547	31	P207325	42	P207620	33
P206302	47	P206373	34	P206552	31	P207326	42	P207667	28
P206303	47	P206374	34	P206553	31	P207327	42	P207784	36
P206304	47	P206375	34	P206554	31	P207328	42	P208324	46
P206305	47	P206376	46	P206555	31	P207329	42	P208326	47
P206306	47	P206377	46	P206556	31	P207330	42	P208328	46
P206308	47	P206378	46	P206559	31	P207331	42	P208330	47
P206309	47	P206379	46	P206600	28	P207332	42	P208336	46
P206310	47	P206380	47	P206601	28	P207333	41	P208338	47
P206311	47	P206381	47	P206602	28	P207335	41	P208348	46
P206312	47	P206382	47	P206603	28	P207338	41	P208350	47
P206313	34	P206383	47	P206604	32,33	P207339	41	P208358	47
P206314	34	P206384	47	P206605	32,33	P207340	41	P208359	47
P206315	34	P206385	47	P206606	32,33	P207341	41	P208364	46
P206316	34	P206386	47	P206607	32,33	P207345	41	P208366	47
P206317	34	P206387	47	P206608	28	P207346	41	P208374	47
P206318	34	P206388	46	P206609	28	P207347	44	P208375	47
P206319	34	P206389	46	P206610	28	P207349	44	P208380	46
P206320	34	P206390	46	P206611	28	P207350	44	P208382	47
P206321	34	P206391	46	P206612	33	P207351	44	P208386	47
P206322	34	P206393	44	P206613	33	P207352	44	P208388	47
P206323	34	P206394	44	P206614	33	P207353	44	P208389	47
P206324	34	P206395	44	P206615	33	P207354	44	P208392	47
P206325	34	P206396	44	P206616	40	P207355	44	P208393	46
P206326	34	P206397	42	P206617	40	P207359	43	P208394	47
P206327	34	P206398	42	P206641	40	P207361	42	P208395	47
P206328	34	P206399	42	P206849	45	P207362	42	P209910	47
P206331	45	P206400	42	P206850	45	P207363	42	P209912	47
P206333	45	P206403	28	P206851	45	P207364	42	P209913	47
P206334	45	P206404	28	P206927	47	P207365	42	P210110	32,33
P206335	45	P206405	28	P207281	46	P207366	42	P212925	32
P206336	45	P206406	28	P207282	46	P207367	45	P213191	32
P206337	45	P206407	28	P207283	46	P207368	45	P216169	44
P206338	45	P206408	28	P207285	46	P207369	45	P216172	41
P206339	41	P206409	28	P207286	46	P207382	34	P216174	42
P206340	41	P206410	28	P207287	46	P207385	34	P216175	42
P206341	41	P206411	28	P207288	46	P207386	34	P216191	46
P206342	41	P206507	36	P207289	46	P207389	34	P216197	46

Part No.	Page(s)	Part No.	Page(s)	Part No.	Page(s)	Part No.	Page(s)	Part No.	Page(s)
P216200	47	P224710	47	P235766	30	P532951	54	X004962	27,28
P216202	47	P224711	47	P235767	30	P532952	54	X005207	37
P216204	47	P224841	37	P235768	30	P532953	54	X006202	27
P216205	47	P226129	30	P235769	30	P532954	54	X006203	27
P216206	47	P226132	30	P235770	42	P532956	54	X006204	27
P216227	46	P226133	30	P235771	42	P532957	54	X007276	57
P216228	46	P226140	30	P235772	42	P532958	54	X007335	57
P222017	32	P226141	30	P235787	44	P532959	54	X007784	27,28
P222018	32	P226142	30	P235788	44	P532960	54	X007785	27,28
P222740	28	P226143	30	P235789	44	P532961	54	X007805	27,28
P222741	28	P226144	30	P235790	45	P532962	54	X007824	27,28
P222742	28	P226145	30	P235792	33	P535571	54	X007829	27,28
P224412	31	P226146	30	P235793	33	P535572	54	X007830	27,28
P224415	31	P226147	30	P235796	33	P535573	54	X007831	27,28
P224418	31	P226148	30	P235797	33	P536163	51	X007833	27,28
P224421	31	P226149	30	P238111	28	P537468	51	X007834	27,28
P224479	31	P226150	30	P238112	28	P540256	52	X009076	27,28
P224481	31	P226151	30	P238113	28	P547694	53		
P224492	41	P226152	30	P270530	36	P600325	53		
P224515	31	P226153	30	P270531	36	P600326	53		
P224518	31	P226154	30	P270532	36	P600327	53		
P224521	31	P226155	30	P270533	36	P600328	53		
P224581	45	P226156	30	P270534	36	P604045	52		
P224582	45	P226157	30	P270535	36	P617632	56		
P224589	46	P226158	30	P270536	36	P776008	56		
P224590	46	P226914	38	P270538	36	P777151	63		
P224600	47	P227167	38	P270539	36	P777730	63		
P224604	46	P227170	38	P270540	36	P777731	63		
P224605	46	P227175	38	P270541	36	P777732	63		
P224607	46	P227178	38	P270542	36	P778810	63		
P224608	46	P227179	37	P270543	36	P780532	63		
P224609	46	P227182	39	P270837	36	P780594	63		
P224611	46	P227215	38	P270838	36				
P224614	46	P227728	38	P271507	36	X001744	61		
P224616	46	P227750	32	P271511	36	X001746	61		
P224617	47	P227803	29	P520882	52	X001747	61		
P224618	47	P227804	29	P520883	52	X001966	59		
P224627	46	P227805	38	P520884	52	X001988	59		
P224628	46	P227839	39	P522439	62	X002014	59		
P224633	47	P228241	29	P522958	56	X002015	59		
P224635	47	P228258	38	P524552	62	X002017	59		
P224636	47	P228260	39	P525956	56	X002018	59		
P224638	47	P229114	39	P532919	55	X002019	59		
P224641	47	P229513	29	P532920	55	X002101	57		
P224669	41	P229851	32	P532921	55	X002102	57		
P224671	41	P230045	29	P532922	55	X002103	57		
P224684	45	P230046	38	P532923	55	X002275	57		
P224685	45	P230047	38	P532924	50,55	X002277	57		
P224686	45	P230281	29	P532925	55	X002278	57		
P224687	45	P230282	29	P532926	55	X003691	61		
P224692	45	P230283	29	P532927	55	X004476	27,28		
P224693	45	P230284	38	P532928	55	X004478	27,28		
P224696	46	P230761	37	P532929	55	X004480	27,28		
P224698	46	P230762	37	P532943	54	X004482	27,28		
P224699	46	P233421	37	P532944	54	X004484	27,28		
P224701	46	P233422	37	P532945	54	X004536	27,28		
P224703	46	P235305	32	P532948	54	X004537	27,28		
P224707	46	P235764	30	P532949	54	X004538	27,28		
P224709	47	P235765	30	P532950	54	X004539	27,28		

Engine Model	RPM	Intake HP	Intake CFM	-- Exhaust --	
				Temp. (°F)	Flow (CFM)
DETROIT DIESEL CONTINUED					
Series 50 (8.5 Ltr)					
2100	250	760	625	1575	
2100	275	790	680	1720	
2100	300	820	715	1845	
2100	320	815	730	1861	
2100	350	815	850	2055	
Series 60 (12.7 Ltr)					
2100	330	1050	610	2157	
2100	350	1090	645	2310	
2100	370	1010	725	2300	
2100	400	1050	780	2500	
2100	430	1080	820	2652	
2100	470	1170	825	2877	
2100	500	1170	825	2877	
Series 60 (14 Ltr)					
2100	550	1231	986	3402	
2100	575	1271	867	3221	

DEUTZ					
BF12L 714	2300	390	695	850	1686
BF6L 913	2800	175	396	850	961
F10L 413	2650	310	595	850	1443
F10L 714	2300	275	577	850	1400
F12L 413	2650	370	714	850	1732
F12L 714	2300	330	695	850	1686
F1L 208	3600	9	70	850	170
F1L 210	3000	16	96	850	233
F1L 411D	3000	16	98	850	238
F2L 411D	3000	32	133	850	323
F2L 411W	3000	30	133	850	323
F2L 912	2500	36	150	850	364
F2L 912W	2500	34	150	850	364
F3L 912	2800	60	176	850	427
F3L 912W	2500	50	158	850	383
F4L 912	2800	80	202	850	490
F4L 912W	2500	67	180	850	437
F5L 912	2800	100	210	850	509
F5L 912W	2500	84	187	850	454
F6L 413	2650	185	357	850	866
F6L 714	2300	165	347	850	842
F6L 912	2800	120	252	850	611
F6L 912W	2500	101	224	850	543
F8L 413	2650	250	476	850	1155
F8L 714	2300	220	463	850	1123

FORD					
00	2400	59	101	900	254
172DF	2400	59	101	900	254
175DF	2500	52	108	900	272
183D	2200	52	99	900	249
192DF	2400	65	113	900	285
201DF	2250	66	111	900	280
220	2400	69	130	900	327
233D	2100	68	120	900	302
242D	2230	76	133	900	335
242DF	2500	79	149	900	375
254DF	2500	80	157	900	395
256DF	2500	89	157	900	395
3320DF	2500	111	203	900	511
362DF	2500	121	223	900	562
363DFT	2400	150	214	900	539
380DF	2500	120	233	900	587
401DF	2500	132	246	900	620
401DFT	2500	167	246	900	620

Engine Model	RPM	Intake HP	Intake CFM	-- Exhaust --	
				Temp. (°F)	Flow (CFM)
67GF	3600	32	60	900	151
98GF	3600	45	87	900	219
X	2250	60	122	900	307
Y	2250	96	183	900	461

HATZ DIESEL					
2L30	3000	30	68	1100	196
2L40	3000	37	82	1100	237
2M40	3000	40	85	1100	246
3L30	3000	45	101	1100	292
3L40	3000	55	123	1100	355
3M40	3000	60	130	1100	376
4L30	3000	60	135	1100	390
4L40	3000	74	164	1100	474
4M40	3000	80	170	1100	491
E573	3000	3	14	1100	40
E673	3000	5	16	1100	46
E75	3000	7	18	1100	52
E780	3000	10	25	1100	72
E786	3000	14	30	1100	87
E79	3000	8	20	1100	58
E88	2600	10	28	1100	81
E89	2600	12	30	1100	87
E950	3000	17	36	1100	104
Z788	3000	23	55	1100	159

HINO					
Z790	3000	30	61	1100	176
DK10	2000	132	325	900	819
DK10T	1800	160	425	900	1070
DM100	2400	62	165	900	416
EB300	2000	132	315	900	793
EC100	2600	76	208	900	524
EF550	2200	230	572	900	1441
EF750	2200	245	589	900	1483
EF750T	2200	272	850	900	2141
EH100	2600	93	244	900	615
EH500	2800	114	277	900	698
EH700	2800	118	290	900	730
EK100	2200	196	467	900	1176
EL100	2600	132	327	900	824
EL100T	2400	145	440	900	1108
EM100	2400	148	362	900	912
ER100	2200	160	407	900	1025
EV700	2200	298	700	900	1763

ISUZU					
QD100	3200	87	185	900	466
QD130	2800	115	230	900	579
QD145	3200	129	280	900	705
QD145T	2500	139	305	900	768
QD200	2200	194	410	900	1033
QD200T	2000	218	515	900	1297
QD27	2800	26	50	900	126
QD40	2800	40	80	900	201
QD60	3800	55	140	900	353
QD85	3000	68	162	900	408
QD90	2800	75	150	900	378
QT15	3600	14	55	900	139
QT23	3600	22	75	900	189
QT35	3000	32	96	900	242

Engine Model	RPM	Intake HP	Intake CFM	-- Exhaust --	
				Temp. (°F)	Flow (CFM)
IVECO					
803 i 3L-NA	2500	51	120	1100	347
804 i 4L-NA	2500	68	155	1100	448
805 i 5L-NA	2500	84	174	1100	214
806 i 6L-NA	2500	102	235	1100	679
806 i tc 6L-TC	2500	131	340	900	856
8210 i 6L-NA	2000	205	440	1100	1271
8280 i V8-NA	2200	287	600	1100	1733
8281 SRi V8-TCA	2200	424	900	900	2267
8281 Si V8-TC	2000	331	790	900	1990
8361 Si 7L-TC	2400	157	450	900	1133
8361 i 6L-NA	2500	139	322	1100	930

JOHN DEERE					
3164D	2500	52	100	900	252
3179D	2500	58	100	900	252
3179T	2500	79	178	900	448
4219D	2500	70	135	900	340
4239A	2500	117	277	900	698
4239D	2500	80	148	900	373
4239T	2500	109	258	900	650
4276D	2500	82	160	900	403
4276T	2200	98	266	900	670
6076A	2200	240	568	900	1431
6076H	2200	250	647	900	1629
6076T	2200	190	505	900	1272
6329D	2500	104	200	900	504
6359A	2500	176	470	900	1184
6359D	2500	121	228	900	574
6359T	2500	163	370	900	932
6414D	2200	118	228	900	574
6414T	2200	146	360	900	907
6466A	2100	233	579	900	1458
6466D	2200	138	258	900	650
6466T	2200	185	484	900	1219
6619A	2100	301	680	900	1713
8955A	2100	456	1130	900	2846
8955T	2100	356	978	900	2463

KOHLER					
K161	3600	7	14	1150	42
K181	3600	8	16	1150	48
K241	3600	10	20	1150	60
K301	3600	12	24	1150	72
K321	3600	14	26	1150	78
K341	3600	16	30	1150	89
K582	3600	23	48	1150	143
K91	3600	4	7	1150	21
KT17	3600	17	35	1150	104
KT19	3600	19	39	1150	116

Engine Exhaust & Air Flow Guide

Engine Model	RPM	HP	-- Exhaust --	
			Intake Temp. (°F)	Flow (CFM)
KUBOTA				
D1402-B	2800	31	62	900
D3200-B	2400	66	123	900
D600-B	3600	16	35	900
DH850-BW	3000	20	41	900
DH850-B	3600	23	49	900
S2800-B	2600	58	116	900
V1100-B	3000	26	55	900
V1702-B	2800	40	77	900
V1902-B	2800	42	83	900
V4300-B	2400	88	164	900
VH1100-B	3600	31	66	900
Z400-B	3600	11	23	900
Z600-BW	3200	14	29	900
ZB400-B	3200	10	21	900
ZB600C-1-B	3200	14	29	900
ZH600-B	3600	16	33	900

LISTER				
HL3	2500	125	900	315
HL4	2500	167	900	421
HL6	2500	250	900	630
HLT6	2100	300	900	756
HR2	2200	73	900	184
HR3	2200	110	900	277
HRW2	2200	31	74	900
HRW3	2200	47	110	900
HRW4	2200	62	146	900
HRW6	2200	93	220	900
HRWS6	2000	102	200	900
LT1	3600	8	24	900
LV1	3600	9	28	900
LV2	3600	18	55	900
ST1	3000	10	31	900
TL2	3000	27	74	900
TL3	3000	40	111	900
TS2	3000	22	61	900
TS3	3000	33	91	900

LOMBARDINI				
10LD 400-2	3000	16	34	1000
10LD 400-2/B1				
	3600	18	41	1000
11LD 535-3	3000	33	74	1000
11LD 625-3	3000	38	84	1000
3LD 450	3000	10	20	1000
3LD 510	3000	11	22	1000
3LD 510/L	2200	8	17	1000
4LD 640	3000	14	28	1000
4LD 640/L	2200	10	22	1000
4LD 705	2600	15	27	1000
4LD 820	2600	18	32	1000
4LD 820/L	2200	14	27	1000
5LD 675-2	3000	29	58	1000
5LD 675-3	3000	44	87	1000
5LD 825-2	2600	34	63	1000
5LD 825-2/L	2200	27	53	1000
5LD 825-3	2600	52	94	1000
5LD 825-3/L	2200	40	80	1000
5LD 825-4	2600	67	125	1000
5LD 825-4/L	2200	54	106	1000
5LD 930-3	2600	54	105	1000
5LD 930-4	2600	72	140	1000
6LD 260	3600	5	15	1000
6LD 260/C	1800	5	14	1000

Engine Model	RPM	HP	-- Exhaust --	
			Intake Temp. (°F)	Flow (CFM)
6LD 325	3600	7	17	1000
6LD 325/C	1800	7	17	1000
6LD 360	3600	8	19	1000
6LD 360 V	3600	8	19	1000
6LD 400	3600	8	21	1000
7LD 665	3000	15	29	1000
7LD 665/F	3000	15	29	1000
7LD 740/L	3000	16	32	1000
8LD 600-2	3000	26	52	1000
8LD 665-2	3000	29	58	1000
8LD 665-2/L	2200	22	44	1000
8LD 740-2	2600	29	52	1000
9LD 561-2	3000	26	48	1000
9LD 561-2/L	2200	18	37	1000

MACK				
E6	NA	350	NA	750
E7	NA	300	NA	728
	NA	350	NA	742
	NA	400	NA	791
	NA	427	NA	795
	NA	460	NA	814
	NA	310/330	NA	728
	NA	330/355	NA	735
	NA	355/380	NA	736
E9	NA	500	NA	740
EN291	2800	178	900	448
EN331	2800	206	900	519
EN402	2800	246	900	620
EN438	2600	247	900	622
EN540	2400	280	900	705
EN707C	2100	306	900	771
END465	2600	325	900	819
END475	2400	280	900	705
END5673C	2100	250	600	900
END5864	2300	270	850	900
END673E	2100	180	400	900
END707	2100	200	410	900
END864BC	2450	540	900	1360
ENDT475	2400	460	900	1159
ENDT673	2100	225	600	900
ENDT675	2100	237	625	900
ENDT676		800	900	2015
ENDT864A	2300	860	900	2166
ENDT865	2600	325	960	900
ENDT866	2400	275	1050	900
ENDTF673	2300	665	900	1675
ENDTF673C	2200	625	900	1574

MERCEDES-BENZ				
OM314	2800	85	170	900
OM346	2800	427	900	1075
OM352	2800	130	260	900
OM352A	2800	168	336	900
OM355	2000	200	327	900
OM360	2500	190	308	900
OM401	2500	195	340	900
OM402	2500	260	340	900
OM403	2500	325	463	900
OM404	2500	430	738	900
OM407	2200	240	480	900
OM407A	2200	280	560	900
OM407h	2200	240	480	900
OM407hA	2200	280	560	900
OM421	2300	216	432	900

Engine Model	RPM	HP	-- Exhaust --	
			Intake Temp. (°F)	Flow (CFM)
OM422	2300	280	560	900
OM422A	2300	330	660	900
OM422LA	2300	375	750	900
OM423	2300	355	710	900
OM423LA	2100	470	940	900
OM424	2300	420	840	900
OM424A	2300	530	1060	900
OM424LA	2300	615	1230	900
OM616	3600	67	134	900
OM617	3600	82	164	900
OM636	3500	40	95	900

MITSUBISHI				
S12A-PT	1800	660	1620	900
S12A-PTA	1800	850	2080	900
S12A-PTK	1800	900	2190	900
S12N-PT	1800	1000	2440	900
S12N-PTA	1800	1130	2750	900
S12N-PTK	1800	1230	3000	900
S12U-PTA	1200	3100	7910	900
S12U-PTK	1200	3300	8400	900
S16N-PT	1800	1320	3210	900
S16N-PTA	1800	1500	3670	900
S16N-PTK	1800	1620	3960	900
S6A-PT	1800	330	810	900
S6A-PTA	1800	425	1020	900
S6A-PTK	1800	450	1100	900
S6B-PT	1800	260	640	900
S6B-PTA	1800	320	780	900
S6B-PTK	1800	360	880	900
S6N-PT	1800	500	1240	900
S6N-PTA	1800	565	1380	900
S6N-PTK	1800	615	1480	900
S6U-PTA	1200	1550	3960	900
S6U-PTK	1200	1650	4200	900
S8N-PT	1800	660	1620	900
S8N-PTA	1800	750	1840	900
S8N-PTK	1800	810	1980	900

MTU OF NORTH AMERICA				
12V-396-TB-83				
	1845	1560	3919	3338
12V-396-TB-93				
	1845	1200	4534	3862
12V-396-TC-82				
	1745	1300	2902	2472
8V-396-TB-83				
	1845	1050	2436	2075
8V-396-TB-93				
	1845	1800	2944	2508
8V-396-TC-82				
	1745	870	1864	1588

NAVISTAR				
4-196	3800	86	162	1150
6.9 L	3000	170	330	1000
7.3 LT (T444)	2600	190	605	753
7.3 L	3000	175	349	1000
9.0 L (DV550)	2800	185	410	1050
C-200	2500	74	109	1150
C-221	2600	90	124	1150
C-263	2800	109	160	1150
C-301	2800	118	183	1150
C-345	3000	160	224	1150

Engine Model	RPM	HP	Intake CFM	-- Exhaust --	
				Temp. (°F)	Flow (CFM)
NAVISTAR CONTINUED					
C-392	3000	180	255	1150	760
C-549	3200	232	381	1150	1136
C135B	2400	46	70	1150	209
C153	2400	53	80	1150	239
C175	2500	63	95	1150	283
D155	2500	48	95	900	239
D179	2400	59	99	900	249
D188	2400	62	104	900	262
D206	2500	56	119	900	300
D236	2400	65	131	900	330
D239	2500	80	138	900	348
D268	2500	85	165	900	416
D282	2400	95	156	900	393
D310	2300	101	165	900	416
D312	3000	117	216	900	544
D360	3000	136	250	900	630
D370	2200	105	188	900	473
D407	2600	127	245	900	617
D414	3000	157	287	900	723
D466	3000	165	323	900	813
D550B	3000	200	382	900	962
D554	2300	150	294	900	740
D691	1600	150	256	900	645
DT239	2500	110	225	900	567
DT358	2400	130	340	900	856
DT360	2700	190	588	850	1426
DT361	2600	146	341	900	859
DT402	2400	165	380	900	957
DT407	2500	160	368	900	927
DT414	3000	220	449	900	1131
DT420	2600	225	403	900	1015
DT466	2400	195	664	737	1520
DT466	2400	210	650	765	1530
DT466	2400	230	677	855	1710
DT466	2400	250	650	845	1640
DT466	2400	275	650	984	1820
DT573	2600	300	539	900	1357
DT573B	2600	260	525	900	1322
DT817	2100	385	975	900	2456
DT817B	2100	320	975	900	2456
DT817C	2200	420	975	900	2456
DVT800	2600	310	752	900	1894
MV-404	3600	188	315	1150	939
MV-446	3600	235	348	1150	1038
UC60	2500	17	33	1150	98
UR-450	2400	158	234	1150	698
UV-401	2800	165	243	1150	725
V-304	4400	180	298	1150	888
V-345	3800	172	284	1150	847
V-345	3800	168	284	1150	847
V-392	3600	236	306	1150	912
V-537	3200	208	372	1150	1109
VS-478	3400	224	352	1150	1049
VS-549	3200	243	381	1150	1136

NISSAN					
A-12	4800	58	74	900	186
A-15	4800	78	95	900	239
ED-33	3200	83	168	900	423
FD-33T	3200	105	235	900	592
FD-6	2700	131	243	900	612
FD-6T	2700	148	340	900	856
H-20	3100	55	82	900	207
H-30	2600	66	102	900	257

Engine Model	RPM	HP	Intake CFM	-- Exhaust --	
				Temp. (°F)	Flow (CFM)
J-15	2800	32	55	900	139
LD-20	2600	38	80	900	201
LD-28	2600	53	115	900	290
ND-6	2400	130	260	900	655
P-40	2300	80	120	900	302
PD-6	2200	173	360	900	907
PD-6T	2200	227	505	900	1272
PE-6	2200	200	408	900	1028
PE-6T	2200	250	570	900	1436
RD10	2400	330	682	900	1718
RD10T	2400	415	1000	900	2519
RD10TA	2300	485	1200	900	3022
RD8	2400	265	545	900	1373
RD8T	2400	320	763	900	1922
SD-16	3200	36	85	900	214
SD-22	3200	51	110	900	277
SD-25	3200	60	126	900	317
SD-33	3200	79	165	900	416
SD-33T	3200	92	230	900	579

PERKINS					
3.1522	2500	44	95	900	239
4-107	4000	57	99	900	249
4-108	4000	60	100	900	252
4-154	3600	80	128	900	322
4-203	2600	63	122	900	307
4-236	2800	80	153	900	385
4-248	2500	85	144	900	363
4-270	2000	62	125	900	315
4-300	2200	90	152	900	383
4-302	2300	76	161	900	405
4-318	2000	75	147	900	370
4-99	4000	55	92	900	232
4.108	4000	49	102	900	257
4.165	3600	70	135	900	340
4.2032	2250	58	117	900	295
4.236	2800	82	157	900	395
4.248	2500	84	152	900	383
4.318	2000	70	140	900	353
6-305	2600	89	184	900	463
6-354	2800	120	230	900	579
6-372	2500	121	215	900	541
6.247	3600	101	205	900	516
6.3544	2800	200	238	900	599
6.3724	2500	200	227	900	572
D3-152	2500	52	88	900	222
D3.152	2500	49	3	900	8
D4.203	2500	52	3	900	8
T6-354	2400	150	307	900	773
T6-354-3	2500	140	320	900	806
T6.3544	2600	150	370	900	932
TV8.640	2600	185	685	900	1725
V8-510	2800	185	331	900	834
V8-540	2500	166	312	900	786
V8-605	2500	200	350	900	881
V8.540	2600	150	370	900	932
V8.640	2600	150	411	900	1035

RENAULT					
18TS/GTS	5750	92	230	1150	686
20 TL/GTL	5500	98	200	1150	596
20 TX	5500	112	230	1150	686
20 TX	5000	112	230	1150	686
4 GTL	4000	33	70	1150	209
4L/TL	4250	20	40	1150	119

Engine Model	RPM	HP	Intake CFM	-- Exhaust --	
				Temp. (°F)	Flow (CFM)
9 TD/GTD	4800			900	
FUEGO TURBO D	4250	85	211	900	531
TRAFIC	4750	46	90	1150	268
TRAFIC	5000	46	90	1150	268
TRAFIC PROP	4000	56	140	900	353

SAME					
1052 LP	2500	39	83		71
1053 P	2500	64	124		106
1054 P	2500	85	165		141
1054 PT	2300	90	152		129
1055 P	2500	105	206		175
1056 P	2500	126	248		211
1056 PS	2300	148	228		194
1056 PT	2300	160	228		194
916.3A	3000	61	131		112
916.4A	3000	81	175		149

TELEDYNE					
ACN	3600	6	13		11
AENL	3600	9	20		17
AGND	3200	12	26		22
BKN	3600	7	16		14
EY18-3W	3600	5	10		9
EY21W	3800	17	33		28
EY25W	3600	6	15		13
EY27W	3600	8	16		14
EY44W	3600	10	22		19
NH4D	2800	30	75		64
R08	5000	27	60		51
R11	4200	34	73		62
R14	4200	48	105		89
R17	5000	83	180		153
R22	5500	101	220		187
RD16	4800	54	135		115
RD21	4200	62	155		132
S-12D	3600	12	31		26
S-14D	3600	14	30		26
S-8D	3600	8	18		15
TJD	3600	18	48		41
TM13	3000	33	70		60
TM13	3000	22	45		38
TM20	3000	52	100		85
TM20	3000	44	90		77
TM27	3000	69	125		106
TM27	3000	59	120		102
TMD13	3000	29	72		61
TMD20	3000	44	110		94
TMD27	3000	121	300		256
TRA-12D	3600	12	25		21
V-465D	3000	66	133		113
V460D	3000	65	133		113
VE4	2400	48	118		100
VF4	2400	56	138		118
VG4D	2400	37	75		64
VH4	2800	61	155		132
VH4D	2800	30	65		55
VR4D	2200	37	122		104
W2-1230	3600	25	55		47
W2-1235	3600	30	68		58
W2-880	3600	20	44		37
W4-1770	3000	35	72		61
WD1-340	3000	7	18		15

Engine Model	RPM	HP	Intake CFM	Temp. (°F)	Flow (CFM)
--------------	-----	----	------------	------------	------------

TELEDYNE CONTINUED

WD1-350.....	3000	8	20		17
WD1-430.....	3000	10	24		20
WD1-450.....	3400	10	26		22
WD1-660.....	3000	15	38		32
WD1-670.....	3000	16	40		34
WD1-750.....	3000	17	43		37
WD2-1000.....	3000	21	52		44
WD2-860.....	3000	19	48		41
WI-145.....	4000	4	8		7
WI-145V.....	3600	4	8		7
WI-185.....	3600	5	10		9
WI-185V.....	3600	5	10		9
WI-340.....	3600	9	20		17
WI-390.....	3600	11	22		19
WI-588.....	3600	16	34		29

VOLKSWAGON

026.2.....	2200	70	140	1150	417
068.5.....	4000	48	90	900	227
068.A.....	4000	60	120	900	302
075.1.....	4000	75	145	900	365
126A.....	2000	45	90	1150	268

VOLVO

D45BPP.....	2300	75	195	900	491
TD100G.....	2000	223	460	900	1159
TD100GPP.....	2000	223	460	900	1159
TD120HP.....	2000	286	575	900	1448
TD121G.....	2000	284	575	900	1448
TD45B.....	2200	90	235	900	592
TD61A.....	2500	154	330	900	831
TD61AP.....	2500	165	350	900	881
TD61AW.....	2500	162	350	900	881
TD71A.....	2200	189	360	900	907
TD71AP.....	2200	192	360	900	907
TD71AW.....	2400	190	360	900	907
TID100KPP.....	2000	249	515	900	1297
TID121KP.....	2000	343	695	900	1750
TID121LP.....	1800	401	800	900	2015
TID71A.....	2200	216	380	900	957
TID71AP.....	2200	209	400	900	1007

Engine Model	RPM	HP	Intake CFM	Temp. (°F)	Flow (CFM)
--------------	-----	----	------------	------------	------------

WAUKESHA

190DLC.....	2800	84	128		109
197DLC.....	2800	91	208		177
197DLCs.....	2800	131	320		273
D317D.....	2400	118	285		243
D317DS.....	2400	142	340		290
F1197D.....	1800	258	620		528
F1197DS.....	1800	400	960		818
F1197DSI.....	2400	462	1100		937
F1905DS.....	1200	397	860		733
F1905DSI.....	2200	514	1015		865
F2896D.....	1200	415	804		685
F2896DS.....	1200	695	1032		879
F2896DSI.....	1200	877	1305		1112
F475D.....	2400	182	440		375
F475DS.....	2400	216	520		443
F674D.....	2200	226	540		460
F674DS.....	2200	229	550		469
H1077D.....	2400	346	630		537
H1077DS.....	2400	522	1080		920
H1077DSI.....	2400	557	1190		1014
H866DS.....	2300	384	920		784
L1616D.....	2400	520	940		801
L1616DS.....	2400	785	1680		1431
L1616DSI.....	2400	836	1850		1576
L5100D.....	1200	830	1420		1210
L5100DS.....	1200	1232	2170		1849
L5100DSI.....	1200	1375	2560		2181
L5790D.....	1200	905	1710		1457
L5790DS.....	1200	1235	2600		2215
L5790DSI.....	1200	1754	3080		2624
LRDCS.....	1200	695	1032		879
NKDC.....	1200	297	566		482
NKDCS.....	1200	390	860		733
P2154D.....	2200	592	1420		1210
P2154DS.....	2200	1017	2450		2087
P2154DSI.....	2200	1077	2600		2215
VLRD.....	1200	905	1710		1457
VLRDS.....	1200	1235	2600		2215
VRD232.....	2200	68	160		136
VRD283.....	2200	76	180		153
VRD310.....	2400	106	255		217
WAKD.....	1800	258	530		451
WAKDS.....	1800	400	810		690

Engine Model	RPM	HP	Intake CFM	Temp. (°F)	Flow (CFM)
--------------	-----	----	------------	------------	------------

WHITE ENG

D-2000.....	2600	70	120		102
D-2300.....	2400		137		117
D-2300T.....	2400		211		180
D-3000.....	2800	110	193		164
D-3000T.....	2600	130	280		239
D-3300T.....	1800		175		149
D-3400.....	2400		210		179
D-3400T.....	2400		333		284
D-4800.....	2400		260		221
D-4800T.....	2400		400		341
D-4800TA.....	2400		400		341
D-4800TAH.....	1800		431		367
G-1600.....	2400		102		87
G-2000.....	2800	84	120		102
G-2300.....	2400		130		111
G-3000.....	2800	130	181		154
G-3400.....	2400		210		179

YANMAR

12LAAL-DT.....	1800	1060	2772	900	6981
3T95LE.....	2800	51	114	900	287
4HAL.....	1800	110	260	900	655
4T95LE.....	2800	68	150	900	378
4T95LTE.....	2800	85	208	900	524
6HAL.....	1800	165	390	900	982
6HAL-DT.....	1800	330	837	900	2108
6HAL-HT.....	1800	264	692	900	1743
6HAL-T.....	1800	209	512	900	1289
6LAAL-DT.....	1800	530	1370	900	3450
6T95LE.....	2800	102	233	900	587
6T95LTE.....	2800	128	314	900	791
8LAAL-DT.....	1800	705	1800	900	4533

When all you have is a Donaldson part number, this section will lead you to the proper page in the catalog where specific information on that part number can be found.

In some cases you will find multiple page numbers listed, for products such as: mufflers (with references to the specifications section and the muffler selection by engine performance section); and clamps (with references to both dimensional and application information).

Part No.	Page(s)	Part No.	Page(s)	Part No.	Page(s)	Part No.	Page(s)	Part No.	Page(s)
H000165	60	H002070	63	J000219	28	J009639	43	J190014	42
H000170	60	H002612	50	J000220	28	J009640	43	J190016	42
H000275	60	H002613	50	J000221	28	J009641	43	J190017	42
H000276	60	H002614	50	J000222	28	J009644	43	J190019	42
H000339	60	H002615	50	J000224	28	J009645	43	J190020	42
H000349	62	H002616	50	J000227	28	J009648	35	J190023	43
H000350	62	H002617	50	J000228	28	J009649	35	J190025	43
H000351	62	H002618	50	J000230	28	J009650	35	J190027	43
H000466	60	H002619	50	J000231	28	J014621	47	J190041	34
H000467	60	H002762	50	J000232	28	J014622	47	J190042	35
H000468	60	H002763	50	J000233	28	J014623	47	J190044	35
H000469	60	H002764	50	J008167	36	J018110	43	J190045	35
H000470	60	H002765	50	J008671	41	J024735	46	J190046	34
H000471	60	H002766	50	J008681	41	J024737	46	J190054	28
H000472	60	H002767	50	J008942	34	J024739	46	J190055	28
H000473	60	H002768	50	J009391	33	J024746	47	J190056	28
H000483	61	H002769	50	J009393	33	J024747	47	J190057	28
H000484	61	H008441	63	J009429	37	J024748	47	J190058	28
H000604	60	H008442	63	J009479	33	J024749	47	J190059	28
H000605	60	H008443	63	J009486	28	J024750	47	J190060	28
H000606	60	H008444	63	J009487	28	J024751	47	J190061	28
H000607	60	H770037	62	J009514	40	J024754	31	J190062	28
H000722	50	H770068	62	J009516	40	J024755	31	J190063	28
H001023	50			J009518	40	J024757	47	J240003	31
H001053	60	J000127	45	J009547	41	J024758	47	J240004	31
H001063	60	J000200	28	J009560	42	J024835	31	J240005	31
H001200	58	J000201	28	J009604	28	J024836	31	J240006	31
H001278	49	J000202	28	J009605	28	J024837	31	J240007	31
H001279	49	J000203	28	J009606	28	J024838	31	J240012	46
H001284	49	J000204	28	J009607	28	J024850	31	J240016	47
H001377	59	J000205	28	J009611	32,33	J028528	43	J240024	46
H001378	59	J000206	28	J009612	32	J034673	31	J340023	46
H001379	59	J000207	28	J009613	32	J034674	31	J540008	46
H001654	58	J000208	28	J009614	32	J034743	31	J640001	46
H001660	58	J000209	28	J009618	32	J034744	31	J640005	47
H001661	58	J000210	28	J009623	28	J034746	47		
H001742	60	J000211	28	J009624	28	J038611	43	M001327	45
H001756	60	J000212	28	J009629	33	J038612	43	M001432	26
H001773	60	J000213	28	J009631	44	J092679	35	M001502	26
H001946	60	J000214	28	J009632	44	J092689	35	M001503	26
H001947	60	J000215	28	J009633	44	J190002	41	M001504	26
H001948	60	J000216	28	J009635	44	J190003	41	M001505	26
H002023	63	J000217	28	J009636	44	J190004	41	M001506	26
H002068	59	J000218	28	J009637	44	J190013	42	M001566	26

Part No.	Page(s)	Part No.	Page(s)	Part No.	Page(s)	Part No.	Page(s)
M001593.....	26	M070050.....	67,74,79	M100016.....	48	M120450.....	70,78,85
M001668.....	26	M070068.....	48	M100043.....	68,76,83	M120566.....	69,78,81
M001702.....	26	M070069.....	48	M100048.....	68,76,83	M120598.....	69,78,81
M001703.....	26	M080018.....	67,74,79	M100049.....	70,76,85	M120713.....	70,78,85
M001756.....	26	M080024.....	48	M100052.....	70,76,84	M120747.....	67,78,80
M001799.....	26	M085008.....	68,74,82	M100146.....	69,76,81	M120748.....	68,78,83
M001865.....	26	M085023.....	68,74,82	M100213.....	69,76,81	M120749... 69,70,78,81,84	
M001866.....	26	M085056.....	68,74,82	M100463.....	67,76,80	M120750.....	70,78,85
M001867.....	26	M085078.....	68,74,82	M100464.....	67,76,79	M120751.....	71,78,86
M002117.....	29	M085080.....	68,74,82	M100465.....	67,76,80	M122300.....	68,78,83
M002118.....	29	M085084.....	69,74,81	M100466.....	67,76,79	M140048.....	68,78,83
M002119.....	29	M085090.....	69,74,81	M100572.....	71,76,86	M170101.....	68,78,83
M002120.....	29	M085171.....	67,74,79	M100580.....	67,76,80	M190002.....	68,78,83
M002121.....	29	M085172.....	69,74,82	M100582.....	67,76,80		
M002122.....	29	M085189.....	69,74,82	M100695.....	67,76,79	P002348.....	62
M002123.....	29	M085206.....	70,74,84	M100807.....	67,76,80	P002351.....	62
M002134.....	26	M085207.....	70,74,85	M100944.....	67,76,80	P003245.....	62
M002135.....	26	M085208.....	71,74,86	M101158.....	67,76,80	P004073.....	62
M002164.....	26	M085226.....	69,74,81	M101159.....	67,76,80	P004076.....	62
M002480.....	36	M085267.....	69,74,82	M101167.....	67,76,79	P004079.....	62
M002482.....	36	M085293.....	67,74,79	M101168.....	68,76,83	P004307.....	62
M002484.....	36	M085407.....	67,74,79	M101169... 69,70,76,81,84		P004906.....	62
M002485.....	36	M085408.....	68,74,82	M101170.....	70,76,85	P007189.....	62
M002486.....	36	M085409... 69,70,74,81,84		M101171.....	71,76,86	P007191.....	62
M002487.....	36	M085410.....	70,74,85	M101181.....	67,76,80	P013722.....	62
M002488.....	36	M085411.....	71,74,86	M101182.....	67,76,80	P016845.....	62
M002490.....	36	M085421.....	67,74,79	M101263.....	67,77,80	P100089.....	57
M002491.....	36	M090009.....	67,74,79	M110012.....	68,77,83	P101290.....	52
M045123.....	48	M090072.....	48,74,80	M110014.....	70,77,84	P101291.....	52
M045193.....	69,73,81	M090074.....	67,75,80	M110077.....	68,77,83	P101292.....	52
M045237.....	67,73,79	M090091.....	48	M110112.....	70,77,84	P101293.....	52
M060005.....	67,73,79	M090095.....	67,75,79	M110148.....	70,77,84	P101294.....	52
M060037.....	48	M090146.....	67,75,79	M110189.....	68,77,83	P101891.....	52
M060038.....	48	M090158.....	68,75,82	M110311.....	70,77,84	P102820.....	52
M060055.....	68,73,82	M090159.....	68,75,82	M110479.....	69,77,81	P102948.....	53
M060158.....	69,73,81	M090170.....	68,75,82	M110674.....	69,77,81	P103198.....	56
M060232.....	68,73,82	M090210.....	68,75,82	M110849.....	67,77,80	P103516.....	52
M060247.....	67,73,79	M090280.....	68,75,83	M111024.....	69,77,81	P104087.....	53
M060250.....	70,73	M090301.....	69,75,81	M111025.....	70,77,84	P104088.....	53
M060251.....	71,73,86	M090362.....	48,75,79	M111026.....	71,77,86	P104089.....	53
M060479.....	67,73,79	M090520.....	68,75,83	M111028.....	68,77,83	P104090.....	53
M060480.....	68,73,82	M090534.....	68,75,83	M111029.....	67,77,79	P105220.....	56
M060481... 69,70,73,81,84		M090535.....	67,75,80	M120100.....	68,77,83	P105529.....	51
M060482.....	70,73,85	M090538.....	68,75,83	M120108.....	68,77,83	P105530.....	51
M060483.....	71,73,86	M090544.....	67,75,79	M120131.....	70,77,85	P105531.....	51
M065030.....	48	M090547.....	70,75,84	M120135.....	70,77	P105532.....	51
M065034.....	68,73,82	M090548.....	70,75,84	M120154.....	70,77,85	P105533.....	51
M065044.....	69,73,81	M090563.....	69,75,82	M120176.....	70,77,85	P105534.....	51
M065065.....	68,73	M090594.....	67,75,79	M120189.....	70,77,85	P105535.....	51
M065071.....	67,73,79	M090595.....	67,75,80	M120197.....	68,77,83	P105536.....	51
M065073.....	70,73,85	M090598.....	71,75,86	M120225.....	68,77,83	P105541.....	52
M065074.....	71,73,86	M090680.....	68,75,83	M120235.....	69,78,81	P105542.....	52
M065138.....	67,73,79	M090781.....	67,75,79	M120365.....	68,78,83	P105543.....	52
M065139.....	68,73,82	M090823.....	69,75,81	M120366.....	70,78,84	P105544.....	52
M065140... 69,70,73,81,84		M091046.....	67,75,79	M120367.....	70,78,84	P105545.....	52
M065141.....	70,73,85	M091047.....	68,76,83	M120382.....	69,78,81	P105546.....	52
M065142.....	71,73,86	M091048... 69,70,76,81,84		M120417.....	70,78	P105547.....	52
M070008.....	67,74,79	M091049.....	70,76,85	M120418.....	71,78,86	P105548.....	52
M070028.....	67,74,79	M091050.....	71,76,86	M120448.....	68,78,83	P105608.....	53

Part No.	Page(s)	Part No.	Page(s)	Part No.	Page(s)	Part No.	Page(s)	Part No.	Page(s)
P148347	55	P206341	41	P206411	28	P207288	46	P207386	34
P148348	55	P206342	41	P206507	36	P207289	46	P207389	34
P148349	55	P206343	41	P206508	41	P207290	47	P207394	34
P148350	55	P206344	41	P206509	41	P207292	46	P207397	34
P149099	56	P206345	41	P206510	37	P207293	47	P207401	34
P158914	56	P206346	42	P206511	37	P207295	47	P207402	34
P159820	51	P206347	41	P206512	37	P207296	47	P207405	34
P171376	50	P206348	41	P206515	37	P207297	47	P207408	34
P171378	50	P206349	42	P206516	37	P207298	47	P207411	34
P171381	50	P206350	41	P206517	37	P207299	46	P207413	34
P205976	35	P206353	41	P206518	37	P207300	46	P207414	34
P205979	35	P206354	41	P206519	37	P207301	47	P207415	47
P206279	43	P206361	34	P206520	37	P207302	47	P207419	47
P206280	43	P206362	34	P206521	37	P207308	47	P207559	47
P206281	43	P206363	34	P206523	36	P207309	47	P207566	33
P206282	43	P206364	34	P206524	36	P207312	47	P207567	33
P206283	43	P206365	34	P206525	36	P207314	46	P207568	33
P206285	43	P206366	34	P206526	36	P207318	47	P207581	33
P206286	43	P206367	34	P206540	37	P207319	47	P207582	33
P206297	35	P206368	34	P206542	37	P207320	47	P207584	33
P206298	35	P206369	34	P206543	41	P207321	47	P207596	28
P206299	35	P206370	34	P206544	31	P207322	42	P207598	28
P206300	35	P206371	34	P206546	31	P207324	42	P207619	33
P206301	47	P206372	34	P206547	31	P207325	42	P207620	33
P206302	47	P206373	34	P206552	31	P207326	42	P207667	28
P206303	47	P206374	34	P206553	31	P207327	42	P207784	36
P206304	47	P206375	34	P206554	31	P207328	42	P208324	46
P206305	47	P206376	46	P206555	31	P207329	42	P208326	47
P206306	47	P206377	46	P206556	31	P207330	42	P208328	46
P206308	47	P206378	46	P206559	31	P207331	42	P208328	46
P206309	47	P206379	46	P206600	28	P207332	42	P208330	47
P206310	47	P206380	47	P206601	28	P207333	42	P208336	46
P206311	47	P206381	47	P206602	28	P207335	41	P208338	47
P206312	47	P206382	47	P206603	28	P207338	41	P208348	46
P206313	34	P206383	47	P206604	32,33	P207339	41	P208350	47
P206314	34	P206384	47	P206605	32,33	P207340	41	P208358	47
P206315	34	P206385	47	P206606	32,33	P207341	41	P208359	47
P206316	34	P206386	47	P206607	32,33	P207345	41	P208364	46
P206317	34	P206387	47	P206608	28	P207346	41	P208366	47
P206318	34	P206388	46	P206609	28	P207347	44	P208374	47
P206319	34	P206389	46	P206610	28	P207349	44	P208375	47
P206320	34	P206390	46	P206611	28	P207349	44	P208380	46
P206321	34	P206391	46	P206612	33	P207350	44	P208382	47
P206322	34	P206393	44	P206613	33	P207351	44	P208385	46
P206323	34	P206394	44	P206614	33	P207352	44	P208386	47
P206324	34	P206395	44	P206615	33	P207353	44	P208388	47
P206325	34	P206396	44	P206616	40	P207354	44	P208389	47
P206326	34	P206397	42	P206617	40	P207355	44	P208392	47
P206327	34	P206398	42	P206641	40	P207359	43	P208393	46
P206328	34	P206399	42	P206849	45	P207361	42	P208394	47
P206331	45	P206400	42	P206850	45	P207362	42	P208395	47
P206333	45	P206403	28	P206851	45	P207363	42	P209910	47
P206334	45	P206404	28	P206927	47	P207364	42	P209912	47
P206335	45	P206405	28	P207281	46	P207365	42	P209913	47
P206336	45	P206406	28	P207282	46	P207366	42	P210110	32,33
P206337	45	P206407	28	P207283	46	P207367	45	P212925	32
P206338	45	P206408	28	P207285	46	P207368	45	P213191	32
P206339	41	P206409	28	P207286	46	P207369	45	P216169	44
P206340	41	P206410	28	P207287	46	P207382	34	P216172	41
						P207385	34	P216174	42

Part No.	Page(s)	Part No.	Page(s)	Part No.	Page(s)	Part No.	Page(s)	Part No.	Page(s)
P216175	42	P224703	46	P233421	37	P532943	54	X004482	27,28
P216191	46	P224706	46	P233422	37	P532944	54	X004484	27,28
P216197	46	P224707	46	P235305	32	P532945	54	X004536	27,28
P216200	47	P224709	47	P235764	30	P532948	54	X004537	27,28
P216202	47	P224710	47	P235765	30	P532949	54	X004538	27,28
P216204	47	P224711	47	P235766	30	P532950	54	X004539	27,28
P216205	47	P224841	37	P235767	30	P532951	54	X004962	27,28
P216206	47	P226129	30	P235768	30	P532952	54	X005207	37
P216227	46	P226132	30	P235769	30	P532953	54	X006202	27
P216228	46	P226133	30	P235770	42	P532954	54	X006203	27
P222017	32	P226140	30	P235771	42	P532956	54	X006204	27
P222018	32	P226141	30	P235772	42	P532957	54	X007276	57
P222740	28	P226142	30	P235787	44	P532958	54	X007335	57
P222741	28	P226143	30	P235788	44	P532959	54	X007784	27,28
P222742	28	P226144	30	P235789	44	P532960	54	X007785	27,28
P224412	31	P226145	30	P235790	45	P532961	54	X007805	27,28
P224415	31	P226146	30	P235792	33	P532962	54	X007824	27,28
P224418	31	P226147	30	P235793	33	P535571	54	X007829	27,28
P224421	31	P226148	30	P235796	33	P535572	54	X007830	27,28
P224479	31	P226149	30	P235797	33	P535573	54	X007831	27,28
P224481	31	P226150	30	P238111	28	P536163	51	X007833	27,28
P224492	41	P226151	30	P238112	28	P537468	51	X007834	27,28
P224515	31	P226152	30	P238113	28	P540256	52	X009076	27,28
P224518	31	P226153	30	P270530	36	P547694	53		
P224521	31	P226154	30	P270531	36	P600325	53		
P224581	45	P226155	30	P270532	36	P600326	53		
P224582	45	P226156	30	P270533	36	P600327	53		
P224589	46	P226157	30	P270534	36	P600328	53		
P224590	46	P226158	30	P270535	36	P604045	52		
P224600	47	P226914	38	P270536	36	P617632	56		
P224604	46	P227167	38	P270538	36	P776008	56		
P224605	46	P227170	38	P270539	36	P777151	63		
P224607	46	P227175	38	P270540	36	P777730	63		
P224608	46	P227178	38	P270541	36	P777731	63		
P224609	46	P227179	37	P270542	36	P777732	63		
P224611	46	P227182	39	P270543	36	P778810	63		
P224614	46	P227215	38	P270837	36	P780532	63		
P224616	46	P227728	38	P270838	36	P780594	63		
P224617	47	P227750	32	P271507	36				
P224618	47	P227803	29	P271508	36	X001744	61		
P224627	46	P227804	29	P271511	36	X001746	61		
P224628	46	P227805	38	P520882	52	X001747	61		
P224633	47	P227839	39	P520883	52	X001966	59		
P224635	47	P228241	29	P520884	52	X001988	59		
P224636	47	P228258	38	P522439	62	X002014	59		
P224638	47	P228260	39	P522958	56	X002015	59		
P224641	47	P229114	39	P524552	62	X002017	59		
P224669	41	P229513	29	P525956	56	X002018	59		
P224671	41	P229851	32	P532919	55	X002019	59		
P224684	45	P230045	29	P532920	55	X002101	57		
P224685	45	P230046	38	P532921	55	X002102	57		
P224686	45	P230047	38	P532922	55	X002103	57		
P224687	45	P230241	37	P532923	55	X002275	57		
P224692	45	P230281	29	P532924	50,55	X002277	57		
P224693	45	P230282	29	P532925	55	X002278	57		
P224696	46	P230283	29	P532926	55	X003691	61		
P224698	46	P230284	38	P532927	55	X004476	27,28		
P224699	46	P230761	37	P532928	55	X004478	27,28		
P224701	46	P230762	37	P532929	55	X004480	27,28		

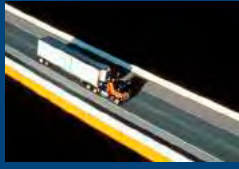

Global Presence with a Local Touch

At Donaldson, we've built a strong, flexible and responsive distribution network to serve our customers around the world.

Localized Manufacturing – It starts with 30+ manufacturing locations around the world – producing most filters in the regions where they're used.

Primary Distribution Centers – Filters then move to our regional warehouses and distribution center hubs – meaning the filters you need are never far away.

Logistics – We work with a network of transportation and logistics companies, consolidators and cross-docking facilities to deliver products to distribution partners quickly and efficiently.

Distribution Partners – We've built one of the largest, strongest and most responsive distributor networks in the filter industry – meaning you can find the filters and support you need, nearly anywhere in the world.



Donaldson Company, Inc.
Minneapolis, MN USA

donaldson.com
shop.donaldson.com

North America 800-374-1374 **Mexico**, **South East Asia** 65-6311-7373
Latin America & Greater China 86-400-650-0610
Caribbean 52-449-300-2400 **Brazil** **Japan** 81-42-540-4112
55-11-4894-6339 **Korea** 82-2-517-3333
Europe 32-16-38-3811 **Australia** 61-02-4350-2033
South Africa 27-11-997-6000 **India** 91-124-4807-400

Catalog No. F110028 ENG (09/2021)

© 2021 Donaldson Company, Inc. All rights reserved. Donaldson Company, Inc. reserves the right to change or discontinue any model or specification at any time and without notice. Printed in the U.S.A.