



aerospace  
 climate control  
 electromechanical  
**filtration**  
 fluid & gas handling  
 hydraulics  
 pneumatics  
 process control  
 sealing & shielding



# SNAPP™

The One-Piece, High-Performance  
Snap-In Fuel Filter Water Separator



ENGINEERING YOUR SUCCESS.

Now, getting the fuel filtration you need ...  
**is a SNAPP.**



## **SNAPP.** The fuel filter change that changes everything.

The world turns to Racor for filtration solutions that provide ultimate protection from water and solid contamination. This is filtration that includes two innovations often copied but never quite duplicated – the powerful protection of patented, world-class Aquabloc® filter media and, the Racor trademark, a clear bowl that allows for at-a-glance inspection of fuel system integrity.

————— **Fast, easy, clean, SNAPP is a fuel filter change for the better** —————

SNAPP is big protection for small engines up to 26 gph and makes every filter change literally a snap. Fast, easy, clean. No tools are needed – when it's time for service, simply snap in a new filter. Simple installation and a patented priming system mean that protecting your engine investment is now ... a SNAPP.

# Mighty small. Small but mighty.

For E10 gasoline, diesel & bio-diesel at just 4" x 8", SNAPP fits anywhere, protects everywhere.

*Forget multi-piece filters with glass bowls. Forget messy change-outs. SNAPP is a one-piece fuel filter separator that is fast and effortless to service.*

*Quick-connect fittings for fast, confident connections.*

*Quick-release squeeze tabs make filter changes a snap.*

*Permanent mounting bracket is stainless steel for withstanding corrosive environments.*

*SNAPP is a one-piece fuel filter water separator for 24/7 protection, even with E10 gasoline and bio-diesel.*

*Heavy-duty high-impact nylon construction won't ever rust or corrode, even in humid conditions.*

**Clear bowl for at-a-glance inspection.**

*The rugged clear bowl allows on-the-spot inspection for water in fuel - a significant advantage when troubleshooting fuel quality.*

**Legendary Aquabloc® filter media in 2, 10 or 30 micron rating.**

*The Aquabloc® media is the world's definitive filtration protection - it's 99% effective in separating water and solid contamination from diesel and bio-diesel.*

*The Racor self-venting drain means easy service with no mess - twist, drain, done.*

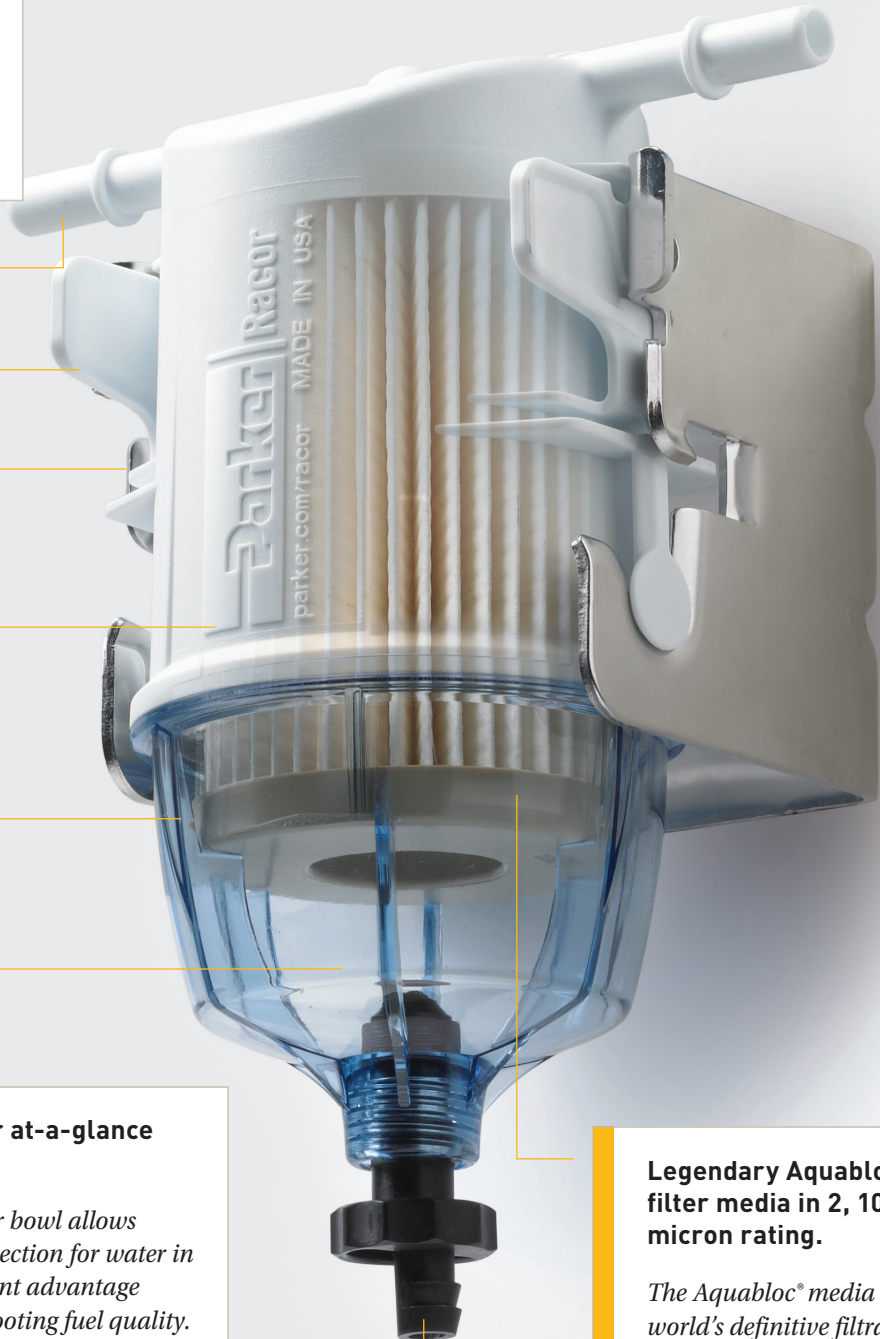

# AQUABLOC ENGINEERED MEDIA

## The Heart & Soul of Ultimate Engine Protection

Sensitive diesel fuel injection systems demand precise removal of damaging water and solid contamination. Yet, fuel additives to diesel and bio-diesel have made separation of harmful liquid and solid particulates more challenging than ever. The SNAPP integrated fuel filter water separator is a filtration system that is 99% efficient – for complete injector protection.

### **Stage One: Coalescing**

Water droplets coalesce on the outside of a chemically-treated composite media. As the droplets grow in size, being heavier than fuel, they fall into the collection bowl to be drained away.

Importantly, the massive surface area of the pleated media helps to slow fuel velocity, enabling extraordinary water removal minimum efficiency of +99% (SAE J1839). Especially with biofuels, this level of water removal is critical to engine protection.

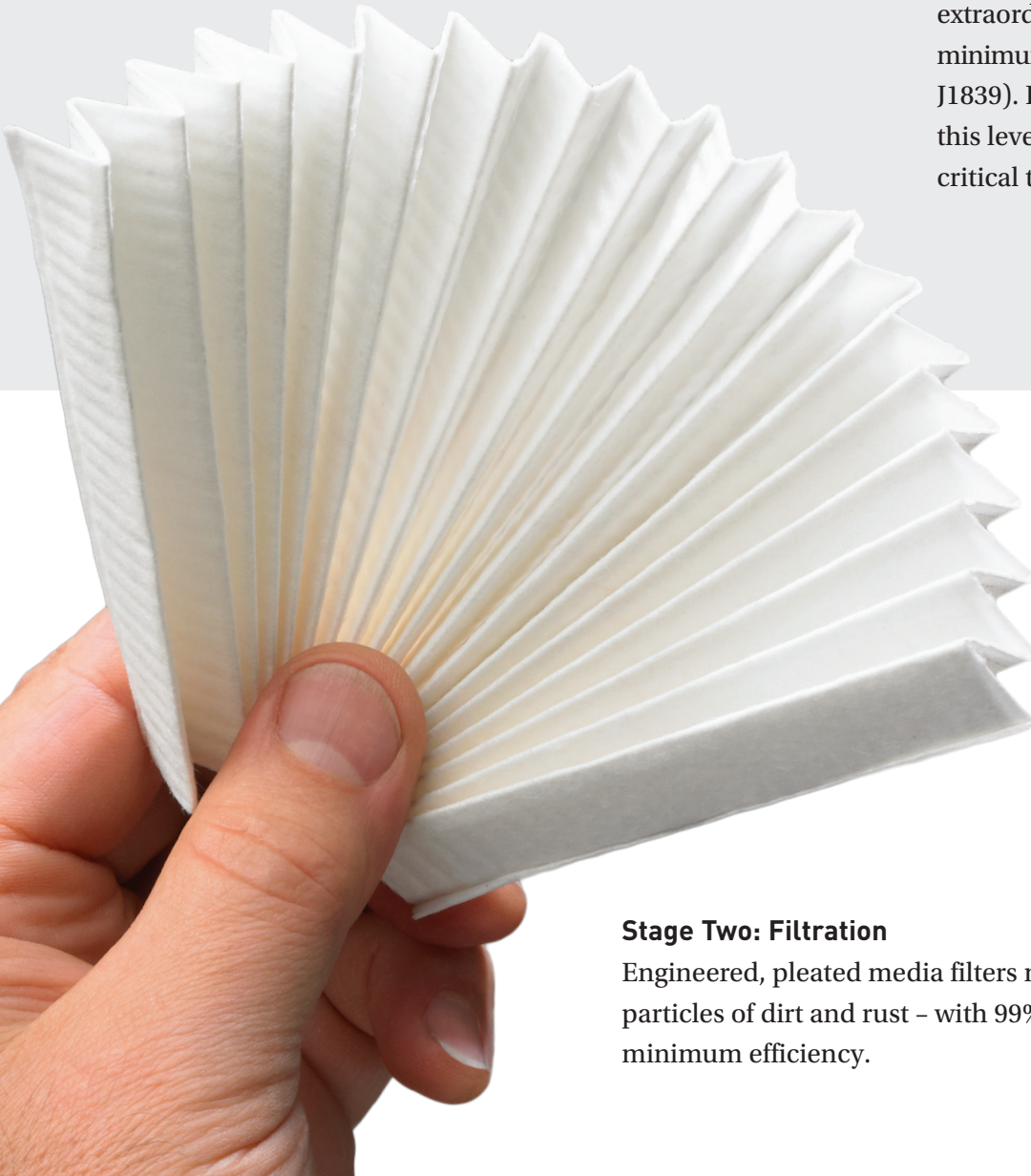

### **Stage Two: Filtration**

Engineered, pleated media filters microscopic particles of dirt and rust – with 99% (SAE J1985) minimum efficiency.

The ultra-high-efficiency Aquabloc media is an engineered blend of distinct media formulations – high-grade cellulose compounded with engineered fibers and chemical treatments proven to repel water.

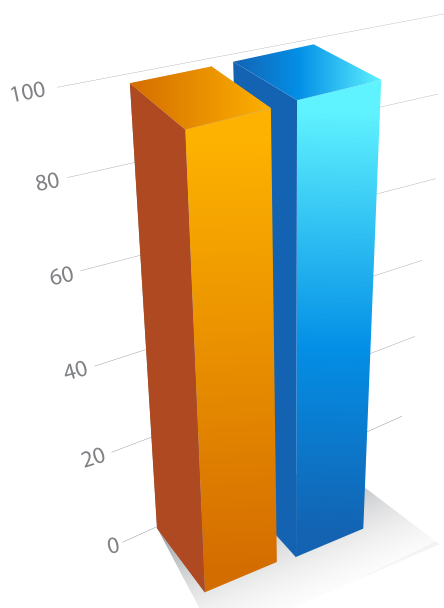

**+99%** water removal efficiency, tested with ULSD (SAE J1839)

**+99%** particle efficiency (SAE J1985)

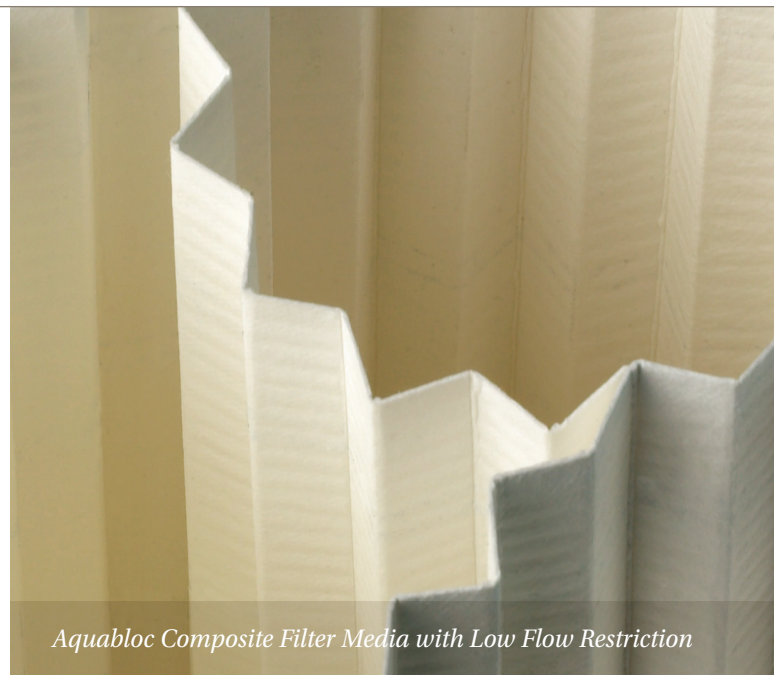

*Aquabloc Composite Filter Media with Low Flow Restriction*

- Ultra-high capacity means less frequent filter changes, boosting operating economy.
- The Aquabloc media is both corrugated and pleated to present a high capacity effective filtration surface area. This design innovation slows fuel velocity to improve coalescing and filtration efficiency.
- The high-dirt-holding-capacity Aquabloc media helps to dramatically extend the life of final-stage on-engine filters, and reduce the overall cost of the filtration program.
- Aquabloc cartridge filter elements are available in 2, 10, 30 micron ratings for diesel, B-20 bio-blends, gasoline and E10, so that protection can be tailored to fuel quality, operating environments and service schedules.

# SNAPP

The Fastest, Cleanest Fuel Filter Change  
On Earth. No Tools, No Mess, No Fuss.

## EASY TO INSTALL AND SERVICE



SNAPP can be installed anywhere in the fuel line between tank and engine, in the engine compartment or on a frame rail.

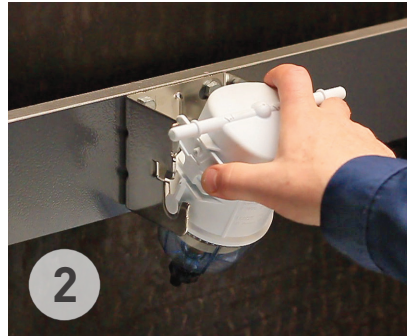

Snap in a new filter; just squeeze tabs to remove.

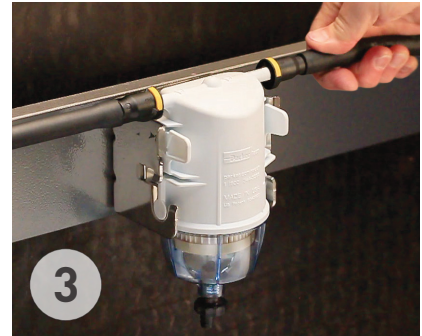

Quick-connect couplings speed installation and service.

## EASY TO PRIME

Disconnect fuel lines; snap out the old and snap in the new filter

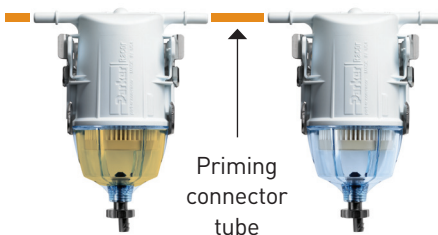

**With Drain**

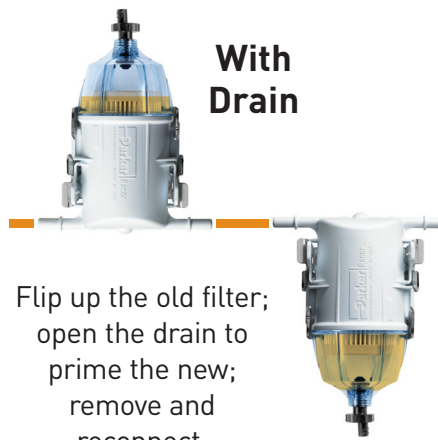

**Without Drain**

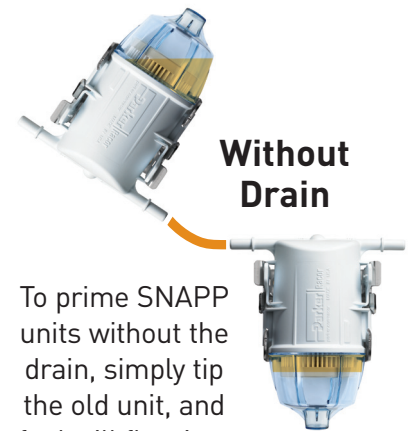

Wherever small gasoline, diesel and bio-diesel engines need big protection. Wherever time is money.

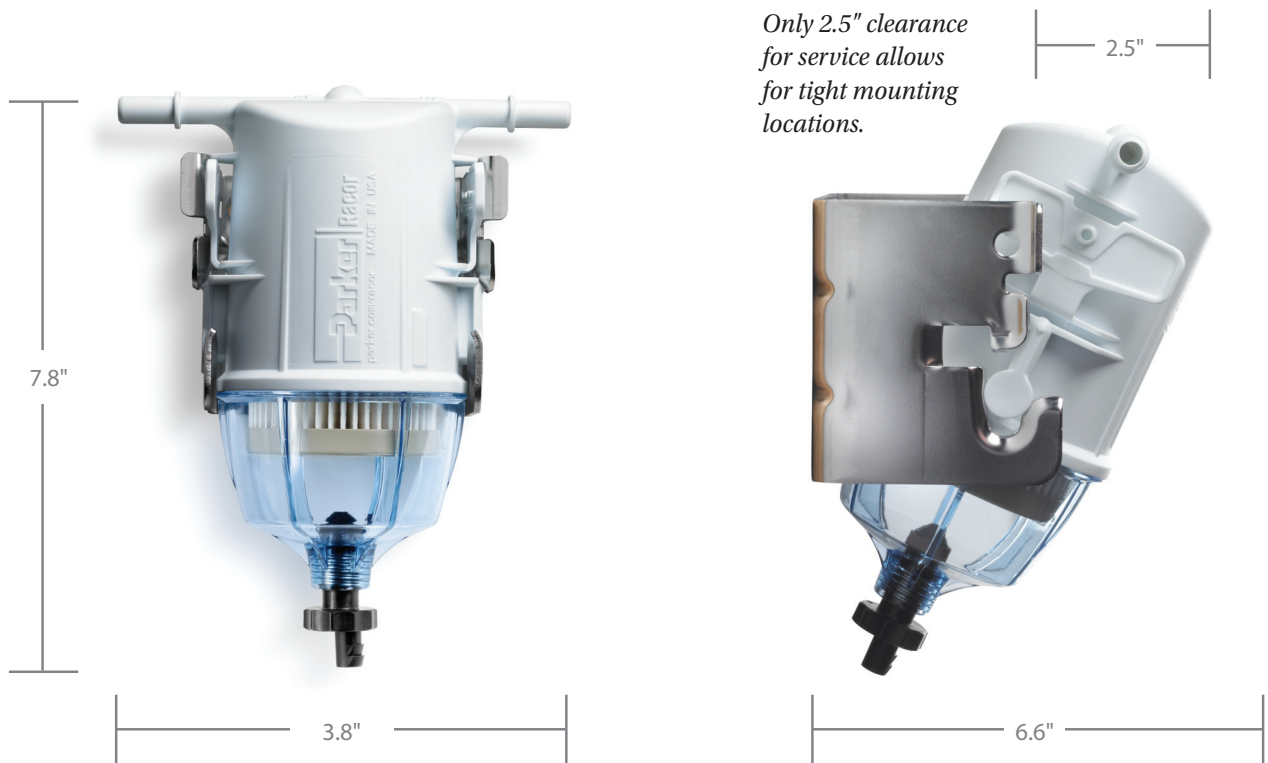

SNAPP fuel filter water separators are packaged for a first installation with mounting bracket and quick connect fittings. The replacement kit includes a new SNAPP filter and priming accessory.

*NOTE: Kits include Aquabloc media in 2, 10 or 30 micron ratings. Two micron is recommended for ultra-fine filtration of solid contaminants.*

Specifications	
Maximum Flow Rate	26 gph (100 lph)
Aquabloc Micron Rating	2, 10, or 30 micron
Height	7.8" (198 mm)
Width	3.8" (97 mm) at bracket
Depth	4.1" (104 mm)
Water Sump Capacity	3.4 oz. (100 ml)
Body Material	Nylon 6 plastic
Bracket Material	Stainless Steel
Port Size	3/8" (9.5 mm)
Quick-Connect Fittings	3/8" (9.5 mm) (per SAE J2044)
Rated Pressure	50 PSI (3.5 bar)
Water Removal Efficiency	99%
Rated Temperature Range	-20° to 150°F (-29° to 66°C)

Part #	Description
23281-02	Fuel Filter Assy with Bracket – Marine -02
23281-10	Fuel Filter Assy with Bracket – Marine -10
23281-30	Fuel Filter Assy with Bracket – Marine -30
R23280-02	Fuel Filter Assy – Marine Service -02
R23280-10	Fuel Filter Assy – Marine Service -10
R23280-30	Fuel Filter Assy – Marine Service -30
23299-02	Fuel Filter Assy with Bracket – Marine with Drain -02
23299-10	Fuel Filter Assy with Bracket – Marine with Drain -10
23299-30	Fuel Filter Assy with Bracket – Marine with Drain -30
R23298-02	Fuel Filter Assy – Marine Service with Drain -02
R23298-10	Fuel Filter Assy – Marine Service with Drain -10
R23298-30	Fuel Filter Assy – Marine Service with Drain -30

# Worldwide Filtration Manufacturing Locations

## North America

### Compressed Air Treatment

Filtration & Separation/Balston  
Haverhill, MA  
978 858 0505  
[www.parker.com/balston](http://www.parker.com/balston)

Filtration & Separation/Finite  
Oxford, MI  
248 628 6400  
[www.parker.com/finitefilter](http://www.parker.com/finitefilter)

Purification, Dehydration &  
Filtration Division  
Lancaster, NY  
716 685 4040  
[www.parker.com/pdf](http://www.parker.com/pdf)

Sales Office  
Charlotte, NC  
704 921 9303  
[www.parker.com/pdf](http://www.parker.com/pdf)

### Engine Filtration & Water Purification

Racor  
Modesto, CA  
209 521 7860  
[www.parker.com/racor](http://www.parker.com/racor)

Racor  
Holly Springs, MS  
662 252 2656  
[www.parker.com/racor](http://www.parker.com/racor)

Racor  
Beaufort, SC  
843 846 3200  
[www.parker.com/racor](http://www.parker.com/racor)

Racor – Village Marine Tec.  
Gardena, CA  
310 516 9911  
[www.desalination.parker.com](http://www.desalination.parker.com)

### Hydraulic Filtration

Hydraulic Filter  
Metamora, OH  
419 644 4311  
[www.parker.com/hydraulicfilter](http://www.parker.com/hydraulicfilter)

### Process Filtration

Process Advanced Filtration  
Oxnard, CA  
805 604 3400  
[www.parker.com/processfiltration](http://www.parker.com/processfiltration)

## Europe

### Compressed Air Treatment

domnick hunter Industrial  
England NE  
+44 (0) 191 402 9000  
[www.domnickhunter.com](http://www.domnickhunter.com)

Hiross Zander  
Padova Business Unit  
Angelo di Piove Padova, Italy  
+39 049 9712 111  
[www.parker.com/hzdz](http://www.parker.com/hzdz)

Hiross Zander  
Essen Business Unit  
Essen, Germany  
T +49 2054 9340, F +49 2054 934164  
[www.parker.com/hzdz](http://www.parker.com/hzdz)

Parker Gas Separations  
Etten-Leur, Netherlands  
+31 76 508 5300

### Engine Filtration & Water Purification

Racor  
England  
+44 (0) 1924 487000  
[www.parker.com/ffde](http://www.parker.com/ffde)

Racor Research & Development  
Stuttgart, Germany  
+49 (0)711 7071 290-0  
[www.parker.com/racor](http://www.parker.com/racor)

### Hydraulic Filtration

Hydraulic Filter  
Arnhem, Holland  
+31 26 3760376  
[www.parker.com/eurofilt](http://www.parker.com/eurofilt)

Urjala Operation  
Urjala as Finland  
+358 20 753 2500  
[www.parker.com/fi](http://www.parker.com/fi)

Condition Monitoring Center  
Norfolk IP 24 1HP England  
+44 1842 763299  
[www.parker.com/cmc](http://www.parker.com/cmc)

### Process Filtration

domnick hunter Process  
DH3 2SF England  
T +44 (0) 191 410 5121  
[www.domnickhunter.com](http://www.domnickhunter.com)

## Asia Pacific

Australia  
NSW 2154, Australia  
+61 2 9634 777  
[www.parker.com/australia](http://www.parker.com/australia)

China  
Shanghai 101206 China  
+86 21 5031 2525  
[www.parker.com/china](http://www.parker.com/china)

India  
Mahape, Navi Mumbai 400 709 India  
T +91 22 5613 7081, 82, 83, 84, 85  
[www.parker.com/india](http://www.parker.com/india)

Japan  
Yokohama-shi, 244-0003 Japan  
T +81 45 870 1522  
[www.parker.com/japan](http://www.parker.com/japan)

Korea  
Hwaseong-City Gyeonggi-Do, Korea  
T +82 31 359 0771  
[www.parker.com/korea](http://www.parker.com/korea)

Singapore  
Singapore 619 702  
T +65 6887 6300  
[www.parker.com/singapore](http://www.parker.com/singapore)

Thailand  
Bangkok 10250 Thailand  
T +66 (0)2 186 7024  
[www.parker.com/thailand](http://www.parker.com/thailand)

## Latin America

Parker Comercio Ltda.  
Filtration Division  
Sao Jose dos Campos  
CEP 12225-390 SP Brazil  
+55 12 4009 3500  
[www.parker.com/br](http://www.parker.com/br)

Pan American Division – Miami  
Miami, FL  
305 470 8800  
[www.parker.com/panam](http://www.parker.com/panam)

## Africa

Aeroporto Kempton Park  
1620 South Africa  
+27 11 9610700  
[www.parker.com/ea](http://www.parker.com/ea)

SNAPP and Aquabloc are trademarks of Racor Division, Parker Hannifin Corporation. © 2014

Brochure RSL0154 Rev 01/14

800 344 3286 [parker-racor.com/snappmarine](http://parker-racor.com/snappmarine)



Parker Hannifin Corporation  
Filtration Group Global Head-  
quarters  
6035 Parkland Boulevard  
Cleveland, OH 44124-4141  
phone 216 896 3000  
fax 216 896 4021  
[www.parker.com/racor](http://www.parker.com/racor)