



TopSpin™ Pre-Cleaner

EXTENDS THE AIR FILTER LIFE
AND BOOSTS SYSTEM EFFICIENCY



Extend the Life of Your Air Filter

If your vehicle already has a pre-cleaner, you obviously recognize its importance. A pre-cleaner will extend the life of your air filter and reduce overall operating costs. Donaldson TopSpin will separate a greater amount of debris and contaminant compared to competitive products.



TopSpin™ products are protected internationally by patents, trademarks, and design registrations, both issued and pending.

TopSpin™ Pre-Cleaner in Action!



Although it's not visible because of the dust cloud, Donaldson TopSpin model H002431 was doing its job during this Best in the Desert Hummer Race. According to Robert Everhart, "The vehicle was going about 70 mph. The dust explosion was seen by people ¼ mile away."



No matter what type of crop or field, Donaldson TopSpin pre-cleaner stops debris and chaff from entering the intake during harvesting to extend the life of the primary filter.

Features & Benefits

Separates up to 85% of incoming contaminant

(per ISO 5011/SAE J726)

Greatly extends air filter life

Reduces air filter usage

Lowers cost per operating hour

Automatically ejects mixed debris

Separates more than 99% of particles 20 micron and larger

Dual mounted bearings

More robust design

Extends bearing life

Operates at a lower RPM

Less noise

Longer bearing life

Lower restriction

Self-cleaning/self-scavenging

No maintenance to clean bowl

No exhaust ejector required

Easy installation

Quick installation

One clamp to tighten

No wires or power requirements

Lighter weight

Lighter than competitive pre-cleaners

Lighter than Donaldson full-view pre-cleaner

Design Improvements

Compared to the original TopSpin (clear cover) models, the design is now more robust!



Picture of the TopSpin pre-cleaner from Donaldson design verification lab after 20 hours of ISO fine dust loading at two times zero visibility.

The TopSpin cover is heavy-duty, solid black polypropylene – a stronger material that can withstand greater vibration. The internal blade mechanism bearings are now protected to extend bearing life.

How it Works!

More than 99% of contaminant 20 micron and larger is expelled

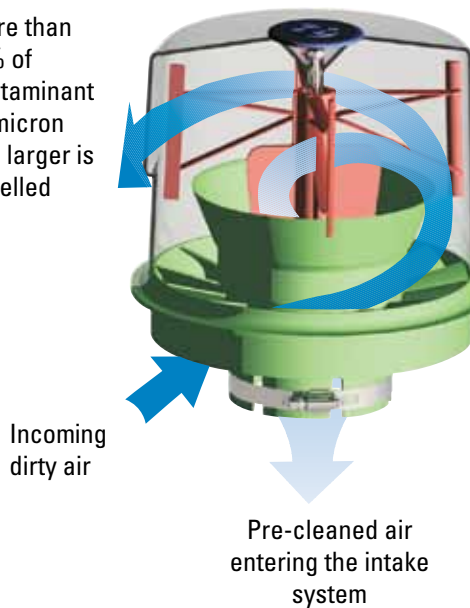

View of the internal design of a redesigned TopSpin Pre-cleaner.



Performance Curves

The Donaldson TopSpin pre-cleaner has the lowest restriction of any competitive brands tested, including our own full-view pre-cleaner.

Multiple tests conducted per ISO 5011/SAE J726 and average results are shown in charts below.

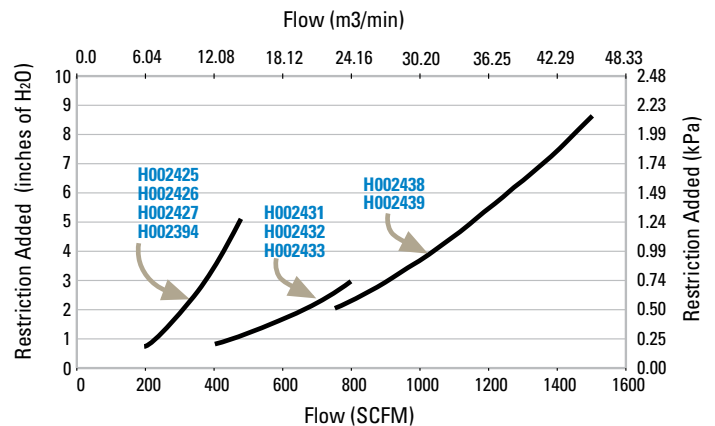
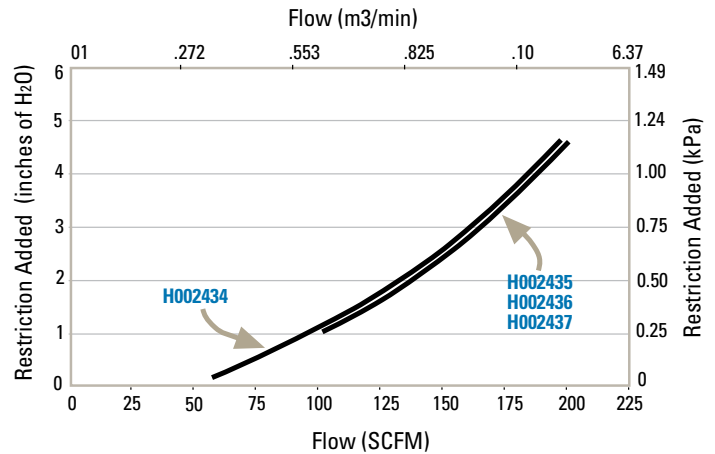

Why is lower restriction better?

- Your engine “breathes” easier
- You can reduce air filter usage
- You will have lower costs per operating hour
- More dust loaded on the filter when serviced by restriction



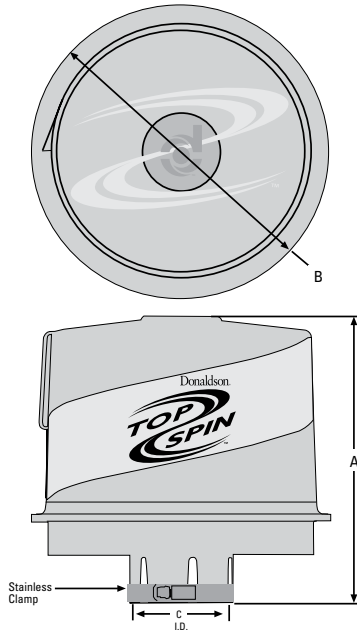

Dimensional Specifications & Order Information

Donaldson TopSpin can be mounted horizontally or vertically. Installation instructions, stainless clamp and one-year warranty are included.

Operating temperature range: -40°F to 180°F (-40°C - 82°C)



SCFM = Standard Cubic Feet per Minute. The ISO 5011/SAEJ726 test procedure was used to extract the results in the charts above. The ISO 5011/SAEJ726 is a widely accepted industry test used by OEMs to evaluate the efficiency of the intake system components. Test results are an average from testing several units.

Outlet I.D. (C)		Overall Height (A)		Body Dia. (B)		Part Number & Image	Operating Flow Range		Weight		
in.	mm	in.	mm	in.	mm		CFM	m ³ /min	lbs.	kg.	
2.03	56	5.75	146	6.38	162	H002434		50-200	2.5-5.7	1.0	0.4
2.27	58	5.75	146	6.38	162	H002435		90-200	2.5-5.7	1.0	0.4
2.53	64	5.75	146	6.38	162	H002436		90-200	2.5-5.7	1.0	0.4
3.03	77	5.75	146	6.38	162	H002437		90-200	2.5-5.7	1.0	0.4
3.07	78	9.39	238	9.51	242	H002425		200-450	5.7-12.7	2.2	1.0
3.83	97	9.39	238	9.51	242	H002426		200-450	5.7-12.7	2.2	1.0
4.06	103	9.39	238	9.51	242	H002394		200-450	5.7-12.7	2.2	1.0
4.56	116	9.39	238	9.51	242	H002427		200-450	5.7-12.7	2.2	1.0
4.06	103	11.30	287	11.32	288	H002431		450-750	12.7-21.2	2.7	1.2
4.56	116	11.30	287	11.32	288	H002432		450-750	12.7-21.2	2.7	1.2
5.03	128	11.30	287	11.32	288	H002433		450-750	12.7-21.2	2.7	1.2
6.03	153	13.57	345	15.62	397	H002438		750-1500	21.2-42.5	6.0	2.7
7.03	179	13.57	345	15.62	397	H002439		750-1500	21.2-42.5	6.0	2.7

Competitive Cross Reference

Centri

EX-20	H002434
EX-30	H002425
EX-40	H002494
EX-50	H002433
EX-55	H002436
EX-60	H002438
EX-70	H002439

Enginaire

3-75/250	H002434
4-150/455	H002394
4.5-250/600	H002432
5-250/600	H002433
65-250/600	H002433

Fleetguard

AP8403	H002394
AP8404	H002433
AP8405	H002439
AP8406	H002439
AP8408	H002434
AP8409	H002394
AP8410	H002433

Sy-Klone

9000R	H002434
9001	H002427
9001R	H002394
9002/9002R	H002433
9003	H002439
9004	H002439
9005	H002394

Turbo II

24	H002437
35	H002427
46	H002432
	H002433
68	H002438
	H002439

Turbo III

50	H002437
200	H002427
500	H002438
	H002439

Eliminate Bowl Dumping!

If your equipment has one of Donaldson's original full-view pre-cleaners, switching to a TopSpin Pre-Cleaner can eliminate the routine task of emptying the bowl.

Donaldson Full-View Pre-Cleaners



Full-View Pre-Cleaner	TopSpin™ Pre-Cleaner
H000820	H002425
H000821	H002426
H000858	H002394
H000823	H002427
H001250	H002435
H001251	H002436
H001249	H002437
H001823	H002434
H002043	H002433
H002044	H002432
H002045	H002431
H002223	H002438
H002224	H002439



Donaldson Company, Inc.
PO Box 1299
Minneapolis, MN
55440-1299

www.donaldson.com

North America 800-374-1374
Mexico +52-449-910-6150
Latin Am. & Caribbean +52-449-910-6150
Brazil +55-11-2119-1604
Europe +32-16-38-3811
South Africa +27-11-997-6000

South East Asia 65-6311-7373
Greater China 852-2405-8388
Japan 81-42-540-4112
Australia 61-02-4350-2033
India +91-124-2290060

Brochure No. F111107 (08/09)

© 2009 Donaldson Company, Inc. Donaldson Company, Inc. reserves the right to change or discontinue any model or specification at any time and without notice. Printed in the U.S.A.