



SAKURA

CATERPILLAR

FILTER SUB-CATALOGUE





Table of Contents

Engine Application

A

Technical Specification

B



Engine Application

A

Sakura Filter

ENGINE APPLICATION

MODEL/APPLICATION	SAKURA NO	MODEL/APPLICATION	SAKURA NO	MODEL/APPLICATION	SAKURA NO
CATERPILLAR		CATERPILLAR		CATERPILLAR	
120 (MOTOR GRADERS) S/N: 14K1-UP Fuel Filter Secondary..... FC-5507 Oil Filter Full Flow..... 0-5502		Hydraulic Oil Filter..... H-5506 Hydraulic Oil Filter..... H-55270 Hydraulic Oil Filter..... H-5504 Oil Filter Full Flow..... C-5510		Fuel Filter Secondary..... FC-5515 Fuel Filter Secondary..... FC-55151 Fuel Filter..... FC-5508 Fuel Filter..... FC-5516 Hydraulic Oil Filter..... H-55270 Hydraulic Oil Filter..... H-5506 Oil Filter Full Flow..... C-5510	
120 (MOTOR GRADERS) S/N: 22R1-941 Air Filter Secondary..... A-5510 Air Filter Set..... A-5549M-S Air Filter Secondary..... A-5550 Air Filter Primary..... A-5509 Air Filter Set..... A-5522-S Air Filter Primary..... A-5549M Air Filter Primary..... A-5549 Fuel Filter Secondary..... FC-5507 Oil Filter Full Flow..... 0-5502		120H (MOTOR GRADERS) S/N: 5FM1-UP Air Filter Primary..... A-5566 Air Filter Secondary..... A-5567 Air Filter Set..... A-5568-S Fuel Filter Secondary..... FC-55151 Fuel Filter Secondary..... FC-5515 Fuel Filter..... FC-5516 Fuel Filter..... FC-5508 Hydraulic Oil Filter..... H-55270 Hydraulic Oil Filter..... H-5506 Oil Filter Full Flow..... C-5510		120H (MOTOR GRADERS) S/N: ALZ1-UP Air Filter Secondary..... A-5534 Air Filter Set..... A-5573-S Air Filter Primary..... A-5535 Cabin Air Filter..... CA-5501 Fuel Filter..... FC-5517 Hydraulic Oil Filter..... H-5506	
120 (MOTOR GRADERS) S/N: 22R942-UP Air Filter Secondary..... A-5550 Air Filter Secondary..... A-5510 Air Filter Set..... A-5549M-S Air Filter Primary..... A-5509 Air Filter Set..... A-5522-S Air Filter Primary..... A-5549M Air Filter Primary..... A-5549 Fuel Filter Secondary..... FC-5507 Oil Filter Full Flow..... C-5510		120H (MOTOR GRADERS) S/N: 6NM1-UP Air Filter Primary..... A-5566 Air Filter Secondary..... A-5567 Air Filter Set..... A-5568-S Fuel Filter Secondary..... FC-5515 Fuel Filter Secondary..... FC-55151 Fuel Filter..... FC-5516 Fuel Filter..... FC-5508 Hydraulic Oil Filter..... H-55270 Hydraulic Oil Filter..... H-5504 Hydraulic Oil Filter..... H-5506 Oil Filter Full Flow..... C-5510		120H (MOTOR GRADERS) S/N: CAF1-UP Air Filter Primary..... A-5535 Air Filter Set..... A-5573-S Air Filter Secondary..... A-5534 Cabin Air Filter..... CA-5501 Fuel Filter..... FC-5517 Hydraulic Oil Filter..... H-5506	
120 (MOTOR GRADERS) S/N: 64U1-UP Air Filter Set..... A-5549M-S Air Filter Secondary..... A-5510 Air Filter Primary..... A-5549M Air Filter Primary..... A-5509 Air Filter Secondary..... A-5550 Air Filter Set..... A-5522-S Air Filter Primary..... A-5549 Fuel Filter Secondary..... FC-5507 Oil Filter Full Flow..... C-5510		120H (MOTOR GRADERS) S/N: 6TM1-UP Air Filter Set..... A-5568-S Air Filter Secondary..... A-5567 Air Filter Primary..... A-5566 Fuel Filter Secondary..... FC-5515 Fuel Filter..... FC-5508 Fuel Filter..... FC-5516 Fuel Filter Secondary..... FC-55151 Hydraulic Oil Filter..... H-5506 Hydraulic Oil Filter..... H-55270 Hydraulic Oil Filter..... H-5504 Oil Filter Full Flow..... C-5510		120B (MOTOR GRADERS) CAT 3306 (S/N: 32C100-UP) Air Filter Primary..... A-5509 Air Filter Set..... A-5522-S Air Filter Secondary..... A-5510 Fuel Filter Secondary..... FC-5507 Oil Filter Full Flow..... C-5510	
120H (MOTOR GRADERS) CAT 3126B (S/N: 2AN1-UP) Air Filter Primary..... A-5566 Air Filter Secondary..... A-5567 Air Filter Set..... A-5568-S Fuel Filter Secondary..... FC-55151 Fuel Filter Secondary..... FC-5515 Fuel Filter..... FC-5516 Fuel Filter..... FC-5508 Hydraulic Oil Filter..... H-5506 Hydraulic Oil Filter..... H-5504 Oil Filter Full Flow..... C-5510		120H (MOTOR GRADERS) S/N: 6YN1-UP Air Filter Primary..... A-5566 Air Filter Secondary..... A-5567 Air Filter Set..... A-5568-S Fuel Filter Secondary..... FC-5515 Fuel Filter..... FC-5508 Fuel Filter..... FC-5516 Fuel Filter Secondary..... FC-55151 Hydraulic Oil Filter..... H-5506 Hydraulic Oil Filter..... H-55270 Oil Filter Full Flow..... C-5510		120G (MOTOR GRADERS) S/N: 11W1251-UP Air Filter Set..... A-5507-S Air Filter Set..... A-5568-S Air Filter Primary..... A-5566 Air Filter Set..... A-55071-S Air Filter Primary..... A-5507 Air Filter Secondary..... A-5508 Air Filter Secondary..... A-5567 Hydraulic Oil Filter..... H-5504 Hydraulic Oil Filter..... H-55270	
120H (MOTOR GRADERS) CAT 3126B (S/N: 4MK1-UP) Air Filter Primary..... A-5566 Air Filter Set..... A-5568-S Air Filter Secondary..... A-5567 Cabin Air Filter..... CA-5501 Fuel Filter Secondary..... FC-5515 Fuel Filter..... FC-5508 Fuel Filter..... FC-5516 Fuel Filter Secondary..... FC-55151		120H (MOTOR GRADERS) S/N: 9YR1-UP Air Filter Primary..... A-5566 Air Filter Secondary..... A-5567 Air Filter Set..... A-5568-S		120G (MOTOR GRADERS) S/N: 4HD1-702 Air Filter Secondary..... A-5508 Air Filter Primary..... A-5566 Air Filter Set..... A-55071-S Air Filter Secondary..... A-5567 Air Filter Set..... A-5507-S Air Filter Set..... A-5568-S Air Filter Primary..... A-5507 Hydraulic Oil Filter..... H-5504 Hydraulic Oil Filter..... H-55270	

MODEL/APPLICATION	SAKURA NO
CATERPILLAR	
120G (MOTOR GRADERS) S/N: 4HD1-UP	
Air Filter Set.....	A-5507-S
Air Filter Primary.....	A-5566
Air Filter Primary.....	A-5507
Air Filter Set.....	A-55071-S
Air Filter Secondary.....	A-5508
Air Filter Secondary.....	A-5567
Air Filter Set.....	A-5568-S
Fuel Filter.....	F-5505
Fuel Filter Secondary.....	FC-5507
Hydraulic Oil Filter.....	H-5504
Hydraulic Oil Filter.....	H-55270
Oil Filter Full Flow.....	C-5510
120G (MOTOR GRADERS) S/N: 4HD703-UP	
Air Filter Secondary.....	A-5567
Air Filter Primary.....	A-5566
Air Filter Set.....	A-55071-S
Air Filter Primary.....	A-5507
Air Filter Secondary.....	A-5508
Air Filter Set.....	A-5568-S
Air Filter Set.....	A-5507-S
Hydraulic Oil Filter.....	H-5504
Hydraulic Oil Filter.....	H-55270
120G (MOTOR GRADERS) S/N: 82V1-UP	
Air Filter Set.....	A-5568-S
Air Filter Primary.....	A-5566
Air Filter Set.....	A-55071-S
Air Filter Secondary.....	A-5567
Air Filter Primary.....	A-5507
Air Filter Secondary.....	A-5508
Air Filter Set.....	A-5507-S
Fuel Filter Secondary.....	FC-5507
Hydraulic Oil Filter.....	H-5504
Oil Filter Full Flow.....	C-5510
120G (MOTOR GRADERS) S/N: 87V1-UP	
Air Filter Set.....	A-5568-S
Air Filter Set.....	A-5507-S
Air Filter Primary.....	A-5566
Air Filter Secondary.....	A-5508
Air Filter Primary.....	A-5507
Air Filter Secondary.....	A-5567
Air Filter Set.....	A-55071-S
Fuel Filter Secondary.....	FC-5507
Hydraulic Oil Filter.....	H-5504
Oil Filter Full Flow.....	C-5510
120G (MOTOR GRADERS) S/N: 87V8319-8359	
Hydraulic Oil Filter.....	H-55270
Hydraulic Oil Filter.....	H-5504
120G (MOTOR GRADERS) S/N: 87V8360-UP	
Air Filter Set.....	A-5507-S
Air Filter Primary.....	A-5566
Air Filter Secondary.....	A-5567

MODEL/APPLICATION	SAKURA NO
CATERPILLAR	
Air Filter Set.....	A-55071-S
Air Filter Primary.....	A-5507
Air Filter Secondary.....	A-5508
Air Filter Set.....	A-5568-S
Hydraulic Oil Filter.....	H-5504
Hydraulic Oil Filter.....	H-55270
120G (MOTOR GRADERS) w/3304 Eng.	
Hydraulic Oil Filter.....	H-55320
120H NA (MOTOR GRADERS) S/N: 2AN1-UP	
Oil Filter Full Flow.....	C-5510
120H ES (MOTOR GRADERS)	
Air Filter Set.....	A-5568-S
Air Filter Secondary.....	A-5567
Air Filter Primary.....	A-5566
Cabin Air Filter.....	CA-5501
Fuel Filter.....	FC-5508
Fuel Filter.....	FC-5516
Fuel Filter Secondary.....	FC-55151
Fuel Filter Secondary.....	FC-5515
Hydraulic Oil Filter.....	H-55270
12 (MOTOR GRADERS) S/N: 38E-38E	
Air Filter Set.....	A-5507-S
Air Filter Primary.....	A-5507
Air Filter Set.....	A-55071-S
Air Filter Secondary.....	A-5508
Oil Filter Full Flow.....	O-5501
12 (MOTOR GRADERS) S/N: 70D-70D	
Air Filter Set.....	A-5507-S
Air Filter Set.....	A-55071-S
Air Filter Secondary.....	A-5508
Air Filter Primary.....	A-5507
Air Filter Set.....	A-55071-S
Oil Filter Full Flow.....	O-5501
12 (MOTOR GRADERS) S/N: 71D-71D	
Air Filter Set.....	A-5507-S
Air Filter Secondary.....	A-5508
Air Filter Primary.....	A-5507
Air Filter Set.....	A-55071-S
Oil Filter Full Flow.....	O-5501
12 (MOTOR GRADERS) S/N: 7T-7T	
Oil Filter Full Flow.....	O-5501
12 (MOTOR GRADERS) S/N: 80C-80C	
Air Filter Set.....	A-55071-S
Air Filter Set.....	A-5507-S
Air Filter Primary.....	A-5507
Air Filter Secondary.....	A-5508
Oil Filter Full Flow.....	O-5501
12 (MOTOR GRADERS) S/N: 81T-1859	
Oil Filter Full Flow.....	O-5501

MODEL/APPLICATION	SAKURA NO
CATERPILLAR	
12 (MOTOR GRADERS) S/N: 8T-8T	
Air Filter Primary.....	A-5507
Air Filter Secondary.....	A-5508
Air Filter Set.....	A-55071-S
Air Filter Set.....	A-5507-S
Oil Filter Full Flow.....	O-5501
12 (MOTOR GRADERS) S/N: 94C-94C	
Air Filter Set.....	A-5507-S
Air Filter Secondary.....	A-5508
Air Filter Primary.....	A-5507
Air Filter Set.....	A-55071-S
Oil Filter Full Flow.....	O-5501
120E (MOTOR GRADERS)	
Air Filter Secondary.....	A-5550
Air Filter Set.....	A-5549M-S
Air Filter Set.....	A-5522-S
Air Filter Primary.....	A-5509
Air Filter Secondary.....	A-5510
Air Filter Primary.....	A-5549
Air Filter Primary.....	A-5549M
Hydraulic Oil Filter.....	H-5504
Oil Filter Full Flow.....	C-5510
Oil Filter Full Flow.....	O-5502
120M (MOTOR GRADERS) CAT C6.6	
Cabin Air Filter.....	CA-55110
Hydraulic Oil Filter Transmission..	EH-55010
120M2 (MOTOR GRADERS) CAT C7.1 ACERT	
Fuel Filter.....	EF-55050
12E (MOTOR GRADERS) S/N: 17K1-UP	
Fuel Filter Secondary.....	FC-5507
12E (MOTOR GRADERS) S/N: 99E1-UP	
Air Filter Secondary.....	A-5508
Air Filter Set.....	A-55071-S
Air Filter Primary.....	A-5566
Air Filter Primary.....	A-5507
Air Filter Set.....	A-5507-S
Air Filter Secondary.....	A-5567
Air Filter Set.....	A-5568-S
Fuel Filter.....	F-5501
Oil Filter Full Flow.....	O-5502
12F (MOTOR GRADERS)	
Fuel Filter.....	F-5503
12F (MOTOR GRADERS) S/N: 13K1-4567	
Air Filter Primary.....	A-5549
Air Filter Secondary.....	A-5550
Air Filter Set.....	A-5549M-S
Air Filter Secondary.....	A-5510
Air Filter Set.....	A-5522-S

MODEL/APPLICATION	SAKURA NO
-------------------	-----------

CATERPILLAR

12F
(MOTOR GRADERS)
S/N: 13K1-4567

Air Filter Primary.....	A-5509
Air Filter Primary.....	A-5549M
Fuel Filter Secondary.....	FC-5507
Oil Filter Full Flow.....	O-5502

12F
(MOTOR GRADERS)
S/N: 13K4568-UP

Air Filter Secondary.....	A-5550
Air Filter Secondary.....	A-5510
Air Filter Set.....	A-5549M-S
Air Filter Primary.....	A-5509
Air Filter Primary.....	A-5549
Air Filter Set.....	A-5522-S
Air Filter Primary.....	A-5549M
Fuel Filter Secondary.....	FC-5507
Oil Filter Full Flow.....	C-5510

12F
(MOTOR GRADERS)
S/N: 73G1-UP

Air Filter Secondary.....	A-5550
Air Filter Set.....	A-5549M-S
Air Filter Secondary.....	A-5510
Air Filter Primary.....	A-5509
Air Filter Set.....	A-5522-S
Air Filter Primary.....	A-5549M
Air Filter Primary.....	A-5549
Fuel Filter.....	F-5501
Hydraulic Oil Filter.....	H-5502
Oil Filter Full Flow.....	O-5502

12F
(MOTOR GRADERS)
S/N: 89H1-1224

Air Filter Primary.....	A-5509
Air Filter Set.....	A-5522-S
Air Filter Primary.....	A-5549M
Air Filter Primary.....	A-5549
Air Filter Secondary.....	A-5550
Air Filter Set.....	A-5549M-S
Air Filter Secondary.....	A-5510
Fuel Filter Secondary.....	FC-5507
Fuel Filter.....	F-5501
Hydraulic Oil Filter.....	H-5502
Hydraulic Oil Filter.....	H-5504
Oil Filter Full Flow.....	O-5502

12F
(MOTOR GRADERS)
S/N: 89H1225-UP

Air Filter Primary.....	A-5549
Air Filter Secondary.....	A-5550
Air Filter Secondary.....	A-5510
Air Filter Set.....	A-5549M-S
Air Filter Set.....	A-5522-S
Air Filter Primary.....	A-5549M
Air Filter Primary.....	A-5509
Fuel Filter Secondary.....	FC-5507
Fuel Filter.....	F-5501
Hydraulic Oil Filter.....	H-5504
Hydraulic Oil Filter.....	H-5502
Oil Filter Full Flow.....	C-5510

MODEL/APPLICATION	SAKURA NO
-------------------	-----------

CATERPILLAR

12G
(MOTOR GRADERS)
CAT 3306

Air Filter Set.....	A-5507-S
Air Filter Primary.....	A-5507
Air Filter Secondary.....	A-5508
Air Filter Set.....	A-55071-S
Fuel Filter Secondary.....	FC-5507
Hydraulic Oil Filter.....	H-5504
Hydraulic Oil Filter.....	H-55270
Oil Filter Full Flow.....	C-5510

12G
(MOTOR GRADERS)
CAT 3306 (S/N: 3PL1-UP)

Air Filter Set.....	A-5568-S
Air Filter Set.....	A-5507-S
Air Filter Primary.....	A-5566
Air Filter Primary.....	A-5507
Air Filter Set.....	A-55071-S
Air Filter Secondary.....	A-5567
Fuel Filter.....	F-5505
Fuel Filter Secondary.....	FC-5507
Hydraulic Oil Filter.....	H-5504
Oil Filter Full Flow.....	C-5510

12G
(MOTOR GRADERS)
CAT 3306 (S/N: 3WC1067-UP)

Air Filter Secondary.....	A-5567
Air Filter Primary.....	A-5566
Air Filter Primary.....	A-5507
Air Filter Set.....	A-5507-S
Air Filter Set.....	A-5568-S
Air Filter Set.....	A-55071-S
Fuel Filter Secondary.....	FC-5507
Fuel Filter.....	F-5505
Hydraulic Oil Filter.....	H-5504
Oil Filter Full Flow.....	C-5510

12G
(MOTOR GRADERS)
CAT 3306 (S/N: 61M1-UP)

Air Filter Primary.....	A-5507
Air Filter Secondary.....	A-5508
Air Filter Set.....	A-5507-S
Air Filter Set.....	A-55071-S
Fuel Filter Secondary.....	FC-5507
Hydraulic Oil Filter.....	H-5504
Oil Filter Full Flow.....	C-5510

12G
(MOTOR GRADERS)
S/N: 3PL842-UP

Air Filter Primary.....	A-5566
Air Filter Secondary.....	A-5567
Air Filter Set.....	A-5568-S

12G
(MOTOR GRADERS)
S/N: 3WC1-1066

Air Filter Secondary.....	A-5508
Air Filter Set.....	A-55071-S
Air Filter Set.....	A-5507-S
Air Filter Primary.....	A-5507
Fuel Filter.....	F-5505
Fuel Filter Secondary.....	FC-5507
Hydraulic Oil Filter.....	H-5504
Hydraulic Oil Filter.....	H-55270

MODEL/APPLICATION	SAKURA NO
-------------------	-----------

CATERPILLAR

Oil Filter Full Flow.....	C-5510
---------------------------	--------

12H
(MOTOR GRADERS)
S/N: 2G51-UP

Air Filter Set.....	A-5573-S
Air Filter Primary.....	A-5535
Air Filter Secondary.....	A-5534
Fuel Filter.....	F-5505
Fuel Filter Secondary.....	FC-5507
Hydraulic Oil Filter.....	H-5506
Hydraulic Oil Filter.....	H-55270
Oil Filter Full Flow.....	C-5510

12H
(MOTOR GRADERS)
S/N: 2LR1-UP

Air Filter Set.....	A-5573-S
Air Filter Primary.....	A-5535
Air Filter Secondary.....	A-5534
Fuel Filter Secondary.....	FC-5507
Fuel Filter.....	F-5505
Hydraulic Oil Filter.....	H-5504
Hydraulic Oil Filter.....	H-5506
Hydraulic Oil Filter.....	H-55270
Oil Filter Full Flow.....	C-5510

12H
(MOTOR GRADERS)
S/N: 2WR1-UP

Air Filter Primary.....	A-5566
Air Filter Set.....	A-5573-S
Air Filter Primary.....	A-5535
Air Filter Secondary.....	A-5534
Air Filter Secondary.....	A-5567
Air Filter Set.....	A-5568-S
Fuel Filter.....	F-5505
Fuel Filter Secondary.....	FC-5507
Hydraulic Oil Filter.....	H-55270
Hydraulic Oil Filter.....	H-5506
Hydraulic Oil Filter.....	H-5504
Oil Filter Full Flow.....	C-5510

12H
(MOTOR GRADERS)
S/N: 4ER1-UP

Air Filter Secondary.....	A-5567
Air Filter Primary.....	A-5566
Air Filter Set.....	A-5568-S
Fuel Filter.....	F-5505
Fuel Filter Secondary.....	FC-5507
Hydraulic Oil Filter.....	H-5506
Hydraulic Oil Filter.....	H-55270
Oil Filter Full Flow.....	C-5510

12H
(MOTOR GRADERS)
S/N: 4XM1-UP

Air Filter Set.....	A-5573-S
Air Filter Primary.....	A-5566
Air Filter Primary.....	A-5535
Air Filter Set.....	A-5568-S
Air Filter Secondary.....	A-5534
Air Filter Secondary.....	A-5567
Fuel Filter Secondary.....	FC-5507
Fuel Filter.....	F-5505
Hydraulic Oil Filter.....	H-5504
Hydraulic Oil Filter.....	H-5506
Hydraulic Oil Filter.....	H-55270

Sakura Filter

ENGINE APPLICATION

MODEL/APPLICATION	SAKURA NO	MODEL/APPLICATION	SAKURA NO	MODEL/APPLICATION	SAKURA NO
CATERPILLAR		CATERPILLAR		CATERPILLAR	
12H (MOTOR GRADERS) S/N: 4XM1-UP Oil Filter Full Flow.....	C-5510	Hydraulic Oil Filter.....	H-5506	Fuel Filter Secondary.....	FC-55151
12H (MOTOR GRADERS) S/N: 5ZM1-UP Air Filter Set.....	A-5568-S	Hydraulic Oil Filter.....	H-55270	Hydraulic Oil Filter.....	H-5504
Air Filter Primary.....	A-5566	Hydraulic Oil Filter.....	H-5504	Hydraulic Oil Filter.....	H-5506
Air Filter Secondary.....	A-5567	Oil Filter Full Flow.....	C-5510	Hydraulic Oil Filter.....	H-55270
Fuel Filter.....	F-5505	12H NA (MOTOR GRADERS) w/3306 Eng. Air Filter Set.....	A-5573M-S	Oil Filter Full Flow.....	C-5510
Fuel Filter Secondary.....	FC-5507	Air Filter Primary.....	A-5535M	135H (MOTOR GRADERS) CAT 3116T VHP (S/N: 7MM1-UP) Air Filter Set.....	A-5568-S
Hydraulic Oil Filter.....	H-55270	12H NA (MOTOR GRADERS) w/3306B Eng. Cabin Air Filter.....	CA-55150	Air Filter Primary.....	A-5566
Hydraulic Oil Filter.....	H-5506	12K (MOTOR GRADERS) w/C7 Eng. Cabin Air Filter.....	CA-55150	Air Filter Secondary.....	A-5567
Hydraulic Oil Filter.....	H-5504	12M (MOTOR GRADERS) CAT C6.6 Cabin Air Filter.....	CA-55110	Fuel Filter Secondary.....	FC-5515
Oil Filter Full Flow.....	C-5510	12M (MOTOR GRADERS) CAT C7.2 Cabin Air Filter.....	CA-55110	Fuel Filter.....	FC-5508
12H (MOTOR GRADERS) S/N: 8MN1-UP Air Filter Set.....	A-5568-S	130G (MOTOR GRADERS) CAT 3304 (S/N: 12W1-UP) Air Filter Set.....	A-5507-S	Fuel Filter.....	FC-5516
Air Filter Primary.....	A-5566	Air Filter Set.....	A-55071-S	Fuel Filter Secondary.....	FC-55151
Air Filter Set.....	A-5573-S	Air Filter Primary.....	A-5507	Hydraulic Oil Filter.....	H-55270
Air Filter Primary.....	A-5535	Fuel Filter.....	F-5505	Hydraulic Oil Filter.....	H-5504
Air Filter Secondary.....	A-5534	Fuel Filter Secondary.....	FC-5507	Oil Filter Full Flow.....	C-5510
Air Filter Secondary.....	A-5567	Hydraulic Oil Filter.....	H-5504	135H (MOTOR GRADERS) w/3126B Eng. Air Filter Primary.....	A-5535M
Fuel Filter.....	F-5505	Oil Filter Full Flow.....	C-5510	Air Filter Set.....	A-5573M-S
Fuel Filter Secondary.....	FC-5507	130G (MOTOR GRADERS) CAT 3304 (S/N: 74V1-UP) Air Filter Set.....	A-5507-S	Cabin Air Filter.....	CA-55150
Hydraulic Oil Filter.....	H-5506	Air Filter Set.....	A-55071-S	135H NA (MOTOR GRADERS) S/N: 3YK1-UP Oil Filter Full Flow.....	C-5510
Hydraulic Oil Filter.....	H-55270	Air Filter Primary.....	A-5507	140 (MOTOR GRADERS) Fuel Filter.....	F-5503
Oil Filter Full Flow.....	C-5510	Fuel Filter.....	F-5505	140 (MOTOR GRADERS) S/N: 11R1-651 Air Filter Set.....	A-5549M-S
12H (MOTOR GRADERS) w/3306 Eng. Air Filter Set.....	A-5573M-S	Fuel Filter Secondary.....	FC-5507	Air Filter Secondary.....	A-5510
Air Filter Primary.....	A-5535M	Hydraulic Oil Filter.....	H-5504	Air Filter Primary.....	A-5549
12H (MOTOR GRADERS) w/C9 Eng. Air Filter Set.....	A-5573M-S	Oil Filter Full Flow.....	C-5510	Air Filter Secondary.....	A-5550
Air Filter Primary.....	A-5535M	130G (MOTOR GRADERS) S/N: 7GB1224-UP Air Filter Set.....	A-55071-S	Air Filter Primary.....	A-5509
Cabin Air Filter.....	CA-55150	Air Filter Primary.....	A-5507	Air Filter Set.....	A-5522-S
12H ES (MOTOR GRADERS) Air Filter Secondary.....	A-5534	Air Filter Secondary.....	A-5508	Air Filter Primary.....	A-5549M
Air Filter Primary.....	A-5535	Air Filter Set.....	A-5507-S	Fuel Filter Secondary.....	FC-5507
Air Filter Set.....	A-5573-S	Fuel Filter Secondary.....	FC-5507	Oil Filter Full Flow.....	O-5502
Fuel Filter Secondary.....	FC-5507	Fuel Filter.....	F-5505	140 (MOTOR GRADERS) S/N: 11R652-UP Air Filter Primary.....	A-5549M
Oil Filter Full Flow.....	C-5510	Hydraulic Oil Filter.....	H-5504	Air Filter Primary.....	A-5549
12H ES (MOTOR GRADERS) w/3306 Eng. Air Filter Primary.....	A-5535M	Hydraulic Oil Filter.....	H-55270	Air Filter Secondary.....	A-5550
Air Filter Set.....	A-5573M-S	Oil Filter Full Flow.....	C-5510	Air Filter Set.....	A-5522-S
12H NA (MOTOR GRADERS) Air Filter Primary.....	A-5566	130G (MOTOR GRADERS) w/3304 Eng. Hydraulic Oil Filter.....	H-55320	Air Filter Secondary.....	A-5510
Air Filter Set.....	A-5573-S	135H (MOTOR GRADERS) CAT 3116T VHP (S/N: 3YK1-UP) Fuel Filter.....	FC-5508	Fuel Filter.....	F-5505
Air Filter Primary.....	A-5535	Fuel Filter.....	FC-5516	Fuel Filter Secondary.....	FC-5515
Air Filter Secondary.....	A-5534	Fuel Filter Secondary.....	FC-5515		
Air Filter Set.....	A-5568-S				
Air Filter Secondary.....	A-5567				
Cabin Air Filter.....	CA-5501				
Fuel Filter.....	F-5505				
Fuel Filter Secondary.....	FC-5507				

MODEL/APPLICATION	SAKURA NO
CATERPILLAR	
140 <i>(MOTOR GRADERS)</i> S/N: 11R652-UP	
Air Filter Set.....	A-5549M-S
Air Filter Primary.....	A-5509
Fuel Filter Secondary.....	FC-5507
Oil Filter Full Flow.....	C-5510
140 <i>(MOTOR GRADERS)</i> S/N: 14U1-387	
Air Filter Secondary.....	A-5550
Air Filter Set.....	A-5549M-S
Air Filter Primary.....	A-5509
Air Filter Primary.....	A-5549
Air Filter Set.....	A-5522-S
Air Filter Secondary.....	A-5510
Air Filter Primary.....	A-5549M
Fuel Filter Secondary.....	FC-5507
Hydraulic Oil Filter.....	H-5504
Oil Filter Full Flow.....	C-5510
Oil Filter Full Flow.....	O-5501
140 <i>(MOTOR GRADERS)</i> S/N: 14U388-UP	
Air Filter Primary.....	A-5549M
Air Filter Secondary.....	A-5550
Air Filter Set.....	A-5522-S
Air Filter Set.....	A-5549M-S
Air Filter Secondary.....	A-5510
Air Filter Primary.....	A-5509
Air Filter Primary.....	A-5549
Fuel Filter Secondary.....	FC-5507
Hydraulic Oil Filter.....	H-5504
Oil Filter Full Flow.....	C-5510
140 <i>(MOTOR GRADERS)</i> S/N: 22J1-UP	
Hydraulic Oil Filter.....	H-5502
140 <i>(MOTOR GRADERS)</i> S/N: 24R1-UP	
Fuel Filter Secondary.....	FC-5507
Oil Filter Full Flow.....	C-5510
140 <i>(MOTOR GRADERS)</i> S/N: 24R492-UP	
Air Filter Primary.....	A-5509
Air Filter Secondary.....	A-5510
Air Filter Set.....	A-5522-S
Oil Filter Full Flow.....	C-5510
140 <i>(MOTOR GRADERS)</i> S/N: 36X1-UP	
Hydraulic Oil Filter.....	H-5504
Hydraulic Oil Filter.....	H-5502
140 <i>(MOTOR GRADERS)</i> S/N: 55F1-UP	
Fuel Filter Secondary.....	FC-5507
Oil Filter Full Flow.....	C-5510
140 <i>(MOTOR GRADERS)</i> S/N: 72V-UP	
Air Filter Secondary.....	A-5522
Air Filter Set.....	A-5522-S
Air Filter Primary.....	A-5509

MODEL/APPLICATION	SAKURA NO
CATERPILLAR	
Hydraulic Oil Filter.....	H-5504
Oil Filter Full Flow.....	C-5510
140H <i>(MOTOR GRADERS)</i> CAT 3306 (S/N: 22K1-200)	
Air Filter Set.....	A-5573-S
Air Filter Primary.....	A-5535
Air Filter Set.....	A-5522-S
Air Filter Primary.....	A-5509
Air Filter Secondary.....	A-5534
Fuel Filter.....	F-5505
Fuel Filter Secondary.....	FC-5507
Fuel/Water Separator.....	SF-5704
Hydraulic Oil Filter.....	H-5506
Hydraulic Oil Filter.....	H-5504
Oil Filter Full Flow.....	C-5510
140H <i>(MOTOR GRADERS)</i>	
Air Filter Secondary.....	A-5534
Air Filter Set.....	A-5573-S
Air Filter Primary.....	A-5535
Cabin Air Filter.....	CA-5501
Fuel Filter.....	F-5505
Fuel Filter Secondary.....	FC-5507
Hydraulic Oil Filter.....	H-5504
Hydraulic Oil Filter.....	H-55270
Hydraulic Oil Filter.....	H-5506
Oil Filter Full Flow.....	C-5510
140H <i>(MOTOR GRADERS)</i> S/N: 22K201-UP	
Air Filter Set.....	A-5573-S
Air Filter Primary.....	A-5535
Air Filter Secondary.....	A-5534
Fuel Filter Secondary.....	FC-5507
Hydraulic Oil Filter.....	H-5506
Hydraulic Oil Filter.....	H-5504
Oil Filter Full Flow.....	C-5510
140H <i>(MOTOR GRADERS)</i> S/N: 3A500491-UP	
Air Filter Set.....	A-5573-S
Air Filter Primary.....	A-5535
Air Filter Secondary.....	A-5534
Cabin Air Filter.....	CA-5501
Fuel Filter Secondary.....	FC-5507
Fuel Filter.....	F-5505
Hydraulic Oil Filter.....	H-5504
Hydraulic Oil Filter.....	H-5506
Oil Filter Full Flow.....	C-5510
140H <i>(MOTOR GRADERS)</i> S/N: 3A51-UP	
Air Filter Secondary.....	A-5534
Air Filter Primary.....	A-5535
Air Filter Set.....	A-5573-S
Fuel Filter Secondary.....	FC-5507
Fuel Filter.....	F-5505
Hydraulic Oil Filter.....	H-5506
Hydraulic Oil Filter.....	H-55270
Oil Filter Full Flow.....	C-5510

MODEL/APPLICATION	SAKURA NO
CATERPILLAR	
140H <i>(MOTOR GRADERS)</i> S/N: 5HM1-UP	
Air Filter Primary.....	A-5535
Air Filter Secondary.....	A-5534
Air Filter Set.....	A-5573-S
Fuel Filter.....	F-5505
Fuel Filter Secondary.....	FC-5507
Hydraulic Oil Filter.....	H-5506
Hydraulic Oil Filter.....	H-55270
Oil Filter Full Flow.....	C-5510
140H <i>(MOTOR GRADERS)</i> S/N: 8JM1-UP	
Air Filter Secondary.....	A-5534
Air Filter Primary.....	A-5535
Air Filter Set.....	A-5573-S
Fuel Filter Secondary.....	FC-5507
Fuel Filter.....	F-5505
Hydraulic Oil Filter.....	H-5504
Hydraulic Oil Filter.....	H-5506
Hydraulic Oil Filter.....	H-55270
Oil Filter Full Flow.....	C-5510
140H <i>(MOTOR GRADERS)</i> S/N: 8KM1-UP	
Air Filter Secondary.....	A-5534
Air Filter Primary.....	A-5535
Air Filter Set.....	A-5573-S
Fuel Filter.....	F-5505
Fuel Filter Secondary.....	FC-5507
Hydraulic Oil Filter.....	H-5506
Hydraulic Oil Filter.....	H-55270
Hydraulic Oil Filter.....	H-5504
Oil Filter Full Flow.....	C-5510
140H <i>(MOTOR GRADERS)</i> S/N: 9TN1-UP	
Air Filter Secondary.....	A-5534
Air Filter Primary.....	A-5535
Air Filter Set.....	A-5573-S
Fuel Filter Secondary.....	FC-5507
Fuel Filter.....	F-5505
Hydraulic Oil Filter.....	H-55270
Hydraulic Oil Filter.....	H-5506
Oil Filter Full Flow.....	C-5510
140H <i>(MOTOR GRADERS)</i> S/N: 9ZN1-UP	
Air Filter Set.....	A-5573-S
Air Filter Primary.....	A-5535
Air Filter Secondary.....	A-5534
Fuel Filter.....	F-5505
Fuel Filter Secondary.....	FC-5507
Hydraulic Oil Filter.....	H-55270
Hydraulic Oil Filter.....	H-5506
Hydraulic Oil Filter.....	H-5504
Oil Filter Full Flow.....	C-5510
140H <i>(MOTOR GRADERS)</i> W/3176C ENG.	
Air Filter Set.....	A-5573M-S
Air Filter Primary.....	A-5535M
Cabin Air Filter.....	CA-55150

MODEL/APPLICATION	SAKURA NO	MODEL/APPLICATION	SAKURA NO	MODEL/APPLICATION	SAKURA NO
CATERPILLAR		CATERPILLAR		CATERPILLAR	
140H (MOTOR GRADERS) w/3306 Eng.		Air Filter Secondary.....	A-5522	Oil Filter Full Flow.....	0-5501
Air Filter Set.....	A-5573M-S	Air Filter Primary.....	A-5509	14C (MOTOR GRADERS) S/N: 35F-UP	
Air Filter Primary.....	A-5535M	Air Filter Set.....	A-5522-S	Fuel Filter.....	F-5501
140M (MOTOR GRADERS) C9		Fuel Filter Secondary.....	FC-5507	Oil Filter Full Flow.....	0-5501
Cabin Air Filter.....	CA-55110	Hydraulic Oil Filter.....	H-5504	14D (MOTOR GRADERS) S/N: 96F-UP	
140M (MOTOR GRADERS) CAT C7		Oil Filter Full Flow.....	C-5510	Fuel Filter.....	F-5501
Cabin Air Filter.....	CA-55110	140G (MOTOR GRADERS) w/3306 Eng.		Oil Filter Full Flow.....	0-5501
14 (MOTOR GRADERS) S/N: 35F-35F		Hydraulic Oil Filter.....	H-55320	14E (MOTOR GRADERS)	
Fuel Filter.....	F-5501	140H ES (MOTOR GRADERS) w/3306 Eng.		Fuel Filter.....	F-5503
Oil Filter Full Flow.....	0-5501	Air Filter Primary.....	A-5535M	14E (MOTOR GRADERS) S/N: 12K1-1835	
14 (MOTOR GRADERS) S/N: 64C-64C		Air Filter Set.....	A-5573M-S	Air Filter Set.....	A-5522-S
Oil Filter Full Flow.....	0-5501	140H NA (MOTOR GRADERS) w/3306 Eng.		Air Filter Set.....	A-5549M-S
140G (MOTOR GRADERS) 08Z1-0N		Air Filter Primary.....	A-5535M	Air Filter Secondary.....	A-5510
Oil Filter Full Flow.....	C-5506	Air Filter Set.....	A-5573M-S	Air Filter Primary.....	A-5509
140G (MOTOR GRADERS) CAT 3306 (S/N: SMD1-UP)		140B (MOTOR GRADERS) S/N: 33C100-UP		Air Filter Secondary.....	A-5550
Air Filter Secondary.....	A-5522	Fuel Filter Secondary.....	FC-5507	Air Filter Primary.....	A-5549
Air Filter Secondary.....	A-5550	Oil Filter Full Flow.....	C-5510	Air Filter Primary.....	A-5549M
Air Filter Set.....	A-5549M-S	140B (MOTOR GRADERS) S/N: 6151-UP		Fuel Filter.....	F-5501
Air Filter Primary.....	A-5549M	Fuel Filter Secondary.....	FC-5507	Fuel Filter Secondary.....	FC-5507
Air Filter Primary.....	A-5549	Oil Filter Full Flow.....	C-5510	Hydraulic Oil Filter.....	H-5502
Air Filter Primary.....	A-5509	143H (MOTOR GRADERS) CAT 3176C ATAAC VHP		Oil Filter Full Flow.....	0-5502
Fuel Filter.....	F-5505	Air Filter Set.....	A-5573-S	14E (MOTOR GRADERS) S/N: 12K1836-UP	
Fuel Filter Secondary.....	FC-5507	Air Filter Primary.....	A-5535	Air Filter Set.....	A-5522-S
Hydraulic Oil Filter.....	HC-5503	Fuel Filter Secondary.....	FC-5507	Air Filter Secondary.....	A-5510
Hydraulic Oil Filter.....	HC-5506	Hydraulic Oil Filter.....	HC-5508	Air Filter Primary.....	A-5509
Hydraulic Oil Filter.....	H-5504	Hydraulic Oil Filter.....	H-5506	Fuel Filter.....	F-5501
Hydraulic Oil Filter.....	H-5504	Hydraulic Oil Filter.....	H-5504	Fuel Filter Secondary.....	FC-5507
Oil Filter Full Flow.....	C-5510	Hydraulic Oil Filter.....	HC-5504	Hydraulic Oil Filter.....	H-5502
140G (MOTOR GRADERS) CAT 3306 (S/N: 72V1-UP)		Oil Filter Full Flow.....	C-5510	Oil Filter Full Flow.....	C-5510
Air Filter Primary.....	A-5509	143H (MOTOR GRADERS) CAT 3176C ATAAC VHP (S/N: 1A11-UP)		14E (MOTOR GRADERS) S/N: 72G1030-UP	
Air Filter Set.....	A-5522-S	Air Filter Primary.....	A-5535	Air Filter Secondary.....	A-5550
Fuel Filter Secondary.....	FC-5507	Air Filter Set.....	A-5573-S	Air Filter Primary.....	A-5549M
Fuel Filter.....	F-5505	Air Filter Secondary.....	A-5534	Air Filter Primary.....	A-5549
Hydraulic Oil Filter.....	HC-5506	Fuel Filter.....	F-5505	Air Filter Set.....	A-5549M-S
Hydraulic Oil Filter.....	H-5504	Fuel Filter Secondary.....	FC-5507	Air Filter Primary.....	A-5509
Hydraulic Oil Filter.....	HC-5503	Hydraulic Oil Filter.....	HC-5504	Air Filter Set.....	A-5522-S
Oil Filter Full Flow.....	C-5510	Hydraulic Oil Filter.....	H-5506	Air Filter Secondary.....	A-5510
140G (MOTOR GRADERS) CAT 3306 (S/N: 81V1-UP)		Hydraulic Oil Filter.....	H-5504	Fuel Filter Secondary.....	FC-5507
Air Filter Set.....	A-5522-S	Hydraulic Oil Filter.....	H-5504	Hydraulic Oil Filter.....	H-5504
Air Filter Primary.....	A-5509	Hydraulic Oil Filter.....	HC-5504	Oil Filter Full Flow.....	C-5510
Fuel Filter Secondary.....	FC-5507	Hydraulic Oil Filter.....	H-55270	14E (MOTOR GRADERS) S/N: 72G1-1029	
Fuel Filter.....	F-5505	Oil Filter Full Flow.....	C-5510	Air Filter Secondary.....	A-5550
Hydraulic Oil Filter.....	HC-5503	143H (MOTOR GRADERS) w/3176C ENG.		Air Filter Primary.....	A-5549M
Hydraulic Oil Filter.....	HC-5506	Air Filter Primary.....	A-5535M	Air Filter Primary.....	A-5549
Hydraulic Oil Filter.....	H-5504	Air Filter Set.....	A-5573M-S	Air Filter Set.....	A-5522-S
Oil Filter Full Flow.....	C-5510	143H (MOTOR GRADERS) w/3306 Eng.		Air Filter Set.....	A-5549M-S
140G (MOTOR GRADERS) S/N: 72V02537-UP		Air Filter Set.....	A-5573M-S	Air Filter Primary.....	A-5509
Air Filter Set.....	A-5522-S	Air Filter Primary.....	A-5535M	Air Filter Secondary.....	A-5510
Air Filter Primary.....	A-5509	14B (MOTOR GRADERS) S/N: 64C-78E		Fuel Filter Secondary.....	FC-5507
Fuel Filter Secondary.....	FC-5507			Hydraulic Oil Filter.....	H-5504
Fuel Filter.....	F-5505			Oil Filter Full Flow.....	0-5502
Hydraulic Oil Filter.....	HC-5503				
Hydraulic Oil Filter.....	HC-5506				
Hydraulic Oil Filter.....	H-5504				
Oil Filter Full Flow.....	C-5510				

MODEL/APPLICATION	SAKURA NO	MODEL/APPLICATION	SAKURA NO	MODEL/APPLICATION	SAKURA NO
CATERPILLAR		CATERPILLAR		CATERPILLAR	
14E (MOTOR GRADERS) S/N: 99G1-UP Air Filter Primary..... A-5558 Air Filter Secondary..... A-5559 Air Filter Primary..... A-5543 Air Filter Set..... A-5544-S Air Filter Secondary..... A-5520 Fuel Filter..... F-5501 Oil Filter Full Flow..... O-5502		Fuel Filter..... FC-5523 Fuel Filter Secondary..... FC-5507 Fuel Filter..... FC-5501 Hydraulic Oil Filter..... H-5504 Hydraulic Oil Filter..... H-5506 Oil Filter Full Flow..... C-5510		160H (MOTOR GRADERS) CAT 3306 (S/N: 2FM1-UP) Air Filter Secondary..... A-5534 Air Filter Set..... A-5573-S Air Filter Primary..... A-5535 Fuel Filter Secondary..... FC-5507 Fuel Filter..... F-5505 Hydraulic Oil Filter..... H-5506 Hydraulic Oil Filter..... H-55270 Oil Filter Full Flow..... C-5510	
14G (MOTOR GRADERS) CAT 3306 Hydraulic Oil Filter Suction..... H-5516		14H (MOTOR GRADERS) S/N: 7WJ11-UP Air Filter Secondary..... A-5534 Air Filter Primary..... A-5535 Air Filter Set..... A-5573-S Fuel Filter Secondary..... FC-5507 Hydraulic Oil Filter..... H-5504 Hydraulic Oil Filter..... H-5506 Oil Filter Full Flow..... C-5510		160H (MOTOR GRADERS) CAT 3306 (S/N: 2HS1-UP) Air Filter Primary..... A-5535 Air Filter Secondary..... A-5534 Air Filter Set..... A-5573-S Fuel Filter Secondary..... FC-5507 Fuel Filter..... F-5505 Hydraulic Oil Filter..... H-55270 Hydraulic Oil Filter..... H-5506 Oil Filter Full Flow..... C-5510	
14G (MOTOR GRADERS) CAT 3306 (S/N: 96U1-UP) Air Filter Secondary..... A-5522 Fuel Filter..... F-5505 Fuel Filter Secondary..... FC-5507 Hydraulic Oil Filter..... H-5504 Oil Filter Full Flow..... C-5510		14H (MOTOR GRADERS) W/3176C Eng. Air Filter Set..... A-5573M-S Air Filter Primary..... A-5535M		160H (MOTOR GRADERS) CAT 3306 (S/N: 3GM1-UP) Air Filter Secondary..... A-5534 Air Filter Primary..... A-5535 Air Filter Set..... A-5573-S Fuel Filter Secondary..... FC-5507 Fuel Filter..... F-5505 Hydraulic Oil Filter..... H-55270 Hydraulic Oil Filter..... H-5506 Oil Filter Full Flow..... C-5510	
14H (MOTOR GRADERS) CAT 3176C ATAAC (S/N: 7WJ1-UP) Air Filter Secondary..... A-5534 Air Filter Primary..... A-5535 Air Filter Set..... A-5573-S Fuel Filter Secondary..... FC-5507 Fuel Filter..... F-5505 Hydraulic Oil Filter..... H-5504 Hydraulic Oil Filter..... H-5506 Hydraulic Oil Filter..... H-55270 Oil Filter Full Flow..... C-5510		14H (MOTOR GRADERS) W/3306 Eng. Air Filter Set..... A-5573M-S Air Filter Primary..... A-5535M		160H (MOTOR GRADERS) S/N: 6WM1-UP Air Filter Set..... A-5573-S Air Filter Secondary..... A-5534 Air Filter Primary..... A-5535 Fuel Filter Secondary..... FC-5507 Fuel Filter..... F-5505 Hydraulic Oil Filter..... H-55270 Hydraulic Oil Filter..... H-5504 Hydraulic Oil Filter..... H-5506 Oil Filter Full Flow..... C-5510	
14H (MOTOR GRADERS) CAT 3176C ATAAC VHP (S/N: 7WJ1-UP) Air Filter Primary..... A-5535 Air Filter Secondary..... A-5534 Air Filter Set..... A-5573-S Fuel Filter..... F-5505 Fuel Filter Secondary..... FC-5507 Hydraulic Oil Filter..... H-5504 Hydraulic Oil Filter..... H-5506 Hydraulic Oil Filter..... H-55270 Oil Filter Full Flow..... C-5510		14H NA (MOTOR GRADERS) w/3306 Eng. Air Filter Primary..... A-5535M Air Filter Set..... A-5573M-S		160H (MOTOR GRADERS) S/N: 9EJ1-UP Air Filter Set..... A-5573-S Air Filter Primary..... A-5535 Air Filter Secondary..... A-5534 Fuel Filter Secondary..... FC-5507 Fuel Filter..... F-5505 Hydraulic Oil Filter..... H-55270 Hydraulic Oil Filter..... H-5504 Hydraulic Oil Filter..... H-5506 Oil Filter Full Flow..... C-5510	
14H (MOTOR GRADERS) Air Filter Secondary..... A-5534 Air Filter Primary..... A-5535 Air Filter Set..... A-5573-S Cabin Air Filter..... CA-5501 Fuel Filter..... FC-5517 Fuel/Water Separator Secondary.. SFC-5504-10B Fuel/Water Separator Secondary.. SFC-5504-10 Hydraulic Oil Filter..... H-55270 Hydraulic Oil Filter..... H-5506		14M (MOTOR GRADERS) CAT C11 , 2013 Air Filter Set..... A-44330-S Air Filter Primary..... A-44330 Air Filter Secondary..... A-44340		160H (MOTOR GRADERS) S/N: 9JM1-UP Air Filter Secondary..... A-5534 Air Filter Primary..... A-5535 Air Filter Set..... A-5573-S Fuel Filter Secondary..... FC-5507	
14H (MOTOR GRADERS) S/N: 6MM1-UP Fuel Filter Secondary..... FC-5507		14M (MOTOR GRADERS) CAT C11 , 2007-UP Fuel Filter..... FC-5517		160H (MOTOR GRADERS) S/N: 9JM1-UP Air Filter Secondary..... A-5534 Air Filter Primary..... A-5535 Air Filter Set..... A-5573-S Fuel Filter Secondary..... FC-5507	
14H (MOTOR GRADERS) S/N: 7WJ1-10 Fuel Filter Secondary..... FC-5507		14M (MOTOR GRADERS) S/N: B9J1-UP Air Filter Secondary..... A-8103 Hydraulic Oil Filter..... HC-5504		160H (MOTOR GRADERS) S/N: 9JM1-UP Air Filter Secondary..... A-5534 Air Filter Primary..... A-5535 Air Filter Set..... A-5573-S Fuel Filter Secondary..... FC-5507	

MODEL/APPLICATION	SAKURA NO
CATERPILLAR	
160H <i>(MOTOR GRADERS)</i> S/N: 93M1-UP	
Fuel Filter.....	F-5505
Hydraulic Oil Filter.....	H-5504
Hydraulic Oil Filter.....	H-5506
Hydraulic Oil Filter.....	H-55270
Oil Filter Full Flow.....	C-5510
160H <i>(MOTOR GRADERS)</i> W/3176C ENG.	
Air Filter Set.....	A-5573M-S
Air Filter Primary.....	A-5535M
160H <i>(MOTOR GRADERS)</i> w/3306 Eng.	
Air Filter Primary.....	A-5535M
Air Filter Set.....	A-5573M-S
160H ES <i>(MOTOR GRADERS)</i>	
Air Filter Secondary.....	A-5534
Air Filter Primary.....	A-5535
Air Filter Set.....	A-5573-S
Cabin Air Filter.....	CA-5501
Fuel Filter.....	F-5505
Fuel Filter Secondary.....	FC-5507
Hydraulic Oil Filter.....	H-55270
Hydraulic Oil Filter.....	H-5504
Hydraulic Oil Filter.....	H-5506
Oil Filter Full Flow.....	C-5510
160H ES <i>(MOTOR GRADERS)</i> w/3306 Eng.	
Air Filter Primary.....	A-5535M
Air Filter Set.....	A-5573M-S
16 <i>(MOTOR GRADERS)</i> S/N: 49G1-UP	
Air Filter Set.....	A-5549M-S
Air Filter Primary.....	A-5549M
Air Filter Set.....	A-5522-S
Air Filter Secondary.....	A-5550
Air Filter Primary.....	A-5549
Air Filter Primary.....	A-5509
Air Filter Secondary.....	A-5510
Fuel Filter.....	F-5501
Hydraulic Oil Filter.....	H-5502
Hydraulic Oil Filter.....	H-5504
Oil Filter Full Flow.....	O-5503
Oil Filter Full Flow.....	O-5501
16 <i>(MOTOR GRADERS)</i> S/N: 93U1-3459	
Air Filter Secondary.....	A-5534
Air Filter Primary.....	A-5501
Air Filter Primary.....	A-5535
Air Filter Set.....	A-5573-S
Air Filter Secondary.....	A-5502
Fuel Filter.....	FC-5509
Fuel Filter.....	FC-5519
Hydraulic Oil Filter.....	H-5504
Oil Filter Full Flow.....	C-5516
160G <i>(MOTOR GRADERS)</i>	

MODEL/APPLICATION	SAKURA NO
CATERPILLAR	
Air Filter Secondary.....	A-5522
Air Filter Set.....	A-5522-S
Air Filter Primary.....	A-5509
Fuel Filter Secondary.....	FC-5507
Fuel Filter.....	F-5505
Fuel Filter.....	FC-5523
Fuel Filter.....	FC-5501
Hydraulic Oil Filter.....	H-5504
Hydraulic Oil Filter.....	H-55270
Oil Filter Full Flow.....	C-5510
160G <i>(MOTOR GRADERS)</i> S/N: 43D1-140	
Air Filter Secondary.....	A-5522
Air Filter Primary.....	A-5509
Air Filter Set.....	A-5522-S
Fuel Filter Secondary.....	FC-5507
Fuel Filter.....	F-5505
Hydraulic Oil Filter.....	H-55270
Hydraulic Oil Filter.....	H-5504
Oil Filter Full Flow.....	C-5510
160G <i>(MOTOR GRADERS)</i> S/N: 43D141-UP	
Air Filter Set.....	A-5522-S
Air Filter Secondary.....	A-5522
Air Filter Primary.....	A-5509
Fuel Filter.....	F-5505
Fuel Filter Secondary.....	FC-5507
Hydraulic Oil Filter.....	H-55270
Hydraulic Oil Filter.....	H-5504
Oil Filter Full Flow.....	C-5510
160M <i>(MOTOR GRADERS)</i> C9	
Cabin Air Filter.....	CA-55110
160M <i>(MOTOR GRADERS)</i> CAT S/N: B9L1-UP	
Fuel Filter.....	FC-5517
Hydraulic Oil Filter.....	HC-5504
160M <i>(MOTOR GRADERS)</i> CAT S/N: CZM1-UP	
Fuel Filter.....	FC-5517
Hydraulic Oil Filter.....	HC-5504
160M <i>(MOTOR GRADERS)</i> CAT S/N: THX1-UP	
Fuel Filter.....	FC-5517
Hydraulic Oil Filter.....	HC-5504
160H NA <i>(MOTOR GRADERS)</i> w/3306 Eng.	
Air Filter Primary.....	A-5535M
Air Filter Set.....	A-5573M-S
163H <i>(MOTOR GRADERS)</i> CAT 3176C ATAAC VHP	
Air Filter Set.....	A-5573-S
Air Filter Primary.....	A-5535
Air Filter Secondary.....	A-5534
Fuel Filter.....	F-5505
Fuel Filter Secondary.....	FC-5507
Hydraulic Oil Filter.....	H-55270

MODEL/APPLICATION	SAKURA NO
CATERPILLAR	
Hydraulic Oil Filter.....	HC-5504
Hydraulic Oil Filter.....	H-5506
Hydraulic Oil Filter.....	H-5504
Oil Filter Full Flow.....	C-5510
163H <i>(MOTOR GRADERS)</i> W/3176C ENG.	
Air Filter Set.....	A-5573M-S
Air Filter Primary.....	A-5535M
163H <i>(MOTOR GRADERS)</i> w/3306 Eng.	
Air Filter Primary.....	A-5535M
Air Filter Set.....	A-5573M-S
163H NA <i>(MOTOR GRADERS)</i> S/N: 5AK1-UP	
Air Filter Secondary.....	A-5534
Air Filter Primary.....	A-5535
Air Filter Set.....	A-5573-S
Fuel Filter.....	F-5505
Fuel Filter Secondary.....	FC-5507
Hydraulic Oil Filter.....	HC-5504
Hydraulic Oil Filter.....	H-5506
Hydraulic Oil Filter.....	H-5504
Hydraulic Oil Filter.....	H-55270
Oil Filter Full Flow.....	C-5510
16G <i>(MOTOR GRADERS)</i> S/N: 59M1-UP	
Air Filter Secondary.....	A-5502
16G <i>(MOTOR GRADERS)</i> S/N: 93U1869-2510	
Air Filter Primary.....	A-5501
Air Filter Secondary.....	A-5502
16G <i>(MOTOR GRADERS)</i> S/N: 93U1-UP	
Air Filter Secondary.....	A-5502
Air Filter Primary.....	A-5501
Fuel Filter.....	FC-5519
Hydraulic Oil Filter.....	H-5502
Hydraulic Oil Filter.....	H-5504
Oil Filter Full Flow.....	C-5516
16G <i>(MOTOR GRADERS)</i> S/N: 93U2511-2661	
Air Filter Primary.....	A-5501
Air Filter Secondary.....	A-5502
Hydraulic Oil Filter.....	H-55270
Hydraulic Oil Filter.....	H-5504
16G <i>(MOTOR GRADERS)</i> S/N: 93U2662-3459	
Air Filter Primary.....	A-5501
Air Filter Secondary.....	A-5502
Hydraulic Oil Filter.....	H-55270
Hydraulic Oil Filter.....	H-5504
16G <i>(MOTOR GRADERS)</i> S/N: 93U3460-UP	
Air Filter Secondary.....	A-5534
Air Filter Primary.....	A-5501
Air Filter Secondary.....	A-5502
Air Filter Primary.....	A-5535

MODEL/APPLICATION	SAKURA NO	MODEL/APPLICATION	SAKURA NO	MODEL/APPLICATION	SAKURA NO
CATERPILLAR		CATERPILLAR		CATERPILLAR	
16G (MOTOR GRADERS) S/N: 93U3460-UP		16M (MOTOR GRADERS) C13		Oil Filter Full Flow.....	C-6202
Air Filter Set.....	A-5573-S	Cabin Air Filter.....	CA-55110	206B (EXCAVATORS) PERKINS 4.236 (S/N: 9BF1-UP)	
Fuel Filter.....	FC-5509	16M (MOTOR GRADERS) CAT S/N: B9H1-UP		Air Filter Primary.....	AS-5523
Hydraulic Oil Filter.....	H-55270	Air Filter Secondary.....	A-8103	Air Filter Secondary.....	A-7913
Hydraulic Oil Filter.....	H-5504	Fuel Filter.....	FC-5510	Fuel Filter Secondary.....	FC-5507
Oil Filter Full Flow.....	C-5516	Fuel Filter.....	FC-5517	Fuel Filter.....	F-5505
16G (MOTOR GRADERS) w/3406 Eng.		Hydraulic Oil Filter.....	HC-5504	Oil Filter Full Flow.....	C-5505
Air Filter Set.....	A-5573M-S	16M (MOTOR GRADERS) CAT S/N: MHX1-UP		211 (EXCAVATORS) S/N: 4EC1-UP	
Air Filter Primary.....	A-5535M	Air Filter Secondary.....	A-8103	Air Filter Primary.....	AS-7805
16H (MOTOR GRADERS) W/3196 ENG.		Fuel Filter.....	FC-5510	Air Filter Secondary.....	A-7964
Air Filter Set.....	A-5573M-S	Fuel Filter.....	FC-5517	Air Filter Set.....	AS-5656-S
Air Filter Primary.....	A-5535M	Hydraulic Oil Filter.....	HC-5504	Fuel Filter.....	FC-5704
16H (MOTOR GRADERS) W/3406C ENG.		205 (EXCAVATORS) PERKINS 4.236 (S/N: 4DC1-UP)		Fuel Filter.....	FC-5103
Air Filter Primary.....	A-5535M	Fuel Filter.....	FC-5704	211 (EXCAVATORS) S/N: 5CC1-UP	
Air Filter Set.....	A-5573M-S	205 (EXCAVATORS) S/N: 3HC1-UP		Air Filter Secondary.....	A-7964
16HNA (MOTOR GRADERS)		Air Filter Secondary.....	A-7964	Air Filter Set.....	AS-5656-S
Air Filter Secondary.....	A-5534	Air Filter Set.....	AS-5656-S	Air Filter Primary.....	AS-7805
Air Filter Set.....	A-5573-S	Air Filter Primary.....	AS-7805	Fuel Filter.....	FC-5704
Air Filter Primary.....	A-5535	Fuel Filter.....	FC-5103	Fuel Filter.....	FC-5704
Cabin Air Filter.....	CA-5501	Fuel Filter.....	FC-5704	Fuel Filter.....	FC-5103
Fuel Filter.....	F-5505	Oil Filter Full Flow.....	C-6202	211 (EXCAVATORS) S/N: 5DC1-UP	
Fuel Filter.....	FC-5509	205 (EXCAVATORS) S/N: 4DC1-UP		Air Filter Secondary.....	A-7964
Hydraulic Oil Filter.....	H-5506	Air Filter Secondary.....	A-7964	Air Filter Set.....	AS-5656-S
Hydraulic Oil Filter.....	H-55270	Air Filter Primary.....	AS-7805	Air Filter Primary.....	AS-7805
Hydraulic Oil Filter.....	H-5504	Air Filter Set.....	AS-5656-S	Fuel Filter.....	FC-5103
16HNA (MOTOR GRADERS) S/N: 6ZJ1-UP		Fuel Filter.....	FC-5704	Fuel Filter.....	FC-5704
Air Filter Set.....	A-5573-S	Fuel Filter.....	FC-5103	212 (EXCAVATORS) PERKINS 4.236 (S/N: 5DC1-UP)	
Air Filter Primary.....	A-5535	Oil Filter Full Flow.....	C-6202	Fuel Filter.....	FC-5704
Air Filter Secondary.....	A-5534	205B (EXCAVATORS) CAT 3114 (S/N: 5ZF1-UP)		212 (EXCAVATORS) S/N: 3JC1-UP	
Fuel Filter.....	FC-5509	Fuel Filter Secondary.....	FC-5507	Air Filter Set.....	AS-5656-S
Fuel Filter.....	F-5505	Fuel Filter.....	F-5505	Air Filter Primary.....	AS-7805
Hydraulic Oil Filter.....	H-55270	Oil Filter Full Flow.....	C-5505	Air Filter Secondary.....	A-7964
Hydraulic Oil Filter.....	H-5506	206 (EXCAVATORS) PERKINS 4.236 (S/N: 3GC1-UP)		Fuel Filter.....	FC-5704
Hydraulic Oil Filter.....	H-5504	Fuel Filter.....	FC-5704	Fuel Filter.....	FC-5103
16HNA (MOTOR GRADERS) W/3406C ENG.		206 (EXCAVATORS) S/N: 2RC1-UP		Oil Filter Full Flow.....	C-6202
Air Filter Primary.....	A-5535M	Air Filter Secondary.....	A-7964	212 (EXCAVATORS) S/N: 5DC1-UP	
Air Filter Set.....	A-5573M-S	Air Filter Set.....	AS-5656-S	Air Filter Set.....	AS-5656-S
16M (MOTOR GRADERS) CAT S/N: B9H1-UP , 2007-UP		Air Filter Primary.....	AS-7805	Air Filter Primary.....	AS-7805
Air Filter Secondary.....	A-8103	Fuel Filter.....	FC-5103	Air Filter Secondary.....	A-7964
Fuel Filter.....	FC-5517	Fuel Filter.....	FC-5704	Fuel Filter.....	FC-5103
Fuel Filter.....	FC-5510	Oil Filter Full Flow.....	C-6202	Fuel Filter.....	FC-5704
Hydraulic Oil Filter.....	HC-5504	206 (EXCAVATORS) S/N: 3GC1-UP		Oil Filter Full Flow.....	C-6202
16M (MOTOR GRADERS) CAT S/N: MHX1-UP , 2007-UP		Air Filter Primary.....	AS-7805	213 (EXCAVATORS) S/N: 3ZC1-UP	
Air Filter Secondary.....	A-8103	Air Filter Secondary.....	A-7964	Air Filter Secondary.....	A-7913
Fuel Filter.....	FC-5510	Air Filter Set.....	AS-5656-S	Fuel Filter.....	FC-5704
Fuel Filter.....	FC-5517	Fuel Filter.....	FC-5704	Fuel Filter.....	FC-5103
Hydraulic Oil Filter.....	HC-5504	Fuel Filter.....	FC-5103	Oil Filter Full Flow.....	C-5102
16M (MOTOR GRADERS) S/N: 93U3460-UP		206 (EXCAVATORS) S/N: 3GC1-UP		Oil Filter Full Flow.....	C-6204
Air Filter Set.....	A-5573-S	Air Filter Primary.....	AS-7805	213 (EXCAVATORS) S/N: 9XB1-UP	
Air Filter Primary.....	A-5535	Air Filter Secondary.....	A-7964	213 (EXCAVATORS) S/N: 9XB1-UP	
Air Filter Secondary.....	A-5534	Air Filter Set.....	AS-5656-S		
Fuel Filter.....	FC-5509	Fuel Filter.....	FC-5704		
Fuel Filter.....	F-5505	Fuel Filter.....	FC-5103		
Hydraulic Oil Filter.....	H-55270				
Hydraulic Oil Filter.....	H-5506				
Hydraulic Oil Filter.....	H-5504				

MODEL/APPLICATION	SAKURA NO	MODEL/APPLICATION	SAKURA NO	MODEL/APPLICATION	SAKURA NO
CATERPILLAR		CATERPILLAR		CATERPILLAR	
215B SA (EXCAVATORS) CAT 3204 (S/N: 4FC1-UP) Air Filter Set..... A-5522-S Air Filter Secondary..... A-5510 Air Filter Primary..... A-5509 Fuel Filter Secondary..... FC-5507 Fuel Filter..... F-5505 Hydraulic Oil Filter..... H-5502 Hydraulic Oil Filter..... H-5503 Hydraulic Oil Filter..... HC-5511 Oil Filter Full Flow..... C-5510		Oil Filter Full Flow..... C-5510 216 (LOADERS) S/N: 4NZ1-UP Air Filter Primary..... A-8505 Air Filter Secondary..... A-8599 Hydraulic Oil Filter..... HC-5504 216 (LOADERS) S/N: 5FZ1-UP Air Filter Primary..... A-8505 Air Filter Secondary..... A-8599 Hydraulic Oil Filter..... HC-5504 216 (LOADERS) S/N: 6BZ1-699 Air Filter Primary..... A-8505 Air Filter Secondary..... A-8599 Hydraulic Oil Filter..... HC-5504 216B (LOADERS) CAT 3024C (S/N: RLL1-UP) , 2004-UP Air Filter Primary..... A-7003 Air Filter Secondary..... A-7004 Hydraulic Oil Filter..... HC-5504 Oil Filter Full Flow..... C-1123 216B (LOADERS) CAT 3034 (S/N: RLL1-UP) , 2004-UP Air Filter Primary..... A-7003 Air Filter Secondary..... A-7004 Hydraulic Oil Filter..... HC-5504 Oil Filter Full Flow..... C-1123 219 (EXCAVATORS) CAT 3304 Hydraulic Oil Filter..... HC-55112 219 (EXCAVATORS) CAT 3304 (S/N: 4HG1-UP) Air Filter Secondary..... A-5510 Air Filter Primary..... A-5509 Air Filter Set..... A-5522-S Fuel Filter Secondary..... FC-5507 Fuel Filter..... F-5505 Hydraulic Oil Filter..... HC-5511 Hydraulic Oil Filter..... H-5502 Hydraulic Oil Filter..... H-5503 Oil Filter Full Flow..... C-5510 219 (EXCAVATORS) CAT 3304 (S/N: 5CF1-UP) Air Filter Set..... A-5522-S Air Filter Primary..... A-5509 Air Filter Secondary..... A-5510 Fuel Filter Secondary..... FC-5507 Fuel Filter..... F-5505 Hydraulic Oil Filter..... HC-5511 Hydraulic Oil Filter..... H-5502 Hydraulic Oil Filter..... H-5503 Oil Filter Full Flow..... C-5510 219D (EXCAVATORS) CAT 3304 Hydraulic Oil Filter..... HC-55112		219D (EXCAVATORS) CAT 3304 (S/N: 5XG00982-UP) Air Filter Primary..... A-5509 Air Filter Set..... A-5522-S Air Filter Secondary..... A-5510 Fuel Filter Secondary..... FC-5507 Hydraulic Oil Filter..... H-5502 Hydraulic Oil Filter..... HC-5511 Hydraulic Oil Filter..... H-5503 Oil Filter Full Flow..... C-5510 219D (EXCAVATORS) CAT 3304 (S/N: 5XG1-UP) Air Filter Primary..... A-5509 Air Filter Set..... A-5522-S Air Filter Secondary..... A-5510 Fuel Filter Secondary..... FC-5507 Hydraulic Oil Filter..... H-5502 Hydraulic Oil Filter..... HC-5511 Hydraulic Oil Filter..... H-5503 Oil Filter Full Flow..... C-5510 224 (EXCAVATORS) S/N: 2JC1-UP Air Filter Secondary..... A-6009 Air Filter Primary..... A-9226 Fuel Filter..... FC-5704 Oil Filter Full Flow..... C-7911 224 (EXCAVATORS) S/N: 5TC1-UP Air Filter Secondary..... A-7913 Fuel Filter..... FC-5103 224B (EXCAVATORS) CAT 3116 (S/N: 7WF1-UP) Air Filter Primary..... AS-5523 Fuel Filter..... F-5505 Fuel Filter Secondary..... FC-5507 Oil Filter Full Flow..... C-5510 225 (EXCAVATORS) S/N: 20S1-UP Air Filter Primary..... A-5549M Air Filter Primary..... A-5509 Air Filter Secondary..... A-5510 Air Filter Primary..... A-5549 Air Filter Secondary..... A-5550 Air Filter Set..... A-5522-S Air Filter Set..... A-5549M-S Fuel Filter Secondary..... FC-5507 Hydraulic Oil Filter..... H-5502 Oil Filter Full Flow..... C-5504 Oil Filter Full Flow..... C-5510 225 (EXCAVATORS) S/N: 51U1-589 Air Filter Primary..... A-5549M Air Filter Secondary..... A-5550 Air Filter Primary..... A-5509 Air Filter Set..... A-5549M-S Air Filter Primary..... A-5549 Air Filter Secondary..... A-5510 Air Filter Set..... A-5522-S	
215C (EXCAVATORS) CAT 3304 Hydraulic Oil Filter..... HC-55112 215C (EXCAVATORS) CAT 3304 (S/N: 4HG1-UP) Air Filter Primary..... A-5509 Air Filter Set..... A-5522-S Air Filter Secondary..... A-5510 Fuel Filter Secondary..... FC-5507 Fuel Filter..... F-5505 Hydraulic Oil Filter..... H-5503 Hydraulic Oil Filter..... HC-5511 Hydraulic Oil Filter..... H-5502 Oil Filter Full Flow..... C-5510 215C (EXCAVATORS) CAT 3304 (S/N: 5CF1-UP) Air Filter Set..... A-5522-S Air Filter Secondary..... A-5510 Air Filter Primary..... A-5509 Fuel Filter Secondary..... FC-5507 Fuel Filter..... F-5505 Hydraulic Oil Filter..... H-5502 Hydraulic Oil Filter..... HC-5511 Hydraulic Oil Filter..... H-5503 Oil Filter Full Flow..... C-5510 215C (EXCAVATORS) S/N: 44G1-UP Air Filter Primary..... A-5509 Air Filter Secondary..... A-5510 Air Filter Set..... A-5522-S Fuel Filter..... FC-5501 Fuel Filter..... FC-5523 Hydraulic Oil Filter..... H-5503 Oil Filter Full Flow..... C-5510 215D (EXCAVATORS) CAT 3304 Hydraulic Oil Filter..... HC-55112 215D (EXCAVATORS) CAT 3304 (S/N: 9TF1-UP) Air Filter Primary..... A-5509 Air Filter Secondary..... A-5510 Air Filter Set..... A-5522-S Fuel Filter..... F-5505 Fuel Filter Secondary..... FC-5507 Hydraulic Oil Filter..... H-5502 Hydraulic Oil Filter..... H-5503 Hydraulic Oil Filter..... HC-5511		219D (EXCAVATORS) CAT 3304 Hydraulic Oil Filter..... HC-55112			

MODEL/APPLICATION	SAKURA NO
CATERPILLAR	
225 (EXCAVATORS) S/N: 51U1-589	
Fuel Filter.....	FC-5503
Hydraulic Oil Filter.....	H-5504
Hydraulic Oil Filter.....	H-5509
Hydraulic Oil Filter.....	H-5502
Oil Filter Full Flow.....	C-5504
225 (EXCAVATORS) S/N: 51U2832-UP	
Air Filter Set.....	A-5549M-S
Air Filter Set.....	A-5522-S
Air Filter Primary.....	A-5549
Air Filter Secondary.....	A-5550
Air Filter Primary.....	A-5509
Air Filter Primary.....	A-5549M
Air Filter Secondary.....	A-5510
Fuel Filter Secondary.....	FC-5507
Hydraulic Oil Filter.....	H-5502
Hydraulic Oil Filter.....	H-5504
Hydraulic Oil Filter.....	H-5509
Oil Filter Full Flow.....	C-5519
225 (EXCAVATORS) S/N: 51U590-2831	
Air Filter Primary.....	A-5549M
Air Filter Set.....	A-5549M-S
Air Filter Set.....	A-5522-S
Air Filter Primary.....	A-5509
Air Filter Primary.....	A-5549
Air Filter Secondary.....	A-5550
Air Filter Secondary.....	A-5510
Fuel Filter Secondary.....	FC-5507
Hydraulic Oil Filter.....	H-5502
Hydraulic Oil Filter.....	H-5504
Hydraulic Oil Filter.....	H-5509
Oil Filter Full Flow.....	C-5504
225 (EXCAVATORS) S/N: 61X1-UP	
Air Filter Secondary.....	A-5510
Air Filter Secondary.....	A-5550
Air Filter Primary.....	A-5509
Air Filter Set.....	A-5522-S
Air Filter Primary.....	A-5549M
Air Filter Set.....	A-5549M-S
Air Filter Primary.....	A-5549
Fuel Filter Secondary.....	FC-5507
Hydraulic Oil Filter.....	H-5502
Oil Filter Full Flow.....	C-5510
225 (EXCAVATORS) S/N: 76U1-UP	
Air Filter Secondary.....	A-5550
Air Filter Secondary.....	A-5510
Air Filter Set.....	A-5522-S
Air Filter Set.....	A-5549M-S
Air Filter Primary.....	A-5549
Air Filter Primary.....	A-5549M
Air Filter Primary.....	A-5509
Fuel Filter Secondary.....	FC-5507
Hydraulic Oil Filter.....	H-5509
Oil Filter Full Flow.....	C-5510

MODEL/APPLICATION	SAKURA NO
CATERPILLAR	
225D (EXCAVATORS) CAT 3304 (S/N: 25J1-UP)	
Air Filter Set.....	A-5544-S
Air Filter Primary.....	A-5543
Air Filter Secondary.....	A-5520
Fuel Filter Secondary.....	FC-5507
Hydraulic Oil Filter.....	H-5502
Hydraulic Oil Filter.....	H-5504
Hydraulic Oil Filter.....	H-5509
Hydraulic Oil Filter.....	H-5503
Oil Filter Full Flow.....	C-5519
225B (EXCAVATORS) CAT 3304 (S/N: 22D1-UP)	
Fuel Filter Secondary.....	FC-5507
Hydraulic Oil Filter.....	H-5504
Hydraulic Oil Filter.....	H-5502
Hydraulic Oil Filter.....	H-5509
Oil Filter Full Flow.....	C-5519
225B (EXCAVATORS) CAT 3304 (S/N: 22D-UP)	
Air Filter Set.....	A-5522-S
Air Filter Primary.....	A-5509
Air Filter Secondary.....	A-5510
Fuel Filter.....	F-5505
Fuel Filter Secondary.....	FC-5507
Hydraulic Oil Filter.....	H-5502
Hydraulic Oil Filter.....	H-5509
Hydraulic Oil Filter.....	H-5503
Hydraulic Oil Filter.....	H-5504
Oil Filter Full Flow.....	C-5510
225B (EXCAVATORS) CAT 3304 (S/N: 3YD1-UP)	
Air Filter Set.....	A-5522-S
Air Filter Primary.....	A-5509
Air Filter Secondary.....	A-5510
Fuel Filter.....	F-5505
Fuel Filter Secondary.....	FC-5507
Hydraulic Oil Filter.....	H-5504
Hydraulic Oil Filter.....	H-5502
Hydraulic Oil Filter.....	H-5509
Hydraulic Oil Filter.....	H-5503
Hydraulic Oil Filter.....	H-5504
Oil Filter Full Flow.....	C-5510
225B (EXCAVATORS) CAT 3304 (S/N: 3YD-UP)	
Air Filter Set.....	A-5522-S
Air Filter Primary.....	A-5509
Air Filter Secondary.....	A-5510
Fuel Filter.....	F-5505
Fuel Filter Secondary.....	FC-5507
Hydraulic Oil Filter.....	H-5504
Hydraulic Oil Filter.....	H-5502
Hydraulic Oil Filter.....	H-5509
Hydraulic Oil Filter.....	H-5503
Hydraulic Oil Filter.....	H-5504
Oil Filter Full Flow.....	C-5510
225B (EXCAVATORS) CAT 3304 (S/N: 3YD-UP)	
Air Filter Set.....	A-5522-S
Air Filter Primary.....	A-5509
Air Filter Secondary.....	A-5510
Fuel Filter.....	F-5505
Fuel Filter Secondary.....	FC-5507
Hydraulic Oil Filter.....	H-5504
Hydraulic Oil Filter.....	H-5503
Hydraulic Oil Filter.....	H-5509
Hydraulic Oil Filter.....	H-5502
Oil Filter Full Flow.....	C-5510
225B (EXCAVATORS) S/N: 1AG1-UP	
Air Filter Set.....	A-5522-S
Air Filter Primary.....	A-5509

MODEL/APPLICATION	SAKURA NO
CATERPILLAR	
Fuel Filter.....	F-5505
Fuel Filter Secondary.....	FC-5507
Hydraulic Oil Filter.....	H-5526
Hydraulic Oil Filter.....	H-5504
Hydraulic Oil Filter.....	H-55280
Hydraulic Oil Filter.....	H-5502
Hydraulic Oil Filter.....	H-5509
Hydraulic Oil Filter.....	H-5503
Hydraulic Oil Filter.....	H-55270
Oil Filter Full Flow.....	C-5510
225B LC (EXCAVATORS) CAT 3208 (S/N: 1GF1-UP)	
Air Filter Set.....	A-5522-S
Air Filter Primary.....	A-5509
Air Filter Secondary.....	A-5510
Fuel Filter Secondary.....	FC-5507
Hydraulic Oil Filter.....	H-5509
Hydraulic Oil Filter.....	H-5502
Hydraulic Oil Filter.....	H-5504
Oil Filter Full Flow.....	C-5519
225B LC (EXCAVATORS) CAT 3208 (S/N: 2ZD1-UP)	
Air Filter Primary.....	A-5509
Air Filter Secondary.....	A-5510
Air Filter Set.....	A-5522-S
Fuel Filter Secondary.....	FC-5507
Hydraulic Oil Filter.....	H-5509
Hydraulic Oil Filter.....	H-5504
Hydraulic Oil Filter.....	H-5502
Oil Filter Full Flow.....	C-5519
225D LC (EXCAVATORS) CAT 3208 (S/N: 6RG1-UP)	
Air Filter Primary.....	A-5509
Air Filter Set.....	A-5522-S
Air Filter Secondary.....	A-5520
Fuel Filter Secondary.....	FC-5507
Fuel Filter.....	F-5505
Hydraulic Oil Filter.....	H-5504
Hydraulic Oil Filter.....	H-5503
Hydraulic Oil Filter.....	H-5502
Hydraulic Oil Filter.....	H-5509
Oil Filter Full Flow.....	C-5510
226 (LOADERS) S/N: 5FZ6700-UP	
Air Filter Secondary.....	A-8599
Air Filter Primary.....	A-8505
Hydraulic Oil Filter.....	HC-5504
226 (LOADERS) S/N: 6BZ1-699	
Air Filter Primary.....	A-8505
Air Filter Secondary.....	A-8599
Hydraulic Oil Filter.....	HC-5504
226B (LOADERS) CAT 3024C (S/N: MJH1-UP) , 2004-UP	
Air Filter Secondary.....	A-7004
Air Filter Primary.....	A-7003
Hydraulic Oil Filter.....	HC-5504
Oil Filter Full Flow.....	C-1123

MODEL/APPLICATION	SAKURA NO
CATERPILLAR	
226B (LOADERS) CAT 3034 (S/N: MJH1-UP) , 2004-UP	
Air Filter Primary.....	A-7003
Air Filter Secondary.....	A-7004
Hydraulic Oil Filter.....	HC-5504
Oil Filter Full Flow.....	C-1123
227 (EXCAVATORS) S/N: 10W1-UP	
Air Filter Secondary.....	A-5550
Air Filter Set.....	A-5522-S
Air Filter Primary.....	A-5509
Air Filter Secondary.....	A-5510
Air Filter Set.....	A-5549M-S
Air Filter Primary.....	A-5549
Fuel Filter Secondary.....	FC-5507
Hydraulic Oil Filter.....	H-5509
Oil Filter Full Flow.....	C-5519
229 (EXCAVATORS) CAT 3304 (S/N: 1AG1-UP)	
Air Filter Secondary.....	A-5520
Air Filter Set.....	A-5522-S
Air Filter Primary.....	A-5509
Fuel Filter Secondary.....	FC-5507
Fuel Filter.....	F-5505
Hydraulic Oil Filter.....	H-5503
Hydraulic Oil Filter.....	H-5504
Hydraulic Oil Filter.....	H-5509
Hydraulic Oil Filter.....	H-5502
Oil Filter Full Flow.....	C-5510
229 (EXCAVATORS) CAT 3304 (S/N: 1GF1-UP)	
Air Filter Primary.....	A-5549
Air Filter Primary.....	A-5549M
Air Filter Primary.....	A-5509
Air Filter Secondary.....	A-5550
Air Filter Set.....	A-5549M-S
Air Filter Set.....	A-5522-S
Air Filter Secondary.....	A-5510
Fuel Filter Secondary.....	FC-5507
Hydraulic Oil Filter.....	H-5502
Hydraulic Oil Filter.....	H-5509
Hydraulic Oil Filter.....	H-5504
Oil Filter Full Flow.....	C-5519
229 (EXCAVATORS) CAT 3304 (S/N: 2ZD1-UP)	
Air Filter Set.....	A-5522-S
Air Filter Primary.....	A-5509
Air Filter Primary.....	A-5549
Air Filter Primary.....	A-5549M
Air Filter Secondary.....	A-5550
Air Filter Set.....	A-5549M-S
Air Filter Secondary.....	A-5510
Fuel Filter Secondary.....	FC-5507
Hydraulic Oil Filter.....	H-5509
Hydraulic Oil Filter.....	H-5502
Hydraulic Oil Filter.....	H-5504
Oil Filter Full Flow.....	C-5519

MODEL/APPLICATION	SAKURA NO
CATERPILLAR	
229 (EXCAVATORS) CAT 3304 (S/N: 3YD1-UP)	
Air Filter Secondary.....	A-5520
Air Filter Set.....	A-5522-S
Air Filter Primary.....	A-5509
Fuel Filter.....	F-5505
Fuel Filter Secondary.....	FC-5507
Hydraulic Oil Filter.....	H-5503
Hydraulic Oil Filter.....	H-5502
Hydraulic Oil Filter.....	H-5509
Hydraulic Oil Filter.....	H-5504
Oil Filter Full Flow.....	C-5510
229D (EXCAVATORS) CAT 3304 (S/N: 2LJ1-UP)	
Air Filter Primary.....	A-5509
Air Filter Secondary.....	A-5510
Air Filter Set.....	A-5522-S
Fuel Filter.....	F-5505
Fuel Filter Secondary.....	FC-5507
Hydraulic Oil Filter.....	H-5504
Hydraulic Oil Filter.....	H-5503
Hydraulic Oil Filter.....	H-5509
Hydraulic Oil Filter.....	H-5502
Oil Filter Full Flow.....	C-5510
231D (EXCAVATORS) CAT 3208 (S/N: 1NK1-UP)	
Air Filter Secondary.....	A-5520
Air Filter Primary.....	A-5543
Air Filter Set.....	A-5544-S
Fuel Filter Secondary.....	FC-5507
Hydraulic Oil Filter.....	H-5504
Hydraulic Oil Filter.....	H-5503
Hydraulic Oil Filter.....	H-5502
Hydraulic Oil Filter.....	H-5509
Oil Filter Full Flow.....	C-5505
231D (EXCAVATORS) CAT 3208 (S/N: 5JW1-UP)	
Air Filter Secondary.....	A-5520
Air Filter Primary.....	A-5543
Air Filter Set.....	A-5544-S
Fuel Filter Secondary.....	FC-5507
Hydraulic Oil Filter.....	H-5504
Hydraulic Oil Filter.....	H-5502
Hydraulic Oil Filter.....	H-5509
Oil Filter Full Flow.....	C-5519
231D (EXCAVATORS) CAT 3208 (S/N: 5WJ1-UP)	
Air Filter Secondary.....	A-5520
Air Filter Primary.....	A-5543
Air Filter Set.....	A-5544-S
Fuel Filter Secondary.....	FC-5507
Hydraulic Oil Filter.....	H-5503
Hydraulic Oil Filter.....	H-5504
Hydraulic Oil Filter.....	H-5502
Hydraulic Oil Filter.....	H-5509
Oil Filter Full Flow.....	C-5505
231D LC (EXCAVATORS) CAT 3208 (S/N: 5WJ1-UP)	

MODEL/APPLICATION	SAKURA NO
CATERPILLAR	
Air Filter Set.....	A-5544-S
Air Filter Primary.....	A-5543
Air Filter Secondary.....	A-5520
Fuel Filter Secondary.....	FC-5507
Hydraulic Oil Filter.....	H-5509
Hydraulic Oil Filter.....	H-5504
Hydraulic Oil Filter.....	H-5502
Oil Filter Full Flow.....	C-5505
232 (LOADERS) CAT 3024C (S/N: CAB1-UP)	
Air Filter Primary.....	A-8505
Air Filter Secondary.....	A-8599
Hydraulic Oil Filter.....	HC-5504
232 (LOADERS) CAT 3034 (S/N: CAB1-UP)	
Air Filter Primary.....	A-8505
Air Filter Secondary.....	A-8599
Hydraulic Oil Filter.....	HC-5504
232B (LOADERS) CAT 3024C (S/N: SCH1-UP) , 2004-UP	
Air Filter Secondary.....	A-7004
Air Filter Primary.....	A-7003
Hydraulic Oil Filter.....	HC-5504
Oil Filter Full Flow.....	C-1123
232B (LOADERS) CAT 3034 (S/N: SCH1-UP) , 2004-UP	
Air Filter Primary.....	A-7003
Air Filter Secondary.....	A-7004
Hydraulic Oil Filter.....	HC-5504
Oil Filter Full Flow.....	C-1123
235 (EXCAVATORS) S/N: 32K1-788	
Air Filter Primary.....	A-5558
Air Filter Secondary.....	A-5520
Air Filter Secondary.....	A-5559
Air Filter Primary.....	A-5543
Air Filter Set.....	A-5544-S
Fuel Filter Secondary.....	FC-5507
Hydraulic Oil Filter.....	H-5504
Hydraulic Oil Filter.....	H-5502
Hydraulic Oil Filter.....	H-5509
Oil Filter Full Flow.....	C-5510
235 (EXCAVATORS) S/N: 32K789-UP	
Air Filter Set.....	A-5544-S
Air Filter Primary.....	A-5558
Air Filter Secondary.....	A-5520
Air Filter Secondary.....	A-5559
Air Filter Primary.....	A-5543
Fuel Filter Secondary.....	FC-5507
Hydraulic Oil Filter.....	H-5502
Hydraulic Oil Filter.....	H-5509
Oil Filter Full Flow.....	C-5510
235 (EXCAVATORS) S/N: 62X1-UP	
Air Filter Secondary.....	A-5520
Air Filter Secondary.....	A-5559
Air Filter Primary.....	A-5558

MODEL/APPLICATION	SAKURA NO
CATERPILLAR	
235 (EXCAVATORS) S/N: 62X1-UP	
Air Filter Set.....	A-5544-S
Air Filter Primary.....	A-5543
Fuel Filter Secondary.....	FC-5507
Hydraulic Oil Filter.....	H-5509
Hydraulic Oil Filter.....	H-5502
Hydraulic Oil Filter.....	H-5504
Oil Filter Full Flow.....	C-5510
235 (EXCAVATORS) S/N: 64X1-UP	
Air Filter Secondary.....	A-5559
Air Filter Set.....	A-5544-S
Air Filter Secondary.....	A-5520
Air Filter Primary.....	A-5543
Air Filter Primary.....	A-5558
Fuel Filter Secondary.....	FC-5507
Hydraulic Oil Filter.....	H-5509
Hydraulic Oil Filter.....	H-5504
Hydraulic Oil Filter.....	H-5502
Oil Filter Full Flow.....	C-5510
235 (EXCAVATORS) S/N: 7WC1-UP	
Air Filter Primary.....	A-5558
Air Filter Set.....	A-5544-S
Air Filter Primary.....	A-5543
Air Filter Secondary.....	A-5559
Air Filter Secondary.....	A-5520
Fuel Filter Secondary.....	FC-5507
Hydraulic Oil Filter.....	H-5502
Hydraulic Oil Filter.....	H-5509
Oil Filter Full Flow.....	C-5510
235 (EXCAVATORS) S/N: 81X1-UP	
Air Filter Set.....	A-5544-S
Air Filter Primary.....	A-5543
Air Filter Secondary.....	A-5559
Air Filter Primary.....	A-5558
Air Filter Secondary.....	A-5520
Fuel Filter Secondary.....	FC-5507
Hydraulic Oil Filter.....	H-5502
Hydraulic Oil Filter.....	H-5504
Hydraulic Oil Filter.....	H-5509
Oil Filter Full Flow.....	C-5510
235 (EXCAVATORS) S/N: 83X1-UP	
Air Filter Primary.....	A-5558
Air Filter Secondary.....	A-5520
Air Filter Set.....	A-5544-S
Air Filter Secondary.....	A-5559
Air Filter Primary.....	A-5543
Fuel Filter Secondary.....	FC-5507
Hydraulic Oil Filter.....	H-5504
Hydraulic Oil Filter.....	H-5502
Hydraulic Oil Filter.....	H-5509
Oil Filter Full Flow.....	C-5510
235 (EXCAVATORS) S/N: 9PC1-UP	
Air Filter Secondary.....	A-5559

MODEL/APPLICATION	SAKURA NO
CATERPILLAR	
Air Filter Primary.....	A-5543
Air Filter Primary.....	A-5558
Air Filter Set.....	A-5544-S
Air Filter Secondary.....	A-5520
Fuel Filter Secondary.....	FC-5507
Hydraulic Oil Filter.....	H-5509
Hydraulic Oil Filter.....	H-5502
Oil Filter Full Flow.....	C-5510
235C (EXCAVATORS) CAT 3306 (S/N: 2PG1-UP)	
Air Filter Set.....	A-5544-S
Air Filter Secondary.....	A-5520
Air Filter Primary.....	A-5543
Fuel Filter Secondary.....	FC-5507
Fuel Filter.....	F-5505
Hydraulic Oil Filter.....	H-5503
Hydraulic Oil Filter.....	H-5509
Hydraulic Oil Filter.....	H-5504
Hydraulic Oil Filter.....	H-5502
Oil Filter Full Flow.....	C-5510
235C (EXCAVATORS) CAT 3306 (S/N: 3WG1-UP)	
Air Filter Set.....	A-5544-S
Air Filter Primary.....	A-5543
Air Filter Secondary.....	A-5520
Fuel Filter.....	F-5505
Fuel Filter Secondary.....	FC-5507
Hydraulic Oil Filter.....	H-5502
Hydraulic Oil Filter.....	H-5509
Hydraulic Oil Filter.....	H-5503
Hydraulic Oil Filter.....	H-5504
Oil Filter Full Flow.....	C-5510
235C (EXCAVATORS) CAT 3306 (S/N: 4DG1-UP)	
Air Filter Primary.....	A-5543
Air Filter Secondary.....	A-5520
Air Filter Set.....	A-5544-S
Fuel Filter.....	F-5505
Fuel Filter Secondary.....	FC-5507
Hydraulic Oil Filter.....	H-5502
Hydraulic Oil Filter.....	H-5509
Hydraulic Oil Filter.....	H-5504
Hydraulic Oil Filter.....	H-5503
Oil Filter Full Flow.....	C-5510
235C (EXCAVATORS) CAT 3306 (S/N: 5AF1-UP)	
Air Filter Primary.....	A-5549
Air Filter Secondary.....	A-5550
Air Filter Primary.....	A-5549M
Air Filter Secondary.....	A-5520
Air Filter Primary.....	A-5543
Air Filter Primary.....	A-5558
Air Filter Secondary.....	A-5559
Air Filter Set.....	A-5549M-S
Air Filter Set.....	A-5544-S
Fuel Filter Secondary.....	FC-5507
Fuel Filter.....	F-5505
Hydraulic Oil Filter.....	H-5502
Hydraulic Oil Filter.....	H-5509

MODEL/APPLICATION	SAKURA NO
CATERPILLAR	
Hydraulic Oil Filter.....	H-5504
Oil Filter Full Flow.....	C-5510
235D (EXCAVATORS) CAT 3306 (S/N: 8KJ1-UP)	
Air Filter Primary.....	A-5543
Air Filter Set.....	A-5544-S
Air Filter Secondary.....	A-5520
Fuel Filter.....	F-5505
Fuel Filter Secondary.....	FC-5507
Hydraulic Oil Filter.....	H-5503
Hydraulic Oil Filter.....	H-5504
Hydraulic Oil Filter.....	H-5502
Hydraulic Oil Filter.....	H-5509
Oil Filter Full Flow.....	C-5510
235D (EXCAVATORS) CAT 3306 (S/N: 8TJ1-UP)	
Air Filter Primary.....	A-5543
Air Filter Set.....	A-5544-S
Air Filter Secondary.....	A-5520
Fuel Filter.....	F-5505
Fuel Filter Secondary.....	FC-5507
Hydraulic Oil Filter.....	H-5504
Hydraulic Oil Filter.....	H-5503
Hydraulic Oil Filter.....	H-5509
Hydraulic Oil Filter.....	H-5502
Oil Filter Full Flow.....	C-5510
235B (EXCAVATORS) CAT 3306 (S/N: 1FD1-UP)	
Air Filter Set.....	A-5544-S
Air Filter Secondary.....	A-5520
Air Filter Primary.....	A-5543
Fuel Filter.....	F-5505
Fuel Filter Secondary.....	FC-5507
Hydraulic Oil Filter.....	H-5503
Hydraulic Oil Filter.....	H-5504
Hydraulic Oil Filter.....	H-5502
Hydraulic Oil Filter.....	H-5509
Oil Filter Full Flow.....	C-5510
235B (EXCAVATORS) CAT 3306 (S/N: 4ED1-UP)	
Air Filter Set.....	A-5544-S
Air Filter Primary.....	A-5543
Air Filter Secondary.....	A-5520
Fuel Filter.....	F-5505
Fuel Filter Secondary.....	FC-5507
Hydraulic Oil Filter.....	H-5502
Hydraulic Oil Filter.....	H-5504
Hydraulic Oil Filter.....	H-5503
Hydraulic Oil Filter.....	H-5509
Oil Filter Full Flow.....	C-5510
235B (EXCAVATORS) CAT 3306 (S/N: 7WC1-UP)	
Air Filter Set.....	A-5544-S
Air Filter Secondary.....	A-5520
Air Filter Primary.....	A-5543
Fuel Filter.....	F-5505
Fuel Filter Secondary.....	FC-5507
Hydraulic Oil Filter.....	H-5502
Hydraulic Oil Filter.....	H-5509
Hydraulic Oil Filter.....	H-5504

MODEL/APPLICATION	SAKURA NO
CATERPILLAR	
235B (EXCAVATORS) CAT 3306 (S/N: 7WC1-UP)	
Hydraulic Oil Filter.....	H-5502
Hydraulic Oil Filter.....	H-5503
Oil Filter Full Flow.....	C-5510
235B (EXCAVATORS) CAT 3306 (S/N: 9PC1-UP)	
Air Filter Secondary.....	A-5520
Air Filter Primary.....	A-5543
Air Filter Set.....	A-5544-S
Fuel Filter.....	F-5505
Fuel Filter Secondary.....	FC-5507
Hydraulic Oil Filter.....	H-5503
Hydraulic Oil Filter.....	H-5504
Hydraulic Oil Filter.....	H-5509
Hydraulic Oil Filter.....	H-5502
Oil Filter Full Flow.....	C-5510
236 (LOADERS) S/N: 4YZ1-3999	
Air Filter Primary.....	A-8505
Air Filter Secondary.....	A-8599
Air Filter Primary.....	A-5541
Air Filter Secondary.....	A-5540
Air Filter Primary.....	A-5541M
Air Filter Primary.....	A-76231
Air Filter Set.....	A-5541M-S
Hydraulic Oil Filter.....	HC-5504
236 (LOADERS) S/N: 4YZ4000-UP	
Air Filter Primary.....	A-5541M
Air Filter Set.....	A-5541M-S
Air Filter Primary.....	A-5541
Air Filter Secondary.....	A-5540
Air Filter Primary.....	A-76231
Air Filter Secondary.....	A-8599
Air Filter Primary.....	A-8505
Hydraulic Oil Filter.....	HC-5504
236 (LOADERS) S/N: 5SZ1-3999	
Air Filter Primary.....	A-5541M
Air Filter Set.....	A-5541M-S
Air Filter Secondary.....	A-5540
Air Filter Primary.....	A-76231
Air Filter Primary.....	A-5541
Hydraulic Oil Filter.....	HC-5504
236 (LOADERS) S/N: 5SZ4000-UP	
Air Filter Primary.....	A-5541M
Air Filter Primary.....	A-8505
Air Filter Set.....	A-5541M-S
Air Filter Secondary.....	A-5540
Air Filter Primary.....	A-5541
Air Filter Secondary.....	A-8599
Hydraulic Oil Filter.....	HC-5504
236 (LOADERS) S/N: 6LZ1000-UP	
Air Filter Primary.....	A-5541M

MODEL/APPLICATION	SAKURA NO
CATERPILLAR	
Air Filter Set.....	A-5541M-S
Air Filter Secondary.....	A-5540
Air Filter Primary.....	A-76231
Air Filter Primary.....	A-5541
Hydraulic Oil Filter.....	HC-5504
236 (LOADERS) S/N: 6LZ1-999	
Air Filter Secondary.....	A-8599
Air Filter Primary.....	A-8505
Hydraulic Oil Filter.....	HC-5504
236 (LOADERS) S/N: CED1-UP	
Air Filter Secondary.....	A-5540
Air Filter Set.....	A-5541M-S
Air Filter Primary.....	A-76231
Air Filter Primary.....	A-5541
Air Filter Primary.....	A-5541M
Hydraulic Oil Filter.....	HC-5504
236 (LOADERS) S/N: FDG1-UP	
Air Filter Primary.....	A-8505
Air Filter Secondary.....	A-8599
Hydraulic Oil Filter.....	HC-5504
236B (LOADERS) S/N: HEN1-UP , 2004-UP	
Air Filter Secondary.....	A-5540
Hydraulic Oil Filter.....	HC-5504
Oil Filter Full Flow.....	C-5504
242 (LOADERS) CAT 3024C (S/N: CMB1-UP)	
Air Filter Primary.....	A-8505
Air Filter Secondary.....	A-8599
Hydraulic Oil Filter.....	HC-5504
242 (LOADERS) CAT 3034 (S/N: CMB1-UP)	
Air Filter Secondary.....	A-8599
Air Filter Primary.....	A-8505
Hydraulic Oil Filter.....	HC-5504
242B (LOADERS) CAT 3024C (S/N: 5SZ4000-UP) , 2004-UP	
Air Filter Secondary.....	A-8599
Air Filter Primary.....	A-8505
Hydraulic Oil Filter.....	HC-5504
242B (LOADERS) CAT 3034 (S/N: 5SZ4000-UP) , 2004-UP	
Air Filter Secondary.....	A-8599
Air Filter Primary.....	A-8505
Hydraulic Oil Filter.....	HC-5504
242B (LOADERS) CAT 3024C (S/N: BXM1-UP)	
Air Filter Secondary.....	A-7004
Air Filter Primary.....	A-7003
Hydraulic Oil Filter.....	HC-5504
Oil Filter Full Flow.....	C-1123
242B (LOADERS) CAT 3034 (S/N: BXM1-UP)	
Air Filter Secondary.....	A-7004

MODEL/APPLICATION	SAKURA NO
CATERPILLAR	
Air Filter Primary.....	A-7003
Hydraulic Oil Filter.....	HC-5504
Oil Filter Full Flow.....	C-1123
245 (EXCAVATORS) S/N: 82X1-UP	
Air Filter Primary.....	A-5535
Air Filter Secondary.....	A-5534
Air Filter Primary.....	A-5501
Air Filter Secondary.....	A-5502
Air Filter Set.....	A-5573-S
Fuel Filter.....	FC-5519
Fuel Filter.....	FC-5509
Hydraulic Oil Filter.....	H-5509
Oil Filter Full Flow.....	C-5516
245 (EXCAVATORS) S/N: 84X1-UP	
Air Filter Secondary.....	A-5502
Air Filter Primary.....	A-5501
Air Filter Primary.....	A-5535
Air Filter Set.....	A-5573-S
Air Filter Secondary.....	A-5534
Fuel Filter.....	FC-5509
Fuel Filter.....	FC-5519
Hydraulic Oil Filter.....	H-5509
Oil Filter Full Flow.....	C-5516
245 (EXCAVATORS) S/N: 95V1-470	
Air Filter Secondary.....	A-5534
Air Filter Primary.....	A-5501
Air Filter Set.....	A-5573-S
Air Filter Primary.....	A-5535
Air Filter Secondary.....	A-5502
Fuel Filter.....	FC-5509
Fuel Filter.....	FC-5519
Hydraulic Oil Filter.....	H-5509
Oil Filter Full Flow.....	C-5516
245 (EXCAVATORS) S/N: 95V471-UP	
Air Filter Set.....	A-5573-S
Air Filter Primary.....	A-5535
Air Filter Primary.....	A-5501
Air Filter Secondary.....	A-5534
Air Filter Secondary.....	A-5502
Fuel Filter.....	FC-5519
Fuel Filter.....	FC-5509
Hydraulic Oil Filter.....	H-5509
Oil Filter Full Flow.....	C-5516
245B (EXCAVATORS) CAT 3406 (S/N: 15J1-712-UP)	
Air Filter Set.....	A-5521-S
Air Filter Primary.....	A-5521
Air Filter Secondary.....	A-5529
Fuel Filter.....	FC-5509
Fuel Filter.....	F-5505
Hydraulic Oil Filter.....	H-5509
Hydraulic Oil Filter.....	H-5502
Oil Filter Full Flow.....	C-5516

MODEL/APPLICATION	SAKURA NO	MODEL/APPLICATION	SAKURA NO	MODEL/APPLICATION	SAKURA NO
CATERPILLAR		CATERPILLAR		CATERPILLAR	
245B (EXCAVATORS) CAT 3406 (S/N: 6MF1-512-UP) Air Filter Set..... A-5555-S Air Filter Secondary..... A-5556 Air Filter Set..... A-5521-S Air Filter Primary..... A-5555 Air Filter Secondary..... A-5529 Air Filter Primary..... A-5521 Fuel Filter..... F-5505 Fuel Filter..... FC-5509 Hydraulic Oil Filter..... H-5509 Hydraulic Oil Filter..... H-5502		245D (EXCAVATORS) CAT 3406 (S/N: 4LK1-UP) Air Filter Secondary..... A-5529 Air Filter Set..... A-5521-S Air Filter Primary..... A-5521 Fuel Filter..... F-5505 Fuel Filter..... FC-5509 Hydraulic Oil Filter..... H-5502 Hydraulic Oil Filter..... H-5509 245D (EXCAVATORS) CAT 3406 (S/N: 7ZJ1-UP) Air Filter Primary..... A-5521 Air Filter Secondary..... A-5529 Air Filter Set..... A-5521-S Fuel Filter..... FC-5509 Fuel Filter..... F-5505 Hydraulic Oil Filter..... H-5509 Hydraulic Oil Filter..... H-5502		246C (LOADERS) CAT S/N: JAY1-UP , 2007-UP Air Filter Secondary..... A-5540 Air Filter Set..... A-5541M-S Air Filter Primary..... A-5541M Air Filter Primary..... A-76231 Air Filter Primary..... A-5541 Hydraulic Oil Filter..... HC-5504 Oil Filter Full Flow..... C-5504 247 (LOADERS) CAT 3034 (S/N: CML1-UP) Air Filter Primary..... A-8505 Air Filter Secondary..... A-8599 Hydraulic Oil Filter..... HC-5504 248 (LOADERS) S/N: 6LZ1-999 Air Filter Secondary..... A-8599 Air Filter Secondary..... A-5540 Air Filter Primary..... A-8505 Air Filter Set..... A-5541M-S Air Filter Primary..... A-5541 Air Filter Primary..... A-76231 Air Filter Primary..... A-5541M Hydraulic Oil Filter..... HC-5504 248 (LOADERS) S/N: FYZ1-3999 Air Filter Primary..... A-8505 Air Filter Primary..... A-5541M Air Filter Set..... A-5541M-S Air Filter Secondary..... A-5540 Air Filter Primary..... A-5541 Air Filter Primary..... A-76231 Air Filter Secondary..... A-8599 Hydraulic Oil Filter..... HC-5504 248B (LOADERS) S/N: SCL1-UP , 2004-UP Air Filter Secondary..... A-5540 Hydraulic Oil Filter..... HC-5504 Oil Filter Full Flow..... C-5504 24H (MOTOR GRADERS) CAT 3412E HEUI , 1996-2007 Fuel/Water Separator Primary.... SFC-5504-30 Fuel/Water Separator Primary... SFC-5504-30B 24H (MOTOR GRADERS) CAT (S/N: 80M1-UP) Fuel Filter..... FC-5517 Fuel Filter..... FC-5509 24H (MOTOR GRADERS) CAT 3412E HEUI (S/N: 7KK1-UP) Air Filter Primary..... A-5593 Air Filter Set..... A-5595-S Air Filter Secondary..... A-5594 Fuel Filter..... FC-5509 Hydraulic Oil Filter..... H-5506 Hydraulic Oil Filter..... H-55280 Hydraulic Oil Filter..... H-5503 Hydraulic Oil Filter..... H-5526	
245B (EXCAVATORS) CAT 3406 (S/N: 6MF513-UP) Fuel Filter..... FC-5509 Fuel Filter..... F-5505 Hydraulic Oil Filter..... H-5502 Hydraulic Oil Filter..... H-5509		246 (LOADERS) CAT 3034 S/N: 3NM17565-UP , 2001 Air Filter Primary..... A-76231 Air Filter Primary..... A-5541M Air Filter Set..... A-5541M-S Air Filter Primary..... A-5541 Air Filter Secondary..... A-5540 Hydraulic Oil Filter..... HC-5504 246 (LOADERS) CAT 3034 S/N: 59203641-UP , 2001 Air Filter Primary..... A-5541M Air Filter Primary..... A-5541 Air Filter Set..... A-5541M-S Air Filter Primary..... A-76231 Air Filter Secondary..... A-5540 Hydraulic Oil Filter..... HC-5504 246 (LOADERS) CAT 3034 (S/N: 5SZ1-3999-UP) Air Filter Secondary..... A-5540 Hydraulic Oil Filter..... HC-5504 246 (LOADERS) S/N: 4YZ1-3999 Air Filter Secondary..... A-8599 Air Filter Primary..... A-8505 Hydraulic Oil Filter..... HC-5504 246B (LOADERS) S/N: PAT1-UP , 2004-UP Air Filter Secondary..... A-5540 Hydraulic Oil Filter..... HC-5504 Oil Filter Full Flow..... C-5504 246C (LOADERS) CAT S/N: CJS1-UP , 2007-UP Air Filter Set..... A-5541M-S Air Filter Primary..... A-5541 Air Filter Primary..... A-5541M Air Filter Primary..... A-76231 Air Filter Secondary..... A-5540 Hydraulic Oil Filter..... HC-5504 Oil Filter Full Flow..... C-5504		245B II (EXCAVATORS) CAT S/N: 11N1-UP Fuel Filter..... FC-5509 Fuel Filter..... FC-5519 Hydraulic Oil Filter..... H-5509 Hydraulic Oil Filter..... H-5502 245B II (EXCAVATORS) CAT S/N: 6MF1-UP Fuel Filter..... FC-5509 Fuel Filter..... FC-5519 Hydraulic Oil Filter..... H-5502 Hydraulic Oil Filter..... H-5509 245B SERIES II (EXCAVATORS) CAT 3406 (S/N: 1SJ713-UP) Air Filter Secondary..... A-5529 Air Filter Primary..... A-5521 Air Filter Set..... A-5521-S Fuel Filter..... FC-5509 Fuel Filter..... F-5505 Hydraulic Oil Filter..... H-5509 Hydraulic Oil Filter..... H-5502 245B SERIES II (EXCAVATORS) CAT 3406 (S/N: 6MF513-UP) Air Filter Primary..... A-5521 Air Filter Secondary..... A-5529 Air Filter Set..... A-5521-S Coolant Filter..... WC-5707 Fuel Filter..... F-5505 Fuel Filter..... FC-5509 Hydraulic Oil Filter..... H-5502 Hydraulic Oil Filter..... H-5509	

MODEL/APPLICATION	SAKURA NO
CATERPILLAR	
24H (MOTOR GRADERS) CAT 3412E HEUI (S/N: 7KK1-UP)	
Hydraulic Oil Filter.....	HC-55200
Hydraulic Oil Filter.....	HC-55300
Hydraulic Oil Filter.....	HC-5516
24H (MOTOR GRADERS) S/N: 7KK1-66-UP	
Air Filter Set.....	A-5595-S
Air Filter Primary.....	A-5593
Air Filter Secondary.....	A-5594
Cabin Air Filter.....	CA-5501
Fuel/Water Separator Secondary..	SFC-5504-10
Fuel/Water Separator Secondary..	SFC-5504-10B
Hydraulic Oil Filter.....	H-5506
Hydraulic Oil Filter.....	H-55280
Hydraulic Oil Filter.....	H-5503
Hydraulic Oil Filter.....	H-5526
Hydraulic Oil Filter.....	HC-55200
Hydraulic Oil Filter.....	HC-55300
24H (MOTOR GRADERS) S/N: 7KK67-UP	
Air Filter Primary.....	A-5593
Air Filter Set.....	A-8506-S
Air Filter Secondary.....	A-5594
Air Filter Set.....	A-5595-S
Air Filter Primary.....	A-8506
Cabin Air Filter.....	CA-5501
Fuel/Water Separator Secondary..	SFC-5504-10B
Fuel/Water Separator Secondary..	SFC-5504-10
Hydraulic Oil Filter.....	H-55280
Hydraulic Oil Filter.....	H-5526
Hydraulic Oil Filter.....	HC-55200
Hydraulic Oil Filter.....	H-5506
Hydraulic Oil Filter.....	H-5503
Hydraulic Oil Filter.....	HC-55300
252 (LOADERS) S/N: 4YZ4000-UP	
Air Filter Primary.....	A-5541
Air Filter Primary.....	A-76231
Air Filter Secondary.....	A-5540
Air Filter Set.....	A-5541M-S
Air Filter Secondary.....	A-8599
Air Filter Primary.....	A-8505
Air Filter Primary.....	A-5541M
Hydraulic Oil Filter.....	HC-5504
252 (LOADERS) S/N: 5SZ4000-UP	
Air Filter Primary.....	A-8505
Air Filter Primary.....	A-5541M
Air Filter Primary.....	A-5541
Air Filter Secondary.....	A-5540
Air Filter Set.....	A-5541M-S
Air Filter Secondary.....	A-8599
Air Filter Primary.....	A-76231
Hydraulic Oil Filter.....	HC-5504
252B (LOADERS) S/N: FDG1-UP	
Air Filter Secondary.....	A-5540
Hydraulic Oil Filter.....	HC-5504

MODEL/APPLICATION	SAKURA NO
CATERPILLAR	
Oil Filter Full Flow.....	C-5504
256C (LOADERS) CAT S/N: CJS1-UP	
Air Filter Set.....	A-5541M-S
Air Filter Primary.....	A-76231
Air Filter Secondary.....	A-5540
Air Filter Primary.....	A-5541M
Air Filter Primary.....	A-5541
Hydraulic Oil Filter.....	HC-5504
Oil Filter Full Flow.....	C-5504
256C (LOADERS) CAT S/N: DWS1-UP	
Air Filter Set.....	A-5541M-S
Air Filter Secondary.....	A-5540
Air Filter Primary.....	A-76231
Air Filter Primary.....	A-5541M
Air Filter Primary.....	A-5541
Hydraulic Oil Filter.....	HC-5504
Oil Filter Full Flow.....	C-5504
257 (LOADERS) CAT 3034 (S/N: CMM1-UP)	
Air Filter Primary.....	A-8505
Air Filter Secondary.....	A-8599
Air Filter Secondary.....	A-5540
Hydraulic Oil Filter.....	HC-5504
2570C (FELLER BUNCHERS) CAT C7.1	
Fuel Filter.....	EF-55050
2570D (FELLER BUNCHERS) CAT C7.1	
Fuel Filter.....	EF-55050
262 (LOADERS) S/N: 4YZ4000-UP	
Air Filter Set.....	A-5541M-S
Air Filter Primary.....	A-5541
Air Filter Primary.....	A-76231
Air Filter Secondary.....	A-5540
Air Filter Secondary.....	A-8599
Air Filter Primary.....	A-5541M
Air Filter Primary.....	A-8505
Hydraulic Oil Filter.....	HC-5504
262B (LOADERS) S/N: PDT1-UP , 2004-UP	
Air Filter Secondary.....	A-5540
Hydraulic Oil Filter.....	HC-5504
Oil Filter Full Flow.....	C-5504
262C (LOADERS) CAT S/N: CJS1-UP	
Air Filter Primary.....	A-5541
Air Filter Set.....	A-5541M-S
Air Filter Primary.....	A-5541M
Air Filter Primary.....	A-76231
Air Filter Secondary.....	A-5540
Hydraulic Oil Filter.....	HC-5504
Oil Filter Full Flow.....	C-5504
262C (LOADERS) CAT S/N: MST1-UP	

MODEL/APPLICATION	SAKURA NO
CATERPILLAR	
Air Filter Set.....	A-5541M-S
Air Filter Primary.....	A-76231
Air Filter Secondary.....	A-5540
Air Filter Primary.....	A-5541
Air Filter Primary.....	A-5541M
Hydraulic Oil Filter.....	HC-5504
Oil Filter Full Flow.....	C-5504
267 (LOADERS) CAT 3034 (S/N: CMP1-UP)	
Air Filter Primary.....	A-8505
Air Filter Secondary.....	A-5540
Air Filter Secondary.....	A-8599
Hydraulic Oil Filter.....	HC-5504
267B (LOADERS) CAT 3034 (S/N: CYC1-UP)	
Air Filter Secondary.....	A-5540
Hydraulic Oil Filter.....	HC-5504
Oil Filter Full Flow.....	C-5504
2670C (FELLER BUNCHERS) CAT C7.1	
Fuel Filter.....	EF-55050
2670D (FELLER BUNCHERS) CAT C7.1	
Fuel Filter.....	EF-55050
268B (LOADERS) CAT 3044C (S/N: LBA1-UP) , 2004-UP	
Air Filter Secondary.....	A-5540
Hydraulic Oil Filter.....	HC-5504
Oil Filter Full Flow.....	C-5504
272C (LOADERS) CAT S/N: CJS1-UP	
Air Filter Primary.....	A-5541
Air Filter Set.....	A-5541M-S
Air Filter Primary.....	A-5541M
Air Filter Secondary.....	A-5540
Air Filter Primary.....	A-76231
Hydraulic Oil Filter.....	HC-5504
Oil Filter Full Flow.....	C-5504
272C (LOADERS) CAT S/N: RED1-UP	
Air Filter Set.....	A-5541M-S
Air Filter Secondary.....	A-5540
Air Filter Primary.....	A-5541M
Air Filter Primary.....	A-5541
Air Filter Primary.....	A-76231
Hydraulic Oil Filter.....	HC-5504
Oil Filter Full Flow.....	C-5504
277 (LOADERS) CAT 3034 (S/N: CNC1-UP)	
Air Filter Secondary.....	A-5540
Hydraulic Oil Filter.....	HC-5504
277B (LOADERS) CAT 3034 (S/N: MDH1-UP)	
Air Filter Secondary.....	A-5540
Hydraulic Oil Filter.....	HC-5504
Oil Filter Full Flow.....	C-5504

MODEL/APPLICATION	SAKURA NO	MODEL/APPLICATION	SAKURA NO	MODEL/APPLICATION	SAKURA NO
CATERPILLAR		CATERPILLAR		CATERPILLAR	
277C (LOADERS) CAT S/N: CJS1-UP Air Filter Primary..... A-76231 Air Filter Set..... A-5541M-S Air Filter Secondary..... A-5540 Air Filter Primary..... A-5541M Air Filter Primary..... A-5541 Hydraulic Oil Filter..... HC-5504 Oil Filter Full Flow..... C-5504		3 (EXCAVATORS) CAT 3116 Air Filter Secondary..... A-6007 Oil Filter Full Flow..... C-7105 301.6C (EXCAVATORS) CAT (S/N: JBB1-UP) , 2006-UP Air Filter Primary..... A-8504 301.8C (EXCAVATORS) CAT S/N: 5DW1-UP , 2008-UP Air Filter Primary..... A-8504 Oil Filter Full Flow..... C-1906 Oil Filter Full Flow..... C-1123 301.8C (EXCAVATORS) CAT S/N: JSB1-UP , 2008-UP Air Filter Primary..... A-8504 Oil Filter Full Flow..... C-1906 Oil Filter Full Flow..... C-1123 302 (EXCAVATORS) CAT 3003 (S/N: 3YW1-UP) Hydraulic Oil Filter..... HC-5504 Oil Filter Full Flow..... C-1123 Oil Filter Full Flow..... C-5504 302 (EXCAVATORS) CAT 3003 (S/N: BDH1-UP) Oil Filter Full Flow..... C-1123 Oil Filter Full Flow..... C-5504 302 (EXCAVATORS) CAT 3003 (S/N: BFA1-UP) Oil Filter Full Flow..... C-1123 Oil Filter Full Flow..... C-5504 302.5C (EXCAVATORS) CAT (S/N: 4ZW1-UP) Air Filter Secondary..... A-8610 Oil Filter Full Flow..... C-1123 Oil Filter Full Flow..... C-1906 303 (EXCAVATORS) CAT 3013 (S/N: 4AZ1-UP) Air Filter Secondary..... A-5569 Oil Filter Full Flow..... C-1123 303 (EXCAVATORS) S/N: DMA1-UP Air Filter Secondary..... A-5569 303.5C (EXCAVATORS) S/N: DMY1-UP Air Filter Secondary..... A-5569 Oil Filter Full Flow..... C-1720 303C (EXCAVATORS) S/N: BXT1-UP Air Filter Secondary..... A-5569 Oil Filter Full Flow..... C-1720 304 (EXCAVATORS) S/N: AFW1-UP Air Filter Secondary..... A-5569 Oil Filter Full Flow..... C-1123		304 (EXCAVATORS) S/N: DMA1-UP Air Filter Secondary..... A-5569 304 (EXCAVATORS) S/N: NAD1-1627-UP Air Filter Secondary..... A-5569 Oil Filter Full Flow..... C-1720 304 (EXCAVATORS) S/N: NAD1628-UP Air Filter Secondary..... A-5569 Oil Filter Full Flow..... C-1720 304CR (EXCAVATORS) CAT 3044C (S/N: NAD1-UP) Air Filter Secondary..... A-5569 Oil Filter Full Flow..... C-1011 304C (EXCAVATORS) S/N: FPPK1-UP Air Filter Secondary..... A-5569 Oil Filter Full Flow..... C-1720 305 (EXCAVATORS) S/N: BMW1-UP Air Filter Secondary..... A-5569 305 (EXCAVATORS) S/N: DGT1-UP Air Filter Secondary..... A-5569 Oil Filter Full Flow..... C-1720 305 (EXCAVATORS) S/N: DSA1-UP Air Filter Secondary..... A-5569 Oil Filter Full Flow..... C-1720 305C (EXCAVATORS) S/N: HWJ1-UP Air Filter Primary..... A-8505 Air Filter Secondary..... A-8599 Oil Filter Full Flow..... C-1720 305 CR (EXCAVATORS) CAT 3054B (S/N: DGT1-UP) , 2004-UP Air Filter Secondary..... A-5569 Oil Filter Full Flow..... C-1720 305 CR (EXCAVATORS) CAT 3054B (S/N: DSA1-UP) Air Filter Secondary..... A-5569 Oil Filter Full Flow..... C-1720 306 (EXCAVATORS) CAT S/N: CXZ1-UP Air Filter Primary..... A-8505 Fuel Filter Secondary..... FC-5515 Fuel Filter..... FC-10022 Fuel Filter..... FC-1002 Fuel Filter..... FC-5516 Fuel Filter Secondary..... FC-55151 Oil Filter Full Flow..... C-5505 Oil Filter Full Flow..... C-5522 Oil Filter Full Flow..... C-5510	
277C (LOADERS) CAT S/N: JWF1-UP Air Filter Primary..... A-5541M Air Filter Primary..... A-76231 Air Filter Set..... A-5541M-S Air Filter Primary..... A-5541 Air Filter Secondary..... A-5540 Hydraulic Oil Filter..... HC-5504 Oil Filter Full Flow..... C-5504					
287 (LOADERS) CAT 3034 (S/N: CNY1-UP) Air Filter Secondary..... A-5540 Hydraulic Oil Filter..... HC-5504					
287B (LOADERS) CAT 3034 (S/N: ZSA1-UP) Air Filter Secondary..... A-5540 Hydraulic Oil Filter..... HC-5504 Oil Filter Full Flow..... C-5504					
287C (LOADERS) CAT S/N: CJS1--UP , 2007-UP Air Filter Set..... A-5541M-S Air Filter Secondary..... A-5540 Air Filter Primary..... A-5541M Air Filter Primary..... A-76231 Air Filter Primary..... A-5541 Hydraulic Oil Filter..... HC-5504 Oil Filter Full Flow..... C-5504					
287C (LOADERS) CAT S/N: GCP1-UP , 2007-UP Air Filter Primary..... A-5541M Air Filter Set..... A-5541M-S Air Filter Secondary..... A-5540 Air Filter Primary..... A-76231 Air Filter Primary..... A-5541 Hydraulic Oil Filter..... HC-5504 Oil Filter Full Flow..... C-5504					
287C (LOADERS) CAT S/N: MAS1-UP , 2007-UP Air Filter Set..... A-5541M-S Air Filter Primary..... A-5541 Air Filter Secondary..... A-5540 Air Filter Primary..... A-5541M Air Filter Primary..... A-76231 Hydraulic Oil Filter..... HC-5504 Oil Filter Full Flow..... C-5504					
2P5000 (FORKLIFTS) w/Mitsubishi K25 Eng. Air Filter Primary..... A-85134					

MODEL/APPLICATION	SAKURA NO	MODEL/APPLICATION	SAKURA NO	MODEL/APPLICATION	SAKURA NO
CATERPILLAR		CATERPILLAR		CATERPILLAR	
306 (EXCAVATORS) CAT S/N: DCK1-UP		Air Filter Primary.....	A-8505	Air Filter Secondary.....	A-8599
Air Filter Primary.....	A-8505	Air Filter Secondary.....	A-8599	Fuel Filter.....	FC-10022
Fuel Filter Secondary.....	FC-5515	Fuel Filter.....	FC-10022	Fuel Filter.....	FC-1002
Fuel Filter.....	FC-1002	Fuel Filter.....	FC-1002	Hydraulic Oil Filter.....	HC-55170
Fuel Filter Secondary.....	FC-55151	Fuel Filter.....	FC-1002	Oil Filter Full Flow.....	C-5505
Fuel Filter.....	FC-10022	307B (EXCAVATORS) S/N: 6KZ1-UP		311 (EXCAVATORS) CAT 3064T	
Fuel Filter.....	FC-5516	Air Filter Primary.....	A-8505	Air Filter Set.....	A-4212-S
Oil Filter Full Flow.....	C-5505	Air Filter Secondary.....	A-8599	Air Filter Secondary.....	A-4211
Oil Filter Full Flow.....	C-5522	Fuel Filter.....	FC-10022	Air Filter Primary.....	A-4210
Oil Filter Full Flow.....	C-5510	Fuel Filter.....	FC-1002	Hydraulic Oil Filter.....	HC-9901
306 (EXCAVATORS) CAT S/N: MAE1-UP		307B (EXCAVATORS) S/N: 7DZ1-UP		311 (EXCAVATORS) CAT 3064 (S/N: 9LJ1-UP)	
Air Filter Primary.....	A-8505	Air Filter Secondary.....	A-8599	Air Filter Secondary.....	A-6008
Fuel Filter Secondary.....	FC-55151	Air Filter Primary.....	A-8505	Air Filter Set.....	A-5663-S
Fuel Filter.....	FC-10022	Fuel Filter.....	FC-1002	Air Filter Primary.....	A-5627
Fuel Filter.....	FC-5516	Fuel Filter.....	FC-10022	Fuel Filter.....	FC-1010
Fuel Filter.....	FC-1002	307B (EXCAVATORS) S/N: AFB1-UP		Oil Filter Full Flow.....	C-5510
Fuel Filter Secondary.....	FC-5515	Air Filter Secondary.....	A-8599	Oil Filter Combination.....	C-7916
Oil Filter Full Flow.....	C-5522	Air Filter Primary.....	A-8505	311 (EXCAVATORS) S/N: 5PK1-UP	
Oil Filter Full Flow.....	C-5510	Fuel Filter.....	FC-10022	Air Filter Primary.....	A-76231
Oil Filter Full Flow.....	C-5505	Fuel Filter.....	FC-1002	Air Filter Primary.....	A-5541
307 (EXCAVATORS) L4 3.6L 3600cc 220 CID , 3600		307B (EXCAVATORS) w/Mitsubishi 4M40 Eng		Air Filter Secondary.....	A-5540
Hydraulic Oil Filter.....	H-5519	Hydraulic Oil Filter.....	H-5519	Air Filter Primary.....	A-5541M
307 (EXCAVATORS) L4 4.4L 4400cc 268.5 CID , 4400		307C (EXCAVATORS) L4 2.8L 2800cc 173 CID , 2800		Air Filter Set.....	A-5541M-S
Hydraulic Oil Filter.....	H-5519	Hydraulic Oil Filter.....	H-5519	Cabin Air Filter.....	CA-55850
307 (EXCAVATORS) MITSUBISHI 4D32		307C (EXCAVATORS) MITSUBISHI 4M40/4M41 (S/N: BCM1-UP)		311 (EXCAVATORS) S/N: 6LK1-UP	
Hydraulic Oil Filter.....	HC-9901	Air Filter Primary.....	A-8505	Air Filter Secondary.....	A-6008
307 (EXCAVATORS) S/N: 2NM1-UP		Cabin Air Filter.....	CA-55850	Air Filter Set.....	A-5663-S
Air Filter Primary.....	A-76231	Fuel Filter.....	FC-10022	Air Filter Primary.....	A-5627
Air Filter Set.....	A-5541M-S	Fuel Filter.....	FC-1002	Air Filter Secondary.....	A-6008
Air Filter Primary.....	A-5541M	Oil Filter Full Flow.....	C-5505	Fuel Filter.....	FC-1010
Air Filter Primary.....	A-5541	307C (EXCAVATORS) MITSUBISHI 4M40/4M41 (S/N: BNE1-UP)		Oil Filter Full Flow.....	C-5510
Air Filter Secondary.....	A-5540	Air Filter Primary.....	A-8505	311CU (EXCAVATORS) CAT 3064T	
307B (EXCAVATORS) MITSUBISHI M40EA (S/N: AFB-UP)		Cabin Air Filter.....	CA-55850	Air Filter Primary.....	A-4210
Air Filter Secondary.....	A-8599	Fuel Filter.....	FC-10022	Air Filter Secondary.....	A-4211
Air Filter Primary.....	A-8505	Fuel Filter.....	FC-1002	Air Filter Set.....	A-4212-S
Cabin Air Filter.....	CA-55850	Oil Filter Full Flow.....	C-5505	Hydraulic Oil Filter.....	HC-9901
Fuel Filter.....	FC-10022	307C (EXCAVATORS) MITSUBISHI 4M40		311CU (EXCAVATORS) CAT 3064T (S/N: CKE1-UP)	
Fuel Filter.....	FC-1002	Hydraulic Oil Filter.....	HC-9901	Air Filter Primary.....	A-5541M
Oil Filter Combination.....	C-5808	307 JA (EXCAVATORS) CAT 3046 (S/N: 2PM1-UP)		Air Filter Set.....	A-5541M-S
307B (EXCAVATORS) MITSUBISHI 4M40		Fuel Filter.....	FC-1016	Air Filter Primary.....	A-76600
Hydraulic Oil Filter.....	HC-9901	307L (EXCAVATORS) S/N: 2PM1-UP		Air Filter Secondary.....	A-5540
307B (EXCAVATORS) S/N: 4RW1-UP		Fuel Filter.....	FC-1016	Air Filter Primary.....	A-76231
Air Filter Primary.....	A-8505	308C (EXCAVATORS) MITSUBISHI 4M40		Air Filter Primary.....	A-5541
Air Filter Secondary.....	A-8599	Hydraulic Oil Filter.....	HC-9901	Hydraulic Oil Filter.....	H-7942
Fuel Filter.....	FC-1002	308C (EXCAVATORS) S/N: KCX1-UP		Hydraulic Oil Filter.....	HC-5801
Fuel Filter.....	FC-10022	307B (EXCAVATORS) S/N: 5CW1-UP		Oil Filter Full Flow.....	C-5510

MODEL/APPLICATION	SAKURA NO	MODEL/APPLICATION	SAKURA NO	MODEL/APPLICATION	SAKURA NO
CATERPILLAR		CATERPILLAR		CATERPILLAR	
312C (EXCAVATORS) CAT 3064 (S/N: FDS1-UP) Fuel Filter Secondary..... FC-55151 Hydraulic Oil Filter..... HC-5801 Hydraulic Oil Filter..... H-7942 Oil Filter Full Flow..... C-5510		312C L (EXCAVATORS) S/N: BNN1-UP Air Filter Primary..... A-76231 Air Filter Primary..... A-5541 Air Filter Secondary..... A-5540 Air Filter Primary..... A-5541M Air Filter Set..... A-5541M-S Hydraulic Oil Filter..... H-7942 Hydraulic Oil Filter..... HC-5801 Oil Filter Full Flow..... C-5102		312B (EXCAVATORS) CAT 3064 (S/N: 9FS1-UP) Air Filter Secondary..... A-5540 Hydraulic Oil Filter..... H-7942 Hydraulic Oil Filter..... HC-5801 Oil Filter Full Flow..... C-5102	
312C L (EXCAVATORS) CAT 3064T Air Filter Primary..... A-4210 Air Filter Secondary..... A-4211 Air Filter Set..... A-4212-S Hydraulic Oil Filter..... HC-9901		312B (EXCAVATORS) CAT 3064T Hydraulic Oil Filter..... HC-9901		312B (EXCAVATORS) CAT 3064 (S/N: 9GR1-UP) Air Filter Secondary..... A-5540 Air Filter Primary..... A-5541M Air Filter Primary..... A-5541 Air Filter Primary..... A-76231 Air Filter Set..... A-5541M-S Fuel Filter..... FC-1010 Hydraulic Oil Filter..... H-7942 Hydraulic Oil Filter..... HC-5801 Oil Filter Full Flow..... C-5510 Oil Filter Full Flow..... C-5102	
312C L (EXCAVATORS) CAT 3064 (S/N: CBA1-UP) Air Filter Primary..... A-5541 Air Filter Primary..... A-76600 Air Filter Secondary..... A-5540 Air Filter Primary..... A-5541M Air Filter Set..... A-5541M-S Air Filter Primary..... A-76231 Fuel Filter..... FC-5516 Fuel Filter Secondary..... FC-5515 Fuel Filter Secondary..... FC-55151 Hydraulic Oil Filter..... HC-5801 Hydraulic Oil Filter..... H-7942 Oil Filter Full Flow..... C-5510		312B (EXCAVATORS) CAT 3064 (S/N: 2KW1-UP) Air Filter Secondary..... A-5540 Hydraulic Oil Filter..... HC-5801 Hydraulic Oil Filter..... H-7942 Oil Filter Full Flow..... C-5102		312D (EXCAVATORS) CAT C4.2 ACERT , 4200 Air Filter Primary..... A-4210 Air Filter Set..... A-4212-S Air Filter Secondary..... A-4211	
312C L (EXCAVATORS) CAT 3064 (S/N: CBT1-UP) Air Filter Secondary..... A-5540 Hydraulic Oil Filter..... HC-5801 Hydraulic Oil Filter..... H-7942 Oil Filter Full Flow..... C-5102		312B (EXCAVATORS) CAT 3064 (S/N: 2NS1-UP) Air Filter Set..... A-5541M-S Air Filter Primary..... A-5541M Air Filter Primary..... A-76231 Air Filter Secondary..... A-5540 Air Filter Primary..... A-5541 Fuel Filter..... FC-1010 Hydraulic Oil Filter..... H-7942 Hydraulic Oil Filter..... HC-5801 Oil Filter Full Flow..... C-5510		312D (EXCAVATORS) CAT C4.2 Hydraulic Oil Filter..... H-55440	
312C L (EXCAVATORS) CAT 3064 (S/N: DBN1-UP) Air Filter Secondary..... A-5540 Cabin Air Filter..... CA-55850 Fuel Filter Secondary..... FC-55151 Fuel Filter Secondary..... FC-5515 Fuel Filter..... FC-5516 Hydraulic Oil Filter..... HC-5801 Hydraulic Oil Filter..... H-5522 Oil Filter Full Flow..... C-5510		312B (EXCAVATORS) CAT 3064 (S/N: 3FS1-UP) Air Filter Primary..... A-5541M Air Filter Set..... A-5541M-S Air Filter Primary..... A-5541 Air Filter Primary..... A-76231 Air Filter Secondary..... A-5540 Fuel Filter..... FC-1010 Hydraulic Oil Filter..... H-7942 Hydraulic Oil Filter..... HC-5801 Oil Filter Full Flow..... C-5510		312D (EXCAVATORS) CAT C4.2 ACERT Hydraulic Oil Filter..... HC-9901	
312C L (EXCAVATORS) CAT 3064 (S/N: FDS1-UP) Air Filter Primary..... A-5541 Air Filter Primary..... A-76600 Air Filter Secondary..... A-5540 Air Filter Primary..... A-76231 Air Filter Set..... A-5541M-S Air Filter Primary..... A-5541M Fuel Filter..... FC-5516 Fuel Filter Secondary..... FC-55151 Fuel Filter Secondary..... FC-5515 Hydraulic Oil Filter..... H-7942 Hydraulic Oil Filter..... HC-5801 Oil Filter Full Flow..... C-5510 Oil Filter Full Flow..... C-5102		312B (EXCAVATORS) CAT 3064 (S/N: 6SW1-UP) Air Filter Secondary..... A-5540 Hydraulic Oil Filter..... HC-5801 Hydraulic Oil Filter..... H-7942 Oil Filter Full Flow..... C-5102		312D (EXCAVATORS) CAT C4.2 ACERT Hydraulic Oil Filter..... H-55440	
312C L (EXCAVATORS) CAT 3064 (S/N: FDS1-UP) Air Filter Primary..... A-5541 Air Filter Primary..... A-76600 Air Filter Secondary..... A-5540 Air Filter Primary..... A-76231 Air Filter Set..... A-5541M-S Air Filter Primary..... A-5541M Fuel Filter..... FC-5516 Fuel Filter Secondary..... FC-55151 Fuel Filter Secondary..... FC-5515 Hydraulic Oil Filter..... H-7942 Hydraulic Oil Filter..... HC-5801 Oil Filter Full Flow..... C-5510 Oil Filter Full Flow..... C-5102		312B (EXCAVATORS) CAT 3064 (S/N: 8JR1-UP) Air Filter Primary..... A-5541M Air Filter Primary..... A-76231 Air Filter Set..... A-5541M-S Air Filter Secondary..... A-5540 Air Filter Primary..... A-5541 Fuel Filter..... FC-1010 Hydraulic Oil Filter..... HC-5801 Hydraulic Oil Filter..... H-7942 Oil Filter Full Flow..... C-5510		312D (EXCAVATORS) CAT C4.2 ACERT Hydraulic Oil Filter..... H-55440	
312C L (EXCAVATORS) CAT 3064 (S/N: FDS1-UP) Air Filter Primary..... A-5541 Air Filter Primary..... A-76600 Air Filter Secondary..... A-5540 Air Filter Primary..... A-76231 Air Filter Set..... A-5541M-S Air Filter Primary..... A-5541M Fuel Filter..... FC-5516 Fuel Filter Secondary..... FC-55151 Fuel Filter Secondary..... FC-5515 Hydraulic Oil Filter..... H-7942 Hydraulic Oil Filter..... HC-5801 Oil Filter Full Flow..... C-5510 Oil Filter Full Flow..... C-5102		312B (EXCAVATORS) CAT 3064 (S/N: 6SW1-UP) Air Filter Secondary..... A-5540 Hydraulic Oil Filter..... HC-5801 Hydraulic Oil Filter..... H-7942 Oil Filter Full Flow..... C-5102		312D (EXCAVATORS) CAT C4.2 ACERT Hydraulic Oil Filter..... H-55440	

MODEL/APPLICATION	SAKURA NO	MODEL/APPLICATION	SAKURA NO	MODEL/APPLICATION	SAKURA NO
CATERPILLAR		CATERPILLAR		CATERPILLAR	
312B L (EXCAVATORS) CAT 3064 (S/N: 6SW1-UP)		Air Filter Set.....	A-4212-S	313F (EXCAVATORS) CAT C4.4	
Hydraulic Oil Filter.....	H-7942	Air Filter Secondary.....	A-4211	Fuel Filter.....	EF-55050
Hydraulic Oil Filter.....	HC-5801	Air Filter Primary.....	A-4210		
Oil Filter Full Flow.....	C-5102	Hydraulic Oil Filter.....	HC-9901	313D2 LGP (EXCAVATORS) CAT 3054C	
		Hydraulic Oil Filter.....	H-55440	Hydraulic Oil Filter.....	H-55440
312B L (EXCAVATORS) CAT 3064 (S/N: 8JR1-UP)		312D2 GC (EXCAVATORS) w/3054C Eng.		313D (EXCAVATORS) CAT C4.2	
Air Filter Primary.....	A-5541M	Fuel/Water Separator.....	SFC-43040	Hydraulic Oil Filter.....	H-55440
Air Filter Primary.....	A-76231				
Air Filter Primary.....	A-5541	312D2 L (EXCAVATORS) CAT 3054C		314C (EXCAVATORS) CAT 3064T	
Air Filter Secondary.....	A-5540	Air Filter Primary.....	A-4210	Hydraulic Oil Filter.....	HC-9901
Air Filter Set.....	A-5541M-S	Air Filter Set.....	A-4212-S		
Fuel Filter.....	FC-1010	Air Filter Secondary.....	A-4211	314C (EXCAVATORS) CAT 3064 (S/N: KJA1-UP)	
Hydraulic Oil Filter.....	HC-5801	Hydraulic Oil Filter.....	H-55440	Air Filter Primary.....	A-5541
Hydraulic Oil Filter.....	H-7942	Hydraulic Oil Filter.....	HC-9901	Air Filter Primary.....	A-5541M
Oil Filter Full Flow.....	C-5510			Air Filter Primary.....	A-76231
		312D2 L (EXCAVATORS) w/3054C Eng.		Air Filter Secondary.....	A-5540
312B L (EXCAVATORS) CAT 3064 (S/N: 9FS1-UP)		Fuel/Water Separator.....	SFC-43040	Air Filter Set.....	A-5541M-S
Air Filter Secondary.....	A-5540			Fuel Filter Secondary.....	FC-55151
Hydraulic Oil Filter.....	HC-5801	312E (EXCAVATORS) CAT C4.4		Fuel Filter.....	FC-5516
Hydraulic Oil Filter.....	H-7942	Fuel Filter.....	EF-55050	Fuel Filter Secondary.....	FC-5515
Oil Filter Full Flow.....	C-5102	Hydraulic Oil Filter.....	H-55440	Hydraulic Oil Filter.....	HC-5801
				Hydraulic Oil Filter.....	H-7942
312B L (EXCAVATORS) CAT 3064 (S/N: 9GR1-UP)		312E L (EXCAVATORS) CAT C4.4		Oil Filter Full Flow.....	C-5510
Air Filter Primary.....	A-5541M	Fuel Filter.....	EF-55050		
Air Filter Primary.....	A-5541	Hydraulic Oil Filter.....	H-55440	314C (EXCAVATORS) CAT 3064 (S/N: PCA1-UP)	
Air Filter Set.....	A-5541M-S			Air Filter Primary.....	A-5541
Air Filter Primary.....	A-76231	312D L (EXCAVATORS) CAT C4.2		Air Filter Set.....	A-5541M-S
Air Filter Secondary.....	A-5540	Hydraulic Oil Filter.....	H-55440	Air Filter Secondary.....	A-5540
Fuel Filter.....	FC-1010			Air Filter Primary.....	A-76231
Hydraulic Oil Filter.....	H-7942	313B (EXCAVATORS) MITSUBISHI 4D34-TE1		Air Filter Primary.....	A-5541M
Hydraulic Oil Filter.....	HC-5801	Air Filter Primary.....	AS-7989	Fuel Filter.....	FC-5516
Oil Filter Full Flow.....	C-5510	Air Filter Set.....	AS-7989-S	Fuel Filter Secondary.....	FC-55151
		Hydraulic Oil Filter.....	HC-9901	Fuel Filter Secondary.....	FC-5515
312B L (EXCAVATORS) CAT 3064 (S/N: 9NW1-UP)		313B CR (EXCAVATORS) CAT 3054 (S/N: BAS1-UP)		Hydraulic Oil Filter.....	HC-5801
Air Filter Secondary.....	A-5540	Fuel Filter.....	FC-1002	Hydraulic Oil Filter.....	H-7942
Hydraulic Oil Filter.....	HC-5801	Fuel Filter.....	FC-10022	Oil Filter Full Flow.....	C-5510
Hydraulic Oil Filter.....	H-7942				
Oil Filter Full Flow.....	C-5102	313B CR (EXCAVATORS) MITSUBISHI 4D34-TE1		314C CR (EXCAVATORS) CAT 3064T	
		Hydraulic Oil Filter.....	HC-9901	Hydraulic Oil Filter.....	HC-9901
312L (EXCAVATORS) S/N: 6GK425-UP					
Air Filter Secondary.....	A-6008	313D2 (EXCAVATORS) CAT 3054C		314C CR (EXCAVATORS) CAT 3145 (S/N: KJA1-UP)	
Air Filter Primary.....	A-5627	Hydraulic Oil Filter.....	H-55440	Air Filter Set.....	A-5541M-S
Air Filter Set.....	A-5663-S			Air Filter Secondary.....	A-5540
Oil Filter Combination.....	C-7916	313D2 (EXCAVATORS) w/3054C Eng.		Air Filter Primary.....	A-5541M
		Fuel/Water Separator.....	SFC-43040	Air Filter Primary.....	A-76231
312D2 (EXCAVATORS) CAT 3054C				Air Filter Primary.....	A-5541
Air Filter Primary.....	A-4210	313F L (EXCAVATORS) CAT C4.4		Fuel Filter Secondary.....	FC-55151
Air Filter Set.....	A-4212-S	Fuel Filter.....	EF-55050	Fuel Filter.....	FC-5516
Air Filter Secondary.....	A-4211			Fuel Filter Secondary.....	FC-5515
Hydraulic Oil Filter.....	H-55440	313F L (EXCAVATORS)		Hydraulic Oil Filter.....	H-7942
Hydraulic Oil Filter.....	HC-9901	Cabin Air Filter.....	CAC-55170	Hydraulic Oil Filter.....	HC-5801
		Cabin Air Filter.....	CA-55170	Oil Filter Full Flow.....	C-5510
312D2 (EXCAVATORS) w/3054C Eng.		Cabin Air Filter.....	CAV-55170		
Fuel/Water Separator.....	SFC-43040			314C CR (EXCAVATORS) CAT 3145 (S/N: PCA1-UP)	
				Air Filter Primary.....	A-76231
312D2 GC (EXCAVATORS) CAT 3054C					

MODEL/APPLICATION	SAKURA NO	MODEL/APPLICATION	SAKURA NO	MODEL/APPLICATION	SAKURA NO
CATERPILLAR		CATERPILLAR		CATERPILLAR	
314C CR (EXCAVATORS) CAT 3145 (S/N: PCA1-UP)		Fuel Filter Secondary.....	FC-5515	315C L (EXCAVATORS) CAT 3046 T	
Air Filter Secondary.....	A-5540	Hydraulic Oil Filter.....	HC-5801	Hydraulic Oil Filter.....	HC-9901
Air Filter Primary.....	A-5541M	Hydraulic Oil Filter.....	H-7942	315C L (EXCAVATORS) w/3054 Eng.	
Air Filter Primary.....	A-5541	Oil Filter Full Flow.....	C-5510	Fuel/Water Separator.....	SFC-43040
Air Filter Set.....	A-5541M-S	315C (EXCAVATORS) CAT 3046		315 (EXCAVATORS) CAT 3046 (S/N: 3ZM1-UP)	
Fuel Filter Secondary.....	FC-5515	Air Filter Secondary.....	A-4402	Air Filter Secondary.....	A-5540
Fuel Filter Secondary.....	FC-55151	Oil Filter Full Flow.....	C-6218	Oil Filter Full Flow.....	C-5102
Fuel Filter.....	FC-5516	315C (EXCAVATORS) CAT 3046 T		315 (EXCAVATORS) CAT 3046 T	
Hydraulic Oil Filter.....	H-7942	Hydraulic Oil Filter.....	HC-9901	Hydraulic Oil Filter.....	HC-9901
Hydraulic Oil Filter.....	HC-5801	315C L (EXCAVATORS) CAT 3150 (S/N: ANF1-UP)		315B (EXCAVATORS) CAT 3046 (S/N: 5SW1-UP)	
Oil Filter Full Flow.....	C-5510	Air Filter Primary.....	A-5673	Air Filter Primary.....	A-76231
314E LCR (EXCAVATORS) CAT C4.4		Air Filter Secondary.....	A-8670	Air Filter Set.....	A-5541M-S
Fuel Filter.....	EF-55050	Air Filter Set.....	A-5675-S	Air Filter Primary.....	A-5541
314E LCR (EXCAVATORS)		Cabin Air Filter.....	CA-55850	Air Filter Primary.....	A-5541M
Cabin Air Filter.....	CAC-55170	Hydraulic Oil Filter.....	HC-5801	Air Filter Secondary.....	A-5540
Cabin Air Filter.....	CA-55170	Hydraulic Oil Filter.....	H-5522	Hydraulic Oil Filter.....	H-7942
Cabin Air Filter.....	CAV-55170	Oil Filter Full Flow.....	C-5510	Hydraulic Oil Filter.....	HC-5801
314E CR (EXCAVATORS) CAT C4.4		315C L (EXCAVATORS) CAT 3150 (S/N: CFB1-UP)		Oil Filter Full Flow.....	C-5102
Fuel Filter.....	EF-55050	Air Filter Primary.....	AS-8577	315B (EXCAVATORS) CAT 3046 T	
314E SR (EXCAVATORS) CAT C4.4		Air Filter Secondary.....	A-8578	Hydraulic Oil Filter.....	HC-9901
Fuel Filter.....	EF-55050	Air Filter Secondary.....	A-2705	315B (EXCAVATORS) S/N: 1SW1-UP	
315C (EXCAVATORS) CAT 3054 (S/N: AKE1-UP)		Air Filter Primary.....	A-2706	Air Filter Primary.....	A-2706
Air Filter Secondary.....	A-2705	Cabin Air Filter.....	CA-55850	Air Filter Secondary.....	A-2705
Air Filter Primary.....	A-2706	Fuel Filter Secondary.....	FC-55151	Fuel Filter.....	FC-1010
Cabin Air Filter.....	CA-55850	Fuel Filter.....	FC-5516	Hydraulic Oil Filter.....	H-7942
Fuel Filter Secondary.....	FC-55151	Fuel Filter Secondary.....	FC-5515	Hydraulic Oil Filter.....	HC-5801
Fuel Filter.....	FC-5516	Hydraulic Oil Filter.....	H-7942	Oil Filter Full Flow.....	C-5504
Fuel Filter Secondary.....	FC-5515	Hydraulic Oil Filter.....	HC-5801	315B (EXCAVATORS) S/N: 3AW1-UP	
Hydraulic Oil Filter.....	H-7942	Oil Filter Full Flow.....	C-5510	Air Filter Secondary.....	A-2705
Hydraulic Oil Filter.....	HC-5801	315C L (EXCAVATORS) CAT 3150 (S/N: CFT1-UP)		Air Filter Primary.....	A-2706
Oil Filter Full Flow.....	C-5510	Air Filter Primary.....	A-2706	Fuel Filter.....	FC-1010
315C (EXCAVATORS) CAT 3054 (S/N: CFB1-UP)		Air Filter Secondary.....	A-2705	Hydraulic Oil Filter.....	H-7942
Air Filter Primary.....	AS-8577	Air Filter Secondary.....	A-2705	Hydraulic Oil Filter.....	HC-5801
Air Filter Secondary.....	A-8578	Air Filter Primary.....	AS-8577	Oil Filter Full Flow.....	C-5504
Air Filter Secondary.....	A-2705	Cabin Air Filter.....	CA-55850	315D (EXCAVATORS) CAT C4.2 ACERT	
Air Filter Primary.....	A-2706	Fuel Filter Secondary.....	FC-5515	Hydraulic Oil Filter.....	HC-9901
Fuel Filter Secondary.....	FC-55151	Fuel Filter Secondary.....	FC-55151	315 M (EXCAVATORS)	
Fuel Filter.....	FC-5516	Fuel Filter.....	FC-5516	Air Filter Primary.....	A-76231
Fuel Filter Secondary.....	FC-5515	Hydraulic Oil Filter.....	H-7942	Air Filter Primary.....	A-5541M
Hydraulic Oil Filter.....	H-7942	Hydraulic Oil Filter.....	HC-5801	Air Filter Secondary.....	A-5540
Hydraulic Oil Filter.....	HC-5801	Oil Filter Full Flow.....	C-5510	Air Filter Primary.....	A-5541
Oil Filter Full Flow.....	C-5510	315C L (EXCAVATORS) CAT 3150 (S/N: CJC1-UP)		Air Filter Set.....	A-5541M-S
315C (EXCAVATORS) CAT 3054 (S/N: CFT1-UP)		Air Filter Secondary.....	A-2705	315L (EXCAVATORS) CAT 3150 (S/N: 4YM1-UP)	
Air Filter Secondary.....	A-2705	Air Filter Primary.....	A-2706	Air Filter Secondary.....	A-6008
Air Filter Secondary.....	A-8578	Cabin Air Filter.....	CA-55850	Air Filter Primary.....	A-5627
Air Filter Primary.....	AS-8577	Fuel Filter.....	FC-5516	315L (EXCAVATORS) CAT 3150 (S/N: 4YM1-UP)	
Air Filter Primary.....	A-2706	Fuel Filter Secondary.....	FC-55151	Air Filter Secondary.....	A-6008
Cabin Air Filter.....	CA-55850	Fuel Filter Secondary.....	FC-5515	Air Filter Primary.....	A-5627
Fuel Filter Secondary.....	FC-55151	Hydraulic Oil Filter.....	HC-5801		
Fuel Filter.....	FC-5516	Hydraulic Oil Filter.....	H-7942		
		Oil Filter Full Flow.....	C-5510		

MODEL/APPLICATION	SAKURA NO	MODEL/APPLICATION	SAKURA NO	MODEL/APPLICATION	SAKURA NO
CATERPILLAR		CATERPILLAR		CATERPILLAR	
315L (EXCAVATORS) CAT 3150 (S/N: 4YM1-UP)		Hydraulic Oil Filter.....	HC-9901	Hydraulic Oil Filter.....	H-7942
Air Filter Set.....	A-5663-S			Oil Filter Full Flow.....	C-5504
Cabin Air Filter.....	CA-55850				
Fuel Filter.....	FC-1010				
Oil Filter Full Flow.....	C-5504				
315L (EXCAVATORS) CAT 3150 (S/N: 5XK1-UP)					
Air Filter Secondary.....	A-6008				
Air Filter Primary.....	A-5627				
Air Filter Set.....	A-5663-S				
Cabin Air Filter.....	CA-55850				
Fuel Filter.....	FC-1010				
Oil Filter Full Flow.....	C-5504				
315L (EXCAVATORS) CAT 3150 (S/N: 6YM1-UP)					
Air Filter Secondary.....	A-6008				
Air Filter Set.....	A-5663-S				
Air Filter Primary.....	A-5627				
Cabin Air Filter.....	CA-55850				
Fuel Filter.....	FC-1010				
Oil Filter Full Flow.....	C-5504				
315L (EXCAVATORS) CAT 3046 T					
Hydraulic Oil Filter.....	HC-9901				
315C L ANF1 (EXCAVATORS) CAT 3150					
Air Filter Primary.....	A-56731				
Air Filter Set.....	A-56731-S				
Air Filter Secondary.....	A-56741				
315D L (EXCAVATORS) CAT C4.2 , 4200, 2011					
Air Filter Primary.....	A-56731				
Air Filter Set.....	A-56731-S				
315D L (EXCAVATORS) CAT C4.2 , 2011					
Air Filter Secondary.....	A-56741				
315D L (EXCAVATORS) CAT C4.2					
Hydraulic Oil Filter.....	HC-9901				
Hydraulic Oil Filter.....	H-55440				
315F LCR (EXCAVATORS) CAT C4.4					
Fuel Filter.....	EF-55050				
316E L (EXCAVATORS) CAT C4.4					
Fuel Filter.....	EF-55050				
Hydraulic Oil Filter.....	H-55440				
316F L (EXCAVATORS) CAT C4.4					
Fuel Filter.....	EF-55050				
317 (EXCAVATORS) CAT 3046 (S/N: 4MM1-UP)					
Air Filter Secondary.....	A-5540				
317 (EXCAVATORS) CAT 3046 (S/N: 5XK484-9970-UP)					
Air Filter Primary.....	A-2706				
Air Filter Secondary.....	A-2705				
Cabin Air Filter.....	CA-55850				
Fuel Filter.....	FC-1010				
Hydraulic Oil Filter.....	H-7942				
Hydraulic Oil Filter.....	HC-5801				
Oil Filter Full Flow.....	C-5504				
317B (EXCAVATORS) CAT S/N: 5XK9971-UP					
Air Filter Secondary.....	A-2705				
Air Filter Primary.....	A-2706				
Cabin Air Filter.....	CA-55850				
Fuel Filter.....	FC-1010				
Hydraulic Oil Filter.....	H-7942				
Hydraulic Oil Filter.....	HC-5801				
Oil Filter Full Flow.....	C-5504				
317B (EXCAVATORS) CAT S/N: 6DZ1-UP					
Air Filter Secondary.....	A-2705				
Air Filter Primary.....	A-2706				
Cabin Air Filter.....	CA-55850				
Fuel Filter.....	FC-1010				
Hydraulic Oil Filter.....	H-7942				
Hydraulic Oil Filter.....	HC-5801				
Oil Filter Full Flow.....	C-5504				
317B (EXCAVATORS) CAT 3046					
Hydraulic Oil Filter.....	HC-9901				
317N (EXCAVATORS) CAT 3046 (S/N: 4MM1-UP)					
Air Filter Secondary.....	A-5540				
Oil Filter Full Flow.....	C-5102				
317N (EXCAVATORS) CAT 3046 (S/N: 9SR1-UP)					
Air Filter Secondary.....	A-5540				
Oil Filter Full Flow.....	C-5102				
317N (EXCAVATORS) CAT 3054T					
Hydraulic Oil Filter.....	HC-9901				
317B L (EXCAVATORS) CAT 3046 (S/N: 6DZ1-UP)					
Air Filter Primary.....	A-2706				
Air Filter Secondary.....	A-2705				
Fuel Filter.....	FC-1010				
Hydraulic Oil Filter.....	HC-5801				
317B L (EXCAVATORS) CAT 3046 (S/N: 9MM1-UP)					
Air Filter Primary.....	A-2706				
Air Filter Secondary.....	A-2705				
Fuel Filter.....	FC-1010				
Hydraulic Oil Filter.....	HC-5801				
317B L (EXCAVATORS) CAT 3046 T					
Hydraulic Oil Filter.....	HC-9901				
318 (EXCAVATORS) CAT 3116DIT					
Air Filter Primary.....	AS-5523				
Air Filter.....	A-5596				
Air Filter Secondary.....	A-7913				
Coolant Filter.....	WC-5707				
Fuel Filter.....	FC-5516				
Fuel Filter Secondary.....	FC-55151				
Fuel Filter Secondary.....	FC-5515				
Oil Filter Full Flow.....	C-5510				
318C (EXCAVATORS) CAT 3066 , 2012					
Air Filter Secondary.....	A-56741				
Air Filter Primary.....	A-56731				
Air Filter Set.....	A-56731-S				
318C (EXCAVATORS) CAT 3066 (S/N: AWS1-UP) , 2004-UP					
Air Filter Secondary.....	A-2705				
Air Filter Primary.....	A-2706				
Cabin Air Filter.....	CA-55850				
Fuel Filter Secondary.....	FC-55151				
Fuel Filter.....	FC-5516				
Fuel Filter Secondary.....	FC-5515				
Hydraulic Oil Filter.....	H-7942				
Hydraulic Oil Filter.....	HC-5801				
Oil Filter Full Flow.....	C-5510				
318C (EXCAVATORS) CAT 3066 (S/N: MDY1-UP) , 2004-UP					
Air Filter Secondary.....	A-2705				
Air Filter Primary.....	A-2706				
Cabin Air Filter.....	CA-55850				
Fuel Filter Secondary.....	FC-55151				
Fuel Filter.....	FC-5516				
Fuel Filter Secondary.....	FC-5515				
Hydraulic Oil Filter.....	H-7942				
Hydraulic Oil Filter.....	HC-5801				
Oil Filter Full Flow.....	C-5510				
318C (EXCAVATORS) CAT 3066T					
Hydraulic Oil Filter.....	HC-9901				
318C (EXCAVATORS) CAT 3066 (S/N: BTG1-UP)					
Air Filter Secondary.....	A-8670				
Air Filter Primary.....	A-5673				
Air Filter Set.....	A-5675-S				

MODEL/APPLICATION	SAKURA NO
CATERPILLAR	
318C (EXCAVATORS) CAT 3066 (S/N: BTG1-UP)	
Fuel Filter Secondary.....	FC-55151
Fuel Filter Secondary.....	FC-5515
Fuel Filter.....	FC-5516
Hydraulic Oil Filter.....	HC-5801
Hydraulic Oil Filter.....	H-7942
Oil Filter Full Flow.....	C-5510
318C (EXCAVATORS) CAT 3066 (S/N: DAH1-UP)	
Air Filter Primary.....	A-5673
Air Filter Set.....	A-5675-S
Air Filter Secondary.....	A-8670
Cabin Air Filter.....	CA-55850
Fuel Filter Secondary.....	FC-55151
Fuel Filter.....	FC-5516
Fuel Filter Secondary.....	FC-5515
Hydraulic Oil Filter.....	HC-5801
Hydraulic Oil Filter.....	H-7942
Oil Filter Full Flow.....	C-5510
318C (EXCAVATORS) CAT 3066 (S/N: GPA1-UP)	
Air Filter Secondary.....	A-2705
Air Filter Primary.....	A-2706
Fuel Filter Secondary.....	FC-55151
Fuel Filter.....	FC-5516
Fuel Filter Secondary.....	FC-5515
Hydraulic Oil Filter.....	HC-5801
Hydraulic Oil Filter.....	H-7942
Oil Filter Full Flow.....	C-5510
318CL (EXCAVATORS) CAT 3066 , 2012	
Air Filter Primary.....	A-56731
Air Filter Secondary.....	A-56741
Air Filter Set.....	A-56731-S
318CL (EXCAVATORS) CAT 3046 (S/N: DAH1-UP)	
Air Filter Secondary.....	A-8670
Air Filter Set.....	A-5675-S
Air Filter Primary.....	A-5673
Fuel Filter Secondary.....	FC-5515
Fuel Filter.....	FC-5516
Fuel Filter Secondary.....	FC-55151
Hydraulic Oil Filter.....	H-7942
Hydraulic Oil Filter.....	HC-5801
Oil Filter Full Flow.....	C-5510
318B (EXCAVATORS) CAT (S/N: 5XK9971-UP)	
Fuel Filter.....	FC-1010
318B (EXCAVATORS) CAT 3046 T	
Hydraulic Oil Filter.....	HC-9901
318B (EXCAVATORS) S/N: 3LR1-UP	
Air Filter Secondary.....	A-2705
Air Filter Primary.....	A-2706
Cabin Air Filter.....	CA-55850

MODEL/APPLICATION	SAKURA NO
CATERPILLAR	
Hydraulic Oil Filter.....	H-7942
Hydraulic Oil Filter.....	HC-5801
Oil Filter Full Flow.....	C-5504
318B (EXCAVATORS) S/N: 7KZ1-UP	
Air Filter Primary.....	A-2706
Air Filter Secondary.....	A-2705
Cabin Air Filter.....	CA-55850
Hydraulic Oil Filter.....	H-7942
Hydraulic Oil Filter.....	HC-5801
Oil Filter Full Flow.....	C-5504
318B (EXCAVATORS) S/N: ADC1-UP	
Air Filter Primary.....	A-2706
Air Filter Secondary.....	A-2705
Cabin Air Filter.....	CA-55850
Hydraulic Oil Filter.....	HC-5801
Hydraulic Oil Filter.....	H-7942
Oil Filter Full Flow.....	C-5504
318B (EXCAVATORS) S/N: AEJ1-UP	
Air Filter Secondary.....	A-2705
Air Filter Primary.....	A-2706
Cabin Air Filter.....	CA-55850
Hydraulic Oil Filter.....	H-7942
Hydraulic Oil Filter.....	HC-5801
Oil Filter Full Flow.....	C-5504
318C LN (EXCAVATORS) CAT 3066 , 2012	
Air Filter Secondary.....	A-56741
Air Filter Primary.....	A-56731
Air Filter Set.....	A-56731-S
318C LN (EXCAVATORS) CAT 3046 (S/N: FAA1-UP)	
Air Filter Secondary.....	A-8670
Air Filter Set.....	A-5675-S
Air Filter Primary.....	A-5673
Fuel Filter Secondary.....	FC-55151
Fuel Filter Secondary.....	FC-5515
Fuel Filter.....	FC-5516
Hydraulic Oil Filter.....	H-7942
Hydraulic Oil Filter.....	HC-5801
Oil Filter Full Flow.....	C-5510
318C BTG1 (EXCAVATORS) CAT 3066	
Air Filter Primary.....	A-56731
Air Filter Set.....	A-56731-S
Air Filter Secondary.....	A-56741
318C DAH1 (EXCAVATORS) CAT 3066	
Air Filter Primary.....	A-56731
Air Filter Secondary.....	A-56741
Air Filter Set.....	A-56731-S
318C L DAH1 (EXCAVATORS) CAT 3046	
Air Filter Set.....	A-56731-S
Air Filter Secondary.....	A-56741
Air Filter Primary.....	A-56731

MODEL/APPLICATION	SAKURA NO
CATERPILLAR	
318C LN FAA1 (EXCAVATORS) CAT 3046	
Air Filter Primary.....	A-56731
Air Filter Set.....	A-56731-S
Air Filter Secondary.....	A-56741
318F L (EXCAVATORS) CAT C4.4	
Fuel Filter.....	EF-55050
318F L (EXCAVATORS)	
Cabin Air Filter.....	CA-55170
Cabin Air Filter.....	CAC-55170
Cabin Air Filter.....	CAV-55170
318E L (EXCAVATORS) CAT C4.4	
Fuel Filter.....	EF-55050
Hydraulic Oil Filter.....	H-55440
318D L (EXCAVATORS) CAT C4.2	
Hydraulic Oil Filter.....	H-55440
318D2 L (EXCAVATORS) CAT 3054C	
Hydraulic Oil Filter.....	H-55440
319C (EXCAVATORS) CAT 3066T	
Hydraulic Oil Filter.....	HC-9901
319C (EXCAVATORS) CAT S/N: 7JK1-UP	
Air Filter Primary.....	A-8508
Air Filter Secondary.....	A-8578
Air Filter Primary.....	A-5673
Air Filter Primary.....	AS-8577
Air Filter Primary.....	A-8508M
Air Filter Secondary.....	A-8670
Air Filter Set.....	A-5675-S
Air Filter Set.....	A-8604-S
Air Filter Set.....	A-8508M-S
Air Filter Secondary.....	A-8507
Cabin Air Filter.....	CA-55850
Fuel Filter Secondary.....	FC-55151
Fuel Filter.....	FC-5516
Fuel Filter.....	FC-1010
Fuel Filter Secondary.....	FC-5515
Hydraulic Oil Filter.....	H-5522
Hydraulic Oil Filter.....	HC-5801
Hydraulic Oil Filter.....	HC-55170
Oil Filter Full Flow.....	C-5522
Oil Filter Full Flow.....	C-5510
319C (EXCAVATORS) CAT S/N: KGL1-UP	
Air Filter Primary.....	AS-8577
Air Filter Primary.....	A-8508M
Air Filter Secondary.....	A-8578
Air Filter Set.....	A-8508M-S
Air Filter Set.....	A-5675-S
Air Filter Primary.....	A-5673
Air Filter Secondary.....	A-8670

MODEL/APPLICATION	SAKURA NO
CATERPILLAR	
319C (EXCAVATORS) CAT S/N: KGL1-UP	
Air Filter Secondary.....	A-8507
Air Filter Primary.....	A-8508
Air Filter Set.....	A-8604-S
Cabin Air Filter.....	CA-55850
Fuel Filter Secondary.....	FC-55151
Fuel Filter Secondary.....	FC-5515
Fuel Filter.....	FC-5516
Fuel Filter.....	FC-1010
Hydraulic Oil Filter.....	H-5522
Hydraulic Oil Filter.....	HC-5801
Hydraulic Oil Filter.....	HC-55170
Oil Filter Full Flow.....	C-5510
Oil Filter Full Flow.....	C-5522
319C (EXCAVATORS) CAT 7JK1-UP	
Air Filter Secondary.....	A-56741
Air Filter Set.....	A-56731-S
Air Filter Primary.....	A-56731
319D (EXCAVATORS) CAT C4.2 , 4200, 2011	
Air Filter Primary.....	A-56731
Air Filter Set.....	A-56731-S
Air Filter Secondary.....	A-56741
319D (EXCAVATORS) CAT C4.2 ACERT	
Hydraulic Oil Filter.....	HC-9901
319C LN (EXCAVATORS) CAT 3066 , 2012	
Air Filter Primary.....	A-56731
Air Filter Set.....	A-56731-S
Air Filter Secondary.....	A-56741
319D LN (EXCAVATORS)	
Cabin Air Filter.....	CAV-55170
Cabin Air Filter.....	CAC-55170
Cabin Air Filter.....	CA-55170
319D L (EXCAVATORS) CAT C4.2	
Hydraulic Oil Filter.....	H-55440
320 (EXCAVATORS) CAT 3066 (S/N: 3RK1-UP)	
Air Filter Set.....	A-6118-S
Air Filter Primary.....	A-6006
Air Filter Secondary.....	A-6007
Cabin Air Filter.....	CA-55850
Fuel Filter.....	F-5505
Hydraulic Oil Filter.....	H-5505
Oil Filter Full Flow.....	C-5510
320 (EXCAVATORS) CAT 3066 (S/N: 7WK1-UP)	
Air Filter Primary.....	A-6006
Air Filter Set.....	A-6118-S
Air Filter Secondary.....	A-6007
Cabin Air Filter.....	CA-55850
Fuel Filter.....	F-5505

MODEL/APPLICATION	SAKURA NO
CATERPILLAR	
Hydraulic Oil Filter.....	H-5505
Oil Filter Full Flow.....	C-5510
320 (EXCAVATORS) CAT 3066 (S/N: 8LK1-UP)	
Air Filter Set.....	A-6118-S
Air Filter Secondary.....	A-6007
Air Filter Primary.....	A-6006
Cabin Air Filter.....	CA-55850
Fuel Filter.....	F-5505
Fuel Filter.....	FC-1010
Hydraulic Oil Filter.....	H-5505
Oil Filter Combination.....	C-7916
320 (EXCAVATORS) CAT 3116 (S/N: 1KL1-UP)	
Air Filter Secondary.....	A-6007
Air Filter Set.....	A-6118-S
Air Filter Primary.....	A-6006
Hydraulic Oil Filter.....	H-5505
Hydraulic Oil Filter.....	HC-5801
Hydraulic Oil Filter.....	HC-5505
Oil Filter Combination.....	C-7916
Oil Filter Full Flow.....	C-5510
320 (EXCAVATORS) CAT 3116 (S/N: 1XM1-UP)	
Air Filter Secondary.....	A-6007
Air Filter Set.....	A-6118-S
Air Filter Primary.....	A-6006
Fuel Filter.....	FC-1010
Hydraulic Oil Filter.....	HC-5505
Hydraulic Oil Filter.....	H-5505
Oil Filter Combination.....	C-7916
Oil Filter Full Flow.....	C-5510
320 (EXCAVATORS) CAT 3116 (S/N: 2DL1-UP)	
Air Filter Set.....	A-6118-S
Air Filter Primary.....	A-6006
Air Filter Secondary.....	A-6007
Fuel Filter.....	FC-1010
Hydraulic Oil Filter.....	HC-5505
Hydraulic Oil Filter.....	H-5505
Oil Filter Full Flow.....	C-5510
Oil Filter Combination.....	C-7916
320 (EXCAVATORS) CAT 3116 (S/N: 2DL-UP)	
Air Filter Secondary.....	A-6007
Air Filter Set.....	A-6118-S
Air Filter Primary.....	A-6006
Fuel Filter Secondary.....	FC-55151
Fuel Filter.....	F-5505
Fuel Filter.....	FC-5516
Fuel Filter Secondary.....	FC-5515
Hydraulic Oil Filter.....	H-5505
Hydraulic Oil Filter.....	HC-5505
Oil Filter Full Flow.....	C-5510
320 (EXCAVATORS) CAT 3116 (S/N: 3RK-UP)	
Air Filter Secondary.....	A-6007
Air Filter Set.....	A-6118-S
Air Filter Primary.....	A-6006

MODEL/APPLICATION	SAKURA NO
CATERPILLAR	
Fuel Filter.....	FC-5516
Fuel Filter Secondary.....	FC-5515
Fuel Filter Secondary.....	FC-55151
Fuel Filter.....	F-5505
Hydraulic Oil Filter.....	HC-5505
Hydraulic Oil Filter.....	H-5505
Oil Filter Full Flow.....	C-5510
320 (EXCAVATORS) CAT 3116 (S/N: 3XK822-UP)	
Air Filter Primary.....	A-6006
Air Filter Secondary.....	A-6007
Air Filter Set.....	A-6118-S
Fuel Filter.....	FC-5516
Fuel Filter.....	F-5505
Fuel Filter Secondary.....	FC-5515
Fuel Filter.....	FC-5508
Fuel Filter Secondary.....	FC-55151
Hydraulic Oil Filter.....	HC-5505
Hydraulic Oil Filter.....	H-5505
Oil Filter Full Flow.....	C-5510
320 (EXCAVATORS) CAT 3116 (S/N: 3XM-UP)	
Air Filter Set.....	A-6118-S
Air Filter Secondary.....	A-6007
Air Filter Primary.....	A-6006
Fuel Filter Secondary.....	FC-5515
Fuel Filter.....	F-5505
Fuel Filter Secondary.....	FC-55151
Fuel Filter.....	FC-5516
Hydraulic Oil Filter.....	HC-5505
Hydraulic Oil Filter.....	H-5505
Oil Filter Full Flow.....	C-5510
320 (EXCAVATORS) CAT 3116 (S/N: 4ZJ460-UP)	
Air Filter Primary.....	A-6006
Air Filter Set.....	A-6118-S
Air Filter Secondary.....	A-6007
Fuel Filter.....	FC-5508
Fuel Filter.....	FC-5516
Fuel Filter Secondary.....	FC-55151
Fuel Filter.....	F-5505
Fuel Filter Secondary.....	FC-5515
Hydraulic Oil Filter.....	H-5505
Hydraulic Oil Filter.....	HC-5505
Oil Filter Full Flow.....	C-5510
320 (EXCAVATORS) CAT 3116 (S/N: 4ZJ-UP)	
Air Filter Primary.....	A-6006
Air Filter Set.....	A-6118-S
Air Filter Secondary.....	A-6007
Fuel Filter Secondary.....	FC-5515
Fuel Filter.....	FC-5516
Fuel Filter Secondary.....	FC-55151
Fuel Filter.....	F-5505
Fuel Filter Secondary.....	FC-5515
Hydraulic Oil Filter.....	H-5505
Hydraulic Oil Filter.....	HC-5505
Oil Filter Full Flow.....	C-5510

MODEL/APPLICATION	SAKURA NO
-------------------	-----------

CATERPILLAR

320
(EXCAVATORS)
CAT 3116 (S/N: 6KM1-UP)

Air Filter Secondary.....	A-6007
Air Filter Set.....	A-6118-S
Air Filter Primary.....	A-6006
Fuel Filter Secondary.....	FC-55151
Fuel Filter Secondary.....	FC-5515
Fuel Filter.....	FC-5516
Fuel Filter.....	F-5505
Fuel Filter.....	FC-5508
Hydraulic Oil Filter.....	H-5505
Hydraulic Oil Filter.....	HC-5505
Oil Filter Full Flow.....	C-5510

320
(EXCAVATORS)
CAT 3116 (S/N: 7WK-UP)

Air Filter Set.....	A-6118-S
Air Filter Secondary.....	A-6007
Air Filter Primary.....	A-6006
Fuel Filter.....	FC-5516
Fuel Filter.....	F-5505
Fuel Filter Secondary.....	FC-55151
Fuel Filter Secondary.....	FC-5515
Hydraulic Oil Filter.....	HC-5505
Hydraulic Oil Filter.....	H-5505
Oil Filter Full Flow.....	C-5510

320
(EXCAVATORS)
CAT 3116 (S/N: 8HL-UP)

Air Filter Primary.....	A-6006
Air Filter Set.....	A-6118-S
Air Filter Secondary.....	A-6007
Fuel Filter Secondary.....	FC-55151
Fuel Filter.....	FC-5516
Fuel Filter Secondary.....	FC-5515
Fuel Filter.....	F-5505
Hydraulic Oil Filter.....	HC-5505
Hydraulic Oil Filter.....	H-5505
Oil Filter Full Flow.....	C-5510

320
(EXCAVATORS)
CAT 3116 (S/N: 8LK1-UP)

Air Filter Secondary.....	A-6007
Air Filter Set.....	A-6118-S
Air Filter Primary.....	A-6006
Hydraulic Oil Filter.....	H-5505
Hydraulic Oil Filter.....	HC-5505
Hydraulic Oil Filter.....	HC-5801
Oil Filter Combination.....	C-7916
Oil Filter Full Flow.....	C-5510

320
(EXCAVATORS)
CAT 3116 (S/N: 8LK-UP)

Air Filter Set.....	A-6118-S
Air Filter Secondary.....	A-6007
Air Filter Primary.....	A-6006
Fuel Filter Secondary.....	FC-5515
Fuel Filter.....	F-5505
Fuel Filter.....	FC-5516
Fuel Filter Secondary.....	FC-55151
Hydraulic Oil Filter.....	HC-5505
Hydraulic Oil Filter.....	H-5505
Oil Filter Full Flow.....	C-5510

MODEL/APPLICATION	SAKURA NO
-------------------	-----------

CATERPILLAR

320
(EXCAVATORS)
CAT 3116 (S/N: 9KK1-UP)

Air Filter Set.....	A-6118-S
Air Filter Primary.....	A-6006
Air Filter Secondary.....	A-6007
Fuel Filter.....	FC-1010
Hydraulic Oil Filter.....	H-5505
Hydraulic Oil Filter.....	HC-5505
Oil Filter Full Flow.....	C-5510
Oil Filter Combination.....	C-7916

320
(EXCAVATORS)
CAT 3116 (S/N: 9WG723-UP)

Air Filter Secondary.....	A-6007
Air Filter Primary.....	A-6006
Air Filter Set.....	A-6118-S
Fuel Filter Secondary.....	FC-55151
Fuel Filter.....	FC-5516
Fuel Filter Secondary.....	FC-5515
Fuel Filter.....	F-5505
Fuel Filter.....	FC-5508
Hydraulic Oil Filter.....	HC-5505
Hydraulic Oil Filter.....	H-5505
Oil Filter Full Flow.....	C-5510

320
(EXCAVATORS)
CAT 3066

Air Filter Secondary.....	A-6007
Oil Filter Full Flow.....	C-7105

320B
(EXCAVATORS)
7JK1-ON

Oil Filter Full Flow.....	C-5506
---------------------------	--------

320B
(EXCAVATORS)
CAT 3116 (S/N: 1XS1-UP)

Air Filter Secondary.....	A-8507
Air Filter Set.....	A-8508M-S
Air Filter Set.....	A-8604-S
Air Filter Primary.....	A-8508
Air Filter Primary.....	A-5549
Air Filter Primary.....	A-5549M
Air Filter Secondary.....	A-5550
Air Filter Set.....	A-5549M-S
Air Filter Primary.....	A-8508M
Fuel Filter.....	FC-5516
Fuel Filter.....	FC-5508
Fuel Filter Secondary.....	FC-5515
Fuel Filter Secondary.....	FC-55151
Hydraulic Oil Filter.....	HC-5505
Hydraulic Oil Filter.....	H-7942
Hydraulic Oil Filter.....	HC-5801
Oil Filter Full Flow.....	C-5510

320B
(EXCAVATORS)
CAT 3116 (S/N: 2AS1-UP)

Air Filter Primary.....	A-5549
Air Filter Secondary.....	A-8507
Air Filter Primary.....	A-8508
Air Filter Primary.....	A-8508M
Air Filter Primary.....	A-5549M
Air Filter Set.....	A-8604-S
Air Filter Secondary.....	A-5550

MODEL/APPLICATION	SAKURA NO
-------------------	-----------

CATERPILLAR

Air Filter Set.....	A-8508M-S
Air Filter Set.....	A-5549M-S
Fuel Filter.....	FC-5516
Fuel Filter.....	FC-5508
Fuel Filter Secondary.....	FC-55151
Fuel Filter Secondary.....	FC-5515
Hydraulic Oil Filter.....	HC-5505
Hydraulic Oil Filter.....	H-7942
Hydraulic Oil Filter.....	HC-5801
Oil Filter Full Flow.....	C-5510

320B
(EXCAVATORS)
CAT 3116 (S/N: 3YZ1-UP)

Air Filter Primary.....	A-8508
Air Filter Set.....	A-8604-S
Air Filter Set.....	A-8508M-S
Air Filter Secondary.....	A-8507
Air Filter Primary.....	A-8508M
Fuel Filter.....	FC-5508
Fuel Filter Secondary.....	FC-55151
Fuel Filter Secondary.....	FC-5515
Fuel Filter.....	FC-5516
Hydraulic Oil Filter.....	HC-5505
Hydraulic Oil Filter.....	HC-5801
Hydraulic Oil Filter.....	H-7942
Oil Filter Full Flow.....	C-5510

320B
(EXCAVATORS)
CAT 3116 (S/N: 4XW1-UP)

Air Filter Primary.....	A-8508M
Air Filter Set.....	A-8508M-S
Air Filter Set.....	A-8604-S
Air Filter Secondary.....	A-8507
Air Filter Primary.....	A-8508
Fuel Filter Secondary.....	FC-5515
Fuel Filter Secondary.....	FC-55151
Fuel Filter.....	FC-1010
Fuel Filter.....	FC-5516
Hydraulic Oil Filter.....	H-7942
Hydraulic Oil Filter.....	HC-5505
Hydraulic Oil Filter.....	HC-5801
Oil Filter Full Flow.....	C-5510

320B
(EXCAVATORS)
CAT 3116 (S/N: 5BR1-UP)

Air Filter Primary.....	A-8508
Air Filter Secondary.....	A-5550
Air Filter Set.....	A-8508M-S
Air Filter Set.....	A-8604-S
Air Filter Primary.....	A-8508M
Air Filter Secondary.....	A-8507
Air Filter Primary.....	A-5549
Air Filter Set.....	A-5549M-S
Air Filter Primary.....	A-5549M
Fuel Filter.....	FC-1010
Hydraulic Oil Filter.....	HC-5801
Hydraulic Oil Filter.....	H-7942
Hydraulic Oil Filter.....	HC-5505
Oil Filter Full Flow.....	C-5510

320B
(EXCAVATORS)
CAT 3116 (S/N: 5GW1-UP)

Air Filter Set.....	A-8604-S
---------------------	----------

MODEL/APPLICATION	SAKURA NO
-------------------	-----------

CATERPILLAR

320B
(EXCAVATORS)
CAT 3116 (S/N: 5GW1-UP)

Air Filter Set.....	A-8508M-S
Air Filter Primary.....	A-8508
Air Filter Primary.....	A-8508M
Air Filter Secondary.....	A-8507
Fuel Filter.....	FC-1010
Fuel Filter.....	FC-5516
Fuel Filter Secondary.....	FC-5515
Fuel Filter Secondary.....	FC-55151
Hydraulic Oil Filter.....	HC-5801
Hydraulic Oil Filter.....	H-7942
Hydraulic Oil Filter.....	HC-5505
Oil Filter Full Flow.....	C-5510

320B
(EXCAVATORS)
CAT 3116 (S/N: 5MS1-UP)

Air Filter Set.....	A-8604-S
Air Filter Set.....	A-8508M-S
Air Filter Primary.....	A-8508
Air Filter Secondary.....	A-8507
Air Filter Primary.....	A-8508M
Fuel Filter.....	FC-5516
Fuel Filter Secondary.....	FC-55151
Fuel Filter.....	FC-5508
Fuel Filter Secondary.....	FC-5515
Hydraulic Oil Filter.....	HC-5505
Hydraulic Oil Filter.....	H-7942
Hydraulic Oil Filter.....	HC-5801
Oil Filter Full Flow.....	C-5510

320B
(EXCAVATORS)
CAT 3116 (S/N: 6CR1-UP)

Air Filter Secondary.....	A-5550
Air Filter Primary.....	A-8508M
Air Filter Set.....	A-5549M-S
Air Filter Set.....	A-8508M-S
Air Filter Set.....	A-8604-S
Air Filter Primary.....	A-5549
Air Filter Primary.....	A-8508
Air Filter Primary.....	A-5549M
Air Filter Secondary.....	A-8507
Fuel Filter.....	FC-1010
Hydraulic Oil Filter.....	HC-5801
Hydraulic Oil Filter.....	H-7942
Hydraulic Oil Filter.....	HC-5505
Oil Filter Full Flow.....	C-5510

320B
(EXCAVATORS)
CAT 3116 (S/N: 6LW1-UP)

Air Filter Primary.....	A-8508M
Air Filter Secondary.....	A-8507
Air Filter Set.....	A-8508M-S
Air Filter Set.....	A-8604-S
Air Filter Primary.....	A-8508
Fuel Filter.....	FC-5516
Fuel Filter Secondary.....	FC-5515
Fuel Filter Secondary.....	FC-55151
Fuel Filter.....	FC-5508
Hydraulic Oil Filter.....	H-7942
Hydraulic Oil Filter.....	HC-5801
Hydraulic Oil Filter.....	HC-5505

MODEL/APPLICATION	SAKURA NO
-------------------	-----------

CATERPILLAR

320B
(EXCAVATORS)
CAT 3116 (S/N: 7JR1-UP)

Oil Filter Full Flow.....	C-5510
Air Filter Set.....	A-8508M-S
Air Filter Set.....	A-8604-S
Air Filter Secondary.....	A-8507
Air Filter Primary.....	A-8508
Air Filter Primary.....	A-8508M
Air Filter Secondary.....	A-5550
Air Filter Primary.....	A-5549M
Air Filter Set.....	A-5549M-S
Air Filter Primary.....	A-5549
Fuel Filter.....	FC-5508
Fuel Filter Secondary.....	FC-5515
Fuel Filter Secondary.....	FC-55151
Fuel Filter.....	FC-5516
Hydraulic Oil Filter.....	HC-5505
Hydraulic Oil Filter.....	HC-5801
Hydraulic Oil Filter.....	H-7942
Oil Filter Full Flow.....	C-5510

320B
(EXCAVATORS)
CAT 3116 (S/N: 9WS1-UP)

Air Filter Primary.....	A-5549
Air Filter Primary.....	A-8508
Air Filter Set.....	A-5549M-S
Air Filter Primary.....	A-8508M
Air Filter Secondary.....	A-5550
Air Filter Primary.....	A-5549M
Air Filter Secondary.....	A-8507
Air Filter Set.....	A-8508M-S
Air Filter Set.....	A-8604-S
Fuel Filter Secondary.....	FC-5515
Fuel Filter.....	FC-5516
Fuel Filter Secondary.....	FC-55151
Fuel Filter.....	FC-5508
Hydraulic Oil Filter.....	HC-5801
Hydraulic Oil Filter.....	H-7942
Hydraulic Oil Filter.....	HC-5505
Oil Filter Full Flow.....	C-5510

320BL
(EXCAVATORS)
CAT 3066 (S/N: 5BR1-UP)

Air Filter Primary.....	A-8508
Air Filter Secondary.....	A-8507
Air Filter Set.....	A-8604-S
Air Filter Set.....	A-8508M-S
Air Filter Primary.....	A-8508M
Fuel Filter.....	FC-1010

320BL
(EXCAVATORS)
CAT 3066 (S/N: 6CR1-UP)

Air Filter Primary.....	A-8508M
Air Filter Set.....	A-8508M-S
Air Filter Secondary.....	A-8507
Air Filter Set.....	A-8604-S
Air Filter Primary.....	A-8508
Fuel Filter.....	FC-1010

320BL
(EXCAVATORS)
CAT 3116 S/N: 4TF67498-UP

Air Filter Set.....	A-8508M-S
Air Filter Set.....	A-8604-S

MODEL/APPLICATION	SAKURA NO
-------------------	-----------

CATERPILLAR

Air Filter Primary.....	A-8508M
Air Filter Primary.....	A-8508
Air Filter Secondary.....	A-8507
Fuel Filter Secondary.....	FC-55151
Fuel Filter.....	FC-5516
Fuel Filter.....	FC-5508
Fuel Filter Secondary.....	FC-5515
Hydraulic Oil Filter.....	H-7942
Hydraulic Oil Filter.....	HC-5801
Hydraulic Oil Filter.....	HC-5505
Oil Filter Full Flow.....	C-5510

320BL
(EXCAVATORS)
CAT 3116 S/N: 7JR3036-UP

Air Filter Set.....	A-8604-S
Air Filter Primary.....	A-8508M
Air Filter Primary.....	A-8508
Air Filter Set.....	A-8508M-S
Air Filter Secondary.....	A-8507
Fuel Filter Secondary.....	FC-5515
Fuel Filter Secondary.....	FC-55151
Fuel Filter.....	FC-5508
Fuel Filter.....	FC-5516
Hydraulic Oil Filter.....	HC-5505
Hydraulic Oil Filter.....	HC-5801
Hydraulic Oil Filter.....	H-7942
Oil Filter Full Flow.....	C-5510

320BL
(EXCAVATORS)
S/N: 7JR1954-UP

Air Filter Set.....	A-8508M-S
Air Filter Secondary.....	A-8507
Air Filter Set.....	A-8604-S
Air Filter Primary.....	A-8508M
Air Filter Primary.....	A-8508
Cabin Air Filter.....	CA-55850
Fuel Filter.....	FC-5508
Fuel Filter Secondary.....	FC-55151
Fuel Filter Secondary.....	FC-5515
Fuel Filter.....	FC-5516
Hydraulic Oil Filter.....	HC-5505
Hydraulic Oil Filter.....	H-7942
Oil Filter Full Flow.....	C-5510

320BL
(EXCAVATORS)
S/N: 7JR1960-UP

Air Filter Primary.....	A-8508
Air Filter Set.....	A-8604-S
Air Filter Set.....	A-8508M-S
Air Filter Primary.....	A-8508M
Air Filter Secondary.....	A-8507
Cabin Air Filter.....	CA-55850
Fuel Filter.....	FC-5508
Fuel Filter Secondary.....	FC-5515
Fuel Filter.....	FC-5516
Fuel Filter Secondary.....	FC-55151
Hydraulic Oil Filter.....	H-7942
Hydraulic Oil Filter.....	HC-5505
Oil Filter Full Flow.....	C-5510

320BL
(EXCAVATORS)
S/N: 7JR2461-UP

Air Filter Primary.....	A-8508
-------------------------	--------

MODEL/APPLICATION	SAKURA NO
CATERPILLAR	
320BL (EXCAVATORS) S/N: 73R2461-UP	
Air Filter Set.....	A-8508M-S
Air Filter Secondary.....	A-8507
Air Filter Set.....	A-8604-S
Air Filter Primary.....	A-8508M
Cabin Air Filter.....	CA-55850
Fuel Filter.....	FC-5508
Fuel Filter Secondary.....	FC-55151
Fuel Filter Secondary.....	FC-5515
Fuel Filter.....	FC-5516
Hydraulic Oil Filter.....	H-7942
Hydraulic Oil Filter.....	HC-5505
Oil Filter Full Flow.....	C-5510
320C (EXCAVATORS) CAT 3066T	
Hydraulic Oil Filter.....	HC-9901
320C (EXCAVATORS) CAT 3066 (S/N: AKH1-UP)	
Air Filter Set.....	A-8604-S
Air Filter Secondary.....	A-8507
Air Filter Primary.....	A-5549M
Air Filter Primary.....	A-5549
Air Filter Set.....	A-5549M-S
Air Filter Primary.....	A-8508
Air Filter Set.....	A-8508M-S
Air Filter Secondary.....	A-5550
Air Filter Primary.....	A-8508M
Cabin Air Filter.....	CA-55850
Fuel Filter.....	FC-5516
Fuel Filter Secondary.....	FC-5515
Fuel Filter Secondary.....	FC-55151
Hydraulic Oil Filter.....	HC-5801
Hydraulic Oil Filter.....	H-7942
Hydraulic Oil Filter.....	H-5522
Oil Filter Full Flow.....	C-5510
320C (EXCAVATORS) CAT 3066 (S/N: ALF1-UP)	
Air Filter Primary.....	A-5549M
Air Filter Set.....	A-5549M-S
Air Filter Primary.....	A-8508
Air Filter Primary.....	A-8508M
Air Filter Secondary.....	A-5550
Air Filter Set.....	A-8508M-S
Air Filter Primary.....	A-5549
Air Filter Secondary.....	A-8507
Air Filter Set.....	A-8604-S
Cabin Air Filter.....	CA-55850
Fuel Filter Secondary.....	FC-55151
Fuel Filter.....	FC-5516
Fuel Filter Secondary.....	FC-5515
Hydraulic Oil Filter.....	HC-5801
Hydraulic Oil Filter.....	H-7942
Hydraulic Oil Filter.....	H-5522
Oil Filter Full Flow.....	C-5510
320C (EXCAVATORS) CAT 3066 (S/N: AMC1-UP)	
Air Filter Set.....	A-8508M-S
Air Filter Primary.....	A-8508M

MODEL/APPLICATION	SAKURA NO
CATERPILLAR	
Air Filter Secondary.....	A-5550
Air Filter Secondary.....	A-8507
Air Filter Primary.....	A-8508
Air Filter Primary.....	A-5549M
Air Filter Set.....	A-8604-S
Air Filter Primary.....	A-5549
Air Filter Set.....	A-5549M-S
Fuel Filter Secondary.....	FC-55151
Fuel Filter.....	FC-5516
Fuel Filter Secondary.....	FC-5515
Hydraulic Oil Filter.....	H-7942
Hydraulic Oil Filter.....	HC-5801
Oil Filter Full Flow.....	C-5510
320C (EXCAVATORS) CAT 3066 (S/N: ANB1-UP)	
Air Filter Set.....	A-8604-S
Air Filter Set.....	A-8508M-S
Air Filter Set.....	A-5549M-S
Air Filter Primary.....	A-8508
Air Filter Secondary.....	A-5550
Air Filter Secondary.....	A-8507
Air Filter Primary.....	A-5549M
Air Filter Primary.....	A-5549
Air Filter Primary.....	A-8508M
Fuel Filter Secondary.....	FC-5515
Fuel Filter.....	FC-5516
Fuel Filter Secondary.....	FC-55151
Hydraulic Oil Filter.....	HC-5801
Hydraulic Oil Filter.....	H-7942
Oil Filter Full Flow.....	C-5510
320C (EXCAVATORS) CAT 3066 (S/N: BBC1-UP)	
Air Filter Secondary.....	A-8507
Air Filter Primary.....	A-8508M
Air Filter Set.....	A-8604-S
Air Filter Primary.....	A-8508
Air Filter Set.....	A-8508M-S
Fuel Filter Secondary.....	FC-55151
Fuel Filter.....	FC-5516
Fuel Filter Secondary.....	FC-5515
Hydraulic Oil Filter.....	HC-5801
Hydraulic Oil Filter.....	H-7942
Oil Filter Full Flow.....	C-5510
320C (EXCAVATORS) CAT 3066 (S/N: BCN1-UP)	
Air Filter Primary.....	A-8508M
Air Filter Primary.....	A-8508
Air Filter Set.....	A-8508M-S
Air Filter Set.....	A-8604-S
Air Filter Secondary.....	A-8507
Fuel Filter Secondary.....	FC-55151
Fuel Filter Secondary.....	FC-5515
Fuel Filter.....	FC-5516
Hydraulic Oil Filter.....	H-7942
Hydraulic Oil Filter.....	HC-5801
Oil Filter Full Flow.....	C-5510
320C (EXCAVATORS) CAT 3066 (S/N: BDC1-UP)	
Air Filter Primary.....	A-8508

MODEL/APPLICATION	SAKURA NO
CATERPILLAR	
Air Filter Set.....	A-8604-S
Air Filter Primary.....	A-8508M
Air Filter Secondary.....	A-8507
Air Filter Set.....	A-8508M-S
Cabin Air Filter.....	CA-55850
Fuel Filter Secondary.....	FC-55151
Fuel Filter.....	FC-5516
Fuel Filter Secondary.....	FC-5515
Hydraulic Oil Filter.....	H-7942
Hydraulic Oil Filter.....	HC-5801
Oil Filter Full Flow.....	C-5510
320C (EXCAVATORS) CAT 3066 (S/N: BDE1-UP)	
Air Filter Set.....	A-8508M-S
Air Filter Primary.....	A-8508
Air Filter Secondary.....	A-8507
Air Filter Set.....	A-8604-S
Air Filter Primary.....	A-8508M
Fuel Filter Secondary.....	FC-5515
Fuel Filter.....	FC-5516
Fuel Filter Secondary.....	FC-55151
Hydraulic Oil Filter.....	H-7942
Hydraulic Oil Filter.....	HC-5801
Oil Filter Full Flow.....	C-5510
320C (EXCAVATORS) CAT 3066 (S/N: BEA1-UP)	
Air Filter Set.....	A-8604-S
Air Filter Primary.....	A-8508M
Air Filter Set.....	A-8508M-S
Air Filter Secondary.....	A-8507
Air Filter Primary.....	A-8508
Fuel Filter Secondary.....	FC-55151
Fuel Filter.....	FC-5516
Fuel Filter Secondary.....	FC-5515
Hydraulic Oil Filter.....	HC-5801
Hydraulic Oil Filter.....	H-7942
Oil Filter Full Flow.....	C-5510
320C (EXCAVATORS) CAT 3066 (S/N: BEF1-UP)	
Air Filter Set.....	A-8604-S
Air Filter Primary.....	A-8508M
Air Filter Secondary.....	A-8507
Air Filter Primary.....	A-8508
Air Filter Set.....	A-8508M-S
Fuel Filter Secondary.....	FC-55151
Fuel Filter.....	FC-5516
Fuel Filter Secondary.....	FC-5515
Hydraulic Oil Filter.....	HC-5801
Hydraulic Oil Filter.....	H-7942
Oil Filter Full Flow.....	C-5510
320C (EXCAVATORS) CAT 3066 (S/N: BER1-UP)	
Air Filter Primary.....	A-8508M
Air Filter Set.....	A-8604-S
Air Filter Set.....	A-8508M-S
Air Filter Secondary.....	A-8507
Air Filter Primary.....	A-8508
Fuel Filter Secondary.....	FC-5515
Fuel Filter.....	FC-5516

MODEL/APPLICATION	SAKURA NO
CATERPILLAR	
320C (EXCAVATORS) CAT 3066 (S/N: BER1-UP)	
Fuel Filter Secondary.....	FC-55151
Hydraulic Oil Filter.....	HC-5801
Hydraulic Oil Filter.....	H-7942
Oil Filter Full Flow.....	C-5510
320C (EXCAVATORS) CAT 3066 (S/N: BGB1-UP)	
Air Filter Primary.....	A-8508
Air Filter Set.....	A-8508M-S
Air Filter Set.....	A-8604-S
Air Filter Primary.....	A-8508M
Air Filter Secondary.....	A-8507
Cabin Air Filter.....	CA-55850
Fuel Filter.....	FC-5516
Fuel Filter Secondary.....	FC-55151
Fuel Filter Secondary.....	FC-5515
Hydraulic Oil Filter.....	H-7942
Hydraulic Oil Filter.....	HC-5801
Oil Filter Full Flow.....	C-5510
320C (EXCAVATORS) CAT 3066 (S/N: BKK1-UP)	
Air Filter Primary.....	A-8508
Air Filter Set.....	A-8604-S
Air Filter Set.....	A-8508M-S
Air Filter Secondary.....	A-8507
Air Filter Primary.....	A-8508M
Cabin Air Filter.....	CA-55850
Fuel Filter.....	FC-5516
Fuel Filter Secondary.....	FC-5515
Fuel Filter Secondary.....	FC-55151
Hydraulic Oil Filter.....	HC-5801
Hydraulic Oil Filter.....	H-7942
Oil Filter Full Flow.....	C-5510
320C (EXCAVATORS) CAT 3066 (S/N: BPR1-UP)	
Air Filter Set.....	A-8604-S
Air Filter Primary.....	A-8508
Air Filter Set.....	A-8508M-S
Air Filter Secondary.....	A-8507
Air Filter Primary.....	A-8508M
Cabin Air Filter.....	CA-55850
Fuel Filter.....	FC-5516
Fuel Filter Secondary.....	FC-5515
Fuel Filter Secondary.....	FC-55151
Hydraulic Oil Filter.....	HC-5801
Hydraulic Oil Filter.....	H-7942
Oil Filter Full Flow.....	C-5510
320C (EXCAVATORS) CAT 3066 (S/N: BRX1-UP)	
Air Filter Primary.....	A-8508M
Air Filter Set.....	A-8604-S
Air Filter Primary.....	A-8508
Air Filter Set.....	A-8508M-S
Air Filter Secondary.....	A-8507
Fuel Filter Secondary.....	FC-5515
Fuel Filter Secondary.....	FC-55151
Fuel Filter.....	FC-5516
Hydraulic Oil Filter.....	HC-5801

MODEL/APPLICATION	SAKURA NO
CATERPILLAR	
Hydraulic Oil Filter.....	H-7942
Oil Filter Full Flow.....	C-5510
320C (EXCAVATORS) CAT 3066 (S/N: CLM1-UP)	
Air Filter Primary.....	A-8508M
Air Filter Primary.....	A-8508
Air Filter Set.....	A-8604-S
Air Filter Secondary.....	A-8507
Air Filter Set.....	A-8508M-S
Cabin Air Filter.....	CA-55850
Fuel Filter.....	FC-5516
Fuel Filter Secondary.....	FC-5515
Fuel Filter Secondary.....	FC-55151
Hydraulic Oil Filter.....	HC-5801
Hydraulic Oil Filter.....	H-7942
Oil Filter Full Flow.....	C-5510
320C (EXCAVATORS) CAT 3066 (S/N: CLZ1-UP)	
Air Filter Primary.....	A-8508M
Air Filter Secondary.....	A-8507
Air Filter Primary.....	A-8508
Air Filter Set.....	A-8604-S
Air Filter Set.....	A-8508M-S
Cabin Air Filter.....	CA-55850
Fuel Filter Secondary.....	FC-55151
Fuel Filter Secondary.....	FC-5515
Fuel Filter.....	FC-5516
Hydraulic Oil Filter.....	HC-5801
Hydraulic Oil Filter.....	H-7942
Oil Filter Full Flow.....	C-5510
320C (EXCAVATORS) CAT 3066 (S/N: DBG1-UP)	
Air Filter Set.....	A-5549M-S
Air Filter Primary.....	A-5549
Air Filter Secondary.....	A-5550
Air Filter Primary.....	A-5549M
Cabin Air Filter.....	CA-55850
Fuel Filter Secondary.....	FC-5515
Fuel Filter Secondary.....	FC-55151
Fuel Filter.....	FC-5516
Hydraulic Oil Filter.....	HC-5801
Hydraulic Oil Filter.....	H-5522
Oil Filter Full Flow.....	C-5510
320C (EXCAVATORS) CAT 3066 (S/N: EGA1-UP)	
Air Filter Set.....	A-5549M-S
Air Filter Primary.....	A-5549
Air Filter Primary.....	A-5549M
Air Filter Secondary.....	A-5550
Cabin Air Filter.....	CA-55850
Fuel Filter Secondary.....	FC-55151
Fuel Filter Secondary.....	FC-5515
Fuel Filter.....	FC-5516
Hydraulic Oil Filter.....	H-5522
Hydraulic Oil Filter.....	HC-5801
Oil Filter Full Flow.....	C-5510
320C (EXCAVATORS) CAT 3066 (S/N: EGL1-09999-UP)	
Air Filter Set.....	A-5549M-S

MODEL/APPLICATION	SAKURA NO
CATERPILLAR	
Air Filter Primary.....	A-5549
Air Filter Primary.....	A-5549M
Air Filter Secondary.....	A-5550
Cabin Air Filter.....	CA-55850
Fuel Filter Secondary.....	FC-55151
Fuel Filter Secondary.....	FC-5515
Fuel Filter.....	FC-5516
Hydraulic Oil Filter.....	HC-5801
Hydraulic Oil Filter.....	H-5522
Oil Filter Full Flow.....	C-5510
320C (EXCAVATORS) CAT 3066 (S/N: GLA1-UP)	
Air Filter Primary.....	A-5549
Air Filter Set.....	A-5549M-S
Air Filter Secondary.....	A-5550
Air Filter Primary.....	A-5549M
Cabin Air Filter.....	CA-55850
Fuel Filter.....	FC-5516
Fuel Filter Secondary.....	FC-55151
Fuel Filter Secondary.....	FC-5515
Hydraulic Oil Filter.....	H-5522
Hydraulic Oil Filter.....	HC-5801
Oil Filter Full Flow.....	C-5510
320C (EXCAVATORS) CAT 3066 (S/N: JTG1-UP)	
Air Filter Primary.....	A-5549M
Air Filter Primary.....	A-5549
Air Filter Secondary.....	A-5550
Air Filter Set.....	A-5549M-S
Cabin Air Filter.....	CA-55850
Fuel Filter Secondary.....	FC-55151
Fuel Filter.....	FC-5516
Fuel Filter Secondary.....	FC-5515
Hydraulic Oil Filter.....	H-5522
Hydraulic Oil Filter.....	HC-5801
Oil Filter Full Flow.....	C-5510
320C (EXCAVATORS) CAT 3066 (S/N: MAB1-UP)	
Air Filter Primary.....	A-8508M
Air Filter Secondary.....	A-8507
Air Filter Set.....	A-8508M-S
Air Filter Primary.....	A-8508
Air Filter Set.....	A-8604-S
Cabin Air Filter.....	CA-55850
Fuel Filter.....	FC-5516
Fuel Filter Secondary.....	FC-5515
Fuel Filter Secondary.....	FC-55151
Hydraulic Oil Filter.....	HC-5801
Hydraulic Oil Filter.....	H-7942
Oil Filter Full Flow.....	C-5510
320C (EXCAVATORS) CAT 3066 (S/N: MAC1-UP)	
Air Filter Primary.....	A-8508M
Air Filter Set.....	A-8604-S
Air Filter Primary.....	A-8508
Air Filter Set.....	A-8508M-S
Air Filter Secondary.....	A-8507
Cabin Air Filter.....	CA-55850
Fuel Filter Secondary.....	FC-55151

MODEL/APPLICATION	SAKURA NO
CATERPILLAR	
320C (EXCAVATORS) CAT 3066 (S/N: MAC1-UP)	
Fuel Filter Secondary.....	FC-5515
Fuel Filter.....	FC-5516
Hydraulic Oil Filter.....	HC-5801
Hydraulic Oil Filter.....	H-7942
Oil Filter Full Flow.....	C-5510
320C (EXCAVATORS) CAT 3066 (S/N: PAB1-UP)	
Air Filter Primary.....	A-8508M
Air Filter Set.....	A-8508M-S
Air Filter Secondary.....	A-8507
Air Filter Set.....	A-8604-S
Air Filter Primary.....	A-8508
Cabin Air Filter.....	CA-55850
Fuel Filter Secondary.....	FC-5515
Fuel Filter Secondary.....	FC-55151
Fuel Filter.....	FC-5516
Hydraulic Oil Filter.....	HC-5801
Hydraulic Oil Filter.....	H-7942
Oil Filter Full Flow.....	C-5510
320C (EXCAVATORS) CAT 3066 (S/N: PAC1-UP)	
Air Filter Secondary.....	A-8507
Air Filter Primary.....	A-8508
Air Filter Set.....	A-8604-S
Air Filter Primary.....	A-8508M
Air Filter Set.....	A-8508M-S
Cabin Air Filter.....	CA-55850
Fuel Filter Secondary.....	FC-5515
Fuel Filter Secondary.....	FC-55151
Fuel Filter.....	FC-5516
Hydraulic Oil Filter.....	HC-5801
Hydraulic Oil Filter.....	H-7942
Oil Filter Full Flow.....	C-5510
320C (EXCAVATORS) CAT 3066 (S/N: RAW1-UP)	
Air Filter Primary.....	A-8508
Air Filter Set.....	A-8508M-S
Air Filter Set.....	A-8604-S
Air Filter Primary.....	A-8508M
Air Filter Secondary.....	A-8507
Cabin Air Filter.....	CA-55850
Fuel Filter Secondary.....	FC-5515
Fuel Filter Secondary.....	FC-55151
Fuel Filter.....	FC-5516
Hydraulic Oil Filter.....	H-7942
Hydraulic Oil Filter.....	HC-5801
Oil Filter Full Flow.....	C-5510
320C (EXCAVATORS) CAT 3066 (S/N: SBN1-UP)	
Air Filter Primary.....	A-8508M
Air Filter Set.....	A-8508M-S
Air Filter Primary.....	A-8508
Air Filter Secondary.....	A-8507
Air Filter Set.....	A-8604-S
Cabin Air Filter.....	CA-55850
Fuel Filter Secondary.....	FC-55151
Fuel Filter.....	FC-5516

MODEL/APPLICATION	SAKURA NO
CATERPILLAR	
Fuel Filter Secondary.....	FC-5515
Hydraulic Oil Filter.....	HC-5801
Hydraulic Oil Filter.....	H-7942
Oil Filter Full Flow.....	C-5510
320C L (EXCAVATORS) CAT 3066 (S/N: AMC1-UP)	
Air Filter Primary.....	A-5549M
Air Filter Secondary.....	A-5550
Air Filter Primary.....	A-8508M
Air Filter Primary.....	A-5549
Air Filter Primary.....	A-8508
Air Filter Set.....	A-5549M-S
Air Filter Set.....	A-8508M-S
Air Filter Set.....	A-8604-S
Air Filter Secondary.....	A-8507
Fuel Filter.....	FC-5516
Fuel Filter Secondary.....	FC-55151
Fuel Filter Secondary.....	FC-5515
Hydraulic Oil Filter.....	HC-5801
Hydraulic Oil Filter.....	H-7942
Oil Filter Full Flow.....	C-5510
320C L (EXCAVATORS) CAT 3066 (S/N: ANB1-UP)	
Air Filter Set.....	A-5549M-S
Air Filter Primary.....	A-5549M
Air Filter Set.....	A-8508M-S
Air Filter Set.....	A-8604-S
Air Filter Primary.....	A-8508M
Air Filter Primary.....	A-5549
Air Filter Primary.....	A-8508
Air Filter Secondary.....	A-5550
Air Filter Secondary.....	A-8507
Fuel Filter Secondary.....	FC-55151
Fuel Filter Secondary.....	FC-5515
Fuel Filter.....	FC-5516
Hydraulic Oil Filter.....	HC-5801
Hydraulic Oil Filter.....	H-7942
Oil Filter Full Flow.....	C-5510
320C L (EXCAVATORS) CAT 3066 (S/N: BBC1-UP)	
Air Filter Set.....	A-8508M-S
Air Filter Primary.....	A-8508M
Air Filter Set.....	A-8604-S
Air Filter Primary.....	A-8508
Air Filter Secondary.....	A-8507
Fuel Filter.....	FC-5516
Fuel Filter Secondary.....	FC-5515
Fuel Filter Secondary.....	FC-55151
Hydraulic Oil Filter.....	HC-5801
Hydraulic Oil Filter.....	H-7942
Oil Filter Full Flow.....	C-5510
320C L (EXCAVATORS) CAT 3066 (S/N: BCN1-UP)	
Air Filter Set.....	A-8508M-S
Air Filter Primary.....	A-8508M
Air Filter Primary.....	A-8508
Air Filter Set.....	A-8604-S
Air Filter Secondary.....	A-8507
Fuel Filter.....	FC-5516
Fuel Filter Secondary.....	FC-5515
Fuel Filter Secondary.....	FC-55151
Hydraulic Oil Filter.....	HC-5801
Hydraulic Oil Filter.....	H-7942
Oil Filter Full Flow.....	C-5510

MODEL/APPLICATION	SAKURA NO
CATERPILLAR	
Fuel Filter.....	FC-5516
Fuel Filter Secondary.....	FC-5515
Hydraulic Oil Filter.....	HC-5801
Hydraulic Oil Filter.....	H-7942
Oil Filter Full Flow.....	C-5510
320C L (EXCAVATORS) CAT 3066 (S/N: BDC1-UP)	
Air Filter Primary.....	A-8508M
Air Filter Secondary.....	A-8507
Air Filter Set.....	A-8604-S
Air Filter Set.....	A-8508M-S
Air Filter Primary.....	A-8508
Fuel Filter Secondary.....	FC-5515
Fuel Filter Secondary.....	FC-55151
Fuel Filter.....	FC-5516
Hydraulic Oil Filter.....	HC-5801
Hydraulic Oil Filter.....	H-7942
Oil Filter Full Flow.....	C-5510
320C L (EXCAVATORS) CAT 3066 (S/N: BDE1-UP)	
Air Filter Set.....	A-8508M-S
Air Filter Set.....	A-8604-S
Air Filter Primary.....	A-8508
Air Filter Secondary.....	A-8507
Air Filter Primary.....	A-8508M
Fuel Filter Secondary.....	FC-5515
Fuel Filter Secondary.....	FC-55151
Fuel Filter.....	FC-5516
Hydraulic Oil Filter.....	HC-5801
Hydraulic Oil Filter.....	H-7942
Oil Filter Full Flow.....	C-5510
320C L (EXCAVATORS) CAT 3066 (S/N: BEA1-UP)	
Air Filter Primary.....	A-8508M
Air Filter Set.....	A-8604-S
Air Filter Secondary.....	A-8507
Air Filter Set.....	A-8508M-S
Air Filter Primary.....	A-8508
Fuel Filter Secondary.....	FC-5515
Fuel Filter Secondary.....	FC-55151
Fuel Filter.....	FC-5516
Hydraulic Oil Filter.....	HC-5801
Hydraulic Oil Filter.....	H-7942
Oil Filter Full Flow.....	C-5510
320C L (EXCAVATORS) CAT 3066 (S/N: BEF1-UP)	
Air Filter Secondary.....	A-8507
Air Filter Set.....	A-8508M-S
Air Filter Primary.....	A-8508M
Air Filter Primary.....	A-8508
Air Filter Set.....	A-8604-S
Fuel Filter Secondary.....	FC-55151
Fuel Filter.....	FC-5516
Fuel Filter Secondary.....	FC-5515
Hydraulic Oil Filter.....	HC-5801
Hydraulic Oil Filter.....	H-7942
Oil Filter Full Flow.....	C-5510
320C L (EXCAVATORS) CAT 3066 (S/N: BER1-UP)	

MODEL/APPLICATION	SAKURA NO
CATERPILLAR	
320C L (EXCAVATORS) CAT 3066 (S/N: BER1-UP)	
Air Filter Set.....	A-8508M-S
Air Filter Primary.....	A-8508M
Air Filter Secondary.....	A-8507
Air Filter Primary.....	A-8508
Air Filter Set.....	A-8604-S
Fuel Filter.....	FC-5516
Fuel Filter Secondary.....	FC-5515
Fuel Filter Secondary.....	FC-55151
Hydraulic Oil Filter.....	H-7942
Hydraulic Oil Filter.....	HC-5801
Oil Filter Full Flow.....	C-5510
320C L (EXCAVATORS) CAT 3066 (S/N: BPR1-UP)	
Air Filter Secondary.....	A-8507
Air Filter Set.....	A-8508M-S
Air Filter Set.....	A-8604-S
Air Filter Primary.....	A-8508
Air Filter Primary.....	A-8508M
Fuel Filter Secondary.....	FC-5515
Fuel Filter Secondary.....	FC-55151
Fuel Filter.....	FC-5516
Hydraulic Oil Filter.....	HC-5801
Hydraulic Oil Filter.....	H-7942
Oil Filter Full Flow.....	C-5510
320C L (EXCAVATORS) CAT 3066 (S/N: BRX1-UP)	
Air Filter Set.....	A-8508M-S
Air Filter Primary.....	A-8508
Air Filter Set.....	A-8604-S
Air Filter Secondary.....	A-8507
Air Filter Primary.....	A-8508M
Fuel Filter Secondary.....	FC-5515
Fuel Filter Secondary.....	FC-55151
Fuel Filter.....	FC-5516
Hydraulic Oil Filter.....	HC-5801
Hydraulic Oil Filter.....	H-7942
Oil Filter Full Flow.....	C-5510
320C L (EXCAVATORS) CAT 3066 ATAAC	
Hydraulic Oil Filter.....	HC-9901
320C LN (EXCAVATORS) CAT 3066 (S/N: BCN1-UP)	
Air Filter Secondary.....	A-8507
Air Filter Set.....	A-8508M-S
Air Filter Set.....	A-8604-S
Air Filter Primary.....	A-8508
Air Filter Primary.....	A-8508M
Fuel Filter Secondary.....	FC-5515
Fuel Filter Secondary.....	FC-55151
Fuel Filter.....	FC-5516
Hydraulic Oil Filter.....	H-7942
Hydraulic Oil Filter.....	HC-5801
Oil Filter Full Flow.....	C-5510
320C LN (EXCAVATORS) CAT 3066 (S/N: BDE1-UP)	
Air Filter Primary.....	A-8508M
Air Filter Secondary.....	A-8507

MODEL/APPLICATION	SAKURA NO
CATERPILLAR	
Air Filter Set.....	A-8508M-S
Air Filter Set.....	A-8604-S
Air Filter Primary.....	A-8508
Fuel Filter Secondary.....	FC-55151
Fuel Filter Secondary.....	FC-5515
Fuel Filter.....	FC-5516
Hydraulic Oil Filter.....	HC-5801
Hydraulic Oil Filter.....	H-7942
Oil Filter Full Flow.....	C-5510
320C LN (EXCAVATORS) CAT 3066 (S/N: BEA1-UP)	
Air Filter Secondary.....	A-8507
Air Filter Set.....	A-8508M-S
Air Filter Primary.....	A-8508
Air Filter Primary.....	A-8508M
Air Filter Set.....	A-8604-S
Fuel Filter.....	FC-5516
Fuel Filter Secondary.....	FC-55151
Fuel Filter Secondary.....	FC-5515
Hydraulic Oil Filter.....	H-7942
Hydraulic Oil Filter.....	HC-5801
Oil Filter Full Flow.....	C-5510
320C LU (EXCAVATORS) CAT 3066 (S/N: CLM1-UP)	
Air Filter Primary.....	A-8508M
Air Filter Primary.....	A-8508
Air Filter Set.....	A-8508M-S
Air Filter Set.....	A-8604-S
Air Filter Secondary.....	A-8507
Fuel Filter Secondary.....	FC-5515
Fuel Filter Secondary.....	FC-55151
Fuel Filter.....	FC-5516
Hydraulic Oil Filter.....	H-7942
Hydraulic Oil Filter.....	HC-5801
Oil Filter Full Flow.....	C-5510
320C LU (EXCAVATORS) CAT 3066 (S/N: CLZ1-UP)	
Air Filter Primary.....	A-8508
Air Filter Primary.....	A-8508M
Air Filter Set.....	A-8508M-S
Air Filter Set.....	A-8604-S
Air Filter Secondary.....	A-8507
Fuel Filter.....	FC-5516
Fuel Filter Secondary.....	FC-55151
Fuel Filter Secondary.....	FC-5515
Hydraulic Oil Filter.....	HC-5801
Hydraulic Oil Filter.....	H-7942
Oil Filter Full Flow.....	C-5510
320C LU (EXCAVATORS) CAT 3066 (S/N: CLZ1-UP)	
Air Filter Primary.....	A-8508
Air Filter Primary.....	A-8508M
Air Filter Set.....	A-8508M-S
Air Filter Set.....	A-8604-S
Air Filter Secondary.....	A-8507
Fuel Filter.....	FC-5516
Fuel Filter Secondary.....	FC-55151
Fuel Filter Secondary.....	FC-5515
Hydraulic Oil Filter.....	HC-5801
Hydraulic Oil Filter.....	H-7942
Oil Filter Full Flow.....	C-5510
320C LU (EXCAVATORS) CAT 3066 ATAAC	
Hydraulic Oil Filter.....	HC-9901
320C U (EXCAVATORS) CAT 3066 (S/N: CLM1-UP)	
Air Filter Primary.....	A-8508
Air Filter Set.....	A-8508M-S
Air Filter Secondary.....	A-8507
Air Filter Set.....	A-8604-S
Fuel Filter.....	FC-5516

MODEL/APPLICATION	SAKURA NO
CATERPILLAR	
Fuel Filter Secondary.....	FC-55151
Fuel Filter Secondary.....	FC-5515
Hydraulic Oil Filter.....	H-7942
Hydraulic Oil Filter.....	HC-5801
Oil Filter Full Flow.....	C-5510
320C U (EXCAVATORS) CAT 3066 (S/N: CLZ1-UP)	
Air Filter Primary.....	A-8508
Air Filter Set.....	A-8508M-S
Air Filter Primary.....	A-8508M
Air Filter Secondary.....	A-8507
Air Filter Set.....	A-8604-S
Fuel Filter.....	FC-5516
Fuel Filter Secondary.....	FC-55151
Fuel Filter Secondary.....	FC-5515
Hydraulic Oil Filter.....	H-7942
Hydraulic Oil Filter.....	HC-5801
Oil Filter Full Flow.....	C-5510
320C U (EXCAVATORS) CAT 3066 ATAAC	
Hydraulic Oil Filter.....	HC-9901
320D (EXCAVATORS) 2006-UP	
Air Filter Primary.....	A-8508M
Air Filter Set.....	A-8508M-S
Air Filter Secondary.....	A-8507
Air Filter Set.....	A-8604-S
Air Filter Primary.....	A-8508
Fuel Filter Secondary.....	FC-55151
Fuel Filter.....	FC-5516
Fuel Filter Secondary.....	FC-5515
Oil Filter Full Flow.....	C-5510
320D (EXCAVATORS) CAT C6.4 ACERT	
Hydraulic Oil Filter.....	HC-9901
320D (EXCAVATORS)	
Cabin Air Filter.....	CA-55170
Cabin Air Filter.....	CAC-55170
Cabin Air Filter.....	CAV-55170
320E (EXCAVATORS) CAT C6.6 ACERT	
Fuel Filter.....	EF-55050
320 BLM (EXCAVATORS)	
Fuel Filter.....	FC-5516
Fuel Filter.....	FC-5508
Fuel Filter Secondary.....	FC-55151
Fuel Filter Secondary.....	FC-5515
Hydraulic Oil Filter.....	HC-5505
Hydraulic Oil Filter.....	H-7942
Hydraulic Oil Filter.....	HC-5801
Oil Filter Full Flow.....	C-5510
320B LN (EXCAVATORS) CAT 3066 (S/N: 1X51-UP)	
Air Filter Primary.....	A-8508M
Air Filter Set.....	A-8604-S

MODEL/APPLICATION	SAKURA NO
CATERPILLAR	
320B LN (EXCAVATORS) CAT 3066 (S/N: 1XS1-UP)	
Air Filter Set.....	A-8508M-S
Air Filter Set.....	A-5549M-S
Air Filter Primary.....	A-5549M
Air Filter Primary.....	A-8508
Air Filter Primary.....	A-5549
Air Filter Secondary.....	A-5550
Fuel Filter Secondary.....	FC-55151
Fuel Filter Secondary.....	FC-5515
Fuel Filter.....	FC-5516
Fuel Filter.....	FC-5508
Hydraulic Oil Filter.....	HC-5801
Hydraulic Oil Filter.....	HC-5505
Hydraulic Oil Filter.....	H-7942
Oil Filter Full Flow.....	C-5510
320B LN (EXCAVATORS) CAT 3066 (S/N: 2AS1-UP)	
Air Filter Primary.....	A-5549
Air Filter Secondary.....	A-5550
Air Filter Primary.....	A-8508M
Air Filter Set.....	A-5549M-S
Air Filter Set.....	A-8604-S
Air Filter Set.....	A-8508M-S
Air Filter Primary.....	A-5549M
Air Filter Primary.....	A-8508
Fuel Filter Secondary.....	FC-5515
Fuel Filter Secondary.....	FC-55151
Fuel Filter.....	FC-5516
Fuel Filter.....	FC-5508
Hydraulic Oil Filter.....	HC-5505
Hydraulic Oil Filter.....	HC-5801
Hydraulic Oil Filter.....	H-7942
Oil Filter Full Flow.....	C-5510
320B LN (EXCAVATORS) CAT 3066 (S/N: 3YZ1-UP)	
Air Filter Primary.....	A-8508
Air Filter Set.....	A-8508M-S
Air Filter Secondary.....	A-8507
Air Filter Primary.....	A-8508M
Air Filter Set.....	A-8604-S
Fuel Filter.....	FC-5516
Fuel Filter.....	FC-5508
Fuel Filter Secondary.....	FC-5515
Fuel Filter Secondary.....	FC-55151
Hydraulic Oil Filter.....	HC-5505
Hydraulic Oil Filter.....	HC-5801
Hydraulic Oil Filter.....	H-7942
Oil Filter Full Flow.....	C-5510
320B LN (EXCAVATORS) CAT 3066 (S/N: SMS1-UP)	
Air Filter Secondary.....	A-8507
Air Filter Primary.....	A-8508
Air Filter Primary.....	A-8508M
Air Filter Set.....	A-8508M-S
Air Filter Set.....	A-8604-S
Fuel Filter.....	FC-5508
Fuel Filter Secondary.....	FC-55151
Fuel Filter Secondary.....	FC-5515
Hydraulic Oil Filter.....	HC-5505
Hydraulic Oil Filter.....	HC-5801
Hydraulic Oil Filter.....	H-7942
Oil Filter Full Flow.....	C-5510

MODEL/APPLICATION	SAKURA NO
CATERPILLAR	
Fuel Filter.....	FC-5516
Hydraulic Oil Filter.....	HC-5505
Hydraulic Oil Filter.....	HC-5801
Hydraulic Oil Filter.....	H-7942
Oil Filter Full Flow.....	C-5510
320B LN (EXCAVATORS) CAT 3066 (S/N: 6LW1-UP)	
Air Filter Set.....	A-8604-S
Air Filter Secondary.....	A-8507
Air Filter Set.....	A-8508M-S
Air Filter Primary.....	A-8508M
Air Filter Primary.....	A-8508
Fuel Filter.....	FC-5508
Fuel Filter Secondary.....	FC-5515
Fuel Filter.....	FC-5516
Fuel Filter Secondary.....	FC-55151
Hydraulic Oil Filter.....	HC-5801
Hydraulic Oil Filter.....	H-7942
Hydraulic Oil Filter.....	HC-5505
Oil Filter Full Flow.....	C-5510
320B LN (EXCAVATORS) CAT 3066 (S/N: 7JR1-UP)	
Air Filter Secondary.....	A-5550
Air Filter Primary.....	A-8508M
Air Filter Set.....	A-8604-S
Air Filter Primary.....	A-5549M
Air Filter Set.....	A-5549M-S
Air Filter Primary.....	A-5549
Air Filter Primary.....	A-8508
Air Filter Set.....	A-8508M-S
Fuel Filter.....	FC-5516
Fuel Filter.....	FC-5508
Fuel Filter Secondary.....	FC-55151
Fuel Filter Secondary.....	FC-5515
Hydraulic Oil Filter.....	HC-5505
Hydraulic Oil Filter.....	HC-5801
Hydraulic Oil Filter.....	H-7942
Oil Filter Full Flow.....	C-5510
320B LN (EXCAVATORS) CAT 3066 (S/N: 9WS1-UP)	
Air Filter Set.....	A-8508M-S
Air Filter Set.....	A-5549M-S
Air Filter Primary.....	A-5549M
Air Filter Set.....	A-8604-S
Air Filter Primary.....	A-5549
Air Filter Primary.....	A-8508
Air Filter Secondary.....	A-5550
Air Filter Primary.....	A-8508M
Fuel Filter.....	FC-5508
Fuel Filter Secondary.....	FC-55151
Fuel Filter.....	FC-5516
Fuel Filter Secondary.....	FC-5515
Hydraulic Oil Filter.....	HC-5801
Hydraulic Oil Filter.....	H-7942
Hydraulic Oil Filter.....	HC-5505
Oil Filter Full Flow.....	C-5510
320B LU (EXCAVATORS) CAT 3066 (S/N: BAN1-UP)	
Air Filter Primary.....	A-8508

MODEL/APPLICATION	SAKURA NO
CATERPILLAR	
Air Filter Secondary.....	A-8507
Air Filter Set.....	A-8508M-S
Air Filter Set.....	A-8604-S
Air Filter Primary.....	A-8508M
Fuel Filter.....	FC-1010
Hydraulic Oil Filter.....	H-5505
Hydraulic Oil Filter.....	HC-5505
Oil Filter Full Flow.....	C-5510
320B LU (EXCAVATORS) CAT 3066 (S/N: BBG1-UP)	
Air Filter Set.....	A-8508M-S
Air Filter Primary.....	A-8508M
Air Filter Secondary.....	A-8507
Air Filter Set.....	A-8604-S
Air Filter Primary.....	A-8508
Fuel Filter.....	FC-1010
Hydraulic Oil Filter.....	HC-5505
Hydraulic Oil Filter.....	H-5505
Oil Filter Full Flow.....	C-5510
320B N (EXCAVATORS) CAT 3066 (S/N: 4NR1-UP)	
Air Filter Set.....	A-8508M-S
Air Filter Secondary.....	A-8507
Air Filter Primary.....	A-8508M
Air Filter Primary.....	A-8508
Air Filter Set.....	A-8604-S
Fuel Filter.....	FC-1010
Hydraulic Oil Filter.....	H-7942
Hydraulic Oil Filter.....	HC-5801
Hydraulic Oil Filter.....	HC-5505
Oil Filter Full Flow.....	C-5510
320B S (EXCAVATORS) CAT 3116 (S/N: 1XS1-UP)	
Air Filter Set.....	A-8508M-S
Air Filter Secondary.....	A-5550
Air Filter Set.....	A-8604-S
Air Filter Secondary.....	A-8507
Air Filter Set.....	A-5549M-S
Air Filter Primary.....	A-5549
Air Filter Primary.....	A-8508
Air Filter Primary.....	A-5549M
Air Filter Primary.....	A-8508M
Fuel Filter Secondary.....	FC-55151
Fuel Filter Secondary.....	FC-5515
Fuel Filter.....	FC-5508
Fuel Filter.....	FC-5516
Hydraulic Oil Filter.....	H-7942
Hydraulic Oil Filter.....	HC-5505
Hydraulic Oil Filter.....	HC-5801
Oil Filter Full Flow.....	C-5510
320B S (EXCAVATORS) CAT 3116 (S/N: 2AS1-UP)	
Air Filter Secondary.....	A-5550
Air Filter Primary.....	A-8508M
Air Filter Secondary.....	A-8507
Air Filter Primary.....	A-5549M
Air Filter Set.....	A-8604-S
Air Filter Primary.....	A-8508
Air Filter Set.....	A-5549M-S

MODEL/APPLICATION	SAKURA NO
CATERPILLAR	
320B S (EXCAVATORS) CAT 3116 (S/N: 2AS1-UP)	
Air Filter Set.....	A-8508M-S
Air Filter Primary.....	A-5549
Fuel Filter Secondary.....	FC-55151
Fuel Filter.....	FC-5516
Fuel Filter.....	FC-5508
Fuel Filter Secondary.....	FC-5515
Hydraulic Oil Filter.....	HC-5801
Hydraulic Oil Filter.....	H-7942
Hydraulic Oil Filter.....	HC-5505
Oil Filter Full Flow.....	C-5510
320B S (EXCAVATORS) CAT 3116 (S/N: 3YZ1-UP)	
Air Filter Secondary.....	A-8507
Air Filter Set.....	A-8508M-S
Air Filter Primary.....	A-8508
Air Filter Primary.....	A-8508M
Air Filter Set.....	A-8604-S
Fuel Filter.....	FC-5516
Fuel Filter Secondary.....	FC-5515
Fuel Filter.....	FC-5508
Fuel Filter Secondary.....	FC-55151
Hydraulic Oil Filter.....	H-7942
Hydraulic Oil Filter.....	HC-5505
Hydraulic Oil Filter.....	HC-5801
Oil Filter Full Flow.....	C-5510
320B S (EXCAVATORS) CAT 3116 (S/N: SMS1-UP)	
Air Filter Secondary.....	A-8507
Air Filter Set.....	A-8604-S
Air Filter Primary.....	A-8508
Air Filter Primary.....	A-8508M
Air Filter Set.....	A-8508M-S
Fuel Filter.....	FC-5508
Fuel Filter Secondary.....	FC-55151
Fuel Filter Secondary.....	FC-5515
Fuel Filter.....	FC-5516
Hydraulic Oil Filter.....	HC-5801
Hydraulic Oil Filter.....	HC-5505
Hydraulic Oil Filter.....	H-7942
Oil Filter Full Flow.....	C-5510
320B S (EXCAVATORS) CAT 3116 (S/N: 6LW1-UP)	
Air Filter Secondary.....	A-8507
Air Filter Set.....	A-8508M-S
Air Filter Set.....	A-8604-S
Air Filter Primary.....	A-8508
Air Filter Primary.....	A-8508M
Fuel Filter.....	FC-5508
Fuel Filter.....	FC-5516
Fuel Filter Secondary.....	FC-55151
Fuel Filter Secondary.....	FC-5515
Hydraulic Oil Filter.....	HC-5801
Hydraulic Oil Filter.....	H-7942
Hydraulic Oil Filter.....	HC-5505
Oil Filter Full Flow.....	C-5510
320B S (EXCAVATORS) CAT 3116 (S/N: 7JR1-UP)	

MODEL/APPLICATION	SAKURA NO
CATERPILLAR	
Air Filter Primary.....	A-5549
Air Filter Set.....	A-8508M-S
Air Filter Set.....	A-8604-S
Air Filter Set.....	A-5549M-S
Air Filter Primary.....	A-5549M
Air Filter Secondary.....	A-8507
Air Filter Primary.....	A-8508
Air Filter Primary.....	A-8508M
Air Filter Secondary.....	A-5550
Fuel Filter Secondary.....	FC-5515
Fuel Filter.....	FC-5516
Fuel Filter.....	FC-5508
Fuel Filter Secondary.....	FC-55151
Hydraulic Oil Filter.....	H-7942
Hydraulic Oil Filter.....	HC-5505
Hydraulic Oil Filter.....	HC-5801
Oil Filter Full Flow.....	C-5510
320B S (EXCAVATORS) CAT 3116 (S/N: 9NS1-UP)	
Air Filter Secondary.....	A-8507
Air Filter Set.....	A-8604-S
Air Filter Primary.....	A-5549M
Air Filter Primary.....	A-5549
Air Filter Secondary.....	A-5550
Air Filter Primary.....	A-8508M
Air Filter Set.....	A-5549M-S
Air Filter Primary.....	A-8508
Air Filter Set.....	A-8508M-S
Fuel Filter.....	FC-5508
Fuel Filter Secondary.....	FC-55151
Fuel Filter Secondary.....	FC-5515
Fuel Filter.....	FC-5516
Hydraulic Oil Filter.....	HC-5801
Hydraulic Oil Filter.....	HC-5505
Hydraulic Oil Filter.....	H-7942
Oil Filter Full Flow.....	C-5510
320B U (EXCAVATORS) CAT 3066 (S/N: BAN1-UP)	
Air Filter Primary.....	A-8508M
Air Filter Set.....	A-8604-S
Air Filter Secondary.....	A-8507
Air Filter Primary.....	A-8508
Air Filter Set.....	A-8508M-S
Fuel Filter.....	FC-1010
Hydraulic Oil Filter.....	HC-5505
Hydraulic Oil Filter.....	H-5505
Oil Filter Full Flow.....	C-5510
320B U (EXCAVATORS) CAT 3066 (S/N: BBG1-UP)	
Air Filter Primary.....	A-8508M
Air Filter Secondary.....	A-8507
Air Filter Set.....	A-8508M-S
Air Filter Set.....	A-8604-S
Air Filter Primary.....	A-8508
Fuel Filter.....	FC-1010
Hydraulic Oil Filter.....	HC-5505
Hydraulic Oil Filter.....	H-5505
Oil Filter Full Flow.....	C-5510

MODEL/APPLICATION	SAKURA NO
CATERPILLAR	
320C FM (DELIMBERS) CAT 3066 (S/N: SAH1-UP)	
Air Filter Primary.....	A-8508
Air Filter Primary.....	A-8508M
Air Filter Secondary.....	A-8507
Air Filter Set.....	A-8604-S
Air Filter Set.....	A-8508M-S
Cabin Air Filter.....	CA-55850
Fuel Filter.....	FC-5516
Fuel Filter Secondary.....	FC-55151
Fuel Filter Secondary.....	FC-5515
Hydraulic Oil Filter.....	H-7942
Hydraulic Oil Filter.....	HC-5801
Oil Filter Full Flow.....	C-5510
320C FM (DELIMBERS) CAT 3066 (S/N: TBR1-UP)	
Air Filter Set.....	A-8604-S
Air Filter Primary.....	A-8508
Air Filter Primary.....	A-8508M
Air Filter Set.....	A-8508M-S
Air Filter Secondary.....	A-8507
Cabin Air Filter.....	CA-55850
Fuel Filter.....	FC-5516
Fuel Filter Secondary.....	FC-5515
Fuel Filter Secondary.....	FC-55151
Hydraulic Oil Filter.....	H-7942
Hydraulic Oil Filter.....	HC-5801
Oil Filter Full Flow.....	C-5510
320C MH (MATERIAL HANDLERS) CAT 3066 (S/N: EGA1-UP)	
Air Filter Primary.....	A-8508M
Air Filter Primary.....	A-8508
Air Filter Set.....	A-8508M-S
Air Filter Set.....	A-8604-S
Air Filter Secondary.....	A-8507
Cabin Air Filter.....	CA-55850
Fuel Filter Secondary.....	FC-55151
Fuel Filter.....	FC-5516
Fuel Filter Secondary.....	FC-5515
Hydraulic Oil Filter.....	HC-5801
Hydraulic Oil Filter.....	H-5522
Oil Filter Full Flow.....	C-5510
320C MH (MATERIAL HANDLERS) CAT 3066 (S/N: JPL1-09999-UP)	
Air Filter Set.....	A-8508M-S
Air Filter Set.....	A-8604-S
Air Filter Primary.....	A-8508
Air Filter Primary.....	A-8508M
Air Filter Secondary.....	A-8507
Cabin Air Filter.....	CA-55850
Fuel Filter Secondary.....	FC-5515
Fuel Filter.....	FC-5516
Fuel Filter Secondary.....	FC-55151
Hydraulic Oil Filter.....	H-5522
Hydraulic Oil Filter.....	HC-5801
Oil Filter Full Flow.....	C-5510
320C S (EXCAVATORS) CAT 3066 (S/N: EGL1-UP)	
Air Filter Primary.....	A-5549

MODEL/APPLICATION	SAKURA NO	MODEL/APPLICATION	SAKURA NO	MODEL/APPLICATION	SAKURA NO
CATERPILLAR		CATERPILLAR		CATERPILLAR	
320C S (EXCAVATORS) CAT 3066 (S/N: EGL1-UP)		320L (EXCAVATORS) CAT 3116 (S/N: 6KM1-UP)		320N (EXCAVATORS) S/N: 3XK822-UP	
Air Filter Set.....	A-5549M-S	Air Filter Set.....	A-6118-S	Air Filter Secondary.....	A-6007
Air Filter Primary.....	A-5549M	Air Filter Primary.....	A-6006	Air Filter Set.....	A-6118-S
Air Filter Secondary.....	A-5550	Air Filter Secondary.....	A-6007	Air Filter Primary.....	A-6006
Cabin Air Filter.....	CA-55850	Fuel Filter.....	FC-5516	Fuel Filter.....	FC-5508
Fuel Filter Secondary.....	FC-5515	Fuel Filter Secondary.....	FC-5515	Fuel Filter.....	F-5505
Fuel Filter.....	FC-5516	Fuel Filter Secondary.....	FC-55151	Fuel Filter Secondary.....	FC-5515
Fuel Filter Secondary.....	FC-55151	Hydraulic Oil Filter.....	HC-5505	Fuel Filter Secondary.....	FC-55151
Hydraulic Oil Filter.....	H-5522	Hydraulic Oil Filter.....	H-5505	Fuel Filter.....	FC-5516
Hydraulic Oil Filter.....	HC-5801	Oil Filter Combination.....	C-7916	Hydraulic Oil Filter.....	H-5505
Oil Filter Full Flow.....	C-5510	Oil Filter Full Flow.....	C-5510	Hydraulic Oil Filter.....	HC-55170
				Hydraulic Oil Filter.....	HC-5505
				Oil Filter Full Flow.....	C-5510
320L (EXCAVATORS) CAT 3116 (S/N: 1KL1-UP)		320L (EXCAVATORS) CAT 3116 (S/N: 7WK1-UP)		320N (EXCAVATORS) S/N: 9WG1-UP	
Air Filter Primary.....	A-6006	Air Filter Set.....	A-6118-S	Air Filter Secondary.....	A-6007
Air Filter Secondary.....	A-6007	Air Filter Primary.....	A-6006	Air Filter Set.....	A-6118-S
Air Filter Set.....	A-6118-S	Air Filter Secondary.....	A-6007	Air Filter Primary.....	A-6006
Fuel Filter.....	FC-1010	Fuel Filter Secondary.....	FC-5515	Hydraulic Oil Filter.....	H-5505
Hydraulic Oil Filter.....	HC-5801	Fuel Filter Secondary.....	FC-55151	Oil Filter Full Flow.....	C-5510
Hydraulic Oil Filter.....	HC-5505	Fuel Filter.....	FC-5516		
Hydraulic Oil Filter.....	H-5505	Fuel Filter.....	F-5505		
Oil Filter Combination.....	C-7916	Hydraulic Oil Filter.....	HC-5505		
Oil Filter Full Flow.....	C-5510	Hydraulic Oil Filter.....	H-5505		
		Oil Filter Full Flow.....	C-5510		
320L (EXCAVATORS) CAT 3116 (S/N: 3XK1-UP)		320L (EXCAVATORS) CAT 3116 (S/N: 8LK1-UP)		320D2 (EXCAVATORS) CAT C7.1 , 7100	
Air Filter Secondary.....	A-6007	Air Filter Secondary.....	A-6007	Hydraulic Oil Filter Suction.....	H-55121
Air Filter Primary.....	A-6006	Air Filter Set.....	A-6118-S		
Air Filter Set.....	A-6118-S	Air Filter Primary.....	A-6006		
Fuel Filter.....	FC-5516	Fuel Filter.....	FC-1010		
Fuel Filter.....	F-5505	Hydraulic Oil Filter.....	HC-5801		
Fuel Filter Secondary.....	FC-5515	Hydraulic Oil Filter.....	HC-5505		
Fuel Filter Secondary.....	FC-55151	Hydraulic Oil Filter.....	H-5505		
Hydraulic Oil Filter.....	H-5505	Oil Filter Full Flow.....	C-5510		
Hydraulic Oil Filter.....	HC-5505	Oil Filter Combination.....	C-7916		
Oil Filter Full Flow.....	C-5510				
320L (EXCAVATORS) CAT 3116 (S/N: 4ZJ1-459-UP)		320L (EXCAVATORS) CAT 3116 (S/N: 9WG1-722-UP)		320D2 (EXCAVATORS) CAT C7.1 , 7100	
Air Filter Set.....	A-6118-S	Air Filter Secondary.....	A-6007	Air Filter Secondary.....	A-44370
Air Filter Primary.....	A-6006	Air Filter Primary.....	A-6006	Air Filter Set.....	A-44380-S
Air Filter Secondary.....	A-6007	Air Filter Set.....	A-6118-S	Air Filter Primary.....	A-44380
Fuel Filter Secondary.....	FC-5515	Fuel Filter.....	F-5505		
Fuel Filter.....	F-5505	Fuel Filter Secondary.....	FC-55151		
Fuel Filter.....	FC-5516	Fuel Filter Secondary.....	FC-5515		
Fuel Filter Secondary.....	FC-55151	Fuel Filter.....	FC-5516		
Hydraulic Oil Filter.....	HC-5505	Hydraulic Oil Filter.....	HC-5505		
Hydraulic Oil Filter.....	H-5505	Hydraulic Oil Filter.....	H-5505		
Oil Filter Full Flow.....	C-5510	Oil Filter Full Flow.....	C-5510		
320L (EXCAVATORS) CAT 3116 (S/N: 4ZJ460-UP)		320L (EXCAVATORS) CAT 3116 (S/N: 9WG723-UP)		320D2 L (EXCAVATORS) CAT C7.1 , 7100	
Air Filter Primary.....	A-6006	Air Filter Secondary.....	A-6006	Air Filter Secondary.....	A-44370
Air Filter Set.....	A-6118-S	Air Filter Primary.....	A-6006	Air Filter Set.....	A-44380-S
Air Filter Secondary.....	A-6007	Air Filter Set.....	A-6118-S	Air Filter Primary.....	A-44380
Fuel Filter Secondary.....	FC-55151	Fuel Filter.....	FC-5516		
Fuel Filter.....	FC-5516	Fuel Filter Secondary.....	FC-5515		
Fuel Filter Secondary.....	FC-5515	Fuel Filter.....	FC-5516		
Hydraulic Oil Filter.....	HC-5505	Hydraulic Oil Filter.....	HC-5505		
Hydraulic Oil Filter.....	H-5505	Hydraulic Oil Filter.....	H-5505		
Oil Filter Combination.....	C-7916	Oil Filter Full Flow.....	C-5510		
Oil Filter Full Flow.....	C-5510				
320L (EXCAVATORS) CAT 3116 (S/N: 4ZJ460-UP)		320L (EXCAVATORS) CAT 3116 (S/N: 9WG723-UP)		320E L (EXCAVATORS) CAT C6.6 ACERT	
Air Filter Primary.....	A-6006	Air Filter Primary.....	A-6006	Fuel Filter.....	EF-55050
Air Filter Set.....	A-6118-S	Air Filter Set.....	A-6118-S		
Air Filter Secondary.....	A-6007	Air Filter Secondary.....	A-6007		
Fuel Filter Secondary.....	FC-55151	Fuel Filter Secondary.....	FC-5515		
Fuel Filter.....	FC-5516	Fuel Filter.....	FC-5516		
Fuel Filter Secondary.....	FC-5515	Fuel Filter Secondary.....	FC-55151		
Hydraulic Oil Filter.....	HC-5505	Hydraulic Oil Filter.....	HC-5505		
Hydraulic Oil Filter.....	H-5505	Hydraulic Oil Filter.....	H-5505		
Oil Filter Combination.....	C-7916	Oil Filter Combination.....	C-7916		
Oil Filter Full Flow.....	C-5510	Oil Filter Full Flow.....	C-5510		
320L (EXCAVATORS) CAT 3116 (S/N: 4ZJ460-UP)		320L (EXCAVATORS) CAT 3116 (S/N: 9WG723-UP)		320E L (EXCAVATORS)	
Air Filter Primary.....	A-6006	Air Filter Primary.....	A-6006	Cabin Air Filter.....	CA-55170
Air Filter Set.....	A-6118-S	Air Filter Set.....	A-6118-S	Cabin Air Filter.....	CAC-55170
Air Filter Secondary.....	A-6007	Air Filter Secondary.....	A-6007	Cabin Air Filter.....	CAV-55170
Fuel Filter Secondary.....	FC-55151	Fuel Filter Secondary.....	FC-5515		
Fuel Filter.....	FC-5516	Fuel Filter.....	FC-5516		
Fuel Filter Secondary.....	FC-5515	Fuel Filter Secondary.....	FC-55151		
Hydraulic Oil Filter.....	HC-5505	Hydraulic Oil Filter.....	HC-5505		
Hydraulic Oil Filter.....	H-5505	Hydraulic Oil Filter.....	H-5505		
Oil Filter Combination.....	C-7916	Oil Filter Combination.....	C-7916		
Oil Filter Full Flow.....	C-5510	Oil Filter Full Flow.....	C-5510		
320L (EXCAVATORS) CAT 3116 (S/N: 4ZJ460-UP)		320L (EXCAVATORS) CAT 3116 (S/N: 9WG723-UP)		320D2 GC (EXCAVATORS) C4.4 ACERT , 4400	
Air Filter Primary.....	A-6006	Air Filter Primary.....	A-6006	Air Filter Set.....	A-44380-S
Air Filter Set.....	A-6118-S	Air Filter Set.....	A-6118-S	Air Filter Primary.....	A-44380
Air Filter Secondary.....	A-6007	Air Filter Secondary.....	A-6007	Air Filter Secondary.....	A-44370
Fuel Filter Secondary.....	FC-55151	Fuel Filter Secondary.....	FC-5515		
Fuel Filter.....	FC-5516	Fuel Filter.....	FC-5516		
Fuel Filter Secondary.....	FC-5515	Fuel Filter Secondary.....	FC-55151		
Hydraulic Oil Filter.....	HC-5505	Hydraulic Oil Filter.....	HC-5505		
Hydraulic Oil Filter.....	H-5505	Hydraulic Oil Filter.....	H-5505		
Oil Filter Combination.....	C-7916	Oil Filter Combination.....	C-7916		
Oil Filter Full Flow.....	C-5510	Oil Filter Full Flow.....	C-5510		

MODEL/APPLICATION	SAKURA NO	MODEL/APPLICATION	SAKURA NO	MODEL/APPLICATION	SAKURA NO
CATERPILLAR		CATERPILLAR		CATERPILLAR	
320D LRR (EXCAVATORS)		321D LCR (EXCAVATORS)		322C (EXCAVATORS) CAT 3126 (S/N: BKM1-UP)	
Cabin Air Filter.....	CA-55170	Cabin Air Filter.....	CA-55170	Air Filter Secondary.....	A-5550
Cabin Air Filter.....	CAC-55170	Cabin Air Filter.....	CAC-55170	Air Filter Secondary.....	A-8507
Cabin Air Filter.....	CAV-55170	Cabin Air Filter.....	CAV-55170	Air Filter Set.....	A-8604-S
320E RR (EXCAVATORS) CAT C6.6		322C (EXCAVATORS) CAT 3126B		Air Filter Primary..... A-5549M Air Filter Set..... A-5549M-S Air Filter Set..... A-8508M-S Air Filter Primary..... A-5549 Air Filter Primary..... A-8508 Air Filter Primary..... A-8508M	
Fuel Filter.....	EF-55050	Hydraulic Oil Filter.....	HC-9901	Fuel Filter.....	FC-5516
320E RR (EXCAVATORS)		322C (EXCAVATORS) CAT 3126 (S/N: BFK1-UP)		Fuel Filter Secondary..... FC-5515 Fuel Filter Secondary..... FC-5515 Fuel Filter..... FC-5508 Hydraulic Oil Filter..... HC-5801 Hydraulic Oil Filter..... H-7942 Oil Filter Full Flow..... C-5510	
Cabin Air Filter.....	CAC-55170	Air Filter Primary.....	A-8508M	Fuel Filter.....	FC-5516
Cabin Air Filter.....	CA-55170	Air Filter Primary.....	A-8508	Fuel Filter Secondary.....	FC-55151
Cabin Air Filter.....	CAV-55170	Air Filter Primary.....	A-5549	Fuel Filter Secondary.....	FC-5515
320D2 FM (EXCAVATORS) CAT C6.4 , 6400		Air Filter Set.....	A-8508M-S	Fuel Filter.....	FC-5508
Hydraulic Oil Filter Transmission..	EH-55050	Air Filter Set.....	A-5549M-S	Hydraulic Oil Filter.....	HC-5801
320E LN (EXCAVATORS) CAT C6.6 ACERT		Air Filter Primary.....	A-5549M	Hydraulic Oil Filter.....	H-7942
Fuel Filter.....	EF-55050	Air Filter Set.....	A-8604-S	Oil Filter Full Flow.....	C-5510
320E LRR (EXCAVATORS) CAT C6.6 ACERT		Air Filter Secondary.....	A-5550		
Fuel Filter.....	EF-55050	Air Filter Secondary.....	A-8507		
320F L (EXCAVATORS) CAT C4.4		Cabin Air Filter.....	CA-55850		
Fuel Filter.....	EF-55050	Fuel Filter.....	FC-5508		
321C (EXCAVATORS) CAT 3066T		Fuel Filter Secondary.....	FC-55151		
Hydraulic Oil Filter.....	HC-9901	Fuel Filter.....	FC-5516		
321C (EXCAVATORS) CAT 3066 (S/N: MCF1-UP)		Fuel Filter Secondary.....	FC-5515		
Air Filter Set.....	A-8604-S	Hydraulic Oil Filter.....	H-7942		
Air Filter Secondary.....	A-8507	Hydraulic Oil Filter.....	HC-5801		
Air Filter Primary.....	A-8508	Oil Filter Full Flow.....	C-5510		
Air Filter Primary.....	A-8508M				
Air Filter Set.....	A-8508M-S				
Fuel Filter.....	FC-5516				
Fuel Filter Secondary.....	FC-5515				
Fuel Filter Secondary.....	FC-55151				
Hydraulic Oil Filter.....	HC-5801				
Hydraulic Oil Filter.....	H-7942				
Oil Filter Full Flow.....	C-5510				
321C LCR (EXCAVATORS) CAT 3066T , 2004-UP		321C (EXCAVATORS) CAT 3126 (S/N: BGR1-UP)		322C (EXCAVATORS) CAT 3126 (S/N: BPH1-UP)	
Air Filter Secondary.....	A-8507	Air Filter Set.....	A-5549M-S	Air Filter Secondary.....	A-8507
Air Filter Primary.....	A-8508	Air Filter Set.....	A-8508M-S	Air Filter Primary.....	A-8508M
Air Filter Set.....	A-8508M-S	Air Filter Primary.....	A-5549	Air Filter Set.....	A-8508M-S
Air Filter Set.....	A-8604-S	Air Filter Primary.....	A-8508	Air Filter Primary.....	A-8508
Air Filter Primary.....	A-8508M	Air Filter Set.....	A-8604-S	Air Filter Set.....	A-8604-S
Fuel Filter Secondary.....	FC-5515	Air Filter Secondary.....	A-8507	Cabin Air Filter.....	CA-55850
Fuel Filter Secondary.....	FC-55151	Air Filter Primary.....	A-5549M	Fuel Filter.....	FC-5516
Hydraulic Oil Filter.....	HC-5801	Air Filter Primary.....	A-8508M	Fuel Filter Secondary.....	FC-55151
Hydraulic Oil Filter.....	H-7942	Air Filter Secondary.....	A-5550	Fuel Filter.....	FC-5508
Oil Filter Full Flow.....	C-5510	Cabin Air Filter.....	CA-55850	Fuel Filter Secondary.....	FC-5515
321D (EXCAVATORS) HCM1-ON		Fuel Filter.....	FC-5508	Hydraulic Oil Filter.....	H-7942
Oil Filter Full Flow.....	C-5506	Fuel Filter Secondary.....	FC-55151	Hydraulic Oil Filter.....	HC-5801
		Hydraulic Oil Filter.....	H-7942	Oil Filter Full Flow.....	C-5510
		Hydraulic Oil Filter.....	HC-5801		
		Hydraulic Oil Filter.....	HC-55170		
		Hydraulic Oil Filter.....	H-7942		
		Oil Filter Full Flow.....	C-5510		

MODEL/APPLICATION	SAKURA NO
CATERPILLAR	
322C (EXCAVATORS) CAT 3126 (S/N: CAM1-UP)	
Fuel Filter Secondary.....	FC-5515
Fuel Filter.....	FC-5508
Fuel Filter Secondary.....	FC-55151
Fuel Filter.....	FC-5516
Hydraulic Oil Filter.....	H-7942
Hydraulic Oil Filter.....	HC-5801
Oil Filter Full Flow.....	C-5510
322C (EXCAVATORS) CAT 3126 (S/N: CBY1-UP)	
Air Filter Secondary.....	A-8507
Air Filter Set.....	A-8604-S
Air Filter Set.....	A-8508M-S
Air Filter Primary.....	A-8508
Air Filter Primary.....	A-8508M
Cabin Air Filter.....	CA-55850
Fuel Filter.....	FC-5516
Fuel Filter Secondary.....	FC-5515
Fuel Filter Secondary.....	FC-55151
Hydraulic Oil Filter.....	H-7942
Hydraulic Oil Filter.....	HC-5801
Oil Filter Full Flow.....	C-5510
322C (EXCAVATORS) CAT 3126 (S/N: DAA1-UP)	
Air Filter Primary.....	A-5558
Air Filter Secondary.....	A-5559
Cabin Air Filter.....	CA-55850
Fuel Filter.....	FC-5517
Hydraulic Oil Filter.....	HC-5801
Hydraulic Oil Filter.....	H-7942
Oil Filter Full Flow.....	C-5510
322C (EXCAVATORS) CAT 3126 (S/N: EMR1-UP)	
Air Filter Secondary.....	A-5559
Air Filter Primary.....	A-5558
Cabin Air Filter.....	CA-55850
Fuel Filter.....	FC-5517
Hydraulic Oil Filter.....	H-7942
Hydraulic Oil Filter.....	H-5522
Hydraulic Oil Filter.....	HC-5801
Oil Filter Full Flow.....	C-5510
322C (EXCAVATORS) CAT 3126 (S/N: HEK1-UP)	
Air Filter Secondary.....	A-5559
Air Filter Primary.....	A-5558
Cabin Air Filter.....	CA-55850
Fuel Filter.....	FC-5517
Hydraulic Oil Filter.....	HC-55170
Hydraulic Oil Filter.....	H-7942
Hydraulic Oil Filter.....	HC-5801
Oil Filter Full Flow.....	C-5510
322C (EXCAVATORS) CAT 3126 (S/N: MAR1-UP)	
Air Filter Primary.....	A-5558
Air Filter Secondary.....	A-5559
Cabin Air Filter.....	CA-55850
Fuel Filter.....	FC-5517
Hydraulic Oil Filter.....	HC-5801

MODEL/APPLICATION	SAKURA NO
CATERPILLAR	
Hydraulic Oil Filter.....	H-7942
Hydraulic Oil Filter.....	H-5522
Oil Filter Full Flow.....	C-5510
322C (EXCAVATORS) S/N: BYL1-UP	
Air Filter Primary.....	A-5558
Air Filter Secondary.....	A-5559
Cabin Air Filter.....	CA-55850
Fuel Filter.....	FC-5517
Hydraulic Oil Filter.....	H-7942
Hydraulic Oil Filter.....	HC-5801
Hydraulic Oil Filter.....	HC-55170
Oil Filter Full Flow.....	C-5510
322C L (EXCAVATORS) CAT 3054 (S/N: BKJ1-UP)	
Air Filter Primary.....	A-8508M
Air Filter Secondary.....	A-5550
Air Filter Secondary.....	A-8507
Air Filter Set.....	A-8604-S
Air Filter Primary.....	A-5549
Air Filter Primary.....	A-8508
Air Filter Set.....	A-8508M-S
Air Filter Set.....	A-5549M-S
Air Filter Primary.....	A-5549M
Cabin Air Filter.....	CA-55850
Fuel Filter Secondary.....	FC-5515
Fuel Filter.....	FC-5508
Fuel Filter.....	FC-5516
Fuel Filter Secondary.....	FC-55151
Hydraulic Oil Filter.....	HC-55170
Hydraulic Oil Filter.....	H-7942
Hydraulic Oil Filter.....	HC-5801
Oil Filter Full Flow.....	C-5510
322C L (EXCAVATORS) CAT 3054 (S/N: BKM1-UP)	
Air Filter Primary.....	A-8508M
Air Filter Secondary.....	A-5550
Air Filter Set.....	A-8508M-S
Air Filter Primary.....	A-8508
Air Filter Primary.....	A-5549
Air Filter Set.....	A-5549M-S
Air Filter Set.....	A-8604-S
Air Filter Primary.....	A-5549M
Air Filter Secondary.....	A-8507
Cabin Air Filter.....	CA-55850
Fuel Filter.....	FC-5508
Fuel Filter Secondary.....	FC-55151
Fuel Filter.....	FC-5516
Fuel Filter Secondary.....	FC-5515
Hydraulic Oil Filter.....	HC-5801
Hydraulic Oil Filter.....	H-7942
Oil Filter Full Flow.....	C-5510
322C L (EXCAVATORS) CAT 3054 (S/N: BLP1-UP)	
Air Filter Set.....	A-8604-S
Air Filter Secondary.....	A-8507
Air Filter Primary.....	A-5549M
Air Filter Primary.....	A-8508
Air Filter Primary.....	A-5549

MODEL/APPLICATION	SAKURA NO
CATERPILLAR	
Air Filter Set.....	A-5549M-S
Air Filter Primary.....	A-8508M
Air Filter Secondary.....	A-5550
Air Filter Set.....	A-8508M-S
Cabin Air Filter.....	CA-55850
Fuel Filter.....	FC-5508
Fuel Filter Secondary.....	FC-5515
Fuel Filter.....	FC-5516
Fuel Filter Secondary.....	FC-55151
Hydraulic Oil Filter.....	H-7942
Hydraulic Oil Filter.....	HC-5801
Oil Filter Full Flow.....	C-5510
322C L (EXCAVATORS) CAT 3054 (S/N: FED1-UP)	
Air Filter Secondary.....	A-5559
Air Filter Primary.....	A-5558
Cabin Air Filter.....	CA-55850
Fuel Filter.....	FC-5517
Hydraulic Oil Filter.....	H-7942
Hydraulic Oil Filter.....	HC-5801
Oil Filter Full Flow.....	C-5510
322C L (EXCAVATORS) CAT 3126B ATAAAC	
Hydraulic Oil Filter.....	HC-9901
322C LN (EXCAVATORS) S/N: EMR00297-UP , 2004-UP	
Air Filter Secondary.....	A-5559
Air Filter Primary.....	A-5558
Fuel Filter.....	FC-5517
Hydraulic Oil Filter.....	HC-5801
Hydraulic Oil Filter.....	H-5522
Oil Filter Full Flow.....	C-5510
322C LN (EXCAVATORS) CAT 3054 (S/N: BFK1-UP)	
Air Filter Primary.....	A-8508M
Air Filter Primary.....	A-5549M
Air Filter Secondary.....	A-8507
Air Filter Primary.....	A-8508
Air Filter Secondary.....	A-5550
Air Filter Primary.....	A-5549
Air Filter Set.....	A-5549M-S
Air Filter Set.....	A-8604-S
Air Filter Set.....	A-8508M-S
Fuel Filter Secondary.....	FC-55151
Fuel Filter.....	FC-5516
Fuel Filter Secondary.....	FC-5515
Fuel Filter.....	FC-5508
Hydraulic Oil Filter.....	HC-5801
Hydraulic Oil Filter.....	H-7942
Oil Filter Full Flow.....	C-5510
322C LN (EXCAVATORS) CAT 3054 (S/N: BGR1-UP)	
Air Filter Set.....	A-8604-S
Air Filter Primary.....	A-8508
Air Filter Set.....	A-5549M-S
Air Filter Primary.....	A-5549
Air Filter Primary.....	A-5549M
Air Filter Secondary.....	A-8507
Air Filter Set.....	A-8508M-S

MODEL/APPLICATION	SAKURA NO
CATERPILLAR	
322C LN (EXCAVATORS) CAT 3054 (S/N: BGR1-UP)	
Air Filter Secondary.....	A-5550
Air Filter Primary.....	A-8508M
Fuel Filter.....	FC-5508
Fuel Filter.....	FC-5516
Fuel Filter Secondary.....	FC-55151
Fuel Filter Secondary.....	FC-5515
Hydraulic Oil Filter.....	HC-5801
Hydraulic Oil Filter.....	H-7942
Oil Filter Full Flow.....	C-5510
322B (EXCAVATORS) CAT 3116 (S/N: 2ES1-UP)	
Air Filter Set.....	A-8508M-S
Air Filter Primary.....	A-8508
Air Filter Primary.....	A-8508M
Air Filter Set.....	A-8604-S
Air Filter Secondary.....	A-8507
Cabin Air Filter.....	CA-55850
Fuel Filter.....	FC-5508
Fuel Filter Secondary.....	FC-5515
Fuel Filter.....	FC-5516
Fuel Filter Secondary.....	FC-55151
Hydraulic Oil Filter.....	HC-5801
Oil Filter Full Flow.....	C-5510
322B (EXCAVATORS) CAT 3116 (S/N: 8MR1-UP)	
Air Filter Set.....	A-8604-S
Air Filter Primary.....	A-8508
Air Filter Primary.....	A-8508M
Air Filter Secondary.....	A-5550
Air Filter Primary.....	A-5549M
Air Filter Secondary.....	A-8507
Air Filter Primary.....	A-5549
Air Filter Set.....	A-8508M-S
Air Filter Set.....	A-5549M-S
Cabin Air Filter.....	CA-55850
Fuel Filter Secondary.....	FC-5515
Fuel Filter.....	FC-5508
Fuel Filter Secondary.....	FC-55151
Fuel Filter.....	FC-5516
Hydraulic Oil Filter.....	HC-5801
Hydraulic Oil Filter.....	HC-5505
Hydraulic Oil Filter.....	H-7942
Oil Filter Full Flow.....	C-5510
322B (EXCAVATORS) CAT 3116 (S/N: 8NR1-UP)	
Air Filter Primary.....	A-8508M
Air Filter Secondary.....	A-5550
Air Filter Set.....	A-8508M-S
Air Filter Set.....	A-5549M-S
Air Filter Primary.....	A-5549
Air Filter Primary.....	A-8508
Air Filter Secondary.....	A-8507
Air Filter Set.....	A-8604-S
Air Filter Primary.....	A-5549M
Cabin Air Filter.....	CA-55850
Fuel Filter.....	FC-5516
Fuel Filter Secondary.....	FC-55151

MODEL/APPLICATION	SAKURA NO
CATERPILLAR	
Fuel Filter.....	FC-5508
Fuel Filter Secondary.....	FC-5515
Hydraulic Oil Filter.....	HC-5505
Hydraulic Oil Filter.....	H-7942
Hydraulic Oil Filter.....	HC-5801
Oil Filter Full Flow.....	C-5510
322L (EXCAVATORS) CAT 3116 (S/N: 4RM1-UP)	
Air Filter Secondary.....	A-6007
Air Filter Primary.....	A-6006
Air Filter Set.....	A-6118-S
Fuel Filter.....	F-5505
Fuel Filter Secondary.....	FC-5515
Fuel Filter.....	FC-5516
Fuel Filter Secondary.....	FC-55151
Fuel Filter.....	FC-5508
Hydraulic Oil Filter.....	H-5505
Hydraulic Oil Filter.....	HC-5505
Oil Filter Full Flow.....	C-5510
322L (EXCAVATORS) CAT 3116 (S/N: 7WL1-UP)	
Air Filter Primary.....	A-6006
Air Filter Secondary.....	A-6007
Air Filter Set.....	A-6118-S
Fuel Filter.....	FC-5508
Fuel Filter.....	F-5505
Fuel Filter Secondary.....	FC-55151
Fuel Filter.....	FC-5516
Fuel Filter Secondary.....	FC-5515
Hydraulic Oil Filter.....	HC-5505
Hydraulic Oil Filter.....	H-5505
Oil Filter Full Flow.....	C-5510
322L (EXCAVATORS) CAT 3116 (S/N: 8CL1-UP)	
Air Filter Set.....	A-6118-S
Air Filter Primary.....	A-6006
Air Filter Secondary.....	A-6007
Fuel Filter.....	FC-5508
Fuel Filter Secondary.....	FC-5515
Fuel Filter.....	FC-5516
Fuel Filter Secondary.....	FC-55151
Fuel Filter.....	F-5505
Hydraulic Oil Filter.....	HC-5505
Hydraulic Oil Filter.....	H-5505
Oil Filter Full Flow.....	C-5510
322L (EXCAVATORS) CAT 3116 (S/N: 8ML1-UP)	
Air Filter Secondary.....	A-6007
Air Filter Primary.....	A-6006
Air Filter Set.....	A-6118-S
Fuel Filter Secondary.....	FC-5515
Fuel Filter.....	FC-5516
Fuel Filter Secondary.....	FC-55151
Fuel Filter.....	F-5505
Hydraulic Oil Filter.....	HC-5505
Hydraulic Oil Filter.....	H-5505
Oil Filter Full Flow.....	C-5510

MODEL/APPLICATION	SAKURA NO
CATERPILLAR	
322L (EXCAVATORS) CAT 3116 (S/N: 9JL1-UP)	
Air Filter Primary.....	A-6006
Air Filter Set.....	A-6118-S
Air Filter Secondary.....	A-6007
Fuel Filter.....	F-5505
Fuel Filter Secondary.....	FC-55151
Fuel Filter.....	FC-5516
Fuel Filter.....	FC-5508
Fuel Filter Secondary.....	FC-5515
Hydraulic Oil Filter.....	HC-5505
Hydraulic Oil Filter.....	H-5505
Oil Filter Full Flow.....	C-5510
322L (EXCAVATORS) CAT 3116 (S/N: 9RL1-UP)	
Air Filter Secondary.....	A-6007
Air Filter Primary.....	A-6006
Air Filter Set.....	A-6118-S
Fuel Filter.....	FC-5516
Fuel Filter Secondary.....	FC-55151
Fuel Filter Secondary.....	FC-5515
Fuel Filter.....	F-5505
Fuel Filter.....	FC-5508
Hydraulic Oil Filter.....	H-5505
Hydraulic Oil Filter.....	HC-5505
Oil Filter Full Flow.....	C-5510
322 LN (EXCAVATORS) CAT 3116 (S/N: 4RM1-UP)	
Air Filter Secondary.....	A-6007
Air Filter Set.....	A-6118-S
Air Filter Primary.....	A-6006
Fuel Filter.....	F-5505
Fuel Filter.....	FC-5508
Fuel Filter Secondary.....	FC-5515
Fuel Filter.....	FC-5516
Fuel Filter Secondary.....	FC-55151
Hydraulic Oil Filter.....	H-5505
Hydraulic Oil Filter.....	HC-5505
Oil Filter Full Flow.....	C-5510
322 LN (EXCAVATORS) CAT 3116 (S/N: 8ML1-UP)	
Air Filter Primary.....	A-6006
Air Filter Secondary.....	A-6007
Air Filter Set.....	A-6118-S
Fuel Filter.....	FC-5508
Fuel Filter.....	F-5505
Fuel Filter Secondary.....	FC-5515
Fuel Filter Secondary.....	FC-55151
Fuel Filter.....	FC-5516
Hydraulic Oil Filter.....	H-5505
Hydraulic Oil Filter.....	HC-5505
Oil Filter Full Flow.....	C-5510
322 LN (EXCAVATORS) CAT 3116 (S/N: 9JL1-UP)	
Air Filter Set.....	A-6118-S
Air Filter Secondary.....	A-6007
Air Filter Primary.....	A-6006
Fuel Filter.....	F-5505
Fuel Filter Secondary.....	FC-5515

MODEL/APPLICATION	SAKURA NO
CATERPILLAR	
322 LN (EXCAVATORS) CAT 3116 (S/N: 9JL1-UP)	
Fuel Filter Secondary.....	FC-55151
Fuel Filter.....	FC-5516
Fuel Filter.....	FC-5508
Hydraulic Oil Filter.....	H-5505
Hydraulic Oil Filter.....	HC-5505
Oil Filter Full Flow.....	C-5510
322B L (EXCAVATORS) CAT 3054 (S/N: 1YS1-UP)	
Air Filter Secondary.....	A-8507
Air Filter Primary.....	A-8508M
Air Filter Primary.....	A-8508
Air Filter Set.....	A-8508M-S
Air Filter Set.....	A-8604-S
Cabin Air Filter.....	CA-55850
Fuel Filter Secondary.....	FC-55151
Fuel Filter.....	FC-5516
Fuel Filter Secondary.....	FC-5515
Fuel Filter.....	FC-5508
Hydraulic Oil Filter.....	HC-5505
Hydraulic Oil Filter.....	HC-5801
Oil Filter Full Flow.....	C-5510
322B L (EXCAVATORS) CAT 3116 (S/N: 1AS1-UP)	
Air Filter Set.....	A-8508M-S
Air Filter Set.....	A-8604-S
Air Filter Secondary.....	A-8507
Air Filter Primary.....	A-8508
Air Filter Primary.....	A-8508M
Fuel Filter Secondary.....	FC-55151
Fuel Filter Secondary.....	FC-5515
Fuel Filter.....	FC-5516
Hydraulic Oil Filter.....	HC-5801
Hydraulic Oil Filter.....	HC-5505
Hydraulic Oil Filter.....	H-7942
Oil Filter Full Flow.....	C-5510
322B L (EXCAVATORS) CAT 3116 (S/N: 1ES1-UP)	
Air Filter Set.....	A-8508M-S
Air Filter Secondary.....	A-8507
Air Filter Primary.....	A-8508
Air Filter Set.....	A-8604-S
Air Filter Primary.....	A-8508M
Fuel Filter Secondary.....	FC-5515
Fuel Filter Secondary.....	FC-55151
Fuel Filter.....	FC-5516
Hydraulic Oil Filter.....	HC-5505
Hydraulic Oil Filter.....	H-7942
Hydraulic Oil Filter.....	HC-5801
Oil Filter Full Flow.....	C-5510
322B L (EXCAVATORS) CAT 3116 (S/N: 1YS1-UP)	
Air Filter Primary.....	A-8508M
Air Filter Primary.....	A-5549M
Air Filter Secondary.....	A-8507
Air Filter Secondary.....	A-5550
Air Filter Primary.....	A-5549
Air Filter Set.....	A-8604-S
Air Filter Set.....	A-5549M-S
Air Filter Primary.....	A-8508
Fuel Filter Secondary.....	FC-55151
Fuel Filter.....	FC-5516
Air Filter Set.....	A-8508M-S

MODEL/APPLICATION	SAKURA NO
CATERPILLAR	
Air Filter Set.....	A-8508M-S
Air Filter Primary.....	A-8508
Air Filter Set.....	A-5549M-S
Fuel Filter.....	FC-5516
Fuel Filter Secondary.....	FC-5515
Fuel Filter.....	FC-5508
Fuel Filter Secondary.....	FC-55151
Hydraulic Oil Filter.....	H-7942
Hydraulic Oil Filter.....	HC-5801
Hydraulic Oil Filter.....	HC-5505
Oil Filter Full Flow.....	C-5510
322B L (EXCAVATORS) CAT 3116 (S/N: 1ZS1-UP)	
Air Filter Primary.....	A-5549M
Air Filter Set.....	A-8604-S
Air Filter Primary.....	A-8508M
Air Filter Primary.....	A-5549
Air Filter Secondary.....	A-8507
Air Filter Secondary.....	A-5550
Air Filter Set.....	A-8508M-S
Air Filter Primary.....	A-8508
Air Filter Set.....	A-5549M-S
Fuel Filter Secondary.....	FC-5515
Fuel Filter.....	FC-5508
Fuel Filter Secondary.....	FC-55151
Fuel Filter.....	FC-5516
Hydraulic Oil Filter.....	H-7942
Hydraulic Oil Filter.....	HC-5801
Hydraulic Oil Filter.....	HC-5505
Oil Filter Full Flow.....	C-5510
322B L (EXCAVATORS) CAT 3116 (S/N: 2ES1-UP)	
Air Filter Primary.....	A-5549
Air Filter Primary.....	A-8508M
Air Filter Primary.....	A-5549M
Air Filter Secondary.....	A-8507
Air Filter Primary.....	A-8508
Air Filter Set.....	A-8508M-S
Air Filter Set.....	A-5549M-S
Air Filter Set.....	A-8604-S
Air Filter Secondary.....	A-5550
Fuel Filter Secondary.....	FC-5515
Fuel Filter.....	FC-5508
Fuel Filter.....	FC-5516
Fuel Filter Secondary.....	FC-55151
Hydraulic Oil Filter.....	HC-5801
Hydraulic Oil Filter.....	H-7942
Hydraulic Oil Filter.....	HC-5505
Oil Filter Full Flow.....	C-5510
322B L (EXCAVATORS) CAT 3116 (S/N: 8MR1-UP)	
Air Filter Primary.....	A-8508M
Air Filter Secondary.....	A-5550
Air Filter Set.....	A-8604-S
Air Filter Primary.....	A-5549
Air Filter Primary.....	A-8508
Air Filter Set.....	A-8508M-S
Air Filter Set.....	A-5549M-S
Air Filter Primary.....	A-5549M

MODEL/APPLICATION	SAKURA NO
CATERPILLAR	
Air Filter Secondary.....	A-8507
Fuel Filter Secondary.....	FC-55151
Fuel Filter Secondary.....	FC-5515
Fuel Filter.....	FC-5516
Fuel Filter.....	FC-5508
Hydraulic Oil Filter.....	H-7942
Hydraulic Oil Filter.....	HC-5505
Hydraulic Oil Filter.....	HC-5801
Oil Filter Full Flow.....	C-5510
322B L (EXCAVATORS) CAT 3116 (S/N: 8NR1-UP)	
Air Filter Primary.....	A-8508M
Air Filter Set.....	A-5549M-S
Air Filter Primary.....	A-8508
Air Filter Primary.....	A-5549
Air Filter Secondary.....	A-5550
Air Filter Set.....	A-8604-S
Air Filter Set.....	A-8508M-S
Air Filter Secondary.....	A-8507
Air Filter Primary.....	A-5549M
Fuel Filter Secondary.....	FC-55151
Fuel Filter Secondary.....	FC-5515
Fuel Filter.....	FC-5508
Fuel Filter.....	FC-5516
Hydraulic Oil Filter.....	H-7942
Hydraulic Oil Filter.....	HC-5801
Hydraulic Oil Filter.....	HC-5505
Oil Filter Full Flow.....	C-5510
322B LN (EXCAVATORS) CAT 3116 (S/N: 1ZS1-UP)	
Air Filter Primary.....	A-8508
Air Filter Primary.....	A-8508M
Air Filter Secondary.....	A-5550
Air Filter Set.....	A-8604-S
Air Filter Set.....	A-5549M-S
Air Filter Set.....	A-8508M-S
Air Filter Primary.....	A-5549M
Air Filter Primary.....	A-5549
Air Filter Secondary.....	A-8507
Fuel Filter.....	FC-5508
Fuel Filter.....	FC-5516
Fuel Filter Secondary.....	FC-5515
Fuel Filter Secondary.....	FC-55151
Hydraulic Oil Filter.....	H-7942
Hydraulic Oil Filter.....	HC-5801
Hydraulic Oil Filter.....	HC-5505
Oil Filter Full Flow.....	C-5510
322B LN (EXCAVATORS) CAT 3116 (S/N: 2ES1-UP)	
Air Filter Primary.....	A-5549
Air Filter Primary.....	A-8508M
Air Filter Secondary.....	A-5550
Air Filter Secondary.....	A-8507
Air Filter Primary.....	A-5549M
Air Filter Set.....	A-8604-S
Air Filter Set.....	A-5549M-S
Air Filter Set.....	A-8508M-S
Air Filter Primary.....	A-8508
Fuel Filter Secondary.....	FC-55151
Fuel Filter.....	FC-5516

MODEL/APPLICATION	SAKURA NO	MODEL/APPLICATION	SAKURA NO	MODEL/APPLICATION	SAKURA NO
CATERPILLAR		CATERPILLAR		CATERPILLAR	
322B LN (EXCAVATORS) CAT 3116 (S/N: 2ES1-UP)		Oil Filter Full Flow.....	C-5510	Hydraulic Oil Filter.....	HC-5801
Fuel Filter Secondary.....	FC-5515	323D (EXCAVATORS) CAT (S/N: MAE1-UP)		323D (EXCAVATORS) S/N: RAC1-UP	
Fuel Filter.....	FC-5508	Fuel Filter.....	FC-10022	Air Filter Primary.....	A-5549M
Hydraulic Oil Filter.....	H-7942	Fuel Filter Secondary.....	FC-5515	Air Filter Primary.....	A-5549
Hydraulic Oil Filter.....	HC-5505	Fuel Filter.....	FC-1002	Air Filter Secondary.....	A-5550
Hydraulic Oil Filter.....	HC-5801	Fuel Filter.....	FC-5516	Air Filter Set.....	A-5549M-S
Oil Filter Full Flow.....	C-5510	Fuel Filter Secondary.....	FC-55151	Cabin Air Filter.....	CA-55850
322C FP (EXCAVATORS) CAT 3054 (S/N: C3R1-UP)		Oil Filter Full Flow.....	C-5522	Hydraulic Oil Filter.....	HC-55170
Air Filter Secondary.....	A-5559	Oil Filter Full Flow.....	C-5510	Hydraulic Oil Filter.....	H-5522
Air Filter Primary.....	A-5558	323D (EXCAVATORS) S/N: BYM1-UP		Hydraulic Oil Filter.....	HC-5801
Cabin Air Filter.....	CA-55850	Air Filter Set.....	A-5549M-S	323D (EXCAVATORS) S/N: SDC1-UP	
Fuel Filter.....	FC-5517	Air Filter Secondary.....	A-5550	Air Filter Secondary.....	A-5550
Hydraulic Oil Filter.....	HC-55170	Air Filter Primary.....	A-5549	Air Filter Primary.....	A-5549
Hydraulic Oil Filter.....	HC-5801	Air Filter Primary.....	A-5549M	Air Filter Set.....	A-5549M-S
Hydraulic Oil Filter.....	H-7942	Cabin Air Filter.....	CA-55850	Air Filter Primary.....	A-5549M
Oil Filter Full Flow.....	C-5510	Hydraulic Oil Filter.....	HC-5801	Cabin Air Filter.....	CA-55850
322C FP (EXCAVATORS) CAT 3054 (S/N: LAR1-UP)		Hydraulic Oil Filter.....	HC-55170	Hydraulic Oil Filter.....	H-5522
Air Filter Secondary.....	A-5559	Hydraulic Oil Filter.....	H-5522	Hydraulic Oil Filter.....	HC-5801
Air Filter Primary.....	A-5558	323D (EXCAVATORS) S/N: CYD1-UP		Hydraulic Oil Filter.....	H-5522
Cabin Air Filter.....	CA-55850	Air Filter Secondary.....	A-5550	323D (EXCAVATORS) S/N: SED1-UP	
Fuel Filter.....	FC-5517	Air Filter Primary.....	A-5549	Air Filter Primary.....	A-5549
Hydraulic Oil Filter.....	HC-55170	Air Filter Set.....	A-5549M-S	Air Filter Set.....	A-5549M-S
Hydraulic Oil Filter.....	HC-5801	Air Filter Primary.....	A-5549M	Air Filter Secondary.....	A-5550
Hydraulic Oil Filter.....	H-7942	Cabin Air Filter.....	CA-55850	Air Filter Primary.....	A-5549M
Oil Filter Full Flow.....	C-5510	Hydraulic Oil Filter.....	HC-5801	Cabin Air Filter.....	CA-55850
322C FP (EXCAVATORS) CAT 3054 (S/N: M2H1-UP)		Hydraulic Oil Filter.....	H-5522	Hydraulic Oil Filter.....	H-5522
Air Filter Primary.....	A-5558	Hydraulic Oil Filter.....	HC-55170	Hydraulic Oil Filter.....	HC-55170
Air Filter Secondary.....	A-5559	323D (EXCAVATORS) S/N: DKM1-UP		Hydraulic Oil Filter.....	HC-5801
Cabin Air Filter.....	CA-55850	Air Filter Primary.....	A-5549	323E (EXCAVATORS) CAT C6.6 ACERT	
Fuel Filter.....	FC-5517	Air Filter Set.....	A-5549M-S	Fuel Filter.....	EF-55050
Hydraulic Oil Filter.....	HC-55170	Air Filter Secondary.....	A-5550	323E SA (EXCAVATORS) CAT C6.6 ACERT	
Hydraulic Oil Filter.....	H-7942	Air Filter Primary.....	A-5549M	Fuel Filter.....	EF-55050
Hydraulic Oil Filter.....	HC-5801	Cabin Air Filter.....	CA-55850	323E SA (EXCAVATORS)	
Oil Filter Full Flow.....	C-5510	Hydraulic Oil Filter.....	HC-55170	Cabin Air Filter.....	CA-55170
323D (EXCAVATORS) CAT (S/N: 7JK1-UP)		Hydraulic Oil Filter.....	HC-5801	Cabin Air Filter.....	CAC-55170
Air Filter Secondary.....	A-8507	Hydraulic Oil Filter.....	H-5522	Cabin Air Filter.....	CAV-55170
Air Filter Primary.....	A-8508M	323D (EXCAVATORS) S/N: JLG1-UP		323E L (EXCAVATORS) CAT C6.6	
Air Filter Primary.....	A-8508	Air Filter Set.....	A-5549M-S	Fuel Filter.....	EF-55050
Air Filter Set.....	A-8508M-S	Air Filter Primary.....	A-5549	323E LN (EXCAVATORS) CAT C6.6 ACERT	
Air Filter Set.....	A-8604-S	Air Filter Secondary.....	A-5550	Fuel Filter.....	EF-55050
Fuel Filter.....	FC-5516	Air Filter Primary.....	A-5549M	323F (EXCAVATORS) CAT C7.1	
Fuel Filter Secondary.....	FC-55151	Cabin Air Filter.....	CA-55850	Fuel Filter.....	EF-55050
Fuel Filter.....	FC-1010	Hydraulic Oil Filter.....	HC-55170	323F L (EXCAVATORS) CAT C7.1	
Fuel Filter Secondary.....	FC-5515	Hydraulic Oil Filter.....	H-5522	Fuel Filter.....	EF-55050
Oil Filter Full Flow.....	C-5510	Hydraulic Oil Filter.....	HC-5801	323F LN (EXCAVATORS) CAT C4.4	
Oil Filter Full Flow.....	C-5522	323D (EXCAVATORS) S/N: PBM1-UP			
323D (EXCAVATORS) CAT (S/N: GDC1-UP)		Air Filter Primary.....	A-5549M		
Fuel Filter.....	FC-5516	Air Filter Set.....	A-5549M-S		
Fuel Filter Secondary.....	FC-5507	Air Filter Primary.....	A-5549		
Fuel Filter Secondary.....	FC-55151	Air Filter Secondary.....	A-5550		
Fuel Filter Secondary.....	FC-5515	Cabin Air Filter.....	CA-55850		
Oil Filter Full Flow.....	C-5522	Hydraulic Oil Filter.....	HC-55170		
		Hydraulic Oil Filter.....	H-5522		

MODEL/APPLICATION	SAKURA NO
CATERPILLAR	
323F LN (EXCAVATORS) CAT S/N: C4.4	
Fuel Filter.....	EF-55050
323F SA (EXCAVATORS) CAT S/N: C4.4	
Fuel Filter.....	EF-55050
324D (EXCAVATORS) CAT S/N: C7C1-UP , 2006-UP	
Air Filter.....	A-5584
Air Filter Primary.....	A-5558
Air Filter Secondary.....	A-5559
Cabin Air Filter.....	CA-55850
Fuel Filter.....	FC-5517
Hydraulic Oil Filter.....	H-5522
Hydraulic Oil Filter.....	HC-5801
Hydraulic Oil Filter.....	HC-55170
Oil Filter Full Flow.....	C-5522
324D (EXCAVATORS) CAT S/N: CJX1-UP , 2006-UP	
Air Filter Primary.....	A-5558
Air Filter Secondary.....	A-5559
Cabin Air Filter.....	CA-55850
Fuel Filter.....	FC-5517
Hydraulic Oil Filter.....	H-5522
Hydraulic Oil Filter.....	HC-5801
Hydraulic Oil Filter.....	HC-55170
Oil Filter Full Flow.....	C-5522
324D (EXCAVATORS) CAT S/N: DFP1-UP , 2006-UP	
Air Filter Secondary.....	A-5559
Air Filter Primary.....	A-5558
Cabin Air Filter.....	CA-55850
Fuel Filter.....	FC-5517
Hydraulic Oil Filter.....	HC-5801
Hydraulic Oil Filter.....	HC-55170
Hydraulic Oil Filter.....	H-5522
Oil Filter Full Flow.....	C-5522
324D (EXCAVATORS) CAT S/N: EJC1-UP , 2006-UP	
Air Filter Primary.....	A-5558
Air Filter Secondary.....	A-5559
Cabin Air Filter.....	CA-55850
Fuel Filter.....	FC-5517
Hydraulic Oil Filter.....	HC-5801
Hydraulic Oil Filter.....	HC-55170
Hydraulic Oil Filter.....	H-5522
Oil Filter Full Flow.....	C-5522
324D (EXCAVATORS) CAT S/N: JGK1-UP , 2006-UP	
Air Filter Primary.....	A-5558
Air Filter.....	A-5584
Air Filter Secondary.....	A-5559
Fuel Filter.....	FC-5517
Hydraulic Oil Filter.....	HC-55170
Hydraulic Oil Filter.....	HC-5801
Hydraulic Oil Filter.....	H-5522
Oil Filter Full Flow.....	C-5522

MODEL/APPLICATION	SAKURA NO
CATERPILLAR	
324D (EXCAVATORS) CAT S/N: JJG1-384-UP , 2006-UP	
Air Filter Secondary.....	A-5559
Air Filter Primary.....	A-5558
Cabin Air Filter.....	CA-55850
Fuel Filter.....	FC-5517
Hydraulic Oil Filter.....	HC-55170
Hydraulic Oil Filter.....	HC-5801
Hydraulic Oil Filter.....	H-5522
Oil Filter Full Flow.....	C-5522
324D (EXCAVATORS) CAT S/N: JJG385-UP , 2006-UP	
Air Filter Secondary.....	A-5559
Air Filter Primary.....	A-5558
Cabin Air Filter.....	CA-55850
Fuel Filter.....	FC-5517
Hydraulic Oil Filter.....	HC-55170
Hydraulic Oil Filter.....	H-5522
Hydraulic Oil Filter.....	HC-5801
Oil Filter Full Flow.....	C-5522
324D (EXCAVATORS) CAT S/N: JKR1-178-UP , 2006-UP	
Air Filter Secondary.....	A-5559
Air Filter.....	A-5584
Air Filter Primary.....	A-5558
Fuel Filter.....	FC-5517
Hydraulic Oil Filter.....	HC-5801
Hydraulic Oil Filter.....	H-5522
Hydraulic Oil Filter.....	HC-55170
Oil Filter Full Flow.....	C-5522
324D (EXCAVATORS) CAT S/N: JKR179-UP , 2006-UP	
Air Filter.....	A-5584
Air Filter Primary.....	A-5558
Air Filter Secondary.....	A-5559
Fuel Filter.....	FC-5517
Hydraulic Oil Filter.....	H-5522
Hydraulic Oil Filter.....	HC-5801
Oil Filter Full Flow.....	C-5522
324D (EXCAVATORS) CAT S/N: JLS1-174-UP , 2006-UP	
Air Filter Primary.....	A-5558
Air Filter.....	A-5584
Air Filter Secondary.....	A-5559
Fuel Filter.....	FC-5517
Hydraulic Oil Filter.....	HC-5801
Hydraulic Oil Filter.....	HC-55170
Hydraulic Oil Filter.....	H-5522
Oil Filter Full Flow.....	C-5522
324D (EXCAVATORS) CAT S/N: JLS175-UP , 2006-UP	
Air Filter Secondary.....	A-5559
Air Filter Primary.....	A-5558
Air Filter.....	A-5584
Fuel Filter.....	FC-5517
Hydraulic Oil Filter.....	H-5522
Hydraulic Oil Filter.....	HC-5801
Oil Filter Full Flow.....	C-5522

MODEL/APPLICATION	SAKURA NO
CATERPILLAR	
324D (EXCAVATORS) CAT S/N: KHX1-UP , 2006-UP	
Air Filter Secondary.....	A-5559
Air Filter Primary.....	A-5558
Air Filter.....	A-5584
Cabin Air Filter.....	CA-55850
Fuel Filter.....	FC-5517
Hydraulic Oil Filter.....	H-5522
Hydraulic Oil Filter.....	HC-55170
Hydraulic Oil Filter.....	HC-5801
Oil Filter Full Flow.....	C-5522
324D (EXCAVATORS) CAT S/N: LAB1-UP , 2006-UP	
Air Filter Secondary.....	A-5559
Air Filter Primary.....	A-5558
Cabin Air Filter.....	CA-55850
Fuel Filter.....	FC-5517
Hydraulic Oil Filter.....	H-5522
Hydraulic Oil Filter.....	HC-5801
Hydraulic Oil Filter.....	HC-55170
Oil Filter Full Flow.....	C-5522
324D (EXCAVATORS) CAT S/N: SYM1-UP , 2006-UP	
Air Filter Secondary.....	A-5559
Air Filter Primary.....	A-5558
Cabin Air Filter.....	CA-55850
Fuel Filter.....	FC-5517
Hydraulic Oil Filter.....	H-5522
Hydraulic Oil Filter.....	HC-5801
Hydraulic Oil Filter.....	HC-55170
Oil Filter Full Flow.....	C-5522
324D (EXCAVATORS) CAT S/N: T2D1-UP , 2006-UP	
Air Filter Secondary.....	A-5559
Air Filter Primary.....	A-5558
Cabin Air Filter.....	CA-55850
Fuel Filter.....	FC-5517
Hydraulic Oil Filter.....	HC-55170
Hydraulic Oil Filter.....	HC-5801
Hydraulic Oil Filter.....	H-5522
Oil Filter Full Flow.....	C-5522
324D (EXCAVATORS) CAT C7 ACERT	
Hydraulic Oil Filter.....	HC-9901
324DL (EXCAVATORS)	
Cabin Air Filter.....	CA-55170
Cabin Air Filter.....	CAC-55170
Cabin Air Filter.....	CAV-55170
324E (EXCAVATORS) CAT C7.1	
Fuel Filter.....	EF-55050
324E L (EXCAVATORS) CAT C7.1	
Fuel Filter.....	EF-55050
324E LN (EXCAVATORS) CAT C7.1	

MODEL/APPLICATION	SAKURA NO	MODEL/APPLICATION	SAKURA NO	MODEL/APPLICATION	SAKURA NO
CATERPILLAR		CATERPILLAR		CATERPILLAR	
324E LN (EXCAVATORS) CAT C7.1 Fuel Filter..... EF-55050		Fuel Filter..... FC-5516 Hydraulic Oil Filter..... HC-5505 Hydraulic Oil Filter..... H-5505 Oil Filter Full Flow..... C-5510		Fuel Filter Secondary..... FC-5515 Fuel Filter..... F-5505 Fuel Filter..... FC-5508 Fuel Filter Secondary..... FC-55151 Hydraulic Oil Filter..... H-5505 Hydraulic Oil Filter..... HC-5505 Oil Filter Full Flow..... C-5510	
325 (EXCAVATORS) CAT 3116 (S/N: 2JK1-UP) Air Filter Primary..... A-6006 Air Filter Secondary..... A-6007 Air Filter Set..... A-6118-S Fuel Filter..... F-5505 Fuel Filter Secondary..... FC-5515 Fuel Filter..... FC-5516 Fuel Filter Secondary..... FC-55151 Hydraulic Oil Filter..... H-5505 Hydraulic Oil Filter..... HC-5505 Oil Filter Full Flow..... C-5510		325 (EXCAVATORS) CAT 3116 (S/N: 6KK1-UP) Air Filter Primary..... A-6006 Air Filter Secondary..... A-6007 Air Filter Set..... A-6118-S Fuel Filter Secondary..... FC-55151 Fuel Filter..... FC-5516 Fuel Filter Secondary..... FC-5515 Fuel Filter..... F-5505 Hydraulic Oil Filter..... H-5505 Hydraulic Oil Filter..... HC-5505 Oil Filter Full Flow..... C-5510		325 (EXCAVATORS) CAT 3116 (S/N: 7TG1-UP) Air Filter Primary..... A-6006 Air Filter Set..... A-6118-S Air Filter Secondary..... A-6007 Fuel Filter..... F-5505 Fuel Filter Secondary..... FC-5515 Fuel Filter..... FC-5516 Fuel Filter Secondary..... FC-55151 Hydraulic Oil Filter..... HC-5505 Hydraulic Oil Filter..... H-5505 Oil Filter Full Flow..... C-5510	
325 (EXCAVATORS) CAT 3116 (S/N: 2SK1-UP) Air Filter Set..... A-6118-S Air Filter Primary..... A-6006 Air Filter Secondary..... A-6007 Fuel Filter..... FC-5516 Fuel Filter Secondary..... FC-5515 Fuel Filter..... F-5505 Fuel Filter Secondary..... FC-55151 Hydraulic Oil Filter..... HC-5505 Hydraulic Oil Filter..... H-5505 Oil Filter Full Flow..... C-5510		325 (EXCAVATORS) CAT 3116 (S/N: 6RM1-UP) Air Filter Set..... A-6118-S Air Filter Primary..... A-6006 Air Filter Secondary..... A-6007 Fuel Filter..... FC-5508 Fuel Filter Secondary..... FC-5515 Fuel Filter..... F-5505 Fuel Filter Secondary..... FC-55151 Fuel Filter..... FC-5516 Hydraulic Oil Filter..... H-5505 Hydraulic Oil Filter..... HC-5505 Oil Filter Full Flow..... C-5510		325 (EXCAVATORS) CAT 3116 (S/N: 8JG1-UP) Air Filter Secondary..... A-6007 Air Filter Set..... A-6118-S Air Filter Primary..... A-6006 Fuel Filter..... FC-5516 Fuel Filter..... F-5505 Fuel Filter Secondary..... FC-55151 Fuel Filter Secondary..... FC-5515 Hydraulic Oil Filter..... HC-5505 Hydraulic Oil Filter..... H-5505 Oil Filter Full Flow..... C-5510	
325 (EXCAVATORS) CAT 3116 (S/N: 2SL1-UP) Air Filter Set..... A-6118-S Air Filter Secondary..... A-6007 Air Filter Primary..... A-6006 Fuel Filter Secondary..... FC-55151 Fuel Filter Secondary..... FC-5515 Fuel Filter..... FC-5516 Fuel Filter..... F-5505 Hydraulic Oil Filter..... H-5505 Hydraulic Oil Filter..... HC-5505 Oil Filter Full Flow..... C-5510		325 (EXCAVATORS) CAT 3116 (S/N: 7CJ1-UP) Air Filter Primary..... A-6006 Air Filter Set..... A-6118-S Air Filter Secondary..... A-6007 Fuel Filter..... FC-5516 Fuel Filter..... F-5505 Fuel Filter Secondary..... FC-5515 Fuel Filter Secondary..... FC-55151 Hydraulic Oil Filter..... HC-5505 Hydraulic Oil Filter..... H-5505 Oil Filter Full Flow..... C-5510		325 (EXCAVATORS) CAT 3116 (S/N: 8NK1-UP) Air Filter Primary..... A-6006 Air Filter Secondary..... A-6007 Air Filter Set..... A-6118-S Fuel Filter Secondary..... FC-5515 Fuel Filter..... F-5505 Fuel Filter..... FC-5516 Fuel Filter Secondary..... FC-55151 Hydraulic Oil Filter..... HC-5505 Hydraulic Oil Filter..... H-5505 Oil Filter Full Flow..... C-5510	
325 (EXCAVATORS) CAT 3116 (S/N: 3LL1-UP) Air Filter Secondary..... A-6007 Air Filter Set..... A-6118-S Air Filter Primary..... A-6006 Fuel Filter..... F-5505 Fuel Filter Secondary..... FC-55151 Fuel Filter Secondary..... FC-5515 Fuel Filter..... FC-5516 Hydraulic Oil Filter..... HC-5505 Hydraulic Oil Filter..... H-5505 Oil Filter Full Flow..... C-5510		325 (EXCAVATORS) CAT 3116 (S/N: 7LJ1-UP) Air Filter Primary..... A-6006 Air Filter Secondary..... A-6007 Air Filter Set..... A-6118-S Fuel Filter Secondary..... FC-5515 Fuel Filter..... F-5505 Fuel Filter Secondary..... FC-55151 Fuel Filter..... FC-5516 Hydraulic Oil Filter..... H-5505 Hydraulic Oil Filter..... HC-5505 Oil Filter Full Flow..... C-5510		325 (EXCAVATORS) CAT 3116 (S/N: 8NL1-UP) Air Filter Secondary..... A-6007 Air Filter Primary..... A-6006 Air Filter Set..... A-6118-S Fuel Filter Secondary..... FC-5515 Fuel Filter..... FC-5516 Fuel Filter..... F-5505 Fuel Filter Secondary..... FC-55151 Hydraulic Oil Filter..... HC-5505 Hydraulic Oil Filter..... H-5505 Oil Filter Full Flow..... C-5510	
325 (EXCAVATORS) CAT 3116 (S/N: 5WK1-UP) Air Filter Secondary..... A-6007 Air Filter Primary..... A-6006 Air Filter Set..... A-6118-S Fuel Filter Secondary..... FC-55151 Fuel Filter Secondary..... FC-5515 Fuel Filter..... F-5505		325 (EXCAVATORS) CAT 3116 (S/N: 7LM1-UP) Air Filter Secondary..... A-6007 Air Filter Primary..... A-6006 Air Filter Set..... A-6118-S Fuel Filter..... FC-5516		325 (EXCAVATORS) CAT 3116 (S/N: 8YK1-UP) Air Filter Set..... A-6118-S Air Filter Primary..... A-6006	

MODEL/APPLICATION	SAKURA NO
CATERPILLAR	
325 (EXCAVATORS) CAT 3116 (S/N: 8YK1-UP)	
Air Filter Secondary.....	A-6007
Fuel Filter.....	F-5505
Fuel Filter Secondary.....	FC-55151
Fuel Filter.....	FC-5516
Fuel Filter Secondary.....	FC-5515
Hydraulic Oil Filter.....	HC-5505
Hydraulic Oil Filter.....	H-5505
Oil Filter Full Flow.....	C-5510
325 (EXCAVATORS) CAT 3116 (S/N: 9KL1-UP)	
Air Filter Primary.....	A-6006
Air Filter Set.....	A-6118-S
Air Filter Secondary.....	A-6007
Fuel Filter Secondary.....	FC-5515
Fuel Filter.....	FC-5516
Fuel Filter.....	F-5505
Fuel Filter Secondary.....	FC-55151
Hydraulic Oil Filter.....	HC-5505
Hydraulic Oil Filter.....	H-5505
Oil Filter Full Flow.....	C-5510
325 (EXCAVATORS) CAT 3116 (S/N: 9SG1-UP)	
Air Filter Set.....	A-6118-S
Air Filter Primary.....	A-6006
Air Filter Secondary.....	A-6007
Fuel Filter Secondary.....	FC-5515
Fuel Filter.....	F-5505
Fuel Filter.....	FC-5516
Fuel Filter Secondary.....	FC-55151
Hydraulic Oil Filter.....	H-5505
Hydraulic Oil Filter.....	HC-5505
Oil Filter Full Flow.....	C-5510
325 (EXCAVATORS) CAT 3116 (S/N: 9ZK1-UP)	
Air Filter Set.....	A-6118-S
Air Filter Primary.....	A-6006
Air Filter Secondary.....	A-6007
Fuel Filter Secondary.....	FC-55151
Fuel Filter Secondary.....	FC-5515
Fuel Filter.....	FC-5516
Fuel Filter.....	F-5505
Hydraulic Oil Filter.....	HC-5505
Hydraulic Oil Filter.....	H-5505
Oil Filter Full Flow.....	C-5510
325 (EXCAVATORS) S/N: 2SL00935-UP	
Air Filter Secondary.....	A-6007
Air Filter Primary.....	A-6006
Air Filter Set.....	A-6118-S
Cabin Air Filter.....	CA-55850
Fuel Filter Secondary.....	FC-55151
Fuel Filter Secondary.....	FC-5515

MODEL/APPLICATION	SAKURA NO
CATERPILLAR	
Fuel Filter.....	FC-5516
Hydraulic Oil Filter.....	HC-5505
Hydraulic Oil Filter.....	H-5503
Hydraulic Oil Filter.....	H-5505
Oil Filter Full Flow.....	C-5510
325B (EXCAVATORS) CAT 3116 (S/N: 2JR1-UP)	
Air Filter Primary.....	A-8508M
Air Filter Set.....	A-8508M-S
Air Filter Set.....	A-8604-S
Air Filter Secondary.....	A-8507
Air Filter Primary.....	A-8508
Fuel Filter Secondary.....	FC-5515
Fuel Filter Secondary.....	FC-55151
Fuel Filter.....	FC-5508
Fuel Filter.....	FC-5516
Hydraulic Oil Filter.....	HC-5505
Oil Filter Full Flow.....	C-5510
325B (EXCAVATORS) CAT 3116 (S/N: 6DN1-UP)	
Air Filter Primary.....	A-5549M
Air Filter Set.....	A-8604-S
Air Filter Set.....	A-5549M-S
Air Filter Primary.....	A-5549
Air Filter Set.....	A-8508M-S
Air Filter Primary.....	A-8508M
Air Filter Primary.....	A-8508
Air Filter Secondary.....	A-5550
Air Filter Secondary.....	A-8507
Fuel Filter Secondary.....	FC-55151
Fuel Filter.....	FC-5516
Fuel Filter.....	FC-5508
Fuel Filter Secondary.....	FC-5515
Hydraulic Oil Filter.....	HC-5801
Hydraulic Oil Filter.....	H-7942
Hydraulic Oil Filter.....	HC-5505
Oil Filter Full Flow.....	C-5510
325B (EXCAVATORS) CAT 3116 (S/N: 8FN1-UP)	
Air Filter Primary.....	A-5549
Air Filter Set.....	A-5549M-S
Air Filter Primary.....	A-8508M
Air Filter Secondary.....	A-8507
Air Filter Primary.....	A-5549M
Air Filter Set.....	A-8604-S
Air Filter Secondary.....	A-5550
Air Filter Set.....	A-8508M-S
Air Filter Primary.....	A-8508
Fuel Filter.....	FC-5516
Fuel Filter Secondary.....	FC-55151
Fuel Filter Secondary.....	FC-5515
Fuel Filter.....	FC-5508
Hydraulic Oil Filter.....	H-7942
Hydraulic Oil Filter.....	HC-5801
Hydraulic Oil Filter.....	HC-5505
Oil Filter Full Flow.....	C-5510
325B (EXCAVATORS) CAT 3116 (S/N: 8PR1-UP)	
Air Filter Set.....	A-8604-S

MODEL/APPLICATION	SAKURA NO
CATERPILLAR	
Air Filter Primary.....	A-5549
Air Filter Set.....	A-5549M-S
Air Filter Primary.....	A-8508M
Air Filter Secondary.....	A-8507
Air Filter Set.....	A-8508M-S
Air Filter Secondary.....	A-5550
Air Filter Primary.....	A-5549M
Air Filter Primary.....	A-8508
Fuel Filter Secondary.....	FC-55151
Fuel Filter Secondary.....	FC-5515
Fuel Filter.....	FC-5516
Fuel Filter.....	FC-5508
Hydraulic Oil Filter.....	HC-5801
Hydraulic Oil Filter.....	H-7942
Hydraulic Oil Filter.....	HC-5505
Oil Filter Full Flow.....	C-5510
325B (EXCAVATORS) CAT 3116 (S/N: 8RR1-UP)	
Air Filter Secondary.....	A-8507
Air Filter Primary.....	A-8508M
Air Filter Secondary.....	A-5550
Air Filter Primary.....	A-5549
Air Filter Primary.....	A-8508
Air Filter Set.....	A-8604-S
Air Filter Set.....	A-8508M-S
Air Filter Set.....	A-5549M-S
Air Filter Primary.....	A-5549M
Fuel Filter.....	FC-5516
Fuel Filter.....	FC-5508
Fuel Filter Secondary.....	FC-5515
Fuel Filter Secondary.....	FC-55151
Hydraulic Oil Filter.....	HC-5801
Hydraulic Oil Filter.....	H-7942
Hydraulic Oil Filter.....	HC-5505
Oil Filter Full Flow.....	C-5510
325B (EXCAVATORS) S/N: 4DS-UP	
Air Filter Set.....	A-5549M-S
Air Filter Primary.....	A-5549
Air Filter Secondary.....	A-5550
Air Filter Primary.....	A-5549M
Fuel Filter Secondary.....	FC-55151
Fuel Filter Secondary.....	FC-5515
Fuel Filter.....	FC-5516
Hydraulic Oil Filter.....	H-5510
Oil Filter Full Flow.....	C-5510
325B (EXCAVATORS) S/N: 6DN00657-UP	
Air Filter Secondary.....	A-5550
Air Filter Set.....	A-5549M-S
Air Filter Primary.....	A-5549M
Air Filter Primary.....	A-5549
Fuel Filter.....	FC-5516
Fuel Filter Secondary.....	FC-5515
Fuel Filter Secondary.....	FC-55151
Hydraulic Oil Filter.....	H-5510
Oil Filter Full Flow.....	C-5510
325B (EXCAVATORS) S/N: 8FN-UP	

MODEL/APPLICATION	SAKURA NO
CATERPILLAR	
325B (EXCAVATORS) S/N: 8FN-UP	
Air Filter Secondary.....	A-5550
Air Filter Primary.....	A-5549
Air Filter Set.....	A-5549M-S
Air Filter Primary.....	A-5549M
Fuel Filter Secondary.....	FC-5515
Fuel Filter Secondary.....	FC-55151
Fuel Filter.....	FC-5516
Hydraulic Oil Filter.....	H-5510
Oil Filter Full Flow.....	C-5510
325B (EXCAVATORS) S/N: 8GM1-UP	
Oil Filter Full Flow.....	C-5510
325B L (EXCAVATORS) CAT 3116 (S/N: 16S1-UP)	
Air Filter Secondary.....	A-8507
Air Filter Primary.....	A-8508M
Air Filter Set.....	A-8508M-S
Air Filter Primary.....	A-8508
Air Filter Set.....	A-8604-S
Fuel Filter.....	FC-5516
Fuel Filter Secondary.....	FC-55151
Fuel Filter Secondary.....	FC-5515
Fuel Filter.....	FC-5508
Hydraulic Oil Filter.....	HC-5801
Hydraulic Oil Filter.....	H-7942
Hydraulic Oil Filter.....	HC-5505
Oil Filter Full Flow.....	C-5510
325B L (EXCAVATORS) CAT 3116 (S/N: 2JR1-UP)	
Air Filter Secondary.....	A-5550
Air Filter Primary.....	A-8508M
Air Filter Primary.....	A-8508
Air Filter Primary.....	A-5549
Air Filter Set.....	A-8508M-S
Air Filter Set.....	A-5549M-S
Air Filter Primary.....	A-5549M
Air Filter Set.....	A-8604-S
Air Filter Secondary.....	A-8507
Fuel Filter Secondary.....	FC-5515
Fuel Filter.....	FC-5508
Fuel Filter.....	FC-5516
Fuel Filter Secondary.....	FC-55151
Hydraulic Oil Filter.....	H-7942
Hydraulic Oil Filter.....	HC-5801
Hydraulic Oil Filter.....	HC-5505
Oil Filter Full Flow.....	C-5510
325B L (EXCAVATORS) CAT 3116 (S/N: 4DS1-UP)	
Air Filter Primary.....	A-8508M
Air Filter Set.....	A-5549M-S
Air Filter Secondary.....	A-5550
Air Filter Primary.....	A-5549
Air Filter Secondary.....	A-8507
Air Filter Primary.....	A-5549M
Air Filter Set.....	A-8508M-S
Air Filter Primary.....	A-8508
Air Filter Set.....	A-8604-S

MODEL/APPLICATION	SAKURA NO
CATERPILLAR	
Fuel Filter.....	FC-5516
Fuel Filter.....	FC-5508
Fuel Filter Secondary.....	FC-5515
Fuel Filter Secondary.....	FC-55151
Hydraulic Oil Filter.....	HC-5801
Hydraulic Oil Filter.....	H-7942
Hydraulic Oil Filter.....	HC-5505
Oil Filter Full Flow.....	C-5510
325B L (EXCAVATORS) CAT 3116 (S/N: 5BS1-UP)	
Air Filter Secondary.....	A-8507
Air Filter Set.....	A-5549M-S
Air Filter Primary.....	A-5549M
Air Filter Set.....	A-8604-S
Air Filter Primary.....	A-8508M
Air Filter Primary.....	A-5549
Air Filter Secondary.....	A-5550
Air Filter Primary.....	A-8508
Air Filter Set.....	A-8508M-S
Fuel Filter.....	FC-5508
Fuel Filter.....	FC-5516
Fuel Filter Secondary.....	FC-5515
Fuel Filter Secondary.....	FC-55151
Hydraulic Oil Filter.....	H-7942
Hydraulic Oil Filter.....	HC-5505
Hydraulic Oil Filter.....	HC-5801
Oil Filter Full Flow.....	C-5510
325B L (EXCAVATORS) CAT 3116 (S/N: 6DN1-UP)	
Air Filter Secondary.....	A-8507
Air Filter Primary.....	A-8508M
Air Filter Set.....	A-8604-S
Air Filter Set.....	A-8508M-S
Air Filter Primary.....	A-8508
Cabin Air Filter.....	CA-55850
Fuel Filter Secondary.....	FC-55151
Fuel Filter Secondary.....	FC-5515
Fuel Filter.....	FC-5516
Fuel Filter.....	FC-5508
Hydraulic Oil Filter.....	HC-5505
Hydraulic Oil Filter.....	H-7942
Hydraulic Oil Filter.....	HC-5801
Oil Filter Full Flow.....	C-5510
325B L (EXCAVATORS) CAT 3116 (S/N: 8FN1-UP)	
Air Filter Primary.....	A-8508M
Air Filter Primary.....	A-8508
Air Filter Set.....	A-8508M-S
Air Filter Set.....	A-8604-S
Air Filter Secondary.....	A-8507
Cabin Air Filter.....	CA-55850
Fuel Filter.....	FC-5508
Fuel Filter Secondary.....	FC-5515
Fuel Filter Secondary.....	FC-55151
Fuel Filter.....	FC-5516
Hydraulic Oil Filter.....	H-7942
Hydraulic Oil Filter.....	HC-5801
Hydraulic Oil Filter.....	HC-5505
Oil Filter Full Flow.....	C-5510

MODEL/APPLICATION	SAKURA NO
CATERPILLAR	
325B L (EXCAVATORS) CAT 3116 (S/N: 8PR1-UP)	
Air Filter Secondary.....	A-8507
Air Filter Set.....	A-5549M-S
Air Filter Primary.....	A-5549M
Air Filter Primary.....	A-5549
Air Filter Set.....	A-8508M-S
Air Filter Primary.....	A-8508M
Air Filter Secondary.....	A-5550
Air Filter Set.....	A-8604-S
Air Filter Primary.....	A-8508
Fuel Filter.....	FC-5508
Fuel Filter Secondary.....	FC-55151
Fuel Filter Secondary.....	FC-5515
Fuel Filter.....	FC-5516
Hydraulic Oil Filter.....	HC-5801
Hydraulic Oil Filter.....	H-7942
Hydraulic Oil Filter.....	HC-5505
Oil Filter Full Flow.....	C-5510
325B L (EXCAVATORS) CAT 3116 (S/N: 8RR1-UP)	
Air Filter Primary.....	A-5549
Air Filter Set.....	A-8508M-S
Air Filter Secondary.....	A-5550
Air Filter Primary.....	A-8508M
Air Filter Primary.....	A-8508
Air Filter Primary.....	A-5549M
Air Filter Set.....	A-5549M-S
Air Filter Set.....	A-8604-S
Air Filter Secondary.....	A-8507
Fuel Filter Secondary.....	FC-5515
Fuel Filter Secondary.....	FC-55151
Fuel Filter.....	FC-5508
Fuel Filter.....	FC-5516
Hydraulic Oil Filter.....	HC-5801
Hydraulic Oil Filter.....	H-7942
Hydraulic Oil Filter.....	HC-5505
Oil Filter Full Flow.....	C-5510
325C (EXCAVATORS) CAT 3126B	
Hydraulic Oil Filter.....	HC-9901
325C (EXCAVATORS) CAT 3126 (S/N: AMH1-UP)	
Air Filter Secondary.....	A-5559
Air Filter Primary.....	A-5558
Cabin Air Filter.....	CA-55850
Fuel Filter.....	FC-5517
Hydraulic Oil Filter.....	HC-55170
Hydraulic Oil Filter.....	HC-5801
Hydraulic Oil Filter.....	H-7942
Oil Filter Full Flow.....	C-5510
325C (EXCAVATORS) CAT 3126 (S/N: BFE1-474-UP)	
Air Filter Secondary.....	A-5559
Air Filter Primary.....	A-5558
Cabin Air Filter.....	CA-55850
Fuel Filter.....	FC-5517
Hydraulic Oil Filter.....	H-7942
Hydraulic Oil Filter.....	HC-5801

MODEL/APPLICATION	SAKURA NO	MODEL/APPLICATION	SAKURA NO	MODEL/APPLICATION	SAKURA NO
CATERPILLAR		CATERPILLAR		CATERPILLAR	
325C (EXCAVATORS) CAT 3126 (S/N: BFE1-474-UP) Hydraulic Oil Filter..... HC-55170 Oil Filter Full Flow..... C-5510		Hydraulic Oil Filter..... H-5522 Hydraulic Oil Filter..... HC-5801 Oil Filter Full Flow..... C-5510		Hydraulic Oil Filter..... HC-55170 Hydraulic Oil Filter..... HC-5801 Oil Filter Full Flow..... C-5510	
325C (EXCAVATORS) CAT 3126 (S/N: BFE1-UP) Air Filter Primary..... A-5558 Air Filter Secondary..... A-5559 Cabin Air Filter..... CA-55850 Fuel Filter..... FC-5517 Hydraulic Oil Filter..... H-7942 Hydraulic Oil Filter..... HC-55170 Hydraulic Oil Filter..... HC-5801 Oil Filter Full Flow..... C-5510		325C (EXCAVATORS) CAT 3126 (S/N: CSJ1-UP) Air Filter Primary..... A-5558 Air Filter Secondary..... A-5559 Cabin Air Filter..... CA-55850 Fuel Filter..... FC-5517 Hydraulic Oil Filter..... H-5522 Hydraulic Oil Filter..... HC-5801 Oil Filter Full Flow..... C-5510		325C L (EXCAVATORS) CAT 3126 (S/N: BKW1-UP) Air Filter Secondary..... A-5559 Air Filter Primary..... A-5558 Fuel Filter..... FC-5517 Hydraulic Oil Filter..... HC-5801 Hydraulic Oil Filter..... H-7942 Oil Filter Full Flow..... C-5510	
325C (EXCAVATORS) CAT 3126 (S/N: BFE475-UP) Air Filter Secondary..... A-5559 Air Filter Primary..... A-5558 Cabin Air Filter..... CA-55850 Fuel Filter..... FC-5517 Hydraulic Oil Filter..... HC-5801 Hydraulic Oil Filter..... HC-55170 Hydraulic Oil Filter..... H-7942 Oil Filter Full Flow..... C-5510		325C (EXCAVATORS) CAT 3126 (S/N: DTF1-UP) Air Filter Primary..... A-5558 Air Filter Secondary..... A-5559 Cabin Air Filter..... CA-55850 Fuel Filter..... FC-5517 Hydraulic Oil Filter..... H-5522 Hydraulic Oil Filter..... HC-5801 Oil Filter Full Flow..... C-5510		325C L (EXCAVATORS) CAT 3126 (S/N: BMM1-UP) Air Filter Primary..... A-5558 Air Filter Secondary..... A-5559 Fuel Filter..... FC-5517 Hydraulic Oil Filter..... HC-5801 Hydraulic Oil Filter..... H-7942 Oil Filter Full Flow..... C-5510	
325C (EXCAVATORS) CAT 3126 (S/N: BKW1-UP) Air Filter Secondary..... A-5559 Air Filter Primary..... A-5558 Cabin Air Filter..... CA-55850 Fuel Filter..... FC-5517 Hydraulic Oil Filter..... H-7942 Hydraulic Oil Filter..... HC-5801 Oil Filter Full Flow..... C-5510		325C (EXCAVATORS) CAT 3126 (S/N: JLC1-UP) Air Filter Secondary..... A-5559 Air Filter Primary..... A-5558 Cabin Air Filter..... CA-55850 Fuel Filter..... FC-5517 Hydraulic Oil Filter..... HC-5801 Hydraulic Oil Filter..... H-5522 Oil Filter Full Flow..... C-5510		325C L (EXCAVATORS) CAT 3126 (S/N: CRB1-UP) Air Filter Secondary..... A-5559 Air Filter Primary..... A-5558 Fuel Filter..... FC-5517 Hydraulic Oil Filter..... HC-5801 Hydraulic Oil Filter..... H-7942 Oil Filter Full Flow..... C-5510	
325C (EXCAVATORS) CAT 3126 (S/N: BMM1-UP) Air Filter Primary..... A-5558 Air Filter Secondary..... A-5559 Cabin Air Filter..... CA-55850 Fuel Filter..... FC-5517 Hydraulic Oil Filter..... HC-5801 Hydraulic Oil Filter..... H-7942 Oil Filter Full Flow..... C-5510		325C (EXCAVATORS) CAT 3126 (S/N: JLD1-UP) Air Filter Secondary..... A-5559 Air Filter Primary..... A-5558 Cabin Air Filter..... CA-55850 Fuel Filter..... FC-5517 Hydraulic Oil Filter..... HC-5801 Hydraulic Oil Filter..... H-5522 Oil Filter Full Flow..... C-5510		325C L (EXCAVATORS) CAT 3126 (S/N: CSJ1-UP) Air Filter Secondary..... A-5559 Air Filter Primary..... A-5558 Fuel Filter..... FC-5517 Hydraulic Oil Filter..... H-7942 Hydraulic Oil Filter..... HC-5801 Oil Filter Full Flow..... C-5510	
325C (EXCAVATORS) CAT 3126 (S/N: BTD1-UP) Air Filter Primary..... A-5558 Air Filter Secondary..... A-5559 Cabin Air Filter..... CA-55850 Fuel Filter..... FC-5517 Hydraulic Oil Filter..... HC-55170 Hydraulic Oil Filter..... H-7942 Hydraulic Oil Filter..... HC-5801 Oil Filter Full Flow..... C-5510		325C (EXCAVATORS) CAT 3126 (S/N: S2C1-UP) Air Filter Secondary..... A-5559 Air Filter Primary..... A-5558 Cabin Air Filter..... CA-55850 Fuel Filter..... FC-5517 Hydraulic Oil Filter..... HC-55170 Hydraulic Oil Filter..... HC-5801 Hydraulic Oil Filter..... H-7942 Oil Filter Full Flow..... C-5510		325C LN (EXCAVATORS) CAT 3116 (S/N: CRB1-UP) Air Filter Primary..... A-5558 Air Filter Secondary..... A-5559 Fuel Filter..... FC-5517 Hydraulic Oil Filter..... HC-5801 Hydraulic Oil Filter..... H-7942 Oil Filter Full Flow..... C-5510	
325C (EXCAVATORS) CAT 3126 (S/N: CRB1-UP) Air Filter Primary..... A-5558 Air Filter Secondary..... A-5559 Cabin Air Filter..... CA-55850 Fuel Filter..... FC-5517		325C L (EXCAVATORS) CAT 3116 (S/N: BFE1-UP) Air Filter Primary..... A-5558 Air Filter Secondary..... A-5559 Fuel Filter..... FC-5517 Hydraulic Oil Filter..... H-7942		325L (EXCAVATORS) CAT 3116 (S/N: 2JK1-UP) Air Filter Secondary..... A-6007 Air Filter Set..... A-6118-S Air Filter Primary..... A-6006 Cabin Air Filter..... CA-55850 Fuel Filter..... FC-5516 Fuel Filter Secondary..... FC-5515 Fuel Filter Secondary..... FC-55151 Fuel Filter..... F-5505 Fuel Filter Secondary..... FC-5507 Fuel Filter..... FC-5508 Hydraulic Oil Filter..... H-5505 Hydraulic Oil Filter..... HC-5505 Oil Filter Full Flow..... C-5510	

MODEL/APPLICATION	SAKURA NO
CATERPILLAR	
325L (EXCAVATORS) CAT 3116 (S/N: 2SK1-UP)	
Air Filter Secondary.....	A-6007
Air Filter Set.....	A-6118-S
Air Filter Primary.....	A-6006
Cabin Air Filter.....	CA-55850
Fuel Filter.....	FC-5516
Fuel Filter Secondary.....	FC-5515
Fuel Filter Secondary.....	FC-55151
Fuel Filter.....	FC-5508
Fuel Filter Secondary.....	FC-5507
Fuel Filter.....	F-5505
Hydraulic Oil Filter.....	H-5505
Hydraulic Oil Filter.....	HC-5505
Oil Filter Full Flow.....	C-5510
325L (EXCAVATORS) CAT 3116 (S/N: 2SL1-UP)	
Air Filter Set.....	A-6118-S
Air Filter Primary.....	A-6006
Air Filter Secondary.....	A-6007
Fuel Filter.....	FC-5516
Fuel Filter Secondary.....	FC-55151
Fuel Filter.....	F-5505
Fuel Filter Secondary.....	FC-5515
Fuel Filter.....	FC-5508
Hydraulic Oil Filter.....	H-5505
Hydraulic Oil Filter.....	HC-5505
Oil Filter Full Flow.....	C-5510
325L (EXCAVATORS) CAT 3116 (S/N: 3LL1-UP)	
Air Filter Secondary.....	A-6007
Air Filter Set.....	A-6118-S
Air Filter Primary.....	A-6006
Fuel Filter.....	F-5505
Fuel Filter Secondary.....	FC-5515
Fuel Filter.....	FC-5516
Fuel Filter Secondary.....	FC-55151
Fuel Filter.....	FC-5508
Hydraulic Oil Filter.....	HC-5505
Hydraulic Oil Filter.....	H-5505
Oil Filter Full Flow.....	C-5510
325L (EXCAVATORS) CAT 3116 (S/N: 5WK1-UP)	
Air Filter Secondary.....	A-6007
Air Filter Primary.....	A-6006
Air Filter Set.....	A-6118-S
Fuel Filter Secondary.....	FC-5515
Fuel Filter.....	FC-5516
Fuel Filter Secondary.....	FC-55151
Fuel Filter.....	F-5505
Fuel Filter.....	FC-5508
Hydraulic Oil Filter.....	H-5505
Hydraulic Oil Filter.....	HC-5505
Oil Filter Full Flow.....	C-5510
325L (EXCAVATORS) CAT 3116 (S/N: 6KK1-UP)	
Air Filter Primary.....	A-6006
Air Filter Set.....	A-6118-S
Air Filter Secondary.....	A-6007

MODEL/APPLICATION	SAKURA NO
CATERPILLAR	
Fuel Filter.....	FC-5508
Fuel Filter.....	F-5505
Fuel Filter.....	FC-5516
Fuel Filter Secondary.....	FC-55151
Fuel Filter Secondary.....	FC-5515
Hydraulic Oil Filter.....	HC-5505
Hydraulic Oil Filter.....	H-5505
Oil Filter Full Flow.....	C-5510
325L (EXCAVATORS) CAT 3116 (S/N: 6RM1-UP)	
Air Filter Secondary.....	A-6007
Air Filter Primary.....	A-6006
Air Filter Set.....	A-6118-S
Fuel Filter.....	FC-5516
Fuel Filter Secondary.....	FC-55151
Fuel Filter Secondary.....	FC-5515
Fuel Filter.....	F-5505
Fuel Filter.....	FC-5508
Hydraulic Oil Filter.....	HC-5505
Hydraulic Oil Filter.....	H-5505
Oil Filter Full Flow.....	C-5510
325L (EXCAVATORS) CAT 3116 (S/N: 7CJ1-UP)	
Air Filter Primary.....	A-6006
Air Filter Set.....	A-6118-S
Air Filter Secondary.....	A-6007
Fuel Filter Secondary.....	FC-55151
Fuel Filter.....	FC-5516
Fuel Filter Secondary.....	FC-5515
Fuel Filter.....	FC-5508
Fuel Filter.....	F-5505
Hydraulic Oil Filter.....	HC-5505
Hydraulic Oil Filter.....	H-5505
Oil Filter Full Flow.....	C-5510
325L (EXCAVATORS) CAT 3116 (S/N: 7LJ1-UP)	
Air Filter Secondary.....	A-6007
Air Filter Set.....	A-6118-S
Air Filter Primary.....	A-6006
Fuel Filter.....	FC-5516
Fuel Filter.....	F-5505
Fuel Filter.....	FC-5508
Fuel Filter Secondary.....	FC-55151
Fuel Filter Secondary.....	FC-5515
Hydraulic Oil Filter.....	H-5505
Hydraulic Oil Filter.....	HC-5505
Oil Filter Full Flow.....	C-5510
325L (EXCAVATORS) CAT 3116 (S/N: 7LM1-UP)	
Air Filter Secondary.....	A-6007
Air Filter Primary.....	A-6006
Air Filter Set.....	A-6118-S
Fuel Filter Secondary.....	FC-5515
Fuel Filter.....	F-5505
Fuel Filter.....	FC-5508
Fuel Filter Secondary.....	FC-55151
Fuel Filter.....	FC-5516
Hydraulic Oil Filter.....	HC-5505
Hydraulic Oil Filter.....	H-5505

MODEL/APPLICATION	SAKURA NO
CATERPILLAR	
Oil Filter Full Flow.....	C-5510
325L (EXCAVATORS) CAT 3116 (S/N: 7TG1-UP)	
Air Filter Secondary.....	A-6007
Air Filter Set.....	A-6118-S
Air Filter Primary.....	A-6006
Cabin Air Filter.....	CA-55850
Fuel Filter.....	FC-5508
Fuel Filter Secondary.....	FC-5515
Fuel Filter Secondary.....	FC-55151
Fuel Filter Secondary.....	FC-5507
Fuel Filter.....	F-5505
Fuel Filter.....	FC-5516
Hydraulic Oil Filter.....	HC-5505
Hydraulic Oil Filter.....	H-5505
Oil Filter Full Flow.....	C-5510
325L (EXCAVATORS) CAT 3116 (S/N: 8JG1-UP)	
Air Filter Set.....	A-6118-S
Air Filter Primary.....	A-6006
Air Filter Secondary.....	A-6007
Fuel Filter.....	FC-5508
Fuel Filter.....	FC-5516
Fuel Filter Secondary.....	FC-5515
Fuel Filter.....	F-5505
Fuel Filter Secondary.....	FC-55151
Hydraulic Oil Filter.....	H-5505
Hydraulic Oil Filter.....	HC-5505
Oil Filter Full Flow.....	C-5510
325L (EXCAVATORS) CAT 3116 (S/N: 8NK1-UP)	
Air Filter Secondary.....	A-6007
Air Filter Set.....	A-6118-S
Air Filter Primary.....	A-6006
Fuel Filter.....	FC-5508
Fuel Filter Secondary.....	FC-5515
Fuel Filter Secondary.....	FC-55151
Fuel Filter.....	FC-5516
Fuel Filter.....	F-5505
Hydraulic Oil Filter.....	HC-5505
Hydraulic Oil Filter.....	H-5505
Oil Filter Full Flow.....	C-5510
325L (EXCAVATORS) CAT 3116 (S/N: 8NL1-UP)	
Air Filter Secondary.....	A-6007
Air Filter Set.....	A-6118-S
Air Filter Primary.....	A-6006
Fuel Filter.....	F-5505
Fuel Filter.....	FC-5508
Fuel Filter Secondary.....	FC-55151
Fuel Filter.....	FC-5516
Fuel Filter Secondary.....	FC-5515
Hydraulic Oil Filter.....	H-5505
Hydraulic Oil Filter.....	HC-5505
Oil Filter Full Flow.....	C-5510
325L (EXCAVATORS) CAT 3116 (S/N: 8YK1-UP)	
Air Filter Set.....	A-6118-S
Air Filter Secondary.....	A-6007

MODEL/APPLICATION	SAKURA NO	MODEL/APPLICATION	SAKURA NO	MODEL/APPLICATION	SAKURA NO
CATERPILLAR		CATERPILLAR		CATERPILLAR	
325L (EXCAVATORS) CAT 3116 (S/N: 8YK1-UP) Air Filter Primary..... A-6006 Fuel Filter..... F-5505 Fuel Filter Secondary..... FC-5515 Fuel Filter..... FC-5508 Fuel Filter Secondary..... FC-55151 Fuel Filter..... FC-5516 Hydraulic Oil Filter..... HC-5505 Hydraulic Oil Filter..... H-5505 Oil Filter Full Flow..... C-5510		325D (EXCAVATORS) CAT C7 ACERT Hydraulic Oil Filter..... HC-9901 325D (EXCAVATORS) S/N: A3R1-504-UP Air Filter Secondary..... A-5559 Air Filter Primary..... A-5558 Cabin Air Filter..... CA-55850 Hydraulic Oil Filter..... HC-5801 Hydraulic Oil Filter..... HC-55170 Hydraulic Oil Filter..... H-5522		325D (EXCAVATORS) S/N: C8L167-UP Air Filter Secondary..... A-5559 Air Filter..... A-5584 Air Filter Primary..... A-5558 Hydraulic Oil Filter..... H-5522 Hydraulic Oil Filter..... HC-5801 325D (EXCAVATORS) S/N: C9M1-139-UP Air Filter Primary..... A-5558 Air Filter Secondary..... A-5559 Hydraulic Oil Filter..... H-5522 Hydraulic Oil Filter..... HC-55170 Hydraulic Oil Filter..... HC-5801	
325L (EXCAVATORS) CAT 3116 (S/N: 9K1-UP) Air Filter Primary..... A-6006 Air Filter Set..... A-6118-S Air Filter Secondary..... A-6007 Fuel Filter..... F-5505 Fuel Filter Secondary..... FC-55151 Fuel Filter Secondary..... FC-5515 Fuel Filter..... FC-5516 Fuel Filter..... FC-5508 Hydraulic Oil Filter..... HC-5505 Hydraulic Oil Filter..... H-5505 Oil Filter Full Flow..... C-5510		325D (EXCAVATORS) S/N: A3R505-UP Air Filter Secondary..... A-5559 Air Filter Primary..... A-5558 Cabin Air Filter..... CA-55850 Hydraulic Oil Filter..... HC-55170 Hydraulic Oil Filter..... HC-5801 Hydraulic Oil Filter..... H-5522		325D (EXCAVATORS) S/N: C9M140-UP Air Filter Primary..... A-5558 Air Filter Secondary..... A-5559 Hydraulic Oil Filter..... H-5522 Hydraulic Oil Filter..... HC-5801	
325L (EXCAVATORS) CAT 3116 (S/N: 9SG1-UP) Air Filter Primary..... A-6006 Air Filter Set..... A-6118-S Air Filter Secondary..... A-6007 Fuel Filter Secondary..... FC-5515 Fuel Filter..... FC-5516 Fuel Filter..... F-5505 Fuel Filter Secondary..... FC-55151 Fuel Filter..... FC-5508 Hydraulic Oil Filter..... HC-5505 Hydraulic Oil Filter..... H-5505 Oil Filter Full Flow..... C-5510		325D (EXCAVATORS) S/N: AZP1-UP Air Filter Primary..... A-5558 Air Filter Secondary..... A-5559 Cabin Air Filter..... CA-55850 Hydraulic Oil Filter..... HC-55170 Hydraulic Oil Filter..... H-5522 Hydraulic Oil Filter..... HC-5801		325D (EXCAVATORS) S/N: DBH1-UP Air Filter Secondary..... A-5559 Air Filter Primary..... A-5558 Cabin Air Filter..... CA-55850 Hydraulic Oil Filter..... HC-5801 Hydraulic Oil Filter..... HC-55170 Hydraulic Oil Filter..... H-5522	
325L (EXCAVATORS) CAT 3116 (S/N: 9ZK1-UP) Air Filter Set..... A-6118-S Air Filter Primary..... A-6006 Air Filter Secondary..... A-6007 Fuel Filter..... FC-5516 Fuel Filter..... F-5505 Fuel Filter Secondary..... FC-55151 Fuel Filter..... FC-5508 Hydraulic Oil Filter..... HC-5505 Hydraulic Oil Filter..... H-5505 Oil Filter Full Flow..... C-5510		325D (EXCAVATORS) S/N: C4H1-209-UP Air Filter Secondary..... A-5559 Air Filter Primary..... A-5558 Cabin Air Filter..... CA-55850 Hydraulic Oil Filter..... HC-55170 Hydraulic Oil Filter..... H-5522 Hydraulic Oil Filter..... HC-5801		325D (EXCAVATORS) S/N: GBR1-UP Air Filter Primary..... A-5558 Air Filter Secondary..... A-5559 Cabin Air Filter..... CA-55850 Hydraulic Oil Filter..... HC-55170 Hydraulic Oil Filter..... H-5522 Hydraulic Oil Filter..... HC-5801	
325L (EXCAVATORS) CAT 3116 (S/N: 9ZK1-UP) Air Filter Set..... A-6118-S Air Filter Primary..... A-6006 Air Filter Secondary..... A-6007 Fuel Filter..... FC-5516 Fuel Filter..... F-5505 Fuel Filter Secondary..... FC-55151 Fuel Filter..... FC-5508 Hydraulic Oil Filter..... H-5505 Hydraulic Oil Filter..... HC-5505 Oil Filter Full Flow..... C-5510		325D (EXCAVATORS) S/N: C4H210-UP Cabin Air Filter..... CA-55850 Hydraulic Oil Filter..... HC-55170 Hydraulic Oil Filter..... H-5522 Hydraulic Oil Filter..... HC-5801		325D (EXCAVATORS) S/N: GPB1-UP Air Filter Secondary..... A-5559 Air Filter Primary..... A-5558 Cabin Air Filter..... CA-55850 Hydraulic Oil Filter..... H-5522 Hydraulic Oil Filter..... HC-5801 Hydraulic Oil Filter..... HC-55170	
325D (EXCAVATORS) CAT S/N: C7C1-UP Fuel Filter..... FC-5517 Oil Filter Full Flow..... C-5522		325D (EXCAVATORS) S/N: C7K1-200-UP Air Filter Secondary..... A-5559 Air Filter Primary..... A-5558 Air Filter..... A-5584 Hydraulic Oil Filter..... HC-5801 Hydraulic Oil Filter..... HC-55170 Hydraulic Oil Filter..... H-5522		325D (EXCAVATORS) S/N: JCL1-UP Air Filter Secondary..... A-5559 Air Filter Primary..... A-5558 Cabin Air Filter..... CA-55850 Hydraulic Oil Filter..... H-5522 Hydraulic Oil Filter..... HC-5801 Hydraulic Oil Filter..... HC-55170	
325D (EXCAVATORS) CAT S/N: KHX1-UP Fuel Filter..... FC-5517 Oil Filter Full Flow..... C-5522		325D (EXCAVATORS) S/N: C8L1-166-UP Air Filter..... A-5584 Air Filter Primary..... A-5558 Air Filter Secondary..... A-5559 Hydraulic Oil Filter..... HC-5801 Hydraulic Oil Filter..... HC-55170 Hydraulic Oil Filter..... H-5522		325D (EXCAVATORS) S/N: KBE1-UP Air Filter Secondary..... A-5559 Air Filter Primary..... A-5558 Cabin Air Filter..... CA-55850	

MODEL/APPLICATION	SAKURA NO
CATERPILLAR	
325B L JA (EXCAVATORS) CAT 3116 (S/N: 8RR1-UP)	
Hydraulic Oil Filter.....	HC-5505
Oil Filter Full Flow.....	C-5510
325B L US (EXCAVATORS) CAT 3116 (S/N: 2JR1-UP)	
Air Filter Set.....	A-8508M-S
Air Filter Secondary.....	A-8507
Air Filter Primary.....	A-8508
Air Filter Set.....	A-8604-S
Air Filter Primary.....	A-8508M
Cabin Air Filter.....	CA-55850
Fuel Filter.....	FC-5508
Fuel Filter.....	FC-5516
Fuel Filter Secondary.....	FC-5515
Fuel Filter Secondary.....	FC-55151
Hydraulic Oil Filter.....	HC-5505
Hydraulic Oil Filter.....	H-7942
Hydraulic Oil Filter.....	HC-5801
Oil Filter Full Flow.....	C-5510
325B LN (EXCAVATORS) CAT 3116 (S/N: 4DS1-UP)	
Air Filter Set.....	A-8604-S
Air Filter Primary.....	A-8508
Air Filter Set.....	A-8508M-S
Air Filter Secondary.....	A-5550
Air Filter Primary.....	A-8508M
Air Filter Primary.....	A-5549
Air Filter Primary.....	A-5549M
Air Filter Secondary.....	A-8507
Air Filter Set.....	A-5549M-S
Fuel Filter Secondary.....	FC-5515
Fuel Filter Secondary.....	FC-55151
Fuel Filter.....	FC-5508
Fuel Filter.....	FC-5516
Hydraulic Oil Filter.....	H-7942
Hydraulic Oil Filter.....	HC-5505
Hydraulic Oil Filter.....	HC-5801
Oil Filter Full Flow.....	C-5510
325B LN (EXCAVATORS) CAT 3116 (S/N: 5BS1-UP)	
Air Filter Primary.....	A-8508M
Air Filter Set.....	A-5549M-S
Air Filter Primary.....	A-5549
Air Filter Primary.....	A-8508
Air Filter Set.....	A-8604-S
Air Filter Primary.....	A-5549M
Air Filter Secondary.....	A-5550
Air Filter Set.....	A-8508M-S
Air Filter Secondary.....	A-8507
Fuel Filter Secondary.....	FC-5515
Fuel Filter Secondary.....	FC-55151
Fuel Filter.....	FC-5516
Fuel Filter.....	FC-5508
Hydraulic Oil Filter.....	HC-5801
Hydraulic Oil Filter.....	H-7942
Oil Filter Full Flow.....	C-5510

MODEL/APPLICATION	SAKURA NO
CATERPILLAR	
325B LN (EXCAVATORS) CAT 3116 (S/N: 6DN1-UP)	
Air Filter Secondary.....	A-8507
Air Filter Primary.....	A-5549
Air Filter Primary.....	A-8508
Air Filter Set.....	A-8604-S
Air Filter Set.....	A-8508M-S
Air Filter Set.....	A-5549M-S
Air Filter Secondary.....	A-5550
Air Filter Primary.....	A-8508M
Air Filter Primary.....	A-5549M
Fuel Filter.....	FC-5508
Fuel Filter.....	FC-5516
Fuel Filter Secondary.....	FC-5515
Fuel Filter Secondary.....	FC-55151
Hydraulic Oil Filter.....	HC-5505
Hydraulic Oil Filter.....	HC-5801
Hydraulic Oil Filter.....	H-7942
Oil Filter Full Flow.....	C-5510
325B LN (EXCAVATORS) CAT 3116 (S/N: 8FN1-UP)	
Air Filter Set.....	A-8604-S
Air Filter Secondary.....	A-5550
Air Filter Primary.....	A-8508M
Air Filter Primary.....	A-5549M
Air Filter Set.....	A-5549M-S
Air Filter Secondary.....	A-8507
Air Filter Primary.....	A-5549
Air Filter Primary.....	A-8508
Air Filter Set.....	A-8508M-S
Fuel Filter Secondary.....	FC-5515
Fuel Filter.....	FC-5516
Fuel Filter.....	FC-5508
Fuel Filter Secondary.....	FC-55151
Hydraulic Oil Filter.....	HC-5801
Hydraulic Oil Filter.....	H-7942
Hydraulic Oil Filter.....	HC-5505
Oil Filter Full Flow.....	C-5510
325C FP (EXCAVATORS) CAT 3116	
Hydraulic Oil Filter.....	HC-9901
325C FP (EXCAVATORS) CAT 3116 (S/N: G1L1-UP)	
Air Filter Secondary.....	A-5559
Air Filter Primary.....	A-5558
Cabin Air Filter.....	CA-55850
Fuel Filter.....	FC-5517
Hydraulic Oil Filter.....	H-7942
Hydraulic Oil Filter.....	HC-55170
Hydraulic Oil Filter.....	HC-5801
Oil Filter Full Flow.....	C-5510
325C FP (EXCAVATORS) CAT 3116 (S/N: M2K1-UP)	
Air Filter Primary.....	A-5558
Air Filter Secondary.....	A-5559
Cabin Air Filter.....	CA-55850
Fuel Filter.....	FC-5517
Hydraulic Oil Filter.....	HC-5801
Hydraulic Oil Filter.....	H-7942

MODEL/APPLICATION	SAKURA NO
CATERPILLAR	
Hydraulic Oil Filter.....	HC-55170
Oil Filter Full Flow.....	C-5510
325C FP (EXCAVATORS) CAT 3116 (S/N: S3M1-UP)	
Air Filter Secondary.....	A-5559
Air Filter Primary.....	A-5558
Cabin Air Filter.....	CA-55850
Fuel Filter.....	FC-5517
Hydraulic Oil Filter.....	H-7942
Hydraulic Oil Filter.....	HC-5801
Hydraulic Oil Filter.....	HC-55170
Oil Filter Full Flow.....	C-5510
325C FP (EXCAVATORS) CAT 3116 (S/N: Y4P1-UP)	
Air Filter Primary.....	A-5558
Air Filter Secondary.....	A-5559
Cabin Air Filter.....	CA-55850
Fuel Filter.....	FC-5517
Hydraulic Oil Filter.....	HC-55170
Hydraulic Oil Filter.....	HC-5801
Hydraulic Oil Filter.....	H-7942
Oil Filter Full Flow.....	C-5510
325C MH (MATERIAL HANDLERS) CAT 3116 (S/N: DTF1-UP)	
Air Filter Secondary.....	A-5559
Air Filter Primary.....	A-5558
Cabin Air Filter.....	CA-55850
Fuel Filter.....	FC-5517
Hydraulic Oil Filter.....	H-5522
Hydraulic Oil Filter.....	HC-5801
Oil Filter Full Flow.....	C-5510
325C MH (MATERIAL HANDLERS) CAT 3116 (S/N: S2C1-UP)	
Air Filter Primary.....	A-5558
Air Filter Secondary.....	A-5559
Cabin Air Filter.....	CA-55850
Fuel Filter.....	FC-5517
Hydraulic Oil Filter.....	HC-55170
Hydraulic Oil Filter.....	H-7942
Hydraulic Oil Filter.....	HC-5801
Oil Filter Full Flow.....	C-5510
325F (EXCAVATORS) CAT C4.4	
Fuel Filter.....	EF-55050
325F LCR (EXCAVATORS) CAT C4.4	
Fuel Filter.....	EF-55050
326D2 L (EXCAVATORS)	
Cabin Air Filter.....	CA-55170
Cabin Air Filter.....	CAC-55170
Cabin Air Filter.....	CAV-55170
326F L (EXCAVATORS) CAT C7.1	
Fuel Filter.....	EF-55050
326F LN (EXCAVATORS) CAT C7.1	

MODEL/APPLICATION	SAKURA NO	MODEL/APPLICATION	SAKURA NO	MODEL/APPLICATION	SAKURA NO
CATERPILLAR		CATERPILLAR		CATERPILLAR	
326F LN (EXCAVATORS) CAT C7.1		329E (EXCAVATORS) CAT C7.1		Fuel Filter.....	F-5505
Fuel Filter.....	EF-55050	Fuel Filter.....	EF-55050	Hydraulic Oil Filter.....	H-5505
328d (EXCAVATORS) CAT S/N: GTN1-UP		329E LN (EXCAVATORS) CAT C7.1		Hydraulic Oil Filter.....	HC-5505
Air Filter Secondary.....	A-5559	Fuel Filter.....	EF-55050	Oil Filter Full Flow.....	C-5510
Air Filter Primary.....	A-5558	329F L (EXCAVATORS) CAT C7.1		330 (EXCAVATORS) CAT 3306 (S/N: 5YM1-UP)	
Fuel Filter.....	FC-5517	Fuel Filter.....	EF-55050	Air Filter Primary.....	A-28710
Hydraulic Oil Filter.....	H-5522	330 (EXCAVATORS) CAT 3116 (S/N: 6ZK1-UP)		Air Filter Secondary.....	A-7967
Hydraulic Oil Filter.....	HC-5801	Air Filter Set.....	A-28730-S	Air Filter Set.....	A-28730-S
Hydraulic Oil Filter.....	HC-55170	Air Filter Primary.....	A-28710	Air Filter Primary.....	A-28710
Oil Filter Full Flow.....	C-5522	Air Filter Secondary.....	A-7967	Air Filter Secondary.....	A-28730-S
328d (EXCAVATORS) CAT S/N: KHX1-UP		Fuel Filter Secondary.....	FC-5507	Fuel Filter Secondary.....	FC-5507
Air Filter Primary.....	A-5558	Fuel Filter.....	F-5505	Fuel Filter.....	F-5505
Air Filter Secondary.....	A-5559	Hydraulic Oil Filter.....	H-5505	Hydraulic Oil Filter.....	HC-5505
Fuel Filter.....	FC-5517	Hydraulic Oil Filter.....	HC-5505	Hydraulic Oil Filter.....	H-5505
Hydraulic Oil Filter.....	H-5522	Oil Filter Full Flow.....	C-5510	Oil Filter Full Flow.....	C-5510
Hydraulic Oil Filter.....	HC-55170	330 (EXCAVATORS) CAT 3304B (S/N: 6WJ1-UP)		330 (EXCAVATORS) CAT 3306 (S/N: 6SK1-UP)	
Hydraulic Oil Filter.....	HC-5801	Air Filter Set.....	A-28730-S	Air Filter Set.....	A-28730-S
Oil Filter Full Flow.....	C-5522	Air Filter Secondary.....	A-7967	Air Filter Secondary.....	A-7967
328d (EXCAVATORS) CAT S/N: MKR1-UP		Air Filter Primary.....	A-28710	Air Filter Primary.....	A-28710
Air Filter Primary.....	A-5558	Cabin Air Filter.....	CA-55850	Fuel Filter Secondary.....	FC-5507
Air Filter Secondary.....	A-5559	Fuel Filter.....	F-5505	Fuel Filter.....	F-5505
Fuel Filter.....	FC-5517	Fuel Filter Secondary.....	FC-5507	Hydraulic Oil Filter.....	HC-5505
Hydraulic Oil Filter.....	H-5522	Hydraulic Oil Filter.....	HC-5505	Hydraulic Oil Filter.....	H-5505
Hydraulic Oil Filter.....	HC-5801	Hydraulic Oil Filter.....	H-5505	Oil Filter Full Flow.....	C-5510
Hydraulic Oil Filter.....	HC-55170	Oil Filter Full Flow.....	C-5510	330 (EXCAVATORS) CAT 3306 (S/N: 6WJ1-UP)	
Oil Filter Full Flow.....	C-5522	330 (EXCAVATORS) CAT 3304B (S/N: 9NG1-UP)		Air Filter Set.....	A-28730-S
328d (EXCAVATORS) CAT C7 ACERT		Air Filter Primary.....	A-28710	Air Filter Primary.....	A-28710
Hydraulic Oil Filter.....	HC-9901	Air Filter Set.....	A-28730-S	Air Filter Secondary.....	A-7967
328D LCR (EXCAVATORS)		Air Filter Secondary.....	A-7967	Fuel Filter Secondary.....	FC-5507
Cabin Air Filter.....	CA-55170	Cabin Air Filter.....	CA-55850	Fuel Filter.....	F-5505
Cabin Air Filter.....	CAC-55170	Fuel Filter Secondary.....	FC-5507	Hydraulic Oil Filter.....	H-5505
Cabin Air Filter.....	CAV-55170	Fuel Filter.....	F-5505	Hydraulic Oil Filter.....	HC-5505
329E L (EXCAVATORS) CAT C7.1		Hydraulic Oil Filter.....	H-5505	Oil Filter Full Flow.....	C-5510
Fuel Filter.....	EF-55050	Hydraulic Oil Filter.....	HC-5505	330 (EXCAVATORS) CAT 3306 (S/N: 8CK1-UP)	
329E L (EXCAVATORS) CAT C7.1 ACERT		Oil Filter Full Flow.....	C-5510	Air Filter Secondary.....	A-7967
Hydraulic Oil Filter.....	HC-9901	330 (EXCAVATORS) CAT 3306 (S/N: 2EL1-UP)		Air Filter Set.....	A-28730-S
329E L (EXCAVATORS)		Air Filter Set.....	A-28730-S	Air Filter Secondary.....	A-7967
Cabin Air Filter.....	CAV-55170	Air Filter Secondary.....	A-7967	Air Filter Set.....	A-28730-S
Cabin Air Filter.....	CA-55170	Air Filter Primary.....	A-28710	Air Filter Primary.....	A-28710
Cabin Air Filter.....	CAC-55170	Fuel Filter.....	F-5505	Fuel Filter Secondary.....	FC-5507
Fuel Filter.....	EF-55030	Fuel Filter Secondary.....	FC-5507	Fuel Filter.....	F-5505
329D L (EXCAVATORS)		Hydraulic Oil Filter.....	H-5505	Hydraulic Oil Filter.....	H-5505
Cabin Air Filter.....	CA-55170	Hydraulic Oil Filter.....	HC-5505	Hydraulic Oil Filter.....	HC-5505
Cabin Air Filter.....	CAC-55170	Oil Filter Full Flow.....	C-5510	Oil Filter Full Flow.....	C-5510
Cabin Air Filter.....	CAV-55170	330 (EXCAVATORS) CAT 3306 (S/N: 2ZM1-UP)		330 (EXCAVATORS) CAT 3306 (S/N: 8RL1-UP)	
329E L (EXCAVATORS)		Air Filter Set.....	A-28730-S	Air Filter Secondary.....	A-7967
Cabin Air Filter.....	CAV-55170	Air Filter Primary.....	A-28710	Air Filter Set.....	A-28730-S
Cabin Air Filter.....	CAC-55170	Air Filter Secondary.....	A-7967	Air Filter Primary.....	A-28710
Fuel Filter.....	EF-55030	Fuel Filter Secondary.....	FC-5507		

MODEL/APPLICATION	SAKURA NO
CATERPILLAR	
330 L (EXCAVATORS) CAT 3304B (S/N: 9NG1-UP)	
Hydraulic Oil Filter.....	HC-5505
Oil Filter Full Flow.....	C-5510
330 L (EXCAVATORS) CAT 3304B (S/N: 9PJ1-UP)	
Air Filter Primary.....	A-28710
Air Filter Set.....	A-28730-S
Air Filter Secondary.....	A-7967
Fuel Filter.....	F-5505
Fuel Filter Secondary.....	FC-5507
Hydraulic Oil Filter.....	HC-5505
Hydraulic Oil Filter.....	H-5505
Oil Filter Full Flow.....	C-5510
330 L (EXCAVATORS) CAT 3304B (S/N: 9WJ1-UP)	
Air Filter Set.....	A-28730-S
Air Filter Secondary.....	A-7967
Air Filter Primary.....	A-28710
Fuel Filter.....	F-5505
Fuel Filter Secondary.....	FC-5507
Hydraulic Oil Filter.....	HC-5505
Hydraulic Oil Filter.....	H-5505
Oil Filter Full Flow.....	C-5510
330 L (EXCAVATORS) CAT 3306 (S/N: 2ZM1-UP)	
Air Filter Primary.....	A-28710
Air Filter Set.....	A-28730-S
Air Filter Secondary.....	A-7967
Fuel Filter Secondary.....	FC-5507
Fuel Filter.....	F-5505
Hydraulic Oil Filter.....	HC-5505
Hydraulic Oil Filter.....	H-5505
Oil Filter Full Flow.....	C-5510
330 L (EXCAVATORS) CAT 3306 (S/N: 5YM1-UP)	
Air Filter Secondary.....	A-7967
Air Filter Primary.....	A-28710
Air Filter Set.....	A-28730-S
Fuel Filter.....	F-5505
Fuel Filter Secondary.....	FC-5507
Hydraulic Oil Filter.....	H-5505
Hydraulic Oil Filter.....	HC-5505
Oil Filter Full Flow.....	C-5510
330 L (EXCAVATORS) CAT 3306 (S/N: 6SK1-UP)	
Air Filter Set.....	A-28730-S
Air Filter Primary.....	A-28710
Air Filter Secondary.....	A-7967
Fuel Filter Secondary.....	FC-5507
Fuel Filter.....	F-5505
Hydraulic Oil Filter.....	HC-5505
Hydraulic Oil Filter.....	H-5505
Oil Filter Full Flow.....	C-5510
330 L (EXCAVATORS) CAT 3306 (S/N: 6WJ1-UP)	
Air Filter Secondary.....	A-7967
Air Filter Set.....	A-28730-S

MODEL/APPLICATION	SAKURA NO
CATERPILLAR	
Air Filter Primary.....	A-28710
Fuel Filter Secondary.....	FC-5507
Fuel Filter.....	F-5505
Hydraulic Oil Filter.....	H-5505
Hydraulic Oil Filter.....	HC-5505
Oil Filter Full Flow.....	C-5510
330 L (EXCAVATORS) CAT 3306 (S/N: 6ZK1-UP)	
Air Filter Secondary.....	A-7967
Air Filter Set.....	A-28730-S
Air Filter Primary.....	A-28710
Fuel Filter.....	F-5505
Fuel Filter Secondary.....	FC-5507
Hydraulic Oil Filter.....	HC-5505
Hydraulic Oil Filter.....	H-5505
Oil Filter Full Flow.....	C-5510
330 L (EXCAVATORS) CAT 3306 (S/N: 8CK1-UP)	
Air Filter Primary.....	A-28710
Air Filter Secondary.....	A-7967
Air Filter Set.....	A-28730-S
Fuel Filter Secondary.....	FC-5507
Fuel Filter.....	F-5505
Hydraulic Oil Filter.....	H-5505
Hydraulic Oil Filter.....	HC-5505
Oil Filter Full Flow.....	C-5510
330 L (EXCAVATORS) CAT 3306 (S/N: 8FK1-UP)	
Air Filter Primary.....	A-5509
Air Filter Set.....	A-28730-S
Air Filter Secondary.....	A-7967
Air Filter Primary.....	A-28710
Air Filter Set.....	A-5522-S
Fuel/Water Separator.....	SF-5704
Oil Filter Full Flow.....	C-5510
330 L (EXCAVATORS) CAT 3306 (S/N: 8RL1-UP)	
Air Filter Set.....	A-28730-S
Air Filter Primary.....	A-28710
Air Filter Secondary.....	A-7967
Fuel Filter.....	F-5505
Fuel Filter Secondary.....	FC-5507
Hydraulic Oil Filter.....	HC-5505
Hydraulic Oil Filter.....	H-5505
Oil Filter Full Flow.....	C-5510
330 L (EXCAVATORS) CAT 3306 (S/N: 9ML1-UP)	
Air Filter Primary.....	A-28710
Air Filter Set.....	A-28730-S
Air Filter Secondary.....	A-7967
Fuel Filter.....	F-5505
Fuel Filter Secondary.....	FC-5507
Hydraulic Oil Filter.....	H-5505
Hydraulic Oil Filter.....	HC-5505
Oil Filter Full Flow.....	C-5510
330 L (EXCAVATORS) CAT 3306 (S/N: 9NG1-UP)	
Air Filter Primary.....	A-28710
Air Filter Secondary.....	A-7967

MODEL/APPLICATION	SAKURA NO
CATERPILLAR	
Air Filter Set.....	A-28730-S
Fuel Filter.....	F-5505
Fuel Filter Secondary.....	FC-5507
Hydraulic Oil Filter.....	HC-5505
Hydraulic Oil Filter.....	H-5505
Oil Filter Full Flow.....	C-5510
330 L (EXCAVATORS) CAT 3306 (S/N: 9PJ1-UP)	
Air Filter Set.....	A-28730-S
Air Filter Secondary.....	A-7967
Air Filter Primary.....	A-28710
Fuel Filter Secondary.....	FC-5507
Fuel Filter.....	F-5505
Hydraulic Oil Filter.....	HC-5505
Hydraulic Oil Filter.....	H-5505
Oil Filter Full Flow.....	C-5510
330 L (EXCAVATORS) CAT 3306 (S/N: 9WJ1-UP)	
Air Filter Secondary.....	A-7967
Air Filter Set.....	A-28730-S
Air Filter Primary.....	A-28710
Fuel Filter.....	F-5505
Fuel Filter Secondary.....	FC-5507
Hydraulic Oil Filter.....	H-5505
Hydraulic Oil Filter.....	HC-5505
Oil Filter Full Flow.....	C-5510
330 L (EXCAVATORS) S/N: 2EL1-UP	
Air Filter Secondary.....	A-6007
Air Filter Primary.....	A-28710
Air Filter Set.....	A-28730-S
Fuel Filter Secondary.....	FC-5507
Hydraulic Oil Filter.....	H-5505
Oil Filter Full Flow.....	C-5510
330B (EXCAVATORS) CAT 3306 (S/N: 4RS1-UP)	
Air Filter Secondary.....	A-5559
Air Filter Primary.....	A-5558
Fuel Filter Secondary.....	FC-5507
Fuel Filter.....	F-5505
Hydraulic Oil Filter.....	HC-5505
Hydraulic Oil Filter.....	HC-5801
Hydraulic Oil Filter.....	H-7942
Oil Filter Full Flow.....	C-5510
330B (EXCAVATORS) CAT 3306 (S/N: 5LS1-UP)	
Air Filter Secondary.....	A-5559
Air Filter Primary.....	A-5558
Fuel Filter Secondary.....	FC-5507
Fuel Filter.....	F-5505
Hydraulic Oil Filter.....	HC-5801
Hydraulic Oil Filter.....	HC-5505
Hydraulic Oil Filter.....	H-7942
Oil Filter Full Flow.....	C-5510
330B (EXCAVATORS) CAT 3306 (S/N: 8SR1-UP)	
Air Filter Primary.....	A-5558
Air Filter Secondary.....	A-5559

MODEL/APPLICATION	SAKURA NO
CATERPILLAR	
330B (EXCAVATORS) CAT 3306 (S/N: 8SR1-UP)	
Fuel Filter.....	F-5505
Fuel Filter Secondary.....	FC-5507
Hydraulic Oil Filter.....	HC-5505
Hydraulic Oil Filter.....	H-7942
Hydraulic Oil Filter.....	HC-5801
Oil Filter Full Flow.....	C-5510
330B (EXCAVATORS) CAT 3306 (S/N: 8TR1-UP)	
Air Filter Primary.....	A-5558
Air Filter Secondary.....	A-5559
Fuel Filter.....	F-5505
Fuel Filter Secondary.....	FC-5507
Hydraulic Oil Filter.....	HC-5505
Hydraulic Oil Filter.....	H-7942
Hydraulic Oil Filter.....	HC-5801
Oil Filter Full Flow.....	C-5510
330B (EXCAVATORS) S/N: 4RS396-UP	
Air Filter Secondary.....	A-5559
Air Filter Primary.....	A-5558
Cabin Air Filter.....	CA-55850
Fuel Filter.....	F-5505
Fuel Filter Secondary.....	FC-5507
Hydraulic Oil Filter.....	HC-5801
Hydraulic Oil Filter.....	H-7942
Hydraulic Oil Filter.....	HC-5505
Oil Filter Full Flow.....	C-5510
330B (EXCAVATORS) S/N: 9HN1-UP	
Fuel Filter Secondary.....	FC-5507
330C L (EXCAVATORS) CAT C9 (S/N: CAP1-903-UP)	
Air Filter Secondary.....	A-8651
Cabin Air Filter.....	CA-55850
Fuel Filter.....	FC-5517
Fuel/Water Separator Secondary..	SFC-5504-10B
Fuel/Water Separator Secondary..	SFC-5504-10
Hydraulic Oil Filter.....	HC-5801
Hydraulic Oil Filter.....	H-5522
330C L (EXCAVATORS) CAT C9 (S/N: CAP1-UP)	
Air Filter Secondary.....	A-8651
Cabin Air Filter.....	CA-55850
Fuel Filter.....	FC-5517
Fuel/Water Separator Secondary..	SFC-5504-10B
Fuel/Water Separator Secondary..	SFC-5504-10
Hydraulic Oil Filter.....	HC-5801
Hydraulic Oil Filter.....	H-5522
330C L (EXCAVATORS) CAT C9 (S/N: CAP226-UP)	
Air Filter Secondary.....	A-8651
Cabin Air Filter.....	CA-55850
Fuel Filter.....	FC-5517
Fuel/Water Separator Secondary..	SFC-5504-10
Fuel/Water Separator Secondary..	SFC-5504-10B
Hydraulic Oil Filter.....	HC-5801
Hydraulic Oil Filter.....	H-5522

MODEL/APPLICATION	SAKURA NO
CATERPILLAR	
Hydraulic Oil Filter..... HC-5801	
330C L (EXCAVATORS) CAT C9 (S/N: CAP904-UP)	
Air Filter Secondary.....	A-8651
Cabin Air Filter.....	CA-55850
Fuel Filter.....	FC-5517
Fuel/Water Separator Secondary..	SFC-5504-10
Fuel/Water Separator Secondary..	SFC-5504-10B
Hydraulic Oil Filter.....	H-5522
Hydraulic Oil Filter.....	HC-5801
330C L (EXCAVATORS) CAT C9 (S/N: CGZ1-UP)	
Air Filter Secondary.....	A-8651
Fuel Filter.....	FC-5517
Hydraulic Oil Filter.....	HC-5801
Hydraulic Oil Filter.....	H-7942
Oil Filter Full Flow.....	C-5516
330C L (EXCAVATORS) CAT C9 (S/N: CYA1-UP)	
Air Filter Secondary.....	A-8651
Cabin Air Filter.....	CA-55850
Fuel Filter.....	FC-5517
Hydraulic Oil Filter.....	H-7942
Hydraulic Oil Filter.....	HC-5801
330C L (EXCAVATORS) CAT C9 (S/N: DKY1-1243-UP)	
Air Filter Secondary.....	A-8651
Cabin Air Filter.....	CA-55850
Fuel Filter.....	FC-5517
Fuel/Water Separator Secondary..	SFC-5504-10
Fuel/Water Separator Secondary..	SFC-5504-10B
Hydraulic Oil Filter.....	H-5522
Hydraulic Oil Filter.....	HC-5801
330C L (EXCAVATORS) CAT C9 (S/N: DKY1243-UP)	
Air Filter Secondary.....	A-8651
Cabin Air Filter.....	CA-55850
Fuel Filter.....	FC-5517
Fuel/Water Separator Secondary..	SFC-5504-10
Fuel/Water Separator Secondary..	SFC-5504-10B
Hydraulic Oil Filter.....	H-5522
Hydraulic Oil Filter.....	HC-5801
330C L (EXCAVATORS) CAT C9 (S/N: DKY1-UP)	
Air Filter Secondary.....	A-8651
Cabin Air Filter.....	CA-55850
Fuel Filter.....	FC-5517
Hydraulic Oil Filter.....	HC-55170
Hydraulic Oil Filter.....	HC-5801
Hydraulic Oil Filter.....	H-7942
330C L (EXCAVATORS) CAT C9 (S/N: GKX1-UP)	
Air Filter Secondary.....	A-8651
Cabin Air Filter.....	CA-55850
Fuel Filter.....	FC-5517
Hydraulic Oil Filter.....	HC-55170
Hydraulic Oil Filter.....	HC-5801
Hydraulic Oil Filter.....	H-7942

MODEL/APPLICATION	SAKURA NO
CATERPILLAR	
330C L (EXCAVATORS) CAT C9 (S/N: JAB1-UP)	
Air Filter Secondary.....	A-8651
Cabin Air Filter.....	CA-55850
Fuel Filter.....	FC-5517
Hydraulic Oil Filter.....	HC-5801
Hydraulic Oil Filter.....	H-7942
330C L (EXCAVATORS) CAT C9 (S/N: KDD1-UP)	
Air Filter Secondary.....	A-8651
Cabin Air Filter.....	CA-55850
Fuel Filter.....	FC-5517
Hydraulic Oil Filter.....	H-7942
Hydraulic Oil Filter.....	HC-5801
330C LN (EXCAVATORS) CAT C9 (S/N: CGZ1-UP)	
Air Filter Secondary.....	A-8651
Fuel Filter.....	FC-5517
Hydraulic Oil Filter.....	HC-5801
Hydraulic Oil Filter.....	H-7942
330C (EXCAVATORS) CAT C9 (S/N: CYA1-UP) , 2002-UP	
Air Filter Secondary.....	A-8651
Cabin Air Filter.....	CA-55850
Hydraulic Oil Filter.....	H-7942
Hydraulic Oil Filter.....	HC-5801
330C (EXCAVATORS) CAT C9	
Hydraulic Oil Filter.....	HC-9901
330C (EXCAVATORS) CAT C9 (S/N: DKY1-UP)	
Air Filter Secondary.....	A-8651
Cabin Air Filter.....	CA-55850
Fuel Filter.....	FC-5517
Hydraulic Oil Filter.....	HC-55170
Hydraulic Oil Filter.....	HC-5801
Hydraulic Oil Filter.....	H-7942
330C (EXCAVATORS) CAT C9 (S/N: GKX1-UP)	
Air Filter Secondary.....	A-8651
Cabin Air Filter.....	CA-55850
Hydraulic Oil Filter.....	HC-55170
Hydraulic Oil Filter.....	HC-5801
Hydraulic Oil Filter.....	H-7942
330C (EXCAVATORS) CAT C9 (S/N: JCD1-UP)	
Air Filter Secondary.....	A-8651
Cabin Air Filter.....	CA-55850
Fuel Filter.....	FC-5517
Hydraulic Oil Filter.....	HC-5801
Hydraulic Oil Filter.....	H-5522
Hydraulic Oil Filter.....	H-7942
330C (EXCAVATORS) CAT C9 (S/N: JNK1-UP)	
Air Filter Secondary.....	A-8651
Cabin Air Filter.....	CA-55850
Fuel Filter.....	FC-5517

MODEL/APPLICATION	SAKURA NO	MODEL/APPLICATION	SAKURA NO	MODEL/APPLICATION	SAKURA NO
CATERPILLAR		CATERPILLAR		CATERPILLAR	
330C (EXCAVATORS) CAT C9 (S/N: JNK1-UP) Fuel/Water Separator Secondary... SFC-5504-10 Fuel/Water Separator Secondary.. SFC-5504-10B Hydraulic Oil Filter..... H-5522 Hydraulic Oil Filter..... HC-5801 Hydraulic Oil Filter..... H-7942		330C MH (MATERIAL HANDLERS) CAT 3304B (S/N: MKM1-UP) Air Filter Secondary..... A-8651 Cabin Air Filter..... CA-55850 Fuel Filter..... FC-5517 Hydraulic Oil Filter..... HC-5801 Hydraulic Oil Filter..... H-5522		330D (EXCAVATORS) S/N: EAK350-UP Air Filter Secondary..... A-8651 Hydraulic Oil Filter..... HC-5801 Hydraulic Oil Filter..... HC-55170 Hydraulic Oil Filter..... H-5522	
330C (EXCAVATORS) CAT C9 (S/N: MCA1-UP) Air Filter Secondary..... A-8651 Cabin Air Filter..... CA-55850 Fuel Filter..... FC-5517 Hydraulic Oil Filter..... HC-55170 Hydraulic Oil Filter..... HC-5801 Hydraulic Oil Filter..... H-7942		330CLME (EXCAVATORS) 2004-UP Air Filter Secondary..... A-8651 Cabin Air Filter..... CA-55850 Fuel Filter..... FC-5517 Hydraulic Oil Filter..... H-7942 Hydraulic Oil Filter..... HC-5801		330D (EXCAVATORS) S/N: EDX1-UP Air Filter Secondary..... A-8651 Cabin Air Filter..... CA-55850 Hydraulic Oil Filter..... H-5522 Hydraulic Oil Filter..... HC-5801 Hydraulic Oil Filter..... HC-55170	
330C (EXCAVATORS) CAT C9 (S/N: MKM1-UP) Air Filter Secondary..... A-8651 Cabin Air Filter..... CA-55850 Fuel Filter..... FC-5517 Fuel/Water Separator Secondary.. SFC-5504-10 Fuel/Water Separator Secondary.. SFC-5504-10B Hydraulic Oil Filter..... HC-5801 Hydraulic Oil Filter..... H-5522		330D (EXCAVATORS) CAT S/N: THX1-UP Fuel Filter..... FC-5517		330D (EXCAVATORS) S/N: ERN1-UP Air Filter Secondary..... A-8651 Cabin Air Filter..... CA-55850 Hydraulic Oil Filter..... H-5522 Hydraulic Oil Filter..... HC-5801 Hydraulic Oil Filter..... HC-55170	
330C FP (EXCAVATORS) CAT 3304B Hydraulic Oil Filter..... HC-9901		330D (EXCAVATORS) CAT C9 ACERT Hydraulic Oil Filter..... HC-9901		330D (EXCAVATORS) S/N: FFK1-UP Air Filter Secondary..... A-8651 Cabin Air Filter..... CA-55850 Hydraulic Oil Filter..... HC-55170 Hydraulic Oil Filter..... HC-5801 Hydraulic Oil Filter..... H-5522	
330C FP (EXCAVATORS) CAT 3304B (S/N: B1K1-UP) Air Filter Secondary..... A-8651 Cabin Air Filter..... CA-55850 Fuel Filter..... FC-5517 Hydraulic Oil Filter..... HC-5801 Hydraulic Oil Filter..... HC-55170 Hydraulic Oil Filter..... H-7942		330D (EXCAVATORS) S/N: B6H1-UP Air Filter Secondary..... A-8651 Cabin Air Filter..... CA-55850 Hydraulic Oil Filter..... H-5522 Hydraulic Oil Filter..... HC-5801 Hydraulic Oil Filter..... HC-55170		330D (EXCAVATORS) S/N: GGE1-UP Air Filter Secondary..... A-8651 Cabin Air Filter..... CA-55850 Hydraulic Oil Filter..... H-5522 Hydraulic Oil Filter..... HC-5801 Hydraulic Oil Filter..... HC-55170	
330C FP (EXCAVATORS) CAT 3304B (S/N: B2L1-UP) Air Filter Secondary..... A-8651 Fuel Filter..... FC-5517 Hydraulic Oil Filter..... H-7942 Hydraulic Oil Filter..... HC-5801 Hydraulic Oil Filter..... HC-55170		330D (EXCAVATORS) S/N: C5K1-222-UP Air Filter Secondary..... A-8651 Cabin Air Filter..... CA-55850 Hydraulic Oil Filter..... H-5522 Hydraulic Oil Filter..... HC-5801 Hydraulic Oil Filter..... HC-55170		330D (EXCAVATORS) S/N: H3K1-UP Air Filter..... A-5584 Air Filter Secondary..... A-8651 Hydraulic Oil Filter..... H-5522 Hydraulic Oil Filter..... HC-55170 Hydraulic Oil Filter..... HC-5801	
330C FP (EXCAVATORS) CAT 3304B (S/N: B3M1-UP) Air Filter Secondary..... A-8651 Cabin Air Filter..... CA-55850 Fuel Filter..... FC-5517 Hydraulic Oil Filter..... H-7942 Hydraulic Oil Filter..... HC-55170 Hydraulic Oil Filter..... HC-5801		330D (EXCAVATORS) S/N: C5K223-UP Air Filter Secondary..... A-8651 Cabin Air Filter..... CA-55850 Hydraulic Oil Filter..... HC-5801 Hydraulic Oil Filter..... HC-55170 Hydraulic Oil Filter..... H-5522		330D (EXCAVATORS) S/N: HAS1-UP Air Filter Secondary..... A-8651 Cabin Air Filter..... CA-55850 Hydraulic Oil Filter..... HC-5801 Hydraulic Oil Filter..... H-5522 Hydraulic Oil Filter..... HC-55170	
330C FP (EXCAVATORS) CAT 3304B (S/N: B4N1-UP) Air Filter Secondary..... A-8651 Cabin Air Filter..... CA-55850 Fuel Filter..... FC-5517 Hydraulic Oil Filter..... HC-55170 Hydraulic Oil Filter..... H-7942 Hydraulic Oil Filter..... HC-5801		330D (EXCAVATORS) S/N: E4K1-349-UP Air Filter Secondary..... A-8651 Hydraulic Oil Filter..... HC-55170 Hydraulic Oil Filter..... H-5522 Hydraulic Oil Filter..... HC-5801		330D (EXCAVATORS) S/N: JLP1-UP Air Filter Secondary..... A-8651 Cabin Air Filter..... CA-55850 Hydraulic Oil Filter..... H-5522 Hydraulic Oil Filter..... HC-55170 Hydraulic Oil Filter..... HC-5801	
330C FP (EXCAVATORS) CAT 3304B (S/N: B4N1-UP) Air Filter Secondary..... A-8651 Cabin Air Filter..... CA-55850 Fuel Filter..... FC-5517 Hydraulic Oil Filter..... HC-55170 Hydraulic Oil Filter..... H-7942 Hydraulic Oil Filter..... HC-5801		330D (EXCAVATORS) S/N: EAH1-UP Air Filter Secondary..... A-8651 Cabin Air Filter..... CA-55850 Hydraulic Oil Filter..... HC-55170 Hydraulic Oil Filter..... HC-5801 Hydraulic Oil Filter..... H-5522		330D (EXCAVATORS) S/N: L2K1-UP	

MODEL/APPLICATION	SAKURA NO	MODEL/APPLICATION	SAKURA NO	MODEL/APPLICATION	SAKURA NO
CATERPILLAR		CATERPILLAR		CATERPILLAR	
330D (EXCAVATORS) S/N: L2K1-UP Air Filter..... A-5584 Air Filter Secondary..... A-8651 Hydraulic Oil Filter..... H-5522 Hydraulic Oil Filter..... HC-5801 Hydraulic Oil Filter..... HC-55170		330D (EXCAVATORS) S/N: T2Y1-UP Air Filter Secondary..... A-8651 Cabin Air Filter..... CA-55850 Hydraulic Oil Filter..... HC-55170 Hydraulic Oil Filter..... H-5522 Hydraulic Oil Filter..... HC-5801		Hydraulic Oil Filter..... H-7942 Hydraulic Oil Filter..... HC-5505 Hydraulic Oil Filter..... HC-5801 Oil Filter Full Flow..... C-5510	
330D (EXCAVATORS) S/N: LEM1-190-UP Air Filter Secondary..... A-8651 Cabin Air Filter..... CA-55850 Hydraulic Oil Filter..... HC-5801 Hydraulic Oil Filter..... H-5522 Hydraulic Oil Filter..... HC-55170		330D (EXCAVATORS) S/N: THJ1-UP Air Filter Secondary..... A-8651 Cabin Air Filter..... CA-55850 Hydraulic Oil Filter..... HC-55170 Hydraulic Oil Filter..... HC-5801 Hydraulic Oil Filter..... H-5522		330B L (EXCAVATORS) CAT 3306 (S/N: 5LS1-UP) Air Filter Primary..... A-5558 Air Filter Secondary..... A-5559 Fuel Filter Secondary..... FC-5507 Fuel Filter..... F-5505 Hydraulic Oil Filter..... HC-5801 Hydraulic Oil Filter..... HC-5505 Hydraulic Oil Filter..... H-7942 Oil Filter Full Flow..... C-5510	
330D (EXCAVATORS) S/N: LEM191-UP Air Filter Secondary..... A-8651 Cabin Air Filter..... CA-55850 Hydraulic Oil Filter..... HC-55170 Hydraulic Oil Filter..... HC-5801 Hydraulic Oil Filter..... H-5522		330 LME (EXCAVATORS) Air Filter Secondary..... A-7967 Air Filter Set..... A-28730-S Air Filter Primary..... A-28710 Hydraulic Oil Filter..... HC-5505 Hydraulic Oil Filter..... H-5505 Oil Filter Full Flow..... C-5510		330B L (EXCAVATORS) CAT 3306 (S/N: 6DR1-UP) Air Filter Primary..... A-5558 Air Filter Secondary..... A-5559 Fuel Filter Secondary..... FC-5507 Fuel Filter..... F-5505 Hydraulic Oil Filter..... HC-5801 Hydraulic Oil Filter..... H-7942 Hydraulic Oil Filter..... HC-5505 Oil Filter Full Flow..... C-5510	
330D (EXCAVATORS) S/N: MAG1-UP Air Filter Secondary..... A-8651 Cabin Air Filter..... CA-55850 Hydraulic Oil Filter..... HC-5801 Hydraulic Oil Filter..... HC-55170 Hydraulic Oil Filter..... H-5522		330B L (EXCAVATORS) CAT 3306 (S/N: 1JS1-UP) Air Filter Primary..... A-5558 Air Filter Secondary..... A-5559 Fuel Filter..... F-5505 Fuel Filter Secondary..... FC-5507 Hydraulic Oil Filter..... HC-5801 Hydraulic Oil Filter..... H-7942 Hydraulic Oil Filter..... HC-5505 Oil Filter Full Flow..... C-5510		330B L (EXCAVATORS) CAT 3306 (S/N: 8SR1-UP) Air Filter Secondary..... A-5559 Air Filter Primary..... A-5558 Fuel Filter Secondary..... FC-5507 Fuel Filter..... F-5505 Hydraulic Oil Filter..... HC-5505 Hydraulic Oil Filter..... HC-5801 Hydraulic Oil Filter..... H-7942 Oil Filter Full Flow..... C-5510	
330D (EXCAVATORS) S/N: MEY1-UP Air Filter Secondary..... A-8651 Cabin Air Filter..... CA-55850 Hydraulic Oil Filter..... HC-55170 Hydraulic Oil Filter..... HC-5801 Hydraulic Oil Filter..... H-5522		330B L (EXCAVATORS) CAT 3306 (S/N: 3YR1-UP) Air Filter Secondary..... A-5559 Air Filter Primary..... A-5558 Fuel Filter Secondary..... FC-5507 Fuel Filter..... F-5505 Hydraulic Oil Filter..... HC-5505 Hydraulic Oil Filter..... H-7942 Hydraulic Oil Filter..... HC-5801 Oil Filter Full Flow..... C-5510		330B L (EXCAVATORS) CAT 3306 (S/N: 8TR1-UP) Air Filter Primary..... A-5558 Air Filter Secondary..... A-5559 Fuel Filter..... F-5505 Fuel Filter Secondary..... FC-5507 Hydraulic Oil Filter..... HC-5505 Hydraulic Oil Filter..... HC-5801 Hydraulic Oil Filter..... H-7942 Oil Filter Full Flow..... C-5510	
330D (EXCAVATORS) S/N: MWP1-UP Air Filter Secondary..... A-8651 Cabin Air Filter..... CA-55850 Hydraulic Oil Filter..... H-5522 Hydraulic Oil Filter..... HC-55170 Hydraulic Oil Filter..... HC-5801		330B L (EXCAVATORS) CAT 3306 (S/N: 4RS1-UP) Air Filter Secondary..... A-5559 Air Filter Primary..... A-5558 Fuel Filter Secondary..... FC-5507 Fuel Filter..... F-5505 Hydraulic Oil Filter..... HC-5801 Hydraulic Oil Filter..... HC-5505 Hydraulic Oil Filter..... H-7942 Oil Filter Full Flow..... C-5510		330B L (EXCAVATORS) CAT 3306 (S/N: 3YR1-UP) Air Filter Secondary..... A-5559 Air Filter Primary..... A-5558 Fuel Filter Secondary..... FC-5507 Fuel Filter..... F-5505 Hydraulic Oil Filter..... HC-5505 Hydraulic Oil Filter..... HC-5801 Hydraulic Oil Filter..... H-7942 Oil Filter Full Flow..... C-5510	
330D (EXCAVATORS) S/N: NBD1-UP Air Filter Secondary..... A-8651 Cabin Air Filter..... CA-55850 Hydraulic Oil Filter..... HC-55170 Hydraulic Oil Filter..... HC-5801 Hydraulic Oil Filter..... H-5522		330B L (EXCAVATORS) CAT 3306 (S/N: 4RS1-UP) Air Filter Secondary..... A-5559 Air Filter Primary..... A-5558 Fuel Filter Secondary..... FC-5507 Fuel Filter..... F-5505 Hydraulic Oil Filter..... HC-5801 Hydraulic Oil Filter..... HC-5505 Hydraulic Oil Filter..... H-7942 Oil Filter Full Flow..... C-5510		330B L (EXCAVATORS) CAT 3306 (S/N: 8TR1-UP) Air Filter Primary..... A-5558 Air Filter Secondary..... A-5559 Fuel Filter..... F-5505 Fuel Filter Secondary..... FC-5507 Hydraulic Oil Filter..... HC-5505 Hydraulic Oil Filter..... HC-5801 Hydraulic Oil Filter..... H-7942 Oil Filter Full Flow..... C-5510	
330D (EXCAVATORS) S/N: RAS1-UP Air Filter Secondary..... A-8651 Cabin Air Filter..... CA-55850 Hydraulic Oil Filter..... HC-55170 Hydraulic Oil Filter..... H-5522 Hydraulic Oil Filter..... HC-5801		330B L (EXCAVATORS) CAT 3306 (S/N: 5LR1-UP) Air Filter Primary..... A-5558 Air Filter Secondary..... A-5559 Fuel Filter Secondary..... FC-5507 Fuel Filter..... F-5505		330B L US (EXCAVATORS) CAT 3304B (S/N: 6DR1-UP) Air Filter Primary..... A-5558 Air Filter Secondary..... A-5559	

MODEL/APPLICATION	SAKURA NO	MODEL/APPLICATION	SAKURA NO	MODEL/APPLICATION	SAKURA NO
CATERPILLAR		CATERPILLAR		CATERPILLAR	
330B L US (EXCAVATORS) CAT 3304B (S/N: 6DR1-UP)		Fuel Filter.....	EF-55050	340F (EXCAVATORS) W/C9.3L ENG.	
Cabin Air Filter.....	CA-55850	336D (EXCAVATORS)		Fuel/Water Separator.....	SFC-55250
Fuel Filter Secondary.....	FC-5507	Cabin Air Filter.....	CA-55170	340F L LRE (EXCAVATORS) W/C9.3L ENG.	
Fuel Filter.....	F-5505	Cabin Air Filter.....	CAV-55170	Fuel/Water Separator.....	SFC-55250
Hydraulic Oil Filter.....	H-7942	Cabin Air Filter.....	CAC-55170	340F L UHD (EXCAVATORS)	
Hydraulic Oil Filter.....	HC-5801	336D L (EXCAVATORS)		Cabin Air Filter.....	CAC-55170
Hydraulic Oil Filter.....	HC-5505	Cabin Air Filter.....	CA-55170	Cabin Air Filter.....	CA-55170
Oil Filter Full Flow.....	C-5510	Cabin Air Filter.....	CAV-55170	Cabin Air Filter.....	CAV-55170
330B LN (EXCAVATORS) CAT 3306 (S/N: 3YR1-UP)		336E L (EXCAVATORS) CAT C9.3 ACERT		345B (EXCAVATORS) CAT 3176 (S/N: 2NW1-UP)	
Air Filter Primary.....	A-5558	Hydraulic Oil Filter.....	HC-9901	Air Filter Set.....	A-5595-S
Air Filter Secondary.....	A-5559	336E L (EXCAVATORS)		Air Filter Primary.....	A-5593
Fuel Filter Secondary.....	FC-5507	Cabin Air Filter.....	CAC-55170	Air Filter Secondary.....	A-5594
Fuel Filter.....	F-5505	Cabin Air Filter.....	CA-55170	Fuel Filter.....	FC-5517
Hydraulic Oil Filter.....	HC-5505	Cabin Air Filter.....	CAV-55170	Fuel/Water Separator Secondary..	SFC-5504-10B
Hydraulic Oil Filter.....	HC-5801	336E (EXCAVATORS)		Fuel/Water Separator Secondary..	SFC-5504-10
Hydraulic Oil Filter.....	H-7942	Cabin Air Filter.....	CA-55170	Hydraulic Oil Filter.....	HC-5505
Oil Filter Full Flow.....	C-5510	Cabin Air Filter.....	CAC-55170	Hydraulic Oil Filter.....	H-7942
330B LN (EXCAVATORS) CAT 3306 (S/N: 5LR1-UP)		Cabin Air Filter.....	CAV-55170	Hydraulic Oil Filter.....	HC-5801
Air Filter Primary.....	A-5558	336E (EXCAVATORS)		Oil Filter Full Flow.....	C-5516
Air Filter Secondary.....	A-5559	Cabin Air Filter.....	CA-55170	345B (EXCAVATORS) CAT 3176 (S/N: 2SW1-UP)	
Fuel Filter Secondary.....	FC-5507	Cabin Air Filter.....	CAC-55170	Air Filter Set.....	A-5595-S
Fuel Filter.....	F-5505	Cabin Air Filter.....	CAV-55170	Air Filter Primary.....	A-5593
Hydraulic Oil Filter.....	HC-5801	336E (EXCAVATORS) W/C9.3L ENG.		Air Filter Secondary.....	A-5594
Hydraulic Oil Filter.....	HC-5505	Fuel/Water Separator.....	SFC-55250	Fuel Filter.....	FC-5517
Hydraulic Oil Filter.....	H-7942	336E LN (EXCAVATORS) W/C9.3L ENG.		Fuel/Water Separator Secondary..	SFC-5504-10
Oil Filter Full Flow.....	C-5510	Fuel/Water Separator.....	SFC-55250	Fuel/Water Separator Secondary..	SFC-5504-10B
330D2 (EXCAVATORS)		336F (EXCAVATORS)		Hydraulic Oil Filter.....	H-7942
Cabin Air Filter.....	CA-55170	Cabin Air Filter.....	CA-55170	Hydraulic Oil Filter.....	HC-5801
Cabin Air Filter.....	CAC-55170	Cabin Air Filter.....	CAC-55170	Hydraulic Oil Filter.....	HC-5505
Cabin Air Filter.....	CAV-55170	Cabin Air Filter.....	CAV-55170	Oil Filter Full Flow.....	C-5516
330F (EXCAVATORS) CAT C7.1 ACERT , 7100		336F (EXCAVATORS) W/C9.3L ENG.		345B (EXCAVATORS) CAT 3176 (S/N: 2ZW1-UP)	
Oil Filter Full Flow.....	E0-55010	Fuel/Water Separator.....	SFC-55250	Air Filter Primary.....	A-8665M
330F (EXCAVATORS) CAT C7.1		336F XE (EXCAVATORS) W/C9.3L ENG.		Air Filter Secondary.....	A-8580
Fuel Filter.....	EF-55050	Fuel/Water Separator.....	SFC-55250	Fuel Filter.....	FC-5517
330F (EXCAVATORS)		336D2 L (EXCAVATORS)		Fuel/Water Separator Secondary..	SFC-5504-10
Cabin Air Filter.....	CAV-55170	Cabin Air Filter.....	CA-55170	Fuel/Water Separator Secondary..	SFC-5504-10B
Cabin Air Filter.....	CA-55170	Cabin Air Filter.....	CAC-55170	Hydraulic Oil Filter.....	HC-5505
Cabin Air Filter.....	CAC-55170	Cabin Air Filter.....	CAV-55170	Hydraulic Oil Filter.....	H-7942
330F L (EXCAVATORS) CAT C7.1		336F L (EXCAVATORS)		Hydraulic Oil Filter.....	HC-5801
Fuel Filter.....	EF-55050	Cabin Air Filter.....	CAV-55170	Oil Filter Full Flow.....	C-5516
330F LN (EXCAVATORS) CAT C7.1		336F (EXCAVATORS) W/C9.3L ENG.		345B (EXCAVATORS) CAT 3176 (S/N: 3MW1-UP)	
Fuel Filter.....	EF-55050	Fuel/Water Separator.....	SFC-55250	Air Filter Primary.....	A-8665M
335F (EXCAVATORS) CAT C7.1		340F (EXCAVATORS)		Air Filter Secondary.....	A-8580
Fuel Filter.....	EF-55050	Cabin Air Filter.....	CA-55170	Fuel Filter.....	FC-5517
335F LCR (EXCAVATORS) CAT C7.1		Cabin Air Filter.....	CA-55170	Fuel/Water Separator Secondary..	SFC-5504-10
Fuel Filter.....	EF-55050	Cabin Air Filter.....	CAC-55170	Fuel/Water Separator Secondary..	SFC-5504-10B
		Cabin Air Filter.....	CAV-55170	Hydraulic Oil Filter.....	HC-5505
				Hydraulic Oil Filter.....	H-7942
				Hydraulic Oil Filter.....	HC-5801
				Oil Filter Full Flow.....	C-5516

MODEL/APPLICATION	SAKURA NO
CATERPILLAR	
345B (EXCAVATORS) CAT 3176 (S/N: 4SS1-UP)	
Air Filter Set.....	A-5595-S
Air Filter Secondary.....	A-5594
Air Filter Primary.....	A-5593
Fuel Filter.....	FC-5517
Fuel/Water Separator Secondary..	SFC-5504-10
Fuel/Water Separator Secondary..	SFC-5504-10B
Hydraulic Oil Filter.....	H-7942
Hydraulic Oil Filter.....	HC-5505
Hydraulic Oil Filter.....	HC-5801
Oil Filter Full Flow.....	C-5516
345B (EXCAVATORS) CAT 3176 (S/N: 7KS1-UP)	
Air Filter Primary.....	A-5593
Air Filter Set.....	A-5595-S
Air Filter Secondary.....	A-5594
Fuel Filter.....	FC-5517
Fuel/Water Separator Secondary..	SFC-5504-10B
Fuel/Water Separator Secondary..	SFC-5504-10
Hydraulic Oil Filter.....	H-7942
Hydraulic Oil Filter.....	HC-5801
Hydraulic Oil Filter.....	HC-5505
Oil Filter Full Flow.....	C-5516
345B (EXCAVATORS) CAT 3176 (S/N: 9GS1-UP)	
Air Filter Set.....	A-5595-S
Air Filter Primary.....	A-5593
Air Filter Secondary.....	A-5594
Fuel Filter.....	FC-5517
Fuel/Water Separator Secondary..	SFC-5504-10
Fuel/Water Separator Secondary..	SFC-5504-10B
Hydraulic Oil Filter.....	H-7942
Hydraulic Oil Filter.....	HC-5505
Hydraulic Oil Filter.....	HC-5801
Oil Filter Full Flow.....	C-5516
345B (EXCAVATORS) CAT 3176 (S/N: AGS1-UP)	
Air Filter Set.....	A-5595-S
Air Filter Primary.....	A-5593
Air Filter Secondary.....	A-5594
Cabin Air Filter.....	CA-55850
Fuel Filter.....	FC-5517
Fuel/Water Separator Secondary..	SFC-5504-10B
Fuel/Water Separator Secondary..	SFC-5504-10
Hydraulic Oil Filter.....	HC-5505
Hydraulic Oil Filter.....	H-7942
Hydraulic Oil Filter.....	HC-5801
345B (EXCAVATORS) CAT 3176 (S/N: AKJ1-UP)	
Air Filter Secondary.....	A-5594
Air Filter Set.....	A-5595-S
Air Filter Primary.....	A-5593
Cabin Air Filter.....	CA-55850
Fuel Filter.....	FC-5517
Fuel/Water Separator Secondary..	SFC-5504-10
Fuel/Water Separator Secondary..	SFC-5504-10B
Hydraulic Oil Filter.....	H-5522
Hydraulic Oil Filter.....	HC-5505

MODEL/APPLICATION	SAKURA NO
CATERPILLAR	
Hydraulic Oil Filter.....	HC-5801
Hydraulic Oil Filter.....	H-7942
345B (EXCAVATORS) CAT 3176 (S/N: AKX1-UP)	
Air Filter Secondary.....	A-5594
Air Filter Set.....	A-5595-S
Air Filter Primary.....	A-5593
Cabin Air Filter.....	CA-55850
Fuel Filter.....	FC-5517
Fuel/Water Separator Secondary..	SFC-5504-10B
Fuel/Water Separator Secondary..	SFC-5504-10
Hydraulic Oil Filter.....	HC-5801
Hydraulic Oil Filter.....	HC-5505
Hydraulic Oil Filter.....	H-5522
Hydraulic Oil Filter.....	H-7942
345B (EXCAVATORS) CAT 3176 (S/N: AKX244-UP)	
Air Filter Set.....	A-5595-S
Air Filter Secondary.....	A-5594
Air Filter Primary.....	A-5593
Cabin Air Filter.....	CA-55850
Fuel Filter.....	FC-5517
Fuel/Water Separator Secondary..	SFC-5504-10
Fuel/Water Separator Secondary..	SFC-5504-10B
Hydraulic Oil Filter.....	H-5522
Hydraulic Oil Filter.....	HC-5801
Hydraulic Oil Filter.....	H-7942
Hydraulic Oil Filter.....	HC-5505
345B (EXCAVATORS) CAT 3176 (S/N: ALB1-UP)	
Air Filter Secondary.....	A-5594
Air Filter Set.....	A-5595-S
Air Filter Primary.....	A-5593
Cabin Air Filter.....	CA-55850
Fuel Filter.....	FC-5517
Fuel/Water Separator Secondary..	SFC-5504-10B
Fuel/Water Separator Secondary..	SFC-5504-10
Hydraulic Oil Filter.....	H-7942
Hydraulic Oil Filter.....	HC-5505
Hydraulic Oil Filter.....	HC-5801
345B (EXCAVATORS) CAT 3176 (S/N: ALD1-UP)	
Air Filter Secondary.....	A-5594
Air Filter Set.....	A-5595-S
Air Filter Primary.....	A-5593
Cabin Air Filter.....	CA-55850
Fuel Filter.....	FC-5517
Fuel/Water Separator Secondary..	SFC-5504-10B
Fuel/Water Separator Secondary..	SFC-5504-10
Hydraulic Oil Filter.....	H-7942
Hydraulic Oil Filter.....	HC-5801
Hydraulic Oil Filter.....	HC-5505
Hydraulic Oil Filter.....	H-5522
345B (EXCAVATORS) CAT 3176 (S/N: BFG1-UP)	
Air Filter Secondary.....	A-8580
Air Filter Primary.....	A-8665M
Cabin Air Filter.....	CA-55850
Fuel Filter.....	FC-5517

MODEL/APPLICATION	SAKURA NO
CATERPILLAR	
Fuel/Water Separator Secondary..	SFC-5504-10
Fuel/Water Separator Secondary..	SFC-5504-10B
Hydraulic Oil Filter.....	HC-5801
Hydraulic Oil Filter.....	H-7942
Hydraulic Oil Filter.....	HC-5505
Oil Filter Full Flow.....	C-5516
345B (EXCAVATORS) CAT 3176 (S/N: CCC1-UP)	
Air Filter Primary.....	A-8665M
Air Filter Secondary.....	A-5594
Air Filter Set.....	A-5595-S
Air Filter Secondary.....	A-8580
Air Filter Primary.....	A-5593
Cabin Air Filter.....	CA-55850
Fuel Filter.....	FC-5517
Fuel/Water Separator Secondary..	SFC-5504-10B
Fuel/Water Separator Secondary..	SFC-5504-10
Hydraulic Oil Filter.....	HC-5505
Hydraulic Oil Filter.....	HC-5801
Hydraulic Oil Filter.....	H-7942
Oil Filter Full Flow.....	C-5516
345B (EXCAVATORS) CAT 3176 (S/N: CFM1-UP)	
Fuel Filter.....	FC-5517
345B (EXCAVATORS) CAT 3176 (S/N: DCW1-UP)	
Air Filter Secondary.....	A-5594
Air Filter Set.....	A-5595-S
Air Filter Primary.....	A-5593
Cabin Air Filter.....	CA-55850
Fuel Filter.....	FC-5517
Fuel/Water Separator Secondary..	SFC-5504-10B
Fuel/Water Separator Secondary..	SFC-5504-10
Hydraulic Oil Filter.....	H-7942
Hydraulic Oil Filter.....	HC-5801
Hydraulic Oil Filter.....	HC-5505
345B (EXCAVATORS) S/N: 7KS00365-UP	
Air Filter Secondary.....	A-8580
Air Filter Primary.....	A-8665M
Cabin Air Filter.....	CA-55850
Fuel Filter.....	FC-5517
Fuel/Water Separator Secondary..	SFC-5504-10
Fuel/Water Separator Secondary..	SFC-5504-10B
Hydraulic Oil Filter.....	HC-5505
Hydraulic Oil Filter.....	H-7942
Oil Filter Full Flow.....	C-5516
345B L (EXCAVATORS) CAT 3176C (S/N: 2SW1-UP)	
Air Filter Primary.....	A-8665M
Air Filter Secondary.....	A-8580
Fuel Filter.....	FC-5517
Fuel/Water Separator Secondary..	SFC-5504-10B
Fuel/Water Separator Secondary..	SFC-5504-10
Hydraulic Oil Filter.....	HC-5801
Hydraulic Oil Filter.....	HC-5505
Hydraulic Oil Filter.....	H-7942

MODEL/APPLICATION	SAKURA NO
CATERPILLAR	
345B L (EXCAVATORS) CAT 3176C (S/N: 2WS1-UP)	
Air Filter Primary.....	A-8665M
Air Filter Secondary.....	A-8580
Cabin Air Filter.....	CA-55850
Fuel Filter.....	FC-5517
Hydraulic Oil Filter.....	HC-5505
Hydraulic Oil Filter.....	H-7942
Hydraulic Oil Filter.....	HC-5801
345B L (EXCAVATORS) CAT 3176C (S/N: 2ZW1-UP)	
Air Filter Primary.....	A-8665M
Air Filter Secondary.....	A-8580
Fuel Filter.....	FC-5517
Fuel/Water Separator Secondary..	SFC-5504-10B
Fuel/Water Separator Secondary...	SFC-5504-10
Hydraulic Oil Filter.....	HC-5801
Hydraulic Oil Filter.....	H-7942
Hydraulic Oil Filter.....	HC-5505
345B L (EXCAVATORS) CAT 3176C (S/N: 3MW1-UP)	
Air Filter Secondary.....	A-8580
Air Filter Primary.....	A-8665M
Fuel Filter.....	FC-5517
Fuel/Water Separator Secondary..	SFC-5504-10B
Fuel/Water Separator Secondary...	SFC-5504-10
Hydraulic Oil Filter.....	HC-5505
Hydraulic Oil Filter.....	H-7942
Hydraulic Oil Filter.....	HC-5801
345B L (EXCAVATORS) CAT 3176C (S/N: 4SS1-UP)	
Air Filter Primary.....	A-5593
Air Filter Set.....	A-5595-S
Air Filter Secondary.....	A-5594
Fuel Filter.....	FC-5517
Fuel/Water Separator Secondary..	SFC-5504-10
Fuel/Water Separator Secondary...	SFC-5504-10B
Hydraulic Oil Filter.....	HC-5505
Hydraulic Oil Filter.....	HC-5801
Hydraulic Oil Filter.....	H-7942
345B L (EXCAVATORS) CAT 3176C (S/N: 5WS1-UP)	
Air Filter Primary.....	A-8665M
Air Filter Secondary.....	A-5594
Air Filter Primary.....	A-5593
Air Filter Set.....	A-5595-S
Air Filter Secondary.....	A-8580
Fuel Filter.....	FC-5517
Fuel/Water Separator Secondary..	SFC-5504-10B
Fuel/Water Separator Secondary...	SFC-5504-10
Hydraulic Oil Filter.....	H-7942
Hydraulic Oil Filter.....	HC-5801
Hydraulic Oil Filter.....	HC-5505
Oil Filter Full Flow.....	C-5516
345B L (EXCAVATORS) CAT 3176C (S/N: 6XS1-UP)	
Air Filter Secondary.....	A-8580
Air Filter Primary.....	A-8665M

MODEL/APPLICATION	SAKURA NO
CATERPILLAR	
Fuel Filter.....	FC-5517
Fuel/Water Separator Secondary..	SFC-5504-10B
Fuel/Water Separator Secondary...	SFC-5504-10
Hydraulic Oil Filter.....	HC-5801
Hydraulic Oil Filter.....	HC-5505
Hydraulic Oil Filter.....	H-7942
345B L (EXCAVATORS) CAT 3176C (S/N: 7KS1-UP)	
Air Filter Primary.....	A-8665M
Air Filter Secondary.....	A-8580
Cabin Air Filter.....	CA-55850
Fuel Filter.....	FC-5517
Fuel/Water Separator Secondary..	SFC-5504-10B
Fuel/Water Separator Secondary...	SFC-5504-10
Hydraulic Oil Filter.....	HC-5505
Hydraulic Oil Filter.....	H-7942
Hydraulic Oil Filter.....	HC-5801
345B L (EXCAVATORS) CAT 3176C (S/N: 9GS1-UP)	
Air Filter Secondary.....	A-5594
Air Filter Primary.....	A-5593
Air Filter Set.....	A-5595-S
Fuel Filter.....	FC-5517
Fuel/Water Separator Secondary..	SFC-5504-10
Fuel/Water Separator Secondary...	SFC-5504-10B
Hydraulic Oil Filter.....	HC-5801
Hydraulic Oil Filter.....	H-7942
Hydraulic Oil Filter.....	HC-5505
345B L (EXCAVATORS) CAT 3176C (S/N: BF61-UP)	
Air Filter Primary.....	A-8665M
Air Filter Secondary.....	A-8580
Fuel Filter.....	FC-5517
Fuel/Water Separator Secondary..	SFC-5504-10
Fuel/Water Separator Secondary...	SFC-5504-10B
Hydraulic Oil Filter.....	HC-5801
Hydraulic Oil Filter.....	HC-5505
Hydraulic Oil Filter.....	H-7942
345 (EXCAVATORS) S/N: 7SK00365-UP	
Air Filter Primary.....	A-8665M
Air Filter Secondary.....	A-8580
Cabin Air Filter.....	CA-55850
Fuel Filter.....	FC-5517
Fuel/Water Separator Secondary..	SFC-5504-10B
Fuel/Water Separator Secondary...	SFC-5504-10
Hydraulic Oil Filter.....	H-7942
Hydraulic Oil Filter.....	HC-5505
Oil Filter Full Flow.....	C-5516
345D (EXCAVATORS) CAT C13 ACERT	
Hydraulic Oil Filter.....	HC-9901
345 BLME (EXCAVATORS)	
Air Filter Primary.....	A-8665M
Air Filter Secondary.....	A-8580
Fuel/Water Separator Secondary..	SFC-5504-10B
Fuel/Water Separator Secondary...	SFC-5504-10
Hydraulic Oil Filter.....	H-7942

MODEL/APPLICATION	SAKURA NO
CATERPILLAR	
Hydraulic Oil Filter.....	HC-5505
Oil Filter Full Flow.....	C-5516
Oil Filter Full Flow.....	C-5510
345B II (EXCAVATORS) CAT 3176C (S/N: AGS1-UP)	
Air Filter Primary.....	A-5593
Air Filter Set.....	A-5595-S
Air Filter Secondary.....	A-5594
Cabin Air Filter.....	CA-55850
Fuel Filter.....	FC-5517
Fuel/Water Separator Secondary..	SFC-5504-10B
Fuel/Water Separator Secondary...	SFC-5504-10
Hydraulic Oil Filter.....	H-7942
Hydraulic Oil Filter.....	HC-5801
Hydraulic Oil Filter.....	HC-5505
Oil Filter Full Flow.....	C-5516
345B II (EXCAVATORS) CAT 3176C (S/N: AKJ1-UP)	
Air Filter Primary.....	A-5593
Air Filter Set.....	A-5595-S
Cabin Air Filter.....	CA-55850
Fuel Filter.....	FC-5517
Hydraulic Oil Filter.....	HC-5801
Oil Filter Full Flow.....	C-5516
345B II (EXCAVATORS) CAT 3176C (S/N: AKX1-UP)	
Air Filter Secondary.....	A-5594
Air Filter Set.....	A-5595-S
Air Filter Primary.....	A-5593
Cabin Air Filter.....	CA-55850
Fuel Filter.....	FC-5517
Fuel/Water Separator Secondary..	SFC-5504-10B
Fuel/Water Separator Secondary...	SFC-5504-10
Hydraulic Oil Filter.....	HC-5801
Hydraulic Oil Filter.....	H-7942
Oil Filter Full Flow.....	C-5516
345B II (EXCAVATORS) CAT 3176C (S/N: ALB1-UP)	
Air Filter Primary.....	A-5593
Air Filter Set.....	A-5595-S
Air Filter Secondary.....	A-5594
Cabin Air Filter.....	CA-55850
Fuel Filter.....	FC-5517
Fuel/Water Separator Secondary..	SFC-5504-10B
Fuel/Water Separator Secondary...	SFC-5504-10
Hydraulic Oil Filter.....	H-7942
Hydraulic Oil Filter.....	HC-5801
345B II (EXCAVATORS) CAT 3176C (S/N: ALD1-UP)	
Air Filter Primary.....	A-5593
Air Filter Set.....	A-5595-S
Air Filter Secondary.....	A-5594
Cabin Air Filter.....	CA-55850
Fuel Filter.....	FC-5517
Fuel/Water Separator Secondary..	SFC-5504-10B
Fuel/Water Separator Secondary...	SFC-5504-10
Hydraulic Oil Filter.....	H-7942
Hydraulic Oil Filter.....	HC-5801

MODEL/APPLICATION	SAKURA NO
CATERPILLAR	
345B II (EXCAVATORS) CAT 3176C (S/N: CCC1-UP)	
Air Filter Primary.....	A-8665M
Air Filter Secondary.....	A-8580
Fuel Filter.....	FC-5517
Fuel/Water Separator Secondary..	SFC-5504-10B
Fuel/Water Separator Secondary..	SFC-5504-10
345B L II (EXCAVATORS) CAT 3176C (S/N: AGS1-UP)	
Air Filter Secondary.....	A-5594
Air Filter Set.....	A-5595-S
Air Filter Primary.....	A-5593
Fuel Filter.....	FC-5517
Fuel/Water Separator Secondary..	SFC-5504-10B
Fuel/Water Separator Secondary..	SFC-5504-10
Hydraulic Oil Filter.....	HC-5801
Hydraulic Oil Filter.....	H-7942
Hydraulic Oil Filter.....	HC-5505
345B L II (EXCAVATORS) CAT 3176C (S/N: AKJ1-UP)	
Air Filter Secondary.....	A-5594
Air Filter Set.....	A-5595-S
Air Filter Primary.....	A-5593
Fuel Filter.....	FC-5517
Fuel/Water Separator Secondary..	SFC-5504-10B
Fuel/Water Separator Secondary..	SFC-5504-10
Hydraulic Oil Filter.....	HC-5505
Hydraulic Oil Filter.....	HC-5801
Hydraulic Oil Filter.....	H-7942
Hydraulic Oil Filter.....	H-5522
345B L II (EXCAVATORS) CAT 3176C (S/N: AKX1-UP)	
Air Filter Secondary.....	A-5594
Air Filter Primary.....	A-5593
Air Filter Set.....	A-5595-S
Fuel Filter.....	FC-5517
Fuel/Water Separator Secondary..	SFC-5504-10
Fuel/Water Separator Secondary..	SFC-5504-10B
Hydraulic Oil Filter.....	H-5522
Hydraulic Oil Filter.....	HC-5801
Hydraulic Oil Filter.....	HC-5505
Hydraulic Oil Filter.....	H-7942
345B L II (EXCAVATORS) CAT 3176C (S/N: ALB1-UP)	
Air Filter Set.....	A-5595-S
Air Filter Primary.....	A-5593
Air Filter Secondary.....	A-5594
Fuel Filter.....	FC-5517
Fuel/Water Separator Secondary..	SFC-5504-10
Fuel/Water Separator Secondary..	SFC-5504-10B
Hydraulic Oil Filter.....	HC-5505
Hydraulic Oil Filter.....	HC-5801
Hydraulic Oil Filter.....	H-7942
345B L II (EXCAVATORS) CAT 3176C (S/N: ALD1-UP)	
Air Filter Secondary.....	A-5594
Air Filter Primary.....	A-5593
Air Filter Set.....	A-5595-S

MODEL/APPLICATION	SAKURA NO
CATERPILLAR	
Fuel Filter.....	FC-5517
Fuel/Water Separator Secondary..	SFC-5504-10B
Fuel/Water Separator Secondary..	SFC-5504-10
Hydraulic Oil Filter.....	HC-5505
Hydraulic Oil Filter.....	H-5522
Hydraulic Oil Filter.....	H-7942
Hydraulic Oil Filter.....	HC-5801
345B L US (EXCAVATORS) CAT 3176C (S/N: 4SS1-UP)	
Air Filter Primary.....	A-5593
Air Filter Set.....	A-5595-S
Air Filter Secondary.....	A-5594
Cabin Air Filter.....	CA-55850
Fuel Filter.....	FC-5517
Hydraulic Oil Filter.....	HC-5801
Hydraulic Oil Filter.....	HC-5505
345B LC (EXCAVATORS) CAT 3176C (S/N: 2SW1-UP)	
Air Filter Secondary.....	A-8580
Air Filter Primary.....	A-8665M
Fuel Filter.....	FC-5517
Fuel/Water Separator Secondary..	SFC-5504-10
Fuel/Water Separator Secondary..	SFC-5504-10B
Hydraulic Oil Filter.....	HC-5801
Hydraulic Oil Filter.....	H-7942
Hydraulic Oil Filter.....	HC-5505
345B LC (EXCAVATORS) CAT 3176C (S/N: 7KS1-UP)	
Air Filter Primary.....	A-8665M
Air Filter Secondary.....	A-8580
Fuel Filter.....	FC-5517
Fuel/Water Separator Secondary..	SFC-5504-10B
Fuel/Water Separator Secondary..	SFC-5504-10
Hydraulic Oil Filter.....	H-7942
Hydraulic Oil Filter.....	HC-5801
Hydraulic Oil Filter.....	HC-5505
345B LC (EXCAVATORS) CAT 3176C (S/N: BFG1-UP)	
Air Filter Primary.....	A-8665M
Air Filter Secondary.....	A-8580
Fuel Filter.....	FC-5517
Fuel/Water Separator Secondary..	SFC-5504-10B
Fuel/Water Separator Secondary..	SFC-5504-10
Hydraulic Oil Filter.....	H-7942
Hydraulic Oil Filter.....	HC-5801
Hydraulic Oil Filter.....	HC-5505
345C (EXCAVATORS) CAT C13 ACERT	
Hydraulic Oil Filter.....	HC-9901
345C (EXCAVATORS) S/N: DHP1-382-UP	
Air Filter Set.....	A-5595-S
Air Filter Primary.....	A-5593
Air Filter Secondary.....	A-5594
Cabin Air Filter.....	CA-55850
Hydraulic Oil Filter.....	H-5522
Hydraulic Oil Filter.....	H-7942
Hydraulic Oil Filter.....	HC-5801
Hydraulic Oil Filter.....	HC-55170

MODEL/APPLICATION	SAKURA NO
CATERPILLAR	
345C (EXCAVATORS) S/N: DHP383-UP	
Air Filter Primary.....	A-5593
Air Filter Secondary.....	A-5594
Air Filter Set.....	A-5595-S
Cabin Air Filter.....	CA-55850
Hydraulic Oil Filter.....	HC-55170
Hydraulic Oil Filter.....	HC-5801
Hydraulic Oil Filter.....	H-5522
345C (EXCAVATORS) S/N: ELS1-UP	
Air Filter Primary.....	A-8665M
Air Filter Secondary.....	A-5594
Air Filter Primary.....	A-5593
Air Filter Secondary.....	A-8580
Air Filter Set.....	A-5595-S
Cabin Air Filter.....	CA-55850
Hydraulic Oil Filter.....	HC-5801
345C (EXCAVATORS) S/N: GCL1-UP	
Air Filter Set.....	A-5595-S
Air Filter Primary.....	A-5593
Air Filter Secondary.....	A-5594
Air Filter Secondary.....	A-8580
Air Filter Primary.....	A-8665M
Cabin Air Filter.....	CA-55850
Hydraulic Oil Filter.....	HC-5801
345C (EXCAVATORS) S/N: GJR1-UP	
Air Filter Set.....	A-5595-S
Air Filter Primary.....	A-5593
Air Filter Secondary.....	A-5594
Cabin Air Filter.....	CA-55850
Hydraulic Oil Filter.....	HC-55170
Hydraulic Oil Filter.....	H-5522
Hydraulic Oil Filter.....	H-7942
Hydraulic Oil Filter.....	HC-5801
345C (EXCAVATORS) S/N: GPH1-UP	
Air Filter Primary.....	A-8665M
Air Filter Set.....	A-5595-S
Air Filter Primary.....	A-5593
Air Filter Secondary.....	A-5594
Air Filter Secondary.....	A-8580
Cabin Air Filter.....	CA-55850
Hydraulic Oil Filter.....	HC-5801
345C (EXCAVATORS) S/N: LYS1-YP-UP	
Air Filter Secondary.....	A-8580
Air Filter Set.....	A-5595-S
Air Filter Primary.....	A-8665M
Air Filter Secondary.....	A-5594
Air Filter Primary.....	A-5593
Cabin Air Filter.....	CA-55850
Hydraulic Oil Filter.....	HC-5801
345C (EXCAVATORS) S/N: SPC1-UP	
Air Filter Secondary.....	A-5594

MODEL/APPLICATION	SAKURA NO
CATERPILLAR	
345C (EXCAVATORS) S/N: SPC1-UP	
Air Filter Primary.....	A-8665M
Air Filter Set.....	A-5595-S
Air Filter Secondary.....	A-8580
Air Filter Primary.....	A-5593
Cabin Air Filter.....	CA-55850
Hydraulic Oil Filter.....	HC-5801
345C (EXCAVATORS) S/N: TBA1-UP	
Air Filter Primary.....	A-5593
Air Filter Set.....	A-5595-S
Air Filter Secondary.....	A-5594
Air Filter Primary.....	A-8665M
Air Filter Secondary.....	A-8580
Cabin Air Filter.....	CA-55850
Hydraulic Oil Filter.....	HC-5801
345C (EXCAVATORS) S/N: WDE1-UP	
Air Filter Primary.....	A-8665M
Air Filter Secondary.....	A-5594
Air Filter Primary.....	A-5593
Air Filter Set.....	A-5595-S
Air Filter Secondary.....	A-8580
Cabin Air Filter.....	CA-55850
Hydraulic Oil Filter.....	HC-5801
345D VG (EXCAVATORS) w/C13 Eng.	
Fuel/Water Separator.....	SFC-55250
345D L VG (EXCAVATORS)	
Cabin Air Filter.....	CA-55170
Cabin Air Filter.....	CAC-55170
Cabin Air Filter.....	CAV-55170
348 (EXCAVATORS) S/N: 3GJ01501-UP	
Fuel Filter.....	F-5501
Oil Filter Full Flow.....	O-5502
349E L (EXCAVATORS)	
Cabin Air Filter.....	CAC-55170
Cabin Air Filter.....	CA-55170
Cabin Air Filter.....	CAV-55170
349E L VG (EXCAVATORS)	
Cabin Air Filter.....	CAC-55170
Cabin Air Filter.....	CAV-55170
Cabin Air Filter.....	CA-55170
349F (EXCAVATORS)	
Cabin Air Filter.....	CA-55170
Cabin Air Filter.....	CAC-55170
Cabin Air Filter.....	CAV-55170
349F L (EXCAVATORS)	
Cabin Air Filter.....	CA-55170
Cabin Air Filter.....	CAC-55170

MODEL/APPLICATION	SAKURA NO
CATERPILLAR	
Cabin Air Filter.....	CAV-55170
350 (EXCAVATORS) CAT 3116 (S/N: 2ZL1-UP)	
Coolant Filter.....	WC-5707
Coolant Filter.....	WC-5705
Fuel Filter Secondary.....	FC-5507
Fuel Filter.....	F-5505
Hydraulic Oil Filter.....	H-5505
350 (EXCAVATORS) CAT 3116 (S/N: 3ML1-UP)	
Air Filter Primary.....	A-5593
Air Filter Secondary.....	A-5594
Air Filter Set.....	A-5595-S
Fuel Filter Secondary.....	FC-5507
Fuel Filter.....	F-5505
Hydraulic Oil Filter.....	HC-5516
Hydraulic Oil Filter.....	H-5505
Hydraulic Oil Filter.....	HC-5511
Oil Filter Full Flow.....	C-5516
350 (EXCAVATORS) CAT 3116 (S/N: 7RK1-UP)	
Air Filter Secondary.....	A-5594
Air Filter Set.....	A-5595-S
Air Filter Primary.....	A-5593
Fuel Filter.....	F-5505
Fuel Filter Secondary.....	FC-5507
Hydraulic Oil Filter.....	HC-5516
Hydraulic Oil Filter.....	HC-5511
Hydraulic Oil Filter.....	H-5505
Oil Filter Full Flow.....	C-5516
350 (EXCAVATORS) CAT 3116 (S/N: 8HK1-UP)	
Air Filter Primary.....	A-5593
Air Filter Set.....	A-5595-S
Air Filter Secondary.....	A-5594
Fuel Filter.....	F-5505
Fuel Filter Secondary.....	FC-5507
Hydraulic Oil Filter.....	H-5505
Hydraulic Oil Filter.....	HC-5516
Hydraulic Oil Filter.....	HC-5511
Oil Filter Full Flow.....	C-5516
350 (EXCAVATORS) CAT 3116 (S/N: 9DK1-UP)	
Air Filter Primary.....	A-5593
Air Filter Secondary.....	A-5594
Air Filter Set.....	A-5595-S
Fuel Filter Secondary.....	FC-5507
Fuel Filter.....	F-5505
Hydraulic Oil Filter.....	HC-5516
Hydraulic Oil Filter.....	H-5505
Hydraulic Oil Filter.....	HC-5511
Oil Filter Full Flow.....	C-5516
350 (EXCAVATORS) CAT 3116 (S/N: 9FL1-UP)	
Air Filter Secondary.....	A-5594
Air Filter Set.....	A-5595-S
Air Filter Primary.....	A-5593
Fuel Filter Secondary.....	FC-5507

MODEL/APPLICATION	SAKURA NO
CATERPILLAR	
Fuel Filter.....	F-5505
Hydraulic Oil Filter.....	H-5505
Hydraulic Oil Filter.....	HC-5511
Hydraulic Oil Filter.....	HC-5516
Oil Filter Full Flow.....	C-5516
350 (EXCAVATORS) CAT 3306 (S/N: 3ML1-UP)	
Air Filter Secondary.....	A-5594
Air Filter Primary.....	A-5593
Air Filter Set.....	A-5595-S
Fuel Filter.....	F-5505
Fuel Filter Secondary.....	FC-5507
Hydraulic Oil Filter.....	HC-5511
Hydraulic Oil Filter.....	HC-5516
Hydraulic Oil Filter.....	H-5505
Oil Filter Full Flow.....	C-5516
350 (EXCAVATORS) CAT 3306 (S/N: 7RK1-UP)	
Air Filter Secondary.....	A-5594
Air Filter Primary.....	A-5593
Air Filter Set.....	A-5595-S
Fuel Filter Secondary.....	FC-5507
Fuel Filter.....	F-5505
Hydraulic Oil Filter.....	HC-5511
Hydraulic Oil Filter.....	HC-5516
Hydraulic Oil Filter.....	H-5505
Oil Filter Full Flow.....	C-5516
350 (EXCAVATORS) CAT 3306 (S/N: 8HK1-UP)	
Air Filter Secondary.....	A-5594
Air Filter Primary.....	A-5593
Air Filter Set.....	A-5595-S
Fuel Filter.....	F-5505
Fuel Filter Secondary.....	FC-5507
Hydraulic Oil Filter.....	HC-5511
Hydraulic Oil Filter.....	HC-5516
Hydraulic Oil Filter.....	H-5505
Oil Filter Full Flow.....	C-5516
350 (EXCAVATORS) CAT 3306 (S/N: 9DK1-UP)	
Air Filter Primary.....	A-5593
Air Filter Set.....	A-5595-S
Air Filter Secondary.....	A-5594
Fuel Filter Secondary.....	FC-5507
Fuel Filter.....	F-5505
Hydraulic Oil Filter.....	HC-5516
Hydraulic Oil Filter.....	H-5505
Hydraulic Oil Filter.....	HC-5511
Oil Filter Full Flow.....	C-5516
350 (EXCAVATORS) CAT 3306 (S/N: 9FL1-UP)	
Air Filter Primary.....	A-5593
Air Filter Secondary.....	A-5594
Air Filter Set.....	A-5595-S
Fuel Filter.....	F-5505
Fuel Filter Secondary.....	FC-5507
Hydraulic Oil Filter.....	HC-5511
Hydraulic Oil Filter.....	HC-5516
Hydraulic Oil Filter.....	H-5505

MODEL/APPLICATION	SAKURA NO
CATERPILLAR	
350 (EXCAVATORS) CAT 3306 (S/N: 9FL1-UP)	
Oil Filter Full Flow.....	C-5516
350B (EXCAVATORS)	
Fuel Filter Secondary.....	FC-5507
Oil Filter Full Flow.....	C-5510
35 (TRACTORS) S/N: 1TJ1-UP	
Air Filter Primary.....	A-5549M
Air Filter Secondary.....	A-5550
Air Filter Primary.....	A-5549
Air Filter Set.....	A-5549M-S
Hydraulic Oil Filter.....	HC-5504
35 (TRACTORS) S/N: 3HS1-UP	
Air Filter Primary.....	A-5549
Air Filter Primary.....	A-5549M
Air Filter Secondary.....	A-5550
Air Filter Set.....	A-5549M-S
Hydraulic Oil Filter.....	HC-5504
35 (TRACTORS) S/N: 8RD1-UP	
Air Filter Primary.....	A-5549M
Air Filter Set.....	A-5549M-S
Air Filter Primary.....	A-5549
Air Filter Secondary.....	A-5550
Hydraulic Oil Filter.....	HC-5504
35 (TRACTORS) S/N: ADK1-UP	
Air Filter Primary.....	A-5549
Air Filter Primary.....	A-5549M
Air Filter Secondary.....	A-5550
Air Filter Set.....	A-5549M-S
Hydraulic Oil Filter.....	HC-5504
350BL (EXCAVATORS)	
Air Filter Primary.....	A-5558
Air Filter Secondary.....	A-5559
Fuel Filter Secondary.....	FC-5507
Hydraulic Oil Filter.....	H-7942
Oil Filter Full Flow.....	C-5510
352F XE VG (EXCAVATORS)	
Cabin Air Filter.....	CA-55170
Cabin Air Filter.....	CAC-55170
Cabin Air Filter.....	CAV-55170
355 (EXCAVATORS)	
Air Filter Primary.....	AS-5523
Air Filter Secondary.....	A-7913
Fuel Filter Secondary.....	FC-5515
Fuel Filter.....	FC-5516
Fuel Filter Secondary.....	FC-55151
Oil Filter Full Flow.....	C-5510
365B (EXCAVATORS) CAT 3196 (S/N: 9PZ1-UP) , 2007-UP	

MODEL/APPLICATION	SAKURA NO
CATERPILLAR	
Air Filter Set.....	A-5595-S
Air Filter Primary.....	A-5593
Air Filter Secondary.....	A-5594
Fuel Filter.....	FC-5517
Fuel/Water Separator Secondary... SFC-5504-10	
Fuel/Water Separator Secondary.. SFC-5504-10B	
Hydraulic Oil Filter.....	HC-5516
Hydraulic Oil Filter.....	HC-5511
Hydraulic Oil Filter.....	H-5522
Hydraulic Oil Filter.....	H-7942
Hydraulic Oil Filter.....	HC-5511
365B (EXCAVATORS) CAT 3196 (S/N: 9TZ1-UP)	
Air Filter Secondary.....	A-5594
Air Filter Primary.....	A-5593
Air Filter Set.....	A-5595-S
Fuel Filter.....	FC-5517
Fuel/Water Separator Secondary... SFC-5504-10	
Fuel/Water Separator Secondary.. SFC-5504-10B	
Hydraulic Oil Filter.....	HC-5511
Hydraulic Oil Filter.....	H-7942
Hydraulic Oil Filter.....	HC-5516
365B (EXCAVATORS) CAT 3196 (S/N: CFJ1-UP)	
Air Filter Secondary.....	A-5594
Air Filter Set.....	A-5595-S
Air Filter Primary.....	A-5593
Cabin Air Filter.....	CA-55850
Fuel Filter.....	FC-5517
Fuel/Water Separator Secondary... SFC-5504-10	
Fuel/Water Separator Secondary.. SFC-5504-10B	
Hydraulic Oil Filter.....	H-7942
Hydraulic Oil Filter.....	HC-5516
Hydraulic Oil Filter.....	HC-5511
365B (EXCAVATORS) CAT 3196 (S/N: CTY1-UP)	
Air Filter Set.....	A-5595-S
Air Filter Primary.....	A-5593
Fuel Filter.....	FC-5517
Fuel/Water Separator Secondary... SFC-5504-10	
Fuel/Water Separator Secondary.. SFC-5504-10B	
Hydraulic Oil Filter.....	H-7942
Hydraulic Oil Filter.....	HC-5516
Hydraulic Oil Filter.....	HC-5511
365B (EXCAVATORS) CAT 3196 (S/N: DER1-UP)	
Air Filter Primary.....	A-5593
Air Filter Secondary.....	A-5594
Air Filter Set.....	A-5595-S
Fuel Filter.....	FC-5517
Fuel/Water Separator Secondary... SFC-5504-10	
Fuel/Water Separator Secondary.. SFC-5504-10B	
Hydraulic Oil Filter.....	H-7942
Hydraulic Oil Filter.....	HC-5516
Hydraulic Oil Filter.....	HC-5511
365B (EXCAVATORS) CAT 3196 (S/N: JMB1-UP)	
Air Filter Primary.....	A-5593
Air Filter Set.....	A-5595-S
Air Filter Secondary.....	A-5594

MODEL/APPLICATION	SAKURA NO
CATERPILLAR	
Fuel Filter.....	FC-5517
Fuel/Water Separator Secondary... SFC-5504-10	
Fuel/Water Separator Secondary.. SFC-5504-10B	
Hydraulic Oil Filter.....	HC-5516
Hydraulic Oil Filter.....	HC-5511
Hydraulic Oil Filter.....	H-5522
365B (EXCAVATORS) CAT 3196 (S/N: PEG1-UP)	
Air Filter Secondary.....	A-5594
Air Filter Set.....	A-5595-S
Air Filter Primary.....	A-5593
Fuel Filter.....	FC-5517
Fuel/Water Separator Secondary.. SFC-5504-10B	
Fuel/Water Separator Secondary... SFC-5504-10	
Hydraulic Oil Filter.....	H-5522
Hydraulic Oil Filter.....	HC-5511
Hydraulic Oil Filter.....	HC-5516
365B (EXCAVATORS) CAT 3196 (S/N: SDL1-UP)	
Air Filter Set.....	A-5595-S
Air Filter Primary.....	A-5593
Air Filter Secondary.....	A-5594
Fuel Filter.....	FC-5517
Fuel/Water Separator Secondary.. SFC-5504-10B	
Fuel/Water Separator Secondary... SFC-5504-10	
Hydraulic Oil Filter.....	H-5522
Hydraulic Oil Filter.....	HC-5511
Hydraulic Oil Filter.....	HC-5516
365B (EXCAVATORS) CAT 3196 ATAAC	
Cabin Air Filter.....	CA-55130
365B II (EXCAVATORS) CAT S/N: 6AR1-UP , 2004-UP	
Air Filter Secondary.....	A-5594
Air Filter Set.....	A-5595-S
Air Filter Primary.....	A-5593
Fuel Filter.....	FC-5517
Fuel Filter.....	FC-5509
Fuel/Water Separator Secondary.. SFC-5504-10B	
Fuel/Water Separator Secondary... SFC-5504-10	
Hydraulic Oil Filter.....	HC-5511
Hydraulic Oil Filter.....	H-5522
Hydraulic Oil Filter.....	HC-55300
Hydraulic Oil Filter.....	HC-5516
Hydraulic Oil Filter.....	HC-55290
365B II (EXCAVATORS) CAT S/N: DER1-UP , 2004-UP	
Air Filter Set.....	A-5595-S
Air Filter Primary.....	A-5593
Air Filter Secondary.....	A-5594
Fuel Filter.....	FC-5517
Fuel Filter.....	FC-5509
Fuel/Water Separator Secondary.. SFC-5504-10B	
Fuel/Water Separator Secondary... SFC-5504-10	
Hydraulic Oil Filter.....	H-5522
Hydraulic Oil Filter.....	HC-55290
Hydraulic Oil Filter.....	H-7942
Hydraulic Oil Filter.....	HC-5516
Hydraulic Oil Filter.....	HC-5511

MODEL/APPLICATION	SAKURA NO
CATERPILLAR	
365B II (EXCAVATORS) CAT S/N: DER1-UP , 2004-UP	
Hydraulic Oil Filter.....	HC-55300
365B II (EXCAVATORS) CAT S/N: GAR1-UP , 2004-UP	
Air Filter Primary.....	A-5593
Air Filter Secondary.....	A-5594
Air Filter Set.....	A-5595-S
Fuel Filter.....	FC-5517
Fuel Filter.....	FC-5509
Fuel/Water Separator Secondary..	SFC-5504-10B
Fuel/Water Separator Secondary..	SFC-5504-10
Hydraulic Oil Filter.....	HC-55300
Hydraulic Oil Filter.....	HC-5516
Hydraulic Oil Filter.....	HC-55290
Hydraulic Oil Filter.....	HC-5511
Hydraulic Oil Filter.....	H-5522
Hydraulic Oil Filter.....	H-7942
365B II (EXCAVATORS) CAT S/N: JMB1-UP , 2004-UP	
Air Filter Primary.....	A-5593
Air Filter Secondary.....	A-5594
Air Filter Set.....	A-5595-S
Fuel Filter.....	FC-5517
Fuel Filter.....	FC-5509
Fuel/Water Separator Secondary..	SFC-5504-10B
Fuel/Water Separator Secondary..	SFC-5504-10
Hydraulic Oil Filter.....	HC-55290
Hydraulic Oil Filter.....	H-7942
Hydraulic Oil Filter.....	H-5522
Hydraulic Oil Filter.....	HC-55300
Hydraulic Oil Filter.....	HC-5511
Hydraulic Oil Filter.....	HC-5516
365B II (EXCAVATORS) CAT S/N: PEG1-UP , 2004-UP	
Air Filter Secondary.....	A-5594
Air Filter Set.....	A-5595-S
Air Filter Primary.....	A-5593
Fuel Filter.....	FC-5517
Fuel Filter.....	FC-5509
Fuel/Water Separator Secondary..	SFC-5504-10
Fuel/Water Separator Secondary..	SFC-5504-10B
Hydraulic Oil Filter.....	HC-5511
Hydraulic Oil Filter.....	H-5522
Hydraulic Oil Filter.....	H-7942
Hydraulic Oil Filter.....	HC-5516
Hydraulic Oil Filter.....	HC-55300
Hydraulic Oil Filter.....	HC-55290
365B II (EXCAVATORS) CAT S/N: SDL1-UP , 2004-UP	
Air Filter Primary.....	A-5593
Air Filter Secondary.....	A-5594
Air Filter Set.....	A-5595-S
Fuel Filter.....	FC-5517
Fuel Filter.....	FC-5509
Fuel/Water Separator Secondary..	SFC-5504-10B
Fuel/Water Separator Secondary..	SFC-5504-10
Hydraulic Oil Filter.....	HC-55300
Hydraulic Oil Filter.....	HC-5511

MODEL/APPLICATION	SAKURA NO
CATERPILLAR	
Hydraulic Oil Filter.....	HC-55290
Hydraulic Oil Filter.....	H-5522
Hydraulic Oil Filter.....	HC-5516
365BL (EXCAVATORS) CAT 3196 (S/N: 9PZ1-UP)	
Air Filter Primary.....	A-5593
Air Filter Set.....	A-5595-S
Air Filter Secondary.....	A-5594
Fuel Filter.....	FC-5517
Fuel/Water Separator Secondary..	SFC-5504-10B
Fuel/Water Separator Secondary..	SFC-5504-10
Hydraulic Oil Filter.....	HC-5516
Hydraulic Oil Filter.....	H-7942
Hydraulic Oil Filter.....	HC-5511
Oil Filter Full Flow.....	C-5516
365BL (EXCAVATORS) CAT 3196 (S/N: AGD1-UP)	
Air Filter Secondary.....	A-5594
Air Filter Set.....	A-5595-S
Air Filter Primary.....	A-5593
Fuel Filter.....	FC-5517
Fuel/Water Separator Secondary..	SFC-5504-10B
Fuel/Water Separator Secondary..	SFC-5504-10
Hydraulic Oil Filter.....	HC-5516
Hydraulic Oil Filter.....	H-7942
Hydraulic Oil Filter.....	HC-5511
Oil Filter Full Flow.....	C-5516
365C (EXCAVATORS) CAT (S/N: LHX1-UP)	
Fuel Filter.....	FC-5517
365C (EXCAVATORS) CAT C15 (S/N: ELC1-UP)	
Air Filter Secondary.....	A-5594
Air Filter Set.....	A-5595-S
Air Filter Primary.....	A-5593
Cabin Air Filter.....	CA-55850
Fuel Filter.....	FC-5510
Hydraulic Oil Filter.....	HC-5511
Hydraulic Oil Filter.....	H-5522
Hydraulic Oil Filter.....	HC-5516
Hydraulic Oil Filter.....	HC-55290
Hydraulic Oil Filter.....	HC-55300
365C (EXCAVATORS) CAT C15 (S/N: FEN1-UP)	
Air Filter Secondary.....	A-5594
Air Filter Primary.....	A-5593
Air Filter Set.....	A-5595-S
Cabin Air Filter.....	CA-55850
Fuel Filter.....	FC-5510
Hydraulic Oil Filter.....	H-5522
Hydraulic Oil Filter.....	HC-5516
Hydraulic Oil Filter.....	HC-55300
Hydraulic Oil Filter.....	HC-5511
Hydraulic Oil Filter.....	HC-55290
365C (EXCAVATORS) CAT C15 (S/N: GWC11-UP)	
Air Filter Set.....	A-5595-S
Air Filter Secondary.....	A-5594
Air Filter Primary.....	A-5593

MODEL/APPLICATION	SAKURA NO
CATERPILLAR	
Cabin Air Filter.....	CA-55850
Fuel Filter.....	FC-5510
Hydraulic Oil Filter.....	HC-5511
Hydraulic Oil Filter.....	H-5522
Hydraulic Oil Filter.....	HC-5516
Hydraulic Oil Filter.....	HC-55290
Hydraulic Oil Filter.....	HC-55300
365C (EXCAVATORS) CAT C15 (S/N: MCS1-UP)	
Air Filter Primary.....	A-5593
Air Filter Secondary.....	A-5594
Air Filter Set.....	A-5595-S
Cabin Air Filter.....	CA-55850
Fuel Filter.....	FC-5510
Hydraulic Oil Filter.....	HC-5511
Hydraulic Oil Filter.....	H-5522
Hydraulic Oil Filter.....	HC-55290
Hydraulic Oil Filter.....	HC-5516
Hydraulic Oil Filter.....	HC-55300
365C (EXCAVATORS) CAT C15 (S/N: MCY1-UP)	
Air Filter Set.....	A-5595-S
Air Filter Primary.....	A-5593
Air Filter Secondary.....	A-5594
Cabin Air Filter.....	CA-55850
Fuel Filter.....	FC-5510
Hydraulic Oil Filter.....	HC-55290
Hydraulic Oil Filter.....	HC-55300
Hydraulic Oil Filter.....	HC-5511
Hydraulic Oil Filter.....	H-5522
Hydraulic Oil Filter.....	HC-5516
365C (EXCAVATORS) CAT C15 (S/N: MEM1-UP)	
Air Filter Primary.....	A-5593
Air Filter Secondary.....	A-5594
Air Filter Set.....	A-5595-S
Cabin Air Filter.....	CA-55850
Fuel Filter.....	FC-5510
Hydraulic Oil Filter.....	HC-55300
Hydraulic Oil Filter.....	HC-5516
Hydraulic Oil Filter.....	HC-5511
Hydraulic Oil Filter.....	HC-55290
Hydraulic Oil Filter.....	H-5522
365C (EXCAVATORS) CAT C15 (S/N: PAR2-UP)	
Air Filter Primary.....	A-5593
Air Filter Set.....	A-5595-S
Air Filter Secondary.....	A-5594
Cabin Air Filter.....	CA-55850
Fuel Filter.....	FC-5510
Hydraulic Oil Filter.....	HC-55300
Hydraulic Oil Filter.....	H-5522
Hydraulic Oil Filter.....	HC-5511
Hydraulic Oil Filter.....	HC-5516
Hydraulic Oil Filter.....	HC-55290
365C (EXCAVATORS) S/N: GWC1-10-UP	
Air Filter Primary.....	A-5593
Air Filter Set.....	A-5595-S

MODEL/APPLICATION	SAKURA NO
CATERPILLAR	
365C (EXCAVATORS) S/N: GWC1-10-UP	
Air Filter Secondary.....	A-5594
Cabin Air Filter.....	CA-55850
Fuel Filter.....	FC-5510
Hydraulic Oil Filter.....	HC-55300
Hydraulic Oil Filter.....	HC-55290
Hydraulic Oil Filter.....	H-5522
Hydraulic Oil Filter.....	HC-5516
Hydraulic Oil Filter.....	HC-5511
365C (EXCAVATORS) S/N: PAR1-1-UP	
Air Filter Secondary.....	A-5594
Air Filter Set.....	A-5595-S
Air Filter Primary.....	A-5593
Cabin Air Filter.....	CA-55850
Hydraulic Oil Filter.....	HC-5516
Hydraulic Oil Filter.....	HC-5511
Hydraulic Oil Filter.....	HC-55290
Hydraulic Oil Filter.....	H-5522
Hydraulic Oil Filter.....	HC-55300
374F (EXCAVATORS)	
Cabin Air Filter.....	CAV-55170
Cabin Air Filter.....	CAC-55170
Cabin Air Filter.....	CA-55170
374F L (EXCAVATORS)	
Cabin Air Filter.....	CAV-55170
Cabin Air Filter.....	CAC-55170
Cabin Air Filter.....	CA-55170
375 (EXCAVATORS) CAT 3406 (S/N: 1JM1-UP)	
Air Filter Secondary.....	A-5715
Fuel Filter.....	F-5505
Fuel Filter.....	FC-5509
Hydraulic Oil Filter.....	HC-5511
Hydraulic Oil Filter.....	H-5505
Hydraulic Oil Filter.....	HC-5516
Oil Filter Full Flow.....	C-5516
375 (EXCAVATORS) CAT 3406 (S/N: 6NK1-UP)	
Air Filter Secondary.....	A-5715
Fuel Filter.....	F-5505
Fuel Filter.....	FC-5509
Hydraulic Oil Filter.....	HC-5511
Hydraulic Oil Filter.....	H-5505
Hydraulic Oil Filter.....	HC-5516
Oil Filter Full Flow.....	C-5516
375 (EXCAVATORS) CAT 3406 (S/N: 6RL1-UP)	
Air Filter Secondary.....	A-5715
Air Filter Primary.....	A-5629
Air Filter Secondary.....	A-5630
Fuel Filter.....	F-5505
Fuel Filter.....	FC-5509
Hydraulic Oil Filter.....	HC-5511
Hydraulic Oil Filter.....	H-5505
Hydraulic Oil Filter.....	HC-5516
Oil Filter Full Flow.....	C-5516
375L (EXCAVATORS) CAT 3406 (S/N: 11N01-UP)	
Air Filter Secondary.....	A-5715
Fuel Filter.....	F-5505
Fuel Filter.....	FC-5509
Hydraulic Oil Filter.....	HC-5511
Hydraulic Oil Filter.....	H-5505
Hydraulic Oil Filter.....	HC-5516
Oil Filter Full Flow.....	C-5516

MODEL/APPLICATION	SAKURA NO
CATERPILLAR	
Hydraulic Oil Filter.....	H-5505
Hydraulic Oil Filter.....	HC-5511
Oil Filter Full Flow.....	C-5516
375 (EXCAVATORS) CAT 3406 (S/N: 8WJ1-UP)	
Air Filter Primary.....	A-5629
Air Filter Secondary.....	A-5715
Air Filter Set.....	A-5629-S
Fuel Filter.....	FC-5509
Fuel Filter.....	F-5505
Hydraulic Oil Filter.....	HC-5511
Hydraulic Oil Filter.....	H-5505
Hydraulic Oil Filter.....	HC-5516
375 (EXCAVATORS) CAT 3406 (S/N: 8XG1-313-UP)	
Air Filter Secondary.....	A-5715
Fuel Filter.....	FC-5509
Fuel Filter.....	F-5505
Hydraulic Oil Filter.....	HC-5516
Hydraulic Oil Filter.....	HC-5511
Hydraulic Oil Filter.....	H-5505
Oil Filter Full Flow.....	C-5516
375 (EXCAVATORS) CAT 3406 (S/N: 8XG313-UP)	
Air Filter Primary.....	A-5629
Air Filter Set.....	A-5629-S
Air Filter Secondary.....	A-5630
Fuel Filter.....	F-5505
Fuel Filter.....	FC-5509
Hydraulic Oil Filter.....	HC-5516
Hydraulic Oil Filter.....	HC-5511
Hydraulic Oil Filter.....	H-5505
375 (EXCAVATORS) CAT 3406 (S/N: 9WL1-UP)	
Air Filter Secondary.....	A-5715
Fuel Filter.....	F-5505
Fuel Filter.....	FC-5509
Hydraulic Oil Filter.....	HC-5511
Hydraulic Oil Filter.....	H-5505
Hydraulic Oil Filter.....	HC-5516
Oil Filter Full Flow.....	C-5516
375 (EXCAVATORS) S/N: 8XG313-UP	
Air Filter Primary.....	A-5629
Air Filter Set.....	A-5629-S
Air Filter Secondary.....	A-5630
Fuel Filter.....	F-5505
Fuel Filter.....	FC-5509
Hydraulic Oil Filter.....	HC-55300
Hydraulic Oil Filter.....	HC-5511
Hydraulic Oil Filter.....	H-5505
Hydraulic Oil Filter.....	HC-55200
Hydraulic Oil Filter.....	HC-5516
Oil Filter Full Flow.....	C-5516
375L (EXCAVATORS) CAT 3406 (S/N: 11N01-UP)	
Air Filter Secondary.....	A-5715
Coolant Filter.....	WC-5707

MODEL/APPLICATION	SAKURA NO
CATERPILLAR	
Coolant Filter.....	WC-5705
Fuel Filter.....	FC-5509
Fuel Filter.....	F-5505
Hydraulic Oil Filter.....	H-5505
Oil Filter Full Flow.....	C-5516
375L (EXCAVATORS) CAT 3406 (S/N: 1JM1-UP)	
Air Filter Secondary.....	A-5715
Coolant Filter.....	WC-5707
Coolant Filter.....	WC-5705
Fuel Filter.....	F-5505
Fuel Filter.....	FC-5509
Hydraulic Oil Filter.....	H-5505
Oil Filter Full Flow.....	C-5516
375L (EXCAVATORS) CAT 3406 (S/N: 6RL1-UP)	
Air Filter Secondary.....	A-5715
Air Filter Set.....	A-5629-S
Air Filter Primary.....	A-5629
Air Filter Secondary.....	A-5630
Fuel Filter.....	FC-5509
Fuel Filter.....	F-5505
Hydraulic Oil Filter.....	HC-5511
Hydraulic Oil Filter.....	HC-5516
Hydraulic Oil Filter.....	H-5505
375L (EXCAVATORS) CAT 3406 (S/N: 8WJ1-UP)	
Air Filter Secondary.....	A-5630
Air Filter Set.....	A-5629-S
Air Filter Primary.....	A-5629
Air Filter Secondary.....	A-5715
Fuel Filter.....	F-5505
Fuel Filter.....	FC-5509
Hydraulic Oil Filter.....	HC-5516
Hydraulic Oil Filter.....	HC-5511
Hydraulic Oil Filter.....	H-5505
375L (EXCAVATORS) CAT 3406 (S/N: 8WJ771-UP)	
Air Filter Secondary.....	A-5715
Coolant Filter.....	WC-5707
Coolant Filter.....	WC-5705
Fuel Filter.....	F-5505
Fuel Filter.....	FC-5509
Hydraulic Oil Filter.....	H-5505
Oil Filter Full Flow.....	C-5516
375L (EXCAVATORS) S/N: 8HK1-UP	
Air Filter Secondary.....	A-5630
Hydraulic Oil Filter.....	HC-55200
Hydraulic Oil Filter.....	H-5505
Oil Filter Full Flow.....	C-5516
375L (EXCAVATORS) S/N: 9FL1-UP	
Air Filter Secondary.....	A-5630
Hydraulic Oil Filter.....	H-5505
Hydraulic Oil Filter.....	HC-55200
Oil Filter Full Flow.....	C-5516

MODEL/APPLICATION	SAKURA NO
CATERPILLAR	
385B (EXCAVATORS) CAT 3456 (S/N: ANS1-UP)	
Air Filter Secondary.....	A-5594
Air Filter Set.....	A-5595-S
Air Filter Primary.....	A-5593
Fuel Filter.....	FC-5517
Fuel/Water Separator Secondary..	SFC-5504-10
Fuel/Water Separator Secondary..	SFC-5504-10B
Hydraulic Oil Filter.....	H-7942
Hydraulic Oil Filter.....	HC-5511
Hydraulic Oil Filter.....	HC-5516
Oil Filter Full Flow.....	C-5516
385B (EXCAVATORS) CAT 3456 (S/N: BFK1-UP)	
Air Filter Set.....	A-5595-S
Air Filter Primary.....	A-5593
Air Filter Secondary.....	A-5594
Cabin Air Filter.....	CA-55850
Fuel Filter.....	FC-5517
Fuel/Water Separator Secondary..	SFC-5504-10B
Fuel/Water Separator Secondary..	SFC-5504-10
Hydraulic Oil Filter.....	H-7942
Hydraulic Oil Filter.....	H-5522
Hydraulic Oil Filter.....	HC-5511
Hydraulic Oil Filter.....	HC-5516
385B (EXCAVATORS) CAT 3456 (S/N: BLY1-UP)	
Air Filter Set.....	A-5595-S
Air Filter Primary.....	A-5593
Air Filter Secondary.....	A-5594
Cabin Air Filter.....	CA-55850
Fuel Filter.....	FC-5517
Fuel/Water Separator Secondary..	SFC-5504-10
Fuel/Water Separator Secondary..	SFC-5504-10B
Hydraulic Oil Filter.....	HC-5511
Hydraulic Oil Filter.....	H-5522
Hydraulic Oil Filter.....	H-7942
Hydraulic Oil Filter.....	HC-5516
385B (EXCAVATORS) CAT 3456 (S/N: CKB1-UP)	
Air Filter Secondary.....	A-5594
Air Filter Primary.....	A-5593
Air Filter Set.....	A-5595-S
Fuel Filter.....	FC-5517
Fuel/Water Separator Secondary..	SFC-5504-10B
Fuel/Water Separator Secondary..	SFC-5504-10
Hydraulic Oil Filter.....	HC-5511
Hydraulic Oil Filter.....	H-7942
385B (EXCAVATORS) CAT 3456 (S/N: CLS1-UP)	
Air Filter Set.....	A-5595-S
Air Filter Primary.....	A-5593
Air Filter Secondary.....	A-5594
Fuel Filter.....	FC-5517
Fuel/Water Separator Secondary..	SFC-5504-10B
Fuel/Water Separator Secondary..	SFC-5504-10
Hydraulic Oil Filter.....	HC-5511
Hydraulic Oil Filter.....	H-5522
Hydraulic Oil Filter.....	H-7942

MODEL/APPLICATION	SAKURA NO
CATERPILLAR	
Hydraulic Oil Filter.....	HC-5511
Oil Filter Full Flow.....	C-5516
385B (EXCAVATORS) CAT 3456 (S/N: CLS215-UP)	
Air Filter Secondary.....	A-5594
Air Filter Primary.....	A-5593
Air Filter Set.....	A-5595-S
Fuel Filter.....	FC-5517
Fuel/Water Separator Secondary..	SFC-5504-10
Fuel/Water Separator Secondary..	SFC-5504-10B
Hydraulic Oil Filter.....	HC-5516
Hydraulic Oil Filter.....	H-7942
Hydraulic Oil Filter.....	H-5522
Hydraulic Oil Filter.....	HC-5511
Oil Filter Full Flow.....	C-5516
385B (EXCAVATORS) CAT 3456 (S/N: FDL161-UP)	
Air Filter Set.....	A-5595-S
Air Filter Secondary.....	A-5594
Air Filter Primary.....	A-5593
Fuel Filter.....	FC-5517
Fuel/Water Separator Secondary..	SFC-5504-10
Fuel/Water Separator Secondary..	SFC-5504-10B
Hydraulic Oil Filter.....	H-7942
Hydraulic Oil Filter.....	HC-5511
Hydraulic Oil Filter.....	HC-5516
Hydraulic Oil Filter.....	H-5522
Oil Filter Full Flow.....	C-5516
385B (EXCAVATORS) CAT 3456 (S/N: FDL1-UP)	
Air Filter Primary.....	A-5593
Air Filter Secondary.....	A-5594
Air Filter Set.....	A-5595-S
Fuel Filter.....	FC-5517
Fuel/Water Separator Secondary..	SFC-5504-10B
Fuel/Water Separator Secondary..	SFC-5504-10
Hydraulic Oil Filter.....	H-5522
Hydraulic Oil Filter.....	H-7942
Hydraulic Oil Filter.....	HC-5516
Hydraulic Oil Filter.....	HC-5511
Oil Filter Full Flow.....	C-5516
385B (EXCAVATORS) CAT 3456 (S/N: MYA1-UP)	
Air Filter Secondary.....	A-5594
Air Filter Primary.....	A-5593
Air Filter Set.....	A-5595-S
Fuel Filter.....	FC-5517
Fuel/Water Separator Secondary..	SFC-5504-10B
Fuel/Water Separator Secondary..	SFC-5504-10
Hydraulic Oil Filter.....	HC-5511
Hydraulic Oil Filter.....	HC-5516
Hydraulic Oil Filter.....	H-7942
385B (EXCAVATORS) CAT 3456 (S/N: RCD1-UP)	
Air Filter Set.....	A-5595-S
Air Filter Primary.....	A-5593
Air Filter Secondary.....	A-5594
Fuel Filter.....	FC-5517
Fuel/Water Separator Secondary..	SFC-5504-10

MODEL/APPLICATION	SAKURA NO
CATERPILLAR	
Fuel/Water Separator Secondary..	SFC-5504-10B
Hydraulic Oil Filter.....	H-5522
Hydraulic Oil Filter.....	HC-5516
Hydraulic Oil Filter.....	HC-5511
Hydraulic Oil Filter.....	H-7942
385BL (EXCAVATORS) CAT 3456 (S/N: ANS1-UP)	
Air Filter Set.....	A-5595-S
Air Filter Primary.....	A-5593
Air Filter Secondary.....	A-5594
Fuel Filter.....	FC-5517
Fuel/Water Separator Secondary..	SFC-5504-10
Fuel/Water Separator Secondary..	SFC-5504-10B
Hydraulic Oil Filter.....	HC-5511
Hydraulic Oil Filter.....	H-7942
385BL (EXCAVATORS) CAT 3456 (S/N: CKB1-UP)	
Air Filter Secondary.....	A-5594
Air Filter Set.....	A-5595-S
Air Filter Primary.....	A-5593
Fuel Filter.....	FC-5517
Fuel/Water Separator Secondary..	SFC-5504-10B
Fuel/Water Separator Secondary..	SFC-5504-10
Hydraulic Oil Filter.....	H-7942
Hydraulic Oil Filter.....	HC-5511
385BL (EXCAVATORS) CAT 3456 (S/N: CLS1-UP)	
Air Filter Set.....	A-5595-S
Air Filter Primary.....	A-5593
Air Filter Secondary.....	A-5594
Fuel Filter.....	FC-5517
Fuel/Water Separator Secondary..	SFC-5504-10B
Fuel/Water Separator Secondary..	SFC-5504-10
Hydraulic Oil Filter.....	HC-5516
Hydraulic Oil Filter.....	HC-5511
385BL (EXCAVATORS) CAT 3456 (S/N: FDL1-UP)	
Air Filter Set.....	A-5595-S
Air Filter Secondary.....	A-5594
Air Filter Primary.....	A-5593
Fuel Filter.....	FC-5517
Fuel/Water Separator Secondary..	SFC-5504-10B
Fuel/Water Separator Secondary..	SFC-5504-10
Hydraulic Oil Filter.....	HC-5516
Hydraulic Oil Filter.....	HC-5511
385C (EXCAVATORS) 2007-UP	
Air Filter Secondary.....	A-5594
Air Filter Primary.....	A-5593
Air Filter Set.....	A-5595-S
Fuel Filter.....	FC-5510
Hydraulic Oil Filter.....	HC-55290
Hydraulic Oil Filter.....	HC-5503
385C (EXCAVATORS) CAT C18 ACERT	
Hydraulic Oil Filter.....	HC-9901
385CL (EXCAVATORS) CAT C18 ACERT	
Hydraulic Oil Filter.....	H-5507

Sakura Filter

ENGINE APPLICATION

MODEL/APPLICATION	SAKURA NO	MODEL/APPLICATION	SAKURA NO	MODEL/APPLICATION	SAKURA NO
CATERPILLAR		CATERPILLAR		CATERPILLAR	
390F (EXCAVATORS)		Hydraulic Oil Filter.....	HC-5506	Hydraulic Oil Filter Transmission....	HC-5501
Cabin Air Filter.....	CA-55170	Oil Filter Full Flow.....	C-5102	416E (BACKHOE LOADERS) S/N: BWC1-UP , 2011	
Cabin Air Filter.....	CAC-55170	416B (BACKHOE LOADERS) S/N: 85G-UP		Cabin Air Filter.....	CA-44360
Cabin Air Filter.....	CAV-55170	Air Filter Primary.....	A-5577	Hydraulic Oil Filter.....	HC-5512
390F L (EXCAVATORS)		Air Filter Secondary.....	A-5580	Oil Filter Full Flow.....	C-5102
Cabin Air Filter.....	CA-55170	Air Filter Set.....	A-5579-S	416E (BACKHOE LOADERS) S/N: CBD 5745-UP , 2011	
Cabin Air Filter.....	CAC-55170	Air Filter Set.....	A-5578-S	Cabin Air Filter.....	CA-44360
Cabin Air Filter.....	CAV-55170	Fuel Filter.....	FS-5701	Oil Filter Full Flow.....	C-5102
414E (BACKHOE LOADERS) CAT 3054		Hydraulic Oil Filter.....	HC-5503	416E (BACKHOE LOADERS) S/N: CBD1-5744 , 2011	
Cabin Air Filter.....	CA-55110	Oil Filter Full Flow.....	C-5102	Cabin Air Filter.....	CA-44360
414E (BACKHOE LOADERS) CAT (S/N: CRS1-UP)		416B (BACKHOE LOADERS) S/N: 82K1-5999		Hydraulic Oil Filter.....	HC-5512
Oil Filter Full Flow.....	C-5102	Air Filter Set.....	A-5579-S	Oil Filter Full Flow.....	C-5102
414E (BACKHOE LOADERS) CAT (S/N: G4D1-UP)		Air Filter Secondary.....	A-5580	416E (BACKHOE LOADERS) S/N: LMS1-UP , 2011	
Oil Filter Full Flow.....	C-5102	Air Filter Set.....	A-5578-S	Cabin Air Filter.....	CA-44360
414E (BACKHOE LOADERS) S/N: ELB1-UP		Air Filter Primary.....	A-5577	Hydraulic Oil Filter.....	HC-5512
Cabin Air Filter.....	CA-44360	Hydraulic Oil Filter.....	HC-5512	Oil Filter Full Flow.....	C-5102
Hydraulic Oil Filter.....	HC-5512	Hydraulic Oil Filter.....	HC-5506	416E (BACKHOE LOADERS) S/N: SHA1-UP , 2011	
Oil Filter Full Flow.....	C-5102	Oil Filter Full Flow.....	C-5102	Cabin Air Filter.....	CA-44360
414E IL (BACKHOE LOADERS) CAT 3054		416D (BACKHOE LOADERS) S/N: 8ZK6000-UP		Hydraulic Oil Filter.....	HC-5512
Cabin Air Filter.....	CA-55110	Air Filter Set.....	A-5579-S	Oil Filter Full Flow.....	C-5102
415F2 (BACKHOE LOADERS) CAT C3.4		Air Filter Set.....	A-5578-S	416E (BACKHOE LOADERS) 3054C	
Cabin Air Filter.....	CA-55110	Air Filter Primary.....	A-5577	Cabin Air Filter.....	CA-44360
416 (BACKHOE LOADERS) S/N: 5PC1-10761		Air Filter Secondary.....	A-5580	Fuel Filter.....	FS-5701
Air Filter Set.....	A-5579-S	Air Filter Set.....	A-5541M-S	Hydraulic Oil Filter.....	HC-5512
Air Filter Primary.....	A-5577	Air Filter Primary.....	A-5541	Oil Filter Full Flow.....	C-5102
Air Filter Secondary.....	A-5580	Hydraulic Oil Filter.....	HC-5512	416E (BACKHOE LOADERS) C4.4	
Air Filter Set.....	A-5578-S	Oil Filter Full Flow.....	C-5102	Cabin Air Filter.....	CA-44360
Hydraulic Oil Filter.....	H-5506	416D (BACKHOE LOADERS) CAT 3054B (S/N: BFP1-UP)		Fuel Filter.....	FS-5701
Hydraulic Oil Filter.....	H-5510	Air Filter Primary.....	A-5541M	Hydraulic Oil Filter.....	HC-5512
416B (BACKHOE LOADERS) S/N: 85G1-11999		Air Filter Primary.....	A-76231	Oil Filter Full Flow.....	C-5102
Air Filter Set.....	A-5579-S	Air Filter Secondary.....	A-5540	416E (BACKHOE LOADERS) CAT (S/N: CRS1-UP)	
Air Filter Set.....	A-5579-S	Air Filter Set.....	A-5541M-S	Oil Filter Full Flow.....	C-5102
Air Filter Primary.....	A-5577	Air Filter Primary.....	A-5541	416E (BACKHOE LOADERS) S/N: G4D1-UP	
Air Filter Secondary.....	A-5580	Hydraulic Oil Filter.....	HC-5512	Oil Filter Full Flow.....	C-5102
Air Filter Set.....	A-5578-S	Oil Filter Full Flow.....	C-5102	416E (BACKHOE LOADERS) S/N: CBD1-UP	
Fuel Filter.....	FS-5701	416D (BACKHOE LOADERS) CAT 3054B (S/N: BKG1-UP)		Hydraulic Oil Filter.....	HC-5512
Hydraulic Oil Filter.....	HC-5512	Air Filter Set.....	A-5541M-S	416B TURBO (BACKHOE LOADERS) S/N: 85G1-UP	
Hydraulic Oil Filter.....	HC-5503	Air Filter Primary.....	A-5541M	Air Filter Secondary.....	A-5580
Oil Filter Full Flow.....	C-5102	Air Filter Secondary.....	A-5540	Air Filter Set.....	A-5579-S
416B (BACKHOE LOADERS) S/N: 85G1-11999		Air Filter Primary.....	A-5541M	Air Filter Primary.....	A-5577
Air Filter Set.....	A-5579-S	Hydraulic Oil Filter.....	HC-5512	Air Filter Set.....	A-5578-S
Air Filter Set.....	A-5579-S	Oil Filter Full Flow.....	C-5102	Fuel Filter.....	FS-5701
Air Filter Primary.....	A-5577	416D (BACKHOE LOADERS) CAT 3054C DIT		Hydraulic Oil Filter.....	HC-5503
Air Filter Secondary.....	A-5580	Air Filter Set.....	A-5541M-S	416C (BACKHOE LOADERS) CAT 3054T (S/N: 1WR8116-UP)	
Air Filter Primary.....	A-5577	Air Filter Primary.....	A-5541M		
Hydraulic Oil Filter.....	HC-5503	Air Filter Secondary.....	A-5540		
Hydraulic Oil Filter.....	HC-5512	Air Filter Primary.....	A-76231		

MODEL/APPLICATION	SAKURA NO
CATERPILLAR	
416C (BACKHOE LOADERS) CAT 3054T (S/N: 1WR8116-UP)	
Air Filter Set.....	A-5541M-S
Air Filter Secondary.....	A-5540
Air Filter Primary.....	A-5541M
Air Filter Primary.....	A-76231
Air Filter Primary.....	A-5541
Hydraulic Oil Filter.....	HC-5512
Hydraulic Oil Filter Transmission...	HC-5501
Oil Filter Full Flow.....	C-5102
416C (BACKHOE LOADERS) CAT 3054T (S/N: 1XR2184-2249)	
Air Filter Set.....	A-5541M-S
Air Filter Primary.....	A-5541
Air Filter Primary.....	A-5541M
Air Filter Secondary.....	A-5540
Air Filter Primary.....	A-76231
Hydraulic Oil Filter Transmission...	HC-5501
Hydraulic Oil Filter.....	HC-5512
Oil Filter Full Flow.....	C-5102
416C (BACKHOE LOADERS) CAT 3054T (S/N: 4ZN16004-UP)	
Air Filter Primary.....	A-76231
Air Filter Primary.....	A-5541
Air Filter Primary.....	A-5541M
Air Filter Set.....	A-5541M-S
Air Filter Secondary.....	A-5540
Hydraulic Oil Filter Transmission...	HC-5501
Hydraulic Oil Filter.....	HC-5512
Oil Filter Full Flow.....	C-5102
416C (BACKHOE LOADERS) CAT 3054T (S/N: 5YN15148-UP)	
Air Filter Secondary.....	A-5540
Air Filter Set.....	A-5541M-S
Air Filter Primary.....	A-76231
Air Filter Primary.....	A-5541M
Air Filter Primary.....	A-5541
Hydraulic Oil Filter Transmission...	HC-5501
Hydraulic Oil Filter.....	HC-5512
Oil Filter Full Flow.....	C-5102
416C (BACKHOE LOADERS) CAT 3054T (S/N: BFP1-UP)	
Air Filter Secondary.....	A-5540
Air Filter Primary.....	A-5541
Air Filter Primary.....	A-76231
Air Filter Set.....	A-5541M-S
Air Filter Primary.....	A-5541M
Hydraulic Oil Filter.....	HC-5512
Hydraulic Oil Filter Transmission...	HC-5501
Oil Filter Full Flow.....	C-5102
416C (BACKHOE LOADERS) CAT 3054T (S/N: BGJ1-UP)	
Air Filter Primary.....	A-5541M
Air Filter Primary.....	A-76231
Air Filter Primary.....	A-5541
Air Filter Secondary.....	A-5540
Air Filter Set.....	A-5541M-S
Hydraulic Oil Filter Transmission...	HC-5501
Hydraulic Oil Filter.....	HC-5512

MODEL/APPLICATION	SAKURA NO
CATERPILLAR	
Oil Filter Full Flow.....	C-5102
416C (BACKHOE LOADERS) CAT 3054T (S/N: BKG1-UP)	
Air Filter Primary.....	A-5541
Air Filter Primary.....	A-5541M
Air Filter Primary.....	A-76231
Air Filter Set.....	A-5541M-S
Air Filter Secondary.....	A-5540
Hydraulic Oil Filter Transmission...	HC-5501
Hydraulic Oil Filter.....	HC-5512
Oil Filter Full Flow.....	C-5102
416C (BACKHOE LOADERS) CAT 7BJ1-UP	
Air Filter Primary.....	A-56731
Air Filter Set.....	A-56731-S
Air Filter Secondary.....	A-56741
416C (BACKHOE LOADERS) S/N: 1AR1-UP	
Air Filter Primary.....	A-5541M
Air Filter Secondary.....	A-5540
Air Filter Primary.....	A-76231
Air Filter Set.....	A-5541M-S
Air Filter Primary.....	A-5541
Hydraulic Oil Filter.....	HC-5512
Hydraulic Oil Filter.....	HC-5506
Oil Filter Full Flow.....	C-5102
416C (BACKHOE LOADERS) S/N: 1AR-UP	
Air Filter Primary.....	A-5541M
Air Filter Primary.....	A-76231
Air Filter Primary.....	A-5541
Air Filter Set.....	A-5541M-S
Air Filter Secondary.....	A-5540
Hydraulic Oil Filter.....	HC-5506
Hydraulic Oil Filter.....	HC-5503
Hydraulic Oil Filter.....	HC-5512
Oil Filter Full Flow.....	C-5102
416C (BACKHOE LOADERS) S/N: 1BR1-UP	
Air Filter Primary.....	A-5541M
Air Filter Secondary.....	A-5540
Air Filter Primary.....	A-76231
Air Filter Primary.....	A-5541
Air Filter Set.....	A-5541M-S
Hydraulic Oil Filter.....	HC-5503
Hydraulic Oil Filter.....	HC-5506
Hydraulic Oil Filter.....	HC-5512
Oil Filter Full Flow.....	C-5102
416C (BACKHOE LOADERS) S/N: 1BR-UP	
Air Filter Primary.....	A-5541M
Air Filter Primary.....	A-5541
Air Filter Set.....	A-5541M-S
Air Filter Secondary.....	A-5540
Air Filter Primary.....	A-76231
Hydraulic Oil Filter.....	HC-5512
Hydraulic Oil Filter.....	HC-5503
Hydraulic Oil Filter.....	HC-5506

MODEL/APPLICATION	SAKURA NO
CATERPILLAR	
Oil Filter Full Flow.....	C-5102
416C (BACKHOE LOADERS) S/N: 1CR-UP	
Air Filter Set.....	A-5541M-S
Air Filter Primary.....	A-76231
Air Filter Primary.....	A-5541M
Air Filter Secondary.....	A-5540
Air Filter Primary.....	A-5541
Hydraulic Oil Filter.....	HC-5512
Hydraulic Oil Filter.....	HC-5503
Hydraulic Oil Filter.....	HC-5506
Oil Filter Full Flow.....	C-5102
416C (BACKHOE LOADERS) S/N: 1KR1-UP	
Air Filter Primary.....	A-5541M
Air Filter Secondary.....	A-5540
Air Filter Primary.....	A-5541
Air Filter Primary.....	A-76231
Air Filter Set.....	A-5541M-S
Hydraulic Oil Filter.....	HC-5512
Hydraulic Oil Filter.....	HC-5506
Oil Filter Full Flow.....	C-5102
416C (BACKHOE LOADERS) S/N: 1LR1-UP	
Air Filter Primary.....	A-5541M
Air Filter Primary.....	A-5541
Air Filter Primary.....	A-76231
Air Filter Set.....	A-5541M-S
Air Filter Secondary.....	A-5540
Hydraulic Oil Filter.....	HC-5512
Hydraulic Oil Filter.....	HC-5503
Hydraulic Oil Filter.....	HC-5506
Oil Filter Full Flow.....	C-5102
416C (BACKHOE LOADERS) S/N: 1WR1-8115	
Air Filter Set.....	A-5541M-S
Air Filter Primary.....	A-5541
Air Filter Secondary.....	A-5540
Air Filter Primary.....	A-5541M
Air Filter Primary.....	A-76231
Hydraulic Oil Filter.....	HC-5506
Hydraulic Oil Filter.....	HC-5512
Oil Filter Full Flow.....	C-5102
416C (BACKHOE LOADERS) S/N: 1WR-UP	
Air Filter Primary.....	A-5541M
Air Filter Primary.....	A-5541
Air Filter Primary.....	A-76231
Air Filter Secondary.....	A-5540
Air Filter Set.....	A-5541M-S
Hydraulic Oil Filter.....	HC-5503
Hydraulic Oil Filter.....	HC-5512
Hydraulic Oil Filter.....	HC-5506
Oil Filter Full Flow.....	C-5102
416C (BACKHOE LOADERS) S/N: 1XR1-2183	
Air Filter Secondary.....	A-5540
Air Filter Primary.....	A-5541M
Air Filter Primary.....	A-5541

MODEL/APPLICATION	SAKURA NO	MODEL/APPLICATION	SAKURA NO	MODEL/APPLICATION	SAKURA NO
CATERPILLAR		CATERPILLAR		CATERPILLAR	
416C <i>(BACKHOE LOADERS)</i> S/N: 1XR1-2183		Hydraulic Oil Filter.....	HC-5506	420E <i>(BACKHOE LOADERS)</i> S/N: KMW1-UP , 2011	
Air Filter Set.....	A-5541M-S	Hydraulic Oil Filter.....	HC-5503	Cabin Air Filter.....	CA-44360
Air Filter Primary.....	A-76231	Oil Filter Full Flow.....	C-5102	Hydraulic Oil Filter.....	HC-5512
Hydraulic Oil Filter.....	HC-5512	416C <i>(BACKHOE LOADERS)</i> S/N: 5YN-UP		Oil Filter Full Flow.....	C-5102
Hydraulic Oil Filter.....	HC-5503	Air Filter Primary.....	A-76231	420E <i>(BACKHOE LOADERS)</i> S/N: PRA1-UP , 2011	
Hydraulic Oil Filter.....	HC-5506	Air Filter Primary.....	A-5541	Cabin Air Filter.....	CA-44360
Oil Filter Full Flow.....	C-5102	Air Filter Primary.....	A-5541M	Hydraulic Oil Filter.....	HC-5512
416C <i>(BACKHOE LOADERS)</i> S/N: 1XR2250-UP		Air Filter Secondary.....	A-5540	Oil Filter Full Flow.....	C-5102
Air Filter Secondary.....	A-5540	Air Filter Set.....	A-5541M-S	420E <i>(BACKHOE LOADERS)</i> C4.4	
Air Filter Primary.....	A-5541M	Hydraulic Oil Filter.....	HC-5512	Cabin Air Filter.....	CA-44360
Air Filter Primary.....	A-76231	Hydraulic Oil Filter.....	HC-5503	Fuel Filter.....	FC-51170
Air Filter Primary.....	A-5541	Hydraulic Oil Filter.....	HC-5506	Fuel Filter.....	FS-5701
Air Filter Set.....	A-5541M-S	Oil Filter Full Flow.....	C-5102	Hydraulic Oil Filter.....	HC-5512
Hydraulic Oil Filter.....	HC-5512	416F2 <i>(BACKHOE LOADERS)</i> C4.4 ACERT , 2015		Oil Filter Full Flow.....	C-5102
Hydraulic Oil Filter.....	HC-5506	Cabin Air Filter.....	CA-44360	420E <i>(BACKHOE LOADERS)</i> CAT C4.4	
Oil Filter Full Flow.....	C-5102	Fuel Filter.....	FS-5701	Cabin Air Filter.....	CA-55110
416C <i>(BACKHOE LOADERS)</i> S/N: 1XR-UP		Oil Filter Full Flow.....	C-5102	420E <i>(BACKHOE LOADERS)</i> CAT 3054C	
Air Filter Primary.....	A-5541	416F2 <i>(LOADERS)</i> C4.4 ACERT		Cabin Air Filter.....	CA-55110
Air Filter Set.....	A-5541M-S	Fuel/Water Separator.....	ES-55010	420E <i>(BACKHOE LOADERS)</i> S/N: PHC1-UP	
Air Filter Secondary.....	A-5540	420D <i>(BACKHOE LOADERS)</i> CAT 7BJ1-UP		Cabin Air Filter.....	CA-44360
Air Filter Primary.....	A-76231	Air Filter Primary.....	A-56731	Fuel Filter.....	FC-51170
Air Filter Primary.....	A-5541M	Air Filter Secondary.....	A-56741	Hydraulic Oil Filter.....	HC-5512
Hydraulic Oil Filter.....	HC-5506	Air Filter Set.....	A-56731-S	Oil Filter Full Flow.....	C-5102
Hydraulic Oil Filter.....	HC-5512	420E <i>(BACKHOE LOADERS)</i> S/N: DAN1-UP , 2011		420F2 <i>(BACKHOE LOADERS)</i> 3054C	
Hydraulic Oil Filter.....	HC-5503	Cabin Air Filter.....	CA-44360	Cabin Air Filter.....	CA-55110
Oil Filter Full Flow.....	C-5102	Hydraulic Oil Filter.....	HC-5512	420F <i>(LOADERS)</i> C4.4 ACERT	
416C <i>(BACKHOE LOADERS)</i> S/N: 42N1-16043		Oil Filter Full Flow.....	C-5102	Fuel/Water Separator.....	ES-55010
Air Filter Set.....	A-5541M-S	420E <i>(BACKHOE LOADERS)</i> S/N: DJL1-UP , 2011		422E <i>(BACKHOE LOADERS)</i> 3054C	
Air Filter Primary.....	A-5541M	Cabin Air Filter.....	CA-44360	Cabin Air Filter.....	CA-55110
Air Filter Primary.....	A-5541	Hydraulic Oil Filter.....	HC-5512	422E <i>(BACKHOE LOADERS)</i> CAT C4.4	
Air Filter Secondary.....	A-5540	Oil Filter Full Flow.....	C-5102	Cabin Air Filter.....	CA-55110
Air Filter Primary.....	A-76231	420E <i>(BACKHOE LOADERS)</i> S/N: GAN1-UP , 2011		422E <i>(BACKHOE LOADERS)</i> CAT S/N: CRS1-UP	
Hydraulic Oil Filter.....	HC-5506	Cabin Air Filter.....	CA-44360	Hydraulic Oil Filter.....	HC-5512
Hydraulic Oil Filter.....	HC-5512	Hydraulic Oil Filter.....	HC-5512	Oil Filter Full Flow.....	C-5102
Hydraulic Oil Filter.....	HC-5503	Oil Filter Full Flow.....	C-5102	422E <i>(BACKHOE LOADERS)</i> CAT S/N: G4D1-UP	
Oil Filter Full Flow.....	C-5102	420E <i>(BACKHOE LOADERS)</i> S/N: GEK1-UP , 2011		Hydraulic Oil Filter.....	HC-5512
416C <i>(BACKHOE LOADERS)</i> S/N: 42N-UP		Cabin Air Filter.....	CA-44360	Oil Filter Full Flow.....	C-5102
Air Filter Primary.....	A-5541M	Hydraulic Oil Filter.....	HC-5512	422E <i>(BACKHOE LOADERS)</i> CAT S/N: HBE1-UP	
Air Filter Set.....	A-5541M-S	Oil Filter Full Flow.....	C-5102	Hydraulic Oil Filter.....	HC-5512
Air Filter Primary.....	A-5541	420E <i>(BACKHOE LOADERS)</i> S/N: HLS1-UP , 2011		Oil Filter Full Flow.....	C-5102
Air Filter Primary.....	A-76231	Cabin Air Filter.....	CA-44360	422E <i>(BACKHOE LOADERS)</i> CAT S/N: HBE1-UP	
Air Filter Secondary.....	A-5540	Hydraulic Oil Filter.....	HC-5512	Hydraulic Oil Filter.....	HC-5512
Hydraulic Oil Filter.....	HC-5506	Oil Filter Full Flow.....	C-5102	Oil Filter Full Flow.....	C-5102
Hydraulic Oil Filter.....	HC-5512	420E <i>(BACKHOE LOADERS)</i> S/N: GEK1-UP , 2011		422F <i>(BACKHOE LOADERS)</i> C4.4	
Hydraulic Oil Filter.....	HC-5503	Cabin Air Filter.....	CA-44360	422E <i>(BACKHOE LOADERS)</i> CAT S/N: HBE1-UP	
Oil Filter Full Flow.....	C-5102	Hydraulic Oil Filter.....	HC-5512	Hydraulic Oil Filter.....	HC-5512
416C <i>(BACKHOE LOADERS)</i> S/N: 5YN1-15147		Oil Filter Full Flow.....	C-5102	Oil Filter Full Flow.....	C-5102
Air Filter Set.....	A-5541M-S	420E <i>(BACKHOE LOADERS)</i> S/N: HLS1-UP , 2011		422E <i>(BACKHOE LOADERS)</i> CAT S/N: HBE1-UP	
Air Filter Primary.....	A-5541M	Cabin Air Filter.....	CA-44360	Hydraulic Oil Filter.....	HC-5512
Air Filter Primary.....	A-76231	Hydraulic Oil Filter.....	HC-5512	Oil Filter Full Flow.....	C-5102
Air Filter Primary.....	A-5541	Oil Filter Full Flow.....	C-5102	422F <i>(BACKHOE LOADERS)</i> C4.4	
Air Filter Secondary.....	A-5540	420E <i>(BACKHOE LOADERS)</i> S/N: HLS1-UP , 2011		422E <i>(BACKHOE LOADERS)</i> CAT S/N: HBE1-UP	
Hydraulic Oil Filter.....	HC-5512	Cabin Air Filter.....	CA-44360	Hydraulic Oil Filter.....	HC-5512
416C <i>(BACKHOE LOADERS)</i> S/N: 5YN1-15147		Hydraulic Oil Filter.....	HC-5512	Oil Filter Full Flow.....	C-5102
Air Filter Set.....	A-5541M-S	Oil Filter Full Flow.....	C-5102	422E <i>(BACKHOE LOADERS)</i> CAT S/N: HBE1-UP	
Air Filter Primary.....	A-5541M	420E <i>(BACKHOE LOADERS)</i> S/N: HLS1-UP , 2011		Hydraulic Oil Filter.....	HC-5512
Air Filter Primary.....	A-76231	Cabin Air Filter.....	CA-44360	Oil Filter Full Flow.....	C-5102
Air Filter Primary.....	A-5541	Hydraulic Oil Filter.....	HC-5512	422F <i>(BACKHOE LOADERS)</i> C4.4	
Air Filter Secondary.....	A-5540	Oil Filter Full Flow.....	C-5102	422E <i>(BACKHOE LOADERS)</i> CAT S/N: HBE1-UP	
Hydraulic Oil Filter.....	HC-5512	420E <i>(BACKHOE LOADERS)</i> S/N: HLS1-UP , 2011		Hydraulic Oil Filter.....	HC-5512

MODEL/APPLICATION	SAKURA NO
CATERPILLAR	
422F (BACKHOE LOADERS) C4.4 Cabin Air Filter.....	CA-55110
422F2 (BACKHOE LOADERS) C4.4 Cabin Air Filter.....	CA-55110
424D (BACKHOE LOADERS) CAT 3054C (S/N: BGP1-UP) Hydraulic Oil Filter Transmission... Hydraulic Oil Filter..... Oil Filter Full Flow.....	HC-5501 HC-5512 C-5102
424D (BACKHOE LOADERS) CAT 3054C (S/N: BKR1-UP) Hydraulic Oil Filter..... Hydraulic Oil Filter Transmission... Oil Filter Full Flow.....	HC-5512 HC-5501 C-5102
426 (BACKHOE LOADERS) S/N: 78C1-3476 Air Filter Primary..... Air Filter Set..... Air Filter Secondary..... Air Filter Set..... Hydraulic Oil Filter..... Hydraulic Oil Filter.....	A-5577 A-5579-S A-5580 A-5578-S H-5506 H-5510
426B (BACKHOE LOADERS) S/N: 5YJ1-2299 Air Filter Set..... Air Filter Set..... Air Filter Secondary..... Air Filter Primary..... Hydraulic Oil Filter..... Hydraulic Oil Filter..... Oil Filter Full Flow.....	A-5579-S A-5578-S A-5580 A-5577 HC-5503 HC-5512 C-5102
426B (BACKHOE LOADERS) S/N: 5YJ2300-UP Air Filter Set..... Air Filter Primary..... Air Filter Set..... Air Filter Secondary..... Hydraulic Oil Filter..... Hydraulic Oil Filter..... Hydraulic Oil Filter..... Oil Filter Full Flow.....	A-5579-S A-5577 A-5578-S A-5580 HC-5503 HC-5512 HC-5506 C-5102
426B (BACKHOE LOADERS) S/N: 6KL1-1199 Air Filter Set..... Air Filter Set..... Air Filter Secondary..... Air Filter Primary..... Hydraulic Oil Filter..... Hydraulic Oil Filter..... Oil Filter Full Flow.....	A-5579-S A-5578-S A-5580 A-5577 HC-5512 HC-5503 C-5102
426B (BACKHOE LOADERS) S/N: 6KL1200-UP Air Filter Primary..... Air Filter Set..... Air Filter Set.....	A-5577 A-5578-S A-5579-S

MODEL/APPLICATION	SAKURA NO
CATERPILLAR	
Hydraulic Oil Filter..... Hydraulic Oil Filter..... Oil Filter Full Flow.....	HC-5503 HC-5506 C-5102
426B (BACKHOE LOADERS) S/N: 6KL1-UP Air Filter Set..... Air Filter Set..... Air Filter Secondary..... Air Filter Primary..... Hydraulic Oil Filter..... Oil Filter Full Flow.....	A-5579-S A-5578-S A-5580 A-5577 HC-5503 C-5102
426B (BACKHOE LOADERS) S/N: 78C1-3476 Air Filter Primary..... Air Filter Set..... Air Filter Secondary..... Air Filter Set..... Fuel Filter..... Hydraulic Oil Filter..... Hydraulic Oil Filter.....	A-5577 A-5578-S A-5580 A-5579-S FC-5103 H-5506 H-5510
426C (BACKHOE LOADERS) CAT 78J1-UP Air Filter Primary..... Air Filter Secondary..... Air Filter Set.....	A-56731 A-56741 A-56731-S
426C (BACKHOE LOADERS) S/N: 1CR1-863 Air Filter Primary..... Air Filter Secondary..... Air Filter Primary..... Air Filter Primary..... Air Filter Set..... Hydraulic Oil Filter Transmission... Hydraulic Oil Filter..... Hydraulic Oil Filter..... Oil Filter Full Flow.....	A-76231 A-5540 A-5541 A-5541M A-5541M-S HC-5501 HC-5506 HC-5512 C-5102
426C (BACKHOE LOADERS) S/N: 1CR864-UP Air Filter Primary..... Air Filter Secondary..... Air Filter Primary..... Air Filter Set..... Air Filter Primary..... Hydraulic Oil Filter..... Hydraulic Oil Filter..... Hydraulic Oil Filter..... Oil Filter Full Flow.....	A-5541 A-5540 A-76231 A-5541M-S A-5541M HC-5512 HC-5501 HC-5506 C-5102
426C (BACKHOE LOADERS) S/N: 1ER1-863 Air Filter Primary..... Air Filter Primary..... Air Filter Set..... Air Filter Secondary..... Air Filter Primary..... Hydraulic Oil Filter Transmission... Hydraulic Oil Filter..... Hydraulic Oil Filter..... Oil Filter Full Flow.....	A-76231 A-5541M A-5541M-S A-5540 A-5541 HC-5501 HC-5506 HC-5512 C-5102

MODEL/APPLICATION	SAKURA NO
CATERPILLAR	
426C (BACKHOE LOADERS) S/N: 1ER864-899 Air Filter Primary..... Air Filter Primary..... Air Filter Primary..... Air Filter Secondary..... Air Filter Set..... Hydraulic Oil Filter Transmission... Hydraulic Oil Filter..... Oil Filter Full Flow.....	A-76231 A-5541 A-5541M A-5540 A-5541M-S HC-5501 HC-5512 C-5102
426C (BACKHOE LOADERS) S/N: 1ER900-UP Air Filter Secondary..... Air Filter Primary..... Air Filter Primary..... Air Filter Set..... Air Filter Primary..... Hydraulic Oil Filter..... Hydraulic Oil Filter..... Hydraulic Oil Filter Transmission... Oil Filter Full Flow.....	A-5540 A-76231 A-5541M A-5541M-S A-5541 HC-5506 HC-5512 HC-5501 C-5102
426C (BACKHOE LOADERS) S/N: 1MR1-955 Air Filter Set..... Air Filter Secondary..... Air Filter Primary..... Air Filter Primary..... Hydraulic Oil Filter..... Hydraulic Oil Filter..... Hydraulic Oil Filter Transmission... Oil Filter Full Flow.....	A-5541M-S A-5540 A-5541 A-76231 A-5541M HC-5512 HC-5506 HC-5501 C-5102
426C (BACKHOE LOADERS) S/N: 1MR956-UP Air Filter Set..... Air Filter Secondary..... Air Filter Primary..... Air Filter Primary..... Hydraulic Oil Filter..... Hydraulic Oil Filter Transmission... Oil Filter Full Flow.....	A-5541M-S A-5540 A-5541 A-76231 A-5541M HC-5512 HC-5501 C-5102
426C (BACKHOE LOADERS) S/N: 1NR1050-UP Air Filter Primary..... Air Filter Secondary..... Air Filter Primary..... Air Filter Primary..... Hydraulic Oil Filter..... Hydraulic Oil Filter Transmission... Hydraulic Oil Filter..... Oil Filter Full Flow.....	A-76231 A-5540 A-5541 A-5541M HC-5512 HC-5501 HC-5512 C-5102
426C (BACKHOE LOADERS) S/N: 1NR1-953 Air Filter Set..... Air Filter Primary..... Air Filter Secondary.....	A-5541M-S A-5541M A-5540

MODEL/APPLICATION	SAKURA NO	MODEL/APPLICATION	SAKURA NO	MODEL/APPLICATION	SAKURA NO
CATERPILLAR		CATERPILLAR		CATERPILLAR	
426C (BACKHOE LOADERS) S/N: 1NR1-953 Air Filter Primary..... A-76231 Air Filter Primary..... A-5541 Hydraulic Oil Filter..... HC-5512 Hydraulic Oil Filter Transmission... HC-5501 Hydraulic Oil Filter..... HC-5506 Hydraulic Oil Filter..... HC-5503 Oil Filter Full Flow..... C-5102		Hydraulic Oil Filter..... HC-5506 Hydraulic Oil Filter..... HC-5503 Hydraulic Oil Filter Transmission... HC-5501 Oil Filter Full Flow..... C-5102 426C (BACKHOE LOADERS) S/N: 1ZR926-999 Air Filter Primary..... A-5541 Air Filter Secondary..... A-5540 Air Filter Set..... A-5541M-S Air Filter Primary..... A-76231 Air Filter Primary..... A-5541M Hydraulic Oil Filter..... HC-5512 Hydraulic Oil Filter Transmission... HC-5501 Oil Filter Full Flow..... C-5102		426C (BACKHOE LOADERS) S/N: 7WN939-1099 Air Filter Set..... A-5541M-S Air Filter Primary..... A-5541 Air Filter Primary..... A-5541M Air Filter Primary..... A-76231 Air Filter Secondary..... A-5540 Hydraulic Oil Filter..... HC-5512 Hydraulic Oil Filter Transmission... HC-5501 Oil Filter Full Flow..... C-5102	
426C (BACKHOE LOADERS) S/N: 1NR954-1049 Air Filter Primary..... A-5541M Air Filter Primary..... A-5541 Air Filter Set..... A-5541M-S Air Filter Secondary..... A-5540 Air Filter Primary..... A-76231 Hydraulic Oil Filter..... HC-5512 Hydraulic Oil Filter Transmission... HC-5501 Oil Filter Full Flow..... C-5102		426C (BACKHOE LOADERS) S/N: 6XN1-3615 Air Filter Primary..... A-5541 Air Filter Primary..... A-5541M Air Filter Set..... A-5541M-S Air Filter Primary..... A-76231 Air Filter Secondary..... A-5540 Hydraulic Oil Filter Transmission... HC-5501 Hydraulic Oil Filter..... HC-5506 Hydraulic Oil Filter..... HC-5512 Oil Filter Full Flow..... C-5102		427F2 (BACKHOE LOADERS) C3.4B Fuel Filter..... EF-55040 427F2 (BACKHOE LOADERS) CAT C3.4 Cabin Air Filter..... CA-55110	
426C (BACKHOE LOADERS) S/N: 1YR1-1516 Air Filter Primary..... A-5541M Air Filter Secondary..... A-5540 Air Filter Set..... A-5541M-S Air Filter Primary..... A-76231 Air Filter Primary..... A-5541 Hydraulic Oil Filter..... HC-5512 Hydraulic Oil Filter..... HC-5506 Hydraulic Oil Filter Transmission... HC-5501 Oil Filter Full Flow..... C-5102		426C (BACKHOE LOADERS) S/N: 6XN3616-UP Air Filter Set..... A-5541M-S Air Filter Primary..... A-76231 Air Filter Secondary..... A-5540 Air Filter Primary..... A-5541 Air Filter Primary..... A-5541M Hydraulic Oil Filter..... HC-5512 Hydraulic Oil Filter Transmission... HC-5501 Oil Filter Full Flow..... C-5102		427F2 (LOADERS) S/N: 6TC1-UP Air Filter Set..... A-5579-S Air Filter Primary..... A-5577 Air Filter Secondary..... A-5580 Air Filter Set..... A-5578-S Fuel Filter..... FC-1010 Fuel Filter..... FC-5103 Hydraulic Oil Filter Transmission... HC-5501 Hydraulic Oil Filter..... H-5510 Hydraulic Oil Filter..... H-5506	
426C (BACKHOE LOADERS) S/N: 1YR1517-UP Air Filter Primary..... A-76231 Air Filter Primary..... A-5541M Air Filter Set..... A-5541M-S Air Filter Secondary..... A-5540 Air Filter Primary..... A-5541 Hydraulic Oil Filter..... HC-5512 Hydraulic Oil Filter Transmission... HC-5501 Oil Filter Full Flow..... C-5102		426C (BACKHOE LOADERS) S/N: 7WN1100-UP Air Filter Primary..... A-5541M Air Filter Set..... A-5541M-S Air Filter Secondary..... A-5540 Air Filter Primary..... A-5541 Air Filter Primary..... A-76231 Hydraulic Oil Filter..... HC-5506 Hydraulic Oil Filter..... HC-5512 Hydraulic Oil Filter Transmission... HC-5501 Oil Filter Full Flow..... C-5102		428B (BACKHOE LOADERS) PERKINS (S/N: 3KK1-2999) Air Filter Set..... A-5578-S Air Filter Secondary..... A-5580 Air Filter Set..... A-5579-S Air Filter Primary..... A-5577 Hydraulic Oil Filter..... HC-5506 Hydraulic Oil Filter..... HC-5512 Hydraulic Oil Filter..... HC-5503 Oil Filter Full Flow..... C-5102	
426C (BACKHOE LOADERS) S/N: 1ZR1000-UP Air Filter Primary..... A-76231 Air Filter Primary..... A-5541M Air Filter Primary..... A-5541 Air Filter Secondary..... A-5540 Air Filter Set..... A-5541M-S Hydraulic Oil Filter Transmission... HC-5501 Hydraulic Oil Filter..... HC-5506 Hydraulic Oil Filter..... HC-5512 Oil Filter Full Flow..... C-5102		426C (BACKHOE LOADERS) S/N: 7WN1-938 Air Filter Primary..... A-5541 Air Filter Secondary..... A-5540 Air Filter Primary..... A-76231 Air Filter Primary..... A-5541M Air Filter Set..... A-5541M-S Hydraulic Oil Filter Transmission... HC-5501 Hydraulic Oil Filter..... HC-5506 Hydraulic Oil Filter..... HC-5503 Oil Filter Full Flow..... C-5102		428B (BACKHOE LOADERS) PERKINS (S/N: 7E31-5999) Air Filter Secondary..... A-5580 Air Filter Set..... A-5579-S Air Filter Set..... A-5578-S Air Filter Primary..... A-5577 Hydraulic Oil Filter..... HC-5506 Hydraulic Oil Filter..... HC-5512 Hydraulic Oil Filter..... HC-5503 Oil Filter Full Flow..... C-5102	
426C (BACKHOE LOADERS) S/N: 1ZR1-925 Air Filter Primary..... A-76231 Air Filter Primary..... A-5541 Air Filter Secondary..... A-5540 Air Filter Set..... A-5541M-S Air Filter Primary..... A-5541M Hydraulic Oil Filter..... HC-5512		426C (BACKHOE LOADERS) S/N: 7WN16000-UP Air Filter Secondary..... A-5580 Air Filter Set..... A-5579-S Air Filter Set..... A-5578-S Air Filter Primary..... A-5577 Hydraulic Oil Filter..... HC-5503 Hydraulic Oil Filter..... HC-5512 Hydraulic Oil Filter..... HC-5506 Oil Filter Full Flow..... C-5102		428B (BACKHOE LOADERS) S/N: 7E36000-UP Air Filter Secondary..... A-5580 Air Filter Set..... A-5579-S Air Filter Set..... A-5578-S Air Filter Primary..... A-5577 Hydraulic Oil Filter..... HC-5503 Hydraulic Oil Filter..... HC-5512 Hydraulic Oil Filter..... HC-5506 Oil Filter Full Flow..... C-5102	

MODEL/APPLICATION	SAKURA NO	MODEL/APPLICATION	SAKURA NO	MODEL/APPLICATION	SAKURA NO
CATERPILLAR		CATERPILLAR		CATERPILLAR	
428C (BACKHOE LOADERS) CAT 3054 (S/N: 8RN1-UP) , 2008-UP		Hydraulic Oil Filter.....	HC-5512	Fuel Filter.....	FS-5701
Air Filter Secondary.....	A-5540	Oil Filter Full Flow.....	C-5102	Oil Filter Full Flow.....	C-5102
Oil Filter Full Flow.....	C-5102	428D (BACKHOE LOADERS) CAT 3054 (S/N: BNB1-UP)		430D (BACKHOE LOADERS) CAT 3054 (S/N: BML02281-UP)	
428C (BACKHOE LOADERS) S/N: 1HR1-300 , 2005-UP		Hydraulic Oil Filter.....	HC-5512	Air Filter Secondary.....	A-5540
Air Filter Secondary.....	A-5540	Oil Filter Full Flow.....	C-5102	Fuel Filter.....	FS-5701
428C (BACKHOE LOADERS) CAT 7BJ1-UP		428D (BACKHOE LOADERS) CAT 3054 (S/N: BNS1-UP)		Oil Filter Full Flow.....	C-5102
Air Filter Primary.....	A-56731	Air Filter Secondary.....	A-5540	430D (BACKHOE LOADERS) CAT 3054 (S/N: BML04800-UP)	
Air Filter Set.....	A-56731-S	Hydraulic Oil Filter.....	HC-5512	Fuel Filter.....	FS-5701
Air Filter Secondary.....	A-56741	Oil Filter Full Flow.....	C-5102	Hydraulic Oil Filter.....	HC-5512
428C (BACKHOE LOADERS) PERKINS (S/N: 7EJ1-UP)		428D (BACKHOE LOADERS) CAT 3054 (S/N: BXC1-UP)		Oil Filter Full Flow.....	C-5102
Air Filter Set.....	A-5579-S	Fuel Filter.....	FS-5701	430D (BACKHOE LOADERS) CAT 3054 (S/N: BMK05900-UP)	
Air Filter Set.....	A-5578-S	Hydraulic Oil Filter.....	HC-5512	Air Filter Secondary.....	A-5540
Air Filter Secondary.....	A-5580	Oil Filter Full Flow.....	C-5102	Hydraulic Oil Filter.....	HC-5512
Air Filter Primary.....	A-5577	428D (BACKHOE LOADERS) CAT 3054 (S/N: DSX1-UP)		Oil Filter Full Flow.....	C-5102
Hydraulic Oil Filter Transmission...	HC-5501	Fuel Filter.....	FS-5701	430D (BACKHOE LOADERS) CAT 3054 (S/N: BNK1-UP)	
428C (BACKHOE LOADERS) PERKINS (S/N: 8RN1-UP)		Hydraulic Oil Filter.....	HC-5512	Air Filter Secondary.....	A-5540
Air Filter Primary.....	A-5541M	Oil Filter Full Flow.....	C-5102	Hydraulic Oil Filter.....	HC-5512
Air Filter Set.....	A-5541M-S	428D (BACKHOE LOADERS) CAT 3054 (S/N: MBM1-UP)		Oil Filter Full Flow.....	C-5102
Air Filter Secondary.....	A-5540	Fuel Filter.....	FS-5701	430D (BACKHOE LOADERS) CAT 3054 (S/N: BNK1-UP)	
Air Filter Primary.....	A-76231	Hydraulic Oil Filter.....	HC-5512	Air Filter Secondary.....	A-5540
Air Filter Primary.....	A-5541	Oil Filter Full Flow.....	C-5102	Hydraulic Oil Filter.....	HC-5512
Fuel/Water Separator.....	SFC-5705	428E (BACKHOE LOADERS) CAT 3054DIT , 2006-UP		Oil Filter Full Flow.....	C-5102
Hydraulic Oil Filter.....	HC-5506	Fuel Filter.....	FS-5701	430D (BACKHOE LOADERS) S/N: BNK02502-UP	
Hydraulic Oil Filter.....	HC-5512	Hydraulic Oil Filter.....	HC-5512	Air Filter Secondary.....	A-5540
Hydraulic Oil Filter Transmission...	HC-5501	Oil Filter Full Flow.....	C-5102	Fuel Filter.....	FS-5701
Oil Filter Full Flow.....	C-5102	428 SERIES II (BACKHOE LOADERS) CAT 3054 (S/N: 6TC6564-6TC7999)		Oil Filter Full Flow.....	C-5102
428C (BACKHOE LOADERS) S/N: 1SR1-UP		Air Filter Secondary.....	A-5580	430E (BACKHOE LOADERS) CAT C4.4	
Air Filter Primary.....	A-76231	Air Filter Primary.....	A-5577	Cabin Air Filter.....	CA-55110
Air Filter Set.....	A-5541M-S	Air Filter Set.....	A-5578-S	430E (BACKHOE LOADERS) CAT S/N: CRS1-UP	
Air Filter Primary.....	A-5541M	Air Filter Set.....	A-5579-S	Hydraulic Oil Filter.....	HC-5512
Air Filter Primary.....	A-5541	Hydraulic Oil Filter.....	H-5510	Oil Filter Full Flow.....	C-5102
Air Filter Secondary.....	A-5540	Hydraulic Oil Filter.....	H-5506	430E (BACKHOE LOADERS) CAT S/N: DDT1-UP	
Hydraulic Oil Filter.....	HC-5512	428 SERIES II (BACKHOE LOADERS) CAT 3054 (S/N: 6TC8000-UP)		Hydraulic Oil Filter.....	HC-5512
Oil Filter Full Flow.....	C-5102	Air Filter Secondary.....	A-5580	Oil Filter Full Flow.....	C-5102
428C (BACKHOE LOADERS) S/N: 2CR1-UP		Air Filter Set.....	A-5578-S	430E (BACKHOE LOADERS) CAT S/N: EAT1-UP	
Air Filter Primary.....	A-5541M	Air Filter Set.....	A-5579-S	Hydraulic Oil Filter.....	HC-5512
Air Filter Set.....	A-5541M-S	Air Filter Primary.....	A-5577	Oil Filter Full Flow.....	C-5102
Air Filter Secondary.....	A-5540	Fuel Filter.....	FC-5103	430E (BACKHOE LOADERS) CAT S/N: BLD1-UP)	
Air Filter Primary.....	A-5541	Hydraulic Oil Filter.....	H-5506	Air Filter Secondary.....	A-5540
Air Filter Primary.....	A-76231	Hydraulic Oil Filter.....	H-5510	Fuel Filter.....	FS-5701
Hydraulic Oil Filter.....	HC-5512	428F2 (BACKHOE LOADERS) C4.4		Hydraulic Oil Filter.....	HC-5512
Oil Filter Full Flow.....	C-5102	Fuel Filter.....	EF-55040	Oil Filter Full Flow.....	C-5102
428D (BACKHOE LOADERS) CAT 3054 (S/N: BLL1-UP)		428F (BACKHOE LOADERS) C4.4		430E (BACKHOE LOADERS) CAT 3054C	
Hydraulic Oil Filter.....	HC-5512	Cabin Air Filter.....	CA-55110	Cabin Air Filter.....	CA-55110
Oil Filter Full Flow.....	C-5102	430D (BACKHOE LOADERS) CAT 3054 (S/N: BML02281-BML04799)		432D (BACKHOE LOADERS) CAT 3054 (S/N: BLD1-UP)	
428D (BACKHOE LOADERS) CAT 3054 (S/N: BMT1-UP)		Air Filter Secondary.....	A-5540	Air Filter Secondary.....	A-5540
Air Filter Secondary.....	A-5540	430D (BACKHOE LOADERS) CAT 3054 (S/N: BML02281-BML04799)		Fuel Filter.....	FS-5701
Fuel Filter.....	FS-5701	Air Filter Secondary.....	A-5540	Hydraulic Oil Filter.....	HC-5512
				Oil Filter Full Flow.....	C-5102

Sakura Filter

ENGINE APPLICATION

MODEL/APPLICATION	SAKURA NO	MODEL/APPLICATION	SAKURA NO	MODEL/APPLICATION	SAKURA NO
CATERPILLAR		CATERPILLAR		CATERPILLAR	
432D (BACKHOE LOADERS) CAT 3054 (S/N: TDR1-UP)		Hydraulic Oil Filter.....	H-5510	436C (BACKHOE LOADERS) CAT 3054 (S/N: 1PR1-1598-UP)	
Fuel Filter.....	FS-5701	Air Filter Set.....	A-5578-S	Air Filter Secondary.....	A-5540
Hydraulic Oil Filter.....	HC-5512	Air Filter Set.....	A-5579-S	Hydraulic Oil Filter.....	HC-5506
Oil Filter Full Flow.....	C-5102	Air Filter Primary.....	A-5577	Hydraulic Oil Filter.....	HC-5503
432D (BACKHOE LOADERS) CAT 3054 (S/N: WEP1-UP)		Air Filter Secondary.....	A-5580	Oil Filter Full Flow.....	C-5102
Fuel Filter.....	FS-5701	Fuel Filter.....	FS-5701	436C (BACKHOE LOADERS) CAT 3054 (S/N: 1PR1599-UP)	
Hydraulic Oil Filter.....	HC-5512	Hydraulic Oil Filter.....	HC-5506	Air Filter Secondary.....	A-5540
Oil Filter Full Flow.....	C-5102	Hydraulic Oil Filter.....	HC-5503	Hydraulic Oil Filter.....	HC-5512
432E (BACKHOE LOADERS) 2008-UP		Oil Filter Full Flow.....	C-5102	Oil Filter Full Flow.....	C-5102
Hydraulic Oil Filter.....	HC-5512	436B (BACKHOE LOADERS) CAT 3054 (S/N: 7FL1-UP)		436C (BACKHOE LOADERS) CAT 3054 (S/N: 1RR1-997-UP)	
Oil Filter Full Flow.....	C-5102	Air Filter Secondary.....	A-5580	Air Filter Secondary.....	A-5540
432E (BACKHOE LOADERS) 3054C		Air Filter Set.....	A-5578-S	Hydraulic Oil Filter.....	HC-5503
Cabin Air Filter.....	CA-55110	Air Filter Primary.....	A-5577	Hydraulic Oil Filter.....	HC-5506
432E (BACKHOE LOADERS) C4.4		Air Filter Set.....	A-5579-S	Oil Filter Full Flow.....	C-5102
Cabin Air Filter.....	CA-55110	Hydraulic Oil Filter.....	HC-5506	436C (BACKHOE LOADERS) CAT 3054 (S/N: 1RR998-UP)	
432F2 (BACKHOE LOADERS) C4.4		Hydraulic Oil Filter.....	HC-5503	Air Filter Secondary.....	A-5540
Fuel Filter.....	EF-55040	Oil Filter Full Flow.....	C-5102	Hydraulic Oil Filter.....	HC-5503
432F (LOADERS) C4.4 ACERT		436B (BACKHOE LOADERS) S/N: 7FL1-UP		Hydraulic Oil Filter.....	HC-5506
Fuel/Water Separator.....	ES-55010	Air Filter Set.....	A-5578-S	Oil Filter Full Flow.....	C-5102
434E (BACKHOE LOADERS) 3054C		Air Filter Secondary.....	A-5580	436C (BACKHOE LOADERS) CAT 3054 (S/N: 2AR1-1603-UP)	
Cabin Air Filter.....	CA-55110	Air Filter Primary.....	A-5577	Air Filter Secondary.....	A-5540
434E (BACKHOE LOADERS) C4.4		Air Filter Set.....	A-5579-S	Hydraulic Oil Filter.....	HC-5503
Cabin Air Filter.....	CA-55110	Hydraulic Oil Filter.....	HC-5512	Hydraulic Oil Filter.....	HC-5506
434E (BACKHOE LOADERS) CAT S/N: CRS1-UP		Hydraulic Oil Filter.....	HC-5506	Hydraulic Oil Filter.....	HC-5506
Hydraulic Oil Filter.....	HC-5512	Oil Filter Full Flow.....	C-5102	Oil Filter Full Flow.....	C-5102
Oil Filter Full Flow.....	C-5102	436C (BACKHOE LOADERS) CAT 3054 (S/N: 1FR1416-UP)		436C (BACKHOE LOADERS) CAT 3054 (S/N: 2BR1-910-UP)	
434E (BACKHOE LOADERS) CAT S/N: FSH1-UP		Air Filter Secondary.....	A-5540	Air Filter Secondary.....	A-5540
Hydraulic Oil Filter.....	HC-5512	Hydraulic Oil Filter.....	HC-5512	Hydraulic Oil Filter.....	HC-5503
Oil Filter Full Flow.....	C-5102	Hydraulic Oil Filter.....	HC-5503	Hydraulic Oil Filter.....	HC-5506
434E (BACKHOE LOADERS) CAT S/N: G4D1-UP		Oil Filter Full Flow.....	C-5102	Oil Filter Full Flow.....	C-5102
Hydraulic Oil Filter.....	HC-5512	436C (BACKHOE LOADERS) CAT 3054 (S/N: 1GR1-915-UP)		436C (BACKHOE LOADERS) CAT 3054 (S/N: 2BR911-UP)	
Oil Filter Full Flow.....	C-5102	Air Filter Secondary.....	A-5540	Air Filter Secondary.....	A-5540
434F (LOADERS) 3054C		Hydraulic Oil Filter.....	HC-5503	Hydraulic Oil Filter.....	HC-5503
Fuel/Water Separator.....	ES-55010	Hydraulic Oil Filter.....	HC-5506	Hydraulic Oil Filter.....	HC-5506
436 (BACKHOE LOADERS) PERKINS 4.236 (S/N: 5KF1-UP)		Oil Filter Full Flow.....	C-5102	Oil Filter Full Flow.....	C-5102
Air Filter Set.....	A-5579-S	436C (BACKHOE LOADERS) CAT 3054 (S/N: 1GR916-1GR949)		436C (BACKHOE LOADERS) CAT 3054 (S/N: 7WN1-UP)	
Air Filter Set.....	A-5578-S	Air Filter Secondary.....	A-5540	Air Filter Secondary.....	A-5540
Air Filter Secondary.....	A-5580	Hydraulic Oil Filter.....	HC-5512	Hydraulic Oil Filter.....	HC-5506
Air Filter Primary.....	A-5577	Hydraulic Oil Filter.....	HC-5503	Hydraulic Oil Filter.....	HC-5503
Fuel Filter.....	FC-5103	Oil Filter Full Flow.....	C-5102	Hydraulic Oil Filter.....	HC-5506
Hydraulic Oil Filter.....	H-5506	436C (BACKHOE LOADERS) CAT 3054 (S/N: 1GR950-UP)		Oil Filter Full Flow.....	C-5102
		Air Filter Secondary.....	A-5540	436C (BACKHOE LOADERS) CAT 3054 (S/N: 8TN1-924-UP)	
		Hydraulic Oil Filter.....	HC-5506	Air Filter Secondary.....	A-5540
		Hydraulic Oil Filter.....	HC-5503	Hydraulic Oil Filter.....	HC-5506
		Oil Filter Full Flow.....	C-5102	Hydraulic Oil Filter.....	HC-5503

MODEL/APPLICATION	SAKURA NO	MODEL/APPLICATION	SAKURA NO	MODEL/APPLICATION	SAKURA NO
CATERPILLAR		CATERPILLAR		CATERPILLAR	
436C (BACKHOE LOADERS) CAT 3054 (S/N: 8TN1-924-UP)		438B (BACKHOE LOADERS) CAT 3054 (S/N: 3KK1-2999-UP)		Oil Filter Full Flow.....	C-5102
Oil Filter Full Flow.....	C-5102	Air Filter Set.....	A-5578-S	438C (BACKHOE LOADERS) CAT 3054 (S/N: 2DR3250-UP)	
436C (BACKHOE LOADERS) CAT 3054 (S/N: 8TN925-UP)		Air Filter Set.....	A-5579-S	Air Filter Secondary.....	A-5540
Air Filter Secondary.....	A-5540	Air Filter Primary.....	A-5577	Hydraulic Oil Filter.....	HC-5506
Hydraulic Oil Filter.....	HC-5512	Air Filter Secondary.....	A-5580	Hydraulic Oil Filter.....	HC-5503
Oil Filter Full Flow.....	C-5102	Fuel Filter.....	FS-5701	Oil Filter Full Flow.....	C-5102
436C (BACKHOE LOADERS) CAT 3054 (S/N: 9JN1-883-UP)		Hydraulic Oil Filter.....	HC-5503	438C (BACKHOE LOADERS) CAT 3054 (S/N: 9KN1061-9KN1199)	
Air Filter Secondary.....	A-5540	Hydraulic Oil Filter.....	HC-5506	Air Filter Secondary.....	A-5540
Hydraulic Oil Filter.....	HC-5503	Oil Filter Full Flow.....	C-5102	Hydraulic Oil Filter.....	HC-5512
Hydraulic Oil Filter.....	HC-5506	438C (BACKHOE LOADERS) CAT 3054 (S/N: 3KK3000-UP)		Oil Filter Full Flow.....	C-5102
Oil Filter Full Flow.....	C-5102	Air Filter Set.....	A-5579-S	438C (BACKHOE LOADERS) CAT 3054 (S/N: 9KN1-1060-UP)	
436C (BACKHOE LOADERS) CAT 3054 (S/N: 9JN884-UP)		Air Filter Primary.....	A-5577	Air Filter Secondary.....	A-5540
Air Filter Secondary.....	A-5540	Air Filter Secondary.....	A-5580	Hydraulic Oil Filter.....	HC-5503
Hydraulic Oil Filter.....	HC-5503	Air Filter Set.....	A-5578-S	Hydraulic Oil Filter.....	HC-5506
Hydraulic Oil Filter.....	HC-5506	Fuel Filter.....	FS-5701	Oil Filter Full Flow.....	C-5102
Oil Filter Full Flow.....	C-5102	Hydraulic Oil Filter.....	HC-5503	438C (BACKHOE LOADERS) CAT 3054 (S/N: 1JR1107-UP)	
436C (BACKHOE LOADERS) CAT 7BJ1-UP		Hydraulic Oil Filter.....	HC-5506	Air Filter Secondary.....	A-5540
Air Filter Secondary.....	A-56741	Hydraulic Oil Filter.....	HC-5506	Hydraulic Oil Filter.....	HC-5512
Air Filter Set.....	A-56731-S	Oil Filter Full Flow.....	C-5102	Oil Filter Full Flow.....	C-5102
Air Filter Primary.....	A-56731	438C (BACKHOE LOADERS) CAT 3054 (S/N: 1JR1-1106-UP)		438C (BACKHOE LOADERS) CAT 7BJ1-UP	
436 II (BACKHOE LOADERS) S/N: 5KF1-805-UP		Air Filter Secondary.....	A-5540	Air Filter Primary.....	A-56731
Air Filter Primary.....	A-5577	Hydraulic Oil Filter.....	HC-5503	Air Filter Secondary.....	A-56741
Air Filter Set.....	A-5579-S	Hydraulic Oil Filter.....	HC-5506	Air Filter Set.....	A-56731-S
Air Filter Secondary.....	A-5580	Oil Filter Full Flow.....	C-5102	438D (BACKHOE LOADERS) CAT 3054 (S/N: BPE1-UP)	
Air Filter Set.....	A-5578-S	438C (BACKHOE LOADERS) CAT 3054 (S/N: 1TR1-1283-UP)		Air Filter Secondary.....	A-5540
Hydraulic Oil Filter Transmission...	HC-5501	Air Filter Secondary.....	A-5540	Fuel Filter.....	FS-5701
436 II (BACKHOE LOADERS) S/N: 5KF806-UP		Hydraulic Oil Filter.....	HC-5506	Hydraulic Oil Filter.....	HC-5512
Air Filter Secondary.....	A-5580	Hydraulic Oil Filter.....	HC-5503	Oil Filter Full Flow.....	C-5102
Air Filter Set.....	A-5578-S	Oil Filter Full Flow.....	C-5102	438D (BACKHOE LOADERS) CAT 3054 (S/N: BPN1-UP)	
Air Filter Primary.....	A-5577	438C (BACKHOE LOADERS) CAT 3054 (S/N: 1TR1284-1TR1549)		Air Filter Secondary.....	A-5540
Air Filter Set.....	A-5579-S	Air Filter Secondary.....	A-5540	Hydraulic Oil Filter.....	HC-5512
Hydraulic Oil Filter Transmission...	HC-5501	Hydraulic Oil Filter.....	HC-5512	Oil Filter Full Flow.....	C-5102
Hydraulic Oil Filter.....	H-5506	Oil Filter Full Flow.....	C-5102	438 SERIES II (BACKHOE LOADERS) CAT 3054 (S/N: 3DJ828-UP)	
438 (BACKHOE LOADERS) PERKINS 4.236 (S/N: 3DJ1-827-UP)		438C (BACKHOE LOADERS) CAT 3054 (S/N: 1TR1550-UP)		Air Filter Set.....	A-5579-S
Air Filter Set.....	A-5578-S	Air Filter Secondary.....	A-5540	Air Filter Primary.....	A-5577
Air Filter Secondary.....	A-5580	Hydraulic Oil Filter.....	HC-5503	Air Filter Set.....	A-5578-S
Air Filter Primary.....	A-5577	Hydraulic Oil Filter.....	HC-5506	Air Filter Secondary.....	A-5580
Air Filter Set.....	A-5579-S	Oil Filter Full Flow.....	C-5102	Fuel Filter.....	FC-5103
Fuel Filter.....	FC-5103	438C (BACKHOE LOADERS) CAT 3054 (S/N: 2DR1-2716-UP)		Hydraulic Oil Filter.....	H-5506
Hydraulic Oil Filter.....	H-5506	Air Filter Secondary.....	A-5540	Hydraulic Oil Filter.....	H-5510
Hydraulic Oil Filter.....	H-5510	Hydraulic Oil Filter.....	HC-5506	442D (BACKHOE LOADERS) CAT 3054 (S/N: BRG1-UP)	
438 (BACKHOE LOADERS) PERKINS 4.236 (S/N: 3DJ828-UP)		Hydraulic Oil Filter.....	HC-5512	Air Filter Secondary.....	A-5540
Air Filter Set.....	A-5579-S	Hydraulic Oil Filter.....	HC-5503	Fuel Filter.....	FS-5701
Air Filter Set.....	A-5578-S	Hydraulic Oil Filter.....	HC-5506	Hydraulic Oil Filter.....	HC-5512
Air Filter Primary.....	A-5577	Oil Filter Full Flow.....	C-5102	Oil Filter Full Flow.....	C-5102
Fuel Filter.....	FC-5103	438C (BACKHOE LOADERS) CAT 3054 (S/N: 2DR2717-2DR3249)		442D (BACKHOE LOADERS) CAT 3054 (S/N: BRY1-UP)	
Hydraulic Oil Filter.....	H-5510	Air Filter Secondary.....	A-5540	Air Filter Secondary.....	A-5540
Hydraulic Oil Filter.....	H-5506	Hydraulic Oil Filter.....	HC-5512		

Sakura Filter

ENGINE APPLICATION

MODEL/APPLICATION	SAKURA NO	MODEL/APPLICATION	SAKURA NO	MODEL/APPLICATION	SAKURA NO
CATERPILLAR		CATERPILLAR		CATERPILLAR	
442D (BACKHOE LOADERS) CAT 3054 (S/N: BRY1-UP)		Fuel Filter.....	FC-5508	Air Filter Set.....	A-5549M-S
Hydraulic Oil Filter.....	HC-5512	Fuel Filter.....	FS-5701	Air Filter Primary.....	A-5549
Oil Filter Full Flow.....	C-5102	Fuel Filter Secondary.....	FC-5507	Air Filter Primary.....	A-5549M
		Fuel Filter.....	F-5505	Air Filter Secondary.....	A-5550
442D (BACKHOE LOADERS) CAT 3054 (S/N: SMJ1-UP)		Hydraulic Oil Filter.....	HC-5504	Hydraulic Oil Filter.....	HC-5506
Fuel Filter.....	FS-5701	Hydraulic Oil Filter.....	HC-5506	Hydraulic Oil Filter.....	HC-5512
Hydraulic Oil Filter.....	HC-5512	Hydraulic Oil Filter.....	HC-5503	Hydraulic Oil Filter.....	HC-5503
Oil Filter Full Flow.....	C-5102	Hydraulic Oil Filter.....	HC-5512	Hydraulic Oil Filter.....	HC-5504
		Oil Filter Full Flow.....	C-5505		
442D (BACKHOE LOADERS) CAT 3054 (S/N: TBD1-UP)		446B (BACKHOE LOADERS) CAT 3114T		45 (TRACTORS) S/N: 1DR1-1105-UP	
Fuel Filter.....	FS-5701	Air Filter Primary.....	A-4210	Air Filter Primary.....	A-5549
Hydraulic Oil Filter.....	HC-5512	Air Filter Secondary.....	A-4211	Air Filter Primary.....	A-5549M
Oil Filter Full Flow.....	C-5102	Air Filter Set.....	A-4212-S	Air Filter Secondary.....	A-5550
				Air Filter Set.....	A-5549M-S
442E (BACKHOE LOADERS) CAT S/N: CRS1-UP , 2006-UP		446B (BACKHOE LOADERS) S/N: 5BL2500-UP		Hydraulic Oil Filter.....	HC-5506
Hydraulic Oil Filter.....	HC-5512	Air Filter Primary.....	A-76600	Hydraulic Oil Filter.....	HC-5503
Oil Filter Full Flow.....	C-5102	Fuel Filter Secondary.....	FC-5507	Hydraulic Oil Filter.....	HC-5512
		Fuel Filter.....	FS-5701	Hydraulic Oil Filter.....	HC-5504
442E (BACKHOE LOADERS) CAT S/N: GKZ1-UP , 2006-UP		Fuel Filter.....	FC-5508		
Hydraulic Oil Filter.....	HC-5512	Hydraulic Oil Filter.....	HC-5512	45 (TRACTORS) S/N: 3BK1-UP	
Oil Filter Full Flow.....	C-5102	Oil Filter Full Flow.....	C-5505	Air Filter Secondary.....	A-5550
				Air Filter Primary.....	A-5549
442E (BACKHOE LOADERS) CAT S/N: LBE1-UP , 2006-UP		446D (BACKHOE LOADERS) CAT 3114		Air Filter Set.....	A-5549M-S
Hydraulic Oil Filter.....	HC-5512	Air Filter Primary.....	A-5511	Air Filter Primary.....	A-5549M
Oil Filter Full Flow.....	C-5102	Air Filter Set.....	A-5511-S	Air Filter Set.....	A-5549M-S
		Fuel Filter.....	F-5505	Hydraulic Oil Filter.....	HC-5504
442E (BACKHOE LOADERS) C4.4		Fuel Filter.....	FC-5508	Hydraulic Oil Filter.....	HC-5503
Cabin Air Filter.....	CA-55110	Fuel Filter.....	FS-5701	Hydraulic Oil Filter.....	HC-5512
				Hydraulic Oil Filter.....	HC-5506
442E (BACKHOE LOADERS) CAT 3054C		446D (BACKHOE LOADERS) CAT 3114T			
Cabin Air Filter.....	CA-55110	Air Filter Primary.....	A-4210	45 (TRACTORS) S/N: 4DZ1-2123-UP	
		Air Filter Set.....	A-4212-S	Air Filter Secondary.....	A-5550
444E (BACKHOE LOADERS) C4.4		Air Filter Secondary.....	A-4211	Air Filter Primary.....	A-5549
Cabin Air Filter.....	CA-55110			Air Filter Primary.....	A-5549M
		45 (TRACTORS) CAT (S/N: 98Z1-4349-UP)		Air Filter Set.....	A-5549M-S
444E (BACKHOE LOADERS) CAT 3054C		Fuel Filter Secondary.....	FC-55151	Hydraulic Oil Filter.....	HC-5504
Cabin Air Filter.....	CA-55110	Fuel Filter Secondary.....	FC-5515		
		Fuel Filter.....	FC-5516	45 (TRACTORS) S/N: 4KW1-UP	
444F (LOADERS) 3054C		45 (TRACTORS) CAT (S/N: 98Z14966-19755-UP)		Air Filter Set.....	A-5549M-S
Fuel/Water Separator.....	ES-55010	Fuel Filter Secondary.....	FC-55151	Air Filter Secondary.....	A-5550
		Fuel Filter Secondary.....	FC-5515	Air Filter Primary.....	A-5549
446 (BACKHOE LOADERS) CAT 3114 (S/N: 6XF1-UP)		Fuel Filter.....	FC-5508	Air Filter Primary.....	A-5549M
Air Filter Primary.....	A-5511	Fuel Filter.....	FC-5516	Hydraulic Oil Filter.....	HC-5504
Air Filter Set.....	A-5511-S				
Fuel Filter Secondary.....	FC-5507	45 (TRACTORS) CAT S/N: 98Z19756-UP		45 (TRACTORS) S/N: 4YL1-UP	
Fuel Filter.....	F-5505	Fuel Filter Secondary.....	FC-5515	Air Filter Set.....	A-5549M-S
Hydraulic Oil Filter.....	H-5506	Fuel Filter.....	FC-5516	Air Filter Secondary.....	A-5550
Hydraulic Oil Filter.....	H-5510	Fuel Filter.....	FC-5516	Air Filter Primary.....	A-5549M
Hydraulic Oil Filter.....	HC-5504	Fuel Filter Secondary.....	FC-55151	Hydraulic Oil Filter.....	HC-5504
Oil Filter Full Flow.....	C-5505				
		45 (TRACTORS) CAT S/N: 98Z4350-14965-UP		45 (TRACTORS) S/N: ABF1-UP	
446B (BACKHOE LOADERS) CAT 3114 (S/N: 5BL1-2499-UP)		Fuel Filter Secondary.....	FC-55151	Air Filter Primary.....	A-5549M
Air Filter Primary.....	A-76600	Fuel Filter Secondary.....	FC-5515	Air Filter Set.....	A-5549M-S
Air Filter Set.....	A-5511-S	Fuel Filter.....	FC-5516	Air Filter Primary.....	A-5549
Air Filter Primary.....	A-5511			Air Filter Secondary.....	A-5550
		45 (TRACTORS) S/N: 1DR1106-UP		Hydraulic Oil Filter.....	HC-5504
				450E (BACKHOE LOADERS) C4.4	

MODEL/APPLICATION	SAKURA NO	MODEL/APPLICATION	SAKURA NO	MODEL/APPLICATION	SAKURA NO
CATERPILLAR		CATERPILLAR		CATERPILLAR	
450E (BACKHOE LOADERS) C4.4 Cabin Air Filter.....	CA-55110	5080 (EXCAVATORS) CAT 3406B (S/N: 6XK1-UP) Air Filter Secondary.....	A-5715	Fuel/Water Separator Secondary..	SFC-5504-10B
450F (BACKHOE LOADERS) C4.4 Cabin Air Filter.....	CA-55110	Air Filter Set.....	A-5629-S	Fuel/Water Separator Secondary...	SFC-5504-10
450F (LOADERS) C4.4 ACERT Fuel/Water Separator.....	ES-55010	Air Filter Secondary.....	A-5630	Hydraulic Oil Filter.....	HC-5516
465 (COMBINES HARVESTERS) CAT 3126 Fuel Filter Secondary.....	FC-55151	Air Filter Primary.....	A-5629	Hydraulic Oil Filter.....	HC-5511
Fuel Filter.....	FC-5516	Fuel Filter.....	F-5505	5110 (EXCAVATORS) CAT 3412E (S/N: 7GN1-UP) , 2007-UP Air Filter Secondary.....	A-5560
Fuel Filter Secondary.....	FC-5515	Hydraulic Oil Filter.....	FC-5509	Air Filter Set.....	A-5555-S
Oil Filter Full Flow.....	C-5510	Hydraulic Oil Filter.....	H-5505	Air Filter Primary.....	A-5555
5000-Serie (EXCAVATORS) CAT 3508B Hydraulic Oil Filter.....	H-51250-05	Hydraulic Oil Filter.....	HC-5511	Fuel Filter.....	FC-5509
508 (SKIDDERS) S/N: 2HD1-UP Air Filter Set.....	A-5568-S	5080 (EXCAVATORS) CAT 3406B (S/N: 8SL1-UP) Air Filter Secondary.....	A-5630	Hydraulic Oil Filter.....	HC-5516
Air Filter Primary.....	A-5507	Air Filter Set.....	A-5629-S	5110 (EXCAVATORS) CAT 3412E (S/N: 8HN1-UP) , 2007-UP Air Filter Secondary.....	A-5560
Air Filter.....	A-5530	Air Filter Primary.....	A-5629	Air Filter Set.....	A-5555-S
Air Filter Primary.....	A-5566	Fuel Filter.....	F-5505	Air Filter Primary.....	A-5555
Air Filter Secondary.....	A-5567	Fuel Filter.....	FC-5509	Fuel Filter.....	FC-5509
Air Filter Set.....	A-55071-S	Hydraulic Oil Filter.....	HC-5516	Hydraulic Oil Filter.....	HC-5516
Air Filter Set.....	A-5507-S	Hydraulic Oil Filter.....	H-5505	5110 (EXCAVATORS) CAT 3412 Fuel/Water Separator Primary.....	SFC-5504-30
Fuel Filter.....	F-5505	Hydraulic Oil Filter.....	HC-5511	Fuel/Water Separator Primary...	SFC-5504-30B
Fuel Filter Secondary.....	FC-5507	5090B (EXCAVATORS) CAT 3456 (S/N: CLD1-UP) Air Filter Primary.....	A-5593	511 (FELLER BUNCHERS) CAT S/N: 5111-UP Air Filter Secondary.....	A-8651
Hydraulic Oil Filter.....	H-5506	Air Filter Set.....	A-5595-S	Air Filter.....	A-5584
Oil Filter Full Flow.....	C-5505	Air Filter Secondary.....	A-5594	Fuel Filter.....	FC-5517
508 (SKIDDERS) S/N: 9DA1-UP Fuel Filter Secondary.....	FC-5507	Fuel Filter.....	FC-5517	Hydraulic Oil Filter.....	HC-55170
Oil Filter Full Flow.....	C-5505	Fuel/Water Separator Secondary..	SFC-5504-10B	Hydraulic Oil Filter.....	H-5509
508 (SKIDDERS) S/N: 9NC1-UP Air Filter.....	A-5530	Fuel/Water Separator Secondary..	SFC-5504-10	Hydraulic Oil Filter.....	HC-5801
Air Filter Primary.....	A-5566	Hydraulic Oil Filter.....	HC-5516	511 (FELLER BUNCHERS) CAT S/N: 5211-UP Air Filter.....	A-5584
Air Filter Set.....	A-5568-S	Hydraulic Oil Filter.....	H-7942	Air Filter Secondary.....	A-8651
Air Filter Primary.....	A-5507	Hydraulic Oil Filter.....	HC-5511	Fuel Filter.....	FC-5517
Air Filter Secondary.....	A-5567	5090B (EXCAVATORS) CAT 3456 (S/N: SJY1-UP) Air Filter Primary.....	A-5593	Hydraulic Oil Filter.....	H-5509
Air Filter Set.....	A-55071-S	Air Filter Set.....	A-5595-S	Hydraulic Oil Filter.....	HC-55170
Air Filter Set.....	A-5507-S	Air Filter Secondary.....	A-5594	Hydraulic Oil Filter.....	HC-5801
Fuel Filter.....	F-5505	Fuel Filter.....	FC-5517	511 (FELLER BUNCHERS) CAT S/N: THX1-UP Air Filter.....	A-5584
Fuel Filter Secondary.....	FC-5507	Fuel/Water Separator Secondary...	SFC-5504-10	Air Filter Secondary.....	A-8651
Hydraulic Oil Filter.....	H-5506	Fuel/Water Separator Secondary..	SFC-5504-10B	Fuel Filter.....	FC-5517
Oil Filter Full Flow.....	C-5505	Hydraulic Oil Filter.....	H-7942	Hydraulic Oil Filter.....	HC-5801
5080 (EXCAVATORS) CAT 3406B (Excluding S/N: 11N6900) Air Filter Secondary.....	A-5715	Hydraulic Oil Filter.....	HC-5516	Hydraulic Oil Filter.....	HC-5801
Coolant Filter.....	WC-5707	Hydraulic Oil Filter.....	HC-5511	Hydraulic Oil Filter.....	H-5509
Coolant Filter.....	WC-5705	5090B FS (EXCAVATORS) CAT 3456 (S/N: CLD1-UP) Air Filter Secondary.....	A-5594	Hydraulic Oil Filter.....	HC-55170
Fuel Filter.....	F-5505	Air Filter Set.....	A-5595-S	5110B (EXCAVATORS) CAT 3412E Fuel/Water Separator Primary.....	SFC-5504-30
Fuel Filter.....	FC-5509	Air Filter Secondary.....	A-5594	Fuel/Water Separator Primary...	SFC-5504-30B
Hydraulic Oil Filter.....	H-5505	Fuel Filter.....	FC-5517		

MODEL/APPLICATION	SAKURA NO
CATERPILLAR	
5110B (EXCAVATORS) CAT 3412E (S/N: AAA1-UP)	
Air Filter Secondary.....	A-5556
Air Filter Primary.....	A-5555
Air Filter Set.....	A-5555-S
Cabin Air Filter.....	CA-55850
Fuel Filter.....	FC-5509
Fuel/Water Separator Secondary..	SFC-5504-10
Fuel/Water Separator Secondary..	SFC-5504-10B
Hydraulic Oil Filter.....	H-5001
Hydraulic Oil Filter.....	H-5506
Hydraulic Oil Filter.....	HC-5516
Oil Filter Full Flow.....	C-5516
5110B (EXCAVATORS) CAT 3412E (S/N: AAK1-226-UP)	
Air Filter Set.....	A-5555-S
Air Filter Primary.....	A-5555
Air Filter Secondary.....	A-5556
Cabin Air Filter.....	CA-55850
Fuel Filter.....	FC-5509
Fuel/Water Separator Secondary..	SFC-5504-10B
Fuel/Water Separator Secondary..	SFC-5504-10
Hydraulic Oil Filter.....	H-5001
Hydraulic Oil Filter.....	H-5506
5110B (EXCAVATORS) CAT 3412E (S/N: AAK1-UP)	
Air Filter Primary.....	A-5555
Air Filter Set.....	A-5555-S
Air Filter Secondary.....	A-5556
Cabin Air Filter.....	CA-55850
Fuel Filter.....	FC-5509
Fuel/Water Separator Secondary..	SFC-5504-10B
Fuel/Water Separator Secondary..	SFC-5504-10
Hydraulic Oil Filter.....	H-5001
Hydraulic Oil Filter.....	H-5506
5110B (EXCAVATORS) CAT 3412E (S/N: AAK227-UP)	
Air Filter Set.....	A-5555-S
Air Filter Secondary.....	A-5556
Air Filter Primary.....	A-5555
Cabin Air Filter.....	CA-55850
Fuel Filter.....	FC-5509
Fuel/Water Separator Secondary..	SFC-5504-10B
Fuel/Water Separator Secondary..	SFC-5504-10
Hydraulic Oil Filter.....	H-5506
Hydraulic Oil Filter.....	H-5001
5130 (EXCAVATORS) CAT 3508 (S/N: 5ZL1-UP)	
Air Filter Primary.....	A-5564
Air Filter.....	A-5547
Air Filter Secondary.....	A-5563
Air Filter Set.....	A-5532-S
Air Filter Secondary.....	A-55291
Air Filter Set.....	A-5565-S
Air Filter Primary.....	A-5532
Fuel Filter.....	FC-5510
Hydraulic Oil Filter.....	HC-5516
Hydraulic Oil Filter.....	H-5506

MODEL/APPLICATION	SAKURA NO
CATERPILLAR	
5130 (EXCAVATORS) CAT 3508 (S/N: 7TJ1-UP)	
Air Filter.....	A-5547
Air Filter Set.....	A-5565-S
Air Filter Secondary.....	A-5563
Air Filter Primary.....	A-5564
Fuel Filter.....	FC-5510
Hydraulic Oil Filter.....	HC-5516
Hydraulic Oil Filter.....	H-5506
5130B (EXCAVATORS) CAT 3508B (S/N: 4CS1-UP)	
Air Filter.....	A-5547
Air Filter Set.....	A-5565-S
Air Filter Secondary.....	A-5563
Air Filter Primary.....	A-5564
Fuel Filter.....	FC-5510
Hydraulic Oil Filter.....	H-5506
Hydraulic Oil Filter.....	HC-5516
515 (SKIDDERS) CAT (S/N: 07Z32027-UP)	
Fuel Filter Secondary.....	FC-5507
Oil Filter Full Flow.....	C-5510
Oil Filter Full Flow.....	C-5522
515 (SKIDDERS) CAT 3304 (S/N: 4LR1-UP)	
Air Filter Primary.....	A-5566
Air Filter Secondary.....	A-5567
Air Filter Set.....	A-5568-S
Fuel Filter Secondary.....	FC-5507
Fuel Filter.....	F-5505
Hydraulic Oil Filter.....	H-5506
Hydraulic Oil Filter.....	HC-5504
Hydraulic Oil Filter.....	H-5510
Oil Filter Full Flow.....	C-5510
515 (SKIDDERS) S/N: 28H1-UP	
Fuel Filter Secondary.....	FC-5507
Hydraulic Oil Filter.....	H-5502
515 (SKIDDERS) S/N: 4LR718-UP	
Air Filter Set.....	A-5568-S
Air Filter Primary.....	A-5566
Air Filter Secondary.....	A-5567
Hydraulic Oil Filter.....	H-5506
Hydraulic Oil Filter.....	HC-5504
517 (SKIDDERS) CAT 3304 DIT	
Air Filter Secondary.....	A-5567
Air Filter Primary.....	A-5566
Air Filter Set.....	A-5568-S
Fuel Filter Secondary.....	FC-5507
Hydraulic Oil Filter.....	H-5504
Oil Filter Full Flow.....	C-5510
517 (SKIDDERS) CAT 3304 (S/N: 5MW1-UP)	
Air Filter Set.....	A-5568-S
Air Filter Primary.....	A-5566

MODEL/APPLICATION	SAKURA NO
CATERPILLAR	
Air Filter Secondary.....	A-5567
Fuel Filter Secondary.....	FC-5507
Hydraulic Oil Filter.....	H-5504
Oil Filter Full Flow.....	C-5510
517 (SKIDDERS) CAT 3304 (S/N: 6PW1-UP)	
Air Filter Primary.....	A-5566
Air Filter Set.....	A-5568-S
Air Filter Secondary.....	A-5567
Fuel Filter Secondary.....	FC-5507
Hydraulic Oil Filter.....	H-5504
Oil Filter Full Flow.....	C-5510
518C (SKIDDERS) CAT 3304	
Air Filter Secondary.....	A-5508
Air Filter Set.....	A-5507-S
Air Filter Set.....	A-55071-S
Air Filter Primary.....	A-5507
Fuel Filter.....	F-5505
Hydraulic Oil Filter.....	H-5504
Oil Filter Full Flow.....	C-5510
518C (SKIDDERS) CAT (S/N: 07Z28000-28000-UP)	
Fuel Filter Secondary.....	FC-5507
518C (SKIDDERS) CAT (S/N: 07Z28001-UP)	
Fuel Filter Secondary.....	FC-5507
Oil Filter Full Flow.....	C-5522
518C (SKIDDERS) S/N: 1CL1-UP	
Air Filter Set.....	A-5507-S
Air Filter Primary.....	A-5507
Air Filter Set.....	A-55071-S
Air Filter Secondary.....	A-5508
Hydraulic Oil Filter.....	H-5502
518C (SKIDDERS) S/N: 2DX1-UP	
Hydraulic Oil Filter.....	H-55270
518C (SKIDDERS) S/N: 4MX1-UP	
Hydraulic Oil Filter.....	H-55270
518C (SKIDDERS) S/N: 81-UP	
Hydraulic Oil Filter.....	H-55270
518C (SKIDDERS) S/N: 9HJ1-UP	
Air Filter Primary.....	A-5507
Air Filter Secondary.....	A-5508
Air Filter Set.....	A-55071-S
Air Filter Set.....	A-5507-S
Hydraulic Oil Filter.....	H-5502
518 (SKIDDERS) CAT 3304 (S/N: 50S1-UP) , 2005-UP	
Air Filter Set.....	A-5507-S
Air Filter Set.....	A-55071-S
Air Filter Primary.....	A-5507
Air Filter Secondary.....	A-5508

MODEL/APPLICATION	SAKURA NO	MODEL/APPLICATION	SAKURA NO	MODEL/APPLICATION	SAKURA NO
CATERPILLAR		CATERPILLAR		CATERPILLAR	
518 (SKIDDERS) CAT 3304 (S/N: 50S1-UP) , 2005-UP Fuel Filter..... F-5505 Fuel Filter Secondary..... FC-5507 Hydraulic Oil Filter..... H-5504 Hydraulic Oil Filter..... H-5502 Oil Filter Full Flow..... C-5510		518 (SKIDDERS) S/N: 1ZC1-UP Hydraulic Oil Filter..... H-5504 Hydraulic Oil Filter..... H-55270		Air Filter Secondary..... A-5508 Air Filter Set..... A-55071-S	
518 (SKIDDERS) CAT 3304 (S/N: 55U1-UP) , 2005-UP Air Filter Secondary..... A-5508 Air Filter Set..... A-55071-S Air Filter Primary..... A-5507 Air Filter Set..... A-5507-S Fuel Filter..... F-5505 Fuel Filter Secondary..... FC-5507 Hydraulic Oil Filter..... H-5504 Hydraulic Oil Filter..... H-5502 Oil Filter Full Flow..... C-5510		518 (SKIDDERS) S/N: 3GA1-UP Hydraulic Oil Filter..... H-5504 Hydraulic Oil Filter..... H-55270		518 (SKIDDERS) S/N: 94U1-UP Air Filter Primary..... A-5507 Air Filter Set..... A-55071-S Air Filter Set..... A-5507-S Fuel Filter Secondary..... FC-5507 Hydraulic Oil Filter..... H-5502 Hydraulic Oil Filter..... H-5504 Oil Filter Full Flow..... C-5510	
518 (SKIDDERS) CAT 3304 (S/N: 94U1-UP) , 2005-UP Air Filter Secondary..... A-5508 Air Filter Set..... A-55071-S Air Filter Primary..... A-5507 Air Filter Set..... A-5507-S Fuel Filter..... F-5505 Fuel Filter Secondary..... FC-5507 Hydraulic Oil Filter..... H-5504 Hydraulic Oil Filter..... H-5502 Oil Filter Full Flow..... C-5510		518 (SKIDDERS) S/N: 4SA1-UP Hydraulic Oil Filter..... H-55270		518 (SKIDDERS) S/N: 94U2207-UP Air Filter Secondary..... A-5508 Air Filter Set..... A-55071-S Air Filter Primary..... A-5507 Air Filter Set..... A-5507-S	
518 (SKIDDERS) CAT 3304 (S/N: 94U1-UP) , 2005-UP Air Filter Secondary..... A-5508 Air Filter Set..... A-55071-S Air Filter Primary..... A-5507 Air Filter Set..... A-5507-S Fuel Filter..... F-5505 Fuel Filter Secondary..... FC-5507 Hydraulic Oil Filter..... H-5502 Hydraulic Oil Filter..... H-5504 Oil Filter Full Flow..... C-5510		518 (SKIDDERS) S/N: 50S1-205 Air Filter Secondary..... A-5567 Air Filter Secondary..... A-5508 Air Filter Primary..... A-5507 Air Filter Set..... A-5507-S Air Filter Set..... A-5568-S Air Filter Primary..... A-5566 Air Filter Set..... A-55071-S Fuel Filter Secondary..... FC-5507 Hydraulic Oil Filter..... H-5504 Hydraulic Oil Filter..... H-5502 Oil Filter Full Flow..... C-5510 Oil Filter Full Flow..... 0-5501		518 (SKIDDERS) S/N: 94U691-2206-UP Air Filter Secondary..... A-5508 Air Filter Primary..... A-5507 Air Filter Set..... A-55071-S Air Filter Set..... A-5507-S	
518 (SKIDDERS) CAT (S/N: 07Z1523-4628-UP) Oil Filter Full Flow..... C-5522 Oil Filter Full Flow..... C-5510		518 (SKIDDERS) S/N: 50S206-UP Air Filter Primary..... A-5566 Air Filter Set..... A-5507-S Air Filter Set..... A-5568-S Air Filter Secondary..... A-5508 Air Filter Primary..... A-5507 Air Filter Set..... A-55071-S Air Filter Secondary..... A-5567 Fuel Filter Secondary..... FC-5507 Hydraulic Oil Filter..... H-5504 Hydraulic Oil Filter..... H-5502 Oil Filter Full Flow..... C-5510		518 (SKIDDERS) S/N: 95U101-2500-UP Air Filter Set..... A-5507-S Air Filter Set..... A-55071-S Air Filter Secondary..... A-5508 Air Filter Primary..... A-5507	
518 (SKIDDERS) CAT (S/N: 07Z4629-5693-UP) Oil Filter Full Flow..... C-5522 Oil Filter Full Flow..... C-5510		518 (SKIDDERS) S/N: 07Z5694-8941-UP) Fuel Filter..... FC-5523 Fuel Filter..... FC-5501 Oil Filter Full Flow..... C-5510 Oil Filter Full Flow..... C-5522		518 (SKIDDERS) S/N: 95U2501-UP Air Filter Set..... A-55071-S Air Filter Secondary..... A-5508 Air Filter Primary..... A-5507 Air Filter Set..... A-5507-S	
518 (SKIDDERS) CAT (S/N: 07Z8942-UP) Fuel Filter..... FC-5523 Fuel Filter..... FC-5501 Oil Filter Full Flow..... C-5522 Oil Filter Full Flow..... C-5510		518 (SKIDDERS) S/N: 50S3230-UP Air Filter Secondary..... A-5508 Air Filter Set..... A-55071-S Air Filter Set..... A-5507-S Air Filter Primary..... A-5507		518 II (SKIDDERS) CAT (S/N: 07Z4629-5693-UP) Oil Filter Full Flow..... C-5510	
518 (SKIDDERS) CAT (S/N: 07Z8942-UP) Fuel Filter..... FC-5523 Fuel Filter..... FC-5501 Oil Filter Full Flow..... C-5522 Oil Filter Full Flow..... C-5510		518 (SKIDDERS) S/N: 55U-55U Air Filter Set..... A-5507-S Air Filter Set..... A-55071-S Air Filter Secondary..... A-5508 Air Filter Primary..... A-5507 Hydraulic Oil Filter..... H-5502 Hydraulic Oil Filter..... H-5504 Oil Filter Full Flow..... C-5510		518 II (SKIDDERS) CAT (S/N: 07Z8942-UP) Oil Filter Full Flow..... C-5510	
518 (SKIDDERS) S/N: 1HE1-UP Hydraulic Oil Filter..... H-55270 Hydraulic Oil Filter..... H-5504		518 (SKIDDERS) S/N: 55U669-UP Air Filter Set..... A-5507-S Air Filter Primary..... A-5507		518 II (SKIDDERS) S/N: 7RE1-UP Hydraulic Oil Filter..... H-5504 Hydraulic Oil Filter..... H-55270	
				518 II (SKIDDERS) Hydraulic Oil Filter..... H-55270	

Sakura Filter

ENGINE APPLICATION

MODEL/APPLICATION	SAKURA NO
CATERPILLAR	
518 II (SKIDDERS) S/N: 7RE1-UP Hydraulic Oil Filter.....	H-5504
518 II (SKIDDERS) S/N: 94U2207-UP Air Filter Set..... Air Filter Secondary..... Air Filter Primary..... Air Filter Set.....	A-5507-S A-5508 A-5507 A-55071-S
518 II (SKIDDERS) S/N: 94U691-2206-UP Air Filter Set..... Air Filter Set..... Air Filter Secondary..... Air Filter Primary.....	A-5507-S A-55071-S A-5508 A-5507
518 II (SKIDDERS) S/N: 95U101-2500-UP Air Filter Primary..... Air Filter Set..... Air Filter Set..... Air Filter Secondary.....	A-5507 A-55071-S A-5507-S A-5508
518 II (SKIDDERS) S/N: 95U2501-UP Air Filter Set..... Air Filter Primary..... Air Filter Secondary..... Air Filter Set.....	A-5507-S A-5507 A-5508 A-55071-S
518 II (SKIDDERS) S/N: 9NE1-UP Hydraulic Oil Filter..... Hydraulic Oil Filter.....	H-55270 H-5504
522C (FELLER BUNCHERS) CAT S/N: 07Z28250-UP Air Filter Primary..... Air Filter Secondary..... Air Filter Set..... Fuel Filter Secondary..... Hydraulic Oil Filter..... Oil Filter Full Flow..... Oil Filter Full Flow.....	A-5566 A-5567 A-5568-S FC-5507 HC-5504 C-5522 C-5510
522C (FELLER BUNCHERS) CAT S/N: 2WL1-UP Air Filter Set..... Air Filter Secondary..... Air Filter Primary..... Fuel Filter Secondary..... Hydraulic Oil Filter..... Oil Filter Full Flow..... Oil Filter Full Flow.....	A-5568-S A-5567 A-5566 FC-5507 HC-5504 C-5510 C-5522
5230 (EXCAVATORS) CAT 3516 (S/N: 2PK1-UP) Air Filter..... Air Filter Primary..... Air Filter Set..... Air Filter Secondary..... Fuel Filter..... Hydraulic Oil Filter.....	A-5547 A-5564 A-5565-S A-5563 FC-5510 H-5510

MODEL/APPLICATION	SAKURA NO
CATERPILLAR	
Hydraulic Oil Filter.....	H-5506
5230 (EXCAVATORS) CAT 3516 (S/N: 7LL1-UP) Air Filter Primary..... Air Filter..... Air Filter Set..... Air Filter Secondary..... Fuel Filter..... Hydraulic Oil Filter..... Hydraulic Oil Filter..... Hydraulic Oil Filter.....	A-5564 A-5547 A-5565-S A-5563 FC-5510 H-5506 HC-5516 H-5510
525 (SKIDDERS) CAT (S/N: 07Z31733-UP) Fuel Filter Secondary..... Oil Filter Full Flow..... Oil Filter Full Flow.....	FC-5507 C-5522 C-5510
525 (SKIDDERS) S/N: 1DN1069-1968-UP Air Filter Primary..... Air Filter Set..... Air Filter Secondary..... Hydraulic Oil Filter..... Hydraulic Oil Filter..... Hydraulic Oil Filter.....	A-5566 A-5568-S A-5567 H-5510 HC-5504 H-5506
525 (SKIDDERS) S/N: 1DN1-1068-UP Air Filter Primary..... Air Filter Secondary..... Air Filter Set..... Hydraulic Oil Filter..... Hydraulic Oil Filter..... Hydraulic Oil Filter.....	A-5566 A-5567 A-5568-S HC-5504 H-5510 H-5506
525 (SKIDDERS) S/N: 1DN1969-UP Air Filter Primary..... Air Filter Secondary..... Air Filter Set..... Hydraulic Oil Filter..... Hydraulic Oil Filter..... Hydraulic Oil Filter.....	A-5566 A-5567 A-5568-S HC-5504 H-5510 H-5506
525 (SKIDDERS) S/N: 1DN1-UP Fuel Filter Secondary.....	FC-5507
525B (SKIDDERS) CAT 3126 (S/N: 2KZ00797--00874) Air Filter Set..... Air Filter Primary..... Air Filter Secondary..... Fuel Filter..... Fuel Filter Secondary..... Fuel Filter Secondary..... Hydraulic Oil Filter..... Hydraulic Oil Filter..... Hydraulic Oil Filter.....	A-5573-S A-5535 A-5534 FC-5516 FC-5515 FC-55151 HC-5504 H-5506 C-5510
525B (SKIDDERS) CAT S/N: 3KZ1--00795) Air Filter Primary..... Air Filter Set..... Air Filter Secondary..... Fuel Filter Secondary..... Fuel Filter Secondary..... Fuel Filter..... Hydraulic Oil Filter..... Hydraulic Oil Filter..... Hydraulic Oil Filter..... Oil Filter Full Flow.....	A-5535 A-5573-S A-5534 FC-5515 FC-55151 FC-5516 HC-5504 H-5506 H-5510 C-5510
525B (SKIDDERS) CAT 3126 (S/N: 3KZ1--00874) Air Filter Primary..... Air Filter Set..... Air Filter Secondary..... Fuel Filter..... Fuel Filter..... Fuel Filter Secondary..... Fuel Filter Secondary..... Fuel Filter Secondary..... Hydraulic Oil Filter..... Hydraulic Oil Filter..... Hydraulic Oil Filter..... Oil Filter Full Flow.....	A-5535 A-5573-S A-5534 FC-5508 FC-5516 FC-5515 FC-55151 H-5510 HC-5504 C-5510
525B (SKIDDERS) W/3126 ENG. Air Filter Primary..... Air Filter Set.....	A-5535M A-5573M-S
525C (SKIDDERS) CAT S/N: 5251-UP Fuel Filter..... Hydraulic Oil Filter..... Oil Filter Full Flow.....	FC-5517 HC-5504 C-5522
525C (SKIDDERS) CAT S/N: KH304-UP Fuel Filter..... Hydraulic Oil Filter..... Oil Filter Full Flow.....	FC-5517 HC-5504 C-5522
525D (SKIDDERS) CAT C7.1 Fuel Filter.....	EF-55050
527 (SKIDDERS) CAT 3304 TA Air Filter Primary..... Air Filter Set..... Air Filter Primary..... Air Filter Secondary..... Fuel Filter..... Hydraulic Oil Filter.....	A-5549M A-5549M-S A-5549 A-5550 F-5505 H-5504

MODEL/APPLICATION	SAKURA NO
CATERPILLAR	
Air Filter Secondary.....	A-5534
Air Filter Set.....	A-5573-S
Fuel Filter.....	FC-5516
Fuel Filter.....	FC-5508
Fuel Filter Secondary.....	FC-55151
Fuel Filter Secondary.....	FC-5515
Hydraulic Oil Filter.....	HC-5504
Hydraulic Oil Filter.....	H-5510
Oil Filter Full Flow.....	C-5510
525B (SKIDDERS) CAT 3126 (S/N: 3KZ1--00795) Air Filter Primary..... Air Filter Set..... Air Filter Secondary..... Fuel Filter Secondary..... Fuel Filter Secondary..... Fuel Filter..... Hydraulic Oil Filter..... Hydraulic Oil Filter..... Hydraulic Oil Filter..... Oil Filter Full Flow.....	A-5535 A-5573-S A-5534 FC-5515 FC-55151 FC-5516 HC-5504 H-5506 H-5510 C-5510
525B (SKIDDERS) CAT 3126 (S/N: 3KZ1--00874) Air Filter Primary..... Air Filter Set..... Air Filter Secondary..... Fuel Filter..... Fuel Filter..... Fuel Filter Secondary..... Fuel Filter Secondary..... Fuel Filter Secondary..... Hydraulic Oil Filter..... Hydraulic Oil Filter..... Hydraulic Oil Filter..... Oil Filter Full Flow.....	A-5535 A-5573-S A-5534 FC-5508 FC-5516 FC-5515 FC-55151 H-5510 HC-5504 C-5510
525B (SKIDDERS) W/3126 ENG. Air Filter Primary..... Air Filter Set.....	A-5535M A-5573M-S
525C (SKIDDERS) CAT S/N: 5251-UP Fuel Filter..... Hydraulic Oil Filter..... Oil Filter Full Flow.....	FC-5517 HC-5504 C-5522
525C (SKIDDERS) CAT S/N: KH304-UP Fuel Filter..... Hydraulic Oil Filter..... Oil Filter Full Flow.....	FC-5517 HC-5504 C-5522
525D (SKIDDERS) CAT C7.1 Fuel Filter.....	EF-55050
527 (SKIDDERS) CAT 3304 TA Air Filter Primary..... Air Filter Set..... Air Filter Primary..... Air Filter Secondary..... Fuel Filter..... Hydraulic Oil Filter.....	A-5549M A-5549M-S A-5549 A-5550 F-5505 H-5504

MODEL/APPLICATION	SAKURA NO
CATERPILLAR	
527 (SKIDDERS) CAT 3304 TA	
Hydraulic Oil Filter.....	H-5510
Oil Filter Full Flow.....	C-5510
527 (SKIDDERS) CAT 3304 (S/N: 2RS1-UP)	
Air Filter Secondary.....	A-5550
Air Filter Primary.....	A-5549M
Air Filter Set.....	A-5549M-S
Air Filter Primary.....	A-5549
Fuel Filter.....	F-5505
Fuel Filter Secondary.....	FC-5507
Hydraulic Oil Filter.....	H-5510
Oil Filter Full Flow.....	C-5510
527 (SKIDDERS) CAT 3304 (S/N: 3DS1-UP)	
Air Filter Primary.....	A-5549M
Air Filter Secondary.....	A-5550
Air Filter Set.....	A-5549M-S
Air Filter Primary.....	A-5549
Fuel Filter Secondary.....	FC-5507
Fuel Filter.....	F-5505
Hydraulic Oil Filter.....	H-5510
Oil Filter Full Flow.....	C-5510
527 (SKIDDERS) CAT 3304 (S/N: 4NS1-UP)	
Air Filter Set.....	A-5549M-S
Air Filter Primary.....	A-5549M
Air Filter Secondary.....	A-5550
Air Filter Primary.....	A-5549
Fuel Filter.....	F-5505
Fuel Filter Secondary.....	FC-5507
Hydraulic Oil Filter.....	H-5510
Oil Filter Full Flow.....	C-5510
528B (SKIDDERS) CAT (S/N: 08Z66000-UP)	
Fuel Filter Secondary.....	FC-5507
Oil Filter Full Flow.....	C-5522
528B (SKIDDERS) CAT (S/N: 6NC1-UP)	
Fuel Filter Secondary.....	FC-5507
Fuel Filter.....	FC-5509
Oil Filter Full Flow.....	C-5522
528B (SKIDDERS) S/N: 1PX1-UP	
Hydraulic Oil Filter.....	H-55270
528B (SKIDDERS) S/N: 7GX1-UP	
Hydraulic Oil Filter.....	H-55270
528B (SKIDDERS) S/N: 8SJ1-UP	
Air Filter Primary.....	A-5549M
Air Filter Primary.....	A-5549
Air Filter Secondary.....	A-5550
Air Filter Set.....	A-5549M-S
Hydraulic Oil Filter.....	H-55270
Hydraulic Oil Filter.....	H-5504

MODEL/APPLICATION	SAKURA NO
CATERPILLAR	
528 (SKIDDERS) CAT 3306 (S/N: 51S1-UP) , 2005-UP	
Air Filter Primary.....	A-5509
Air Filter Set.....	A-5522-S
Air Filter Secondary.....	A-5510
Fuel Filter Secondary.....	FC-5507
Fuel Filter.....	F-5505
Hydraulic Oil Filter.....	H-5504
528 (SKIDDERS) CAT 3306 (S/N: 96C1-UP) , 2005-UP	
Air Filter Primary.....	A-5509
Air Filter Secondary.....	A-5510
Air Filter Set.....	A-5522-S
Fuel Filter Secondary.....	FC-5507
Fuel Filter.....	F-5505
Hydraulic Oil Filter.....	H-5504
528 (SKIDDERS) CAT 3306 (S/N: 97C1-UP) , 2005-UP	
Air Filter Set.....	A-5522-S
Air Filter Primary.....	A-5509
Air Filter Secondary.....	A-5510
Fuel Filter.....	F-5505
Fuel Filter Secondary.....	FC-5507
Hydraulic Oil Filter.....	H-5504
528 (SKIDDERS) S/N: 51S1-128	
Air Filter Set.....	A-5522-S
Air Filter Primary.....	A-5549M
Air Filter Primary.....	A-5549
Air Filter Secondary.....	A-5550
Air Filter Secondary.....	A-5510
Air Filter Set.....	A-5549M-S
Air Filter Primary.....	A-5509
Fuel Filter Secondary.....	FC-5507
Hydraulic Oil Filter.....	H-5504
Oil Filter Full Flow.....	C-5510
528 (SKIDDERS) S/N: 51S129-UP	
Air Filter Primary.....	A-5549
Air Filter Secondary.....	A-5550
Air Filter Primary.....	A-5509
Air Filter Primary.....	A-5549M
Air Filter Set.....	A-5522-S
Air Filter Secondary.....	A-5510
Air Filter Set.....	A-5549M-S
Fuel Filter Secondary.....	FC-5507
Hydraulic Oil Filter.....	H-5504
Oil Filter Full Flow.....	C-5510
528 (SKIDDERS) S/N: 78W1-UP	
Fuel Filter Secondary.....	FC-5507
Oil Filter Full Flow.....	C-5510
528 (SKIDDERS) S/N: 96C1-UP	

MODEL/APPLICATION	SAKURA NO
CATERPILLAR	
Air Filter Set.....	A-5522-S
Air Filter Primary.....	A-5509
Fuel Filter Secondary.....	FC-5507
Hydraulic Oil Filter.....	H-5504
Oil Filter Full Flow.....	C-5510
528 (SKIDDERS) S/N: 97C1-UP	
Air Filter Primary.....	A-5549
Air Filter Secondary.....	A-5550
Air Filter Set.....	A-5549M-S
Air Filter Primary.....	A-5549M
Air Filter Set.....	A-5522-S
Air Filter Primary.....	A-5509
Air Filter Secondary.....	A-5510
Fuel Filter Secondary.....	FC-5507
Hydraulic Oil Filter.....	H-5504
Oil Filter Full Flow.....	C-5510
528 (SKIDDERS) w/3306 Eng.	
Hydraulic Oil Filter.....	H-55320
530B (SKIDDERS) CAT (S/N: 08Z66000-UP)	
Fuel Filter Secondary.....	FC-5507
Oil Filter Full Flow.....	C-5522
530B (SKIDDERS) CAT (S/N: 6NC1-UP)	
Fuel Filter Secondary.....	FC-5507
Fuel Filter.....	FC-5509
Oil Filter Full Flow.....	C-5522
530B (SKIDDERS) S/N: 3PX1-UP	
Hydraulic Oil Filter.....	H-55270
530B (SKIDDERS) S/N: 5BK1-UP	
Air Filter Primary.....	A-5549
Air Filter Primary.....	A-5549M
Air Filter Secondary.....	A-5550
Air Filter Set.....	A-5549M-S
Hydraulic Oil Filter.....	H-55270
Hydraulic Oil Filter.....	H-5504
530B (SKIDDERS) S/N: 7HX1-UP	
Hydraulic Oil Filter.....	H-55270
532 (FELLER BUNCHERS) CAT S/N: 5321-UP	
Air Filter.....	A-5584
Air Filter Secondary.....	A-8651
Fuel Filter.....	FC-5517
Hydraulic Oil Filter.....	HC-5801
Hydraulic Oil Filter.....	HC-55170
Hydraulic Oil Filter.....	H-5509
532 (FELLER BUNCHERS) CAT S/N: THX1-UP	
Air Filter.....	A-5584
Air Filter Secondary.....	A-8651
Fuel Filter.....	FC-5517
Hydraulic Oil Filter.....	HC-5801

MODEL/APPLICATION	SAKURA NO	MODEL/APPLICATION	SAKURA NO	MODEL/APPLICATION	SAKURA NO
CATERPILLAR		CATERPILLAR		CATERPILLAR	
532 (FELLER BUNCHERS) CAT S/N: THX1-UP Hydraulic Oil Filter..... HC-55170 Hydraulic Oil Filter..... H-5509		535B (SKIDDERS) S/N: AAE562-562-UP Hydraulic Oil Filter..... HC-5504 535B (SKIDDERS) S/N: AAE563-567-UP Hydraulic Oil Filter..... HC-5504 Hydraulic Oil Filter..... H-5510 Hydraulic Oil Filter..... H-5506		Fuel Filter..... FC-5516 Fuel Filter..... FC-5508 Hydraulic Oil Filter..... HC-5505 Oil Filter Full Flow..... C-5510 539 (LOG LOADERS) W/3126 ENG. Air Filter Set..... A-5573M-S Air Filter Primary..... A-5535M	
533 (FELLER BUNCHERS) CAT 3126 (S/N: CDR1-UP) Air Filter Primary..... A-5558 Air Filter Secondary..... A-5559 Fuel Filter Secondary..... FC-5515 Fuel Filter..... FC-5516 Fuel Filter..... FC-5508 Fuel Filter Secondary..... FC-55151 Hydraulic Oil Filter..... HC-55300 Oil Filter Full Flow..... C-5510		535B (SKIDDERS) S/N: AAE568-582-UP Hydraulic Oil Filter..... H-5510 Hydraulic Oil Filter..... HC-5504 Hydraulic Oil Filter..... H-5506 535B (SKIDDERS) S/N: AAE583-708-UP Hydraulic Oil Filter..... HC-5504 535B (SKIDDERS) S/N: AAE709-746-UP Hydraulic Oil Filter..... HC-5504 535B (SKIDDERS) S/N: AAE747-778-UP Hydraulic Oil Filter..... HC-5504 535B (SKIDDERS) S/N: AAE779-UP Air Filter Secondary..... A-5534 Air Filter Primary..... A-5535 Air Filter Set..... A-5573-S Hydraulic Oil Filter..... HC-5504 535B (SKIDDERS) W/3126 ENG. Air Filter Set..... A-5573M-S Air Filter Primary..... A-5535M		541 (FELLER BUNCHERS) CAT S/N: 5411-UP Air Filter..... A-5584 Air Filter Secondary..... A-8651 Fuel Filter..... FC-5517 Hydraulic Oil Filter..... HC-5801 Hydraulic Oil Filter..... HC-55170 Hydraulic Oil Filter..... H-5509 541 (FELLER BUNCHERS) CAT S/N: THX1-UP Air Filter..... A-5584 Air Filter Secondary..... A-8651 Fuel Filter..... FC-5517 Hydraulic Oil Filter..... HC-5801 Hydraulic Oil Filter..... H-5509 Hydraulic Oil Filter..... HC-55170	
535B (SKIDDERS) CAT 3126 DITA Air Filter Primary..... A-5535 Air Filter Set..... A-5573-S Air Filter Secondary..... A-5534 Fuel Filter Secondary..... FC-5515 Fuel Filter Secondary..... FC-55151 Fuel Filter..... FC-5508 Fuel Filter..... FC-5516 Hydraulic Oil Filter..... HC-5504 Oil Filter Full Flow..... C-5510		535d (SKIDDERS) CAT C7.1 Fuel Filter..... EF-55050 535C (SKIDDERS) CAT S/N: 5351-UP Fuel Filter..... FC-5517 Hydraulic Oil Filter..... HC-5504 Oil Filter Full Flow..... C-5522 535C (SKIDDERS) CAT S/N: KHX1-UP Fuel Filter..... FC-5517 Hydraulic Oil Filter..... HC-5504 Oil Filter Full Flow..... C-5522 538 (LOG LOADERS) CAT C7.1 Fuel Filter..... EF-55050 539 (LOG LOADERS) CAT 3126 DITA (S/N: 1PZ-UP) Air Filter Primary..... A-5535 Air Filter Set..... A-5573-S Air Filter Secondary..... A-5534 Fuel Filter Secondary..... FC-55151 Fuel Filter Secondary..... FC-5515		543 (FELLER BUNCHERS) CAT 3126 (S/N: ASJ1-UP) Air Filter Secondary..... A-5559 Air Filter Primary..... A-5558 Fuel Filter..... FC-5516 Fuel Filter Secondary..... FC-55151 Fuel Filter Secondary..... FC-5515 Fuel Filter..... FC-5508 Hydraulic Oil Filter..... HC-55300 Oil Filter Full Flow..... C-5510 545 (SKIDDERS) CAT (S/N: 6NC1-UP) Fuel Filter..... FC-5509 Fuel Filter Secondary..... FC-5507 Oil Filter Full Flow..... C-5522 545 (SKIDDERS) CAT 3306 (S/N: 2FZ1-UP) Air Filter Set..... A-5573-S Air Filter Primary..... A-5535 Air Filter Secondary..... A-5534 Fuel Filter..... F-5505 Fuel Filter Secondary..... FC-5507 Hydraulic Oil Filter..... H-5510 Hydraulic Oil Filter..... HC-5504 Hydraulic Oil Filter..... H-5506 Oil Filter Full Flow..... C-5510 545 (SKIDDERS) S/N: 2FZ1-431-UP Air Filter Secondary..... A-5534 Air Filter Set..... A-5573-S Air Filter Primary..... A-5535 Hydraulic Oil Filter..... H-5510 Hydraulic Oil Filter..... H-5506 Hydraulic Oil Filter..... HC-5504	
535B (SKIDDERS) S/N: AAE1-557-UP Air Filter Set..... A-5573-S Air Filter Primary..... A-5535 Air Filter Secondary..... A-5534 Hydraulic Oil Filter..... HC-5504 Hydraulic Oil Filter..... H-5506 Hydraulic Oil Filter..... H-5510		535B (SKIDDERS) S/N: AAE558-561-UP Hydraulic Oil Filter..... H-5510 Hydraulic Oil Filter..... HC-5504 Hydraulic Oil Filter..... H-5506			

Sakura Filter

ENGINE APPLICATION

MODEL/APPLICATION	SAKURA NO	MODEL/APPLICATION	SAKURA NO	MODEL/APPLICATION	SAKURA NO
CATERPILLAR		CATERPILLAR		CATERPILLAR	
545 <i>(SKIDDERS)</i> S/N: 2FZ432-432-UP		Hydraulic Oil Filter.....	HC-5801	Hydraulic Oil Filter.....	HC-5504
Air Filter Set.....	A-5573-S	Oil Filter Full Flow.....	C-5510		
Air Filter Primary.....	A-5535			55 <i>(TRACTORS)</i> S/N: AEN1-UP	
Air Filter Secondary.....	A-5534	Fuel Filter.....	FC-5508	Air Filter Secondary.....	A-5550
Hydraulic Oil Filter.....	HC-5504	Fuel Filter.....	FC-5516	Air Filter Set.....	A-5549M-S
Hydraulic Oil Filter.....	H-5510	Fuel Filter Secondary.....	FC-5515	Air Filter Primary.....	A-5549
Hydraulic Oil Filter.....	H-5506	Fuel Filter Secondary.....	FC-55151	Air Filter Primary.....	A-5549M
		Oil Filter Full Flow.....	C-5522	Hydraulic Oil Filter.....	HC-5504
545 <i>(SKIDDERS)</i> S/N: 2FZ433-433-UP					
Air Filter Primary.....	A-5535	55 <i>(TRACTORS)</i> S/N: 2CC1-UP		550B <i>(FORAGE HARVESTERS)</i> CAT 3056E (S/N: SAW1-UP)	
Air Filter Secondary.....	A-5534	Hydraulic Oil Filter.....	H-5501	Air Filter Primary.....	A-5549
Air Filter Set.....	A-5573-S			Air Filter Primary.....	A-5549M
Hydraulic Oil Filter.....	HC-5504	55 <i>(TRACTORS)</i> S/N: 2EJ1-UP		Air Filter Set.....	A-5549M-S
		Hydraulic Oil Filter.....	H-5501	Air Filter Secondary.....	A-5550
545 <i>(SKIDDERS)</i> S/N: 2FZ434-437-UP				Hydraulic Oil Filter.....	HC-5801
Air Filter Set.....	A-5573-S	55 <i>(TRACTORS)</i> S/N: 3SM1-UP			
Air Filter Primary.....	A-5535	Air Filter Primary.....	A-5549M	551 <i>(FELLER BUNCHERS)</i> CAT S/N: 5511-UP	
Air Filter Secondary.....	A-5534	Air Filter Primary.....	A-5549	Air Filter.....	A-5584
Hydraulic Oil Filter.....	H-5510	Air Filter Secondary.....	A-5550	Air Filter Secondary.....	A-8651
Hydraulic Oil Filter.....	H-5506	Air Filter Set.....	A-5549M-S	Fuel Filter.....	FC-5517
Hydraulic Oil Filter.....	HC-5504	Hydraulic Oil Filter.....	HC-5504	Hydraulic Oil Filter.....	HC-55170
				Hydraulic Oil Filter.....	HC-5801
545 <i>(SKIDDERS)</i> S/N: 2FZ438-UP		55 <i>(TRACTORS)</i> S/N: 5DK1-1849-UP		Hydraulic Oil Filter.....	H-5509
Air Filter Secondary.....	A-5534	Air Filter Primary.....	A-5549M		
Air Filter Set.....	A-5573-S	Air Filter Set.....	A-5549M-S	551 <i>(FELLER BUNCHERS)</i> CAT S/N: 5521-UP	
Air Filter Primary.....	A-5535	Air Filter Secondary.....	A-5550	Air Filter.....	A-5584
Hydraulic Oil Filter.....	HC-5504	Air Filter Primary.....	A-5549	Air Filter Secondary.....	A-8651
		Hydraulic Oil Filter.....	HC-5512	Fuel Filter.....	FC-5517
545 <i>(SKIDDERS)</i> w/3306 Eng.		Hydraulic Oil Filter.....	HC-5506	Hydraulic Oil Filter.....	HC-55170
Air Filter Set.....	A-5573M-S	Hydraulic Oil Filter.....	HC-5504	Hydraulic Oil Filter.....	HC-5801
Air Filter Primary.....	A-5535M	Hydraulic Oil Filter.....	HC-5503	Hydraulic Oil Filter.....	H-5509
545C <i>(SKIDDERS)</i> CAT S/N: 5451-UP		55 <i>(TRACTORS)</i> S/N: 6NN1-UP		551 <i>(FELLER BUNCHERS)</i> CAT S/N: THX1-UP	
Fuel Filter.....	FC-5517	Air Filter Secondary.....	A-5550	Air Filter.....	A-5584
Hydraulic Oil Filter.....	HC-5504	Air Filter Primary.....	A-5549M	Air Filter Secondary.....	A-8651
Oil Filter Full Flow.....	C-5522	Air Filter Primary.....	A-5549	Fuel Filter.....	FC-5517
		Air Filter Set.....	A-5549M-S	Hydraulic Oil Filter.....	HC-5801
545C <i>(SKIDDERS)</i> CAT S/N: KHX1-UP		Hydraulic Oil Filter.....	HC-5504	Hydraulic Oil Filter.....	H-5509
Fuel Filter.....	FC-5517			Hydraulic Oil Filter.....	HC-55170
Hydraulic Oil Filter.....	HC-5504	55 <i>(TRACTORS)</i> S/N: 7DM1-UP			
Oil Filter Full Flow.....	C-5522	Air Filter Set.....	A-5549M-S	554 <i>(FORWARDERS)</i> CAT 7BJ1-UP	
		Air Filter Primary.....	A-5549M	Air Filter Primary.....	A-56731
545D <i>(SKIDDERS)</i> CAT C7.1		Air Filter Secondary.....	A-5550	Air Filter Set.....	A-56731-S
Fuel Filter.....	EF-55050	Air Filter Primary.....	A-5549	Air Filter Secondary.....	A-56741
		Hydraulic Oil Filter.....	HC-5504		
548 <i>(LOG LOADERS)</i> CAT C7.1		Hydraulic Oil Filter.....	HC-5512	554 <i>(FORWARDERS)</i> S/N: 1AM-UP	
Fuel Filter.....	EF-55050	Hydraulic Oil Filter.....	HC-5503	Air Filter Set.....	A-5541M-S
		Hydraulic Oil Filter.....	HC-5506	Air Filter Primary.....	A-5541
550 <i>(FORAGE HARVESTERS)</i> CAT 3126 (S/N: 7Z1-UP)		Oil Filter Full Flow.....	C-5510	Air Filter Primary.....	A-5541M
Air Filter Set.....	A-5549M-S	Oil Filter Full Flow.....	C-5522	Air Filter Primary.....	A-76231
Air Filter Secondary.....	A-5550			Air Filter Secondary.....	A-5540
Air Filter Primary.....	A-5549M	55 <i>(TRACTORS)</i> S/N: 7T21-UP		Hydraulic Oil Filter.....	HC-5504
Air Filter Primary.....	A-5549	Air Filter Set.....	A-5549M-S	Oil Filter Full Flow.....	C-5102
Fuel Filter Secondary.....	FC-55151	Air Filter Secondary.....	A-5550		
Fuel Filter Secondary.....	FC-5515	Air Filter Set.....	A-5549M-S	555D <i>(SKIDDERS)</i> CAT C7.1	
Fuel Filter.....	FC-5516	Air Filter Primary.....	A-5549M	Fuel Filter.....	EF-55050

Sakura Filter

ENGINE APPLICATION

MODEL/APPLICATION	SAKURA NO	MODEL/APPLICATION	SAKURA NO	MODEL/APPLICATION	SAKURA NO
CATERPILLAR		CATERPILLAR		CATERPILLAR	
558 (LOG LOADERS) CAT C7.1 Fuel Filter..... EF-55050		561C (PIPE LAYERS) S/N: 85H1-UP Air Filter Secondary..... A-5550 Air Filter Secondary..... A-5510 Air Filter Primary..... A-5549 Air Filter Set..... A-5522-S Air Filter Primary..... A-5509 Air Filter Primary..... A-5549M Air Filter Set..... A-5549M-S Fuel Filter Secondary..... FC-5507 Fuel Filter..... F-5501 Hydraulic Oil Filter..... H-5502 Hydraulic Oil Filter..... H-5504 Oil Filter Full Flow..... C-5510 Oil Filter Full Flow..... O-5502		561D (PIPE LAYERS) Fuel Filter..... F-5503 563C (FELLER BUNCHERS) CAT C7.1 Fuel Filter..... EF-55050 563D (FELLER BUNCHERS) CAT C7.1 Fuel Filter..... EF-55050	
559C (LOG LOADERS) CAT C6.6 Fuel Filter..... EF-55050		561C (PIPE LAYERS) S/N: 92J1-362 Air Filter Primary..... A-5549M Air Filter Set..... A-5549M-S Air Filter Secondary..... A-5510 Air Filter Set..... A-5522-S Air Filter Primary..... A-5549 Air Filter Primary..... A-5509 Air Filter Secondary..... A-5550 Fuel Filter Secondary..... FC-5507 Hydraulic Oil Filter..... H-5504 Oil Filter Full Flow..... O-5502		564 (FORWARDERS) CAT S/N: CPT1-UP Air Filter Primary..... AS-8577 Air Filter Secondary..... A-8578 Fuel Filter..... FC-5517 Hydraulic Oil Filter..... HC-5504 Hydraulic Oil Filter..... HC-5801 Oil Filter Full Flow..... C-5522	
560B (HANDLER TELESCOPIC) CAT 3056E (S/N: TRA1-UP) Air Filter Set..... A-5549M-S Air Filter Secondary..... A-5550 Air Filter Primary..... A-5549 Air Filter Primary..... A-5549M Hydraulic Oil Filter..... HC-5801		561C (PIPE LAYERS) S/N: 92J1-362 Air Filter Primary..... A-5549M Air Filter Set..... A-5549M-S Air Filter Secondary..... A-5510 Air Filter Set..... A-5522-S Air Filter Primary..... A-5549 Air Filter Primary..... A-5509 Air Filter Secondary..... A-5550 Fuel Filter Secondary..... FC-5507 Hydraulic Oil Filter..... H-5504 Oil Filter Full Flow..... O-5502		564 (FORWARDERS) CAT S/N: KBN1-UP Air Filter Secondary..... A-8578 Air Filter Primary..... AS-8577 Fuel Filter..... FC-5517 Hydraulic Oil Filter..... HC-5504 Hydraulic Oil Filter..... HC-5801 Oil Filter Full Flow..... C-5522	
561M (PIPE LAYERS) CAT 3116 Air Filter Set..... A-5568-S Air Filter Secondary..... A-5567 Air Filter Primary..... A-5566 Fuel Filter..... FC-5516 Fuel Filter Secondary..... FC-55151 Fuel Filter Secondary..... FC-5515 Hydraulic Oil Filter..... H-5504 Oil Filter Full Flow..... C-5510		561C (PIPE LAYERS) S/N: 92J1-UP Air Filter Secondary..... A-5550 Air Filter Primary..... A-5549 Air Filter Secondary..... A-5510 Air Filter Primary..... A-5549M Air Filter Set..... A-5522-S Air Filter Set..... A-5549M-S Air Filter Primary..... A-5509 Fuel Filter Secondary..... FC-5507 Fuel Filter..... F-5501 Hydraulic Oil Filter..... H-5502 Hydraulic Oil Filter..... H-5504 Oil Filter Full Flow..... C-5510 Oil Filter Full Flow..... O-5502		570 (FORAGE HARVESTERS) CAT 3126 (S/N: 4XR1-UP) Air Filter Set..... A-5549M-S Air Filter Secondary..... A-5550 Air Filter Primary..... A-5549 Air Filter Primary..... A-5549M Fuel Filter Secondary..... FC-5515 Fuel Filter..... FC-5516 Fuel Filter Secondary..... FC-55151 Hydraulic Oil Filter..... HC-5801 Oil Filter Full Flow..... C-5510	
561N (PIPE LAYERS) w/3126B Eng. Hydraulic Oil Filter..... HC-55280		561C (PIPE LAYERS) S/N: 92J363-UP Air Filter Set..... A-5549M-S Air Filter Secondary..... A-5550 Air Filter Primary..... A-5549M Air Filter Primary..... A-5509 Air Filter Secondary..... A-5510 Air Filter Set..... A-5522-S Air Filter Primary..... A-5549 Fuel Filter Secondary..... FC-5507 Fuel Filter..... F-5501 Hydraulic Oil Filter..... H-5502 Hydraulic Oil Filter..... H-5504 Oil Filter Full Flow..... C-5510 Oil Filter Full Flow..... O-5502		570B (FORAGE HARVESTERS) CAT 3126B (S/N: CKG1-UP) Air Filter Secondary..... A-5550 Air Filter Primary..... A-5549M Air Filter Primary..... A-5549 Air Filter Set..... A-5549M-S Fuel Filter..... FC-5517 Hydraulic Oil Filter..... HC-5801 Oil Filter Full Flow..... C-5510	
561B (PIPE LAYERS) S/N: 62A1-UP Air Filter Set..... A-5507-S Air Filter Secondary..... A-5567 Air Filter Set..... A-5568-S Air Filter Set..... A-55071-S Air Filter Primary..... A-5507 Air Filter Secondary..... A-5508 Air Filter Primary..... A-5566 Fuel Filter..... F-5501 Hydraulic Oil Filter..... H-5504 Oil Filter Full Flow..... O-5502		561C (PIPE LAYERS) S/N: 92J1-UP Air Filter Secondary..... A-5550 Air Filter Primary..... A-5549 Air Filter Secondary..... A-5510 Air Filter Primary..... A-5549M Air Filter Set..... A-5522-S Air Filter Set..... A-5549M-S Air Filter Primary..... A-5509 Fuel Filter Secondary..... FC-5507 Fuel Filter..... F-5501 Hydraulic Oil Filter..... H-5502 Hydraulic Oil Filter..... H-5504 Oil Filter Full Flow..... C-5510 Oil Filter Full Flow..... O-5502		571A (PIPE LAYERS) S/N: 64A1-151 Fuel Filter..... F-5501 Hydraulic Oil Filter..... H-5504 Oil Filter Full Flow..... O-5503	
561C (PIPE LAYERS) Fuel Filter..... F-5503		561C (PIPE LAYERS) S/N: 92J363-UP Air Filter Set..... A-5549M-S Air Filter Secondary..... A-5550 Air Filter Primary..... A-5549M Air Filter Primary..... A-5509 Air Filter Secondary..... A-5510 Air Filter Set..... A-5522-S Air Filter Primary..... A-5549 Fuel Filter Secondary..... FC-5507 Hydraulic Oil Filter..... H-5504 Oil Filter Full Flow..... C-5510		571A (PIPE LAYERS) S/N: 64A152-UP Air Filter Primary..... A-5514 Air Filter Set..... A-5514-S Fuel Filter..... F-5501 Hydraulic Oil Filter..... H-5504 Oil Filter Full Flow..... O-5503	
561C (PIPE LAYERS) S/N: 54X1-UP Air Filter Secondary..... A-5550 Air Filter Set..... A-5549M-S Air Filter Secondary..... A-5510 Air Filter Primary..... A-5549 Air Filter Primary..... A-5509 Air Filter Primary..... A-5549M Air Filter Set..... A-5522-S Fuel Filter Secondary..... FC-5507 Fuel Filter..... F-5501 Hydraulic Oil Filter..... H-5504 Hydraulic Oil Filter..... H-5502 Oil Filter Full Flow..... C-5510 Oil Filter Full Flow..... O-5502		561C (PIPE LAYERS) S/N: 92J363-UP Air Filter Set..... A-5549M-S Air Filter Secondary..... A-5550 Air Filter Primary..... A-5549M Air Filter Primary..... A-5509 Air Filter Secondary..... A-5510 Air Filter Set..... A-5522-S Air Filter Primary..... A-5549 Fuel Filter Secondary..... FC-5507 Hydraulic Oil Filter..... H-5504 Oil Filter Full Flow..... C-5510		571A (PIPE LAYERS) S/N: 64A152-UP Air Filter Primary..... A-5514 Air Filter Set..... A-5514-S Fuel Filter..... F-5501 Hydraulic Oil Filter..... H-5504 Oil Filter Full Flow..... O-5503	
561C (PIPE LAYERS) S/N: 54X1-UP Air Filter Secondary..... A-5550 Air Filter Set..... A-5549M-S Air Filter Secondary..... A-5510 Air Filter Primary..... A-5549 Air Filter Primary..... A-5509 Air Filter Primary..... A-5549M Air Filter Set..... A-5522-S Fuel Filter Secondary..... FC-5507 Fuel Filter..... F-5501 Hydraulic Oil Filter..... H-5504 Hydraulic Oil Filter..... H-5502 Oil Filter Full Flow..... C-5510 Oil Filter Full Flow..... O-5502		561C (PIPE LAYERS) S/N: 92J363-UP Air Filter Set..... A-5549M-S Air Filter Secondary..... A-5550 Air Filter Primary..... A-5549M Air Filter Primary..... A-5509 Air Filter Secondary..... A-5510 Air Filter Set..... A-5522-S Air Filter Primary..... A-5549 Fuel Filter Secondary..... FC-5507 Hydraulic Oil Filter..... H-5504 Oil Filter Full Flow..... C-5510		571A (PIPE LAYERS) S/N: 64A152-UP Air Filter Primary..... A-5514 Air Filter Set..... A-5514-S Fuel Filter..... F-5501 Hydraulic Oil Filter..... H-5504 Oil Filter Full Flow..... O-5503	

Sakura Filter

ENGINE APPLICATION

MODEL/APPLICATION	SAKURA NO	MODEL/APPLICATION	SAKURA NO	MODEL/APPLICATION	SAKURA NO
CATERPILLAR		CATERPILLAR		CATERPILLAR	
571F (PIPE LAYERS)		Air Filter Set.....	A-5549M-S	Oil Filter Full Flow.....	0-5503
Fuel Filter.....	F-5503	Air Filter Primary.....	A-5509	572E (PIPE LAYERS) S/N: 65A176-UP	
571F (PIPE LAYERS) S/N: 16W1-UP		Air Filter Secondary.....	A-5550	Air Filter Primary.....	A-5514
Air Filter Secondary.....	A-5522	Air Filter Primary.....	A-5549	Air Filter Set.....	A-5514-S
Air Filter Set.....	A-5549M-S	Fuel Filter Secondary.....	FC-5507	Fuel Filter.....	F-5501
Air Filter Primary.....	A-5549	Hydraulic Oil Filter.....	H-5502	Hydraulic Oil Filter.....	H-5504
Air Filter Primary.....	A-5549M	Hydraulic Oil Filter.....	H-5503	Oil Filter Full Flow.....	0-5503
Air Filter Primary.....	A-5509	Oil Filter Full Flow.....	C-5510	572F (PIPE LAYERS)	
Air Filter Set.....	A-5522-S	571G (PIPE LAYERS) S/N: 5ZD1-UP		Fuel Filter.....	F-5503
Air Filter Secondary.....	A-5550	Air Filter Set.....	A-5549M-S	572F (PIPE LAYERS) S/N: 96N1-163	
Fuel Filter Secondary.....	FC-5507	Air Filter Secondary.....	A-5550	Air Filter Primary.....	A-5549
Hydraulic Oil Filter.....	H-5503	Air Filter Primary.....	A-5549M	Air Filter Secondary.....	A-5550
Hydraulic Oil Filter.....	H-5502	Air Filter Primary.....	A-5549	Air Filter Set.....	A-5522-S
Oil Filter Full Flow.....	C-5510	572R (PIPE LAYERS) CAT 3306 (S/N: 2HZ-UP)		Air Filter Set.....	A-5549M-S
571F (PIPE LAYERS) S/N: 95N1-190		Air Filter Primary.....	A-5535	Air Filter Primary.....	A-5549M
Air Filter Primary.....	A-5549	Air Filter Secondary.....	A-5534	Air Filter Secondary.....	A-5522
Air Filter Set.....	A-5549M-S	Air Filter Set.....	A-5573-S	Air Filter Primary.....	A-5509
Air Filter Secondary.....	A-5522	Fuel Filter.....	F-5505	Fuel Filter Secondary.....	FC-5507
Air Filter Primary.....	A-5549M	Fuel Filter Secondary.....	FC-5507	Hydraulic Oil Filter.....	H-5502
Air Filter Primary.....	A-5509	Hydraulic Oil Filter.....	H-5503	Hydraulic Oil Filter.....	H-5503
Air Filter Set.....	A-5522-S	Oil Filter Full Flow.....	C-5510	Oil Filter Full Flow.....	C-5510
Air Filter Secondary.....	A-5550	572R (PIPE LAYERS) W/3176C Eng.		572F (PIPE LAYERS) S/N: 96N164-UP	
Fuel Filter Secondary.....	FC-5507	Air Filter Set.....	A-5573M-S	Air Filter Primary.....	A-5549
Hydraulic Oil Filter.....	H-5503	Air Filter Primary.....	A-5535M	Air Filter Set.....	A-5549M-S
Oil Filter Full Flow.....	C-5510	572R (PIPE LAYERS) w/3306 Eng.		Air Filter Primary.....	A-5549M
571F (PIPE LAYERS) S/N: 95N191-UP		Air Filter Set.....	A-5573M-S	Air Filter Set.....	A-5522-S
Air Filter Set.....	A-5549M-S	Air Filter Primary.....	A-5535M	Air Filter Secondary.....	A-5550
Air Filter Primary.....	A-5549M	572R II (PIPE LAYERS) CAT S/N: 7ZR6828-UP		Air Filter Primary.....	A-5509
Air Filter Secondary.....	A-5522	Air Filter Set.....	A-5573-S	Air Filter Secondary.....	A-5522
Air Filter Secondary.....	A-5550	Air Filter Secondary.....	A-5534	Fuel Filter Secondary.....	FC-5507
Air Filter Primary.....	A-5509	Air Filter Primary.....	A-5535	Hydraulic Oil Filter.....	H-5503
Air Filter Primary.....	A-5549	Fuel Filter.....	FC-5509	Hydraulic Oil Filter.....	H-5502
Air Filter Set.....	A-5522-S	Hydraulic Oil Filter.....	H-5526	Oil Filter Full Flow.....	C-5510
Fuel Filter Secondary.....	FC-5507	Hydraulic Oil Filter.....	H-5510	572G (PIPE LAYERS) S/N: 40U1-UP	
Hydraulic Oil Filter.....	H-5503	Hydraulic Oil Filter.....	H-55280	Air Filter Secondary.....	A-5550
Oil Filter Full Flow.....	C-5510	572R II (PIPE LAYERS) CAT S/N: DSC302-UP		Air Filter Primary.....	A-5549M
571F (PIPE LAYERS) S/N: 95N1-UP		Air Filter Secondary.....	A-5534	Air Filter Primary.....	A-5509
Air Filter Set.....	A-5549M-S	Air Filter Set.....	A-5573-S	Air Filter Secondary.....	A-5522
Air Filter Set.....	A-5522-S	Air Filter Primary.....	A-5535	Air Filter Set.....	A-5549M-S
Air Filter Primary.....	A-5549	Fuel Filter.....	FC-5509	Air Filter Set.....	A-5522-S
Air Filter Primary.....	A-5509	Hydraulic Oil Filter.....	H-5526	Air Filter Primary.....	A-5549
Air Filter Secondary.....	A-5550	Hydraulic Oil Filter.....	H-55280	Fuel Filter Secondary.....	FC-5507
Air Filter Secondary.....	A-5522	Hydraulic Oil Filter.....	H-5510	Hydraulic Oil Filter.....	H-5503
Air Filter Primary.....	A-5549M	572E (PIPE LAYERS) S/N: 65A1-150		Hydraulic Oil Filter.....	H-5502
Fuel Filter Secondary.....	FC-5507	Fuel Filter.....	F-5501	Oil Filter Full Flow.....	C-5510
Hydraulic Oil Filter.....	H-5503	Hydraulic Oil Filter.....	H-5504	573C (FELLER BUNCHERS) CAT C7.1	
Hydraulic Oil Filter.....	H-5502	Oil Filter Full Flow.....	0-5503	Fuel Filter.....	EF-55050
Oil Filter Full Flow.....	C-5510	572E (PIPE LAYERS) S/N: 65A151-175		573D (FELLER BUNCHERS) CAT C7.1	
571G (PIPE LAYERS) S/N: 16W1-UP		Fuel Filter.....	F-5501	Fuel Filter.....	EF-55050
Air Filter Set.....	A-5522-S	Hydraulic Oil Filter.....	H-5504		
Air Filter Primary.....	A-5549M				
Air Filter Secondary.....	A-5522				

MODEL/APPLICATION	SAKURA NO	MODEL/APPLICATION	SAKURA NO	MODEL/APPLICATION	SAKURA NO
CATERPILLAR		CATERPILLAR		CATERPILLAR	
574 (FORWARDERS) CAT 3126 (S/N: 1FM-UP)		Oil Filter Full Flow.....	0-5501	Hydraulic Oil Filter.....	HC-5504
Air Filter Secondary.....	A-8578	583 (PIPE LAYERS) S/N: 21A1-UP		583H (PIPE LAYERS) S/N: 61A120-UP	
Fuel Filter.....	FC-5516	Fuel Filter.....	F-5501	Air Filter Set.....	A-5515-S
Fuel Filter Secondary.....	FC-55151	Oil Filter Full Flow.....	0-5502	Air Filter Primary.....	A-5515
Fuel Filter Secondary.....	FC-5515	583 (PIPE LAYERS) S/N: 61A1-119		Air Filter Secondary.....	A-5528
Hydraulic Oil Filter.....	HC-5504	Fuel Filter.....	F-5501	Fuel Filter.....	F-5501
Oil Filter Full Flow.....	C-5510	Hydraulic Oil Filter.....	H-5504	Hydraulic Oil Filter.....	H-5502
574B (FORWARDERS) CAT 3056E (S/N: CZZ1-UP)		Hydraulic Oil Filter.....	H-5503	Hydraulic Oil Filter.....	H-5503
Air Filter Primary.....	AS-8577	Oil Filter Full Flow.....	0-5501	Hydraulic Oil Filter.....	H-5504
Air Filter Secondary.....	A-8578	583 (PIPE LAYERS) S/N: 61A120-UP		Oil Filter Full Flow.....	0-5502
Hydraulic Oil Filter.....	HC-5504	Air Filter Primary.....	A-5515	583H (PIPE LAYERS) S/N: 61A1-UP	
Hydraulic Oil Filter.....	HC-5801	Air Filter Secondary.....	A-5528	Air Filter Primary.....	A-5515
578 (PIPE LAYERS) S/N: 8HB1-UP		Air Filter Set.....	A-5515-S	Air Filter Set.....	A-5515-S
Air Filter Secondary.....	A-5534	Fuel Filter.....	F-5501	Air Filter Secondary.....	A-5528
Air Filter Primary.....	A-5535	Hydraulic Oil Filter.....	H-5502	Fuel Filter.....	F-5501
Air Filter Set.....	A-5573-S	Hydraulic Oil Filter.....	H-5504	Hydraulic Oil Filter.....	H-5504
Fuel Filter.....	FC-5509	Hydraulic Oil Filter.....	H-5504	Hydraulic Oil Filter.....	H-5502
Hydraulic Oil Filter.....	H-5510	Hydraulic Oil Filter.....	H-5503	Hydraulic Oil Filter.....	H-5503
Oil Filter Full Flow.....	C-5516	Oil Filter Full Flow.....	0-5502	Oil Filter Full Flow.....	0-5502
578 (PIPE LAYERS) S/N: 9CA1-UP		583 (PIPE LAYERS) S/N: 61A199-UP		583K (PIPE LAYERS) S/N: 78V1-UP	
Hydraulic Oil Filter.....	H-5510	Air Filter Secondary.....	A-5528	Air Filter Secondary.....	A-5534
578 (PIPE LAYERS) w/3406 Eng.		Air Filter Primary.....	A-5515	Air Filter Primary.....	A-5501
Air Filter Primary.....	A-5535M	Air Filter Set.....	A-5515-S	Air Filter Secondary.....	A-5502
Air Filter Set.....	A-5573M-S	Fuel Filter.....	F-5501	Air Filter Primary.....	A-5535
579C (LOG LOADERS) CAT C6.6		Hydraulic Oil Filter.....	H-5503	Air Filter Set.....	A-5573-S
Fuel Filter.....	EF-55050	Hydraulic Oil Filter.....	H-5504	Fuel Filter Secondary.....	FC-5507
580 (FORAGE HARVESTERS) CAT 3126 (S/N: 7CN1-UP)		Oil Filter Full Flow.....	0-5501	Hydraulic Oil Filter.....	H-5503
Air Filter Secondary.....	A-5550	583R (PIPE LAYERS) CAT 3406C		Hydraulic Oil Filter.....	H-5502
Air Filter Primary.....	A-5549M	Air Filter Secondary.....	A-5556	Oil Filter Full Flow.....	C-5516
Air Filter Set.....	A-5549M-S	Air Filter Set.....	A-5555-S	587T (PIPE LAYERS) CAT S/N: FAT1-UP	
Air Filter Primary.....	A-5549	Air Filter Primary.....	A-5555	Air Filter Secondary.....	A-5556
Fuel Filter Secondary.....	FC-55151	Fuel Filter.....	FC-5509	Air Filter Primary.....	A-5555
Fuel Filter.....	FC-5516	Hydraulic Oil Filter.....	H-5510	Air Filter Set.....	A-5555-S
Fuel Filter Secondary.....	FC-5515	583T (PIPE LAYERS) CAT S/N: CMX1-UP		Fuel Filter.....	FC-5517
Hydraulic Oil Filter.....	HC-5801	Air Filter Secondary.....	A-5556	Hydraulic Oil Filter.....	HC-5504
Oil Filter Full Flow.....	C-5510	Air Filter Primary.....	A-5555	Hydraulic Oil Filter.....	H-5526
580B (FORAGE HARVESTERS) CAT 3126B (S/N: CLT1-UP)		Air Filter Set.....	A-5555-S	Hydraulic Oil Filter.....	H-55280
Air Filter Secondary.....	A-5550	Fuel Filter.....	FC-5517	587T (PIPE LAYERS) CAT S/N: LHX1-UP	
Air Filter Primary.....	A-5549M	Hydraulic Oil Filter.....	H-5526	Air Filter Primary.....	A-5555
Air Filter Primary.....	A-5549	Hydraulic Oil Filter.....	HC-5504	Air Filter Set.....	A-5555-S
Air Filter Set.....	A-5549M-S	Hydraulic Oil Filter.....	H-5506	Air Filter Secondary.....	A-5556
Fuel Filter.....	FC-5517	Hydraulic Oil Filter.....	H-55280	Fuel Filter.....	FC-5517
Hydraulic Oil Filter.....	HC-5801	Hydraulic Oil Filter.....	H-5503	Hydraulic Oil Filter.....	H-5526
Oil Filter Full Flow.....	C-5510	Hydraulic Oil Filter.....	H-5503	Hydraulic Oil Filter.....	HC-5504
583 (PIPE LAYERS) S/N: 16A-16A		583T (PIPE LAYERS) CAT S/N: LHX1-UP		Hydraulic Oil Filter.....	H-55280
Fuel Filter.....	F-5501	Air Filter Set.....	A-5555-S	587R (PIPE LAYERS) CAT S/N: 41Z23000-UP	
Hydraulic Oil Filter.....	H-55270	Air Filter Primary.....	A-5555	Air Filter Primary.....	A-5555
Hydraulic Oil Filter.....	H-5504	Air Filter Secondary.....	A-5556	Air Filter Set.....	A-5555-S
		Fuel Filter.....	FC-5517	Air Filter Secondary.....	A-5556
		Hydraulic Oil Filter.....	H-5503	Fuel Filter.....	FC-5509
		Hydraulic Oil Filter.....	H-55280	Hydraulic Oil Filter.....	HC-5504
		Hydraulic Oil Filter.....	H-5526	Hydraulic Oil Filter.....	H-5526
		Hydraulic Oil Filter.....	H-5506	Hydraulic Oil Filter.....	HC-5504
		Hydraulic Oil Filter.....	H-5506	Hydraulic Oil Filter.....	H-55280

Sakura Filter

ENGINE APPLICATION

MODEL/APPLICATION	SAKURA NO	MODEL/APPLICATION	SAKURA NO	MODEL/APPLICATION	SAKURA NO
CATERPILLAR		CATERPILLAR		CATERPILLAR	
587R (PIPE LAYERS) CAT S/N: 41Z23000-UP		Air Filter Set.....	A-5521-S	Hydraulic Oil Filter.....	H-5526
Oil Filter Full Flow.....	C-5516	Air Filter Primary.....	A-5521	Oil Filter Full Flow.....	C-5510
587R (PIPE LAYERS) CAT S/N: BXL1-UP		Fuel Filter Secondary.....	FC-5507	613C SERIES II (SCRAPERS) CAT 3116T (S/N: 93X2780-UP)	
Air Filter Set.....	A-5555-S	Hydraulic Oil Filter.....	H-5503	Air Filter Secondary.....	A-5559
Air Filter Secondary.....	A-5556	Oil Filter Full Flow.....	C-5516	Air Filter Set.....	A-5544-S
Air Filter Primary.....	A-5555	6040 (LOADERS)		Air Filter Primary.....	A-5543
Fuel Filter.....	FC-5509	Air Filter.....	A-42420	Air Filter Primary.....	A-5558
Hydraulic Oil Filter.....	H-5526	611 (SCRAPERS) CAT 3306 (S/N: 6SZ1-UP)		Fuel Filter Secondary.....	FC-5515
Hydraulic Oil Filter.....	HC-5504	Air Filter Primary.....	A-5558	Fuel Filter.....	FC-5516
Hydraulic Oil Filter.....	H-55280	Air Filter Secondary.....	A-5559	Fuel Filter Secondary.....	FC-55151
Oil Filter Full Flow.....	C-5516	Fuel Filter.....	F-5505	Oil Filter Full Flow.....	C-5510
589 (PIPE LAYERS) CAT 3408 TA (S/N: 9BA1-UP)		Fuel Filter Secondary.....	FC-5507	613 (SCRAPERS)	
Air Filter Primary.....	A-5521	Hydraulic Oil Filter.....	H-55270	Hydraulic Oil Filter.....	H-55320
Air Filter Set.....	A-5521-S	Hydraulic Oil Filter.....	H-5504	613 (SCRAPERS) S/N: 71M1-1377	
589 (PIPE LAYERS) S/N: 31Z1-UP		Hydraulic Oil Filter.....	H-5509	Air Filter Set.....	A-5549M-S
Air Filter Set.....	A-5521-S	Oil Filter Full Flow.....	C-5510	Air Filter Set.....	A-5522-S
Air Filter Primary.....	A-5561	611 (SCRAPERS) CAT 3306 (S/N: 7WZ1-UP)		Air Filter Primary.....	A-5549M
Air Filter Set.....	A-5562-S	Air Filter Secondary.....	A-5559	Air Filter Primary.....	A-5509
Air Filter Primary.....	A-5521	Air Filter Primary.....	A-5558	Air Filter Primary.....	A-5549
Air Filter Secondary.....	A-5560	Fuel Filter.....	F-5505	Air Filter Secondary.....	A-5510
Air Filter Secondary.....	A-5552	Fuel Filter Secondary.....	FC-5507	Air Filter Set.....	A-5549M-S
Fuel Filter.....	F-5505	Hydraulic Oil Filter.....	H-5504	Air Filter Set.....	A-5522-S
Hydraulic Oil Filter.....	H-5504	Hydraulic Oil Filter.....	H-5509	Air Filter Primary.....	A-5509
Hydraulic Oil Filter.....	H-55270	Hydraulic Oil Filter.....	H-55270	Air Filter Secondary.....	A-5550
Hydraulic Oil Filter.....	H-5509	Oil Filter Full Flow.....	C-5510	Air Filter Primary.....	A-5549M
Oil Filter Full Flow.....	C-5516	613C (SCRAPERS) CAT 3208 (S/N: 92X1-UP)		Fuel Filter Secondary.....	FC-5507
591 (PIPE LAYERS)		Air Filter Set.....	A-5544-S	Hydraulic Oil Filter.....	H-5503
Fuel Filter.....	FC-5519	Air Filter Primary.....	A-5543	Hydraulic Oil Filter.....	H-5504
Hydraulic Oil Filter.....	H-5504	Fuel Filter Secondary.....	FC-5507	Oil Filter Full Flow.....	C-5504
Oil Filter Full Flow.....	C-5516	Fuel Filter.....	F-5505	613 (SCRAPERS) S/N: 71M1378-UP	
594 (PIPE LAYERS) S/N: 62H1-UP		Hydraulic Oil Filter.....	H-5504	Air Filter Primary.....	A-5549
Air Filter Primary.....	A-5557	Hydraulic Oil Filter.....	H-5509	Air Filter Secondary.....	A-5510
Air Filter Secondary.....	A-5526	Oil Filter Full Flow.....	C-5510	Air Filter Set.....	A-5549M-S
Air Filter Set.....	A-5557-S	613C (SCRAPERS) CAT 3208 (S/N: 93X1-UP)		Air Filter Set.....	A-5522-S
Fuel Filter.....	F-5501	Air Filter Set.....	A-5544-S	Air Filter Primary.....	A-5509
Hydraulic Oil Filter.....	H-5503	Air Filter Primary.....	A-5543	Air Filter Secondary.....	A-5550
Oil Filter Full Flow.....	O-5503	Fuel Filter Secondary.....	FC-5507	Air Filter Primary.....	A-5549M
594G (PIPE LAYERS) S/N: 62H1-UP		Fuel Filter.....	F-5505	Fuel Filter Secondary.....	FC-5507
Air Filter Primary.....	A-5557	Hydraulic Oil Filter.....	H-5504	Hydraulic Oil Filter.....	H-5503
Air Filter Secondary.....	A-5526	Hydraulic Oil Filter.....	H-5509	Hydraulic Oil Filter.....	H-5504
Air Filter Set.....	A-5557-S	Oil Filter Full Flow.....	C-5510	Oil Filter Full Flow.....	C-5504
Fuel Filter.....	F-5501	613C SERIES II (SCRAPERS) CAT 3116T (S/N: 8LJ1-UP)		613 (SCRAPERS) S/N: 72M1-4267	
Hydraulic Oil Filter.....	H-5503	Air Filter Primary.....	A-5543	Air Filter Primary.....	A-5549
Oil Filter Full Flow.....	O-5503	Air Filter Secondary.....	A-5559	Air Filter Set.....	A-5549M-S
594H (PIPE LAYERS) S/N: 96V1-UP		Air Filter Primary.....	A-5558	Air Filter Secondary.....	A-5550
Air Filter Set.....	A-5555-S	Air Filter Secondary.....	A-5558	Air Filter Primary.....	A-5549M
Air Filter Secondary.....	A-5529	Air Filter Set.....	A-5544-S	613B (SCRAPERS)	
Air Filter Primary.....	A-5555	Fuel Filter Secondary.....	FC-5515	Hydraulic Oil Filter.....	H-55320
Air Filter Secondary.....	A-5556	Fuel Filter Secondary.....	FC-55151	613B (SCRAPERS) S/N: 38W1-UP	
594H (PIPE LAYERS) S/N: 96V1-UP		Fuel Filter.....	FC-5516	Air Filter Primary.....	A-5549
Air Filter Set.....	A-5555-S	Hydraulic Oil Filter.....	H-5504	Air Filter Secondary.....	A-5510
Air Filter Secondary.....	A-5529	Hydraulic Oil Filter.....	H-55280	Air Filter Secondary.....	A-5550
Air Filter Primary.....	A-5555	Hydraulic Oil Filter.....	H-5503	Air Filter Set.....	A-5549M-S
Air Filter Secondary.....	A-5556	Hydraulic Oil Filter.....	H-55270	Air Filter Set.....	A-5522-S

Sakura Filter

ENGINE APPLICATION

MODEL/APPLICATION	SAKURA NO	MODEL/APPLICATION	SAKURA NO	MODEL/APPLICATION	SAKURA NO
CATERPILLAR		CATERPILLAR		CATERPILLAR	
621B (SCRAPERS) S/N: 2DB1-UP		621B (SCRAPERS) S/N: 9AC1-UP		Hydraulic Oil Filter.....	H-55320
Hydraulic Oil Filter.....	H-55270	Fuel Filter.....	F-5505	621F (SCRAPERS) S/N: 4SK1-UP	
Hydraulic Oil Filter.....	H-5504	Fuel Filter.....	FC-5509	Hydraulic Oil Filter.....	H-5504
Hydraulic Oil Filter.....	H-5509	Hydraulic Oil Filter.....	H-55270	Oil Filter Full Flow.....	C-5516
Oil Filter Full Flow.....	C-5516	Hydraulic Oil Filter.....	H-5504	621F (SCRAPERS) S/N: 5JK1-UP	
621B (SCRAPERS) S/N: 2GB1-UP		Hydraulic Oil Filter.....	H-5509	Air Filter Secondary.....	A-5502
Fuel Filter Secondary.....	FC-5507	Oil Filter Full Flow.....	C-5516	621F (SCRAPERS) S/N: 8PL1-UP	
621B (SCRAPERS) S/N: 31V1-UP		621 E (SCRAPERS) S/N: 2PD1011-UP		Air Filter Secondary.....	A-5502
Fuel Filter Secondary.....	FC-5507	Air Filter Primary.....	A-5535	621F (SCRAPERS) S/N: 9NL1-UP	
621B (SCRAPERS) S/N: 35V1-UP		Air Filter Set.....	A-5573-S	Air Filter Secondary.....	A-5502
Fuel Filter Secondary.....	FC-5507	Air Filter Primary.....	A-5501	621F (SCRAPERS) S/N: 9NL1-UP	
621B (SCRAPERS) S/N: 36V1-UP		Air Filter.....	A-5547	Air Filter Secondary.....	A-5502
Fuel Filter Secondary.....	FC-5507	Air Filter Secondary.....	A-5502	621F (SCRAPERS) w/3406, 3406C Eng.	
621B (SCRAPERS) S/N: 45P1-UP		Air Filter Secondary.....	A-5534	Air Filter Primary.....	A-5535M
Air Filter Primary.....	A-5501	621 E (SCRAPERS) S/N: 2PD1-686		Air Filter Set.....	A-5573M-S
Air Filter Secondary.....	A-5534	Air Filter.....	A-5547	Hydraulic Oil Filter.....	H-55320
Air Filter Secondary.....	A-5502	621 E (SCRAPERS) S/N: 2PD1-437		621F BZ (SCRAPERS) CAT 3406 (S/N: 8PL1-UP)	
Air Filter Primary.....	A-5535	Fuel Filter Secondary.....	FC-5507	Air Filter Set.....	A-5573-S
Air Filter Set.....	A-5573-S	Hydraulic Oil Filter.....	H-5504	Air Filter Primary.....	A-5535
Fuel Filter Secondary.....	FC-5507	Oil Filter Full Flow.....	C-5516	Air Filter Secondary.....	A-5534
Fuel Filter.....	FC-5519	621 E (SCRAPERS) S/N: 2PD687-1010		Fuel Filter.....	FC-5509
Hydraulic Oil Filter.....	H-5509	Air Filter.....	A-5547	Hydraulic Oil Filter.....	H-5504
Hydraulic Oil Filter.....	H-5504	621 E (SCRAPERS) S/N: 6AB1-905		Hydraulic Oil Filter.....	H-5509
Oil Filter Full Flow.....	C-5516	Air Filter Primary.....	A-5501	Oil Filter Full Flow.....	C-5516
621B (SCRAPERS) S/N: 6XB1-UP		Air Filter Secondary.....	A-5502	621F BZ (SCRAPERS) CAT 3406 (S/N: 9NL1-UP)	
Fuel Filter.....	F-5505	Air Filter.....	A-5547	Air Filter Primary.....	A-5535
Fuel Filter.....	FC-5509	Hydraulic Oil Filter.....	H-5509	Air Filter Set.....	A-5573-S
Hydraulic Oil Filter.....	H-5504	621 E (SCRAPERS) S/N: 6AB1-UP		Air Filter Secondary.....	A-5534
Hydraulic Oil Filter.....	H-5509	Air Filter Set.....	A-5573-S	Fuel Filter.....	FC-5509
Hydraulic Oil Filter.....	H-55270	Air Filter Secondary.....	A-5534	Hydraulic Oil Filter.....	H-5509
Oil Filter Full Flow.....	C-5516	Air Filter Primary.....	A-5535	Hydraulic Oil Filter.....	H-5504
621B (SCRAPERS) S/N: 73V1-UP		Fuel Filter Secondary.....	FC-5507	Oil Filter Full Flow.....	C-5516
Fuel Filter Secondary.....	FC-5507	Hydraulic Oil Filter.....	H-5504	621F BZ (SCRAPERS) CAT 3406C (S/N: 8PL1-UP)	
621B (SCRAPERS) S/N: 7KC1-UP		Oil Filter Full Flow.....	C-5516	Air Filter Set.....	A-5573-S
Fuel Filter.....	F-5505	621 E (SCRAPERS) S/N: 6BB1-UP		Air Filter Primary.....	A-5535
Fuel Filter.....	FC-5509	Air Filter Set.....	A-5573-S	Air Filter Secondary.....	A-5534
Hydraulic Oil Filter.....	H-5509	Air Filter Primary.....	A-5535	Fuel Filter.....	FC-5509
Hydraulic Oil Filter.....	H-55270	Air Filter Primary.....	A-5501	Hydraulic Oil Filter.....	H-5504
Hydraulic Oil Filter.....	H-5504	Air Filter Secondary.....	A-5534	Hydraulic Oil Filter.....	H-5509
Oil Filter Full Flow.....	C-5516	Air Filter Secondary.....	A-5502	Oil Filter Full Flow.....	C-5516
621B (SCRAPERS) S/N: 8HC1-UP		Fuel Filter.....	FC-5519	621F BZ (SCRAPERS) CAT 3406C (S/N: 9NL1-UP)	
Fuel Filter.....	F-5505	Fuel Filter.....	FC-5509	Air Filter Primary.....	A-5535
Fuel Filter.....	FC-5509	Hydraulic Oil Filter.....	H-5509	Air Filter Set.....	A-5573-S
Hydraulic Oil Filter.....	H-5504	Hydraulic Oil Filter.....	H-5504	Air Filter Secondary.....	A-5534
Hydraulic Oil Filter.....	H-5509	Oil Filter Full Flow.....	C-5516	Fuel Filter.....	FC-5509
Hydraulic Oil Filter.....	H-55270	621 E (SCRAPERS) w/3406 Eng.		Hydraulic Oil Filter.....	H-5509
Oil Filter Full Flow.....	C-5516	Air Filter Set.....	A-5573M-S	Hydraulic Oil Filter.....	H-5504
		Air Filter Primary.....	A-5535M	Oil Filter Full Flow.....	C-5516
				621F US (SCRAPERS) CAT 3406 (S/N: 4SK1-UP)	

MODEL/APPLICATION	SAKURA NO
CATERPILLAR	
621F US (SCRAPERS) CAT 3406 (S/N: 4SK1-UP)	
Air Filter Secondary.....	A-5502
Air Filter Primary.....	A-5501
Fuel Filter.....	FC-5509
Hydraulic Oil Filter.....	H-5504
Hydraulic Oil Filter.....	H-5509
Oil Filter Full Flow.....	C-5516
621F US (SCRAPERS) CAT 3406 (S/N: 5JK1-UP)	
Air Filter Secondary.....	A-5502
Air Filter Primary.....	A-5501
Fuel Filter.....	FC-5509
Hydraulic Oil Filter.....	H-5509
Hydraulic Oil Filter.....	H-5504
Oil Filter Full Flow.....	C-5516
621F US (SCRAPERS) CAT 3406C (S/N: 4SK1-UP)	
Air Filter Secondary.....	A-5502
Air Filter Primary.....	A-5501
Fuel Filter.....	FC-5509
Hydraulic Oil Filter.....	H-5504
Hydraulic Oil Filter.....	H-5509
Oil Filter Full Flow.....	C-5516
621F US (SCRAPERS) CAT 3406C (S/N: 5JK1-UP)	
Air Filter Secondary.....	A-5502
Air Filter Primary.....	A-5501
Fuel Filter.....	FC-5509
Hydraulic Oil Filter.....	H-5509
Hydraulic Oil Filter.....	H-5504
Oil Filter Full Flow.....	C-5516
621S (SCRAPERS) S/N: 1TE1-UP	
Hydraulic Oil Filter.....	H-5504
Hydraulic Oil Filter.....	H-55270
621S (SCRAPERS) w/3306 Eng.	
Hydraulic Oil Filter.....	H-55320
623G (SCRAPERS) CAT (S/N: BET1-UP)	
Oil Filter Full Flow.....	C-5516
623G (SCRAPERS) CAT (S/N: LHX1-UP)	
Fuel Filter.....	FC-5517
Hydraulic Oil Filter.....	H-55270
623G (SCRAPERS) S/N: 6PY1-UP	
Hydraulic Oil Filter.....	H-5504
Hydraulic Oil Filter.....	H-55270
623G (SCRAPERS) S/N: ARW1-UP	
Air Filter Secondary.....	A-5560
Air Filter Set.....	A-5562-S
Air Filter Primary.....	A-5561
Fuel Filter.....	FC-5509
Fuel/Water Separator Secondary..	SFC-5504-10B

MODEL/APPLICATION	SAKURA NO
CATERPILLAR	
Fuel/Water Separator Secondary...	SFC-5504-10
Hydraulic Oil Filter.....	H-5509
Hydraulic Oil Filter.....	HC-55300
623G (SCRAPERS) S/N: CES1-UP	
Air Filter Set.....	A-5562-S
Air Filter Primary.....	A-5561
Air Filter Secondary.....	A-5560
Cabin Air Filter.....	CA-55060
Fuel Filter.....	FC-5509
Hydraulic Oil Filter.....	HC-55300
Hydraulic Oil Filter.....	H-5509
623G (SCRAPERS) S/N: DBC1-UP	
Air Filter Secondary.....	A-5560
Air Filter Primary.....	A-5561
Air Filter Set.....	A-5562-S
Cabin Air Filter.....	CA-55060
Hydraulic Oil Filter.....	HC-55300
Hydraulic Oil Filter.....	H-5509
623G (SCRAPERS) w/3406E Eng.	
Hydraulic Oil Filter.....	H-55320
623B (SCRAPERS)	
Air Filter Set.....	A-44150-S
Air Filter Primary.....	A-44150
Hydraulic Oil Filter.....	H-55320
623B (SCRAPERS) S/N: 46P1-UP	
Air Filter Primary.....	A-5535
Air Filter Set.....	A-5573-S
Air Filter Primary.....	A-5501
Air Filter Secondary.....	A-5502
Air Filter Secondary.....	A-5534
Fuel Filter.....	FC-5519
Fuel Filter.....	FC-5509
Hydraulic Oil Filter.....	H-5509
Hydraulic Oil Filter.....	H-5504
Oil Filter Full Flow.....	C-5516
623E (SCRAPERS) S/N: 5SG1-477	
Air Filter Secondary.....	A-5502
Hydraulic Oil Filter.....	H-5504
Oil Filter Full Flow.....	C-5516
623E (SCRAPERS) S/N: 6CB1-UP	
Air Filter Secondary.....	A-5502
Air Filter Secondary.....	A-5534
Air Filter Primary.....	A-5535
Air Filter Set.....	A-5573-S
Hydraulic Oil Filter.....	H-5504
Oil Filter Full Flow.....	C-5516
623E (SCRAPERS) S/N: 6DB1-UP	
Air Filter Primary.....	A-5535
Air Filter Set.....	A-5573-S
Air Filter Secondary.....	A-5502

MODEL/APPLICATION	SAKURA NO
CATERPILLAR	
Air Filter Primary.....	A-5501
Air Filter Secondary.....	A-5534
Fuel Filter.....	FC-5519
Fuel Filter.....	FC-5509
Hydraulic Oil Filter.....	H-5509
Hydraulic Oil Filter.....	H-5504
Oil Filter Full Flow.....	C-5516
623E (SCRAPERS) S/N: 6YF1-UP	
Air Filter Secondary.....	A-5534
Air Filter Secondary.....	A-5502
Air Filter Primary.....	A-5535
Air Filter Set.....	A-5573-S
Fuel Filter.....	FC-5509
Hydraulic Oil Filter.....	H-5504
Oil Filter Full Flow.....	C-5516
623E (SCRAPERS) w/3406, 3406C Engs.	
Air Filter Primary.....	A-5535M
Air Filter Set.....	A-5573M-S
Hydraulic Oil Filter.....	H-55320
623F (SCRAPERS) w/3406, 3406C Engs.	
Air Filter Primary.....	A-5535M
Air Filter Set.....	A-5573M-S
Hydraulic Oil Filter.....	H-55320
623 (SCRAPERS) S/N: 52U1-UP	
Air Filter Primary.....	A-5558
Air Filter Set.....	A-5544-S
Air Filter Secondary.....	A-5559
Air Filter Primary.....	A-5543
Air Filter Secondary.....	A-5520
Fuel Filter.....	F-5501
Hydraulic Oil Filter.....	H-5504
Hydraulic Oil Filter.....	H-5509
Oil Filter Full Flow.....	O-5502
624F (LOADERS) S/N: 4YN-UP	
Air Filter Set.....	A-5568-S
Air Filter Primary.....	A-5566
Air Filter Secondary.....	A-5567
Fuel Filter Secondary.....	FC-5515
Fuel Filter.....	F-5505
Fuel Filter Secondary.....	FC-55151
Fuel Filter.....	FC-5516
Hydraulic Oil Filter.....	H-5506
Hydraulic Oil Filter.....	HC-5504
Oil Filter Full Flow.....	C-5510
Oil Filter Full Flow.....	C-5505
624F (LOADERS) S/N: 5NN-UP	
Air Filter Primary.....	A-5566
Air Filter Set.....	A-5568-S
Air Filter Secondary.....	A-5567
Fuel Filter.....	F-5505
Fuel Filter Secondary.....	FC-55151
Fuel Filter.....	FC-5516

MODEL/APPLICATION	SAKURA NO	MODEL/APPLICATION	SAKURA NO	MODEL/APPLICATION	SAKURA NO
CATERPILLAR		CATERPILLAR		CATERPILLAR	
624F (LOADERS) S/N: 5NN-UP Fuel Filter Secondary..... FC-5515 Hydraulic Oil Filter..... H-5506 Hydraulic Oil Filter..... HC-5504 Oil Filter Full Flow..... C-5510 Oil Filter Full Flow..... C-5505		627F (SCRAPERS) CAT (S/N: 08Z72000-89611-UP) Fuel Filter Secondary..... FC-5507 Oil Filter Full Flow..... C-5510 627F (SCRAPERS) CAT (S/N: 08Z89612-UP) Fuel Filter Secondary..... FC-5507 Oil Filter Full Flow..... C-5522 627F (SCRAPERS) CAT (S/N: 11N7400-UP) Oil Filter Full Flow..... C-5516 627F (SCRAPERS) CAT (S/N: 41Z1-UP) Fuel Filter..... FC-5509 Fuel Filter..... FC-5519 627F (SCRAPERS) CAT (S/N: 6NC1-UP) Fuel Filter Secondary..... FC-5507 Fuel Filter..... FC-5509 Oil Filter Full Flow..... C-5516 Oil Filter Full Flow..... C-5522 627F (SCRAPERS) S/N: 1DL1-UP Air Filter Secondary..... A-5534 Air Filter Set..... A-5573-S Air Filter Primary..... A-5535 Hydraulic Oil Filter..... HC-5503 Hydraulic Oil Filter..... H-5509 Hydraulic Oil Filter..... HC-5512 Hydraulic Oil Filter..... HC-5506 627F (SCRAPERS) S/N: 1WE2000-UP Hydraulic Oil Filter..... H-55270 Hydraulic Oil Filter..... H-5504 627F (SCRAPERS) S/N: 2YK1-243-UP Air Filter Primary..... A-5543 Air Filter Set..... A-5544-S 627F (SCRAPERS) S/N: 3GB900-UP Hydraulic Oil Filter..... H-55270 627F (SCRAPERS) S/N: 3JB500-UP Hydraulic Oil Filter..... H-55270 627F (SCRAPERS) S/N: 4RY489-UP Hydraulic Oil Filter..... H-55270 Hydraulic Oil Filter..... H-5504 627F (SCRAPERS) S/N: 4YK244-UP Air Filter Primary..... A-5561 Air Filter Set..... A-5562-S Air Filter Secondary..... A-5560 627F (SCRAPERS) w/3406E Eng. Hydraulic Oil Filter..... H-55320 627G (SCRAPERS) w/C9 Eng. Air Filter Set..... A-5573M-S Air Filter Primary..... A-5535M		Air Filter Set..... A-5573M-S Air Filter Primary..... A-5535M Hydraulic Oil Filter..... H-55320 627B (SCRAPERS) Air Filter Set..... A-44150-S Air Filter Primary..... A-44150 627B (SCRAPERS) S/N: 37V1-UP Air Filter Primary..... A-5558 Air Filter Secondary..... A-5559 Fuel Filter Secondary..... FC-5507 Hydraulic Oil Filter..... H-5504 Oil Filter Full Flow..... C-5510 627B (SCRAPERS) S/N: 38V1-UP Air Filter Primary..... A-5558 Air Filter Secondary..... A-5559 Fuel Filter Secondary..... FC-5507 Hydraulic Oil Filter..... H-5504 Oil Filter Full Flow..... C-5510 627B (SCRAPERS) w/3306 Eng. Hydraulic Oil Filter..... H-55320 627E (SCRAPERS) CAT 3406 (S/N: 6EB1-UP) Air Filter Primary..... A-5501 Air Filter Primary..... A-5543 Air Filter Set..... A-5544-S Air Filter..... A-5547 Fuel Filter..... F-5505 Fuel Filter Secondary..... FC-5507 Hydraulic Oil Filter..... H-5509 Hydraulic Oil Filter..... H-5504 Oil Filter Full Flow..... C-5516 627E (SCRAPERS) CAT 3406 (S/N: 6FB1-UP) Air Filter..... A-5547 Air Filter Set..... A-5544-S Air Filter Primary..... A-5501 Air Filter Primary..... A-5543 Fuel Filter Secondary..... FC-5507 Fuel Filter..... F-5505 Hydraulic Oil Filter..... H-5504 Hydraulic Oil Filter..... H-5509 Oil Filter Full Flow..... C-5516 627E (SCRAPERS) CAT 3406 (S/N: 6GB1-UP) Air Filter..... A-5547 Air Filter Set..... A-5544-S Air Filter Primary..... A-5501 Air Filter Primary..... A-5543 Fuel Filter..... F-5505 Fuel Filter Secondary..... FC-5507 Hydraulic Oil Filter..... H-5504 Hydraulic Oil Filter..... H-5509 Oil Filter Full Flow..... C-5516	

MODEL/APPLICATION	SAKURA NO
CATERPILLAR	
627E (SCRAPERS) w/3306 Eng. Hydraulic Oil Filter.....	H-55320
627E (SCRAPERS) w/3406 Eng. Air Filter Primary..... Air Filter Set..... Hydraulic Oil Filter.....	A-5535M A-5573M-S H-55320
627 (SCRAPERS) Fuel Filter.....	F-5503
627 (SCRAPERS) S/N: 1451-UP Air Filter Secondary..... Air Filter Primary..... Hydraulic Oil Filter..... Hydraulic Oil Filter..... Oil Filter Full Flow.....	A-5502 A-5501 H-5509 H-5504 C-5510
627 (SCRAPERS) S/N: 1551-UP Air Filter Primary..... Air Filter Secondary..... Hydraulic Oil Filter..... Hydraulic Oil Filter..... Oil Filter Full Flow.....	A-5501 A-5502 H-5509 H-5504 C-5510
627 (SCRAPERS) S/N: 50K1-UP Fuel Filter Secondary..... Oil Filter Full Flow.....	FC-5507 C-5510
627 (SCRAPERS) S/N: 54K1451-UP Air Filter Set..... Air Filter Primary..... Air Filter Secondary..... Air Filter Primary..... Air Filter Primary..... Air Filter Secondary..... Air Filter Set..... Fuel Filter Secondary..... Hydraulic Oil Filter..... Hydraulic Oil Filter..... Oil Filter Full Flow.....	A-5522-S A-5509 A-5510 A-5549M A-5549 A-5550 A-5549M-S FC-5507 H-5504 H-5503 C-5510
627 (SCRAPERS) S/N: 54K1-736 Air Filter Secondary..... Air Filter Primary..... Air Filter Primary..... Air Filter Secondary..... Air Filter Primary..... Air Filter Set..... Air Filter Set..... Fuel Filter Secondary..... Hydraulic Oil Filter..... Hydraulic Oil Filter..... Oil Filter Full Flow.....	A-5510 A-5509 A-5549 A-5550 A-5549M A-5522-S A-5549M-S FC-5507 H-5503 H-5504 0-5502
627 (SCRAPERS) S/N: 54K737-888 Air Filter Secondary..... Air Filter Primary..... Air Filter Primary..... Air Filter Secondary..... Air Filter Primary..... Air Filter Set..... Air Filter Set..... Fuel Filter Secondary..... Hydraulic Oil Filter..... Hydraulic Oil Filter..... Oil Filter Full Flow.....	A-5510 A-5509 A-5549 A-5550 A-5549M A-5522-S A-5549M-S FC-5507 H-5503 H-5504 C-5510

MODEL/APPLICATION	SAKURA NO
CATERPILLAR	
Air Filter Secondary..... Air Filter Set..... Air Filter Set..... Air Filter Secondary..... Air Filter Primary..... Air Filter Primary..... Air Filter Primary..... Fuel Filter Secondary..... Hydraulic Oil Filter..... Hydraulic Oil Filter..... Oil Filter Full Flow.....	A-5550 A-5549M-S A-5522-S A-5510 A-5549M A-5509 A-5549 FC-5507 H-5503 H-5504 C-5510
627 (SCRAPERS) S/N: 54K889-1450 Air Filter Set..... Air Filter Secondary..... Air Filter Set..... Air Filter Primary..... Air Filter Secondary..... Air Filter Primary..... Air Filter Primary..... Fuel Filter Secondary..... Hydraulic Oil Filter..... Oil Filter Full Flow.....	A-5522-S A-5510 A-5549M-S A-5549M A-5550 A-5549 A-5509 FC-5507 H-5503 C-5510
627 (SCRAPERS) S/N: 68M1551-UP Air Filter Secondary..... Air Filter Secondary..... Air Filter Primary..... Air Filter Set..... Air Filter Primary..... Fuel Filter Secondary..... Hydraulic Oil Filter..... Oil Filter Full Flow.....	A-5534 A-5502 A-5535 A-5573-S A-5501 FC-5507 H-5504 C-5510
627 (SCRAPERS) S/N: 68M1-650 Air Filter Secondary..... Air Filter Primary..... Air Filter Set..... Air Filter Primary..... Air Filter Secondary..... Air Filter Set..... Air Filter Primary..... Fuel Filter Secondary..... Hydraulic Oil Filter..... Hydraulic Oil Filter..... Oil Filter Full Flow.....	A-5550 A-5549 A-5549M-S A-5549M A-5510 A-5522-S A-5509 FC-5507 H-5503 H-5504 0-5502
627 (SCRAPERS) S/N: 68M651-878 Air Filter Secondary..... Air Filter Secondary..... Air Filter Primary..... Air Filter Set..... Air Filter Set..... Air Filter Primary..... Air Filter Primary..... Fuel Filter Secondary..... Hydraulic Oil Filter..... Hydraulic Oil Filter..... Oil Filter Full Flow.....	A-5550 A-5510 A-5549M A-5549M-S A-5522-S A-5549 A-5509 FC-5507 H-5503 H-5504 C-5510

MODEL/APPLICATION	SAKURA NO
CATERPILLAR	
627 (SCRAPERS) S/N: 68M879-1550 Air Filter Set..... Air Filter Secondary..... Air Filter Secondary..... Air Filter Primary..... Air Filter Primary..... Fuel Filter Secondary..... Oil Filter Full Flow.....	A-5573-S A-5502 A-5534 A-5535 A-5501 FC-5507 C-5510
627 (SCRAPERS) S/N: 69M1-UP Fuel Filter Secondary..... Oil Filter Full Flow.....	FC-5507 C-5510
627B TR (SCRAPERS) S/N: 1551-UP Air Filter Primary..... Air Filter Set..... Air Filter Secondary..... Air Filter Secondary..... Air Filter Primary..... Fuel Filter Secondary..... Hydraulic Oil Filter..... Oil Filter Full Flow.....	A-5535 A-5573-S A-5534 A-5502 A-5501 FC-5507 H-5504 C-5510
627E PS (SCRAPERS) S/N: 6EB1-UP Air Filter Primary..... Fuel Filter Secondary..... Fuel Filter..... Fuel Filter..... Hydraulic Oil Filter..... Hydraulic Oil Filter..... Hydraulic Oil Filter..... Oil Filter Full Flow..... Oil Filter Full Flow.....	A-5501 FC-5507 FC-5509 F-5505 H-5509 H-55270 H-5504 C-5516 C-5510
627E PS (SCRAPERS) S/N: 6FB1-UP Air Filter Primary..... Air Filter Set..... Fuel Filter Secondary..... Fuel Filter..... Hydraulic Oil Filter..... Hydraulic Oil Filter..... Oil Filter Full Flow..... Oil Filter Full Flow.....	A-5543 A-5544-S FC-5507 F-5505 H-5504 H-55270 C-5510 C-5516
627E PS (SCRAPERS) S/N: 6GB1-UP Air Filter Primary..... Fuel Filter..... Fuel Filter..... Fuel Filter Secondary..... Hydraulic Oil Filter..... Hydraulic Oil Filter..... Oil Filter Full Flow..... Oil Filter Full Flow.....	A-5501 FC-5509 F-5505 FC-5507 H-5509 H-55270 C-5510 C-5516
627E PS (SCRAPERS) S/N: 6HB1-UP Air Filter Primary.....	A-5543

MODEL/APPLICATION	SAKURA NO	MODEL/APPLICATION	SAKURA NO	MODEL/APPLICATION	SAKURA NO
CATERPILLAR		CATERPILLAR		CATERPILLAR	
627E PS (SCRAPERS) S/N: 6HB1-UP Air Filter Set..... A-5544-S Fuel Filter Secondary..... FC-5507 Fuel Filter..... F-5505 Hydraulic Oil Filter..... H-5504 Hydraulic Oil Filter..... H-55270 Oil Filter Full Flow..... C-5516 Oil Filter Full Flow..... C-5510		631D (SCRAPERS) S/N: 66W1-UP Air Filter Secondary..... A-5529 Hydraulic Oil Filter..... H-5504 Oil Filter Full Flow..... C-5516 631D (SCRAPERS) S/N: 68W1-UP Air Filter Secondary..... A-5529 631D (SCRAPERS) w/3408 Eng. Hydraulic Oil Filter..... H-55320 631E II (SCRAPERS) CAT (S/N: 48W19968-UP) Oil Filter Full Flow..... C-5516 631E II (SCRAPERS) CAT (S/N: 99C1-UP) Fuel Filter..... FC-5509 Fuel/Water Separator Secondary... SFC-5504-10 Fuel/Water Separator Secondary.. SFC-5504-10B 631E II (SCRAPERS) S/N: 1AB1446-1509-UP Air Filter Secondary..... A-5552 Air Filter Set..... A-5521-S Air Filter Primary..... A-5521 Air Filter..... A-5547 Hydraulic Oil Filter..... HC-5506 Hydraulic Oil Filter..... HC-55310 Hydraulic Oil Filter..... HC-5503 Hydraulic Oil Filter..... H-5509 Hydraulic Oil Filter..... HC-5512 631E II (SCRAPERS) S/N: 1AB1510-1575-UP Air Filter Set..... A-5521-S Air Filter Secondary..... A-5552 Air Filter..... A-5547 Air Filter Primary..... A-5521 Hydraulic Oil Filter..... HC-5512 Hydraulic Oil Filter..... HC-55310 Hydraulic Oil Filter..... H-5509 Hydraulic Oil Filter..... HC-5503 Hydraulic Oil Filter..... HC-5506 631E II (SCRAPERS) S/N: 1AB1576-1639-UP Air Filter Set..... A-5562-S Air Filter Secondary..... A-5560 Air Filter Primary..... A-5561 Air Filter..... A-5547 Hydraulic Oil Filter..... HC-55310 Hydraulic Oil Filter..... HC-5506 Hydraulic Oil Filter..... HC-5503 Hydraulic Oil Filter..... H-5509 Hydraulic Oil Filter..... HC-5512 631E II (SCRAPERS) S/N: 1AB1640-UP Air Filter Secondary..... A-5560 Air Filter Set..... A-5562-S Air Filter..... A-5547	Air Filter Primary..... A-5561 Hydraulic Oil Filter..... HC-55310 Hydraulic Oil Filter..... H-5509 Hydraulic Oil Filter..... HC-5512 Hydraulic Oil Filter..... HC-5506 Hydraulic Oil Filter..... HC-5503 631E II (SCRAPERS) S/N: 1AB1-855-UP Air Filter Secondary..... A-5552 Air Filter..... A-5547 Air Filter Primary..... A-5521 Air Filter Set..... A-5521-S Hydraulic Oil Filter..... H-5509 631E II (SCRAPERS) S/N: 1AB856-1445-UP Air Filter Set..... A-5521-S Air Filter..... A-5547 Air Filter Secondary..... A-5552 Air Filter Primary..... A-5521 Hydraulic Oil Filter..... H-5509 631E II (SCRAPERS) S/N: 1BB1540-UP Oil Filter Full Flow..... C-5516 631E II (SCRAPERS) S/N: 1NB1-1389-UP Air Filter Secondary..... A-5552 Air Filter..... A-5547 Air Filter Set..... A-5521-S Air Filter Primary..... A-5521 631E II (SCRAPERS) S/N: 1NB1390-UP Air Filter Set..... A-5562-S Air Filter Primary..... A-5521 Air Filter Secondary..... A-5560 Air Filter Secondary..... A-5552 Air Filter Set..... A-5521-S Air Filter Primary..... A-5561 Air Filter..... A-5547 631E II (SCRAPERS) S/N: 3ND1-UP Air Filter..... A-5547 Air Filter Primary..... A-5521 Air Filter Set..... A-5521-S Air Filter Secondary..... A-5552 631E II (SCRAPERS) S/N: 3TE1-UP Hydraulic Oil Filter..... H-5504 Hydraulic Oil Filter..... H-55270 631E II (SCRAPERS) S/N: 8TA1-UP Hydraulic Oil Filter..... H-55270 Hydraulic Oil Filter..... H-5504 631E II (SCRAPERS) S/N: 9PE1-UP Hydraulic Oil Filter..... H-55270 Hydraulic Oil Filter..... H-5504		
630 (SCRAPERS) S/N: 52F-52F Fuel Filter..... F-5501 Hydraulic Oil Filter..... H-5503 Oil Filter Full Flow..... 0-5503					
630B (SCRAPERS) S/N: 14G1-UP Air Filter Secondary..... A-5559 Air Filter Primary..... A-5543 Air Filter Secondary..... A-5520 Air Filter Primary..... A-5558 Air Filter Set..... A-5544-S Fuel Filter..... F-5501 Hydraulic Oil Filter..... H-5503 Oil Filter Full Flow..... 0-5503					
631 (SCRAPERS) S/N: 51F-UP Fuel Filter..... F-5501 Hydraulic Oil Filter..... H-5503 Oil Filter Full Flow..... 0-5503					
631 (SCRAPERS) S/N: 67M1-UP Air Filter Set..... A-5557-S Air Filter Secondary..... A-5526 Air Filter Primary..... A-5557 Hydraulic Oil Filter..... H-5504 Hydraulic Oil Filter..... H-5509 Oil Filter Full Flow..... 0-5503					
631D (SCRAPERS) S/N: 24W1-UP Air Filter Primary..... A-5555 Air Filter Primary..... A-5521 Air Filter Set..... A-5521-S Air Filter Set..... A-5555-S Air Filter Secondary..... A-5556 Air Filter Secondary..... A-5529 Fuel Filter..... FC-5509 Hydraulic Oil Filter..... H-5504 Oil Filter Full Flow..... C-5516					
631D (SCRAPERS) S/N: 28W1-UP Air Filter Secondary..... A-5529					
631D (SCRAPERS) S/N: 29W1-UP Air Filter Secondary..... A-5529					
631D (SCRAPERS) S/N: 39W1-UP Air Filter Secondary..... A-5529					

MODEL/APPLICATION	SAKURA NO
-------------------	-----------

CATERPILLAR

631G
(SCRAPERS)
CAT S/N: 5XD1-UP , 2007-UP

Air Filter Set.....	A-5565-S
Air Filter Secondary.....	A-5563
Air Filter Primary.....	A-5564
Fuel Filter.....	FC-5509
Fuel/Water Separator Secondary..	SFC-5504-10B
Fuel/Water Separator Secondary..	SFC-5504-10
Hydraulic Oil Filter.....	HC-5512
Hydraulic Oil Filter.....	HC-5506
Hydraulic Oil Filter.....	HC-5503

631G
(SCRAPERS)
CAT S/N: AWK1-UP , 2007-UP

Air Filter Set.....	A-5565-S
Air Filter Secondary.....	A-5563
Air Filter Primary.....	A-5564
Fuel Filter.....	FC-5509
Fuel/Water Separator Secondary..	SFC-5504-10B
Fuel/Water Separator Secondary..	SFC-5504-10
Hydraulic Oil Filter.....	HC-5503
Hydraulic Oil Filter.....	HC-5506
Hydraulic Oil Filter.....	HC-5512

631G
(SCRAPERS)

Fuel/Water Separator Primary....	SFC-5504-30
Fuel/Water Separator Primary....	SFC-5504-30B

631G
(SCRAPERS)
S/N: CLR1-UP

Air Filter Primary.....	A-5564
Air Filter Secondary.....	A-5563
Air Filter Set.....	A-5565-S
Cabin Air Filter.....	CA-55060
Hydraulic Oil Filter.....	H-5509
Hydraulic Oil Filter.....	HC-5512
Hydraulic Oil Filter.....	HC-5506
Hydraulic Oil Filter.....	HC-5503
Hydraulic Oil Filter.....	HC-55300

631G
(SCRAPERS)
S/N: DFA1-UP

Air Filter Set.....	A-5595-S
Air Filter Primary.....	A-5593
Air Filter Secondary.....	A-5594
Cabin Air Filter.....	CA-55060
Hydraulic Oil Filter.....	H-5509
Hydraulic Oil Filter.....	HC-5506
Hydraulic Oil Filter.....	HC-5512
Hydraulic Oil Filter.....	HC-55300
Hydraulic Oil Filter.....	HC-5503

631G
(SCRAPERS)
w/3408E Eng.

Hydraulic Oil Filter.....	H-55320
---------------------------	---------

631B
(SCRAPERS)
S/N: 13G1-3686

Air Filter Set.....	A-5544-S
Air Filter Primary.....	A-5558
Air Filter Primary.....	A-5543
Air Filter Secondary.....	A-5559
Air Filter Secondary.....	A-5520

MODEL/APPLICATION	SAKURA NO
-------------------	-----------

CATERPILLAR

Fuel Filter.....	F-5501
Hydraulic Oil Filter.....	H-5503
Oil Filter Full Flow.....	O-5503

631B
(SCRAPERS)
S/N: 13G3687-UP

Air Filter Set.....	A-5544-S
Air Filter Secondary.....	A-5520
Air Filter Primary.....	A-5558
Air Filter Secondary.....	A-5559
Air Filter Primary.....	A-5543
Fuel Filter Secondary.....	FC-5507
Hydraulic Oil Filter.....	H-5503
Oil Filter Full Flow.....	O-5503

631C
(SCRAPERS)

Hydraulic Oil Filter.....	H-55320
---------------------------	---------

631C
(SCRAPERS)
S/N: 67M1-4259

Hydraulic Oil Filter.....	H-5504
Oil Filter Full Flow.....	O-5503

631C
(SCRAPERS)
S/N: 67M4260-UP

Air Filter Set.....	A-5557-S
Air Filter Secondary.....	A-5526
Air Filter Primary.....	A-5557
Fuel Filter Secondary.....	FC-5507
Hydraulic Oil Filter.....	H-5504
Oil Filter Full Flow.....	O-5503

631E
(SCRAPERS)
S/N: 1AB1-1639

Air Filter Set.....	A-5555-S
Air Filter Secondary.....	A-5556
Air Filter Set.....	A-5562-S
Air Filter Secondary.....	A-5560
Air Filter Primary.....	A-5555
Air Filter Primary.....	A-5561
Fuel Filter.....	FC-5509
Hydraulic Oil Filter.....	H-5504
Oil Filter Full Flow.....	C-5516

631E
(SCRAPERS)
S/N: 1AB1510-1575

Air Filter Set.....	A-5521-S
Air Filter Primary.....	A-5521
Air Filter.....	A-5547
Air Filter Secondary.....	A-5552
Hydraulic Oil Filter.....	HC-5506
Hydraulic Oil Filter.....	H-5509
Hydraulic Oil Filter.....	HC-5503
Hydraulic Oil Filter.....	HC-5512
Hydraulic Oil Filter.....	HC-55310

631E
(SCRAPERS)
S/N: 1AB1576-1639

Air Filter Secondary.....	A-5560
Air Filter Set.....	A-5562-S
Air Filter Primary.....	A-5561
Air Filter.....	A-5547
Hydraulic Oil Filter.....	HC-5506
Hydraulic Oil Filter.....	HC-5512

MODEL/APPLICATION	SAKURA NO
-------------------	-----------

CATERPILLAR

Hydraulic Oil Filter.....	H-5509
Hydraulic Oil Filter.....	HC-5503
Hydraulic Oil Filter.....	HC-55310

631E
(SCRAPERS)
S/N: 1AB1640-UP

Air Filter Primary.....	A-5561
Air Filter Set.....	A-5562-S
Air Filter.....	A-5547
Air Filter Secondary.....	A-5560
Hydraulic Oil Filter.....	H-5509
Hydraulic Oil Filter.....	HC-5503
Hydraulic Oil Filter.....	HC-55310
Hydraulic Oil Filter.....	HC-5506
Hydraulic Oil Filter.....	HC-5512

631E
(SCRAPERS)
S/N: 1AB1-855

Air Filter Primary.....	A-5521
Air Filter Set.....	A-5521-S
Air Filter.....	A-5547
Air Filter Secondary.....	A-5552
Hydraulic Oil Filter.....	H-5509

631E
(SCRAPERS)
S/N: 1BB1-1539

Air Filter Set.....	A-5521-S
Air Filter Primary.....	A-5521
Oil Filter Full Flow.....	C-5516

631E
(SCRAPERS)
S/N: 1NB1-389

Air Filter Secondary.....	A-5560
Air Filter Set.....	A-5521-S
Air Filter Set.....	A-5562-S
Air Filter Primary.....	A-5561
Air Filter Primary.....	A-5521
Hydraulic Oil Filter.....	H-5504
Oil Filter Full Flow.....	C-5516

631E
(SCRAPERS)
S/N: 3ND1-UP

Air Filter Set.....	A-5521-S
Air Filter Primary.....	A-5521
Air Filter Primary.....	A-5561
Air Filter Secondary.....	A-5560
Air Filter Secondary.....	A-5552
Air Filter Set.....	A-5562-S
Fuel Filter.....	FC-5509
Hydraulic Oil Filter.....	H-5504

631E
(SCRAPERS)
S/N: 4LD1-UP

Air Filter Primary.....	A-5521
Air Filter Set.....	A-5521-S
Air Filter Set.....	A-5562-S
Air Filter Primary.....	A-5561
Air Filter Secondary.....	A-5552
Air Filter Secondary.....	A-5560
Fuel Filter.....	FC-5509
Hydraulic Oil Filter.....	H-5504

631E
(SCRAPERS)
w/3408, 3408C Engs.

Hydraulic Oil Filter.....	H-55320
---------------------------	---------

MODEL/APPLICATION	SAKURA NO	MODEL/APPLICATION	SAKURA NO	MODEL/APPLICATION	SAKURA NO
CATERPILLAR		CATERPILLAR		CATERPILLAR	
632 (SCRAPERS) S/N: 14G-14G		Air Filter Primary.....	A-5555	Fuel Filter.....	F-5505
Air Filter Secondary.....	A-5520	Fuel Filter.....	FC-5509	Hydraulic Oil Filter.....	H-5504
Air Filter Primary.....	A-5543	Hydraulic Oil Filter.....	H-5504	Hydraulic Oil Filter.....	H-55270
Air Filter Set.....	A-5544-S	Oil Filter Full Flow.....	C-5516	Oil Filter Full Flow.....	C-5510
Fuel Filter.....	F-5501				
Hydraulic Oil Filter.....	H-5503	633D (SCRAPERS) w/3408 Eng.		637G (SCRAPERS)	
Oil Filter Full Flow.....	O-5503	Hydraulic Oil Filter.....	H-55320	Fuel/Water Separator Primary....	SFC-5504-30B
				Fuel/Water Separator Primary....	SFC-5504-30
632 (SCRAPERS) S/N: 14G1-UP		633E II (SCRAPERS) CAT S/N: 99C7560-UP		637G (SCRAPERS) S/N: CEH1-UP	
Air Filter Secondary.....	A-5520	Oil Filter Full Flow.....	C-5516	Air Filter Primary.....	A-5564
Air Filter Set.....	A-5544-S			Air Filter Set.....	A-5565-S
Air Filter Primary.....	A-5543	633E II (SCRAPERS) S/N: 2P51-UP		Air Filter Secondary.....	A-5563
Air Filter Primary.....	A-5558	Air Filter.....	A-5547	Cabin Air Filter.....	CA-55060
Air Filter Secondary.....	A-5559	Air Filter Primary.....	A-5561	Hydraulic Oil Filter.....	H-5509
Fuel Filter.....	F-5501	Air Filter Set.....	A-5562-S	Hydraulic Oil Filter.....	HC-5512
Hydraulic Oil Filter.....	H-5503	Air Filter Secondary.....	A-5560	Hydraulic Oil Filter.....	HC-5506
Oil Filter Full Flow.....	O-5503	Fuel Filter.....	FC-5509	Hydraulic Oil Filter.....	HC-55300
		Fuel/Water Separator Secondary..	SFC-5504-10B	Hydraulic Oil Filter.....	HC-5503
633 (SCRAPERS) S/N: 44J1-UP		Fuel/Water Separator Secondary... SFC-5504-10		637G (SCRAPERS) S/N: DFJ1-UP	
Air Filter Secondary.....	A-5520	Hydraulic Oil Filter.....	H-5509	Air Filter Primary.....	A-5593
Air Filter Set.....	A-5544-S	Hydraulic Oil Filter.....	HC-5503	Air Filter Set.....	A-5595-S
Air Filter Primary.....	A-5558	Hydraulic Oil Filter.....	HC-5512	Air Filter Secondary.....	A-5594
Air Filter Primary.....	A-5543	Hydraulic Oil Filter.....	HC-5506	Cabin Air Filter.....	CA-55060
Air Filter Secondary.....	A-5559	633E II (SCRAPERS) S/N: 9PE1-UP		Hydraulic Oil Filter.....	HC-5506
Air Filter Secondary.....	A-5526	Hydraulic Oil Filter.....	H-55270	Hydraulic Oil Filter.....	H-5509
Fuel Filter Secondary.....	FC-5507	Hydraulic Oil Filter.....	H-5504	Hydraulic Oil Filter.....	HC-5503
Hydraulic Oil Filter.....	H-5503			Hydraulic Oil Filter.....	HC-5512
Oil Filter Full Flow.....	O-5503	633C (SCRAPERS) S/N: 66M1-UP		Hydraulic Oil Filter.....	HC-55300
		Air Filter Set.....	A-5557-S	637G (SCRAPERS) w/3408E Eng.	
633 (SCRAPERS) S/N: 66M1-781		Air Filter Primary.....	A-5557	Hydraulic Oil Filter.....	H-55320
Air Filter Set.....	A-5544-S	Air Filter Secondary.....	A-5526	637G (SCRAPERS) w/C18 Eng.	
Air Filter Primary.....	A-5543	Fuel Filter Secondary.....	FC-5507	Hydraulic Oil Filter.....	H-55320
Air Filter Primary.....	A-5558	Hydraulic Oil Filter.....	H-5504	637G (SCRAPERS) w/C9 Eng.	
Air Filter Secondary.....	A-5526	Oil Filter Full Flow.....	O-5503	Air Filter Set.....	A-5573M-S
Air Filter Secondary.....	A-5520			Air Filter Primary.....	A-5535M
Air Filter Secondary.....	A-5559	633E (SCRAPERS)		637D (SCRAPERS) CAT (S/N: 99C7615-UP) , 2011	
Fuel Filter Secondary.....	FC-5507	Hydraulic Oil Filter.....	H-55320	Coolant Filter.....	WC-6901
Hydraulic Oil Filter.....	H-5503	633E (SCRAPERS) S/N: 1EB1-309		Coolant Filter.....	WC-5707
Oil Filter Full Flow.....	O-5503	Hydraulic Oil Filter.....	HC-5503	Coolant Filter.....	WC-5705
		637G (SCRAPERS) CAT 3408E (S/N: AWE1-UP)		Fuel Filter.....	FC-5509
633 (SCRAPERS) S/N: 66M782-UP		Air Filter Set.....	A-5562-S	Fuel/Water Separator.....	SFC-5505
Air Filter Set.....	A-5557-S	Air Filter Secondary.....	A-5560	Fuel/Water Separator Secondary..	SFC-5504-10B
Air Filter Primary.....	A-5557	Air Filter Primary.....	A-5561	Fuel/Water Separator.....	SF-5704
Air Filter Secondary.....	A-5526	Fuel Filter.....	F-5505	Fuel/Water Separator Secondary..	SFC-5504-10
Hydraulic Oil Filter.....	H-5509	Fuel Filter Secondary.....	FC-5507	Oil Filter By Pass.....	C-5718
Hydraulic Oil Filter.....	H-5504	Hydraulic Oil Filter.....	H-55270	Oil Filter Full Flow.....	C-5516
Oil Filter Full Flow.....	O-5503	Hydraulic Oil Filter.....	H-5504		
		Oil Filter Full Flow.....	C-5510	637D (SCRAPERS) CAT (S/N: THX10860-UP) , 2011	
633D (SCRAPERS) S/N: 19W1-UP		637G (SCRAPERS) CAT 3408E (S/N: AVN1-UP)		Coolant Filter.....	WC-6901
Air Filter Secondary.....	A-5529	Air Filter Set.....	A-5562-S	Coolant Filter.....	WC-5705
		Air Filter Secondary.....	A-5560	Coolant Filter.....	WC-5707
633D (SCRAPERS) S/N: 25W1-UP		Air Filter Primary.....	A-5561	Fuel Filter.....	FC-5509
Air Filter Secondary.....	A-5556	Fuel Filter.....	F-5505	Fuel/Water Separator.....	SFC-5505
Air Filter Set.....	A-5521-S	Fuel Filter Secondary.....	FC-5507	Fuel/Water Separator Secondary..	SFC-5504-10B
Air Filter Primary.....	A-5521	Hydraulic Oil Filter.....	H-55270	Fuel/Water Separator.....	SF-5704
Air Filter Secondary.....	A-5529	Hydraulic Oil Filter.....	H-5504	Fuel/Water Separator Secondary..	SFC-5504-10
Air Filter Set.....	A-5555-S	Oil Filter Full Flow.....	C-5510	Oil Filter By Pass.....	C-5718
				Oil Filter Full Flow.....	C-5516

MODEL/APPLICATION	SAKURA NO
-------------------	-----------

CATERPILLAR

637D
(SCRAPERS)
CAT (S/N: THX10860-UP) , 2011

Fuel Filter.....	FC-5517
Fuel/Water Separator Secondary..	SFC-5504-10B
Fuel/Water Separator Secondary..	SFC-5504-10
Fuel/Water Separator.....	SF-5704
Fuel/Water Separator.....	SFC-5505
Oil Filter Full Flow.....	C-5516
Oil Filter By Pass.....	C-5718

637D
(SCRAPERS)
CAT C10 (S/N: 2PN1-7341) , 2011

Coolant Filter.....	WC-5707
Coolant Filter.....	WC-5705
Coolant Filter.....	WC-6901
Fuel Filter.....	FC-5509
Fuel/Water Separator.....	SF-5704
Fuel/Water Separator Secondary..	SFC-5504-10B
Fuel/Water Separator.....	SFC-5505
Fuel/Water Separator Secondary..	SFC-5504-10
Oil Filter Full Flow.....	C-5516
Oil Filter By Pass.....	C-5718

637D
(SCRAPERS)
CAT C10 (S/N: 2PN7342-UP) , 2011

Coolant Filter.....	WC-5707
Coolant Filter.....	WC-6901
Coolant Filter.....	WC-5705
Fuel Filter.....	FC-5509
Fuel/Water Separator.....	SFC-5505
Fuel/Water Separator Secondary..	SFC-5504-10
Fuel/Water Separator Secondary..	SFC-5504-10B
Fuel/Water Separator.....	SF-5704
Oil Filter Full Flow.....	C-5516
Oil Filter By Pass.....	C-5718

637D
(SCRAPERS)
CAT C10 (S/N: 3CS1-UP) , 2011

Coolant Filter.....	WC-5707
Coolant Filter.....	WC-5705
Coolant Filter.....	WC-6901
Fuel Filter.....	FC-5517
Fuel Filter.....	FC-5509
Fuel/Water Separator Secondary..	SFC-5504-10B
Fuel/Water Separator Secondary..	SFC-5504-10
Fuel/Water Separator.....	SFC-5505
Fuel/Water Separator.....	SF-5704
Oil Filter By Pass.....	C-5718
Oil Filter Full Flow.....	C-5516

637D
(SCRAPERS)
CAT C10 (S/N: 8YS1-UP) , 2011

Coolant Filter.....	WC-5705
Coolant Filter.....	WC-5707
Coolant Filter.....	WC-6901
Fuel Filter.....	FC-5509
Fuel/Water Separator.....	SF-5704
Fuel/Water Separator Secondary..	SFC-5504-10B
Fuel/Water Separator Secondary..	SFC-5504-10
Fuel/Water Separator.....	SFC-5505
Oil Filter By Pass.....	C-5718
Oil Filter Full Flow.....	C-5516

MODEL/APPLICATION	SAKURA NO
-------------------	-----------

CATERPILLAR

637D
(SCRAPERS)
S/N: 20W1-UP

Air Filter Secondary.....	A-5559
Air Filter Primary.....	A-5558
Hydraulic Oil Filter.....	H-5504
Oil Filter Full Flow.....	C-5510

637D
(SCRAPERS)
S/N: 22W1-UP

Air Filter Secondary.....	A-5559
Air Filter Primary.....	A-5558
Hydraulic Oil Filter.....	H-5504
Oil Filter Full Flow.....	C-5510

637D
(SCRAPERS)
S/N: 26W1-UP

Air Filter Set.....	A-5521-S
Air Filter Set.....	A-5555-S
Air Filter Secondary.....	A-5529
Air Filter Primary.....	A-5555
Air Filter Secondary.....	A-5556
Air Filter Primary.....	A-5521
Fuel Filter.....	FC-5509
Hydraulic Oil Filter.....	H-5504
Oil Filter Full Flow.....	C-5516

637D
(SCRAPERS)
S/N: 27W1-UP

Air Filter Primary.....	A-5521
Air Filter Set.....	A-5555-S
Air Filter Secondary.....	A-5556
Air Filter Set.....	A-5521-S
Air Filter Secondary.....	A-5529
Air Filter Primary.....	A-5555
Fuel Filter.....	FC-5509
Hydraulic Oil Filter.....	H-5504
Oil Filter Full Flow.....	C-5516

637D
(SCRAPERS)
S/N: 4JB1-UP

Air Filter Set.....	A-5544-S
Air Filter Primary.....	A-5521
Air Filter Set.....	A-5521-S
Air Filter Primary.....	A-5543
Fuel Filter Secondary.....	FC-5507
Fuel Filter.....	F-5505
Hydraulic Oil Filter.....	H-5504
Hydraulic Oil Filter.....	H-55270
Oil Filter Full Flow.....	C-5510

637E
(SCRAPERS)
08Z63865-ON

Oil Filter Full Flow.....	C-5506
---------------------------	--------

637E
(SCRAPERS)
CAT 3306 (S/N: 1JB1-UP)

Air Filter Primary.....	A-5521
Air Filter Set.....	A-5521-S
Air Filter Secondary.....	A-5560
Air Filter Secondary.....	A-5552
Fuel Filter Secondary.....	FC-5507
Fuel Filter.....	FC-5509

MODEL/APPLICATION	SAKURA NO
-------------------	-----------

CATERPILLAR

637E
(SCRAPERS)
CAT 3408 (S/N: 1JB1-UP)

Air Filter Secondary.....	A-5552
Air Filter Primary.....	A-5521
Air Filter Set.....	A-5521-S
Air Filter Secondary.....	A-5560
Fuel Filter Secondary.....	FC-5507
Fuel Filter.....	FC-5509

637E
(SCRAPERS)
S/N: 1FB1-UP

Air Filter Set.....	A-5521-S
Air Filter Primary.....	A-5521
Air Filter Secondary.....	A-5560
Air Filter Secondary.....	A-5552
Air Filter Primary.....	A-5561
Air Filter Set.....	A-5562-S
Fuel Filter.....	FC-5509
Hydraulic Oil Filter.....	H-5504
Oil Filter Full Flow.....	C-5516

637E
(SCRAPERS)
S/N: 1HB1-690

Air Filter Primary.....	A-5521
Air Filter Secondary.....	A-5560
Air Filter Set.....	A-5521-S
Air Filter Set.....	A-5562-S
Air Filter Secondary.....	A-5559
Air Filter Primary.....	A-5543
Air Filter Primary.....	A-5558
Air Filter Primary.....	A-5561
Air Filter Set.....	A-5544-S
Fuel Filter Secondary.....	FC-5507
Fuel Filter.....	F-5505
Hydraulic Oil Filter.....	H-55270
Hydraulic Oil Filter.....	H-5504
Oil Filter Full Flow.....	C-5510

637E
(SCRAPERS)
S/N: 1HB1-809

Air Filter Secondary.....	A-5560
Air Filter Primary.....	A-5561
Air Filter Set.....	A-5562-S
Fuel Filter.....	FC-5509
Hydraulic Oil Filter.....	H-5504
Oil Filter Full Flow.....	C-5510

637E
(SCRAPERS)
S/N: 1HB810-UP

Air Filter Primary.....	A-5561
Air Filter Set.....	A-5562-S
Air Filter Secondary.....	A-5560

637E
(SCRAPERS)
S/N: 1LB1-UP

Air Filter Primary.....	A-5558
Air Filter Secondary.....	A-5559
Hydraulic Oil Filter.....	H-5504
Oil Filter Full Flow.....	C-5516

637E
(SCRAPERS)
S/N: 7CB1-179

Air Filter Secondary.....	A-5559
Air Filter Secondary.....	A-5560

Sakura Filter

ENGINE APPLICATION

MODEL/APPLICATION	SAKURA NO	MODEL/APPLICATION	SAKURA NO	MODEL/APPLICATION	SAKURA NO
CATERPILLAR					
637E II (SCRAPERS) S/N: 3KB1-UP					
Hydraulic Oil Filter.....	H-55270				
637E II (SCRAPERS) S/N: 7CB166-168-UP					
Air Filter Set.....	A-5521-S				
Air Filter Primary.....	A-5535				
Air Filter Set.....	A-5573-S				
Air Filter Secondary.....	A-5534				
Air Filter Secondary.....	A-5552				
Air Filter Primary.....	A-5521				
637E II (SCRAPERS) S/N: 7CB169-179-UP					
Air Filter Primary.....	A-5535				
Air Filter Secondary.....	A-5534				
Air Filter Set.....	A-5573-S				
Air Filter Primary.....	A-5561				
Air Filter Set.....	A-5562-S				
Air Filter Secondary.....	A-5560				
637E II (SCRAPERS) S/N: 7CB180-UP					
Air Filter Secondary.....	A-5560				
Air Filter Primary.....	A-5561				
Air Filter Set.....	A-5562-S				
Air Filter Set.....	A-5573-S				
Air Filter Secondary.....	A-5534				
Air Filter Primary.....	A-5535				
637E II (SCRAPERS) S/N: 7CB182-UP					
Air Filter Set.....	A-5544-S				
Air Filter Secondary.....	A-5534				
Air Filter Primary.....	A-5543				
Air Filter Set.....	A-5573-S				
Air Filter Primary.....	A-5535				
637E II (SCRAPERS) S/N: 7CB83-83-UP					
Air Filter Set.....	A-5573-S				
Air Filter Primary.....	A-5535				
Air Filter Secondary.....	A-5529				
Air Filter Set.....	A-5521-S				
Air Filter Secondary.....	A-5534				
Air Filter Primary.....	A-5521				
637E II (SCRAPERS) S/N: 7CB94-165-UP					
Air Filter Set.....	A-5573-S				
Air Filter Set.....	A-5521-S				
Air Filter Primary.....	A-5535				
Air Filter Secondary.....	A-5534				
Air Filter Primary.....	A-5521				
Air Filter Secondary.....	A-5552				
637E II (SCRAPERS) S/N: 9PE1-UP					
Hydraulic Oil Filter.....	H-5504				
Hydraulic Oil Filter.....	H-55270				
637 (SCRAPERS)					
Hydraulic Oil Filter.....	H-55320				
CATERPILLAR					
637 (SCRAPERS) S/N: 63M305-UP					
Air Filter Secondary.....	A-5520				
Air Filter Primary.....	A-5543				
Air Filter Secondary.....	A-5559				
Air Filter Primary.....	A-5558				
Air Filter Set.....	A-5544-S				
Fuel Filter Secondary.....	FC-5507				
Hydraulic Oil Filter.....	H-5504				
Oil Filter Full Flow.....	C-5510				
637 (SCRAPERS) S/N: 64M1-UP					
Air Filter Primary.....	A-5558				
Air Filter Set.....	A-5544-S				
Air Filter Secondary.....	A-5559				
Air Filter Primary.....	A-5543				
Air Filter Secondary.....	A-5520				
Fuel Filter Secondary.....	FC-5507				
Hydraulic Oil Filter.....	H-5504				
Oil Filter Full Flow.....	O-5502				
637 (SCRAPERS) S/N: 65M1-UP					
Air Filter Secondary.....	A-5526				
Air Filter Primary.....	A-5557				
Air Filter Set.....	A-5557-S				
Fuel Filter Secondary.....	FC-5507				
Hydraulic Oil Filter.....	H-5503				
Hydraulic Oil Filter.....	H-5504				
Oil Filter Full Flow.....	O-5503				
637 (SCRAPERS) S/N: 79P1-UP					
Air Filter Secondary.....	A-5526				
Air Filter Set.....	A-5557-S				
Air Filter Primary.....	A-5557				
Fuel Filter Secondary.....	FC-5507				
Hydraulic Oil Filter.....	H-5504				
Hydraulic Oil Filter.....	H-5503				
Oil Filter Full Flow.....	O-5503				
637 (SCRAPERS) S/N: 91N1-373					
Air Filter Secondary.....	A-5559				
Air Filter Set.....	A-5544-S				
Air Filter Primary.....	A-5543				
Air Filter Primary.....	A-5558				
Air Filter Secondary.....	A-5520				
Fuel Filter Secondary.....	FC-5507				
Hydraulic Oil Filter.....	H-5504				
Oil Filter Full Flow.....	O-5502				
637 (SCRAPERS) S/N: 91N374-UP					
Air Filter Set.....	A-5544-S				
Air Filter Secondary.....	A-5520				
Air Filter Primary.....	A-5543				
Air Filter Secondary.....	A-5559				
Air Filter Primary.....	A-5558				
Fuel Filter Secondary.....	FC-5507				
Hydraulic Oil Filter.....	H-5504				
Oil Filter Full Flow.....	C-5510				
637 (SCRAPERS) S/N: 92N1-204					
Air Filter Set.....	A-5544-S				
Air Filter Secondary.....	A-5520				
Air Filter Secondary.....	A-5559				
Air Filter Primary.....	A-5543				
Air Filter Primary.....	A-5558				
Fuel Filter Secondary.....	FC-5507				
Hydraulic Oil Filter.....	H-5504				
Oil Filter Full Flow.....	C-5510				
637 (SCRAPERS) S/N: 92N205-UP					
Air Filter Set.....	A-5544-S				
Air Filter Primary.....	A-5558				
Air Filter Primary.....	A-5543				
Air Filter Secondary.....	A-5520				
Air Filter Secondary.....	A-5559				
Fuel Filter Secondary.....	FC-5507				
Hydraulic Oil Filter.....	H-5504				
Oil Filter Full Flow.....	C-5510				
637B (SCRAPERS) S/N: 26R1-UP					
Fuel Filter Secondary.....	FC-5507				
Oil Filter Full Flow.....	C-5510				
637D TR (SCRAPERS) S/N: 27W1-UP					
Air Filter Secondary.....	A-5556				
Air Filter Set.....	A-5555-S				
Air Filter Secondary.....	A-5529				
Air Filter Primary.....	A-5555				
Air Filter Primary.....	A-5521				
Air Filter Set.....	A-5521-S				
Fuel Filter.....	FC-5509				
Hydraulic Oil Filter.....	H-5504				
Oil Filter Full Flow.....	C-5516				
639D (SCRAPERS) S/N: 88X1-UP					
Fuel Filter Secondary.....	FC-5507				
Oil Filter Full Flow.....	C-5510				
639D (SCRAPERS) S/N: 99X1-UP					
Air Filter Secondary.....	A-5556				
Air Filter Set.....	A-5555-S				
Air Filter Secondary.....	A-5529				
Air Filter Primary.....	A-5555				
Air Filter Set.....	A-5521-S				
Air Filter Primary.....	A-5521				
Fuel Filter.....	FC-5509				
Hydraulic Oil Filter.....	H-5504				
Oil Filter Full Flow.....	C-5516				
641 (SCRAPERS) S/N: 41M1-UP					
Air Filter Secondary.....	A-5559				
Air Filter Primary.....	A-5543				
Air Filter Set.....	A-5544-S				
Air Filter Primary.....	A-5558				
Air Filter Secondary.....	A-5520				
Fuel Filter.....	F-5501				

MODEL/APPLICATION	SAKURA NO
CATERPILLAR	
641 (SCRAPERS) S/N: 41M1-UP	
Hydraulic Oil Filter.....	H-5503
Oil Filter Full Flow.....	0-5503
641 (SCRAPERS) S/N: 64F1-UP	
Air Filter Primary.....	A-5558
Air Filter Set.....	A-5544-S
Air Filter Primary.....	A-5543
Air Filter Secondary.....	A-5520
Air Filter Secondary.....	A-5559
Fuel Filter.....	F-5501
Hydraulic Oil Filter.....	H-5503
Oil Filter Full Flow.....	0-5503
641B (SCRAPERS) S/N: 65K1-900	
Air Filter Primary.....	A-5543
Air Filter Set.....	A-5544-S
Air Filter Secondary.....	A-5520
Air Filter Secondary.....	A-5559
Air Filter Primary.....	A-5558
Fuel Filter Secondary.....	FC-5507
Hydraulic Oil Filter.....	H-5503
Hydraulic Oil Filter.....	H-5504
Oil Filter Full Flow.....	0-5502
641B (SCRAPERS) S/N: 65K901-UP	
Air Filter Secondary.....	A-5559
Air Filter Set.....	A-5544-S
Air Filter Primary.....	A-5558
Air Filter Primary.....	A-5543
Air Filter Secondary.....	A-5520
Fuel Filter Secondary.....	FC-5507
Hydraulic Oil Filter.....	H-5503
Hydraulic Oil Filter.....	H-5504
Oil Filter Full Flow.....	C-5516
641B (SCRAPERS) w/D346 Eng.	
Hydraulic Oil Filter.....	H-55320
650 (SCRAPERS) S/N: 58K1-354	
Air Filter Set.....	A-5544-S
Air Filter Secondary.....	A-5520
Air Filter Secondary.....	A-5559
Air Filter Primary.....	A-5543
Air Filter Primary.....	A-5558
Fuel Filter Secondary.....	FC-5507
Hydraulic Oil Filter.....	H-5503
Hydraulic Oil Filter.....	H-5504
Oil Filter Full Flow.....	0-5502
650 (SCRAPERS) S/N: 58K355-UP	
Air Filter Secondary.....	A-5520
Air Filter Primary.....	A-5543
Air Filter Secondary.....	A-5559
Air Filter Set.....	A-5544-S
Air Filter Primary.....	A-5558
Fuel Filter Secondary.....	FC-5507

MODEL/APPLICATION	SAKURA NO
CATERPILLAR	
Hydraulic Oil Filter.....	H-5504
Hydraulic Oil Filter.....	H-5503
Oil Filter Full Flow.....	C-5516
650 (SCRAPERS) S/N: 63F1-UP	
Air Filter Secondary.....	A-5559
Air Filter Primary.....	A-5558
Air Filter Set.....	A-5544-S
Air Filter Primary.....	A-5543
Air Filter Secondary.....	A-5520
Fuel Filter.....	F-5501
Hydraulic Oil Filter.....	H-5503
Oil Filter Full Flow.....	0-5503
650 (SCRAPERS) S/N: 77F1-UP	
Air Filter Secondary.....	A-5559
Air Filter Set.....	A-5544-S
Air Filter Primary.....	A-5543
Air Filter Primary.....	A-5558
Air Filter Secondary.....	A-5520
Fuel Filter.....	F-5501
Hydraulic Oil Filter.....	H-5503
Oil Filter Full Flow.....	0-5503
650B (SCRAPERS)	
Hydraulic Oil Filter.....	H-55320
651 (SCRAPERS) S/N: 33G1-UP	
Air Filter Primary.....	A-5543
Air Filter Secondary.....	A-5520
Air Filter Secondary.....	A-5559
Air Filter Set.....	A-5544-S
Air Filter Primary.....	A-5558
Fuel Filter.....	F-5501
Hydraulic Oil Filter.....	H-5503
Oil Filter Full Flow.....	0-5503
651 (SCRAPERS) S/N: 44M1-UP	
Air Filter Secondary.....	A-5520
Air Filter Secondary.....	A-5559
Air Filter Primary.....	A-5543
Air Filter Primary.....	A-5558
Air Filter Set.....	A-5544-S
Fuel Filter.....	F-5501
Hydraulic Oil Filter.....	H-5503
Oil Filter Full Flow.....	0-5503
651E (SCRAPERS) CAT 3412 (S/N: 88Z1-UP)	
Air Filter Primary.....	A-5521
Air Filter Set.....	A-5521-S
Air Filter.....	A-5547
Fuel Filter.....	FC-5509
Hydraulic Oil Filter.....	H-5503
Oil Filter Full Flow.....	C-5516
651E (SCRAPERS) CAT 3412 (S/N: 89Z1-UP)	
Air Filter Set.....	A-5521-S
Air Filter Primary.....	A-5521

MODEL/APPLICATION	SAKURA NO
CATERPILLAR	
Air Filter.....	A-5547
Fuel Filter.....	FC-5509
Hydraulic Oil Filter.....	H-5503
Oil Filter Full Flow.....	C-5516
651E (SCRAPERS) CAT 3412E (S/N: 88Z1-UP)	
Air Filter Set.....	A-5521-S
Air Filter.....	A-5547
Air Filter Primary.....	A-5521
Fuel Filter.....	FC-5509
Hydraulic Oil Filter.....	H-5503
Oil Filter Full Flow.....	C-5516
651E (SCRAPERS) CAT 3412E (S/N: 89Z1-UP)	
Air Filter Set.....	A-5521-S
Air Filter.....	A-5547
Air Filter Primary.....	A-5521
Fuel Filter.....	FC-5509
Hydraulic Oil Filter.....	H-5503
Oil Filter Full Flow.....	C-5516
651B (SCRAPERS) S/N: 67K1-508	
Air Filter Secondary.....	A-5559
Air Filter Set.....	A-5544-S
Air Filter Primary.....	A-5558
Air Filter Primary.....	A-5543
Air Filter Secondary.....	A-5520
Fuel Filter Secondary.....	FC-5507
Hydraulic Oil Filter.....	H-5504
Hydraulic Oil Filter.....	H-5503
Oil Filter Full Flow.....	0-5503
651B (SCRAPERS) S/N: 67K509-UP	
Air Filter Secondary.....	A-5520
Air Filter Primary.....	A-5558
Air Filter Secondary.....	A-5559
Air Filter Primary.....	A-5543
Air Filter Set.....	A-5544-S
Fuel Filter Secondary.....	FC-5507
Hydraulic Oil Filter.....	H-5504
Hydraulic Oil Filter.....	H-5503
Oil Filter Full Flow.....	C-5516
651B (SCRAPERS) w/D346 Eng.	
Hydraulic Oil Filter.....	H-55320
657E (SCRAPERS) CAT 3412C	
Hydraulic Oil Filter.....	H-5507
657E (SCRAPERS) CAT 3412E	
Hydraulic Oil Filter.....	H-5507
657E (SCRAPERS) CAT 3408 TA (S/N: 6MB1-UP)	
Fuel Filter.....	FC-5509
Hydraulic Oil Filter.....	H-5504
Hydraulic Oil Filter.....	H-5503
Oil Filter Full Flow.....	C-5516

MODEL/APPLICATION	SAKURA NO	MODEL/APPLICATION	SAKURA NO	MODEL/APPLICATION	SAKURA NO
CATERPILLAR		CATERPILLAR		CATERPILLAR	
657E (SCRAPERS) CAT 3408 TA (S/N: 86Z1-UP) Air Filter Primary..... A-5555 Air Filter Set..... A-5555-S Air Filter Secondary..... A-5529 Air Filter Set..... A-5521-S Air Filter Primary..... A-5521 Air Filter Secondary..... A-5556 Fuel Filter..... FC-5509 Hydraulic Oil Filter..... H-5504 Oil Filter Full Flow..... C-5516		657E (SCRAPERS) S/N: 5YR304-UP Air Filter Primary..... A-5593 Air Filter Set..... A-5595-S Air Filter..... A-5547 Air Filter Secondary..... A-5594 657E (SCRAPERS) S/N: 6PR1-UP Air Filter Secondary..... A-5556 Air Filter Set..... A-5555-S Air Filter Primary..... A-5555 Fuel Filter..... FC-5509 Hydraulic Oil Filter..... H-55270 Hydraulic Oil Filter..... H-5504 Oil Filter Full Flow..... C-5516		Fuel Filter..... FC-5510 Fuel Filter..... FC-5517 657G (SCRAPERS) S/N: A4G1-UP Air Filter Set..... A-5595-S Air Filter Primary..... A-5593 Air Filter Secondary..... A-5594 Hydraulic Oil Filter..... HC-5503 Hydraulic Oil Filter..... HC-5506 Hydraulic Oil Filter..... HC-55300 Hydraulic Oil Filter..... HC-5512	
657E (SCRAPERS) CAT 3408 TA (S/N: 87Z1-UP) Air Filter Primary..... A-5555 Air Filter Set..... A-5555-S Air Filter Secondary..... A-5556 Air Filter Set..... A-5521-S Air Filter Secondary..... A-5529 Air Filter Primary..... A-5521 Fuel Filter..... FC-5509 Hydraulic Oil Filter..... H-5504 Oil Filter Full Flow..... C-5516		657E (SCRAPERS) S/N: 6TR1-226-UP Air Filter Primary..... A-5593 Air Filter Set..... A-5595-S Air Filter Secondary..... A-5594 Air Filter..... A-5547 Hydraulic Oil Filter..... HC-55300		657G (SCRAPERS) S/N: DRM1-UP Hydraulic Oil Filter..... H-55280 Hydraulic Oil Filter..... H-5503 Hydraulic Oil Filter..... H-5526	
657E (SCRAPERS) CAT 3412 TA (S/N: 6MB1-UP) Fuel Filter..... FC-5509 Hydraulic Oil Filter..... H-5504 Hydraulic Oil Filter..... H-5503 Oil Filter Full Flow..... C-5516		657E (SCRAPERS) S/N: 6TR227-UP Air Filter Primary..... A-5593 Air Filter Set..... A-5595-S Air Filter..... A-5547 Air Filter Secondary..... A-5594 Hydraulic Oil Filter..... HC-55300		657G (SCRAPERS) S/N: GER1-UP Air Filter Secondary..... A-5563 Air Filter Set..... A-5565-S Air Filter Primary..... A-5564	
657E (SCRAPERS) CAT 3412 TA (S/N: 86Z1-UP) Air Filter Primary..... A-5521 Air Filter Primary..... A-5555 Air Filter Secondary..... A-5556 Air Filter Secondary..... A-5529 Air Filter Set..... A-5555-S Air Filter Set..... A-5521-S Fuel Filter..... FC-5509 Hydraulic Oil Filter..... H-5504 Oil Filter Full Flow..... C-5516		657E (SCRAPERS) S/N: 90Z1-UP Air Filter Primary..... A-5555 Air Filter Secondary..... A-5556 Air Filter Primary..... A-5521 Air Filter Set..... A-5555-S Air Filter Set..... A-5521-S Air Filter Secondary..... A-5529 Fuel Filter..... FC-5509 Hydraulic Oil Filter..... H-5503 Oil Filter Full Flow..... C-5516		657G (SCRAPERS) S/N: LMH1-UP Hydraulic Oil Filter..... H-5526 Hydraulic Oil Filter..... H-5503 Hydraulic Oil Filter..... H-55280	
657E (SCRAPERS) CAT 3412 TA (S/N: 87Z1-UP) Air Filter Secondary..... A-5556 Air Filter Secondary..... A-5529 Air Filter Primary..... A-5555 Air Filter Set..... A-5521-S Air Filter Primary..... A-5521 Air Filter Set..... A-5555-S Fuel Filter..... FC-5509 Hydraulic Oil Filter..... H-5504 Oil Filter Full Flow..... C-5516		657E (SCRAPERS) S/N: 91Z1-UP Air Filter Set..... A-5555-S Air Filter Primary..... A-5521 Air Filter Secondary..... A-5556 Air Filter Primary..... A-5555 Air Filter Set..... A-5521-S Air Filter Secondary..... A-5529 Fuel Filter..... FC-5509 Hydraulic Oil Filter..... H-5503 Oil Filter Full Flow..... C-5516		657G (SCRAPERS) S/N: PGE1-UP Hydraulic Oil Filter..... H-55270	
657E (SCRAPERS) CAT 3412 TA (S/N: 87Z1-UP) Air Filter Secondary..... A-5556 Air Filter Secondary..... A-5529 Air Filter Primary..... A-5555 Air Filter Set..... A-5521-S Air Filter Primary..... A-5521 Air Filter Set..... A-5555-S Fuel Filter..... FC-5509 Hydraulic Oil Filter..... H-5504 Oil Filter Full Flow..... C-5516		657E (SCRAPERS) S/N: 91Z1-UP Air Filter Set..... A-5555-S Air Filter Primary..... A-5521 Air Filter Secondary..... A-5556 Air Filter Primary..... A-5555 Air Filter Set..... A-5521-S Air Filter Secondary..... A-5529 Fuel Filter..... FC-5509 Hydraulic Oil Filter..... H-5503 Oil Filter Full Flow..... C-5516		657G (SCRAPERS) S/N: W1C1-UP Air Filter Set..... A-5595-S Air Filter Primary..... A-5593 Air Filter Secondary..... A-5594 Cabin Air Filter..... CA-55060 Hydraulic Oil Filter..... HC-55300	
657E (SCRAPERS) CAT 3412 TA (S/N: 87Z1-UP) Fuel/Water Separator Primary.... SFC-5504-30 Fuel/Water Separator Primary.... SFC-5504-30B		657E (SCRAPERS) S/N: 91Z1-UP Air Filter Set..... A-5555-S Air Filter Primary..... A-5521 Air Filter Secondary..... A-5556 Air Filter Primary..... A-5555 Air Filter Set..... A-5521-S Air Filter Secondary..... A-5529 Fuel Filter..... FC-5509 Hydraulic Oil Filter..... H-5503 Oil Filter Full Flow..... C-5516		657G (SCRAPERS) S/N: W1E1-UP Air Filter Secondary..... A-5563 Air Filter Set..... A-5565-S Air Filter Primary..... A-5564	
657E (SCRAPERS) S/N: 5YR1-303-UP Air Filter Primary..... A-5593 Air Filter Set..... A-5595-S		657E (SCRAPERS) CAT (S/N: LHX1-UP) Fuel Filter..... FC-5517		657G (SCRAPERS) S/N: W1F105-UP Air Filter Secondary..... A-5563 Air Filter Primary..... A-5564 Air Filter Set..... A-5565-S	
		657G (SCRAPERS) CAT (S/N: RHX1-UP)		657G (SCRAPERS) S/N: W1F1-104-UP Air Filter Primary..... A-5564 Air Filter Secondary..... A-5563	

MODEL/APPLICATION	SAKURA NO	MODEL/APPLICATION	SAKURA NO	MODEL/APPLICATION	SAKURA NO
CATERPILLAR		CATERPILLAR		CATERPILLAR	
657G (SCRAPERS) S/N: W1F1-104-UP Air Filter Set..... A-5565-S 657B (SCRAPERS) S/N: 68K1-826 Air Filter Secondary..... A-5520 Air Filter Secondary..... A-5559 Air Filter Primary..... A-5558 Air Filter Primary..... A-5543 Air Filter Set..... A-5544-S Fuel Filter Secondary..... FC-5507 Hydraulic Oil Filter..... H-5503 Hydraulic Oil Filter..... H-5504 Oil Filter Full Flow..... 0-5502 657B (SCRAPERS) S/N: 68K827-UP Air Filter Set..... A-5544-S Air Filter Primary..... A-5543 Air Filter Secondary..... A-5559 Air Filter Secondary..... A-5520 Air Filter Primary..... A-5558 Fuel Filter Secondary..... FC-5507 Hydraulic Oil Filter..... H-5503 Hydraulic Oil Filter..... H-55270 Hydraulic Oil Filter..... H-5504 Oil Filter Full Flow..... 0-5502 657B (SCRAPERS) S/N: 68K829-UP Air Filter Secondary..... A-5520 Air Filter Secondary..... A-5559 Air Filter Primary..... A-5558 Air Filter Set..... A-5544-S Air Filter Primary..... A-5543 Fuel Filter Secondary..... FC-5507 Hydraulic Oil Filter..... H-5504 Hydraulic Oil Filter..... H-5503 Oil Filter Full Flow..... 0-5502 657B (SCRAPERS) w/D346 Eng. Hydraulic Oil Filter..... H-55320 657 (SCRAPERS) S/N: 19G1-UP Air Filter Secondary..... A-5520 Air Filter Primary..... A-5543 Air Filter Primary..... A-5558 Air Filter Set..... A-5544-S Air Filter Secondary..... A-5559 Fuel Filter..... F-5501 Hydraulic Oil Filter..... H-5503 Oil Filter Full Flow..... 0-5503 657 (SCRAPERS) S/N: 31G1-UP Air Filter Primary..... A-5558 Air Filter Secondary..... A-5559 Air Filter Primary..... A-5543 Air Filter Set..... A-5544-S Air Filter Secondary..... A-5520 Fuel Filter..... F-5501	Hydraulic Oil Filter..... H-5503 Oil Filter Full Flow..... 0-5503 657 (SCRAPERS) S/N: 46M1-UP Air Filter Secondary..... A-5559 Air Filter Primary..... A-5558 Air Filter Set..... A-5544-S Air Filter Primary..... A-5543 Air Filter Secondary..... A-5520 Fuel Filter..... F-5501 Hydraulic Oil Filter..... H-5503 Oil Filter Full Flow..... 0-5503 657 (SCRAPERS) S/N: 8621-8721 Air Filter Set..... A-5521-S Air Filter Primary..... A-5521 Air Filter Secondary..... A-5529 Hydraulic Oil Filter..... H-5504 Oil Filter Full Flow..... C-5516 657 (SCRAPERS) S/N: 9021-9121 Air Filter Set..... A-5521-S Air Filter Secondary..... A-5529 Air Filter Primary..... A-5521 Fuel Filter..... FC-5519 Hydraulic Oil Filter..... H-5503 Oil Filter Full Flow..... C-5516 65B (TRACTORS) CAT (S/N: 08Z32054-UP) Fuel Filter Secondary..... FC-5507 Oil Filter Full Flow..... C-5522 65B (TRACTORS) S/N: 7YC1-1116-UP Air Filter Primary..... A-5543 Air Filter Set..... A-5549M-S Air Filter Primary..... A-5535 Air Filter Secondary..... A-5550 Air Filter Set..... A-5573-S Air Filter Set..... A-5544-S Air Filter Primary..... A-5549M Air Filter Primary..... A-5549 Air Filter Secondary..... A-5534 Hydraulic Oil Filter..... HC-5508 Hydraulic Oil Filter..... HC-5503 Hydraulic Oil Filter..... HC-5512 Hydraulic Oil Filter..... HC-5506 Oil Filter Full Flow..... C-5510 Oil Filter Full Flow..... C-5522 65B (TRACTORS) S/N: 7YC1117-UP Air Filter Set..... A-5544-S Air Filter Primary..... A-5535 Air Filter Secondary..... A-5550 Air Filter Set..... A-5573-S Air Filter Primary..... A-5549 Air Filter Primary..... A-5543 Air Filter Secondary..... A-5534 Air Filter Set..... A-5549M-S Air Filter Primary..... A-5549M	Hydraulic Oil Filter..... HC-5508 Hydraulic Oil Filter..... HC-5503 Hydraulic Oil Filter..... HC-5506 Hydraulic Oil Filter..... HC-5512 Oil Filter Full Flow..... C-5522 65C (TRACTORS) CAT (S/N: 08769250-84539-UP) Fuel Filter Secondary..... FC-5507 Oil Filter Full Flow..... C-5522 65C (TRACTORS) CAT (S/N: 08Z84540-UP) Fuel Filter..... FC-5509 Oil Filter Full Flow..... C-5522 65C (TRACTORS) S/N: 2ZJ1-499-UP Air Filter Primary..... A-5535 Air Filter Set..... A-5573-S Air Filter Secondary..... A-5534 Hydraulic Oil Filter..... HC-5512 Hydraulic Oil Filter..... HC-5503 Hydraulic Oil Filter..... HC-5506 Oil Filter Full Flow..... C-5510 Oil Filter Full Flow..... C-5516 Oil Filter Full Flow..... C-5522 65C (TRACTORS) S/N: 2ZJ500-UP Air Filter Secondary..... A-5534 Air Filter Primary..... A-5535 Air Filter Set..... A-5573-S Hydraulic Oil Filter..... HC-5506 Hydraulic Oil Filter..... HC-5503 Hydraulic Oil Filter..... HC-5512 Oil Filter Full Flow..... C-5510 Oil Filter Full Flow..... C-5516 Oil Filter Full Flow..... C-5522 65D (TRACTORS) CAT (S/N: 08Z78500-84539-UP) Fuel Filter Secondary..... FC-5507 Oil Filter Full Flow..... C-5522 65D (TRACTORS) CAT (S/N: 08Z84540-UP) Fuel Filter..... FC-5509 Oil Filter Full Flow..... C-5522 65D (TRACTORS) CAT (S/N: 6NC1-UP) Fuel Filter..... FC-5509 Fuel Filter Secondary..... FC-5507 Oil Filter Full Flow..... C-5516 Oil Filter Full Flow..... C-5522 65D (TRACTORS) S/N: 2ZJ1000-UP Air Filter Secondary..... A-5534 Air Filter Set..... A-5573-S Air Filter Primary..... A-5535 Hydraulic Oil Filter..... HC-5506 Hydraulic Oil Filter..... HC-5512			

Sakura Filter

ENGINE APPLICATION

MODEL/APPLICATION	SAKURA NO	MODEL/APPLICATION	SAKURA NO	MODEL/APPLICATION	SAKURA NO
CATERPILLAR		CATERPILLAR		CATERPILLAR	
65D (TRACTORS) S/N: 2ZJ1000-UP		Air Filter Set.....	A-5544-S	Air Filter Secondary.....	A-5520
Hydraulic Oil Filter.....	HC-5503	Air Filter Primary.....	A-5543	Fuel Filter.....	F-5501
		Air Filter Secondary.....	A-5520	Hydraulic Oil Filter.....	H-5503
		Air Filter Primary.....	A-5558	Oil Filter Full Flow.....	O-5503
65D (TRACTORS) S/N: 2ZJ1-999-UP		Fuel Filter Secondary.....	FC-5507		
Air Filter Secondary.....	A-5534	Hydraulic Oil Filter.....	H-5504	666 (SCRAPERS) S/N: 64H1-UP	
Air Filter Set.....	A-5573-S	Hydraulic Oil Filter.....	H-5503	Air Filter Primary.....	A-5543
Air Filter Primary.....	A-5535	Oil Filter Full Flow.....	O-5502	Air Filter Secondary.....	A-5559
Hydraulic Oil Filter.....	HC-5503			Air Filter Primary.....	A-5558
Hydraulic Oil Filter.....	HC-5506	660 (SCRAPERS) S/N: 58K355-UP		Air Filter Set.....	A-5544-S
Hydraulic Oil Filter.....	HC-5512	Air Filter Set.....	A-5544-S	Air Filter Secondary.....	A-5520
		Air Filter Primary.....	A-5543	Fuel Filter.....	F-5501
65E (TRACTORS) CAT S/N: 7ZR575-648-UP		Air Filter Primary.....	A-5558	Hydraulic Oil Filter.....	H-5503
Fuel Filter.....	FC-5517	Air Filter Secondary.....	A-5559	Oil Filter Full Flow.....	O-5503
		Air Filter Secondary.....	A-5520		
65E (TRACTORS) CAT S/N: 7ZR1450-4252-UP		Fuel Filter Secondary.....	FC-5507	666 (SCRAPERS) S/N: 77F1-UP	
Fuel Filter.....	FC-5517	Hydraulic Oil Filter.....	H-5504	Air Filter Set.....	A-5544-S
Oil Filter Full Flow.....	C-5516	Hydraulic Oil Filter.....	H-5503	Air Filter Secondary.....	A-5520
		Oil Filter Full Flow.....	C-5516	Air Filter Secondary.....	A-5559
65E (TRACTORS) CAT S/N: 7ZR4253-4280-UP				Air Filter Primary.....	A-5558
Fuel Filter.....	FC-5517	660 (SCRAPERS) S/N: 77F1-UP		Air Filter Primary.....	A-5543
Oil Filter Full Flow.....	C-5516	Air Filter Set.....	A-5544-S	Fuel Filter.....	F-5501
		Air Filter Secondary.....	A-5559	Hydraulic Oil Filter.....	H-5503
65E (TRACTORS) CAT S/N: 7ZR4281-5544-UP		Air Filter Secondary.....	A-5520	Oil Filter Full Flow.....	O-5503
Fuel Filter.....	FC-5517	Air Filter Primary.....	A-5558		
Oil Filter Full Flow.....	C-5516	Air Filter Primary.....	A-5543	666B (SCRAPERS) S/N: 66K1-226	
		Fuel Filter.....	F-5501	Air Filter Set.....	A-5544-S
65E (TRACTORS) CAT S/N: 7ZR5545-UP		Hydraulic Oil Filter.....	H-5503	Air Filter Primary.....	A-5558
Fuel Filter.....	FC-5517	Oil Filter Full Flow.....	O-5503	Air Filter Primary.....	A-5543
Oil Filter Full Flow.....	C-5516			Air Filter Secondary.....	A-5559
		660B (SCRAPERS)		Air Filter Secondary.....	A-5520
65E (TRACTORS) CAT S/N: 7ZR649-1449-UP		Hydraulic Oil Filter.....	H-55320	Fuel Filter Secondary.....	FC-5507
Fuel Filter.....	FC-5517			Hydraulic Oil Filter.....	H-5504
Oil Filter Full Flow.....	C-5516	666 (SCRAPERS) S/N: 18G1-UP		Hydraulic Oil Filter.....	H-55270
		Air Filter Secondary.....	A-5559	Hydraulic Oil Filter.....	H-55280
65E (TRACTORS) S/N: 1GM1-UP		Air Filter Primary.....	A-5543	Hydraulic Oil Filter.....	H-5503
Air Filter Primary.....	A-5535	Air Filter Primary.....	A-5558	Oil Filter Full Flow.....	O-5502
Air Filter Secondary.....	A-5534	Air Filter Set.....	A-5544-S		
Air Filter Set.....	A-5573-S	Air Filter Secondary.....	A-5520	666B (SCRAPERS) S/N: 66K227-UP	
Fuel/Water Separator Secondary..	SFC-5504-10B	Fuel Filter.....	F-5501	Air Filter Secondary.....	A-5559
Fuel/Water Separator Secondary..	SFC-5504-10	Hydraulic Oil Filter.....	H-5503	Air Filter Secondary.....	A-5520
Hydraulic Oil Filter.....	HC-5503	Oil Filter Full Flow.....	O-5503	Air Filter Set.....	A-5544-S
Hydraulic Oil Filter.....	HC-5512			Air Filter Primary.....	A-5543
Hydraulic Oil Filter.....	HC-5506	666 (SCRAPERS) S/N: 20G1-241		Air Filter Primary.....	A-5558
		Air Filter Set.....	A-5544-S	Fuel Filter Secondary.....	FC-5507
65E (TRACTORS) S/N: 6GS1-UP		Air Filter Primary.....	A-5558	Hydraulic Oil Filter.....	H-5503
Air Filter Secondary.....	A-5534	Air Filter Secondary.....	A-5520	Hydraulic Oil Filter.....	H-5504
Air Filter Primary.....	A-5535	Air Filter Secondary.....	A-5559	Oil Filter Full Flow.....	C-5516
Air Filter Set.....	A-5573-S	Air Filter Primary.....	A-5543		
Fuel/Water Separator Secondary..	SFC-5504-10B	Fuel Filter.....	F-5501	70C (TRACTORS) CAT (S/N: 08Z72400-UP)	
Fuel/Water Separator Secondary..	SFC-5504-10	Hydraulic Oil Filter.....	H-5503	Fuel Filter Secondary.....	FC-5507
Hydraulic Oil Filter.....	HC-5512	Oil Filter Full Flow.....	O-5503	Oil Filter Full Flow.....	C-5522
Hydraulic Oil Filter.....	HC-5506				
Hydraulic Oil Filter.....	HC-5503	666 (SCRAPERS) S/N: 32G1-UP		70C (TRACTORS) S/N: 2YL1-UP	
		Air Filter Primary.....	A-5543	Air Filter Primary.....	A-5535
660 (SCRAPERS) S/N: 58K1-354		Air Filter Secondary.....	A-5559	Air Filter Set.....	A-5573-S
Air Filter Secondary.....	A-5559	Air Filter Set.....	A-5544-S	Air Filter Secondary.....	A-5534
		Air Filter Primary.....	A-5558	Hydraulic Oil Filter.....	HC-5512
				Hydraulic Oil Filter.....	HC-5506

MODEL/APPLICATION	SAKURA NO
CATERPILLAR	
70C (TRACTORS) S/N: 2YL1-UP	
Hydraulic Oil Filter.....	HC-5503
Oil Filter Full Flow.....	C-5510
Oil Filter Full Flow.....	C-5522
725 (ARTICULATED TRUCKS) CAT 3176C	
Air Filter Secondary.....	A-8651
Fuel Filter.....	FC-5517
Fuel/Water Separator Secondary..	SFC-5504-10
Fuel/Water Separator Secondary..	SFC-5504-10B
Hydraulic Oil Filter.....	H-5526
Hydraulic Oil Filter.....	HC-5507
Oil Filter Full Flow.....	C-5516
725 (ARTICULATED TRUCKS) CAT C11	
Air Filter Secondary.....	A-8651
Fuel Filter.....	FC-5517
Fuel/Water Separator Secondary..	SFC-5504-10
Fuel/Water Separator Secondary..	SFC-5504-10B
Hydraulic Oil Filter.....	H-5526
Hydraulic Oil Filter.....	HC-5507
Oil Filter Full Flow.....	C-5516
725 (ARTICULATED TRUCKS) S/N: AFX1-1178	
Air Filter Secondary.....	A-8651
Cabin Air Filter.....	CA-55060
Fuel/Water Separator Secondary..	SFC-5504-10
Fuel/Water Separator Secondary..	SFC-5504-10B
Hydraulic Oil Filter.....	HC-5507
Hydraulic Oil Filter.....	HC-55220
Hydraulic Oil Filter.....	H-5526
Hydraulic Oil Filter.....	H-55280
Hydraulic Oil Filter.....	H-5503
725 (ARTICULATED TRUCKS) S/N: AFX1179-1582	
Air Filter Secondary.....	A-8651
Cabin Air Filter.....	CA-55060
Fuel/Water Separator Secondary..	SFC-5504-10B
Fuel/Water Separator Secondary..	SFC-5504-10
Hydraulic Oil Filter.....	H-5526
Hydraulic Oil Filter.....	HC-55220
Hydraulic Oil Filter.....	H-5503
Hydraulic Oil Filter.....	H-55280
Hydraulic Oil Filter.....	HC-5507
725 (ARTICULATED TRUCKS) S/N: AFX1583-UP	
Air Filter Secondary.....	A-8651
Cabin Air Filter.....	CA-55060
Fuel/Water Separator Secondary..	SFC-5504-10
Fuel/Water Separator Secondary..	SFC-5504-10B
Hydraulic Oil Filter.....	HC-5507
Hydraulic Oil Filter.....	HC-55220
Hydraulic Oil Filter.....	H-5526
Hydraulic Oil Filter.....	H-55280
Hydraulic Oil Filter.....	H-5503

MODEL/APPLICATION	SAKURA NO
CATERPILLAR	
Cabin Air Filter.....	CA-55160
725 (ARTICULATED TRUCKS) S/N: B111-504	
Air Filter Secondary.....	A-8651
Cabin Air Filter.....	CA-55060
Fuel/Water Separator Secondary..	SFC-5504-10
Fuel/Water Separator Secondary..	SFC-5504-10B
Hydraulic Oil Filter.....	H-55280
Hydraulic Oil Filter.....	HC-5507
Hydraulic Oil Filter.....	H-5503
Hydraulic Oil Filter.....	HC-55220
Hydraulic Oil Filter.....	H-5526
725 (ARTICULATED TRUCKS) S/N: B11505-711	
Air Filter Secondary.....	A-8651
Cabin Air Filter.....	CA-55060
Fuel/Water Separator Secondary..	SFC-5504-10
Fuel/Water Separator Secondary..	SFC-5504-10B
Hydraulic Oil Filter.....	H-55280
Hydraulic Oil Filter.....	H-5526
Hydraulic Oil Filter.....	HC-5504
730 (ARTICULATED TRUCKS) CAT 3196C	
Air Filter Secondary.....	A-8651
Fuel Filter.....	FC-5517
Fuel/Water Separator Secondary..	SFC-5504-10
Fuel/Water Separator Secondary..	SFC-5504-10B
Hydraulic Oil Filter.....	HC-5507
Hydraulic Oil Filter.....	H-5526
Oil Filter Full Flow.....	C-5516
730 (ARTICULATED TRUCKS) CAT C11	
Air Filter Secondary.....	A-8651
Fuel Filter.....	FC-5517
Fuel/Water Separator Secondary..	SFC-5504-10
Fuel/Water Separator Secondary..	SFC-5504-10B
Hydraulic Oil Filter.....	H-5526
Hydraulic Oil Filter.....	HC-5507
Oil Filter Full Flow.....	C-5516
730 (ARTICULATED TRUCKS) S/N: AGF1092-1491	
Air Filter Secondary.....	A-8651
Cabin Air Filter.....	CA-55060
Fuel/Water Separator Secondary..	SFC-5504-10
Fuel/Water Separator Secondary..	SFC-5504-10B
Hydraulic Oil Filter.....	HC-5507
Hydraulic Oil Filter.....	HC-55220
Hydraulic Oil Filter.....	H-55280
Hydraulic Oil Filter.....	H-5526
730 (ARTICULATED TRUCKS) S/N: AGF1-1091	
Air Filter Secondary.....	A-8651
Cabin Air Filter.....	CA-55060
Fuel/Water Separator Secondary..	SFC-5504-10B
Fuel/Water Separator Secondary..	SFC-5504-10
Hydraulic Oil Filter.....	HC-55220
Hydraulic Oil Filter.....	H-5503
Hydraulic Oil Filter.....	H-55280

MODEL/APPLICATION	SAKURA NO
CATERPILLAR	
Hydraulic Oil Filter.....	HC-5507
Hydraulic Oil Filter.....	H-5526
730 (ARTICULATED TRUCKS) S/N: AGF1492-UP	
Air Filter Secondary.....	A-8651
Cabin Air Filter.....	CA-55060
Fuel/Water Separator Secondary..	SFC-5504-10B
Fuel/Water Separator Secondary..	SFC-5504-10
Hydraulic Oil Filter.....	HC-5507
Hydraulic Oil Filter.....	HC-55220
Hydraulic Oil Filter.....	H-55280
Hydraulic Oil Filter.....	H-5526
730 (ARTICULATED TRUCKS) S/N: B1M1-410	
Air Filter Secondary.....	A-8651
Cabin Air Filter.....	CA-55060
Fuel/Water Separator Secondary..	SFC-5504-10B
Fuel/Water Separator Secondary..	SFC-5504-10
Hydraulic Oil Filter.....	HC-55220
Hydraulic Oil Filter.....	H-5526
Hydraulic Oil Filter.....	H-55280
Hydraulic Oil Filter.....	HC-5507
730 (ARTICULATED TRUCKS) S/N: B1M411-630	
Air Filter Secondary.....	A-8651
Cabin Air Filter.....	CA-55060
Fuel/Water Separator Secondary..	SFC-5504-10B
Fuel/Water Separator Secondary..	SFC-5504-10
Hydraulic Oil Filter.....	HC-5504
Hydraulic Oil Filter.....	H-55280
Hydraulic Oil Filter.....	H-5526
730 (ARTICULATED TRUCKS) S/N: B1M1-184	
Air Filter Secondary.....	A-8651
Cabin Air Filter.....	CA-55060
Fuel/Water Separator Secondary..	SFC-5504-10B
Fuel/Water Separator Secondary..	SFC-5504-10
Hydraulic Oil Filter.....	H-55280
Hydraulic Oil Filter.....	H-5526
Hydraulic Oil Filter.....	HC-55220
Hydraulic Oil Filter.....	HC-5507
730 (ARTICULATED TRUCKS) S/N: B1W185-196	
Air Filter Secondary.....	A-8651
Cabin Air Filter.....	CA-55060
Fuel/Water Separator Secondary..	SFC-5504-10
Fuel/Water Separator Secondary..	SFC-5504-10B
Hydraulic Oil Filter.....	H-55280
Hydraulic Oil Filter.....	HC-5504
Hydraulic Oil Filter.....	H-5526
730 (ARTICULATED TRUCKS) S/N: B1M1-UP	
Cabin Air Filter.....	CA-55160
735 (ARTICULATED TRUCKS) CAT 3406E	
Air Filter Secondary.....	A-8580
Air Filter Primary.....	A-8665M
Air Filter.....	AH-7001

MODEL/APPLICATION	SAKURA NO
CATERPILLAR	
735 <i>(ARTICULATED TRUCKS)</i> CAT 3406E	
Fuel Filter.....	FC-5509
Fuel/Water Separator Secondary..	SFC-5504-10
Fuel/Water Separator Secondary..	SFC-5504-10B
Hydraulic Oil Filter.....	HC-5507
Hydraulic Oil Filter.....	H-5526
Oil Filter Full Flow.....	C-5516
735 <i>(ARTICULATED TRUCKS)</i> CAT C15	
Air Filter.....	AH-7001
Air Filter Secondary.....	A-8580
Air Filter Primary.....	A-8665M
Fuel Filter.....	FC-5517
Fuel/Water Separator Secondary..	SFC-5504-10B
Fuel/Water Separator Secondary..	SFC-5504-10
Hydraulic Oil Filter.....	H-5526
Hydraulic Oil Filter.....	HC-5507
Oil Filter Full Flow.....	C-5516
735 <i>(ARTICULATED TRUCKS)</i> S/N: AWR1-856	
Air Filter Primary.....	A-8665M
Air Filter Secondary.....	A-8580
Cabin Air Filter.....	CA-55060
Hydraulic Oil Filter.....	H-5526
Hydraulic Oil Filter.....	H-55280
Hydraulic Oil Filter.....	HC-55220
Hydraulic Oil Filter.....	HC-5507
735 <i>(ARTICULATED TRUCKS)</i> S/N: AWR857-UP	
Air Filter Primary.....	A-8665M
Air Filter Secondary.....	A-8580
Cabin Air Filter.....	CA-55060
Hydraulic Oil Filter.....	HC-55220
Hydraulic Oil Filter.....	H-55280
Hydraulic Oil Filter.....	H-5526
Hydraulic Oil Filter.....	HC-5507
735 <i>(ARTICULATED TRUCKS)</i> S/N: B1N1-436	
Air Filter Primary.....	A-8665M
Air Filter Secondary.....	A-8580
Cabin Air Filter.....	CA-55060
Hydraulic Oil Filter.....	H-5526
Hydraulic Oil Filter.....	HC-55220
Hydraulic Oil Filter.....	H-55280
Hydraulic Oil Filter.....	HC-5507
740 <i>(ARTICULATED TRUCKS)</i> CAT 3406E	
Air Filter Secondary.....	A-8580
Air Filter.....	AH-7001
Air Filter Primary.....	A-8665M
Fuel Filter.....	FC-5509
Fuel/Water Separator Secondary..	SFC-5504-10
Fuel/Water Separator Secondary..	SFC-5504-10B
Hydraulic Oil Filter.....	HC-5507
Hydraulic Oil Filter.....	H-55270
Hydraulic Oil Filter.....	H-5504
Hydraulic Oil Filter.....	H-5526
Oil Filter Full Flow.....	C-5516

MODEL/APPLICATION	SAKURA NO
CATERPILLAR	
740 <i>(ARTICULATED TRUCKS)</i> CAT C15	
Air Filter Secondary.....	A-8580
Air Filter Primary.....	A-8665M
Air Filter.....	AH-7001
Fuel Filter.....	FC-5517
Fuel/Water Separator Secondary..	SFC-5504-10
Fuel/Water Separator Secondary..	SFC-5504-10B
Hydraulic Oil Filter.....	HC-5507
Hydraulic Oil Filter.....	H-5526
Hydraulic Oil Filter.....	H-5504
Oil Filter Full Flow.....	C-5516
740 <i>(ARTICULATED TRUCKS)</i> S/N: AXM1-UP	
Air Filter Primary.....	A-8665M
Air Filter Secondary.....	A-8580
Cabin Air Filter.....	CA-55060
Hydraulic Oil Filter.....	H-5526
Hydraulic Oil Filter.....	H-55280
Hydraulic Oil Filter.....	H-55270
Hydraulic Oil Filter.....	HC-5507
Hydraulic Oil Filter.....	HC-55220
740 <i>(ARTICULATED TRUCKS)</i> S/N: AZZ1-UP	
Air Filter Primary.....	A-8665M
Air Filter Secondary.....	A-8580
Cabin Air Filter.....	CA-55060
Hydraulic Oil Filter.....	H-5526
Hydraulic Oil Filter.....	H-55280
Hydraulic Oil Filter.....	H-55220
Hydraulic Oil Filter.....	HC-5507
Hydraulic Oil Filter.....	H-55270
740 <i>(ARTICULATED TRUCKS)</i> S/N: B1P1-1073	
Air Filter Secondary.....	A-8580
Air Filter Primary.....	A-8665M
Cabin Air Filter.....	CA-55060
Hydraulic Oil Filter.....	H-5526
Hydraulic Oil Filter.....	H-55280
Hydraulic Oil Filter.....	H-55270
Hydraulic Oil Filter.....	HC-55220
Hydraulic Oil Filter.....	HC-5507
740 <i>(ARTICULATED TRUCKS)</i> S/N: B1R1-219	
Air Filter Secondary.....	A-8580
Air Filter Primary.....	A-8665M
Cabin Air Filter.....	CA-55060
Hydraulic Oil Filter.....	HC-55220
Hydraulic Oil Filter.....	H-55270
Hydraulic Oil Filter.....	HC-5507
Hydraulic Oil Filter.....	H-5526
Hydraulic Oil Filter.....	H-55280
75 <i>(TRACTORS)</i> CAT S/N: 43Z1-UP	
Air Filter Primary.....	A-5501
Air Filter Secondary.....	A-5502
Fuel Filter.....	FC-5509
Hydraulic Oil Filter.....	HC-5512

MODEL/APPLICATION	SAKURA NO
CATERPILLAR	
Hydraulic Oil Filter.....	HC-5508
Hydraulic Oil Filter.....	HC-5503
Hydraulic Oil Filter.....	HC-5506
Oil Filter Full Flow.....	C-5516
75 <i>(TRACTORS)</i> CAT S/N: 4CJ1-UP	
Air Filter Secondary.....	A-5502
Air Filter Primary.....	A-5501
Fuel Filter.....	FC-5509
Hydraulic Oil Filter.....	HC-5506
Hydraulic Oil Filter.....	HC-5512
Hydraulic Oil Filter.....	HC-5508
Hydraulic Oil Filter.....	HC-5503
Oil Filter Full Flow.....	C-5516
75C <i>(TRACTORS)</i> CAT (S/N: 43Z2487-UP)	
Fuel Filter.....	FC-5509
Oil Filter Full Flow.....	C-5516
75C <i>(TRACTORS)</i> CAT (S/N: 43Z490-2486-UP)	
Fuel Filter.....	FC-5509
Oil Filter Full Flow.....	C-5516
75C <i>(TRACTORS)</i> S/N: 4KK1-499-UP	
Air Filter Primary.....	A-5535
Air Filter Set.....	A-5573-S
Air Filter Secondary.....	A-5534
Hydraulic Oil Filter.....	HC-5512
Hydraulic Oil Filter.....	HC-5506
Hydraulic Oil Filter.....	HC-5503
75C <i>(TRACTORS)</i> S/N: 4KK500-UP	
Air Filter Secondary.....	A-5534
Air Filter Primary.....	A-5535
Air Filter Set.....	A-5573-S
Hydraulic Oil Filter.....	HC-5512
Hydraulic Oil Filter.....	HC-5506
Hydraulic Oil Filter.....	HC-5503
75D <i>(TRACTORS)</i> CAT S/N: 5AR1-UP	
Air Filter Primary.....	A-5535
Air Filter Set.....	A-5573-S
Air Filter Secondary.....	A-5534
Fuel Filter.....	FC-5509
Fuel Filter.....	FC-5517
Fuel/Water Separator Secondary..	SFC-5504-10B
Fuel/Water Separator Secondary..	SFC-5504-10
Hydraulic Oil Filter.....	HC-5506
Hydraulic Oil Filter.....	HC-5503
Hydraulic Oil Filter.....	HC-5512
Oil Filter Full Flow.....	C-5516
75D <i>(TRACTORS)</i> CAT S/N: 7ZR1-UP	
Air Filter Set.....	A-5573-S
Air Filter Secondary.....	A-5534
Air Filter Primary.....	A-5535
Fuel Filter.....	FC-5517
Fuel Filter.....	FC-5509

MODEL/APPLICATION	SAKURA NO
CATERPILLAR	
75D (TRACTORS) CAT S/N: 7ZR1-UP	
Fuel/Water Separator Secondary..	SFC-5504-10
Fuel/Water Separator Secondary..	SFC-5504-10B
Hydraulic Oil Filter.....	HC-5503
Hydraulic Oil Filter.....	HC-5512
Hydraulic Oil Filter.....	HC-5506
Oil Filter Full Flow.....	C-5516
75E (TRACTORS) CAT S/N: 7ZR1450-4252-UP	
Fuel Filter.....	FC-5517
Oil Filter Full Flow.....	C-5516
75E (TRACTORS) CAT S/N: 7ZR4253-4280-UP	
Fuel Filter.....	FC-5517
Oil Filter Full Flow.....	C-5516
75E (TRACTORS) CAT S/N: 7ZR4281-5544-UP	
Fuel Filter.....	FC-5517
Oil Filter Full Flow.....	C-5516
75E (TRACTORS) CAT S/N: 7ZR5545-UP	
Fuel Filter.....	FC-5517
Oil Filter Full Flow.....	C-5516
75E (TRACTORS) CAT S/N: 7ZR575-1449-UP	
Fuel Filter.....	FC-5517
Oil Filter Full Flow.....	C-5516
75E (TRACTORS) S/N: 1HM1-UP	
Air Filter Secondary.....	A-5534
Air Filter Primary.....	A-5535
Air Filter Set.....	A-5573-S
Fuel/Water Separator Secondary..	SFC-5504-10B
Fuel/Water Separator Secondary..	SFC-5504-10
Hydraulic Oil Filter.....	HC-5503
Hydraulic Oil Filter.....	HC-5506
Hydraulic Oil Filter.....	HC-5512
75E (TRACTORS) S/N: 6HS1-UP	
Air Filter Primary.....	A-5535
Air Filter Set.....	A-5573-S
Air Filter Secondary.....	A-5534
Fuel/Water Separator Secondary..	SFC-5504-10B
Fuel/Water Separator Secondary..	SFC-5504-10
Hydraulic Oil Filter.....	HC-5506
Hydraulic Oil Filter.....	HC-5503
Hydraulic Oil Filter.....	HC-5512
75E (TRACTORS) CAT 3176	
Hydraulic Oil Filter.....	H-5507
768C (DUMP TRUCKS) CAT 3408	
Fuel Filter.....	FC-5519
Oil Filter Full Flow.....	C-5516

MODEL/APPLICATION	SAKURA NO
CATERPILLAR	
768B (DUMP TRUCKS) S/N: 79S1-UP	
Oil Filter Full Flow.....	O-5503
769D (DUMP TRUCKS) CAT 3408E (S/N: 5TR1-504) , 2005-UP	
Air Filter Set.....	A-5555-S
Air Filter Secondary.....	A-5556
Air Filter Primary.....	A-5555
Fuel Filter.....	FC-5509
Fuel/Water Separator Secondary..	SFC-5504-10
Fuel/Water Separator Secondary..	SFC-5504-10B
Hydraulic Oil Filter.....	HC-5511
Hydraulic Oil Filter.....	HC-5504
Hydraulic Oil Filter.....	HC-5516
Oil Filter Full Flow.....	C-5516
769D (DUMP TRUCKS) CAT 3408E (S/N: 5S5-UP)	
Air Filter Secondary.....	A-5556
Air Filter Set.....	A-5555-S
Air Filter Primary.....	A-5555
Coolant Filter.....	WC-5707
Fuel Filter.....	FC-5509
Hydraulic Oil Filter.....	HC-5504
Hydraulic Oil Filter.....	H-5503
Hydraulic Oil Filter.....	HC-5511
Oil Filter Full Flow.....	C-5516
769D (DUMP TRUCKS) CAT 3408E (S/N: 5TR-UP)	
Air Filter Secondary.....	A-5556
Air Filter Set.....	A-5555-S
Air Filter Primary.....	A-5555
Coolant Filter.....	WC-5707
Fuel Filter.....	FC-5509
Hydraulic Oil Filter.....	HC-5504
Hydraulic Oil Filter.....	HC-5511
Hydraulic Oil Filter.....	H-5503
Oil Filter Full Flow.....	C-5516
769D (DUMP TRUCKS) CAT 3408E (S/N: 8BB-UP)	
Air Filter Set.....	A-5555-S
Air Filter Primary.....	A-5555
Air Filter Secondary.....	A-5556
Coolant Filter.....	WC-5707
Fuel Filter.....	FC-5509
Hydraulic Oil Filter.....	HC-5504
Hydraulic Oil Filter.....	HC-5511
Hydraulic Oil Filter.....	H-5503
Oil Filter Full Flow.....	C-5516
769D (DUMP TRUCKS) CAT 3408E TA-HEUI (S/N: 5S51-UP)	
Air Filter Set.....	A-5555-S
Air Filter Primary.....	A-5555
Air Filter Secondary.....	A-5556
Fuel Filter.....	FC-5509
Hydraulic Oil Filter.....	HC-55170
Hydraulic Oil Filter.....	HC-55300
Hydraulic Oil Filter.....	HC-5505
Hydraulic Oil Filter.....	HC-5503
Oil Filter Full Flow.....	C-5516

MODEL/APPLICATION	SAKURA NO
CATERPILLAR	
Hydraulic Oil Filter.....	HC-5516
Oil Filter Full Flow.....	C-5516
769D (DUMP TRUCKS) CAT 3408E TA-HEUI (S/N: 5TR1-504)	
Air Filter Set.....	A-5555-S
Air Filter Secondary.....	A-5556
Air Filter Primary.....	A-5555
Fuel Filter.....	FC-5509
Hydraulic Oil Filter.....	HC-55300
Hydraulic Oil Filter.....	HC-5516
Hydraulic Oil Filter.....	HC-5504
Oil Filter Full Flow.....	C-5516
769D (DUMP TRUCKS) CAT 3408E TA-HEUI (S/N: 5TR1-UP)	
Fuel Filter.....	FC-5509
Hydraulic Oil Filter.....	H-5503
Oil Filter Full Flow.....	C-5516
769D (DUMP TRUCKS) CAT 3408E TA-HEUI (S/N: 5TR505-UP)	
Air Filter Set.....	A-5555-S
Air Filter Secondary.....	A-5556
Air Filter Primary.....	A-5555
Fuel Filter.....	FC-5509
Hydraulic Oil Filter.....	H-5526
Hydraulic Oil Filter.....	H-55270
Hydraulic Oil Filter.....	H-5504
Hydraulic Oil Filter.....	H-55280
Hydraulic Oil Filter.....	H-5503
Oil Filter Full Flow.....	C-5516
769D (DUMP TRUCKS) CAT 3408E TA-HEUI (S/N: BBB1-UP)	
Air Filter Secondary.....	A-5556
Air Filter Primary.....	A-5555
Air Filter Set.....	A-5555-S
Fuel Filter.....	FC-5509
Hydraulic Oil Filter.....	HC-55300
Hydraulic Oil Filter.....	HC-55170
Hydraulic Oil Filter.....	HC-5504
Hydraulic Oil Filter.....	HC-5505
Hydraulic Oil Filter.....	HC-5516
Oil Filter Full Flow.....	C-5516
769D (DUMP TRUCKS)	
Fuel/Water Separator Primary....	SFC-5504-30
Fuel/Water Separator Primary....	SFC-5504-30B
769 (DUMP TRUCKS) S/N: 1X1-UP	
Air Filter Set.....	A-5521-S
Air Filter Primary.....	A-5521
Air Filter Secondary.....	A-5529
Fuel Filter.....	FC-5519
Hydraulic Oil Filter.....	H-5504
Hydraulic Oil Filter.....	H-5503
Oil Filter Full Flow.....	C-5516
769 (DUMP TRUCKS) S/N: 99F1-1229	
Air Filter Secondary.....	A-5520
Air Filter Set.....	A-5544-S

MODEL/APPLICATION	SAKURA NO
CATERPILLAR	
769 (DUMP TRUCKS) S/N: 99F1-1229	
Air Filter Primary.....	A-5543
Hydraulic Oil Filter.....	H-5503
Hydraulic Oil Filter.....	H-55280
Oil Filter Full Flow.....	O-5503
769 (DUMP TRUCKS) S/N: 99F1230-UP	
Air Filter Secondary.....	A-5520
Air Filter Set.....	A-5544-S
Air Filter Primary.....	A-5543
Hydraulic Oil Filter.....	H-5503
Oil Filter Full Flow.....	O-5503
769 (DUMP TRUCKS) S/N: 99F1231-1237	
Air Filter Primary.....	A-5543
Air Filter Set.....	A-5544-S
Air Filter Secondary.....	A-5520
Hydraulic Oil Filter.....	H-55280
Hydraulic Oil Filter.....	H-5503
Oil Filter Full Flow.....	O-5503
769 (DUMP TRUCKS) S/N: 99F1238-UP	
Air Filter Primary.....	A-5543
Air Filter Set.....	A-5544-S
Air Filter Secondary.....	A-5520
Hydraulic Oil Filter.....	H-5503
Hydraulic Oil Filter.....	H-55280
Oil Filter Full Flow.....	O-5503
769B (DUMP TRUCKS) S/N: 99F1-1229	
Air Filter Primary.....	A-5543
Air Filter Set.....	A-5544-S
Air Filter Primary.....	A-5558
Air Filter Secondary.....	A-5559
Air Filter Secondary.....	A-5520
Fuel Filter.....	F-5501
Hydraulic Oil Filter.....	H-5503
Oil Filter Full Flow.....	O-5503
769B (DUMP TRUCKS) S/N: 99F1230-UP	
Air Filter Primary.....	A-5558
Air Filter Secondary.....	A-5520
Air Filter Primary.....	A-5543
Air Filter Secondary.....	A-5559
Air Filter Set.....	A-5544-S
Fuel Filter Secondary.....	FC-5507
Hydraulic Oil Filter.....	H-5503
Oil Filter Full Flow.....	O-5503
769C (DUMP TRUCKS) CAT 3408 (S/N: 01X02877-05473) , 2005-UP	
Air Filter Secondary.....	A-5529
Air Filter Set.....	A-5521-S
Air Filter Primary.....	A-5521
Fuel Filter.....	FC-5509
Hydraulic Oil Filter.....	H-5503
Hydraulic Oil Filter.....	H-5504
Oil Filter Full Flow.....	C-5516

MODEL/APPLICATION	SAKURA NO
CATERPILLAR	
769C (DUMP TRUCKS) CAT 3408 (S/N: 01X05474-06324) , 2005-UP	
Air Filter Secondary.....	A-5529
Air Filter Primary.....	A-5521
Air Filter Set.....	A-5521-S
Fuel Filter.....	FC-5509
Hydraulic Oil Filter.....	H-5504
Hydraulic Oil Filter.....	H-5503
Oil Filter Full Flow.....	C-5516
769C (DUMP TRUCKS) CAT 3408 (S/N: 01X06325-06599) , 2005-UP	
Air Filter Set.....	A-5555-S
Air Filter Primary.....	A-5555
Air Filter Secondary.....	A-5556
Fuel Filter.....	FC-5509
Hydraulic Oil Filter.....	H-5503
Hydraulic Oil Filter.....	H-5504
Oil Filter Full Flow.....	C-5516
769C (DUMP TRUCKS) CAT 3408 (S/N: 01X1-02876) , 2005-UP	
Air Filter Secondary.....	A-5529
Air Filter Set.....	A-5521-S
Air Filter Primary.....	A-5521
Fuel Filter.....	FC-5509
Hydraulic Oil Filter.....	H-5504
Hydraulic Oil Filter.....	H-5503
769C (DUMP TRUCKS)	
Air Filter Secondary.....	A-5529
Air Filter.....	AH-7001
Air Filter Set.....	A-5521-S
Air Filter Primary.....	A-5521
Coolant Filter.....	WC-5707
Fuel Filter.....	FC-5519
Hydraulic Oil Filter.....	H-5503
Hydraulic Oil Filter.....	H-5504
Oil Filter Full Flow.....	C-5516
769C (DUMP TRUCKS) S/N: 1X6325-UP	
Air Filter Primary.....	A-5555
Air Filter Secondary.....	A-5556
Air Filter Set.....	A-5521-S
Air Filter Set.....	A-5555-S
Air Filter Secondary.....	A-5529
Air Filter Primary.....	A-5521
Fuel Filter.....	FC-5519
Fuel Filter.....	FC-5509
Hydraulic Oil Filter.....	H-5503
Oil Filter Full Flow.....	C-5516
769D US (DUMP TRUCKS) CAT 3408E (S/N: 5TR1-UP) , 2005-UP	
Air Filter Primary.....	A-5555
Air Filter Set.....	A-5555-S
Air Filter.....	AH-7001
Air Filter Secondary.....	A-5556
Fuel Filter.....	FC-5509
Fuel/Water Separator Secondary..	SFC-5504-10
Fuel/Water Separator Secondary..	SFC-5504-10B

MODEL/APPLICATION	SAKURA NO
CATERPILLAR	
Hydraulic Oil Filter.....	H-5504
Hydraulic Oil Filter.....	H-5503
Oil Filter Full Flow.....	C-5516
771D (DUMP TRUCKS) CAT 3408E (S/N: 6JR1-UP) , 2005-UP	
Air Filter Primary.....	A-5555
Air Filter Set.....	A-5555-S
Air Filter Secondary.....	A-5556
Fuel Filter.....	FC-5509
Fuel/Water Separator Secondary..	SFC-5504-10
Fuel/Water Separator Secondary..	SFC-5504-10B
Hydraulic Oil Filter.....	H-5504
Hydraulic Oil Filter.....	H-5503
Oil Filter Full Flow.....	C-5516
771D (DUMP TRUCKS) CAT 3408E (S/N: 6YS1-UP) , 2005-UP	
Air Filter Secondary.....	A-5556
Air Filter Set.....	A-5555-S
Air Filter Primary.....	A-5555
Fuel Filter.....	FC-5509
Fuel/Water Separator Secondary..	SFC-5504-10
Fuel/Water Separator Secondary..	SFC-5504-10B
Hydraulic Oil Filter.....	HC-5504
Hydraulic Oil Filter.....	HC-5505
Hydraulic Oil Filter.....	HC-5511
Hydraulic Oil Filter.....	HC-5516
Oil Filter Full Flow.....	C-5516
771D (DUMP TRUCKS) CAT 3408E (S/N: BCA1-UP)	
Air Filter Set.....	A-5555-S
Air Filter Primary.....	A-5555
Air Filter Secondary.....	A-5556
Air Filter.....	AH-7001
Fuel Filter.....	FC-5509
Fuel/Water Separator Secondary..	SFC-5504-10B
Fuel/Water Separator Secondary..	SFC-5504-10
Hydraulic Oil Filter.....	HC-5505
Hydraulic Oil Filter.....	HC-5504
Hydraulic Oil Filter.....	HC-5511
Hydraulic Oil Filter.....	HC-5516
Oil Filter Full Flow.....	C-5516
771D (DUMP TRUCKS) CAT 3408E TA-HEUI (S/N: 6YS1-UP)	
Air Filter Primary.....	A-5555
Air Filter Set.....	A-5555-S
Air Filter Secondary.....	A-5556
Fuel Filter.....	FC-5509
Hydraulic Oil Filter.....	HC-5504
Hydraulic Oil Filter.....	HC-5505
Hydraulic Oil Filter.....	HC-5516
Hydraulic Oil Filter.....	HC-55170
Hydraulic Oil Filter.....	HC-55300
Oil Filter Full Flow.....	C-5516
771C (DUMP TRUCKS) S/N: 3BJ1-UP	
Air Filter Set.....	A-5555-S
Air Filter Secondary.....	A-5556
Air Filter Primary.....	A-5555

Sakura Filter

ENGINE APPLICATION

MODEL/APPLICATION	SAKURA NO
CATERPILLAR	
771C (DUMP TRUCKS) S/N: 3BJ200-UP	
Air Filter Set.....	A-5555-S
Air Filter Secondary.....	A-5556
Air Filter Primary.....	A-5555
Fuel Filter.....	F-5505
Fuel Filter.....	FC-5509
Hydraulic Oil Filter.....	H-5526
Hydraulic Oil Filter.....	H-55270
Hydraulic Oil Filter.....	H-5504
Hydraulic Oil Filter.....	H-55280
Hydraulic Oil Filter.....	H-5503
Oil Filter Full Flow.....	C-5516
771D US (DUMP TRUCKS) CAT 3408E (S/N: 6JR1-UP)	
Air Filter Primary.....	A-5555
Air Filter Secondary.....	A-5556
Air Filter Set.....	A-5555-S
Air Filter.....	AH-7001
Fuel Filter.....	FC-5509
Fuel/Water Separator Secondary..	SFC-5504-10B
Fuel/Water Separator Secondary..	SFC-5504-10
Hydraulic Oil Filter.....	H-5504
Hydraulic Oil Filter.....	H-5503
Oil Filter Full Flow.....	C-5516
772 (DUMP TRUCKS) CAT S/N: RHX1-UP	
Air Filter Primary.....	A-8686
Air Filter Set.....	A-7627-S
Air Filter Secondary.....	A-8580
Air Filter Primary.....	A-8665M
Air Filter Secondary.....	A-7626
Cabin Air Filter.....	CA-55060
Fuel Filter.....	FC-5510
Fuel Filter.....	FC-5517
Hydraulic Oil Filter.....	HC-5516
Hydraulic Oil Filter.....	H-5001
Hydraulic Oil Filter.....	H-55270
Hydraulic Oil Filter.....	HC-55170
Hydraulic Oil Filter.....	HC-55300
Hydraulic Oil Filter.....	HC-5505
772 (DUMP TRUCKS) CAT S/N: RLB1-UP	
Air Filter Primary.....	A-8686
Air Filter Primary.....	A-8665M
Air Filter Set.....	A-7627-S
Air Filter Secondary.....	A-7626
Air Filter Secondary.....	A-8580
Cabin Air Filter.....	CA-55060
Fuel Filter.....	FC-5510
Fuel Filter.....	FC-5517
Hydraulic Oil Filter.....	H-55270
Hydraulic Oil Filter.....	HC-5505
Hydraulic Oil Filter.....	HC-55300
Hydraulic Oil Filter.....	HC-55170
Hydraulic Oil Filter.....	HC-5516
Hydraulic Oil Filter.....	H-5001
772 (DUMP TRUCKS)	

MODEL/APPLICATION	SAKURA NO
CATERPILLAR	
Air Filter Secondary.....	A-5520
Air Filter Set.....	A-5544-S
Air Filter Primary.....	A-5543
Fuel Filter.....	FC-5523
Fuel Filter.....	FC-5501
Hydraulic Oil Filter.....	H-5503
Oil Filter Full Flow.....	O-5503
Oil Filter Full Flow.....	O-5502
772B (DUMP TRUCKS) CAT 3412	
Fuel Filter.....	FC-5519
Oil Filter Full Flow.....	C-5516
773 (DUMP TRUCKS) S/N: 63G1-252	
Air Filter Secondary.....	A-5520
Air Filter Primary.....	A-5543
Air Filter Set.....	A-5544-S
Hydraulic Oil Filter.....	H-5503
Oil Filter Full Flow.....	O-5501
773 (DUMP TRUCKS) S/N: 63G253-339	
Air Filter Secondary.....	A-5520
Air Filter Set.....	A-5544-S
Air Filter Primary.....	A-5543
Air Filter Secondary.....	A-5559
Air Filter Primary.....	A-5558
Fuel Filter Secondary.....	FC-5507
Hydraulic Oil Filter.....	H-5503
Oil Filter Full Flow.....	O-5503
773 (DUMP TRUCKS) S/N: 63G340-858	
Air Filter Secondary.....	A-5520
Air Filter Primary.....	A-5558
Air Filter Set.....	A-5544-S
Air Filter Secondary.....	A-5559
Air Filter Primary.....	A-5543
Fuel Filter Secondary.....	FC-5507
Hydraulic Oil Filter.....	H-5503
Oil Filter Full Flow.....	O-5503
773 (DUMP TRUCKS) S/N: 63G859-UP	
Air Filter Set.....	A-5544-S
Air Filter Primary.....	A-5543
Air Filter Primary.....	A-5558
Air Filter Secondary.....	A-5559
Air Filter Secondary.....	A-5520
Fuel Filter Secondary.....	FC-5507
Hydraulic Oil Filter.....	H-5503
Oil Filter Full Flow.....	C-5516
773B (DUMP TRUCKS) CAT 3412 (S/N: 63W1-UP) , 2005-UP	
Air Filter Set.....	A-5521-S
Air Filter Primary.....	A-5521
Air Filter Secondary.....	A-5529
Coolant Filter.....	WC-5707
Coolant Filter.....	WC-5705
Fuel Filter.....	FC-5509
Hydraulic Oil Filter.....	H-5503

MODEL/APPLICATION	SAKURA NO
CATERPILLAR	
Oil Filter Full Flow.....	C-5516
773B (DUMP TRUCKS) S/N: 63W1-UP	
Air Filter Secondary.....	A-5556
Air Filter Set.....	A-5521-S
Air Filter Primary.....	A-5521
Air Filter Set.....	A-5555-S
Air Filter Secondary.....	A-5529
Air Filter Primary.....	A-5555
Fuel Filter.....	FC-5519
Fuel Filter.....	FC-5509
Hydraulic Oil Filter.....	H-5503
Oil Filter Full Flow.....	C-5516
773D (DUMP TRUCKS) CAT 3412E (S/N: 7CS1-00480) , 2005-UP	
Air Filter.....	AH-7001
773D (DUMP TRUCKS) CAT 3412E (S/N: 7CS1-UP) , 2005-UP	
Air Filter Set.....	A-5555-S
Air Filter Primary.....	A-5555
Air Filter Secondary.....	A-5556
Fuel Filter.....	FC-5509
Fuel/Water Separator Secondary..	SFC-5504-10B
Fuel/Water Separator Secondary..	SFC-5504-10
Hydraulic Oil Filter.....	HC-5505
Hydraulic Oil Filter.....	HC-5516
Hydraulic Oil Filter.....	HC-5511
Hydraulic Oil Filter.....	HC-5504
Oil Filter Full Flow.....	C-5516
773D (DUMP TRUCKS) CAT 3412E (S/N: 7ER1-UP) , 2005-UP	
Air Filter Secondary.....	A-5556
Air Filter Set.....	A-5555-S
Air Filter Primary.....	A-5555
Fuel Filter.....	FC-5509
Fuel/Water Separator Secondary..	SFC-5504-10B
Fuel/Water Separator Secondary..	SFC-5504-10
Hydraulic Oil Filter.....	H-5503
Oil Filter Full Flow.....	C-5516
773D (DUMP TRUCKS)	
Fuel/Water Separator Primary....	SFC-5504-30B
Fuel/Water Separator Primary....	SFC-5504-30
773D (DUMP TRUCKS) S/N: 7ER1-UP	
Air Filter Secondary.....	A-5556
Air Filter Primary.....	A-5555
Air Filter Set.....	A-5555-S
Fuel Filter.....	FC-5509
Hydraulic Oil Filter.....	H-5503
Hydraulic Oil Filter.....	H-5526
Hydraulic Oil Filter.....	H-55280
Oil Filter Full Flow.....	C-5516
773E (DUMP TRUCKS) CAT 3412E (S/N: BDA1-478) , 2005-UP	
Air Filter.....	AH-7001
773E (DUMP TRUCKS) CAT 3412E (S/N: BDA1-UP) , 2005-UP	

MODEL/APPLICATION	SAKURA NO
-------------------	-----------

CATERPILLAR

773E
(DUMP TRUCKS)
CAT 3412E (S/N: BDA1-UP) , 2005-UP

Air Filter Secondary.....	A-5556
Air Filter Primary.....	A-5555
Air Filter Set.....	A-5555-S
Fuel Filter.....	FC-5509
Fuel/Water Separator Secondary..	SFC-5504-10B
Fuel/Water Separator Secondary..	SFC-5504-10
Hydraulic Oil Filter.....	HC-5504
Hydraulic Oil Filter.....	HC-55300
Hydraulic Oil Filter.....	HC-5505
Hydraulic Oil Filter.....	HC-5516
Hydraulic Oil Filter.....	HC-5511
Hydraulic Oil Filter.....	HC-55170
Oil Filter Full Flow.....	C-5516

773E
(DUMP TRUCKS)
CAT 3412E (S/N: BDA259-478) , 2005-UP

Air Filter Set.....	A-5555-S
Air Filter Primary.....	A-5555
Air Filter Secondary.....	A-5556
Fuel Filter.....	FC-5509
Fuel/Water Separator Secondary..	SFC-5504-10B
Fuel/Water Separator Secondary..	SFC-5504-10
Hydraulic Oil Filter.....	HC-5504
Hydraulic Oil Filter.....	HC-5516
Hydraulic Oil Filter.....	HC-55300
Hydraulic Oil Filter.....	HC-5505
Hydraulic Oil Filter.....	HC-5511
Hydraulic Oil Filter.....	HC-55170
Oil Filter Full Flow.....	C-5516

773E
(DUMP TRUCKS)
CAT S/N: 5JJ264-UP , 2005-UP

Air Filter Primary.....	A-5555
Air Filter Secondary.....	A-5556
Air Filter Set.....	A-5555-S
Fuel Filter.....	FC-5509
Fuel/Water Separator Secondary..	SFC-5504-10B
Fuel/Water Separator Secondary..	SFC-5504-10
Hydraulic Oil Filter.....	HC-55290
Hydraulic Oil Filter.....	HC-55300
Hydraulic Oil Filter.....	HC-55170
Hydraulic Oil Filter.....	HC-5516
Hydraulic Oil Filter.....	HC-5511
Hydraulic Oil Filter.....	HC-5504
Hydraulic Oil Filter.....	HC-5505
Oil Filter Full Flow.....	C-5516

773E
(DUMP TRUCKS)
CAT S/N: BDA1-159-UP , 2005-UP

Air Filter Primary.....	A-5555
Air Filter Secondary.....	A-5556
Air Filter Set.....	A-5555-S
Fuel Filter.....	FC-5509
Fuel/Water Separator Secondary..	SFC-5504-10
Fuel/Water Separator Secondary..	SFC-5504-10B
Hydraulic Oil Filter.....	HC-55170
Hydraulic Oil Filter.....	HC-5516
Hydraulic Oil Filter.....	HC-5511
Hydraulic Oil Filter.....	HC-55290
Hydraulic Oil Filter.....	HC-5505

MODEL/APPLICATION	SAKURA NO
-------------------	-----------

CATERPILLAR

Hydraulic Oil Filter.....	HC-55300
Hydraulic Oil Filter.....	HC-5504
Oil Filter Full Flow.....	C-5516

773E
(DUMP TRUCKS)
CAT S/N: BDA160-UP , 2005-UP

Air Filter Primary.....	A-5555
Air Filter Secondary.....	A-5556
Air Filter Set.....	A-5555-S
Fuel Filter.....	FC-5509
Fuel/Water Separator Secondary..	SFC-5504-10
Fuel/Water Separator Secondary..	SFC-5504-10B
Hydraulic Oil Filter.....	HC-5504
Hydraulic Oil Filter.....	HC-5505
Hydraulic Oil Filter.....	HC-55300
Hydraulic Oil Filter.....	HC-55290
Hydraulic Oil Filter.....	HC-5511
Hydraulic Oil Filter.....	HC-55170
Hydraulic Oil Filter.....	HC-5516
Oil Filter Full Flow.....	C-5516

773E
(DUMP TRUCKS)
CAT 3412E

Fuel/Water Separator Primary....	SFC-5504-30
Fuel/Water Separator Primary....	SFC-5504-30B

773F
(DUMP TRUCKS)
2007-UP

Air Filter Secondary.....	A-7626
Air Filter Set.....	A-7627-S
Air Filter Primary.....	A-8686
Fuel Filter.....	FC-5503
Hydraulic Oil Filter.....	HC-55200
Hydraulic Oil Filter.....	H-5504

773D US
(DUMP TRUCKS)
CAT 3412E (S/N: 7ER1-UP) , 2005-UP

Air Filter Secondary.....	A-5556
Air Filter.....	AH-7001
Air Filter Set.....	A-5555-S
Air Filter Primary.....	A-5555
Fuel Filter.....	FC-5509
Fuel/Water Separator Secondary..	SFC-5504-10
Fuel/Water Separator Secondary..	SFC-5504-10B
Hydraulic Oil Filter.....	H-5503
Oil Filter Full Flow.....	C-5516

775
(DUMP TRUCKS)

Fuel Filter.....	FC-5506
Hydraulic Oil Filter.....	H-5503
Hydraulic Oil Filter.....	H-5517

775B
(DUMP TRUCKS)
CAT 3412 (S/N: 7XJ200-UP) , 2005-UP

Air Filter Secondary.....	A-5556
Air Filter Secondary.....	A-5529
Air Filter Primary.....	A-5555
Air Filter Set.....	A-5521-S
Air Filter Set.....	A-5555-S
Air Filter Primary.....	A-5521
Fuel Filter.....	F-5505
Fuel Filter.....	FC-5509
Hydraulic Oil Filter.....	H-5503
Oil Filter Full Flow.....	C-5516

MODEL/APPLICATION	SAKURA NO
-------------------	-----------

CATERPILLAR

775B
(DUMP TRUCKS)
S/N: 7XJ1-UP

Air Filter Set.....	A-5555-S
Air Filter Secondary.....	A-5556
Air Filter Primary.....	A-5555

775B
(DUMP TRUCKS)
S/N: 7XJ200-UP

Air Filter Primary.....	A-5555
Air Filter Set.....	A-5521-S
Air Filter Set.....	A-5555-S
Air Filter Secondary.....	A-5556
Air Filter Primary.....	A-5521
Fuel Filter.....	FC-5509
Hydraulic Oil Filter.....	H-55280
Hydraulic Oil Filter.....	H-5503
Hydraulic Oil Filter.....	H-5526
Oil Filter Full Flow.....	C-5516

775D
(DUMP TRUCKS)
CAT 3412E (S/N: 6KR1-123) , 2005-UP

Air Filter Secondary.....	A-5556
Air Filter Primary.....	A-5555
Air Filter Set.....	A-5555-S
Fuel Filter.....	FC-5509
Fuel/Water Separator Secondary..	SFC-5504-10
Fuel/Water Separator Secondary..	SFC-5504-10B
Hydraulic Oil Filter.....	H-5503
Oil Filter Full Flow.....	C-5516

775D
(DUMP TRUCKS)
CAT 3412E (S/N: 8AS1-UP) , 2005-UP

Air Filter Secondary.....	A-5556
Air Filter.....	AH-7001
Air Filter Primary.....	A-5555
Air Filter Set.....	A-5555-S
Fuel Filter.....	FC-5509
Fuel/Water Separator Secondary..	SFC-5504-10B
Fuel/Water Separator Secondary..	SFC-5504-10
Hydraulic Oil Filter.....	HC-5504
Hydraulic Oil Filter.....	HC-5505
Hydraulic Oil Filter.....	HC-5511
Hydraulic Oil Filter.....	HC-5516
Oil Filter Full Flow.....	C-5516

775D
(DUMP TRUCKS)

Fuel/Water Separator Primary....	SFC-5504-30
Fuel/Water Separator Primary....	SFC-5504-30B

775D
(DUMP TRUCKS)
S/N: 6KR1-123

Air Filter Secondary.....	A-5556
Air Filter Primary.....	A-5555
Air Filter Set.....	A-5555-S
Fuel Filter.....	FC-5509
Hydraulic Oil Filter.....	H-55280
Hydraulic Oil Filter.....	H-5503
Hydraulic Oil Filter.....	H-5526
Oil Filter Full Flow.....	C-5516

775E
(DUMP TRUCKS)
CAT 3412E (S/N: BEC1-UP) , 2005-UP

Air Filter Secondary.....	A-5556
---------------------------	--------

MODEL/APPLICATION	SAKURA NO
-------------------	-----------

CATERPILLAR

775E
(DUMP TRUCKS)
CAT 3412E (S/N: BEC1-UP) , 2005-UP

Air Filter Primary.....	A-5555
Air Filter.....	AH-7001
Air Filter Set.....	A-5555-S
Fuel Filter.....	FC-5509
Fuel/Water Separator Secondary..	SFC-5504-10
Fuel/Water Separator Secondary..	SFC-5504-10B
Hydraulic Oil Filter.....	HC-5504
Hydraulic Oil Filter.....	HC-5511
Hydraulic Oil Filter.....	HC-5516
Hydraulic Oil Filter.....	HC-5505
Oil Filter Full Flow.....	C-5516

775E
(DUMP TRUCKS)

Fuel/Water Separator Primary....	SFC-5504-30
Fuel/Water Separator Primary....	SFC-5504-30B

775F
(DUMP TRUCKS)
CAT S/N: DLS1-UP , 2006-UP

Air Filter Secondary.....	A-7626
Air Filter Set.....	A-7627-S
Air Filter Primary.....	A-8686
Fuel Filter.....	FC-5510
Hydraulic Oil Filter.....	HC-55170
Hydraulic Oil Filter.....	H-5001
Hydraulic Oil Filter.....	HC-5505
Oil Filter Full Flow.....	C-5516

775F
(DUMP TRUCKS)
CAT S/N: LJX1-UP , 2006-UP

Air Filter Set.....	A-7627-S
Air Filter Secondary.....	A-7626
Air Filter Primary.....	A-8686
Fuel Filter.....	FC-5510
Hydraulic Oil Filter.....	HC-55170
Hydraulic Oil Filter.....	H-5001
Hydraulic Oil Filter.....	HC-5505
Oil Filter Full Flow.....	C-5516

775B US
(DUMP TRUCKS)
CAT 3412 DITA (S/N: 7XJ200-UP) , 2005-UP

Air Filter.....	AH-7001
Air Filter Primary.....	A-5555
Air Filter Set.....	A-5555-S
Air Filter Secondary.....	A-5556
Fuel Filter.....	FC-5509
Fuel/Water Separator Secondary..	SFC-5504-10B
Fuel/Water Separator Secondary..	SFC-5504-10
Hydraulic Oil Filter.....	H-5503
Oil Filter Full Flow.....	C-5516

775D US
(DUMP TRUCKS)
CAT 3412 DITA (S/N: 6KR124-UP) , 2005-UP

Air Filter Primary.....	A-5555
Air Filter Set.....	A-5555-S
Air Filter Secondary.....	A-5556
Air Filter.....	AH-7001
Fuel Filter.....	FC-5509
Fuel/Water Separator Secondary..	SFC-5504-10B
Fuel/Water Separator Secondary..	SFC-5504-10
Hydraulic Oil Filter.....	H-5503

MODEL/APPLICATION	SAKURA NO
-------------------	-----------

CATERPILLAR

Oil Filter Full Flow.....	C-5516
---------------------------	--------

776
(DUMP TRUCKS)
CAT D348

Air Filter.....	A-5518
Fuel Filter.....	F-5501
Oil Filter Full Flow.....	O-5503
Oil Filter Full Flow.....	O-5501

776
(DUMP TRUCKS)
S/N: 14H1-UP

Air Filter Secondary.....	A-5502
Air Filter Primary.....	A-5501
Fuel Filter.....	F-5501
Hydraulic Oil Filter.....	H-5503

776
(DUMP TRUCKS)
w/D348 Eng.

Hydraulic Oil Filter.....	H-55320
---------------------------	---------

776B
(DUMP TRUCKS)
S/N: 6J31-UP

Air Filter Set.....	A-5544-S
Air Filter Primary.....	A-5543
Air Filter Primary.....	A-5558
Air Filter Secondary.....	A-7915
Fuel Filter.....	FC-5506
Hydraulic Oil Filter.....	H-5503
Oil Filter Full Flow.....	C-5516
Oil Filter Full Flow.....	O-5502

776D
(DUMP TRUCKS)
CAT (S/N: 2GR1-2632-UP)

Air Filter Secondary.....	A-5594
Air Filter Set.....	A-44240-S
Air Filter Primary.....	A-44220
Air Filter Secondary.....	A-5715
Air Filter Secondary.....	A-44230
Air Filter Set.....	A-5595-S
Air Filter Primary.....	A-5593
Fuel Filter.....	FC-5510

776D
(DUMP TRUCKS)
CAT (S/N: 2GR2633-UP)

Air Filter Secondary.....	A-5594
Air Filter Set.....	A-44240-S
Air Filter Primary.....	A-44220
Air Filter Set.....	A-5595-S
Air Filter Primary.....	A-5593
Air Filter Secondary.....	A-5715
Air Filter Secondary.....	A-44230
Fuel Filter.....	FC-5510

776D
(DUMP TRUCKS)

Air Filter Set.....	A-5595-S
Air Filter Primary.....	A-5593
Air Filter Secondary.....	A-5594
Hydraulic Oil Filter.....	H-5504

776D
(DUMP TRUCKS)
S/N: 5ER1-122-UP

Air Filter Primary.....	A-5593
Air Filter Set.....	A-5595-S
Hydraulic Oil Filter.....	H-55270
Hydraulic Oil Filter.....	H-5503

MODEL/APPLICATION	SAKURA NO
-------------------	-----------

CATERPILLAR

Hydraulic Oil Filter.....	H-55280
Hydraulic Oil Filter.....	H-5526

776D
(DUMP TRUCKS)
S/N: 5ER123-UP

Air Filter Primary.....	A-5593
Air Filter Set.....	A-5595-S
Hydraulic Oil Filter.....	H-55280
Hydraulic Oil Filter.....	H-5503
Hydraulic Oil Filter.....	H-55270
Hydraulic Oil Filter.....	H-5526

776D
(DUMP TRUCKS)
S/N: AFS1-80-UP

Air Filter Primary.....	A-5593
Air Filter Set.....	A-5595-S
Fuel Filter Secondary.....	FC-5507
Hydraulic Oil Filter.....	HC-55170
Hydraulic Oil Filter.....	H-55270
Hydraulic Oil Filter.....	H-55280
Hydraulic Oil Filter.....	H-5503
Hydraulic Oil Filter.....	HC-5511
Hydraulic Oil Filter.....	HC-5505
Hydraulic Oil Filter.....	H-5526
Hydraulic Oil Filter.....	HC-55290

776D
(DUMP TRUCKS)
S/N: AFS81-UP

Air Filter Set.....	A-5595-S
Air Filter Primary.....	A-5593
Fuel Filter Secondary.....	FC-5507
Hydraulic Oil Filter.....	HC-5505
Hydraulic Oil Filter.....	H-5526
Hydraulic Oil Filter.....	H-55280
Hydraulic Oil Filter.....	HC-5511
Hydraulic Oil Filter.....	HC-55290
Hydraulic Oil Filter.....	H-5503
Hydraulic Oil Filter.....	HC-55170
Hydraulic Oil Filter.....	H-55270

776C
(DUMP TRUCKS)
CAT S/N: 2TK1-UP

Air Filter Set.....	A-5595-S
Air Filter Secondary.....	A-7915
Air Filter Secondary.....	A-5594
Air Filter Primary.....	A-5593
Fuel Filter.....	FC-5506
Fuel Filter.....	FC-5510
Hydraulic Oil Filter.....	H-55270
Hydraulic Oil Filter.....	H-5503

776C
(DUMP TRUCKS)
CAT S/N: 7YG1-211-UP

Air Filter Set.....	A-5595-S
Air Filter Secondary.....	A-7915
Air Filter Primary.....	A-5593
Air Filter Secondary.....	A-5594
Fuel Filter.....	FC-5506
Fuel Filter.....	FC-5510
Hydraulic Oil Filter.....	H-55270
Hydraulic Oil Filter.....	H-5503

776C
(DUMP TRUCKS)
CAT S/N: 7YG212-UP

MODEL/APPLICATION	SAKURA NO
CATERPILLAR	
776C (DUMP TRUCKS) CAT S/N: 7YG212-UP	
Air Filter Primary.....	A-5593
Air Filter Secondary.....	A-5594
Air Filter Secondary.....	A-7915
Air Filter Set.....	A-5595-S
Fuel Filter.....	FC-5506
Fuel Filter.....	FC-5510
Hydraulic Oil Filter.....	H-55270
Hydraulic Oil Filter.....	H-5503
776D US (DUMP TRUCKS) CAT 3508B (S/N: 5ER1-UP)	
Air Filter Secondary.....	A-5594
Air Filter Primary.....	A-5593
Air Filter.....	AH-7001
Air Filter Set.....	A-5595-S
Fuel Filter.....	FC-5510
Fuel Filter.....	F-5505
Hydraulic Oil Filter.....	H-5504
Hydraulic Oil Filter.....	H-5503
777 (DUMP TRUCKS) CAT (S/N: 2GR1-2632-UP)	
Air Filter Primary.....	A-44220
Air Filter Secondary.....	A-5594
Air Filter Set.....	A-44240-S
Air Filter Secondary.....	A-5715
Air Filter Secondary.....	A-44230
Air Filter Primary.....	A-5593
Air Filter Set.....	A-5595-S
Fuel Filter.....	FC-5510
777 (DUMP TRUCKS) S/N: 84A1-559-UP	
Hydraulic Oil Filter.....	H-5503
Hydraulic Oil Filter.....	H-55270
777 (DUMP TRUCKS) S/N: 84A1-UP	
Air Filter Primary.....	A-5535
Air Filter Secondary.....	A-5502
Air Filter Secondary.....	A-5534
Air Filter Set.....	A-5573-S
Air Filter Primary.....	A-5501
Fuel Filter.....	F-5501
Hydraulic Oil Filter.....	H-5503
Oil Filter Full Flow.....	C-5516
777A (DUMP TRUCKS) CAT D348	
Air Filter Secondary.....	A-5502
Fuel Filter.....	F-5501
Hydraulic Oil Filter.....	H-5503
777B (DUMP TRUCKS) CAT 3508 (S/N: 4YC1-UP) , 2005-UP	
Fuel Filter.....	FC-5510
Hydraulic Oil Filter.....	H-5504
Hydraulic Oil Filter.....	H-5503
777B (DUMP TRUCKS) S/N: 3NF1-UP	
Air Filter Secondary.....	A-5594
Air Filter Primary.....	A-5593

MODEL/APPLICATION	SAKURA NO
CATERPILLAR	
Air Filter Set.....	A-5595-S
777B (DUMP TRUCKS) S/N: 4YC1-UP	
Air Filter Secondary.....	A-5594
Air Filter Primary.....	A-5593
Air Filter Set.....	A-5595-S
Air Filter Secondary.....	A-7915
Fuel Filter.....	FC-5510
Fuel Filter.....	FC-5506
Hydraulic Oil Filter.....	H-5503
Oil Filter Full Flow.....	C-5516
777C (DUMP TRUCKS) S/N: 4XJ1-UP	
Air Filter Set.....	A-5595-S
Air Filter Primary.....	A-5593
Air Filter Secondary.....	A-5594
Fuel Filter.....	FC-5510
Hydraulic Oil Filter.....	H-5503
777D (DUMP TRUCKS) CAT 3512B (S/N: 3PR1-UP) , 2005-UP	
Air Filter Set.....	A-5595-S
Air Filter Primary.....	A-5593
Air Filter Secondary.....	A-5594
Fuel Filter.....	F-5505
Fuel Filter.....	FC-5510
Hydraulic Oil Filter.....	H-5503
Hydraulic Oil Filter.....	H-5504
777D (DUMP TRUCKS) CAT 3512B (S/N: AGC1-UP) , 2005-UP	
Air Filter Secondary.....	A-5594
Air Filter.....	AH-7001
Air Filter Set.....	A-5595-S
Air Filter Primary.....	A-5593
Fuel Filter.....	F-5505
Fuel Filter.....	FC-5510
Hydraulic Oil Filter.....	H-55270
Hydraulic Oil Filter.....	H-5503
Hydraulic Oil Filter.....	HC-5511
Hydraulic Oil Filter.....	H-5504
Hydraulic Oil Filter.....	HC-5505
777D (DUMP TRUCKS) CAT 3512B (S/N: AGY1-UP) , 2005-UP	
Air Filter Secondary.....	A-5715
Fuel Filter.....	FC-5510
Fuel Filter.....	F-5505
Hydraulic Oil Filter.....	HC-5505
Hydraulic Oil Filter.....	H-5503
Hydraulic Oil Filter.....	H-5504
Hydraulic Oil Filter.....	HC-5511
777D (DUMP TRUCKS) CAT 3508B EUI (S/N: 3PR1-UP)	
Air Filter Primary.....	A-5593
Air Filter Set.....	A-5595-S
Air Filter Secondary.....	A-5594
Fuel Filter.....	FC-5510
Hydraulic Oil Filter.....	H-55270
Hydraulic Oil Filter.....	H-5526
Hydraulic Oil Filter.....	H-5503

MODEL/APPLICATION	SAKURA NO
CATERPILLAR	
Hydraulic Oil Filter.....	H-55280
Hydraulic Oil Filter.....	H-5504
777D (DUMP TRUCKS) CAT 3508B EUI (S/N: AGC1-UP)	
Air Filter Secondary.....	A-5594
Air Filter Set.....	A-5595-S
Air Filter Primary.....	A-5593
Fuel Filter.....	FC-5510
Hydraulic Oil Filter.....	H-55270
Hydraulic Oil Filter.....	H-5503
Hydraulic Oil Filter.....	HC-5511
Hydraulic Oil Filter.....	H-55280
Hydraulic Oil Filter.....	H-5526
Hydraulic Oil Filter.....	H-5504
Hydraulic Oil Filter.....	HC-5505
Hydraulic Oil Filter.....	HC-55170
777D (DUMP TRUCKS) CAT 3508B EUI (S/N: AGY1-UP)	
Air Filter Secondary.....	A-5715
Fuel Filter.....	FC-5510
Hydraulic Oil Filter.....	H-55270
Hydraulic Oil Filter.....	H-5503
Hydraulic Oil Filter.....	H-5504
Hydraulic Oil Filter.....	HC-55170
Hydraulic Oil Filter.....	H-5526
Hydraulic Oil Filter.....	HC-5511
Hydraulic Oil Filter.....	H-55280
Hydraulic Oil Filter.....	HC-5505
777D HAA (DUMP TRUCKS) S/N: 2YW1-UP	
Air Filter Secondary.....	A-5715
Fuel Filter.....	FC-5510
Hydraulic Oil Filter.....	H-5503
Hydraulic Oil Filter.....	H-5504
Hydraulic Oil Filter.....	H-55280
Hydraulic Oil Filter.....	H-55270
Hydraulic Oil Filter.....	H-5526
777F (DUMP TRUCKS) CAT S/N: JRP1-UP , 2007-UP	
Air Filter Primary.....	A-8686
Air Filter Set.....	A-7627-S
Air Filter Secondary.....	A-7626
Fuel Filter.....	FC-5510
Hydraulic Oil Filter.....	H-5503
Hydraulic Oil Filter.....	H-5526
Hydraulic Oil Filter.....	HC-5505
Hydraulic Oil Filter.....	H-5001
Hydraulic Oil Filter.....	HC-55170
Hydraulic Oil Filter.....	H-55280
Oil Filter Full Flow.....	C-5516
777F (DUMP TRUCKS) CAT S/N: LJW2110-UP , 2007-UP	
Air Filter Set.....	A-7627-S
Air Filter Secondary.....	A-7626
Air Filter Primary.....	A-8686
Fuel Filter.....	FC-5510
Hydraulic Oil Filter.....	HC-55170
Hydraulic Oil Filter.....	H-5526
Hydraulic Oil Filter.....	H-5503

MODEL/APPLICATION	SAKURA NO	MODEL/APPLICATION	SAKURA NO	MODEL/APPLICATION	SAKURA NO
CATERPILLAR		CATERPILLAR		CATERPILLAR	
777F (DUMP TRUCKS) CAT S/N: L3W2110-UP , 2007-UP Hydraulic Oil Filter..... H-55280 Hydraulic Oil Filter..... H-5001 Hydraulic Oil Filter..... HC-5505 Oil Filter Full Flow..... C-5516		784B (DUMP TRUCKS) S/N: 8GB-UP Air Filter..... A-5547 Air Filter Secondary..... A-5715 Fuel Filter..... FC-5506 Fuel Filter..... FC-5510 Hydraulic Oil Filter..... H-5503 Hydraulic Oil Filter..... H-55270 Hydraulic Oil Filter..... H-5504		Fuel Filter..... FC-5506 Hydraulic Oil Filter..... H-5504 Hydraulic Oil Filter..... H-55270 Hydraulic Oil Filter..... H-5503 Oil Filter Full Flow..... C-5516 785B (DUMP TRUCKS) S/N: 6HK00216-6HK00216 Air Filter Secondary..... A-5715 Fuel Filter..... FC-5506 Hydraulic Oil Filter..... H-55270 Hydraulic Oil Filter..... H-5503 Hydraulic Oil Filter..... H-5504 Oil Filter Full Flow..... C-5516	
777F (DUMP TRUCKS) CAT C32 Hydraulic Oil Filter Transmission.. EH-55010		784C (DUMP TRUCKS) S/N: 2P21-UP Air Filter Secondary..... A-5715 Fuel Filter..... FC-5510 Hydraulic Oil Filter..... H-5503 Hydraulic Oil Filter..... H-55280 Hydraulic Oil Filter..... H-55270 Hydraulic Oil Filter..... H-5526 Hydraulic Oil Filter..... H-5504		785B (DUMP TRUCKS) S/N: 6HK-UP Air Filter..... A-5547 Air Filter Secondary..... A-5715 Fuel Filter..... FC-5506 Fuel Filter..... FC-5510 Hydraulic Oil Filter..... H-55270 Hydraulic Oil Filter..... H-5503 Hydraulic Oil Filter..... H-5504	
777D US (DUMP TRUCKS) CAT 3508B (S/N: 3PR1-UP) , 2005-UP Air Filter Secondary..... A-5594 Air Filter..... AH-7001 Air Filter Primary..... A-5593 Air Filter Set..... A-5595-S Fuel Filter..... FC-5510 Fuel Filter..... F-5505 Hydraulic Oil Filter..... H-5504 Hydraulic Oil Filter..... H-5503		785 (DUMP TRUCKS) CAT 3512 (S/N: 8GB1-UP) Air Filter Secondary..... A-5715 Air Filter..... A-5547 Air Filter..... AH-7001 Fuel Filter..... FC-5510 Hydraulic Oil Filter..... H-5503 Hydraulic Oil Filter..... H-55270 Hydraulic Oil Filter..... H-5504		785B (DUMP TRUCKS) S/N: 8GB-UP Air Filter Secondary..... A-5715 Air Filter..... A-5547 Fuel Filter..... FC-5510 Hydraulic Oil Filter..... H-55270 Hydraulic Oil Filter..... H-5504	
779 (DUMP TRUCKS) Air Filter Primary..... A-5557 Air Filter Secondary..... A-5526 Air Filter Set..... A-5557-S Hydraulic Oil Filter..... H-5503		785B (DUMP TRUCKS) CAT 3512 (S/N: 6HK1-UP) Air Filter..... A-5547 Air Filter Secondary..... A-5715 Air Filter..... AH-7001 Fuel Filter..... F-5505 Fuel Filter..... FC-5510 Hydraulic Oil Filter..... H-55270 Hydraulic Oil Filter..... H-5503 Hydraulic Oil Filter..... H-5504		785C (DUMP TRUCKS) CAT 3516B (S/N: 1HW1-UP) , 2005-UP Air Filter Secondary..... A-9205 Air Filter..... AH-7001 Air Filter Secondary..... A-5715 Cabin Air Filter..... CA-55060 Fuel Filter..... FC-5510 Fuel Filter Secondary..... FC-5507 Fuel Filter..... F-5505 Hydraulic Oil Filter..... H-5526 Hydraulic Oil Filter..... H-5503 Hydraulic Oil Filter..... H-5504	
783B (DUMP TRUCKS) CAT 3512 (S/N: 5YM-UP) Air Filter Secondary..... A-5715 Fuel Filter..... FC-5506 Hydraulic Oil Filter..... H-5504 Hydraulic Oil Filter..... H-5503 Hydraulic Oil Filter..... H-55270		785B (DUMP TRUCKS) CAT 3512 TA-EUI (S/N: 6HK433-UP) Air Filter Secondary..... A-5715 Fuel Filter..... FC-5510 Hydraulic Oil Filter..... H-55270 Hydraulic Oil Filter..... H-5526 Hydraulic Oil Filter..... H-55280 Hydraulic Oil Filter..... H-5503 Hydraulic Oil Filter..... H-5504		785C (DUMP TRUCKS) CAT 3516B (S/N: 5AZ1-UP) , 2005-UP Air Filter Secondary..... A-9205 Air Filter..... AH-7001 Cabin Air Filter..... CA-55060 Fuel Filter..... F-5505 Fuel Filter..... FC-5510 Hydraulic Oil Filter..... H-5504 Hydraulic Oil Filter..... H-5503	
784B (DUMP TRUCKS) S/N: 1HW-UP Air Filter Secondary..... A-5715 Air Filter..... A-5547 Fuel Filter..... FC-5506 Fuel Filter..... FC-5510 Hydraulic Oil Filter..... H-55270 Hydraulic Oil Filter..... H-5503 Hydraulic Oil Filter..... H-5504		785B (DUMP TRUCKS) S/N: 1HW-UP Air Filter Secondary..... A-5715 Air Filter..... A-5547 Fuel Filter..... FC-5506 Fuel Filter..... FC-5510 Hydraulic Oil Filter..... H-55270 Hydraulic Oil Filter..... H-5526 Hydraulic Oil Filter..... H-55280 Hydraulic Oil Filter..... H-5503 Hydraulic Oil Filter..... H-5504		785C (DUMP TRUCKS) CAT 3516B (S/N: APX1-UP) , 2005-UP Air Filter Secondary..... A-5715 Fuel Filter..... F-5505 Fuel Filter..... FC-5510 Hydraulic Oil Filter..... H-5504 Hydraulic Oil Filter..... H-5503	
784B (DUMP TRUCKS) S/N: 5RK1-UP Air Filter Secondary..... A-5715 Fuel Filter..... FC-5510 Hydraulic Oil Filter..... H-5503 Hydraulic Oil Filter..... H-5504		785B (DUMP TRUCKS) S/N: 6HK-UP Air Filter Secondary..... A-5715 Air Filter..... A-5547 Fuel Filter..... FC-5510 Fuel Filter..... FC-5510 Hydraulic Oil Filter..... H-55270 Hydraulic Oil Filter..... H-5503 Hydraulic Oil Filter..... H-5504		785C (DUMP TRUCKS) CAT 3516B (S/N: 5AZ1-UP) , 2005-UP Air Filter Secondary..... A-9205 Air Filter..... AH-7001 Cabin Air Filter..... CA-55060 Fuel Filter..... F-5505 Fuel Filter..... FC-5510 Hydraulic Oil Filter..... H-5504 Hydraulic Oil Filter..... H-5503	
784B (DUMP TRUCKS) S/N: 6HK-UP Air Filter Secondary..... A-5715 Air Filter..... A-5547 Fuel Filter..... FC-5510 Fuel Filter..... FC-5506 Hydraulic Oil Filter..... H-5504 Hydraulic Oil Filter..... H-5503 Hydraulic Oil Filter..... H-55270		785B (DUMP TRUCKS) S/N: 6HK00123-6HK00129 Air Filter Secondary..... A-5715		785C (DUMP TRUCKS) CAT 3516B (S/N: APX1-UP) , 2005-UP Air Filter Secondary..... A-5715 Fuel Filter..... F-5505 Fuel Filter..... FC-5510 Hydraulic Oil Filter..... H-5504 Hydraulic Oil Filter..... H-5503	

Sakura Filter

ENGINE APPLICATION

MODEL/APPLICATION	SAKURA NO	MODEL/APPLICATION	SAKURA NO	MODEL/APPLICATION	SAKURA NO
CATERPILLAR		CATERPILLAR		CATERPILLAR	
785C (DUMP TRUCKS) CAT 3516B (S/N: APX1-UP) , 2005-UP		789 (DUMP TRUCKS) CAT 3516 (S/N: 7EK-UP)		789C (DUMP TRUCKS) CAT 3516TA EUI (S/N: 2BW1-UP)	
785C (DUMP TRUCKS) CAT 3512		789 (DUMP TRUCKS) CAT 3516 (S/N: 9ZC1-UP)		793 (DUMP TRUCKS) CAT 3516 (S/N: 3S31-UP)	
Fuel/Water Separator..... SFC-55281 Fuel/Water Separator..... SFC-55280		Air Filter Secondary..... A-9205 Fuel Filter Secondary..... FC-5507 Fuel Filter..... FC-5510 Fuel Filter..... FC-5506 Hydraulic Oil Filter..... H-5506 Hydraulic Oil Filter..... H-5503 Hydraulic Oil Filter..... H-5504		Air Filter Secondary..... A-9205 Fuel Filter..... FC-5510 Hydraulic Oil Filter..... H-55280 Hydraulic Oil Filter..... H-55270 Hydraulic Oil Filter..... H-5506 Hydraulic Oil Filter..... H-5526 Hydraulic Oil Filter..... H-5503 Hydraulic Oil Filter..... H-5504	
785C (DUMP TRUCKS) CAT 3512 TA-EUI (S/N: 1HW1-UP)		789 (DUMP TRUCKS) CAT 3516 (S/N: 9ZC1-UP)		793 (DUMP TRUCKS) CAT 3516 (S/N: 3S31-UP)	
Air Filter Secondary..... A-5715 Fuel Filter..... FC-5510 Hydraulic Oil Filter..... H-5504 Hydraulic Oil Filter..... H-55280 Hydraulic Oil Filter..... H-5503 Hydraulic Oil Filter..... H-55270		Air Filter..... AH-7001 Air Filter..... A-5547 Air Filter Secondary..... A-9205 Coolant Filter..... WC-5707 Fuel Filter..... F-5505 Fuel Filter..... FC-5510 Hydraulic Oil Filter..... H-5503 Hydraulic Oil Filter..... H-55270 Hydraulic Oil Filter..... H-5504 Hydraulic Oil Filter..... H-5506		Air Filter Secondary..... A-7902 Air Filter..... A-5547 Air Filter..... AH-7001 Fuel Filter..... F-5505 Fuel Filter..... FC-5510 Hydraulic Oil Filter..... H-5506 Hydraulic Oil Filter..... H-5503 Hydraulic Oil Filter..... H-5504 Hydraulic Oil Filter..... H-55280	
785C (DUMP TRUCKS) CAT 3512 TA-EUI (S/N: 5AZ1-UP)		789 (DUMP TRUCKS) CAT 3516 (S/N: 9ZC-UP)		793 (DUMP TRUCKS) S/N: 3S36-UP	
Air Filter Secondary..... A-9205 Fuel Filter..... FC-5510 Hydraulic Oil Filter..... H-5526 Hydraulic Oil Filter..... H-5504 Hydraulic Oil Filter..... H-55280 Hydraulic Oil Filter..... H-5503 Hydraulic Oil Filter..... H-55270		Air Filter Secondary..... A-9205 Fuel Filter Secondary..... FC-5507 Fuel Filter..... FC-5510 Fuel Filter..... FC-5506 Hydraulic Oil Filter..... H-5503 Hydraulic Oil Filter..... H-5506 Hydraulic Oil Filter..... H-5504		Air Filter Secondary..... A-7902 Fuel Filter..... FC-5506 Fuel Filter..... FC-5510 Hydraulic Oil Filter..... H-5504 Hydraulic Oil Filter..... H-5506 Oil Filter Full Flow..... C-5516	
785D (DUMP TRUCKS) CAT 3512		789 (DUMP TRUCKS) CAT 3516 (S/N: 9ZC-UP)		793 (DUMP TRUCKS) S/N: 3S36-UP	
Fuel/Water Separator..... SFC-55280 Fuel/Water Separator..... SFC-55281		Air Filter Secondary..... A-9205 Fuel Filter Secondary..... FC-5507 Fuel Filter..... FC-5510 Fuel Filter..... FC-5506 Hydraulic Oil Filter..... H-5503 Hydraulic Oil Filter..... H-5506 Hydraulic Oil Filter..... H-5504		Air Filter Secondary..... A-7902 Fuel Filter..... FC-5506 Fuel Filter..... FC-5510 Hydraulic Oil Filter..... H-5504 Hydraulic Oil Filter..... H-5506 Oil Filter Full Flow..... C-5516	
786 (DUMP TRUCKS) S/N: 81A1-UP		789B (DUMP TRUCKS) CAT 3516 (S/N: 7EK1-UP)		793B (DUMP TRUCKS) CAT 3516 (S/N: 1HL1-UP)	
Oil Filter Full Flow..... 0-5503		Air Filter..... A-5547 Air Filter Secondary..... A-9205 Air Filter..... AH-7001 Coolant Filter..... WC-5707 Fuel Filter..... FC-5510 Fuel Filter..... F-5505 Hydraulic Oil Filter..... H-55270 Hydraulic Oil Filter..... H-5503 Hydraulic Oil Filter..... H-5504 Hydraulic Oil Filter..... H-5506		Air Filter..... AH-7001 Air Filter..... A-5547 Air Filter Secondary..... A-7902 Fuel Filter..... F-5505 Fuel Filter..... FC-5510 Hydraulic Oil Filter..... HC-5506 Hydraulic Oil Filter..... H-55280 Hydraulic Oil Filter..... H-5503 Hydraulic Oil Filter..... H-5506 Hydraulic Oil Filter..... H-5504 Hydraulic Oil Filter..... HC-5503	
787B (DUMP TRUCKS) CAT S/N: 2PK450-UP		789C (DUMP TRUCKS) CAT 3516 (S/N: 2BW1-UP) , 2005-UP		793B (DUMP TRUCKS) CAT 3516 (S/N: 2HL-UP)	
Air Filter..... A-5547 Air Filter Secondary..... A-9205 Fuel Filter..... FC-5510 Hydraulic Oil Filter..... H-5506 Hydraulic Oil Filter..... H-55280 Hydraulic Oil Filter..... H-5503 Hydraulic Oil Filter..... H-5526 Hydraulic Oil Filter..... H-55270 Hydraulic Oil Filter..... H-55270		Air Filter Secondary..... A-9205 Fuel Filter Secondary..... FC-5507 Fuel Filter..... FC-5510 Fuel Filter..... FC-5506 Hydraulic Oil Filter..... H-5504 Hydraulic Oil Filter..... H-5503 Hydraulic Oil Filter..... H-5506		Air Filter..... A-5547 Air Filter Secondary..... A-7902 Fuel Filter..... F-5505 Fuel Filter..... FC-5510 Hydraulic Oil Filter..... H-5504 Hydraulic Oil Filter..... H-5506 Hydraulic Oil Filter..... H-5504 Hydraulic Oil Filter..... H-5503	
787B (DUMP TRUCKS) CAT S/N: 9TM1-UP		789C (DUMP TRUCKS) CAT 3516 (S/N: 2BW1-UP) , 2005-UP		793C (DUMP TRUCKS) CAT 3516 (S/N: 4AR1-UP) , 2005-UP	
Air Filter Secondary..... A-9205 Air Filter..... A-5547 Fuel Filter..... FC-5510 Hydraulic Oil Filter..... H-55280 Hydraulic Oil Filter..... H-5503 Hydraulic Oil Filter..... H-5526 Hydraulic Oil Filter..... H-55270 Hydraulic Oil Filter..... H-5506		Cabin Air Filter..... CA-55060 Fuel Filter Secondary..... FC-5507 Fuel Filter..... F-5505 Fuel Filter..... FC-5510 Hydraulic Oil Filter..... H-5504 Hydraulic Oil Filter..... H-5503 Hydraulic Oil Filter..... H-5506		Air Filter..... A-5547 Air Filter Secondary..... A-7902 Hydraulic Oil Filter..... H-5504 Hydraulic Oil Filter..... H-5503	
789 (DUMP TRUCKS) CAT 3516 (S/N: 2BW-UP)		789C (DUMP TRUCKS) CAT 3516 (S/N: 2BW1-UP)		793C (DUMP TRUCKS) CAT 3516 (S/N: 4AR1-UP) , 2005-UP	
Air Filter Secondary..... A-9205 Fuel Filter..... FC-5506 Fuel Filter..... FC-5510 Fuel Filter Secondary..... FC-5507 Hydraulic Oil Filter..... H-5503		Fuel/Water Separator..... SFC-55281 Fuel/Water Separator..... SFC-55280		Air Filter Secondary..... A-7902 Fuel Filter..... F-5505 Fuel Filter..... FC-5510 Hydraulic Oil Filter..... H-5506 Hydraulic Oil Filter..... H-5504 Hydraulic Oil Filter..... H-5526 Hydraulic Oil Filter..... HC-5503 Hydraulic Oil Filter..... HC-5506	

MODEL/APPLICATION	SAKURA NO
CATERPILLAR	
793C (DUMP TRUCKS) CAT 3516 (S/N: 4AR1-UP) , 2005-UP	
Hydraulic Oil Filter.....	H-5503
793C (DUMP TRUCKS) CAT 3516 (S/N: 4GZ1-UP) , 2005-UP	
Air Filter Secondary.....	A-7902
Fuel Filter.....	FC-5510
Fuel Filter.....	F-5505
Hydraulic Oil Filter.....	H-5503
Hydraulic Oil Filter.....	HC-5503
Hydraulic Oil Filter.....	H-5504
Hydraulic Oil Filter.....	HC-5506
Hydraulic Oil Filter.....	H-5506
Hydraulic Oil Filter.....	H-5526
793C (DUMP TRUCKS) CAT 3516 (S/N: ATY1-UP) , 2005-UP	
Air Filter Secondary.....	A-7902
Fuel Filter.....	FC-5510
Fuel Filter.....	F-5505
Hydraulic Oil Filter.....	HC-5506
Hydraulic Oil Filter.....	H-5504
Hydraulic Oil Filter.....	H-55270
Hydraulic Oil Filter.....	H-5503
Hydraulic Oil Filter.....	H-5506
793C (DUMP TRUCKS) CAT 3516B EUI (S/N: 4AR1-UP)	
Air Filter Secondary.....	A-7902
Fuel Filter.....	FC-5510
Hydraulic Oil Filter.....	H-5506
Hydraulic Oil Filter.....	HC-5512
Hydraulic Oil Filter.....	HC-5506
Hydraulic Oil Filter.....	H-5504
Hydraulic Oil Filter.....	H-5526
Hydraulic Oil Filter.....	H-55270
Hydraulic Oil Filter.....	H-5503
Hydraulic Oil Filter.....	H-55280
793C (DUMP TRUCKS) CAT 3516B EUI (S/N: 4GZ1-UP)	
Air Filter Secondary.....	A-7902
Fuel Filter.....	FC-5510
Hydraulic Oil Filter.....	HC-5512
Hydraulic Oil Filter.....	H-5506
Hydraulic Oil Filter.....	H-5526
Hydraulic Oil Filter.....	HC-5506
Hydraulic Oil Filter.....	H-55280
Hydraulic Oil Filter.....	H-5503
Hydraulic Oil Filter.....	H-55270
Hydraulic Oil Filter.....	H-5504
793C (DUMP TRUCKS) CAT 3516B EUI (S/N: ATY1-UP)	
Air Filter Secondary.....	A-7902
Fuel Filter.....	FC-5510
Hydraulic Oil Filter.....	H-55270
Hydraulic Oil Filter.....	HC-5506
Hydraulic Oil Filter.....	H-5506
Hydraulic Oil Filter.....	HC-5512
Hydraulic Oil Filter.....	H-5504

MODEL/APPLICATION	SAKURA NO
CATERPILLAR	
793D (DUMP TRUCKS) CAT S/N: 7TR1-UP	
Air Filter Secondary.....	A-7902
Cabin Air Filter.....	CA-55060
Fuel Filter.....	FC-5510
Fuel Filter Secondary.....	FC-5507
Hydraulic Oil Filter.....	H-5526
Hydraulic Oil Filter.....	H-55270
Hydraulic Oil Filter.....	H-55280
Hydraulic Oil Filter.....	H-5503
793D (DUMP TRUCKS) CAT S/N: 8WM1-UP	
Air Filter Secondary.....	A-7902
Cabin Air Filter.....	CA-55060
Fuel Filter.....	FC-5510
Fuel Filter Secondary.....	FC-5507
Hydraulic Oil Filter.....	H-5526
Hydraulic Oil Filter.....	H-5503
Hydraulic Oil Filter.....	H-55270
Hydraulic Oil Filter.....	H-55280
793D (DUMP TRUCKS) CAT S/N: FDB1-UP	
Air Filter Secondary.....	A-7902
Cabin Air Filter.....	CA-55060
Fuel Filter Secondary.....	FC-5507
Fuel Filter.....	FC-5510
Hydraulic Oil Filter.....	H-55270
Hydraulic Oil Filter.....	H-55280
Hydraulic Oil Filter.....	H-5526
Hydraulic Oil Filter.....	H-5503
797 (DUMP TRUCKS) CAT 3524B (S/N: 5YW1-UP) , 2005-UP	
Air Filter Secondary.....	A-7902
Air Filter Secondary.....	A-9205
Cabin Air Filter.....	CA-55060
Fuel Filter.....	FC-5510
Hydraulic Oil Filter.....	HC-5511
Hydraulic Oil Filter.....	H-5503
Hydraulic Oil Filter.....	H-5001
Hydraulic Oil Filter.....	H-5504
797 (DUMP TRUCKS) S/N: 5YW1-UP	
Air Filter Secondary.....	A-7902
Air Filter Secondary.....	A-9205
Fuel Filter.....	FC-5510
Hydraulic Oil Filter.....	H-5503
Hydraulic Oil Filter.....	H-5001
Hydraulic Oil Filter.....	H-55270
Hydraulic Oil Filter.....	H-5504
Hydraulic Oil Filter.....	HC-5511
797B (DUMP TRUCKS) CAT 3524B EUI (S/N: JSM1-UP) , 2004-UP	
Fuel Filter.....	FC-5510
Hydraulic Oil Filter.....	HC-5511
Hydraulic Oil Filter.....	H-5503
Hydraulic Oil Filter.....	H-5001
7WK (EXCAVATORS)	

MODEL/APPLICATION	SAKURA NO
CATERPILLAR	
Air Filter Secondary.....	A-6007
Air Filter Primary.....	A-6006
Air Filter Set.....	A-6118-S
Fuel Filter.....	F-5505
Fuel Filter.....	FC-5508
Fuel Filter Secondary.....	FC-55151
Fuel Filter Secondary.....	FC-5515
Fuel Filter.....	FC-5516
Hydraulic Oil Filter.....	H-5505
Hydraulic Oil Filter.....	HC-5505
Oil Filter Full Flow.....	C-5510
814 (COMPACTORS) S/N: 14R1-UP	
Air Filter Primary.....	A-5549M
Air Filter Primary.....	A-5549
Air Filter Secondary.....	A-5550
Air Filter Set.....	A-5522-S
Air Filter Set.....	A-5549M-S
Air Filter Primary.....	A-5509
Air Filter Secondary.....	A-5510
Fuel Filter.....	FC-5510
Fuel Filter Secondary.....	FC-5507
Hydraulic Oil Filter.....	H-5503
Hydraulic Oil Filter.....	H-5504
Oil Filter Full Flow.....	C-5510
814 (COMPACTORS) S/N: 90P1-156	
Air Filter Set.....	A-5544-S
Air Filter Primary.....	A-5558
Air Filter Secondary.....	A-5520
Air Filter Secondary.....	A-5559
Air Filter Primary.....	A-5543
Fuel Filter Secondary.....	FC-5507
Hydraulic Oil Filter.....	H-5503
Hydraulic Oil Filter.....	H-5504
Oil Filter Full Flow.....	O-5502
814 (COMPACTORS) S/N: 90P157-UP	
Air Filter Primary.....	A-5549
Air Filter Set.....	A-5549M-S
Air Filter Secondary.....	A-5550
Air Filter Primary.....	A-5549M
Air Filter Primary.....	A-5509
Air Filter Set.....	A-5522-S
Air Filter Secondary.....	A-5510
Fuel Filter Secondary.....	FC-5507
Fuel Filter.....	FC-5510
Hydraulic Oil Filter.....	H-5503
Hydraulic Oil Filter.....	H-5504
Oil Filter Full Flow.....	C-5510
814B (DOZERS) 08Z3945-25424	
Oil Filter Full Flow.....	C-5506
814B (DOZERS) CAT (S/N: 08Z25425-26313)	
Fuel Filter.....	FC-5523
Fuel Filter.....	FC-5501
Oil Filter Full Flow.....	C-5510

MODEL/APPLICATION	SAKURA NO
CATERPILLAR	
814B (DOZERS) CAT (S/N: 08Z26314-UP)	
Fuel Filter Secondary.....	FC-5507
Oil Filter Full Flow.....	C-5510
814B (DOZERS) CAT (S/N: 08Z3945-25424)	
Fuel Filter.....	FC-5523
Fuel Filter.....	FC-5501
Oil Filter Full Flow.....	C-5510
Oil Filter Full Flow.....	C-5522
814B (DOZERS) S/N: 16Z1-274	
Air Filter Set.....	A-5522-S
Air Filter Primary.....	A-5509
Air Filter Secondary.....	A-5522
Hydraulic Oil Filter.....	H-55270
Hydraulic Oil Filter.....	H-5506
814B (DOZERS) S/N: 16Z1-UP	
Air Filter Secondary.....	A-5522
Air Filter Set.....	A-5549M-S
Air Filter Primary.....	A-5549
Air Filter Secondary.....	A-5550
Air Filter Primary.....	A-5549M
Air Filter Set.....	A-5522-S
Air Filter Primary.....	A-5509
Fuel Filter Secondary.....	FC-5507
Fuel Filter.....	F-5505
Hydraulic Oil Filter.....	H-5504
Hydraulic Oil Filter.....	H-5506
Oil Filter Full Flow.....	C-5510
814B (DOZERS) S/N: 16Z275-306	
Air Filter Primary.....	A-5549
Air Filter Set.....	A-5549M-S
Air Filter Set.....	A-5522-S
Air Filter Primary.....	A-5549M
Air Filter Secondary.....	A-5550
Air Filter Secondary.....	A-5522
Air Filter Primary.....	A-5509
Hydraulic Oil Filter.....	H-55270
Hydraulic Oil Filter.....	H-5506
814B (DOZERS) S/N: 16Z307-UP	
Air Filter Primary.....	A-5549M
Air Filter Secondary.....	A-5550
Air Filter Secondary.....	A-5522
Air Filter Primary.....	A-5509
Air Filter Set.....	A-5522-S
Air Filter Primary.....	A-5549
Air Filter Set.....	A-5549M-S
Hydraulic Oil Filter.....	H-5506
Hydraulic Oil Filter.....	H-55270
814F (DOZERS) CAT (S/N: 08Z86460-UP)	
Fuel Filter Secondary.....	FC-5507
Oil Filter Full Flow.....	C-5510
Oil Filter Full Flow.....	C-5522

MODEL/APPLICATION	SAKURA NO
CATERPILLAR	
814F (DOZERS) CAT (S/N: 3PD1-UP)	
Fuel Filter.....	FC-5517
Oil Filter Full Flow.....	C-5516
814F (DOZERS) CAT (S/N: 6NC1-UP)	
Fuel Filter Secondary.....	FC-5507
Fuel Filter.....	FC-5509
Oil Filter Full Flow.....	C-5522
Oil Filter Full Flow.....	C-5516
814F (DOZERS) CAT (S/N: 9DM1-UP)	
Air Filter Secondary.....	A-5559
Air Filter Primary.....	A-5558
Cabin Air Filter.....	CA-55070
Hydraulic Oil Filter.....	H-55270
Hydraulic Oil Filter.....	H-5506
814F (DOZERS) CAT (S/N: BGF1-UP)	
Air Filter Set.....	A-5555-S
Air Filter Primary.....	A-5555
Air Filter Secondary.....	A-5556
Cabin Air Filter.....	CA-55070
Hydraulic Oil Filter.....	H-55270
Hydraulic Oil Filter.....	H-5506
814F II (DOZERS) CAT S/N: BXG1-UP	
Air Filter Secondary.....	A-5556
Air Filter Set.....	A-5555-S
Air Filter Primary.....	A-5555
Cabin Air Filter.....	CA-55070
Fuel Filter.....	FC-5517
Hydraulic Oil Filter.....	H-5506
Hydraulic Oil Filter.....	H-55270
814F II (DOZERS) CAT S/N: THX286-UP	
Air Filter Set.....	A-5555-S
Air Filter Secondary.....	A-5556
Air Filter Primary.....	A-5555
Cabin Air Filter.....	CA-55070
Fuel Filter.....	FC-5517
Hydraulic Oil Filter.....	H-55270
Hydraulic Oil Filter.....	H-5506
814K (DOZERS) CAT C7.1	
Fuel Filter.....	EF-55050
815 (COMPACTORS)	
Fuel Filter.....	F-5503
815 (COMPACTORS) S/N: 15R1 EXC. 91P925-UP	
Air Filter Set.....	A-5549M-S
Air Filter Secondary.....	A-5550
Air Filter Secondary.....	A-5510
Air Filter Primary.....	A-5549
Air Filter Primary.....	A-5549M
Air Filter Primary.....	A-5509

MODEL/APPLICATION	SAKURA NO
CATERPILLAR	
Air Filter Set.....	A-5522-S
Fuel Filter Secondary.....	FC-5507
Hydraulic Oil Filter.....	H-5504
Hydraulic Oil Filter.....	H-5503
Oil Filter Full Flow.....	C-5510
815 (COMPACTORS) S/N: 15R1-UP	
Air Filter Primary.....	A-5549M
Air Filter Secondary.....	A-5510
Air Filter Set.....	A-5522-S
Air Filter Primary.....	A-5549
Air Filter Set.....	A-5549M-S
Air Filter Primary.....	A-5509
Air Filter Secondary.....	A-5550
Fuel Filter Secondary.....	FC-5507
Hydraulic Oil Filter.....	H-5503
Hydraulic Oil Filter.....	H-5504
Oil Filter Full Flow.....	C-5510
815 (COMPACTORS) S/N: 91P1-91P243	
Air Filter Secondary.....	A-5520
Air Filter Set.....	A-5544-S
Air Filter Primary.....	A-5543
Air Filter Primary.....	A-5558
Air Filter Secondary.....	A-5559
Fuel Filter Secondary.....	FC-5507
Hydraulic Oil Filter.....	H-5503
Hydraulic Oil Filter.....	H-5504
Oil Filter Full Flow.....	O-5502
815 (COMPACTORS) S/N: 91P244-919	
Air Filter Secondary.....	A-5510
Air Filter Secondary.....	A-5550
Air Filter Primary.....	A-5509
Air Filter Primary.....	A-5549
Air Filter Set.....	A-5522-S
Air Filter Set.....	A-5549M-S
Air Filter Primary.....	A-5549M
Fuel Filter Secondary.....	FC-5507
Hydraulic Oil Filter.....	H-5503
Hydraulic Oil Filter.....	H-5504
Oil Filter Full Flow.....	O-5501
Oil Filter Full Flow.....	O-5502
Oil Filter Full Flow.....	C-5510
815 (COMPACTORS) S/N: 91P920-UP	
Air Filter Secondary.....	A-5510
Air Filter Set.....	A-5549M-S
Air Filter Primary.....	A-5509
Air Filter Set.....	A-5522-S
Air Filter Secondary.....	A-5550
Air Filter Primary.....	A-5549
Air Filter Primary.....	A-5549M
Fuel Filter Secondary.....	FC-5507
Hydraulic Oil Filter.....	H-5503
Hydraulic Oil Filter.....	H-5504
Oil Filter Full Flow.....	O-5501
Oil Filter Full Flow.....	O-5502
Oil Filter Full Flow.....	C-5510
815 (COMPACTORS) S/N: 91P925-925	
Air Filter Secondary.....	A-5510
Air Filter Set.....	A-5549M-S
Air Filter Primary.....	A-5509
Air Filter Set.....	A-5522-S
Air Filter Secondary.....	A-5550
Air Filter Primary.....	A-5549
Air Filter Primary.....	A-5549M
Fuel Filter Secondary.....	FC-5507
Hydraulic Oil Filter.....	H-5503
Hydraulic Oil Filter.....	H-5504
Oil Filter Full Flow.....	C-5510

Sakura Filter

ENGINE APPLICATION

MODEL/APPLICATION	SAKURA NO	MODEL/APPLICATION	SAKURA NO	MODEL/APPLICATION	SAKURA NO
CATERPILLAR		CATERPILLAR		CATERPILLAR	
815 (COMPACTORS) S/N: 91P925-925 Air Filter Secondary..... A-5510 Air Filter Set..... A-5522-S Air Filter Primary..... A-5549M Air Filter Secondary..... A-5550 Air Filter Primary..... A-5549 Air Filter Primary..... A-5509 Air Filter Set..... A-5549M-S Fuel Filter Secondary..... FC-5507 Hydraulic Oil Filter..... H-5504 Hydraulic Oil Filter..... H-5503 Oil Filter Full Flow..... O-5501 Oil Filter Full Flow..... C-5510 Oil Filter Full Flow..... O-5502		815F (COMPACTORS) w/C9 Eng. Fuel/Water Separator..... SFC-55170 815F II (COMPACTORS) CAT S/N: BYN1-UP Air Filter Primary..... A-5555 Air Filter Set..... A-5555-S Air Filter Secondary..... A-5556 Cabin Air Filter..... CA-55070 Fuel Filter..... FC-5517 Hydraulic Oil Filter..... H-5506 Hydraulic Oil Filter..... H-55270 815F II (COMPACTORS) CAT S/N: THX1-UP Air Filter Secondary..... A-5556 Air Filter Set..... A-5555-S Air Filter Primary..... A-5555 Cabin Air Filter..... CA-55070 Fuel Filter..... FC-5517 Hydraulic Oil Filter..... H-5506 Hydraulic Oil Filter..... H-55270 815K (COMPACTORS) CAT C7.1 Fuel Filter..... EF-55050 816 (COMPACTORS) S/N: 15U1-UP Air Filter Secondary..... A-5510 Air Filter Set..... A-5522-S Air Filter Primary..... A-5509 Fuel Filter..... FC-5523 Fuel Filter..... FC-5501 Hydraulic Oil Filter..... H-5502 Hydraulic Oil Filter..... H-5504 Oil Filter Full Flow..... C-5510 816 (COMPACTORS) S/N: 15Z1-UP Air Filter Primary..... A-5509 Air Filter Secondary..... A-5522 Air Filter Set..... A-5522-S Fuel Filter..... FC-5519 Hydraulic Oil Filter..... H-5506 Hydraulic Oil Filter..... H-5504 Oil Filter Full Flow..... C-5510 816 (COMPACTORS) S/N: 57U1-UP Air Filter Primary..... A-5509 Air Filter Set..... A-5522-S Air Filter Set..... A-5549M-S Air Filter Primary..... A-5549M Air Filter Secondary..... A-5550 Air Filter Primary..... A-5549 Air Filter Secondary..... A-5510 Fuel Filter Secondary..... FC-5507 Hydraulic Oil Filter..... H-5504 Hydraulic Oil Filter..... H-5502 Oil Filter Full Flow..... C-5510		816B (COMPACTORS) S/N: 15Z1-UP Air Filter Primary..... A-5549M Air Filter Primary..... A-5549 Air Filter Primary..... A-5509 Air Filter Secondary..... A-5550 Air Filter Set..... A-5522-S Air Filter Secondary..... A-5522 Air Filter Set..... A-5549M-S Fuel Filter Secondary..... FC-5507 Fuel Filter..... F-5505 Hydraulic Oil Filter..... H-5504 Hydraulic Oil Filter..... H-5506 Hydraulic Oil Filter..... H-55270 Oil Filter Full Flow..... C-5510 816F (COMPACTORS) 3176C Fuel/Water Separator..... SFC-55170 816F (COMPACTORS) w/C9 Eng. Fuel/Water Separator..... SFC-55170 816F II (COMPACTORS) CAT S/N: BZR1-UP Air Filter Set..... A-5555-S Air Filter Secondary..... A-5556 Air Filter Primary..... A-5555 Cabin Air Filter..... CA-55070 Fuel Filter..... FC-5517 Hydraulic Oil Filter..... H-55270 Hydraulic Oil Filter..... H-5506 816F II (COMPACTORS) CAT S/N: THX1-UP Air Filter Secondary..... A-5556 Air Filter Set..... A-5555-S Air Filter Primary..... A-5555 Cabin Air Filter..... CA-55070 Fuel Filter..... FC-5517 Hydraulic Oil Filter..... H-55270 Hydraulic Oil Filter..... H-5506 816K (COMPACTORS) CAT C7.1 Fuel Filter..... EF-55050 824C (DOZERS) CAT 3406 Air Filter Primary..... A-44150 Air Filter Set..... A-44150-S 824C (DOZERS) CAT (S/N: 11N1-UP) Fuel Filter..... FC-5509 Fuel Filter..... FC-5519 824C (DOZERS) CAT (S/N: 70V14539-16375) Fuel Filter..... FC-5509 824C (DOZERS) CAT (S/N: 70V16376-UP) Fuel Filter..... FC-5509	
815 (COMPACTORS) S/N: EXC. 91P-UP Air Filter Set..... A-5549M-S Air Filter Secondary..... A-5550 Air Filter Primary..... A-5549M Air Filter Primary..... A-5549 Air Filter Primary..... A-5509 Air Filter Set..... A-5522-S Air Filter Secondary..... A-5510 Fuel Filter Secondary..... FC-5507 Hydraulic Oil Filter..... H-5503 Hydraulic Oil Filter..... H-5504 Oil Filter Full Flow..... O-5501 Oil Filter Full Flow..... C-5510 Oil Filter Full Flow..... O-5502		815 (COMPACTORS) w/3306 Eng. Hydraulic Oil Filter..... H-55320 815B (COMPACTORS) S/N: 17Z1-UP Air Filter Set..... A-5522-S Air Filter Secondary..... A-5550 Air Filter Set..... A-5549M-S Air Filter Primary..... A-5549M Air Filter Secondary..... A-5522 Air Filter Primary..... A-5549 Air Filter Primary..... A-5509 Fuel Filter..... F-5505 Fuel Filter Secondary..... FC-5507 Hydraulic Oil Filter..... H-5506 Hydraulic Oil Filter..... H-5504 Oil Filter Full Flow..... C-5510		815F (COMPACTORS) 3176C Fuel/Water Separator..... SFC-55170 815F (COMPACTORS) CAT 3176C ATAAC (S/N: 1GN1-UP) Air Filter Primary..... A-5558 Air Filter Secondary..... A-5559 Fuel Filter Secondary..... FC-5507 Hydraulic Oil Filter..... H-5506 Hydraulic Oil Filter..... H-5504	

MODEL/APPLICATION	SAKURA NO
CATERPILLAR	
824C (DOZERS) CAT S/N: BKN1-UP	
Fuel Filter.....	FC-5517
Fuel Filter.....	FC-5509
824C (DOZERS) S/N: 29G1-UP	
Air Filter Primary.....	A-5549M
Air Filter Set.....	A-5522-S
Air Filter Primary.....	A-5549
Air Filter Primary.....	A-5509
Air Filter Secondary.....	A-5510
Air Filter Set.....	A-5549M-S
Air Filter Secondary.....	A-5550
Fuel Filter.....	F-5501
Hydraulic Oil Filter.....	H-5503
Oil Filter Full Flow.....	O-5503
824C (DOZERS) S/N: 36H1-UP	
Air Filter Primary.....	A-5543
Air Filter Primary.....	A-5558
Air Filter Set.....	A-5544-S
Air Filter Secondary.....	A-5520
Air Filter Secondary.....	A-5559
Fuel Filter.....	F-5501
Hydraulic Oil Filter.....	H-5503
Oil Filter Full Flow.....	O-5503
824C (DOZERS) S/N: 85X1045-1158	
Air Filter Primary.....	A-5501
Air Filter Secondary.....	A-5502
Hydraulic Oil Filter.....	H-55270
824C (DOZERS) S/N: 85X1159-1159	
Air Filter Secondary.....	A-5502
Air Filter Primary.....	A-5501
Hydraulic Oil Filter.....	H-5506
Hydraulic Oil Filter.....	H-55270
824C (DOZERS) S/N: 85X1160-1175	
Air Filter Secondary.....	A-5502
Air Filter Primary.....	A-5501
Hydraulic Oil Filter.....	H-55270
824C (DOZERS) S/N: 85X1176-1193	
Air Filter Secondary.....	A-5502
Air Filter Primary.....	A-5501
Hydraulic Oil Filter.....	H-55270
Hydraulic Oil Filter.....	H-5506
824C (DOZERS) S/N: 85X1194-1583	
Air Filter Secondary.....	A-5502
Air Filter Primary.....	A-5501
Hydraulic Oil Filter.....	H-5504
Hydraulic Oil Filter.....	H-5506
Hydraulic Oil Filter.....	H-55270
824C (DOZERS) S/N: 85X1-563	

MODEL/APPLICATION	SAKURA NO
CATERPILLAR	
Air Filter Primary.....	A-5501
Air Filter Secondary.....	A-5502
Hydraulic Oil Filter.....	H-55270
824C (DOZERS) S/N: 85X1584-UP	
Air Filter Secondary.....	A-5534
Air Filter Set.....	A-5573-S
Air Filter Primary.....	A-5535
Hydraulic Oil Filter.....	H-55270
Hydraulic Oil Filter.....	H-5504
Hydraulic Oil Filter.....	H-5506
824C (DOZERS) S/N: 85X1-UP	
Air Filter Secondary.....	A-5534
Air Filter Secondary.....	A-5502
Air Filter Primary.....	A-5501
Air Filter Set.....	A-5573-S
Air Filter Primary.....	A-5535
Fuel Filter.....	F-5505
Fuel Filter.....	FC-5519
Fuel Filter.....	FC-5509
Hydraulic Oil Filter.....	H-5504
Hydraulic Oil Filter.....	H-5506
Oil Filter Full Flow.....	C-5516
824C (DOZERS) S/N: 85X564-836	
Air Filter Secondary.....	A-5502
Air Filter Primary.....	A-5501
Hydraulic Oil Filter.....	H-55270
824C (DOZERS) S/N: 85X837-1044	
Air Filter Secondary.....	A-5502
Air Filter Primary.....	A-5501
Hydraulic Oil Filter.....	H-55270
824C (DOZERS) w/3406 Eng.	
Air Filter Primary.....	A-5535M
Air Filter Set.....	A-5573M-S
824G II (DOZERS) CAT S/N: AWW1-UP	
Air Filter Primary.....	A-5555
Air Filter Set.....	A-5555-S
Air Filter Secondary.....	A-5556
Air Filter.....	A-5584
Fuel Filter.....	FC-5517
Fuel Filter.....	FC-5509
Fuel/Water Separator Secondary... SFC-5504-10	
Fuel/Water Separator Secondary.. SFC-5504-10B	
Hydraulic Oil Filter.....	H-55280
Hydraulic Oil Filter.....	H-5506
Hydraulic Oil Filter.....	H-5526
Oil Filter Full Flow.....	C-5516
824G II (DOZERS) CAT S/N: BKN1-UP	
Air Filter Secondary.....	A-5556
Air Filter Primary.....	A-5555
Air Filter.....	A-5584
Air Filter Set.....	A-5555-S

MODEL/APPLICATION	SAKURA NO
CATERPILLAR	
Fuel Filter.....	FC-5517
Fuel Filter.....	FC-5509
Fuel/Water Separator Secondary... SFC-5504-10	
Fuel/Water Separator Secondary.. SFC-5504-10B	
Hydraulic Oil Filter.....	H-5526
Hydraulic Oil Filter.....	H-55280
Hydraulic Oil Filter.....	H-5506
Oil Filter Full Flow.....	C-5516
824H (DOZERS) CAT S/N: ASX1-299-UP	
Air Filter.....	A-5584
Air Filter Set.....	A-5595-S
Air Filter Primary.....	A-5593
Air Filter Secondary.....	A-5594
Fuel Filter.....	FC-5517
Hydraulic Oil Filter.....	H-5506
Hydraulic Oil Filter.....	H-55280
Hydraulic Oil Filter.....	H-5526
824H (DOZERS) CAT S/N: ASX300-UP	
Air Filter.....	A-5584
Air Filter Secondary.....	A-5594
Air Filter Primary.....	A-5593
Air Filter Set.....	A-5595-S
Fuel Filter.....	FC-5517
Hydraulic Oil Filter.....	H-5526
Hydraulic Oil Filter.....	H-55280
824H (DOZERS) CAT S/N: LHX1-UP	
Air Filter Primary.....	A-5593
Air Filter Secondary.....	A-5594
Air Filter Set.....	A-5595-S
Air Filter.....	A-5584
Fuel Filter.....	FC-5517
Hydraulic Oil Filter.....	H-55280
Hydraulic Oil Filter.....	H-5506
Hydraulic Oil Filter.....	H-5526
824H (DOZERS) CAT S/N: ZBD1-UP	
Air Filter Secondary.....	A-5594
Air Filter Primary.....	A-5593
Air Filter.....	A-5584
Air Filter Set.....	A-5595-S
Fuel Filter.....	FC-5517
Hydraulic Oil Filter.....	H-55280
Hydraulic Oil Filter.....	H-5506
Hydraulic Oil Filter.....	H-5526
824G (DOZERS) CAT (S/N: 41Z212-UP)	
Fuel Filter.....	FC-5509
Oil Filter Full Flow.....	C-5516
824G (DOZERS)	
Air Filter Set.....	A-5573M-S
Air Filter Primary.....	A-5535M
Air Filter Secondary.....	A-5556
Air Filter Set.....	A-5555-S
Air Filter Primary.....	A-5555
Fuel Filter.....	FC-5509

Sakura Filter

ENGINE APPLICATION

MODEL/APPLICATION	SAKURA NO	MODEL/APPLICATION	SAKURA NO	MODEL/APPLICATION	SAKURA NO
CATERPILLAR		CATERPILLAR		CATERPILLAR	
824G (DOZERS)		825G (COMPACTORS) CAT 3406E ATAAC		Hydraulic Oil Filter.....	H-55280
Oil Filter Full Flow.....	C-5516	Air Filter Set.....	A-5555-S	Hydraulic Oil Filter.....	H-5506
824G (DOZERS)		Air Filter Primary.....	A-5555	Hydraulic Oil Filter.....	H-5526
S/N: 45N1-320		Air Filter Secondary.....	A-5556		
Air Filter.....	A-5584	Fuel Filter.....	FC-5506	825H (COMPACTORS) CAT S/N: ZHC1-UP	
Air Filter Primary.....	A-5535	Hydraulic Oil Filter.....	H-5506	Air Filter.....	A-5584
Air Filter Set.....	A-5573-S	Hydraulic Oil Filter.....	H-5504	Air Filter Secondary.....	A-5594
Air Filter Secondary.....	A-5534			Air Filter Set.....	A-5595-S
Hydraulic Oil Filter.....	H-5506	825G (COMPACTORS) CAT 3406E ATAAC (S/N: 6RN1-UP)		Air Filter Primary.....	A-5593
Hydraulic Oil Filter.....	H-55270	Air Filter.....	A-5584	Fuel Filter.....	FC-5517
824G (DOZERS)		Air Filter Secondary.....	A-5534	Hydraulic Oil Filter.....	H-55280
S/N: 45N321-UP		Air Filter Set.....	A-5555-S	Hydraulic Oil Filter.....	H-5526
Air Filter.....	A-5584	Air Filter Secondary.....	A-5556	Hydraulic Oil Filter.....	H-5506
Air Filter Primary.....	A-5555	Air Filter Primary.....	A-5555		
Air Filter Set.....	A-5555-S	Air Filter Primary.....	A-5535	825H (COMPACTORS) W/C15 ENG.	
Air Filter Secondary.....	A-5556	Air Filter Set.....	A-5573-S	Fuel/Water Separator.....	SFC-55170
Hydraulic Oil Filter.....	H-5506	Coolant Filter.....	WC-5707		
Hydraulic Oil Filter.....	H-55270	Coolant Filter.....	WC-5705	825K (COMPACTORS) W/C15 ENG.	
824K (DOZERS) W/C15 ENG.		Fuel Filter.....	FC-5509	Fuel/Water Separator.....	SFC-55250
Fuel/Water Separator.....	SFC-55250	Fuel Filter.....	F-5505		
825 (COMPACTORS) S/N: 43N1-43N493		Hydraulic Oil Filter.....	H-5504	826 (COMPACTORS) S/N: 58U1-UP	
Air Filter Set.....	A-5544-S	Hydraulic Oil Filter.....	H-5506	Air Filter Set.....	A-5544-S
Air Filter Primary.....	A-5558	Hydraulic Oil Filter.....	H-55270	Air Filter Primary.....	A-5543
Air Filter Secondary.....	A-5559	Oil Filter Full Flow.....	C-5516	Air Filter Secondary.....	A-5520
Air Filter Primary.....	A-5543	825G (COMPACTORS) w/3406 Eng.		Hydraulic Oil Filter.....	H-5503
Air Filter Secondary.....	A-5520	Air Filter Set.....	A-5573M-S	Oil Filter Full Flow.....	O-5503
Hydraulic Oil Filter.....	H-5503	Air Filter Primary.....	A-5535M		
Oil Filter Full Flow.....	O-5503	825G II (COMPACTORS) CAT 3406 (S/N: AXB1-437)		826B (COMPACTORS) S/N: 58U1-UP	
825 (COMPACTORS) S/N: 43N494-UP		Hydraulic Oil Filter.....	H-5506	Air Filter Secondary.....	A-5520
Air Filter Set.....	A-5544-S	825G II (COMPACTORS) CAT 3406 (S/N: AXB1-UP)		Air Filter Primary.....	A-5558
Air Filter Primary.....	A-5543	Air Filter Secondary.....	A-5556	Air Filter Set.....	A-5544-S
Air Filter Secondary.....	A-5559	Air Filter Set.....	A-5555-S	Air Filter Primary.....	A-5543
Air Filter Primary.....	A-5558	Air Filter.....	A-5584	Air Filter Secondary.....	A-5559
Air Filter Secondary.....	A-5520	Air Filter Primary.....	A-5555	Fuel Filter Secondary.....	FC-5507
Fuel Filter Secondary.....	FC-5507	Fuel Filter.....	FC-5517	Hydraulic Oil Filter.....	H-5503
Hydraulic Oil Filter.....	H-5503	Hydraulic Oil Filter.....	H-5526	Oil Filter Full Flow.....	O-5503
Oil Filter Full Flow.....	O-5503	Oil Filter Full Flow.....	C-5516		
825C (COMPACTORS) S/N: 86X1-UP		825H (COMPACTORS) CAT S/N: AZW1-299-UP		826C (COMPACTORS) S/N: 87X1-UP	
Air Filter Secondary.....	A-5502	Air Filter Secondary.....	A-5594	Air Filter Primary.....	A-5501
Air Filter Secondary.....	A-5534	Air Filter Primary.....	A-5593	Air Filter Secondary.....	A-5534
Air Filter Primary.....	A-5501	Air Filter Set.....	A-5595-S	Air Filter Secondary.....	A-5502
Air Filter Primary.....	A-5535	Air Filter.....	A-5584	Air Filter Set.....	A-5573-S
Air Filter Set.....	A-5573-S	Fuel Filter.....	FC-5517	Air Filter Primary.....	A-5535
Fuel Filter.....	F-5505	Hydraulic Oil Filter.....	H-5526	Fuel Filter.....	FC-5509
Fuel Filter.....	FC-5509	Hydraulic Oil Filter.....	H-5506	Fuel Filter.....	FC-5519
Hydraulic Oil Filter.....	H-5506	Hydraulic Oil Filter.....	H-55280	Hydraulic Oil Filter.....	H-5504
Hydraulic Oil Filter.....	H-5504	825H (COMPACTORS) CAT S/N: LHX1-UP		Hydraulic Oil Filter.....	H-5506
Oil Filter Full Flow.....	C-5516	Air Filter.....	A-5584	Oil Filter Full Flow.....	C-5516
825C (COMPACTORS) w/3406 Eng.		Air Filter Primary.....	A-5593		
Air Filter Primary.....	A-5535M	Air Filter Set.....	A-5595-S	826C (COMPACTORS) w/3406 Eng.	
Air Filter Set.....	A-5573M-S	Air Filter Secondary.....	A-5594	Air Filter Primary.....	A-5535M
		Fuel Filter.....	FC-5517	Air Filter Set.....	A-5573M-S

MODEL/APPLICATION	SAKURA NO	MODEL/APPLICATION	SAKURA NO	MODEL/APPLICATION	SAKURA NO
CATERPILLAR		CATERPILLAR		CATERPILLAR	
826G II (COMPACTORS) CAT S/N: AYH1-UP Air Filter Set..... A-5555-S Air Filter..... A-5584 Air Filter Secondary..... A-5556 Air Filter Primary..... A-5555 Fuel Filter..... FC-5509 Fuel Filter..... FC-5517 Fuel/Water Separator Secondary.. SFC-5504-10B Fuel/Water Separator Secondary... SFC-5504-10 Hydraulic Oil Filter..... H-5506 Hydraulic Oil Filter..... H-55280 Hydraulic Oil Filter..... H-5526 Oil Filter Full Flow..... C-5516		Fuel/Water Separator..... SFC-55250 82DC (DOZERS) Air Filter Primary..... A-5501 Air Filter Secondary..... A-5502 Coolant Filter..... WC-5707 Fuel Filter..... FC-5502 Hydraulic Oil Filter..... H-5506 Hydraulic Oil Filter..... H-5504 Oil Filter Full Flow..... C-5516 834B (DOZERS) CAT (S/N: 48W15340-19874) Fuel Filter..... FC-5509 834B (DOZERS) CAT (S/N: 48W19875-26423) Fuel Filter..... FC-5509 834B (DOZERS) CAT (S/N: 48W26424-UP) Fuel Filter..... FC-5509 834B (DOZERS) CAT (S/N: 48W9818-15339) Fuel Filter..... FC-5509 834B (DOZERS) CAT (S/N: 99C1-UP) Fuel Filter..... FC-5509 Fuel/Water Separator Secondary.. SFC-5504-10B Fuel/Water Separator Secondary... SFC-5504-10 834B (DOZERS) CAT 3408 (S/N: 92Z1-UP) Air Filter Primary..... A-5521 Air Filter Set..... A-5521-S Fuel Filter..... FC-5509 Hydraulic Oil Filter..... H-5504 Hydraulic Oil Filter..... H-5509 Oil Filter Full Flow..... C-5516 834B (DOZERS) CAT 3408E (S/N: 92Z1-UP) Air Filter Set..... A-5521-S Air Filter Primary..... A-5521 Fuel Filter..... FC-5509 Hydraulic Oil Filter..... H-5504 Hydraulic Oil Filter..... H-5509 Oil Filter Full Flow..... C-5516 834B (DOZERS) S/N: 7BR1-UP Air Filter Primary..... A-5555 Air Filter Secondary..... A-5556 Air Filter Set..... A-5555-S Hydraulic Oil Filter..... H-5509 Hydraulic Oil Filter..... HC-5504 Hydraulic Oil Filter..... H-55270 834B (DOZERS) S/N: 92Z1-327 Air Filter Set..... A-5521-S Air Filter Secondary..... A-5529 Air Filter Primary..... A-5521 Hydraulic Oil Filter..... H-55270		834B (DOZERS) S/N: 92Z328-328 Air Filter Secondary..... A-5529 Air Filter Set..... A-5521-S Air Filter Primary..... A-5521 Hydraulic Oil Filter..... H-55270 834B (DOZERS) S/N: 92Z329-378 Hydraulic Oil Filter..... H-55270 834B (DOZERS) S/N: 92Z379-UP Hydraulic Oil Filter..... H-55270 Hydraulic Oil Filter..... H-5509 834G (DOZERS) CAT (S/N: 7RC1515-UP) Fuel Filter..... FC-5509 834G (DOZERS) CAT (S/N: BNT10129-UP) Fuel Filter..... FC-5509 834G (DOZERS) CAT S/N: 7RC1-1514 Fuel Filter..... FC-5509 Oil Filter Full Flow..... C-5516 834G (DOZERS) CAT S/N: BNT1-10128 Fuel Filter..... FC-5509 Oil Filter Full Flow..... C-5516 834G (DOZERS) S/N: BPC1-UP Air Filter..... A-5584 Air Filter Set..... A-5565-S Air Filter Secondary..... A-5563 Air Filter Primary..... A-5564 Fuel/Water Separator Secondary.. SFC-5504-10 Fuel/Water Separator Secondary.. SFC-5504-10B Hydraulic Oil Filter..... HC-5504 Hydraulic Oil Filter..... HC-5512 834H (DOZERS) CAT (S/N: RHX1-UP) Fuel Filter..... FC-5510 Fuel Filter..... FC-5517 834H (DOZERS) CAT C18TA ACERT Cabin Air Filter..... CA-55120 834H (DOZERS) S/N: BTX1-UP Air Filter Set..... A-5595-S Air Filter..... A-5584 Air Filter Primary..... A-5593 Air Filter Secondary..... A-5594 Hydraulic Oil Filter..... HC-5504 Hydraulic Oil Filter..... HC-5512 834H (DOZERS) S/N: XDC1-UP Air Filter Secondary..... A-5594 Air Filter Primary..... A-5593	
826G II (COMPACTORS) CAT S/N: BKN1-UP Air Filter Primary..... A-5555 Air Filter Secondary..... A-5556 Air Filter..... A-5584 Air Filter Set..... A-5555-S Fuel Filter..... FC-5517 Fuel Filter..... FC-5509 Fuel/Water Separator Secondary.. SFC-5504-10 Fuel/Water Separator Secondary.. SFC-5504-10B Hydraulic Oil Filter..... H-5506 Hydraulic Oil Filter..... H-5526 Hydraulic Oil Filter..... H-55280 Oil Filter Full Flow..... C-5516					
826G II (COMPACTORS) w/3406 Eng. Fuel/Water Separator..... SFC-55170					
826H (COMPACTORS) CAT (S/N: LHX1-UP) Fuel Filter..... FC-5517					
826H (COMPACTORS) S/N: ANF1-UP Air Filter Primary..... A-5593 Air Filter Set..... A-5595-S Air Filter..... A-5584 Air Filter Secondary..... A-5594 Hydraulic Oil Filter..... H-55280 Hydraulic Oil Filter..... H-5506 Hydraulic Oil Filter..... H-5526					
826H (COMPACTORS) S/N: ZXT1-UP Air Filter Secondary..... A-5594 Air Filter..... A-5584 Air Filter Set..... A-5595-S Air Filter Primary..... A-5593 Hydraulic Oil Filter..... H-5526 Hydraulic Oil Filter..... H-55280 Hydraulic Oil Filter..... H-5506					
826H (COMPACTORS) W/C15 ENG. Fuel/Water Separator..... SFC-55170					
826K (COMPACTORS) W/C15 ENG.					

MODEL/APPLICATION	SAKURA NO
CATERPILLAR	
834H (DOZERS) S/N: XDC1-UP	
Air Filter Set.....	A-5595-S
Air Filter.....	A-5584
Hydraulic Oil Filter.....	HC-5512
Hydraulic Oil Filter.....	HC-5504
834H (DOZERS) w/C18 Eng.	
Fuel/Water Separator.....	SFC-55250
834 (DOZERS) S/N: 43E1-UP	
Air Filter Secondary.....	A-5520
Air Filter Secondary.....	A-5559
Air Filter Primary.....	A-5543
Air Filter Primary.....	A-5558
Air Filter Set.....	A-5544-S
Fuel Filter.....	F-5501
Hydraulic Oil Filter.....	H-5503
Oil Filter Full Flow.....	O-5503
834 (DOZERS) S/N: 92Z1-UP	
Air Filter Primary.....	A-5521
Air Filter Set.....	A-5521-S
Air Filter Secondary.....	A-5529
Oil Filter Full Flow.....	C-5516
834K (DOZERS) w/C18 Eng.	
Fuel/Water Separator.....	SFC-55250
835 (COMPACTORS) S/N: 44N1-298	
Air Filter Primary.....	A-5543
Air Filter Secondary.....	A-5520
Air Filter Primary.....	A-5558
Air Filter Set.....	A-5544-S
Air Filter Secondary.....	A-5559
Fuel Filter Secondary.....	FC-5507
Hydraulic Oil Filter.....	H-5503
Oil Filter Full Flow.....	O-5503
835 (COMPACTORS) S/N: 44N299-UP	
Air Filter Set.....	A-5544-S
Air Filter Primary.....	A-5558
Air Filter Primary.....	A-5543
Air Filter Secondary.....	A-5520
Air Filter Secondary.....	A-5559
Fuel Filter Secondary.....	FC-5507
Hydraulic Oil Filter.....	H-5503
Oil Filter Full Flow.....	O-5503
835K (DOZERS) CAT C18 ACERT	
Hydraulic Oil Filter Suction.....	H-5516
836 (COMPACTORS) CAT 3408 (S/N: 7FR1-263-UP)	
Air Filter Secondary.....	A-5529
Air Filter Set.....	A-5521-S
Air Filter Primary.....	A-5521
Fuel Filter.....	FC-5509

MODEL/APPLICATION	SAKURA NO
CATERPILLAR	
Fuel/Water Separator Secondary..	SFC-5504-10B
Fuel/Water Separator Secondary...	SFC-5504-10
Hydraulic Oil Filter.....	H-5504
Hydraulic Oil Filter.....	H-5509
Oil Filter Full Flow.....	C-5516
836 (COMPACTORS) CAT 3408 (S/N: 7FR1-264-UP)	
Air Filter Primary.....	A-5555
Air Filter Secondary.....	A-5556
Air Filter Set.....	A-5555-S
Fuel Filter.....	FC-5509
Fuel/Water Separator Secondary..	SFC-5504-10
Fuel/Water Separator Secondary..	SFC-5504-10B
Hydraulic Oil Filter.....	H-5504
Hydraulic Oil Filter.....	H-5509
Oil Filter Full Flow.....	C-5516
836 (COMPACTORS) S/N: 3RL1-UP	
Air Filter Primary.....	A-5521
Air Filter Set.....	A-5521-S
Air Filter Secondary.....	A-5529
Fuel Filter.....	F-5505
Fuel Filter.....	FC-5509
Hydraulic Oil Filter.....	H-5509
Hydraulic Oil Filter.....	H-5504
Hydraulic Oil Filter.....	H-55270
Oil Filter Full Flow.....	C-5516
836G (COMPACTORS) CAT 3456 DITA (S/N: 7MZ1-UP)	
Air Filter.....	A-5584
Air Filter Primary.....	A-5564
Air Filter Set.....	A-5565-S
Air Filter Secondary.....	A-5563
Fuel Filter.....	FC-5509
Fuel/Water Separator Secondary..	SFC-5504-10B
Fuel/Water Separator Secondary...	SFC-5504-10
Hydraulic Oil Filter.....	HC-5504
Hydraulic Oil Filter.....	HC-5503
Hydraulic Oil Filter.....	HC-5506
Hydraulic Oil Filter.....	HC-5512
Oil Filter Full Flow.....	C-5516
836H (COMPACTORS) CAT (S/N: RHX1-UP)	
Fuel Filter.....	FC-5510
Fuel Filter.....	FC-5517
836H (COMPACTORS) S/N: BXD1-429-UP	
Air Filter Primary.....	A-5593
Air Filter.....	A-5584
Air Filter Set.....	A-5595-S
Air Filter Secondary.....	A-5594
Hydraulic Oil Filter.....	HC-5504
Hydraulic Oil Filter.....	HC-5512
836H (COMPACTORS) S/N: BXD430-UP	
Air Filter Primary.....	A-5593
Air Filter Set.....	A-5595-S
Air Filter Secondary.....	A-5594
Hydraulic Oil Filter.....	HC-5504
Hydraulic Oil Filter.....	HC-5512

MODEL/APPLICATION	SAKURA NO
CATERPILLAR	
Hydraulic Oil Filter.....	HC-5504
836H (COMPACTORS) S/N: XTR1-UP	
Air Filter Set.....	A-5595-S
Air Filter Primary.....	A-5593
Air Filter Secondary.....	A-5594
Air Filter.....	A-5584
Hydraulic Oil Filter.....	HC-5512
Hydraulic Oil Filter.....	HC-5504
836H (COMPACTORS) w/C18 Eng.	
Fuel/Water Separator.....	SFC-55250
836C (COMPACTORS) S/N: 7FR1-225	
Air Filter Set.....	A-5555-S
Air Filter Primary.....	A-5555
Air Filter Secondary.....	A-5556
Fuel Filter.....	FC-5509
Hydraulic Oil Filter.....	H-5504
Oil Filter Full Flow.....	C-5516
836K (COMPACTORS) w/C18 Eng.	
Fuel/Water Separator.....	SFC-55250
844 (DOZERS) CAT 3412E	
Air Filter Set.....	A-5555-S
Air Filter Secondary.....	A-5556
Air Filter Primary.....	A-5555
Fuel Filter.....	FC-5509
Hydraulic Oil Filter.....	H-5506
Oil Filter Full Flow.....	C-5516
844 (DOZERS) CAT (S/N: 5JJ4077-4369)	
Fuel Filter.....	FC-5509
844 (DOZERS) CAT S/N: 5JJ251-4071	
Oil Filter Full Flow.....	C-5510
Oil Filter Full Flow.....	C-5516
844 (DOZERS) CAT S/N: 5JJ4370-UP	
Oil Filter Full Flow.....	C-5510
Oil Filter Full Flow.....	C-5516
844 (DOZERS) CAT S/N: 80M861-UP	
Oil Filter Full Flow.....	C-5516
Oil Filter Full Flow.....	C-5510
844 (DOZERS) CAT 3412 TAE	
Cabin Air Filter.....	CA-55120
844 (DOZERS) S/N: 2KZ1-UP	
Air Filter Set.....	A-5555-S
Air Filter Secondary.....	A-5556
Air Filter Primary.....	A-5555
Fuel/Water Separator Secondary..	SFC-5504-10B
Fuel/Water Separator Secondary...	SFC-5504-10

MODEL/APPLICATION	SAKURA NO
CATERPILLAR	
844 (DOZERS) S/N: 2KZ1-UP	
Hydraulic Oil Filter.....	H-5526
Hydraulic Oil Filter.....	H-5506
844 (DOZERS) S/N: BBN1-UP	
Air Filter Primary.....	A-5555
Air Filter Secondary.....	A-5556
Air Filter Set.....	A-5555-S
Fuel/Water Separator Secondary..	SFC-5504-10
Fuel/Water Separator Secondary..	SFC-5504-10B
Hydraulic Oil Filter.....	H-5506
Hydraulic Oil Filter.....	H-55280
Hydraulic Oil Filter.....	H-5526
844H (DOZERS) CAT S/N: BTW1-UP	
Air Filter Primary.....	A-5555
Air Filter Secondary.....	A-5556
Air Filter Set.....	A-5555-S
Fuel Filter.....	FC-5510
Hydraulic Oil Filter.....	HC-5504
Hydraulic Oil Filter.....	H-5526
Hydraulic Oil Filter.....	H-5506
Hydraulic Oil Filter.....	H-55280
Oil Filter Full Flow.....	C-5516
844H (DOZERS) CAT S/N: EHX1-2415-UP	
Air Filter Set.....	A-5555-S
Air Filter Secondary.....	A-5556
Air Filter Primary.....	A-5555
Fuel Filter.....	FC-5510
Hydraulic Oil Filter.....	H-55280
Hydraulic Oil Filter.....	H-5506
Hydraulic Oil Filter.....	HC-5504
Hydraulic Oil Filter.....	H-5526
Oil Filter Full Flow.....	C-5516
844H (DOZERS) CAT S/N: EHX2416-2486-UP	
Air Filter Primary.....	A-5555
Air Filter Set.....	A-5555-S
Air Filter Secondary.....	A-5556
Fuel Filter.....	FC-5510
Hydraulic Oil Filter.....	HC-5504
Hydraulic Oil Filter.....	H-5526
Hydraulic Oil Filter.....	H-55280
Hydraulic Oil Filter.....	H-5506
844H (DOZERS) CAT S/N: EHX2487-UP	
Air Filter Primary.....	A-5555
Air Filter Set.....	A-5555-S
Air Filter Secondary.....	A-5556
Fuel Filter.....	FC-5510
Hydraulic Oil Filter.....	H-5526
Hydraulic Oil Filter.....	HC-5504
Hydraulic Oil Filter.....	H-5506
Hydraulic Oil Filter.....	H-55280
Oil Filter Full Flow.....	C-5516

MODEL/APPLICATION	SAKURA NO
CATERPILLAR	
844H (DOZERS) CAT C27TA ACERT	
Cabin Air Filter.....	CA-55120
844K (DOZERS) CAT C27	
Fuel/Water Separator.....	SFC-55250
854G (DOZERS) CAT (S/N: 2GR1-2632-UP)	
Air Filter Primary.....	A-44220
Air Filter Set.....	A-44240-S
Air Filter Primary.....	A-5593
Air Filter Set.....	A-5595-S
Air Filter Secondary.....	A-44230
Air Filter Secondary.....	A-5715
Air Filter Secondary.....	A-5594
Fuel Filter.....	FC-5510
854G (DOZERS) CAT (S/N: 2GR2633-UP)	
Air Filter Primary.....	A-5593
Air Filter Set.....	A-5595-S
Air Filter Secondary.....	A-44230
Air Filter Secondary.....	A-5594
Air Filter Set.....	A-44240-S
Air Filter Secondary.....	A-5715
Air Filter Primary.....	A-44220
Fuel Filter.....	FC-5510
854G (DOZERS) CAT 3508TA	
Cabin Air Filter.....	CA-55120
854G (DOZERS) S/N: 1JW1-237-UP	
Hydraulic Oil Filter.....	HC-5512
Hydraulic Oil Filter.....	H-5526
Hydraulic Oil Filter.....	H-55280
854G (DOZERS) S/N: 1JW238-UP	
Hydraulic Oil Filter.....	H-5526
Hydraulic Oil Filter.....	H-55280
Hydraulic Oil Filter.....	HC-5512
Hydraulic Oil Filter.....	HC-5504
854G (DOZERS) S/N: A4W1-UP	
Hydraulic Oil Filter.....	H-55280
Hydraulic Oil Filter.....	HC-5512
Hydraulic Oil Filter.....	HC-5504
Hydraulic Oil Filter.....	H-5526
854G (DOZERS) S/N: AMP1-UP	
Hydraulic Oil Filter.....	H-55280
Hydraulic Oil Filter.....	HC-5512
Hydraulic Oil Filter.....	HC-5504
Hydraulic Oil Filter.....	H-5526
854K (DOZERS) CAT C32TA ACERT	
Cabin Air Filter.....	CA-55120

MODEL/APPLICATION	SAKURA NO
CATERPILLAR	
85C (TRACTORS) CAT 3176	
Hydraulic Oil Filter.....	H-5507
85D (TRACTORS) CAT S/N: 4GR1-UP	
Air Filter Secondary.....	A-5556
Air Filter Primary.....	A-5555
Air Filter Set.....	A-5555-S
Fuel Filter.....	FC-5509
Fuel Filter.....	FC-5517
Fuel/Water Separator Secondary..	SFC-5504-10B
Fuel/Water Separator Secondary..	SFC-5504-10
Hydraulic Oil Filter.....	HC-5503
Hydraulic Oil Filter.....	HC-5512
Hydraulic Oil Filter.....	HC-5506
Oil Filter Full Flow.....	C-5516
85D (TRACTORS) CAT S/N: 6AR1-UP	
Air Filter Secondary.....	A-5556
Air Filter Primary.....	A-5555
Air Filter Set.....	A-5555-S
Fuel Filter.....	FC-5517
Fuel Filter.....	FC-5509
Fuel/Water Separator Secondary..	SFC-5504-10
Fuel/Water Separator Secondary..	SFC-5504-10B
Hydraulic Oil Filter.....	HC-5503
Hydraulic Oil Filter.....	HC-5506
Hydraulic Oil Filter.....	HC-5512
Oil Filter Full Flow.....	C-5516
85E (TRACTORS) CAT 3196	
Hydraulic Oil Filter.....	H-5507
85E (TRACTORS) CAT S/N: 6AR1190-2131-UP	
Fuel Filter.....	FC-5517
Oil Filter Full Flow.....	C-5516
85E (TRACTORS) CAT S/N: 6AR2132-2142-UP	
Fuel Filter.....	FC-5517
Oil Filter Full Flow.....	C-5516
85E (TRACTORS) CAT S/N: 6AR2143-2645-UP	
Fuel Filter.....	FC-5517
Oil Filter Full Flow.....	C-5516
85E (TRACTORS) CAT S/N: 6AR2646-UP	
Fuel Filter.....	FC-5517
Oil Filter Full Flow.....	C-5516
85E (TRACTORS) CAT S/N: 6AR850-1189-UP	
Fuel Filter.....	FC-5517
Oil Filter Full Flow.....	C-5516
85E (TRACTORS) S/N: 1NM1-UP	
Air Filter Primary.....	A-5555
Air Filter Set.....	A-5555-S
Air Filter Secondary.....	A-5556

MODEL/APPLICATION	SAKURA NO
CATERPILLAR	
85E (TRACTORS) S/N: 1N1M1-UP	
Fuel/Water Separator Secondary..	SFC-5504-10
Fuel/Water Separator Secondary..	SFC-5504-10B
Hydraulic Oil Filter.....	HC-5506
Hydraulic Oil Filter.....	HC-5512
Hydraulic Oil Filter.....	HC-5503
85E (TRACTORS) S/N: 15M1-UP	
Air Filter Secondary.....	A-5556
Air Filter Primary.....	A-5555
Air Filter Set.....	A-5555-S
Fuel/Water Separator Secondary..	SFC-5504-10
Fuel/Water Separator Secondary..	SFC-5504-10B
Hydraulic Oil Filter.....	HC-5506
Hydraulic Oil Filter.....	HC-5512
Hydraulic Oil Filter.....	HC-5503
85E (TRACTORS) S/N: 6J51-UP	
Air Filter Secondary.....	A-5556
Air Filter Primary.....	A-5555
Air Filter Set.....	A-5555-S
Fuel/Water Separator Secondary..	SFC-5504-10B
Fuel/Water Separator Secondary..	SFC-5504-10
Hydraulic Oil Filter.....	HC-5506
Hydraulic Oil Filter.....	HC-5512
Hydraulic Oil Filter.....	HC-5503
85E (TRACTORS) S/N: 6K51-UP	
Air Filter Secondary.....	A-5556
Air Filter Primary.....	A-5555
Air Filter Set.....	A-5555-S
Fuel/Water Separator Secondary..	SFC-5504-10B
Fuel/Water Separator Secondary..	SFC-5504-10
Hydraulic Oil Filter.....	HC-5506
Hydraulic Oil Filter.....	HC-5512
Hydraulic Oil Filter.....	HC-5503
902 (LOADERS) CAT (S/N: 7E51-UP)	
Air Filter Secondary.....	A-8599
Air Filter Primary.....	A-8505
Hydraulic Oil Filter.....	HC-5504
Oil Filter Full Flow.....	C-1906
Oil Filter Full Flow.....	C-5504
906 (LOADERS) CAT (S/N: CJS1-UP)	
Oil Filter Full Flow.....	C-5504
906 (LOADERS) CAT 3044C (S/N: 6Z51-UP)	
Air Filter Secondary.....	A-8599
Air Filter Primary.....	A-8505
Hydraulic Oil Filter.....	HC-5504
Oil Filter Full Flow.....	C-5504
906 (LOADERS) S/N: MER1-UP	
Air Filter Primary.....	A-5541M
Air Filter Primary.....	A-76231

MODEL/APPLICATION	SAKURA NO
CATERPILLAR	
Air Filter Secondary.....	A-5540
Air Filter Set.....	A-5541M-S
Air Filter Primary.....	A-5541
Hydraulic Oil Filter.....	HC-5504
906H (LOADERS) CAT 3044C , 2007-UP	
Air Filter Secondary.....	A-5540
Air Filter Primary.....	A-5541M
Air Filter Set.....	A-5541M-S
Air Filter Primary.....	A-5541
Air Filter Primary.....	A-76231
Hydraulic Oil Filter.....	HC-5504
908 (LOADERS) CAT (S/N: 7B31-UP)	
Air Filter Secondary.....	A-8670
Air Filter Set.....	A-5675-S
Air Filter Primary.....	A-5673
Oil Filter Full Flow.....	C-5102
908 (LOADERS) CAT (S/N: CJS1-UP)	
Oil Filter Full Flow.....	C-5504
908 (LOADERS) CAT 3044C (S/N: 8B51-UP)	
Air Filter Primary.....	A-5541M
Air Filter Set.....	A-5541M-S
Air Filter Primary.....	A-76231
Air Filter Primary.....	A-5541
Air Filter Secondary.....	A-5540
Hydraulic Oil Filter.....	HC-5504
Oil Filter Full Flow.....	C-5102
908 (LOADERS) CAT 7B31-UP	
Air Filter Secondary.....	A-56741
Air Filter Primary.....	A-56731
Air Filter Set.....	A-56731-S
908 (LOADERS) S/N: TAR1-UP	
Air Filter Set.....	A-5541M-S
Air Filter Secondary.....	A-5540
Air Filter Primary.....	A-76231
Air Filter Primary.....	A-5541M
Air Filter Primary.....	A-5541
Hydraulic Oil Filter.....	HC-5504
910 (LOADERS) S/N: 40Y1-UP	
Air Filter Set.....	A-5542-S
Air Filter Secondary.....	A-5525
Air Filter Primary.....	A-5542
Fuel Filter.....	FC-5503
Hydraulic Oil Filter.....	H-5504
Oil Filter Full Flow.....	C-5519
910 (LOADERS) S/N: 41Y1-UP	
Air Filter Secondary.....	A-5525
Air Filter Set.....	A-5542-S
Air Filter Primary.....	A-5542
Fuel Filter.....	FC-5503
Hydraulic Oil Filter.....	H-5504
Fuel Filter Secondary.....	FC-5507

MODEL/APPLICATION	SAKURA NO
CATERPILLAR	
Hydraulic Oil Filter.....	H-5504
Oil Filter Full Flow.....	C-5519
910 (LOADERS) S/N: 45Y22861-33060	
Air Filter Set.....	A-5542-S
Air Filter Primary.....	A-5542
Air Filter Secondary.....	A-5525
Fuel Filter.....	FC-5503
Hydraulic Oil Filter.....	H-5504
Oil Filter Full Flow.....	C-5519
Oil Filter Full Flow.....	C-5504
910 (LOADERS) S/N: 45Y33061-UP	
Air Filter Secondary.....	A-5525
Air Filter Primary.....	A-5542
Air Filter Set.....	A-5542-S
Fuel Filter.....	FC-5503
Hydraulic Oil Filter.....	H-5504
Oil Filter Full Flow.....	C-5519
Oil Filter Full Flow.....	C-5504
910 (LOADERS) S/N: 80U1-UP	
Air Filter Secondary.....	A-5525
Air Filter Primary.....	A-5542
Air Filter Set.....	A-5542-S
Fuel Filter.....	FC-5503
Hydraulic Oil Filter.....	H-5504
Oil Filter Full Flow.....	C-5519
910 (LOADERS) w/3204 Eng.	
Air Filter Secondary.....	A-5590
910E (LOADERS) S/N: 15F1-1103	
Air Filter Primary.....	A-5511
Air Filter Set.....	A-5511-S
Fuel Filter Secondary.....	FC-5507
Fuel Filter.....	F-5505
Hydraulic Oil Filter.....	H-5510
Oil Filter Full Flow.....	C-5505
910E (LOADERS) S/N: 1YK1-1999	
Oil Filter Full Flow.....	C-5505
910F (LOADERS) CAT 3114T (S/N: 1KF-UP)	
Air Filter Set.....	A-5663-S
Air Filter Primary.....	A-5627
Air Filter Secondary.....	A-6008
Air Filter Set.....	A-5542-S
Air Filter Secondary.....	A-5525
Air Filter Primary.....	A-5542
Fuel Filter.....	FC-5501
Fuel Filter.....	FC-5516
Fuel Filter Secondary.....	FC-55151
Fuel Filter.....	FC-5523
Fuel Filter Secondary.....	FC-5515
Fuel Filter.....	F-5505
Hydraulic Oil Filter.....	H-5504
Oil Filter Full Flow.....	C-5505

MODEL/APPLICATION	SAKURA NO
CATERPILLAR	
910F (LOADERS) CAT 3114T (S/N: 1SF-UP)	
Air Filter Secondary.....	A-6008
Air Filter Set.....	A-5663-S
Air Filter Primary.....	A-5627
Air Filter Secondary.....	A-5525
Air Filter Primary.....	A-5542
Air Filter Set.....	A-5542-S
Fuel Filter.....	FC-5523
Fuel Filter Secondary.....	FC-5515
Fuel Filter.....	FC-5501
Fuel Filter.....	FC-5516
Fuel Filter Secondary.....	FC-55151
Fuel Filter.....	F-5505
Hydraulic Oil Filter.....	H-5504
Oil Filter Full Flow.....	C-5505
910F (LOADERS) S/N: 1KF1171-UP	
Fuel Filter Secondary.....	FC-55151
Fuel Filter.....	FC-5516
Fuel Filter Secondary.....	FC-5515
Oil Filter Full Flow.....	C-5505
910F (LOADERS) S/N: 1SF1100-UP	
Oil Filter Full Flow.....	C-5505
910F (LOADERS) S/N: 1SF1104-UP	
Air Filter Set.....	A-5663-S
Air Filter Secondary.....	A-6008
Air Filter Primary.....	A-5627
Fuel Filter.....	F-5505
Fuel Filter Secondary.....	FC-5515
Fuel Filter Secondary.....	FC-55151
Fuel Filter.....	FC-5516
Hydraulic Oil Filter.....	HC-5504
Hydraulic Oil Filter.....	H-5510
Oil Filter Full Flow.....	C-5505
910F (LOADERS) S/N: 1YK2000-UP	
Fuel Filter Secondary.....	FC-55151
Fuel Filter.....	FC-5516
Fuel Filter Secondary.....	FC-5515
Oil Filter Full Flow.....	C-5505
910G (LOADERS) CAT 3064	
Cabin Air Filter.....	CA-55130
910G (LOADERS) S/N: AKR1-UP	
Air Filter Primary.....	A-5541M
Air Filter Set.....	A-5541M-S
Air Filter Primary.....	A-5541
Air Filter Primary.....	A-76231
Hydraulic Oil Filter.....	HC-5504
914 (LOADERS) PERKINS	
Air Filter Primary.....	A-5627
Air Filter Set.....	A-5663-S

MODEL/APPLICATION	SAKURA NO
CATERPILLAR	
Hydraulic Oil Filter.....	HC-5504
Oil Filter Full Flow.....	C-5102
914G (LOADERS) CAT 7BJ1-UP , 2011	
Air Filter Set.....	A-56731-S
Air Filter Secondary.....	A-56741
Air Filter Primary.....	A-56731
914G (LOADERS) S/N: 7ZM440-653-UP , 2001-2014	
Air Filter Primary.....	A-5541M
Air Filter Primary.....	A-76231
Air Filter Secondary.....	A-5540
Air Filter Primary.....	A-5541
Air Filter Set.....	A-5663-S
Air Filter Set.....	A-5541M-S
Air Filter Primary.....	A-5627
Hydraulic Oil Filter.....	HC-5504
914G (LOADERS) CAT 3054T , 1998	
Cabin Air Filter.....	CA-55130
914G (LOADERS) CAT (S/N: 5HK11200-11200-UP)	
Oil Filter Full Flow.....	C-5102
914G (LOADERS) CAT (S/N: 5HK11201-UP)	
Oil Filter Full Flow.....	C-5102
914G (LOADERS) CAT (S/N: 7BJ1-UP)	
Air Filter Set.....	A-5675-S
Air Filter Secondary.....	A-8670
Air Filter Primary.....	A-5673
Oil Filter Full Flow.....	C-5102
914G (LOADERS) CAT (S/N: CRS1-UP)	
Oil Filter Full Flow.....	C-5102
914G (LOADERS) CAT 3054C DIT (S/N: 7ZM1-UP)	
Air Filter Primary.....	A-76231
Air Filter Primary.....	A-5541
Air Filter Set.....	A-5663-S
Air Filter Secondary.....	A-5540
Air Filter Primary.....	A-5541M
Air Filter Primary.....	A-5627
Air Filter Set.....	A-5541M-S
Hydraulic Oil Filter.....	HC-5504
Oil Filter Full Flow.....	C-5102
914G (LOADERS) CAT 3054C DIT (S/N: 9WM1-UP)	
Air Filter Set.....	A-5541M-S
Air Filter Set.....	A-5663-S
Air Filter Primary.....	A-5541
Air Filter Secondary.....	A-5540
Air Filter Primary.....	A-5627
Air Filter Primary.....	A-76231
Air Filter Primary.....	A-5541M
Hydraulic Oil Filter.....	HC-5504
Oil Filter Full Flow.....	C-5102

MODEL/APPLICATION	SAKURA NO
CATERPILLAR	
914G (LOADERS) S/N: 7ZM225-439-UP	
Air Filter Set.....	A-5663-S
Air Filter Primary.....	A-5627
Hydraulic Oil Filter.....	HC-5504
914G (LOADERS) S/N: 7ZM654-UP	
Air Filter Primary.....	A-5541M
Air Filter Set.....	A-5541M-S
Air Filter Primary.....	A-5627
Air Filter Primary.....	A-76231
Air Filter Secondary.....	A-5540
Air Filter Set.....	A-5663-S
Air Filter Primary.....	A-5541
Hydraulic Oil Filter.....	HC-5504
914G (LOADERS) S/N: 9WM363-1012-UP	
Air Filter Set.....	A-5663-S
Air Filter Primary.....	A-5627
Hydraulic Oil Filter.....	HC-5504
914G (LOADERS) S/N: PDF1-UP	
Air Filter Set.....	A-5541M-S
Air Filter Primary.....	A-5541
Air Filter Primary.....	A-5541M
Air Filter Secondary.....	A-5540
Air Filter Primary.....	A-76231
Hydraulic Oil Filter.....	HC-5504
916 (LOADERS) CAT (S/N: 45V42589-UP)	
Fuel Filter.....	FC-5523
Fuel Filter.....	FC-5501
Oil Filter Full Flow.....	C-5505
916 (LOADERS) CAT 3204 (S/N: 2XB1-UP)	
Air Filter Set.....	A-5507-S
Air Filter Primary.....	A-5507
Air Filter.....	A-5530
Air Filter Set.....	A-55071-S
Fuel Filter.....	F-5505
Fuel Filter Secondary.....	FC-5507
Hydraulic Oil Filter.....	H-5506
Oil Filter Full Flow.....	C-5505
916 (LOADERS) CAT 3204 (S/N: 5KC1-UP)	
Air Filter Set.....	A-55071-S
Air Filter Set.....	A-5507-S
Air Filter Primary.....	A-5507
Air Filter.....	A-5530
Fuel Filter Secondary.....	FC-5507
Fuel Filter.....	F-5505
Hydraulic Oil Filter.....	H-5506
Oil Filter Full Flow.....	C-5505
916 (LOADERS) CAT 3204 (S/N: 9WB1-UP)	
Air Filter Set.....	A-55071-S
Air Filter.....	A-5530

MODEL/APPLICATION	SAKURA NO
CATERPILLAR	
916 (LOADERS) CAT 3204 (S/N: 9WB1-UP)	
Air Filter Primary.....	A-5507
Air Filter Set.....	A-5507-S
Fuel Filter.....	F-5505
Fuel Filter Secondary.....	FC-5507
Hydraulic Oil Filter.....	H-5506
Oil Filter Full Flow.....	C-5505
916 (LOADERS) S/N: 9WB2005-UP	
Air Filter Set.....	A-55071-S
Air Filter Set.....	A-5507-S
Air Filter.....	A-5530
Air Filter Primary.....	A-5507
Fuel Filter.....	F-5505
Fuel Filter Secondary.....	FC-5507
Hydraulic Oil Filter.....	H-5506
Oil Filter Full Flow.....	C-5505
918F (LOADERS) CAT (S/N: 2FG4905-UP)	
Fuel Filter Secondary.....	FC-55151
Fuel Filter.....	FC-5516
Fuel Filter Secondary.....	FC-5515
Fuel Filter Secondary.....	FC-5507
Oil Filter Full Flow.....	C-5505
918F (LOADERS) CAT S/N: 2FG1500-4904-UP	
Fuel Filter Secondary.....	FC-5507
Oil Filter Full Flow.....	C-5505
918F (LOADERS) CAT S/N: 97Z152-UP	
Fuel Filter Secondary.....	FC-5507
Oil Filter Full Flow.....	C-5505
918F (LOADERS) S/N: 2CK1-UP	
Air Filter Primary.....	A-5566
Air Filter Set.....	A-5568-S
Air Filter Secondary.....	A-5567
Fuel Filter Secondary.....	FC-5507
Fuel Filter.....	F-5505
Hydraulic Oil Filter.....	HC-5504
Hydraulic Oil Filter.....	H-5506
Oil Filter Full Flow.....	C-5505
918F (LOADERS) S/N: 3TJ1-UP	
Air Filter Set.....	A-5568-S
Air Filter Secondary.....	A-5567
Air Filter Primary.....	A-5566
Fuel Filter Secondary.....	FC-55151
Fuel Filter Secondary.....	FC-5515
Fuel Filter.....	FC-5516
Fuel Filter.....	F-5505
Hydraulic Oil Filter.....	H-5506
Hydraulic Oil Filter.....	HC-5504
Oil Filter Full Flow.....	C-5505
918F (LOADERS) S/N: 5DL1-UP	
Air Filter Secondary.....	A-5567

MODEL/APPLICATION	SAKURA NO
CATERPILLAR	
Air Filter Primary.....	A-5566
Air Filter Set.....	A-5568-S
Fuel Filter.....	F-5505
Fuel Filter Secondary.....	FC-5507
Hydraulic Oil Filter.....	HC-5504
Hydraulic Oil Filter.....	H-5506
Oil Filter Full Flow.....	C-5505
920 (LOADERS)	
Air Filter Set.....	A-44180-S
Air Filter Primary.....	A-44180
920 (LOADERS) S/N: 62K11414-UP	
Air Filter Primary.....	A-5507
Air Filter Secondary.....	A-5567
Air Filter Set.....	A-5507-S
Air Filter Set.....	A-5568-S
Air Filter Secondary.....	A-5508
Air Filter Set.....	A-55071-S
Air Filter Primary.....	A-5566
Fuel Filter Secondary.....	FC-5507
Hydraulic Oil Filter.....	H-5504
Oil Filter Full Flow.....	C-5510
920 (LOADERS) S/N: 62K1-3389	
Air Filter Secondary.....	A-5508
Air Filter Primary.....	A-5507
Air Filter Set.....	A-55071-S
Air Filter Primary.....	A-5566
Air Filter Secondary.....	A-5567
Air Filter Set.....	A-5568-S
Air Filter Set.....	A-5507-S
Fuel Filter Secondary.....	FC-5507
Hydraulic Oil Filter.....	H-5504
Hydraulic Oil Filter.....	H-5503
Oil Filter Full Flow.....	O-5502
920 (LOADERS) S/N: 62K3390-11413	
Air Filter Set.....	A-5507-S
Air Filter Secondary.....	A-5508
Air Filter Secondary.....	A-5567
Air Filter Set.....	A-55071-S
Air Filter Primary.....	A-5507
Air Filter Primary.....	A-5566
Air Filter Set.....	A-5568-S
Fuel Filter Secondary.....	FC-5507
Hydraulic Oil Filter.....	H-5504
Hydraulic Oil Filter.....	H-5503
Oil Filter Full Flow.....	C-5510
920 (LOADERS) S/N: 62K3394	
Air Filter Secondary.....	A-5567
Air Filter Set.....	A-5507-S
Air Filter Set.....	A-5568-S
Air Filter Secondary.....	A-5508
Air Filter Set.....	A-55071-S
Air Filter Primary.....	A-5566
Air Filter Primary.....	A-5507
Fuel Filter Secondary.....	FC-5507

MODEL/APPLICATION	SAKURA NO
CATERPILLAR	
Hydraulic Oil Filter.....	H-5503
Hydraulic Oil Filter.....	H-5504
Oil Filter Full Flow.....	C-5510
920 (LOADERS) S/N: 62K3394-62K3394	
Air Filter Secondary.....	A-5508
Air Filter Primary.....	A-5507
Air Filter Secondary.....	A-5567
Air Filter Primary.....	A-5566
Air Filter Set.....	A-5507-S
Air Filter Set.....	A-5568-S
Air Filter Set.....	A-55071-S
Fuel Filter Secondary.....	FC-5507
Hydraulic Oil Filter.....	H-5504
Hydraulic Oil Filter.....	H-5503
Oil Filter Full Flow.....	O-5502
920 (LOADERS) S/N: 7531-UP	
Air Filter Primary.....	A-5507
Air Filter Set.....	A-5507-S
Air Filter Set.....	A-55071-S
Air Filter Secondary.....	A-5508
Fuel Filter Secondary.....	FC-5507
Hydraulic Oil Filter.....	H-5503
Hydraulic Oil Filter.....	H-5504
Oil Filter Full Flow.....	O-5502
Oil Filter Full Flow.....	C-5510
920 (LOADERS) w/3304 Eng.	
Hydraulic Oil Filter.....	H-55320
922A (LOADERS)	
Air Filter Secondary.....	A-5512
Air Filter Set.....	A-5511-S
Air Filter Set.....	A-5568-S
Air Filter Primary.....	A-5566
Air Filter Set.....	A-55071-S
Air Filter Secondary.....	A-5567
Air Filter Secondary.....	A-5508
Air Filter Primary.....	A-5511
Air Filter Set.....	A-5507-S
Air Filter Primary.....	A-5507
Fuel Filter.....	F-5505
Fuel Filter Secondary.....	FC-5507
Hydraulic Oil Filter.....	H-5503
Oil Filter Full Flow.....	O-5502
922B (LOADERS) S/N: 59A1-UP	
Air Filter Secondary.....	A-5512
Air Filter Set.....	A-5511-S
Air Filter Primary.....	A-5511
Fuel Filter.....	F-5501
Hydraulic Oil Filter.....	H-5503
Oil Filter Full Flow.....	O-5502
922B (LOADERS) S/N: 88J1-UP	
Air Filter Set.....	A-5507-S
Air Filter Set.....	A-55071-S

MODEL/APPLICATION	SAKURA NO	MODEL/APPLICATION	SAKURA NO	MODEL/APPLICATION	SAKURA NO
CATERPILLAR		CATERPILLAR		CATERPILLAR	
924F (LOADERS) S/N: 7PN1-UP Air Filter Set..... A-5568-S Air Filter Primary..... A-5566 Air Filter Secondary..... A-5567 Fuel Filter Secondary..... FC-55151 Fuel Filter..... FC-5516 Fuel Filter Secondary..... FC-5515 Fuel Filter..... F-5505 Hydraulic Oil Filter..... H-5506 Hydraulic Oil Filter..... HC-5504 Oil Filter Full Flow..... C-5505		Cabin Air Filter..... CA-55130 924G (LOADERS) S/N: 3PZ1-UP Air Filter Secondary..... A-8578 Air Filter Primary..... AS-8577 Hydraulic Oil Filter..... HC-5504 924G (LOADERS) S/N: 9SW1-UP Air Filter Primary..... AS-8577 Air Filter Secondary..... A-8578 Hydraulic Oil Filter..... HC-5504 924G (LOADERS) S/N: AAN1035-UP Air Filter Secondary..... A-8578 Air Filter Primary..... AS-8577 Hydraulic Oil Filter..... HC-5504 924G (LOADERS) CAT (S/N: CPT1-UP) Fuel Filter..... FC-5517 Oil Filter Full Flow..... C-5522 924G (LOADERS) CAT 3056E ATAAC (S/N: 3DZ1-UP) Air Filter Secondary..... A-8578 Air Filter Primary..... AS-8577 Hydraulic Oil Filter..... HC-5504 924G (LOADERS) CAT 3056E ATAAC (S/N: 3PZ1-UP) Air Filter Secondary..... A-8578 Air Filter Primary..... AS-8577 Hydraulic Oil Filter..... HC-5504 924G (LOADERS) CAT 3056E ATAAC (S/N: 6W1-UP) Air Filter Secondary..... A-8578 Air Filter Primary..... AS-8577 Hydraulic Oil Filter..... HC-5504 924G (LOADERS) CAT 3056E ATAAC (S/N: 6YW1-UP) Air Filter Secondary..... A-8578 Air Filter Primary..... AS-8577 Hydraulic Oil Filter..... HC-5504 924G (LOADERS) CAT 3056E ATAAC (S/N: 9SW1-UP) Air Filter Secondary..... A-8578 Air Filter Primary..... AS-8577 Hydraulic Oil Filter..... HC-5504 924G (LOADERS) CAT 3056E ATAAC (S/N: AAB1-UP) Air Filter Secondary..... A-8578 Air Filter Primary..... AS-8577 Hydraulic Oil Filter..... HC-5504 924G (LOADERS) CAT 3056E ATAAC (S/N: AAN1-UP) Air Filter Secondary..... A-8578 Air Filter Primary..... AS-8577 Hydraulic Oil Filter..... HC-5504 924G (LOADERS) CAT 3056E ATAAC Air Filter Secondary..... A-8578 Air Filter Primary..... AS-8577 Hydraulic Oil Filter..... HC-5504		924G (LOADERS) S/N: RBB900-1048-UP Air Filter Primary..... AS-8577 Air Filter Secondary..... A-8578 Hydraulic Oil Filter..... HC-5504 924G (LOADERS) S/N: WMB1-UP Air Filter Primary..... A-5105 Air Filter Secondary..... A-5106 Air Filter Secondary..... A-8578 Air Filter Primary..... AS-8577 Hydraulic Oil Filter..... HC-5504 924GZ (LOADERS) CAT (S/N: CPT1-UP) Fuel Filter..... FC-5517 Oil Filter Full Flow..... C-5522 924GZ (LOADERS) CAT 3056 (S/N: DFZ1-UP) Air Filter Primary..... AS-8577 Air Filter Secondary..... A-8578 Hydraulic Oil Filter..... HC-5504 Oil Filter Full Flow..... C-5510 924GZ (LOADERS) CAT 3056 (S/N: WGX1-UP) Air Filter Secondary..... A-8578 Air Filter Primary..... AS-8577 Hydraulic Oil Filter..... HC-5504 Oil Filter Full Flow..... C-5510 924GZ (LOADERS) CAT 3056E ATAAC (S/N: AAB451-UP) Air Filter Primary..... AS-8577 Air Filter Secondary..... A-8578 Hydraulic Oil Filter..... HC-5504 924GZ (LOADERS) CAT 3056E ATAAC Cabin Air Filter..... CA-55130 924GZ (LOADERS) S/N: AAB1-319-UP Air Filter Primary..... AS-8577 Air Filter Secondary..... A-8578 Hydraulic Oil Filter..... HC-5504 924GZ (LOADERS) S/N: AAB320-450-UP Air Filter Secondary..... A-8578 Air Filter Primary..... AS-8577 Hydraulic Oil Filter..... HC-5504 924GZ (LOADERS) S/N: RTA1-390-UP Air Filter Primary..... AS-8577 Air Filter Secondary..... A-8578 Hydraulic Oil Filter..... HC-5504 924GZ (LOADERS) S/N: RTA391-461-UP Air Filter Primary..... AS-8577 Air Filter Secondary..... A-8578 Air Filter Primary..... A-5105	

MODEL/APPLICATION	SAKURA NO	MODEL/APPLICATION	SAKURA NO	MODEL/APPLICATION	SAKURA NO
CATERPILLAR		CATERPILLAR		CATERPILLAR	
924GZ (LOADERS) S/N: RTA391-461-UP Air Filter Secondary..... A-5106 Hydraulic Oil Filter..... HC-5504		Hydraulic Oil Filter..... H-5506		926 (LOADERS) S/N: 94Z1821-2050-UP Air Filter Set..... A-5507-S Air Filter Primary..... A-5507 Air Filter..... A-5530 Air Filter Set..... A-55071-S Hydraulic Oil Filter..... H-5506 Hydraulic Oil Filter..... H-5501	
924GZ (LOADERS) S/N: RTA462-496-UP Air Filter Secondary..... A-8578 Air Filter Primary..... AS-8577 Hydraulic Oil Filter..... HC-5504		926 (LOADERS) S/N: 4NB-UP Air Filter Primary..... A-5507 Air Filter Secondary..... A-5567 Air Filter Primary..... A-5566 Air Filter Set..... A-5568-S Air Filter Set..... A-5507-S Air Filter Set..... A-55071-S Air Filter..... A-5530 Fuel Filter..... FC-5523 Fuel Filter Secondary..... FC-5507 Fuel Filter..... FC-5501 Hydraulic Oil Filter..... H-5506 Oil Filter Full Flow..... C-5505		926 (LOADERS) S/N: 94Z2051-UP Air Filter Primary..... A-5507 Air Filter..... A-5530 Air Filter Set..... A-55071-S Air Filter Set..... A-5507-S Hydraulic Oil Filter..... H-5506 Hydraulic Oil Filter..... H-5501	
924GZ (LOADERS) S/N: RTA497-UP Air Filter Primary..... A-5105 Air Filter Secondary..... A-5106 Air Filter Primary..... AS-8577 Air Filter Secondary..... A-8578 Hydraulic Oil Filter..... HC-5504		926 (LOADERS) S/N: 7TC1-833 Air Filter Primary..... A-5542 Air Filter Set..... A-5542-S Air Filter Secondary..... A-5525 Fuel Filter..... FC-5503 Oil Filter Full Flow..... C-5505		926E (LOADERS) CAT 3204 (S/N: 4NB1-3611-UP) Air Filter..... A-5530 Air Filter Set..... A-5507-S Air Filter Set..... A-55071-S Air Filter Primary..... A-5507 Fuel Filter Secondary..... FC-5507 Fuel Filter..... F-5505 Hydraulic Oil Filter..... H-5506 Oil Filter Full Flow..... C-5510 Oil Filter Full Flow..... C-5505	
924K (LOADERS) CAT C7.1 , 7100 Hydraulic Oil Filter Transmission.. EH-55060		926 (LOADERS) S/N: 8NB1-UP Air Filter..... A-5530 Air Filter Primary..... A-5507 Air Filter Set..... A-5507-S Air Filter Set..... A-55071-S Fuel Filter..... F-5505 Fuel Filter Secondary..... FC-5507 Hydraulic Oil Filter..... H-5506 Oil Filter Full Flow..... C-5505		926E (LOADERS) CAT 3204 (S/N: 4NB3612-UP) Air Filter Set..... A-55071-S Air Filter Primary..... A-5507 Air Filter..... A-5530 Air Filter Set..... A-5507-S Fuel Filter..... F-5505 Fuel Filter Secondary..... FC-5507 Hydraulic Oil Filter..... H-5506 Oil Filter Full Flow..... C-5505 Oil Filter Full Flow..... C-5510	
926 (LOADERS) CAT (S/N: 45V39562-UP) Fuel Filter..... FC-5501 Fuel Filter..... FC-5523 Oil Filter Full Flow..... C-5505		926 (LOADERS) S/N: 94Z1-1716-UP Air Filter..... A-5530 Air Filter Set..... A-55071-S Air Filter Set..... A-5507-S Air Filter Primary..... A-5507 Hydraulic Oil Filter..... H-5506 Hydraulic Oil Filter..... H-5501		926E (LOADERS) CAT 3204 (S/N: 7TC1-UP) Air Filter Primary..... A-5507 Air Filter Set..... A-5507-S Air Filter..... A-5530 Air Filter Set..... A-55071-S Fuel Filter..... F-5505 Fuel Filter Secondary..... FC-5507 Hydraulic Oil Filter..... H-5506 Oil Filter Full Flow..... C-5505 Oil Filter Full Flow..... C-5510	
926 (LOADERS) S/N: 4NB1026-1026-UP Hydraulic Oil Filter..... H-5501		926 (LOADERS) S/N: 94Z1-2208 Air Filter Set..... A-55071-S Air Filter Primary..... A-5507 Air Filter..... A-5530 Air Filter Set..... A-5507-S Fuel Filter Secondary..... FC-5507 Fuel Filter..... F-5505 Hydraulic Oil Filter..... H-5506 Oil Filter Full Flow..... C-5505		926E (LOADERS) CAT 3204 (S/N: 8NB1-1542-UP) Air Filter..... A-5530 Air Filter Primary..... A-5507 Air Filter Set..... A-55071-S Air Filter Set..... A-5507-S Fuel Filter Secondary..... FC-5507 Fuel Filter..... F-5505 Hydraulic Oil Filter..... H-5506	
926 (LOADERS) S/N: 4NB1027-1027-UP Hydraulic Oil Filter..... H-5501		926 (LOADERS) S/N: 94Z1717-1820-UP Air Filter Set..... A-55071-S Air Filter..... A-5530 Air Filter Set..... A-5507-S Air Filter Primary..... A-5507 Hydraulic Oil Filter..... H-5506 Hydraulic Oil Filter..... H-5501			
926 (LOADERS) S/N: 4NB1028-1588-UP Hydraulic Oil Filter..... H-5501					
926 (LOADERS) S/N: 4NB1-1025-UP Hydraulic Oil Filter..... H-5501					
926 (LOADERS) S/N: 4NB1589-1605-UP Hydraulic Oil Filter..... H-5501					
926 (LOADERS) S/N: 4NB1006-1840-UP Hydraulic Oil Filter..... H-5501					
926 (LOADERS) S/N: 4NB1841-3028-UP Air Filter Primary..... A-5507 Air Filter Set..... A-5507-S Air Filter Set..... A-55071-S Air Filter..... A-5530 Hydraulic Oil Filter..... H-5501					
926 (LOADERS) S/N: 4NB3029-UP Air Filter Primary..... A-5507 Air Filter Set..... A-5507-S Air Filter..... A-5530 Air Filter Set..... A-55071-S Hydraulic Oil Filter..... H-5501					

MODEL/APPLICATION	SAKURA NO	MODEL/APPLICATION	SAKURA NO	MODEL/APPLICATION	SAKURA NO
CATERPILLAR		CATERPILLAR		CATERPILLAR	
926E (LOADERS) CAT 3204 (S/N: 8NB1-1542-UP) Oil Filter Full Flow..... C-5510 Oil Filter Full Flow..... C-5505		928F (LOADERS) CAT S/N: 98Z4533-15831-UP Fuel Filter Secondary..... FC-55151 Fuel Filter..... FC-5516 Fuel Filter Secondary..... FC-5515 Oil Filter Full Flow..... C-5522		Air Filter Secondary..... A-5567 Air Filter Set..... A-5568-S Fuel Filter Secondary..... FC-5515 Fuel Filter Secondary..... FC-55151 Fuel Filter..... FC-5516 Hydraulic Oil Filter..... HC-5508 Hydraulic Oil Filter..... H-5506 Oil Filter Full Flow..... C-5510	
926E (LOADERS) CAT 3204 (S/N: 8NB1543-UP) Air Filter Set..... A-55071-S Air Filter..... A-5530 Air Filter Primary..... A-5507 Air Filter Set..... A-5507-S Fuel Filter..... F-5505 Fuel Filter Secondary..... FC-5507 Hydraulic Oil Filter..... H-5506 Oil Filter Full Flow..... C-5505 Oil Filter Full Flow..... C-5510		928F (LOADERS) CAT S/N: 98Z820-4532-UP Fuel Filter..... FC-5501 Fuel Filter..... FC-5523 Oil Filter Full Flow..... C-5522		928F (LOADERS) S/N: 8AK1-494-UP Air Filter Secondary..... A-5567 Air Filter Primary..... A-5566 Air Filter Set..... A-5568-S Cabin Air Filter..... CA-55070 Hydraulic Oil Filter..... H-5506 Hydraulic Oil Filter..... HC-5508	
926E (LOADERS) S/N: 8NB2452-UP Air Filter..... A-5530 Air Filter Primary..... A-5507 Air Filter Set..... A-55071-S Air Filter Set..... A-5507-S Fuel Filter..... F-5505 Fuel Filter Secondary..... FC-5507 Oil Filter Full Flow..... C-5505		928F (LOADERS) S/N: 2XL1-578-UP Air Filter Secondary..... A-5567 Air Filter Set..... A-5568-S Air Filter Primary..... A-5566 Cabin Air Filter..... CA-55070 Hydraulic Oil Filter..... HC-5504 Hydraulic Oil Filter..... H-5506		928F (LOADERS) S/N: 8AK1-699 Air Filter Secondary..... A-5567 Air Filter Primary..... A-5566 Air Filter Set..... A-5568-S Fuel Filter..... F-5505 Hydraulic Oil Filter..... HC-5504 Hydraulic Oil Filter..... H-5506 Oil Filter Full Flow..... C-5510	
926M (LOADERS) CAT C7.1 Fuel Filter..... EF-55050		928F (LOADERS) S/N: 2XL1-1757-UP Air Filter Primary..... A-5566 Air Filter Secondary..... A-5567 Air Filter Set..... A-5568-S Cabin Air Filter..... CA-55070 Hydraulic Oil Filter..... H-5506		928F (LOADERS) S/N: 8AK495-867-UP Air Filter Secondary..... A-5567 Air Filter Set..... A-5568-S Air Filter Primary..... A-5566 Cabin Air Filter..... CA-55070 Hydraulic Oil Filter..... HC-5508 Hydraulic Oil Filter..... H-5506	
928F (LOADERS) CAT S/N: 4TF14750-UP Fuel Filter Secondary..... FC-5515 Fuel Filter Secondary..... FC-55151 Fuel Filter..... FC-5516 Oil Filter Full Flow..... C-5522		928F (LOADERS) S/N: 2XL1-UP Air Filter Secondary..... A-5567 Air Filter Set..... A-5568-S Air Filter Primary..... A-5566 Fuel Filter..... FC-5516 Fuel Filter..... F-5505 Fuel Filter Secondary..... FC-5515 Fuel Filter Secondary..... FC-55151 Hydraulic Oil Filter..... H-5506 Hydraulic Oil Filter..... HC-5504 Oil Filter Full Flow..... C-5510		928F (LOADERS) S/N: 8AK700-UP Air Filter Primary..... A-5566 Air Filter Set..... A-5568-S Air Filter Secondary..... A-5567 Fuel Filter Secondary..... FC-5515 Fuel Filter..... FC-5516 Fuel Filter..... F-5505 Fuel Filter Secondary..... FC-55151 Hydraulic Oil Filter..... H-5506 Hydraulic Oil Filter..... HC-5504 Oil Filter Full Flow..... C-5510	
928F (LOADERS) CAT S/N: 4TF8700-14749-UP Fuel Filter..... FC-5523 Fuel Filter..... FC-5501 Oil Filter Full Flow..... C-5522		928F (LOADERS) S/N: 2XL579-1756-UP Air Filter Primary..... A-5566 Air Filter Secondary..... A-5567 Air Filter Set..... A-5568-S Cabin Air Filter..... CA-55070 Hydraulic Oil Filter..... HC-5504 Hydraulic Oil Filter..... H-5506		928F (LOADERS) S/N: 8AK868-UP Air Filter Set..... A-5568-S Air Filter Primary..... A-5566 Air Filter Secondary..... A-5567 Cabin Air Filter..... CA-55070 Hydraulic Oil Filter..... H-5506	
928F (LOADERS) CAT S/N: 6RR177-657-UP Fuel Filter Secondary..... FC-55151 Fuel Filter..... FC-5516 Fuel Filter Secondary..... FC-5515 Oil Filter Full Flow..... C-5522		928F (LOADERS) S/N: 7YM1-UP Fuel Filter..... FC-5516 Fuel Filter Secondary..... FC-55151 Fuel Filter Secondary..... FC-5515 Hydraulic Oil Filter..... H-5506 Hydraulic Oil Filter..... HC-5508 Oil Filter Full Flow..... C-5510		928F (LOADERS) S/N: 8AK868-UP Air Filter Set..... A-5568-S Air Filter Primary..... A-5566 Air Filter Secondary..... A-5567 Cabin Air Filter..... CA-55070 Hydraulic Oil Filter..... H-5506	
928F (LOADERS) CAT S/N: 6RR658-UP Fuel Filter Secondary..... FC-55151 Fuel Filter..... FC-5516 Fuel Filter Secondary..... FC-5515 Oil Filter Full Flow..... C-5522		928F (LOADERS) S/N: 8AK11-UP Air Filter Primary..... A-5566		928G (LOADERS) CAT 3116T , 1998 Cabin Air Filter..... CA-55130	
928F (LOADERS) CAT S/N: 98Z15832-UP Fuel Filter Secondary..... FC-55151 Fuel Filter Secondary..... FC-5515 Fuel Filter..... FC-5516 Oil Filter Full Flow..... C-5522		928F (LOADERS) S/N: 8AK11-UP Air Filter Primary..... A-5566		928G (LOADERS) CAT (S/N: 98Z1-130-UP) Fuel Filter Secondary..... FC-55151	

MODEL/APPLICATION	SAKURA NO
CATERPILLAR	
928G (LOADERS) CAT (S/N: 98Z1-130-UP)	
Fuel Filter Secondary.....	FC-5515
Fuel Filter.....	FC-5516
928G (LOADERS) CAT (S/N: 98Z131-UP)	
Fuel Filter Secondary.....	FC-5515
Fuel Filter Secondary.....	FC-55151
Fuel Filter.....	FC-5516
Fuel Filter.....	FC-5508
928G (LOADERS) CAT (S/N: CPT1-UP)	
Fuel Filter.....	FC-5517
Oil Filter Full Flow.....	C-5522
928G (LOADERS) CAT 3056E ATAAC (S/N: 6XR1-UP)	
Air Filter Secondary.....	A-8578
Air Filter Primary.....	AS-8577
Fuel Filter.....	FC-5508
Fuel Filter.....	FC-5516
Fuel Filter Secondary.....	FC-55151
Fuel Filter Secondary.....	FC-5515
Hydraulic Oil Filter.....	HC-5504
Oil Filter Full Flow.....	C-5510
928G (LOADERS) CAT 3056E ATAAC (S/N: 6XR-UP)	
Air Filter Secondary.....	A-8578
Air Filter Primary.....	AS-8577
Fuel Filter Secondary.....	FC-55151
Fuel Filter.....	FC-5516
Fuel Filter Secondary.....	FC-5515
Hydraulic Oil Filter.....	HC-5508
Hydraulic Oil Filter.....	HC-5504
Oil Filter Full Flow.....	C-5510
928G (LOADERS) CAT 3056E ATAAC (S/N: 7SR1-UP)	
Air Filter Primary.....	AS-8577
Air Filter Secondary.....	A-8578
Fuel Filter Secondary.....	FC-55151
Fuel Filter Secondary.....	FC-5515
Fuel Filter.....	FC-5516
Hydraulic Oil Filter.....	HC-5504
Oil Filter Full Flow.....	C-5510
928G (LOADERS) CAT S/N: 4TF25000-UP	
Fuel Filter.....	FC-5516
Fuel Filter Secondary.....	FC-5515
Fuel Filter.....	FC-5508
Fuel Filter Secondary.....	FC-55151
Oil Filter Full Flow.....	C-5522
928G (LOADERS) CAT S/N: 6RR1-UP	
Fuel Filter.....	FC-5508
Fuel Filter Secondary.....	FC-5515
Fuel Filter.....	FC-5516
Fuel Filter Secondary.....	FC-55151
Oil Filter Full Flow.....	C-5522

MODEL/APPLICATION	SAKURA NO
CATERPILLAR	
928G (LOADERS) S/N: 6XR1543-UP	
Air Filter Primary.....	A-5566
Air Filter Set.....	A-5568-S
Air Filter Secondary.....	A-5567
Hydraulic Oil Filter.....	HC-5504
928G (LOADERS) S/N: 6XR1-885-UP	
Air Filter Set.....	A-5568-S
Air Filter Secondary.....	A-5567
Air Filter Primary.....	A-5566
Hydraulic Oil Filter.....	HC-5504
928G (LOADERS) S/N: 6XR886-1542-UP	
Air Filter Primary.....	A-5566
Air Filter Set.....	A-5568-S
Air Filter Secondary.....	A-5567
Hydraulic Oil Filter.....	HC-5504
928G (LOADERS) S/N: 7SR1-1380-UP	
Air Filter Primary.....	A-5566
Air Filter Set.....	A-5568-S
Air Filter Secondary.....	A-5567
Hydraulic Oil Filter.....	HC-5504
928G (LOADERS) S/N: 7SR1381-UP	
Air Filter Secondary.....	A-5567
Air Filter Primary.....	A-5566
Air Filter Set.....	A-5568-S
Hydraulic Oil Filter.....	HC-5504
928G (LOADERS) S/N: DJD1-UP	
Air Filter Primary.....	A-5105
Air Filter Secondary.....	A-8578
Air Filter Primary.....	AS-8577
Air Filter Secondary.....	A-5106
Hydraulic Oil Filter.....	HC-5504
928G (LOADERS) S/N: WLG1-UP	
Air Filter Primary.....	AS-8577
Air Filter Secondary.....	A-5106
Air Filter Secondary.....	A-8578
Air Filter Primary.....	A-5105
Hydraulic Oil Filter.....	HC-5504
930 (LOADERS) S/N: 17B1-219	
Air Filter Secondary.....	A-5508
Air Filter Set.....	A-5568-S
Air Filter Set.....	A-55071-S
Air Filter Primary.....	A-5566
Air Filter Secondary.....	A-5567
Air Filter Set.....	A-5507-S
Air Filter Primary.....	A-5507
Fuel Filter.....	F-5505
Hydraulic Oil Filter.....	H-5503
Oil Filter Full Flow.....	C-5510

MODEL/APPLICATION	SAKURA NO
CATERPILLAR	
930 (LOADERS) S/N: 17B220-999	
Air Filter Set.....	A-5507-S
Air Filter.....	A-5530
Air Filter Primary.....	A-5507
Air Filter Set.....	A-55071-S
Air Filter Secondary.....	A-5508
Fuel Filter.....	F-5505
Fuel Filter Secondary.....	FC-5507
Hydraulic Oil Filter.....	H-55280
Hydraulic Oil Filter.....	H-5503
Hydraulic Oil Filter.....	H-5526
Oil Filter Full Flow.....	C-5510
930 (LOADERS) S/N: 41K1-2326	
Air Filter Primary.....	A-5566
Air Filter Set.....	A-5568-S
Air Filter Primary.....	A-5507
Air Filter Set.....	A-55071-S
Air Filter Secondary.....	A-5508
Air Filter Secondary.....	A-5567
Air Filter Set.....	A-5507-S
Fuel Filter Secondary.....	FC-5507
Hydraulic Oil Filter.....	H-5504
Hydraulic Oil Filter.....	H-5503
Oil Filter Full Flow.....	C-5510
930 (LOADERS) S/N: 41K2327-5314	
Air Filter Secondary.....	A-5567
Air Filter Set.....	A-5568-S
Air Filter Primary.....	A-5507
Air Filter Set.....	A-55071-S
Air Filter Secondary.....	A-5508
Air Filter Primary.....	A-5566
Air Filter Set.....	A-5507-S
Fuel Filter Secondary.....	FC-5507
Hydraulic Oil Filter.....	H-5503
Hydraulic Oil Filter.....	H-5504
Oil Filter Full Flow.....	C-5510
930 (LOADERS) S/N: 73M1-UP	
Air Filter Secondary.....	A-5508
Air Filter Set.....	A-5507-S
Air Filter Set.....	A-55071-S
Air Filter Primary.....	A-5507
Air Filter Set.....	A-5568-S
Air Filter Secondary.....	A-5567
Air Filter Primary.....	A-5566
Fuel Filter Secondary.....	FC-5507
Hydraulic Oil Filter.....	H-5504
Hydraulic Oil Filter.....	H-5503
Oil Filter Full Flow.....	C-5510
930 (LOADERS) S/N: 79J1-UP	
Air Filter Secondary.....	A-5508
Air Filter Set.....	A-55071-S
Air Filter Set.....	A-5568-S
Air Filter Primary.....	A-5507
Air Filter Secondary.....	A-5567

MODEL/APPLICATION	SAKURA NO
CATERPILLAR	
930 (LOADERS) S/N: 7931-UP	
Air Filter Primary.....	A-5566
Air Filter Set.....	A-5507-S
Fuel Filter Secondary.....	FC-5507
Hydraulic Oil Filter.....	H-5504
Hydraulic Oil Filter.....	H-5503
Oil Filter Full Flow.....	C-5510
930G (LOADERS) CAT S/N: CPT1-UP , 2007-UP	
Air Filter Secondary.....	A-5106
Air Filter Primary.....	A-5105
Air Filter Primary.....	AS-8577
Air Filter Secondary.....	A-8578
Fuel Filter.....	FC-5517
Hydraulic Oil Filter.....	HC-5504
Oil Filter Full Flow.....	C-5522
930G (LOADERS) CAT S/N: TFW1-UP , 2007-UP	
Air Filter Primary.....	A-5105
Air Filter Secondary.....	A-8578
Air Filter Primary.....	AS-8577
Air Filter Secondary.....	A-5106
Fuel Filter.....	FC-5517
Hydraulic Oil Filter.....	HC-5504
Oil Filter Full Flow.....	C-5522
930G (LOADERS) CAT S/N: TWR1-786-UP , 2007-UP	
Air Filter Secondary.....	A-8578
Air Filter Primary.....	A-5105
Air Filter Secondary.....	A-5106
Air Filter Primary.....	AS-8577
Fuel Filter.....	FC-5517
Hydraulic Oil Filter.....	HC-5504
Oil Filter Full Flow.....	C-5522
930G (LOADERS) CAT S/N: TWR787-UP , 2007-UP	
Air Filter Primary.....	A-5105
Air Filter Secondary.....	A-5106
Fuel Filter.....	FC-5517
Hydraulic Oil Filter.....	HC-5504
Oil Filter Full Flow.....	C-5522
930R (LOADERS) CAT 3304	
Air Filter Set.....	A-44180-S
Air Filter Primary.....	A-44180
930R (LOADERS) CAT (S/N: 4YD1-1221)	
Fuel Filter.....	FC-5501
Fuel Filter.....	FC-5523
Oil Filter Full Flow.....	C-5510
930R (LOADERS) CAT (S/N: 4YD1222-2199)	
Fuel Filter.....	FC-5523
Fuel Filter.....	FC-5501
Oil Filter Full Flow.....	C-5522
Oil Filter Full Flow.....	C-5510

MODEL/APPLICATION	SAKURA NO
CATERPILLAR	
930R (LOADERS) CAT (S/N: 4YD2200-UP)	
Fuel Filter.....	FC-5501
Fuel Filter.....	FC-5523
Oil Filter Full Flow.....	C-5522
930R (LOADERS) S/N: 57Z1275-3999	
Air Filter Set.....	A-55071-S
Air Filter Set.....	A-5507-S
Air Filter Primary.....	A-5507
Air Filter Secondary.....	A-5508
Hydraulic Oil Filter.....	H-5503
Hydraulic Oil Filter.....	H-5501
930R (LOADERS) S/N: 57Z1-3016	
Air Filter Secondary.....	A-5508
Air Filter Set.....	A-5507-S
Air Filter Primary.....	A-5507
Air Filter Set.....	A-55071-S
Fuel Filter.....	F-5505
Fuel Filter Secondary.....	FC-5507
Hydraulic Oil Filter.....	H-5503
Hydraulic Oil Filter.....	H-55280
Hydraulic Oil Filter.....	H-5526
Oil Filter Full Flow.....	C-5510
930R (LOADERS) S/N: 57Z1-3999	
Air Filter Secondary.....	A-5508
Air Filter Set.....	A-5507-S
Air Filter Primary.....	A-5507
Air Filter Primary.....	A-5566
Air Filter Secondary.....	A-5567
Air Filter Set.....	A-55071-S
Air Filter Set.....	A-5568-S
Fuel Filter Secondary.....	FC-5507
Hydraulic Oil Filter.....	H-5503
Oil Filter Full Flow.....	C-5510
930R (LOADERS) S/N: 57Z1-971	
Hydraulic Oil Filter.....	H-5501
Hydraulic Oil Filter.....	H-5503
930R (LOADERS) S/N: 57Z3017-3999	
Air Filter Secondary.....	A-5508
Air Filter Primary.....	A-5507
Air Filter Set.....	A-55071-S
Air Filter Set.....	A-5507-S
Fuel Filter Secondary.....	FC-5507
Fuel Filter.....	F-5505
Hydraulic Oil Filter.....	H-5526
Hydraulic Oil Filter.....	H-55280
Hydraulic Oil Filter.....	H-5503
Oil Filter Full Flow.....	C-5510
930R (LOADERS) S/N: 57Z4000-4612	
Air Filter Primary.....	A-5507
Air Filter Set.....	A-5507-S
Air Filter.....	A-5530

MODEL/APPLICATION	SAKURA NO
CATERPILLAR	
Air Filter Set.....	A-55071-S
Hydraulic Oil Filter.....	H-5503
Hydraulic Oil Filter.....	H-5501
930R (LOADERS) S/N: 57Z4613-UP	
Air Filter Set.....	A-5507-S
Air Filter.....	A-5530
Air Filter Set.....	A-55071-S
Air Filter Primary.....	A-5507
Hydraulic Oil Filter.....	H-5501
Hydraulic Oil Filter.....	H-5503
930R (LOADERS) S/N: 57Z972-1274	
Air Filter Secondary.....	A-5508
Air Filter Primary.....	A-5507
Air Filter Set.....	A-5507-S
Air Filter Set.....	A-55071-S
Hydraulic Oil Filter.....	H-5501
Hydraulic Oil Filter.....	H-5503
930T (LOADERS) S/N: 17B1000-2010	
Air Filter Primary.....	A-5507
Air Filter Set.....	A-5507-S
Air Filter Set.....	A-55071-S
Air Filter.....	A-5530
Fuel Filter.....	F-5505
Fuel Filter Secondary.....	FC-5507
Hydraulic Oil Filter.....	H-55280
Hydraulic Oil Filter.....	H-5503
Hydraulic Oil Filter.....	H-5526
Oil Filter Full Flow.....	C-5510
930T (LOADERS) S/N: 57Z4000-UP	
Air Filter.....	A-5530
Air Filter Set.....	A-55071-S
Air Filter Primary.....	A-5507
Air Filter Set.....	A-5507-S
Fuel Filter Secondary.....	FC-5507
Fuel Filter.....	F-5505
Hydraulic Oil Filter.....	H-55280
Hydraulic Oil Filter.....	H-5503
Hydraulic Oil Filter.....	H-5526
Oil Filter Full Flow.....	C-5510
930T SERIES II (LOADERS) S/N: 17B2011-UP	
Air Filter Primary.....	A-5509
Air Filter.....	A-5530
Air Filter Set.....	A-5522-S
Fuel Filter.....	F-5505
Fuel Filter Secondary.....	FC-5507
Hydraulic Oil Filter.....	H-5526
Hydraulic Oil Filter.....	H-55280
Hydraulic Oil Filter.....	H-5503
Oil Filter Full Flow.....	C-5510
930M (LOADERS) CAT C7.1	
Fuel Filter.....	EF-55050

MODEL/APPLICATION	SAKURA NO	MODEL/APPLICATION	SAKURA NO	MODEL/APPLICATION	SAKURA NO
CATERPILLAR		CATERPILLAR		CATERPILLAR	
931 (LOADERS) S/N: 10N1-UP		Fuel Filter.....	FC-5503	Hydraulic Oil Filter.....	H-5504
Air Filter Primary.....	A-5542	Hydraulic Oil Filter.....	H-5504	Oil Filter Full Flow.....	C-5519
Air Filter Set.....	A-5542-S				
Air Filter Secondary.....	A-5525	931B (LOADERS) S/N: 30Y1-UP		931C (LOADERS) S/N: 7HF1-UP	
Fuel Filter.....	FC-5503	Air Filter Primary.....	A-5542	Air Filter Set.....	A-5542-S
Hydraulic Oil Filter.....	H-5504	Air Filter Set.....	A-5542-S	Air Filter Primary.....	A-5542
Oil Filter Full Flow.....	C-5504	Air Filter Secondary.....	A-5525	Air Filter Secondary.....	A-5525
		Fuel Filter.....	FC-5503	Fuel Filter Secondary.....	FC-5507
931 (LOADERS) S/N: 78U1-UP		Hydraulic Oil Filter.....	H-55270	Hydraulic Oil Filter.....	H-5504
Air Filter Primary.....	A-5542	Hydraulic Oil Filter.....	H-5504	Hydraulic Oil Filter.....	H-55270
Air Filter Secondary.....	A-5525	Oil Filter Full Flow.....	C-5519	Oil Filter Full Flow.....	C-5519
Air Filter Set.....	A-5542-S				
Fuel Filter.....	FC-5503	931B (LOADERS) S/N: 4SC1-UP		931C (LOADERS) S/N: 8AF1-UP	
Hydraulic Oil Filter.....	H-5504	Air Filter Primary.....	A-5542	Air Filter Primary.....	A-5542
Oil Filter Full Flow.....	C-5504	Air Filter Set.....	A-5542-S	Air Filter Secondary.....	A-5525
		Air Filter Secondary.....	A-5525	Air Filter Set.....	A-5542-S
931 (LOADERS) S/N: 81U1-UP		Fuel Filter.....	FC-5503	Fuel Filter Secondary.....	FC-5507
Air Filter Secondary.....	A-5525	Hydraulic Oil Filter.....	H-5504	Hydraulic Oil Filter.....	H-55270
Air Filter Set.....	A-5542-S	Hydraulic Oil Filter.....	H-55270	Hydraulic Oil Filter.....	H-5504
Air Filter Primary.....	A-5542	Oil Filter Full Flow.....	C-5519	Oil Filter Full Flow.....	C-5519
Fuel Filter.....	FC-5503				
Oil Filter Full Flow.....	C-5504	931B (LOADERS) S/N: 6EC1-UP		931C (LOADERS) w/3204 Eng.	
		Air Filter Primary.....	A-5542	Air Filter Secondary.....	A-5590
931 (LOADERS) w/3204 Eng.		Air Filter Set.....	A-5542-S	Hydraulic Oil Filter.....	H-55320
Air Filter Secondary.....	A-5590	Air Filter Secondary.....	A-5525		
		Fuel Filter.....	FC-5503	933 (LOADERS) CAT (S/N: 5XK1-UP)	
931B (LOADERS) CAT 3204		Hydraulic Oil Filter.....	H-5504	Fuel Filter Secondary.....	FC-55151
Air Filter Set.....	A-5542-S	Hydraulic Oil Filter.....	H-55270	Fuel Filter Secondary.....	FC-5515
Air Filter Primary.....	A-5542	Oil Filter Full Flow.....	C-5519	Fuel Filter.....	FC-5516
Air Filter Secondary.....	A-5525			Fuel Filter.....	FC-1010
Fuel Filter.....	FC-5503	931B (LOADERS) w/3204 Eng.		Oil Filter Full Flow.....	C-5504
Hydraulic Oil Filter.....	H-5504	Air Filter Secondary.....	A-5590		
Oil Filter Full Flow.....	C-5519	Hydraulic Oil Filter.....	H-55320	933 (LOADERS) S/N: 11A-UP	
				Oil Filter Full Flow.....	0-5501
931B (LOADERS) S/N: 25Y1-UP		931C (LOADERS) S/N: 2B11-UP			
Air Filter Primary.....	A-5542	Air Filter Set.....	A-5542-S	933 (LOADERS) S/N: 16G1-UP	
Air Filter Set.....	A-5542-S	Air Filter Primary.....	A-5542	Air Filter Set.....	A-5542-S
Air Filter Secondary.....	A-5525	Air Filter Secondary.....	A-5525	Air Filter Secondary.....	A-5525
Fuel Filter.....	FC-5503	Fuel Filter Secondary.....	FC-5507	Air Filter Primary.....	A-5542
Hydraulic Oil Filter.....	H-55270	Fuel Filter.....	FC-5503	Hydraulic Oil Filter.....	H-5504
Hydraulic Oil Filter.....	H-5504	Hydraulic Oil Filter.....	H-55270	Hydraulic Oil Filter.....	H-55270
Oil Filter Full Flow.....	C-5519	Oil Filter Full Flow.....	C-5519	Oil Filter Full Flow.....	C-5504
931B (LOADERS) S/N: 26Y1-UP		931C (LOADERS) S/N: 5LG1-UP		933 (LOADERS) S/N: 2311-UP	
Air Filter Secondary.....	A-5525	Air Filter Secondary.....	A-5525	Air Filter Secondary.....	A-5525
Air Filter Primary.....	A-5542	Air Filter Primary.....	A-5542	Air Filter Primary.....	A-5542
Air Filter Set.....	A-5542-S	Air Filter Set.....	A-5542-S	Air Filter Set.....	A-5542-S
Fuel Filter.....	FC-5503	Fuel Filter Secondary.....	FC-5507	Hydraulic Oil Filter.....	H-5504
Hydraulic Oil Filter.....	H-5504	Fuel Filter.....	FC-5503	Hydraulic Oil Filter.....	H-55270
Hydraulic Oil Filter.....	H-55270	Hydraulic Oil Filter.....	H-55270	Oil Filter Full Flow.....	C-5504
Oil Filter Full Flow.....	C-5519	Oil Filter Full Flow.....	C-5519		
				933 (LOADERS) S/N: 59D1-UP	
931B (LOADERS) S/N: 29Y1-UP		931C (LOADERS) S/N: 6RF1-UP		Air Filter Primary.....	A-5542
Air Filter Set.....	A-5542-S	Air Filter Set.....	A-5542-S	Air Filter Secondary.....	A-5525
Air Filter Primary.....	A-5542	Air Filter Secondary.....	A-5525	Air Filter Set.....	A-5542-S
Air Filter Secondary.....	A-5525	Fuel Filter.....	FC-5503	Hydraulic Oil Filter.....	H-5504
				Hydraulic Oil Filter.....	H-55270
				Oil Filter Full Flow.....	C-5504

MODEL/APPLICATION	SAKURA NO	MODEL/APPLICATION	SAKURA NO	MODEL/APPLICATION	SAKURA NO
CATERPILLAR		CATERPILLAR		CATERPILLAR	
933 (LOADERS) S/N: 8FL1-392 Air Filter Primary..... A-5542 Air Filter Set..... A-5542-S Air Filter Secondary..... A-5525 Cabin Air Filter..... CA-55070 Hydraulic Oil Filter..... H-5504 Hydraulic Oil Filter..... H-5501		Hydraulic Oil Filter..... HC-5504 Oil Filter Full Flow..... C-5504 933C (LOADERS) CAT 3046 (S/N: 5JS1-UP) Air Filter Secondary..... A-5525 Air Filter Primary..... A-5542 Air Filter Set..... A-5542-S Hydraulic Oil Filter..... HC-5504 Oil Filter Full Flow..... C-5504		935C (LOADERS) S/N: 5DJ1-UP Air Filter Set..... A-5542-S Air Filter Primary..... A-5542 Air Filter Secondary..... A-5525 Fuel Filter..... FC-5503 Hydraulic Oil Filter..... H-5504 Oil Filter Full Flow..... C-5519	
933 (LOADERS) S/N: 8FL1-UP Air Filter Primary..... A-5542 Air Filter Secondary..... A-5525 Air Filter Set..... A-5542-S Hydraulic Oil Filter..... H-5504 Hydraulic Oil Filter..... H-55270 Oil Filter Full Flow..... C-5504		933C (LOADERS) CAT S/N: 4MS1-UP Air Filter Secondary..... A-5525 Air Filter Set..... A-5542-S Air Filter Primary..... A-5542 Cabin Air Filter..... CA-55070 Fuel Filter Secondary..... FC-5515 Fuel Filter..... FC-1010 Fuel Filter..... FC-5516 Fuel Filter Secondary..... FC-55151 Hydraulic Oil Filter..... HC-5504 Oil Filter Full Flow..... C-5504		935C (LOADERS) S/N: 8CF1-UP Air Filter Primary..... A-5542 Air Filter Secondary..... A-5525 Air Filter Set..... A-5542-S Fuel Filter Secondary..... FC-5507 Hydraulic Oil Filter..... H-5504 Oil Filter Full Flow..... C-5519	
933 (LOADERS) S/N: 8FL393-UP Air Filter Primary..... A-5542 Air Filter Set..... A-5542-S Air Filter Secondary..... A-5525 Cabin Air Filter..... CA-55070 Hydraulic Oil Filter..... H-5501 Hydraulic Oil Filter..... H-5504		933C (LOADERS) CAT S/N: 5JS1-UP Air Filter Primary..... A-5542 Air Filter Secondary..... A-5525 Air Filter Set..... A-5542-S Cabin Air Filter..... CA-55070 Fuel Filter Secondary..... FC-5515 Fuel Filter..... FC-1010 Fuel Filter..... FC-5516 Fuel Filter Secondary..... FC-55151 Hydraulic Oil Filter..... HC-5504 Oil Filter Full Flow..... C-5504		935C (LOADERS) w/3204 Eng. Air Filter Secondary..... A-5590 Hydraulic Oil Filter..... H-55320	
933 (LOADERS) S/N: 9EL109-UP Air Filter Primary..... A-5542 Air Filter Set..... A-5542-S Air Filter Secondary..... A-5525 Cabin Air Filter..... CA-55070 Hydraulic Oil Filter..... H-5501 Hydraulic Oil Filter..... H-5504		933C (LOADERS) CAT S/N: 5XK1-UP Air Filter Primary..... A-5542 Air Filter Secondary..... A-5525 Air Filter Set..... A-5542-S Cabin Air Filter..... CA-55070 Fuel Filter Secondary..... FC-5515 Fuel Filter..... FC-1010 Fuel Filter..... FC-5516 Fuel Filter Secondary..... FC-55151 Hydraulic Oil Filter..... HC-5504 Oil Filter Full Flow..... C-5504		935CII (LOADERS) CAT (S/N: 45V90750-UP) Fuel Filter..... FC-5523 Fuel Filter..... FC-5501 Oil Filter Full Flow..... C-5519	
933 (LOADERS) S/N: 9EL1-108 Air Filter Primary..... A-5542 Air Filter Set..... A-5542-S Air Filter Secondary..... A-5525 Cabin Air Filter..... CA-55070 Hydraulic Oil Filter..... H-5501 Hydraulic Oil Filter..... H-5504		933C (LOADERS) CAT S/N: 5XK1-UP Air Filter Set..... A-5542-S Air Filter Secondary..... A-5525 Air Filter Primary..... A-5542 Cabin Air Filter..... CA-55070 Fuel Filter..... FC-1010 Fuel Filter Secondary..... FC-5515 Fuel Filter Secondary..... FC-55151 Hydraulic Oil Filter..... HC-5504 Oil Filter Full Flow..... C-5504		935CII (LOADERS) CAT (S/N: 7YJ1-2721-UP) Fuel Filter..... FC-5501 Fuel Filter Secondary..... FC-5507 Fuel Filter..... FC-5523 Oil Filter Full Flow..... C-5505 Oil Filter Full Flow..... C-5519	
933 (LOADERS) S/N: 9EL1-UP Air Filter Secondary..... A-5525 Air Filter Set..... A-5542-S Air Filter Primary..... A-5542 Hydraulic Oil Filter..... H-5504 Hydraulic Oil Filter..... H-55270 Oil Filter Full Flow..... C-5504		933C (LOADERS) CAT S/N: 5XK1-UP Air Filter Set..... A-5542-S Air Filter Secondary..... A-5525 Air Filter Primary..... A-5542 Cabin Air Filter..... CA-55070 Fuel Filter..... FC-1010 Fuel Filter Secondary..... FC-5515 Fuel Filter Secondary..... FC-55151 Hydraulic Oil Filter..... HC-5504 Oil Filter Full Flow..... C-5504		935CII (LOADERS) S/N: 5DJ1-UP Air Filter Secondary..... A-5525 Air Filter Set..... A-5542-S Air Filter Primary..... A-5542 Hydraulic Oil Filter..... H-5504 Hydraulic Oil Filter..... H-5501	
933 (LOADERS) w/3046 Eng. Air Filter Secondary..... A-5590 Hydraulic Oil Filter..... H-55320		935B (LOADERS) S/N: 3DF1-UP Air Filter Primary..... A-5542 Air Filter Set..... A-5542-S Air Filter Secondary..... A-5525 Fuel Filter..... FC-5503 Hydraulic Oil Filter..... H-55270 Hydraulic Oil Filter..... H-5504 Oil Filter Full Flow..... C-5519		935CII (LOADERS) CAT (S/N: 12Z1-UP) Air Filter Set..... A-5522-S Air Filter Primary..... A-5509 Air Filter Secondary..... A-5522 Fuel Filter Secondary..... FC-5507 Oil Filter Full Flow..... C-5522	
933C (LOADERS) CAT 3046 (S/N: 4MS1-UP) Air Filter Primary..... A-5542 Air Filter Set..... A-5542-S Air Filter Secondary..... A-5525		935B (LOADERS) w/3204 Eng. Air Filter Secondary..... A-5590 Hydraulic Oil Filter..... H-55320		936 (LOADERS) S/N: 33Z1-3090 Air Filter Set..... A-5522-S Air Filter Secondary..... A-5522	

MODEL/APPLICATION	SAKURA NO
CATERPILLAR	
938F (LOADERS) CAT S/N: 4TF14130-28599	
Fuel Filter.....	FC-5516
Fuel Filter Secondary.....	FC-55151
Oil Filter Full Flow.....	C-5522
938F (LOADERS) CAT S/N: 4TF32198-UP	
Fuel Filter Secondary.....	FC-5515
Fuel Filter.....	FC-5508
Fuel Filter.....	FC-5516
Fuel Filter Secondary.....	FC-55151
Oil Filter Full Flow.....	C-5522
938F (LOADERS) CAT S/N: 98Z17000-UP	
Fuel Filter Secondary.....	FC-5515
Fuel Filter.....	FC-5516
Fuel Filter Secondary.....	FC-55151
Fuel Filter.....	FC-5508
Oil Filter Full Flow.....	C-5522
938F (LOADERS) CAT S/N: 98Z5104-16999	
Fuel Filter Secondary.....	FC-55151
Fuel Filter.....	FC-5516
Fuel Filter Secondary.....	FC-5515
Oil Filter Full Flow.....	C-5522
938F (LOADERS) S/N: 1KM1-1799	
Air Filter Set.....	A-5549M-S
Air Filter Primary.....	A-5549M
Air Filter Primary.....	A-5549
Air Filter Secondary.....	A-5550
Cabin Air Filter.....	CA-55070
Hydraulic Oil Filter.....	HC-5504
Hydraulic Oil Filter.....	H-5506
938F (LOADERS) S/N: 1KM1800-UP	
Air Filter Primary.....	A-5549M
Air Filter Set.....	A-5549M-S
Air Filter Primary.....	A-5549
Air Filter Secondary.....	A-5550
Cabin Air Filter.....	CA-55070
Hydraulic Oil Filter.....	HC-5504
Hydraulic Oil Filter.....	H-5506
938F (LOADERS) S/N: 1KM1-UP	
Air Filter Set.....	A-5549M-S
Air Filter Primary.....	A-5549
Air Filter Primary.....	A-5549M
Air Filter Secondary.....	A-5550
Fuel Filter Secondary.....	FC-5515
Fuel Filter.....	FC-5508
Fuel Filter Secondary.....	FC-55151
Fuel Filter.....	FC-5516
Fuel Filter.....	F-5505
Hydraulic Oil Filter.....	HC-5504
Hydraulic Oil Filter.....	H-5506
Oil Filter Full Flow.....	C-5510

MODEL/APPLICATION	SAKURA NO
CATERPILLAR	
938F (LOADERS) S/N: 2RM1-1123	
Air Filter Set.....	A-5549M-S
Air Filter Secondary.....	A-5550
Air Filter Primary.....	A-5549
Air Filter Primary.....	A-5549M
Cabin Air Filter.....	CA-55070
Hydraulic Oil Filter.....	HC-5508
Hydraulic Oil Filter.....	HC-5504
Hydraulic Oil Filter.....	H-5506
938F (LOADERS) S/N: 2RM1124-UP	
Air Filter Primary.....	A-5549
Air Filter Primary.....	A-5549M
Air Filter Secondary.....	A-5550
Air Filter Set.....	A-5549M-S
Cabin Air Filter.....	CA-55070
Hydraulic Oil Filter.....	H-5506
Hydraulic Oil Filter.....	HC-5504
Hydraulic Oil Filter.....	HC-5508
938F (LOADERS) S/N: 2RM-1291	
Air Filter Secondary.....	A-5550
Air Filter Set.....	A-5549M-S
Air Filter Primary.....	A-5549
Air Filter Primary.....	A-5549M
Fuel Filter.....	FC-5516
Fuel Filter Secondary.....	FC-55151
Fuel Filter.....	FC-5508
Fuel Filter Secondary.....	FC-5515
Hydraulic Oil Filter.....	HC-5504
Hydraulic Oil Filter.....	H-5506
Oil Filter Full Flow.....	C-5510
938F (LOADERS) S/N: 2RM1-UP	
Fuel Filter.....	F-5505
Oil Filter Full Flow.....	C-5510
938F (LOADERS) S/N: 75N1-310	
Air Filter Set.....	A-5549M-S
Air Filter Primary.....	A-5549M
Air Filter Secondary.....	A-5550
Air Filter Primary.....	A-5549
Cabin Air Filter.....	CA-55070
Hydraulic Oil Filter.....	H-5506
Hydraulic Oil Filter.....	HC-5508
938F (LOADERS) S/N: 75N1-UP	
Fuel Filter.....	F-5505
Hydraulic Oil Filter.....	H-5506
Oil Filter Full Flow.....	C-5510
938F (LOADERS) S/N: 75N311-384	
Air Filter Secondary.....	A-5550
Air Filter Primary.....	A-5549M
Air Filter Primary.....	A-5549
Air Filter Set.....	A-5549M-S
Cabin Air Filter.....	CA-55070

MODEL/APPLICATION	SAKURA NO
CATERPILLAR	
Hydraulic Oil Filter.....	HC-5504
Hydraulic Oil Filter.....	H-5506
938F (LOADERS) S/N: 75N385-UP	
Air Filter Secondary.....	A-5550
Air Filter Set.....	A-5549M-S
Air Filter Primary.....	A-5549M
Air Filter Primary.....	A-5549
Cabin Air Filter.....	CA-55070
Hydraulic Oil Filter.....	HC-5504
Hydraulic Oil Filter.....	H-5506
938F (LOADERS) S/N: 85M1-UP	
Air Filter Primary.....	A-5549M
Air Filter Set.....	A-5549M-S
Air Filter Primary.....	A-5549
Air Filter Secondary.....	A-5550
Fuel Filter Secondary.....	FC-5515
Fuel Filter Secondary.....	FC-55151
Fuel Filter.....	FC-5516
Fuel Filter.....	F-5505
Hydraulic Oil Filter.....	HC-5504
Hydraulic Oil Filter.....	H-5506
Oil Filter Full Flow.....	C-5510
938G (LOADERS) CAT 3126	
Cabin Air Filter.....	CA-55130
938G (LOADERS) CAT (S/N: 55K1-UP)	
Fuel Filter.....	FC-5508
Fuel Filter Secondary.....	FC-5515
Fuel Filter Secondary.....	FC-55151
Fuel Filter.....	FC-5516
Oil Filter Full Flow.....	C-5522
938G (LOADERS) CAT (S/N: 6J1-UP)	
Fuel Filter.....	FC-5516
Fuel Filter.....	FC-5508
Fuel Filter Secondary.....	FC-55151
Fuel Filter Secondary.....	FC-5515
Oil Filter Full Flow.....	C-5522
938G (LOADERS) CAT 3126B ATAAC HEUI (S/N: 4YS1-UP)	
Air Filter Secondary.....	A-5550
Fuel Filter.....	FC-5508
Fuel Filter Secondary.....	FC-55151
Fuel Filter.....	FC-5516
Fuel Filter Secondary.....	FC-5515
Hydraulic Oil Filter.....	HC-5504
Hydraulic Oil Filter.....	H-5506
Oil Filter Full Flow.....	C-5510
938G (LOADERS) CAT 3126B ATAAC HEUI (S/N: 6WS1-682)	
Air Filter Secondary.....	A-5550
Fuel Filter.....	FC-5508
Fuel Filter Secondary.....	FC-55151
Fuel Filter.....	FC-5516
Fuel Filter Secondary.....	FC-5515

MODEL/APPLICATION	SAKURA NO
CATERPILLAR	
938G (LOADERS) CAT 3126B ATAAC HEUI (S/N: 6WS1-682)	
Hydraulic Oil Filter.....	HC-5504
Hydraulic Oil Filter.....	H-5506
Oil Filter Full Flow.....	C-5510
938G (LOADERS) CAT 3126B ATAAC HEUI (S/N: 6WS683-UP)	
Air Filter Secondary.....	A-5550
Fuel Filter.....	FC-5508
Fuel Filter.....	FC-5516
Fuel Filter Secondary.....	FC-5515
Fuel Filter Secondary.....	FC-55151
Hydraulic Oil Filter.....	H-5506
Hydraulic Oil Filter.....	HC-5504
Oil Filter Full Flow.....	C-5510
938G (LOADERS) CAT 3126B ATAAC HEUI (S/N: 8RS1-610)	
Air Filter Secondary.....	A-5550
Fuel Filter.....	FC-5508
Fuel Filter.....	FC-5516
Fuel Filter Secondary.....	FC-5515
Fuel Filter Secondary.....	FC-55151
Hydraulic Oil Filter.....	H-5506
Hydraulic Oil Filter.....	HC-5504
Oil Filter Full Flow.....	C-5510
938G (LOADERS) CAT 3126B ATAAC HEUI (S/N: 8RS611-UP)	
Air Filter Secondary.....	A-5550
Fuel Filter.....	FC-5508
Fuel Filter.....	FC-5516
Fuel Filter Secondary.....	FC-55151
Fuel Filter Secondary.....	FC-5515
Hydraulic Oil Filter.....	H-5506
Hydraulic Oil Filter.....	HC-5504
Oil Filter Full Flow.....	C-5510
938G (LOADERS) CAT 3126B ATAAC HEUI (S/N: 9HS1-UP)	
Air Filter Secondary.....	A-5550
Fuel Filter.....	FC-5516
Fuel Filter Secondary.....	FC-55151
Fuel Filter.....	FC-5508
Fuel Filter Secondary.....	FC-5515
Hydraulic Oil Filter.....	H-5506
Hydraulic Oil Filter.....	HC-5504
Oil Filter Full Flow.....	C-5510
938G (LOADERS) S/N: 4YS1-511	
Air Filter Secondary.....	A-5550
Air Filter Set.....	A-5549M-S
Air Filter Primary.....	A-5549
Air Filter Primary.....	A-5549M
Hydraulic Oil Filter.....	HC-5504
Hydraulic Oil Filter.....	H-5506
938G (LOADERS) S/N: 4YS512-UP	
Air Filter Secondary.....	A-5550
Air Filter Primary.....	A-5549
Air Filter Primary.....	A-5549M

MODEL/APPLICATION	SAKURA NO
CATERPILLAR	
Air Filter Set.....	A-5549M-S
Hydraulic Oil Filter.....	H-5506
Hydraulic Oil Filter.....	HC-5504
938G (LOADERS) S/N: 9HS1-280	
Air Filter Secondary.....	A-5550
Hydraulic Oil Filter.....	H-5506
Hydraulic Oil Filter.....	HC-5504
938G (LOADERS) S/N: 9HS281-743	
Air Filter Secondary.....	A-5550
Hydraulic Oil Filter.....	HC-5504
Hydraulic Oil Filter.....	H-5506
938G (LOADERS) S/N: 9HS744-UP	
Air Filter Secondary.....	A-5550
Hydraulic Oil Filter.....	H-5506
Hydraulic Oil Filter.....	HC-5504
938G II (LOADERS) CAT 3126B ATAAC HEUI	
Cabin Air Filter.....	CA-55130
938H (LOADERS) CAT C6.6 ACERT-Konzept , 2008	
Cabin Air Filter.....	CA-55130
938H (LOADERS) w/C6.6 Eng.	
Hydraulic Oil Filter.....	HC-55280
938G SERIES II (LOADERS) CAT (S/N: 5GG1-UP)	
Fuel Filter.....	FC-5517
Oil Filter Full Flow.....	C-5522
938G SERIES II (LOADERS) CAT (S/N: BMA1-UP)	
Fuel Filter.....	FC-5517
Oil Filter Full Flow.....	C-5522
938G SERIES II (LOADERS) S/N: CRD1-UP	
Air Filter Secondary.....	A-5559
Air Filter Primary.....	A-5558
Hydraulic Oil Filter.....	H-5506
Hydraulic Oil Filter.....	HC-5504
938G SERIES II (LOADERS) S/N: PHN1-UP	
Air Filter Primary.....	A-5558
Air Filter Secondary.....	A-5559
Hydraulic Oil Filter.....	H-5506
Hydraulic Oil Filter.....	HC-5504
938G SERIES II (LOADERS) S/N: RTB1-UP	
Air Filter Primary.....	A-5558
Air Filter Secondary.....	A-5559
Hydraulic Oil Filter.....	HC-5504
Hydraulic Oil Filter.....	H-5506
938M (LOADERS) CAT C7.1	
Fuel Filter.....	EF-55050

MODEL/APPLICATION	SAKURA NO
CATERPILLAR	
939 (LOADERS) CAT S/N: 5XK1-UP	
Air Filter Primary.....	A-5542
Air Filter Secondary.....	A-5525
Air Filter Set.....	A-5542-S
Cabin Air Filter.....	CA-55070
Fuel Filter Secondary.....	FC-5515
Fuel Filter.....	FC-1010
Fuel Filter.....	FC-5516
Fuel Filter Secondary.....	FC-55151
Hydraulic Oil Filter.....	H-5504
Hydraulic Oil Filter.....	H-5501
Oil Filter Full Flow.....	C-5504
939 (LOADERS) CAT S/N: 9GL1-UP	
Air Filter Primary.....	A-5542
Air Filter Set.....	A-5542-S
Air Filter Secondary.....	A-5525
Cabin Air Filter.....	CA-55070
Fuel Filter Secondary.....	FC-5515
Fuel Filter.....	FC-1010
Fuel Filter Secondary.....	FC-55151
Fuel Filter.....	FC-5516
Hydraulic Oil Filter.....	H-5504
Hydraulic Oil Filter.....	H-5501
Oil Filter Full Flow.....	C-5504
939 (LOADERS) CAT S/N: 9GL1-UP	
Air Filter Secondary.....	A-5525
Air Filter Primary.....	A-5542
Air Filter Set.....	A-5542-S
Hydraulic Oil Filter.....	H-5502
Oil Filter Full Flow.....	C-5510
939 (LOADERS) S/N: 9GL1-UP	
Air Filter Secondary.....	A-5525
Air Filter Set.....	A-5542-S
Air Filter Primary.....	A-5542
Hydraulic Oil Filter.....	H-55270
Hydraulic Oil Filter.....	H-5504
Oil Filter Full Flow.....	C-5504
939 (LOADERS) w/3046 Eng.	
Air Filter Secondary.....	A-5590
Hydraulic Oil Filter.....	H-55320
939C (LOADERS) CAT 3046T (S/N: 6DS1-UP)	
Air Filter Secondary.....	A-5525
Air Filter Primary.....	A-5542
Air Filter Set.....	A-5542-S
Hydraulic Oil Filter.....	HC-5504
Oil Filter Full Flow.....	C-5504
939C (LOADERS) CAT S/N: 5XK12250-UP	
Air Filter Primary.....	A-5542
Air Filter Set.....	A-5542-S
Air Filter Secondary.....	A-5525
Cabin Air Filter.....	CA-55070

MODEL/APPLICATION	SAKURA NO	MODEL/APPLICATION	SAKURA NO	MODEL/APPLICATION	SAKURA NO
CATERPILLAR		CATERPILLAR		CATERPILLAR	
939C (LOADERS) CAT S/N: 5XK12250-UP Fuel Filter..... FC-1010 Hydraulic Oil Filter..... HC-5504 Oil Filter Full Flow..... C-5504		Fuel Filter Secondary..... FC-5507 Hydraulic Oil Filter..... H-5502 Hydraulic Oil Filter..... H-5504 Oil Filter Full Flow..... O-5502		Air Filter Set..... A-5507-S Air Filter Secondary..... A-5508 Air Filter Set..... A-55071-S Fuel Filter..... FC-5510 Hydraulic Oil Filter..... H-55270 Hydraulic Oil Filter..... H-5504 Oil Filter Full Flow..... O-5501	
939C (LOADERS) CAT S/N: 6DS1-UP Air Filter Primary..... A-5542 Air Filter Set..... A-5542-S Air Filter Secondary..... A-5525 Cabin Air Filter..... CA-55070 Fuel Filter..... FC-1010 Hydraulic Oil Filter..... HC-5504 Oil Filter Full Flow..... C-5504		941B (LOADERS) Except S/N 75H Hydraulic Oil Filter..... H-55320		943 (LOADERS) S/N: 03Y1-1385 Air Filter..... A-5530 Air Filter Primary..... A-5507 Air Filter Set..... A-55071-S Air Filter Set..... A-5507-S Fuel Filter..... F-5505 Fuel Filter Secondary..... FC-5507 Hydraulic Oil Filter..... H-5506 Oil Filter Full Flow..... C-5505	
939C (LOADERS) w/3046T Eng. Air Filter Secondary..... A-5590		941B (LOADERS) S/N: 80H3040-3084 Air Filter Primary..... A-5566 Air Filter Primary..... A-5507 Air Filter Set..... A-5507-S Air Filter Secondary..... A-5567 Air Filter Secondary..... A-5508 Air Filter Set..... A-55071-S Air Filter Set..... A-5568-S Fuel Filter Secondary..... FC-5507 Hydraulic Oil Filter..... H-5502 Hydraulic Oil Filter..... H-5504 Oil Filter Full Flow..... O-5502		943 (LOADERS) S/N: 03Y1-1386-UP Air Filter Primary..... A-5507 Air Filter Set..... A-55071-S Air Filter Set..... A-5507-S Air Filter..... A-5530 Fuel Filter..... F-5505 Fuel Filter Secondary..... FC-5507 Hydraulic Oil Filter..... H-5506 Oil Filter Full Flow..... C-5505	
941 (LOADERS) Except S/N 75H Hydraulic Oil Filter..... H-55320		941B (LOADERS) S/N: 80H3085-UP Air Filter Primary..... A-5507 Air Filter Set..... A-55071-S Air Filter Set..... A-5568-S Air Filter Secondary..... A-5508 Air Filter Primary..... A-5566 Air Filter Secondary..... A-5567 Air Filter Set..... A-5507-S Fuel Filter Secondary..... FC-5507 Hydraulic Oil Filter..... H-5504 Hydraulic Oil Filter..... H-5502 Oil Filter Full Flow..... C-5510		943 (LOADERS) S/N: 19Z1-1378 Air Filter..... A-5530 Air Filter Primary..... A-5566 Air Filter Secondary..... A-5567 Air Filter Set..... A-55071-S Air Filter Primary..... A-5507 Air Filter Set..... A-5568-S Air Filter Set..... A-5507-S Fuel Filter Secondary..... FC-5507 Hydraulic Oil Filter..... H-55280 Hydraulic Oil Filter..... H-5506 Oil Filter Full Flow..... C-5505	
941 (LOADERS) S/N: 16U1-UP Air Filter Secondary..... A-5508 Fuel Filter Secondary..... FC-5507 Hydraulic Oil Filter..... H-5504 Hydraulic Oil Filter..... H-5502 Oil Filter Full Flow..... C-5510 Oil Filter Full Flow..... O-5502		941B (LOADERS) S/N: 80H3087-80H3087 Air Filter Primary..... A-5566 Air Filter Primary..... A-5507 Air Filter Secondary..... A-5567 Air Filter Set..... A-55071-S Air Filter Set..... A-5507-S Air Filter Set..... A-5568-S Air Filter Secondary..... A-5508 Fuel Filter Secondary..... FC-5507 Hydraulic Oil Filter..... H-5504 Hydraulic Oil Filter..... H-5502 Oil Filter Full Flow..... C-5510		943 (LOADERS) S/N: 19Z1379-UP Air Filter Set..... A-5507-S Air Filter Secondary..... A-5567 Air Filter Primary..... A-5507 Air Filter Set..... A-5568-S Air Filter Primary..... A-5566 Air Filter Set..... A-55071-S Air Filter..... A-5530 Fuel Filter Secondary..... FC-5507 Hydraulic Oil Filter..... H-5506 Hydraulic Oil Filter..... H-55270 Oil Filter Full Flow..... C-5505	
941 (LOADERS) S/N: 80H1-3039 Air Filter Set..... A-5568-S Air Filter Primary..... A-5566 Air Filter Secondary..... A-5567 Air Filter Set..... A-5507-S Air Filter Primary..... A-5507 Air Filter Set..... A-55071-S Air Filter Secondary..... A-5508 Fuel Filter Secondary..... FC-5507 Hydraulic Oil Filter..... H-5502 Hydraulic Oil Filter..... H-5504 Oil Filter Full Flow..... O-5502		941B (LOADERS) S/N: 80H3884-UP Air Filter Set..... A-5507-S Air Filter Primary..... A-5507 Air Filter Set..... A-55071-S Air Filter Secondary..... A-5508 Hydraulic Oil Filter..... H-5502 Hydraulic Oil Filter..... H-5504 Oil Filter Full Flow..... C-5510		943 (LOADERS) S/N: 31Y1-UP Air Filter Secondary..... A-5567 Air Filter Set..... A-5568-S Air Filter Secondary..... A-5525 Air Filter Primary..... A-5542	
941 (LOADERS) S/N: 80H3087-UP Air Filter Secondary..... A-5567 Air Filter Set..... A-55071-S Air Filter Primary..... A-5566 Air Filter Primary..... A-5507 Air Filter Set..... A-5507-S Air Filter Set..... A-5568-S Air Filter Secondary..... A-5508		941B (LOADERS) S/N: 80H5702-80H5702 Air Filter Primary..... A-5507			

Sakura Filter

ENGINE APPLICATION

MODEL/APPLICATION	SAKURA NO	MODEL/APPLICATION	SAKURA NO	MODEL/APPLICATION	SAKURA NO
CATERPILLAR		CATERPILLAR		CATERPILLAR	
943 (LOADERS) S/N: 31Y1-UP Air Filter Set..... A-5542-S Air Filter Primary..... A-5566 Fuel Filter..... FC-5503 Oil Filter Full Flow..... C-5505		Air Filter Secondary..... A-5567 Air Filter Set..... A-5568-S Air Filter Set..... A-55071-S Air Filter Secondary..... A-5508 Fuel Filter..... F-5501 Hydraulic Oil Filter..... H-5503 Oil Filter Full Flow..... O-5502		950 (LOADERS) S/N: 81J1-4272 Air Filter Set..... A-55071-S Air Filter Set..... A-5507-S Air Filter Secondary..... A-5508 Air Filter Primary..... A-5507 Hydraulic Oil Filter..... H-5504 Hydraulic Oil Filter..... H-5503 Oil Filter Full Flow..... O-5502	
943 (LOADERS) S/N: 4Z1-UP Air Filter Set..... A-5568-S Air Filter Set..... A-5507-S Air Filter Primary..... A-5507 Air Filter Set..... A-55071-S Air Filter Secondary..... A-5567 Air Filter..... A-5530 Air Filter Primary..... A-5566 Fuel Filter Secondary..... FC-5507 Hydraulic Oil Filter..... H-5506 Hydraulic Oil Filter..... H-5503 Oil Filter Full Flow..... C-5505		944A (LOADERS) S/N: 58A1-UP Air Filter Set..... A-5568-S Air Filter Primary..... A-5507 Air Filter Set..... A-5507-S Air Filter Secondary..... A-5567 Air Filter Secondary..... A-5508 Air Filter Set..... A-55071-S Air Filter Primary..... A-5566 Fuel Filter Secondary..... FC-5507 Hydraulic Oil Filter..... H-5503 Oil Filter Full Flow..... O-5502		950 (LOADERS) S/N: 81J4273-5410 Air Filter Set..... A-55071-S Air Filter Set..... A-5507-S Air Filter Set..... A-5568-S Air Filter Primary..... A-5566 Air Filter Secondary..... A-5508 Air Filter Primary..... A-5507 Air Filter Secondary..... A-5567 Fuel Filter Secondary..... FC-5507 Hydraulic Oil Filter..... H-5504 Hydraulic Oil Filter..... H-5503 Oil Filter Full Flow..... C-5510	
943 LGP (LOADERS) S/N: 19Z1-252 Air Filter..... A-5530 Air Filter Set..... A-5507-S Air Filter Primary..... A-5507 Air Filter Set..... A-55071-S Fuel Filter..... F-5505 Fuel Filter Secondary..... FC-5507 Hydraulic Oil Filter..... H-5526 Hydraulic Oil Filter..... H-5506 Oil Filter Full Flow..... C-5505		94U (SKIDDERS) Fuel Filter..... F-5503		950 (LOADERS) S/N: 81J5411-UP Air Filter Secondary..... A-5567 Air Filter Secondary..... A-5508 Air Filter Primary..... A-5507 Air Filter Set..... A-55071-S Air Filter Set..... A-5568-S Air Filter Set..... A-5507-S Air Filter Primary..... A-5566 Fuel Filter Secondary..... FC-5507 Hydraulic Oil Filter..... H-5504 Hydraulic Oil Filter..... H-5503 Oil Filter Full Flow..... C-5510	
943 LGP (LOADERS) S/N: 19Z253-UP Air Filter Set..... A-5522-S Air Filter Secondary..... A-5522 Air Filter Primary..... A-5509 Fuel Filter..... F-5505 Fuel Filter Secondary..... FC-5507 Hydraulic Oil Filter..... H-5526 Hydraulic Oil Filter..... H-5506 Hydraulic Oil Filter..... H-55280 Hydraulic Oil Filter..... H-5503 Oil Filter Full Flow..... C-5505		950 (LOADERS) S/N: 31K1016-1200 Air Filter Primary..... A-5566 Air Filter Secondary..... A-5567 Air Filter Secondary..... A-5508 Air Filter Set..... A-5568-S Air Filter Set..... A-55071-S Air Filter Primary..... A-5507 Air Filter Set..... A-5507-S Fuel Filter Secondary..... FC-5507 Hydraulic Oil Filter..... H-5503 Hydraulic Oil Filter..... H-5504 Oil Filter Full Flow..... C-5510		950 (LOADERS) S/N: 90A1-UP Air Filter Primary..... A-5566 Air Filter Secondary..... A-5508 Air Filter Secondary..... A-5567 Air Filter Set..... A-5568-S Air Filter Primary..... A-5507 Air Filter Set..... A-5507-S Air Filter Set..... A-55071-S Fuel Filter..... F-5501 Hydraulic Oil Filter..... H-5503 Oil Filter Full Flow..... O-5502	
944 (LOADERS) S/N: 87J1-UP Air Filter Set..... A-5507-S Air Filter Primary..... A-5566 Air Filter Set..... A-55071-S Air Filter Primary..... A-5507 Air Filter Set..... A-5568-S Air Filter Secondary..... A-5567 Air Filter Secondary..... A-5508 Fuel Filter Secondary..... FC-5507 Hydraulic Oil Filter..... H-5503 Oil Filter Full Flow..... O-5502		950 (LOADERS) S/N: 31K1-1015 Air Filter Set..... A-55071-S Air Filter Set..... A-5507-S Air Filter Primary..... A-5507 Air Filter Secondary..... A-5508 Hydraulic Oil Filter..... H-5503 Hydraulic Oil Filter..... H-5504 Oil Filter Full Flow..... O-5502		950 (LOADERS) S/N: 90A1-UP Air Filter Primary..... A-5566 Air Filter Secondary..... A-5508 Air Filter Secondary..... A-5567 Air Filter Set..... A-5568-S Air Filter Primary..... A-5507 Air Filter Set..... A-5507-S Air Filter Set..... A-55071-S Fuel Filter..... F-5501 Hydraulic Oil Filter..... H-5503 Oil Filter Full Flow..... O-5502	
944A (LOADERS) S/N: 43A1-UP Air Filter Primary..... A-5566 Air Filter Primary..... A-5507 Air Filter Set..... A-5507-S		950 (LOADERS) S/N: 31K1201-UP Air Filter Set..... A-5507-S Air Filter Set..... A-5568-S Air Filter Primary..... A-5566 Air Filter Secondary..... A-5508 Air Filter Set..... A-55071-S Air Filter Secondary..... A-5567 Air Filter Primary..... A-5507 Fuel Filter Secondary..... FC-5507 Hydraulic Oil Filter..... H-5503 Hydraulic Oil Filter..... H-5504 Oil Filter Full Flow..... C-5510		950 (LOADERS) w/3304 Eng. Hydraulic Oil Filter..... H-55320	
				950F (LOADERS) CAT (S/N: 4TF1202-5321) Fuel Filter..... FC-5523 Fuel Filter..... FC-5501 Oil Filter Full Flow..... C-5522 Oil Filter Full Flow..... C-5510	
				950F (LOADERS) CAT (S/N: 4TF17863-24499)	

MODEL/APPLICATION	SAKURA NO
CATERPILLAR	
950F (LOADERS) CAT (S/N: 4TF17863-24499)	
Fuel Filter Secondary.....	FC-55151
Fuel Filter.....	FC-5516
Fuel Filter Secondary.....	FC-5515
Fuel Filter.....	FC-5523
Fuel Filter.....	FC-5501
Oil Filter Full Flow.....	C-5510
Oil Filter Full Flow.....	C-5522
950F (LOADERS) CAT (S/N: 4TF1-985)	
Fuel Filter.....	FC-5501
Fuel Filter.....	FC-5523
950F (LOADERS) CAT (S/N: 4TF24500-UP)	
Fuel Filter.....	FC-5523
Fuel Filter Secondary.....	FC-5515
Fuel Filter.....	FC-5508
Fuel Filter Secondary.....	FC-55151
Fuel Filter.....	FC-5516
Fuel Filter.....	FC-5501
Oil Filter Full Flow.....	C-5510
Oil Filter Full Flow.....	C-5522
950F (LOADERS) CAT (S/N: 4TF5322-9463)	
Fuel Filter.....	FC-5523
Fuel Filter.....	FC-5501
Oil Filter Full Flow.....	C-5510
Oil Filter Full Flow.....	C-5522
950F (LOADERS) CAT (S/N: 4TF9464-17862)	
Fuel Filter.....	FC-5501
Fuel Filter.....	FC-5516
Fuel Filter.....	FC-5523
Fuel Filter Secondary.....	FC-5515
Fuel Filter Secondary.....	FC-55151
Oil Filter Full Flow.....	C-5510
Oil Filter Full Flow.....	C-5522
950F (LOADERS) CAT (S/N: 98Z1-2349)	
Fuel Filter.....	FC-5501
Fuel Filter.....	FC-5523
Oil Filter Full Flow.....	C-5522
950F (LOADERS) CAT (S/N: 98Z14398-UP)	
Fuel Filter.....	FC-5523
Fuel Filter Secondary.....	FC-5515
Fuel Filter Secondary.....	FC-55151
Fuel Filter.....	FC-5508
Fuel Filter.....	FC-5501
Fuel Filter.....	FC-5516
Oil Filter Full Flow.....	C-5522
950F (LOADERS) CAT (S/N: 98Z2350-8479)	
Fuel Filter Secondary.....	FC-5515
Fuel Filter.....	FC-5523
Fuel Filter.....	FC-5501
Fuel Filter Secondary.....	FC-55151

MODEL/APPLICATION	SAKURA NO
CATERPILLAR	
Fuel Filter.....	FC-5516
Oil Filter Full Flow.....	C-5522
950F (LOADERS) CAT (S/N: 98Z8480-14397)	
Fuel Filter.....	FC-5508
Fuel Filter.....	FC-5516
Fuel Filter.....	FC-5501
Fuel Filter Secondary.....	FC-5515
Fuel Filter.....	FC-5523
Fuel Filter Secondary.....	FC-55151
Oil Filter Full Flow.....	C-5522
950F (LOADERS) CAT S/N: 4TF1172-1172	
Fuel Filter.....	FC-5501
Fuel Filter.....	FC-5523
Oil Filter Full Flow.....	C-5522
Oil Filter Full Flow.....	C-5510
950F (LOADERS) CAT S/N: 4TF1173-1178	
Fuel Filter.....	FC-5523
Fuel Filter.....	FC-5501
Oil Filter Full Flow.....	C-5510
Oil Filter Full Flow.....	C-5522
950F (LOADERS) CAT S/N: 4TF1179-1179	
Fuel Filter.....	FC-5523
Fuel Filter.....	FC-5501
Oil Filter Full Flow.....	C-5510
Oil Filter Full Flow.....	C-5522
950F (LOADERS) CAT S/N: 4TF1180-1198	
Fuel Filter.....	FC-5523
Fuel Filter.....	FC-5501
Oil Filter Full Flow.....	C-5510
Oil Filter Full Flow.....	C-5522
950F (LOADERS) CAT S/N: 4TF1199-1199	
Fuel Filter.....	FC-5523
Fuel Filter.....	FC-5501
Oil Filter Full Flow.....	C-5522
Oil Filter Full Flow.....	C-5510
950F (LOADERS) CAT S/N: 4TF1200-1201	
Fuel Filter.....	FC-5523
Fuel Filter.....	FC-5501
Oil Filter Full Flow.....	C-5522
Oil Filter Full Flow.....	C-5510
950F (LOADERS) CAT S/N: 4TF986-1171	
Fuel Filter.....	FC-5523
Fuel Filter.....	FC-5501
Oil Filter Full Flow.....	C-5510
Oil Filter Full Flow.....	C-5522
950F (LOADERS)	
Air Filter Secondary.....	A-5550
Air Filter Primary.....	A-5549

MODEL/APPLICATION	SAKURA NO
CATERPILLAR	
Air Filter Set.....	A-5549M-S
Air Filter Primary.....	A-5549M
Oil Filter Full Flow.....	C-5510
950F (LOADERS) S/N: 4DJ1-1999	
Air Filter Secondary.....	A-5522
Air Filter Primary.....	A-5509
Air Filter Set.....	A-5522-S
Fuel Filter Secondary.....	FC-5507
Fuel Filter.....	F-5505
Hydraulic Oil Filter.....	H-5506
Oil Filter Full Flow.....	C-5510
950F (LOADERS) S/N: 4DJ-UP	
Air Filter Set.....	A-5549M-S
Air Filter Primary.....	A-5549M
Air Filter Secondary.....	A-5550
Air Filter Primary.....	A-5549
Fuel Filter.....	F-5505
Fuel Filter Secondary.....	FC-5515
Fuel Filter.....	FC-5516
Fuel Filter Secondary.....	FC-55151
Fuel Filter Secondary.....	FC-5507
Hydraulic Oil Filter.....	H-5501
Hydraulic Oil Filter.....	H-5506
950F (LOADERS) S/N: 5SK1-976	
Air Filter Set.....	A-5568-S
Air Filter Primary.....	A-5566
Air Filter Secondary.....	A-5567
Fuel Filter Secondary.....	FC-5507
Hydraulic Oil Filter.....	H-5506
Oil Filter Full Flow.....	C-5510
950F (LOADERS) S/N: 5SK2334-UP	
Air Filter Secondary.....	A-5550
Air Filter Primary.....	A-5549
Air Filter Set.....	A-5549M-S
Air Filter Primary.....	A-5549M
Fuel Filter.....	FC-5508
Hydraulic Oil Filter.....	H-5506
Oil Filter Full Flow.....	C-5510
950F (LOADERS) S/N: 5SK977-2333	
Air Filter Primary.....	A-5549M
Air Filter Primary.....	A-5509
Air Filter Set.....	A-5549M-S
Air Filter Set.....	A-5522-S
Air Filter Primary.....	A-5549
Air Filter Secondary.....	A-5550
Air Filter Secondary.....	A-5522
Fuel Filter Secondary.....	FC-55151
Fuel Filter Secondary.....	FC-5515
Fuel Filter.....	FC-5516
Hydraulic Oil Filter.....	H-5506
Oil Filter Full Flow.....	C-5510
950F (LOADERS) S/N: 6YG1-UP	
Air Filter Secondary.....	A-5522

MODEL/APPLICATION SAKURA NO

CATERPILLAR

950F (LOADERS)
S/N: 6YG1-UP

Air Filter Primary..... A-5509
Air Filter Set..... A-5522-S
Fuel Filter..... F-5505
Fuel Filter Secondary..... FC-5507
Hydraulic Oil Filter..... H-55270
Hydraulic Oil Filter..... H-5504
Hydraulic Oil Filter..... H-5506

950F (LOADERS)
S/N: 6YG-UP

Air Filter Primary..... A-5549
Air Filter Set..... A-5549M-S
Air Filter Secondary..... A-5550
Air Filter Primary..... A-5549M
Fuel Filter..... FC-5516
Fuel Filter..... F-5505
Fuel Filter Secondary..... FC-55151
Fuel Filter Secondary..... FC-5515
Fuel Filter Secondary..... FC-5507
Hydraulic Oil Filter..... H-5506
Hydraulic Oil Filter..... H-5501

950F (LOADERS)
S/N: 7ZF1-UP

Air Filter Secondary..... A-5522
Air Filter Set..... A-5522-S
Air Filter Primary..... A-5509
Fuel Filter..... F-5505
Fuel Filter Secondary..... FC-5507
Hydraulic Oil Filter..... H-5506
Hydraulic Oil Filter..... H-55270
Oil Filter Full Flow..... C-5510

950F (LOADERS)
S/N: 7ZF-UP

Air Filter Secondary..... A-5550
Air Filter Set..... A-5549M-S
Air Filter Primary..... A-5549M
Air Filter Primary..... A-5549
Fuel Filter Secondary..... FC-5507
Fuel Filter Secondary..... FC-55151
Fuel Filter..... FC-5516
Fuel Filter Secondary..... FC-5515
Fuel Filter..... F-5505
Hydraulic Oil Filter..... H-5501
Hydraulic Oil Filter..... H-5506

950F (LOADERS)
S/N: 8TK03917-UP

Air Filter Secondary..... A-5550
Air Filter Set..... A-5549M-S
Air Filter Primary..... A-5549M
Air Filter Primary..... A-5549
Cabin Air Filter..... CA-55070
Fuel Filter Secondary..... FC-5515
Fuel Filter Secondary..... FC-55151
Fuel Filter..... FC-5516
Hydraulic Oil Filter..... H-5506
Oil Filter Full Flow..... C-5510

MODEL/APPLICATION SAKURA NO

CATERPILLAR

950F (LOADERS)
S/N: 8TK1-310

Air Filter Primary..... A-5549
Air Filter Secondary..... A-5550
Air Filter Primary..... A-5549M
Air Filter Set..... A-5549M-S
Fuel Filter Secondary..... FC-5507
Fuel Filter..... F-5505
Hydraulic Oil Filter..... H-5506
Oil Filter Full Flow..... C-5510

950F (LOADERS)
S/N: 8TK2200-UP

Air Filter Primary..... A-5549
Air Filter Primary..... A-5549M
Air Filter Secondary..... A-5550
Air Filter Set..... A-5549M-S
Hydraulic Oil Filter..... H-5506
Oil Filter Full Flow..... C-5510

950F (LOADERS)
S/N: 8TK311-2199

Air Filter Primary..... A-5509
Air Filter Primary..... A-5549
Air Filter Primary..... A-5549M
Air Filter Set..... A-5522-S
Air Filter Set..... A-5549M-S
Air Filter Secondary..... A-5550
Air Filter Secondary..... A-5522
Fuel Filter..... FC-5516
Fuel Filter Secondary..... FC-5515
Fuel Filter Secondary..... FC-55151
Hydraulic Oil Filter..... H-5506
Oil Filter Full Flow..... C-5510

950F (LOADERS)
S/N: 8TK-UP

Air Filter Primary..... A-5549
Air Filter Secondary..... A-5550
Air Filter Primary..... A-5549M
Air Filter Set..... A-5549M-S
Fuel Filter..... FC-5516
Fuel Filter..... F-5505
Fuel Filter Secondary..... FC-55151
Fuel Filter Secondary..... FC-5515
Fuel Filter Secondary..... FC-5507
Hydraulic Oil Filter..... H-5501
Hydraulic Oil Filter..... H-5506

950B (LOADERS)
CAT (S/N: 07Z1375-8554)

Oil Filter Full Flow..... C-5510

950B (LOADERS)
CAT (S/N: 07Z8555-8941)

Fuel Filter Secondary..... FC-5507
Oil Filter Full Flow..... C-5510
Oil Filter Full Flow..... C-5522

950B (LOADERS)
CAT (S/N: 07Z8942-UP)

Fuel Filter Secondary..... FC-5507

MODEL/APPLICATION SAKURA NO

CATERPILLAR

950B (LOADERS)
CAT (S/N: 12Z607-6185)

Oil Filter Full Flow..... C-5510

950B (LOADERS)
CAT (S/N: 12Z6186-11536)

Oil Filter Full Flow..... C-5510

950B (LOADERS)
S/N: 22Z1-3188

Air Filter Set..... A-5522-S
Air Filter Primary..... A-5509
Air Filter Secondary..... A-5522
Fuel Filter Secondary..... FC-5507
Fuel Filter..... F-5505
Hydraulic Oil Filter..... H-5506
Oil Filter Full Flow..... C-5510

950B (LOADERS)
S/N: 22Z1-811

Hydraulic Oil Filter..... H-5501

950B (LOADERS)
S/N: 22Z4827-5259

Air Filter Primary..... A-5509
Air Filter Set..... A-5522-S
Air Filter Secondary..... A-5522
Hydraulic Oil Filter..... H-5506
Hydraulic Oil Filter..... H-5501

950B (LOADERS)
S/N: 22Z5260-5407

Air Filter Secondary..... A-5522
Air Filter Primary..... A-5509
Air Filter Set..... A-5522-S
Hydraulic Oil Filter..... H-5506

950B (LOADERS)
S/N: 22Z5408-UP

Hydraulic Oil Filter..... H-5506

950B (LOADERS)
S/N: 22Z812-4826

Air Filter Secondary..... A-5522
Air Filter Primary..... A-5509
Air Filter Set..... A-5522-S
Hydraulic Oil Filter..... H-5501

950B (LOADERS)
S/N: 31R1-UP

Air Filter Primary..... A-5509
Air Filter Secondary..... A-5522
Air Filter Set..... A-5522-S
Fuel Filter..... F-5505
Fuel Filter Secondary..... FC-5507
Hydraulic Oil Filter..... H-5506
Oil Filter Full Flow..... C-5510

950B (LOADERS)
S/N: 63R1-5857

Hydraulic Oil Filter..... H-5501

950B (LOADERS)
S/N: 63R1-6053

Air Filter Set..... A-5522-S
Air Filter Primary..... A-5509

Sakura Filter

ENGINE APPLICATION

MODEL/APPLICATION	SAKURA NO
CATERPILLAR	
950B (LOADERS) S/N: 63R1-6053	
Air Filter Secondary.....	A-5522
Fuel Filter.....	F-5505
Fuel Filter Secondary.....	FC-5507
Hydraulic Oil Filter.....	H-5506
Oil Filter Full Flow.....	C-5510
950B (LOADERS) S/N: 63R5858-6054	
Air Filter Secondary.....	A-5522
Air Filter Primary.....	A-5509
Air Filter Set.....	A-5522-S
Hydraulic Oil Filter.....	H-5501
950B (LOADERS) S/N: 63R6055-9191	
Air Filter Set.....	A-5522-S
Air Filter Primary.....	A-5509
Air Filter Secondary.....	A-5522
Hydraulic Oil Filter.....	H-5501
Hydraulic Oil Filter.....	H-5506
950B (LOADERS) S/N: 63R9192-UP	
Air Filter Set.....	A-5522-S
Air Filter Primary.....	A-5509
Air Filter Secondary.....	A-5522
Hydraulic Oil Filter.....	H-5506
950B (LOADERS) S/N: 65R1-UP	
Air Filter Secondary.....	A-5522
Air Filter Set.....	A-5522-S
Air Filter Primary.....	A-5509
Fuel Filter Secondary.....	FC-5507
Fuel Filter.....	F-5505
Hydraulic Oil Filter.....	H-5506
Oil Filter Full Flow.....	C-5510
950E (LOADERS) S/N: 22Z-UP	
Air Filter Primary.....	A-5549
Air Filter Primary.....	A-5509
Air Filter Primary.....	A-5549M
Air Filter Set.....	A-5549M-S
Air Filter Secondary.....	A-5550
Air Filter Set.....	A-5522-S
Air Filter Secondary.....	A-5522
Fuel Filter.....	FC-5501
Fuel Filter Secondary.....	FC-5507
Fuel Filter.....	FC-5523
Hydraulic Oil Filter.....	H-5501
Hydraulic Oil Filter.....	H-5506

MODEL/APPLICATION	SAKURA NO
CATERPILLAR	
Oil Filter Full Flow.....	C-5510
950E (LOADERS) S/N: 31R-UP	
Air Filter Primary.....	A-5509
Air Filter Set.....	A-5522-S
Air Filter Primary.....	A-5549M
Air Filter Secondary.....	A-5550
Air Filter Secondary.....	A-5522
Air Filter Set.....	A-5549M-S
Air Filter Primary.....	A-5549
Fuel Filter Secondary.....	FC-5507
Fuel Filter.....	FC-5501
Fuel Filter.....	FC-5523
Hydraulic Oil Filter.....	H-5501
Hydraulic Oil Filter.....	H-5506
Oil Filter Full Flow.....	C-5510
950E (LOADERS) S/N: 63R6054-UP	
Air Filter Set.....	A-5522-S
Air Filter Secondary.....	A-5522
Air Filter Primary.....	A-5509
Fuel Filter.....	F-5505
Fuel Filter Secondary.....	FC-5507
Hydraulic Oil Filter.....	H-5506
Oil Filter Full Flow.....	C-5510
950E (LOADERS) S/N: 63R-UP	
Air Filter Primary.....	A-5549
Air Filter Secondary.....	A-5550
Air Filter Secondary.....	A-5522
Air Filter Set.....	A-5549M-S
Air Filter Set.....	A-5522-S
Air Filter Primary.....	A-5509
Air Filter Primary.....	A-5549M
Fuel Filter Secondary.....	FC-5507
Fuel Filter.....	FC-5523
Fuel Filter.....	FC-5501
Hydraulic Oil Filter.....	H-5501
Hydraulic Oil Filter.....	H-5506
Oil Filter Full Flow.....	C-5510
950E (LOADERS) S/N: 65R3088-UP	
Air Filter Primary.....	A-5549M
Air Filter Set.....	A-5522-S
Air Filter Primary.....	A-5509
Air Filter Primary.....	A-5549
Air Filter Secondary.....	A-5550
Air Filter Secondary.....	A-5522
Air Filter Set.....	A-5549M-S
Fuel Filter Secondary.....	FC-5507
Hydraulic Oil Filter.....	H-5506
Oil Filter Full Flow.....	C-5510
950E (LOADERS) S/N: 65R3089-UP	
Air Filter Primary.....	A-5509
Air Filter Set.....	A-5522-S
Air Filter Secondary.....	A-5522
Fuel Filter.....	F-5505
Fuel Filter Secondary.....	FC-5507

MODEL/APPLICATION	SAKURA NO
CATERPILLAR	
Hydraulic Oil Filter.....	H-5506
Oil Filter Full Flow.....	C-5510
950E (LOADERS) S/N: 65R-UP	
Air Filter Primary.....	A-5509
Air Filter Primary.....	A-5549M
Air Filter Set.....	A-5522-S
Air Filter Secondary.....	A-5522
Air Filter Secondary.....	A-5550
Air Filter Primary.....	A-5549
Air Filter Set.....	A-5549M-S
Fuel Filter.....	FC-5523
Fuel Filter.....	FC-5501
Fuel Filter Secondary.....	FC-5507
Hydraulic Oil Filter.....	H-5501
Hydraulic Oil Filter.....	H-5506
Oil Filter Full Flow.....	C-5510
950G (LOADERS) CAT (S/N: 55K1-UP)	
Fuel Filter.....	FC-5508
Fuel Filter.....	FC-5516
Fuel Filter Secondary.....	FC-5515
Fuel Filter Secondary.....	FC-55151
Oil Filter Full Flow.....	C-5522
950G (LOADERS) CAT (S/N: 63K1-UP)	
Fuel Filter Secondary.....	FC-55151
Fuel Filter.....	FC-5516
Fuel Filter Secondary.....	FC-5515
Fuel Filter.....	FC-5508
Oil Filter Full Flow.....	C-5522
950G (LOADERS) CAT 3126 (S/N: 2351-UP)	
Air Filter Secondary.....	A-5550
Fuel Filter.....	FC-5516
Fuel Filter Secondary.....	FC-5515
Fuel Filter Secondary.....	FC-55151
Fuel Filter.....	FC-5508
Hydraulic Oil Filter.....	HC-5504
Hydraulic Oil Filter.....	HC-5505
Oil Filter Full Flow.....	C-5510
950G (LOADERS) CAT 3126 (S/N: 33W1-UP)	
Air Filter Secondary.....	A-5550
Fuel Filter Secondary.....	FC-55151
Fuel Filter.....	FC-5516
Fuel Filter Secondary.....	FC-5515
Fuel Filter.....	FC-5508
Hydraulic Oil Filter.....	HC-5504
Oil Filter Full Flow.....	C-5510
950G (LOADERS) CAT 3126 (S/N: 4BS1-UP)	
Air Filter Secondary.....	A-5550
Fuel Filter Secondary.....	FC-55151
Fuel Filter.....	FC-5516
Fuel Filter.....	FC-5508
Fuel Filter Secondary.....	FC-5515
Hydraulic Oil Filter.....	HC-5504
Oil Filter Full Flow.....	C-5510

MODEL/APPLICATION	SAKURA NO
CATERPILLAR	
950G (LOADERS) CAT 3126 (S/N: 4BS1-UP)	
Air Filter Secondary.....	A-5550
Fuel Filter.....	FC-5516
Fuel Filter.....	FC-5508
Fuel Filter Secondary.....	FC-55151
Fuel Filter Secondary.....	FC-5515
Hydraulic Oil Filter.....	HC-5504
Oil Filter Full Flow.....	C-5510
950G (LOADERS) CAT 3126 (S/N: 5MW1-UP)	
Air Filter Secondary.....	A-5550
Fuel Filter Secondary.....	FC-5515
Fuel Filter Secondary.....	FC-55151
Fuel Filter.....	FC-5508
Fuel Filter.....	FC-5516
Hydraulic Oil Filter.....	HC-5504
Oil Filter Full Flow.....	C-5510
950G (LOADERS) CAT 3126 (S/N: 6NS1-UP)	
Air Filter Secondary.....	A-5550
Fuel Filter.....	FC-5516
Fuel Filter.....	FC-5508
Fuel Filter Secondary.....	FC-55151
Fuel Filter Secondary.....	FC-5515
Hydraulic Oil Filter.....	HC-5504
Oil Filter Full Flow.....	C-5510
950G (LOADERS) CAT 3126 (S/N: 8JW1-UP)	
Air Filter Secondary.....	A-5550
Fuel Filter Secondary.....	FC-55151
Fuel Filter Secondary.....	FC-5515
Fuel Filter.....	FC-5508
Fuel Filter.....	FC-5516
Hydraulic Oil Filter.....	HC-5504
Oil Filter Full Flow.....	C-5510
950G (LOADERS) CAT 3126B ATAAC HEUI (S/N: 6NS1-UP)	
Air Filter Secondary.....	A-5550
Fuel Filter Secondary.....	FC-55151
Fuel Filter.....	FC-5508
Fuel Filter.....	FC-5516
Fuel Filter Secondary.....	FC-5515
Hydraulic Oil Filter.....	HC-5504
Oil Filter Full Flow.....	C-5510
950G (LOADERS) S/N: 2J51-940	
Air Filter Secondary.....	A-5550
Air Filter.....	A-25460
Air Filter.....	A-5584
Hydraulic Oil Filter.....	HC-5504
950G (LOADERS) S/N: 2J5941-UP	
Air Filter.....	A-25460
Air Filter.....	A-5584

MODEL/APPLICATION	SAKURA NO
CATERPILLAR	
Air Filter Secondary.....	A-5550
Hydraulic Oil Filter.....	HC-5504
Hydraulic Oil Filter.....	HC-5505
Hydraulic Oil Filter.....	HC-55170
950G II (LOADERS) CAT (S/N: 5GG1-UP)	
Fuel Filter.....	FC-5517
Oil Filter Full Flow.....	C-5522
950G II (LOADERS) CAT (S/N: BMA1-UP)	
Fuel Filter.....	FC-5517
Oil Filter Full Flow.....	C-5522
950G II (LOADERS) S/N: A1-UP	
Air Filter Primary.....	A-5558
Air Filter Secondary.....	A-5559
Cabin Air Filter.....	CA-55070
Hydraulic Oil Filter.....	HC-5504
950G II (LOADERS) S/N: AXR1-UP	
Air Filter Secondary.....	A-5559
Air Filter Primary.....	A-5558
Cabin Air Filter.....	CA-55070
Hydraulic Oil Filter.....	HC-5504
950G II (LOADERS) S/N: AYB1-UP	
Air Filter Primary.....	A-5558
Air Filter Secondary.....	A-5559
Air Filter.....	A-25460
Cabin Air Filter.....	CA-55070
Hydraulic Oil Filter.....	HC-5504
Hydraulic Oil Filter.....	HC-55170
Hydraulic Oil Filter.....	HC-5505
950G II (LOADERS) S/N: AYL1-UP	
Air Filter.....	A-25460
Air Filter Primary.....	A-5558
Air Filter Secondary.....	A-5559
Cabin Air Filter.....	CA-55070
Hydraulic Oil Filter.....	HC-5504
950G II (LOADERS) S/N: BAA1-UP	
Air Filter Primary.....	A-5558
Air Filter Secondary.....	A-5559
Cabin Air Filter.....	CA-55070
Hydraulic Oil Filter.....	HC-5504
950H (LOADERS) CAT S/N: C7C1-UP , 2006-UP	
Cabin Air Filter.....	CA-55070
Fuel Filter.....	FC-5517
Hydraulic Oil Filter.....	HC-5504
Oil Filter Full Flow.....	C-5522
950H (LOADERS) CAT S/N: K5K2-UP , 2006-UP	
Cabin Air Filter.....	CA-55070
Fuel Filter.....	FC-5517
Hydraulic Oil Filter.....	HC-5504

MODEL/APPLICATION	SAKURA NO
CATERPILLAR	
Oil Filter Full Flow.....	C-5522
950H (LOADERS) CAT S/N: KH11-UP , 2006-UP	
Cabin Air Filter.....	CA-55070
Fuel Filter.....	FC-5517
Hydraulic Oil Filter.....	HC-5504
Oil Filter Full Flow.....	C-5522
950H (LOADERS) CAT S/N: M1G1-UP , 2006-UP	
Cabin Air Filter.....	CA-55070
Fuel Filter.....	FC-5517
Hydraulic Oil Filter.....	HC-5504
Oil Filter Full Flow.....	C-5522
950H (LOADERS) CAT S/N: N1A1-UP , 2006-UP	
Cabin Air Filter.....	CA-55070
Fuel Filter.....	FC-5517
Hydraulic Oil Filter.....	HC-5504
Oil Filter Full Flow.....	C-5522
950H (LOADERS) w/C7 Eng.	
Hydraulic Oil Filter.....	HC-55280
950A (LOADERS) S/N: 81J1-4272	
Air Filter Secondary.....	A-5567
Air Filter Set.....	A-55071-S
Air Filter Primary.....	A-5507
Air Filter Secondary.....	A-5508
Air Filter Primary.....	A-5566
Air Filter Set.....	A-5507-S
Air Filter Set.....	A-5568-S
Fuel Filter Secondary.....	FC-5507
Hydraulic Oil Filter.....	H-5503
Hydraulic Oil Filter.....	H-5504
Oil Filter Full Flow.....	O-5502
950A (LOADERS) S/N: 81J4273-7845	
Air Filter Set.....	A-5507-S
Air Filter Set.....	A-5568-S
Air Filter Primary.....	A-5507
Air Filter Set.....	A-55071-S
Air Filter Secondary.....	A-5508
Air Filter Primary.....	A-5566
Air Filter Secondary.....	A-5567
Fuel Filter Secondary.....	FC-5507
Hydraulic Oil Filter.....	H-5503
Hydraulic Oil Filter.....	H-5504
Oil Filter Full Flow.....	C-5510
950A (LOADERS) S/N: 81J7846-UP	
Air Filter Secondary.....	A-5567
Air Filter Secondary.....	A-5508
Air Filter Set.....	A-5507-S
Air Filter Set.....	A-5568-S
Air Filter Primary.....	A-5507
Air Filter Secondary.....	A-5567
Hydraulic Oil Filter.....	H-5503
Hydraulic Oil Filter.....	H-5504
Oil Filter Full Flow.....	C-5510

Sakura Filter

ENGINE APPLICATION

MODEL/APPLICATION	SAKURA NO	MODEL/APPLICATION	SAKURA NO	MODEL/APPLICATION	SAKURA NO
CATERPILLAR		CATERPILLAR		CATERPILLAR	
950A (LOADERS) S/N: 81J7846-UP		Fuel Filter Secondary.....	FC-5515	Air Filter Secondary.....	A-5550
Hydraulic Oil Filter.....	H-5503	Fuel Filter.....	FC-5523	Air Filter Primary.....	A-5549M
Hydraulic Oil Filter.....	H-5504	Fuel Filter.....	FC-5516	Air Filter Set.....	A-5549M-S
Oil Filter Full Flow.....	C-5510	Fuel Filter.....	FC-5501	Cabin Air Filter.....	CA-55070
		Fuel Filter Secondary.....	FC-55151	Hydraulic Oil Filter.....	H-5506
		Oil Filter Full Flow.....	C-5522		
950F SERIES II (LOADERS) CAT (S/N: 4TF1202-9463)		950F SERIES II (LOADERS) CAT (S/N: 98Z8480-14397)		950F SERIES II (LOADERS) S/N: 2LM1-UP	
Fuel Filter.....	FC-5523	Fuel Filter.....	FC-5516	Air Filter Primary.....	A-5549M
Fuel Filter.....	FC-5501	Fuel Filter.....	FC-5508	Air Filter Set.....	A-5549M-S
Oil Filter Full Flow.....	C-5522	Fuel Filter.....	FC-5508	Air Filter Primary.....	A-5549
Oil Filter Full Flow.....	C-5510	Fuel Filter Secondary.....	FC-55151	Air Filter Secondary.....	A-5550
		Fuel Filter.....	FC-5501	Fuel Filter.....	FC-5516
950F SERIES II (LOADERS) CAT (S/N: 4TF17863-24499)		Fuel Filter.....	FC-5523	Fuel Filter Secondary.....	FC-55151
Fuel Filter.....	FC-5501	Fuel Filter Secondary.....	FC-5515	Fuel Filter.....	F-5505
Fuel Filter Secondary.....	FC-55151	Oil Filter Full Flow.....	C-5522	Fuel Filter.....	FC-5508
Fuel Filter.....	FC-5523			Fuel Filter Secondary.....	FC-5515
Fuel Filter Secondary.....	FC-5515	950F SERIES II (LOADERS) CAT S/N: 4TF1-1171		Hydraulic Oil Filter.....	H-5506
Fuel Filter.....	FC-5516	Fuel Filter.....	FC-5523	Oil Filter Full Flow.....	C-5510
Oil Filter Full Flow.....	C-5510	Fuel Filter.....	FC-5501		
Oil Filter Full Flow.....	C-5522			950F SERIES II (LOADERS) S/N: 4DJ2000-2864	
		950F SERIES II (LOADERS) CAT S/N: 4TF1172-1172		Air Filter Secondary.....	A-5550
Fuel Filter.....	FC-5508	Fuel Filter.....	FC-5501	Air Filter Set.....	A-5549M-S
Fuel Filter.....	FC-5523	Fuel Filter.....	FC-5523	Air Filter Primary.....	A-5549
Fuel Filter Secondary.....	FC-5515	Oil Filter Full Flow.....	C-5510	Air Filter Primary.....	A-5549M
Fuel Filter Secondary.....	FC-55151			Fuel Filter Secondary.....	FC-5515
Fuel Filter.....	FC-5501	950F SERIES II (LOADERS) CAT S/N: 4TF1173-1178		Fuel Filter.....	FC-5516
Fuel Filter.....	FC-5516	Fuel Filter.....	FC-5501	Fuel Filter Secondary.....	FC-55151
Oil Filter Full Flow.....	C-5522	Fuel Filter.....	FC-5523	Fuel Filter.....	F-5505
Oil Filter Full Flow.....	C-5510			Hydraulic Oil Filter.....	H-5506
		950F SERIES II (LOADERS) CAT S/N: 4TF1179-1179		Oil Filter Full Flow.....	C-5510
950F SERIES II (LOADERS) CAT (S/N: 4TF9464-17862)		Fuel Filter.....	FC-5523		
Fuel Filter.....	FC-5523	Fuel Filter.....	FC-5501	950F SERIES II (LOADERS) S/N: 4DJ2865-3960	
Fuel Filter Secondary.....	FC-5515	Oil Filter Full Flow.....	C-5510	Air Filter Set.....	A-5549M-S
Fuel Filter Secondary.....	FC-55151			Air Filter Primary.....	A-5549M
Fuel Filter.....	FC-5501	950F SERIES II (LOADERS) CAT S/N: 4TF1180-1198		Air Filter Secondary.....	A-5550
Fuel Filter.....	FC-5516	Fuel Filter.....	FC-5501	Air Filter Primary.....	A-5549
Oil Filter Full Flow.....	C-5510	Fuel Filter.....	FC-5523	Fuel Filter.....	F-5505
Oil Filter Full Flow.....	C-5522			Fuel Filter.....	FC-5508
		950F SERIES II (LOADERS) CAT S/N: 4TF1199-1199		Fuel Filter.....	FC-5516
950F SERIES II (LOADERS) CAT (S/N: 98Z1-2349)		Fuel Filter.....	FC-5523	Fuel Filter Secondary.....	FC-5515
Fuel Filter.....	FC-5516	Fuel Filter.....	FC-5501	Fuel Filter Secondary.....	FC-55151
Fuel Filter.....	FC-5523	Oil Filter Full Flow.....	C-5510	Hydraulic Oil Filter.....	H-5506
Fuel Filter Secondary.....	FC-5515			Oil Filter Full Flow.....	C-5510
Fuel Filter.....	FC-5501	950F SERIES II (LOADERS) CAT S/N: 4TF1200-1201			
Fuel Filter Secondary.....	FC-55151	Fuel Filter.....	FC-5501	950F SERIES II (LOADERS) S/N: 5SK1-1989	
Oil Filter Full Flow.....	C-5522	Fuel Filter.....	FC-5523	Air Filter Primary.....	A-5549
				Air Filter Secondary.....	A-5550
950F SERIES II (LOADERS) CAT (S/N: 98Z14398-UP)		950F SERIES II (LOADERS) S/N: 2LM1-187		Air Filter Primary.....	A-5549M
Fuel Filter.....	FC-5508	Air Filter Secondary.....	A-5550	Air Filter Set.....	A-5549M-S
Fuel Filter.....	FC-5516	Air Filter Primary.....	A-5549	Cabin Air Filter.....	CA-55070
Fuel Filter Secondary.....	FC-55151	Air Filter Set.....	A-5549M-S	Hydraulic Oil Filter.....	H-5506
Fuel Filter.....	FC-5501	Air Filter Primary.....	A-5549M		
Fuel Filter.....	FC-5523	Cabin Air Filter.....	CA-55070	950F SERIES II (LOADERS) S/N: 5SK1-742	
Fuel Filter Secondary.....	FC-5515	Hydraulic Oil Filter.....	H-5506	Air Filter Primary.....	A-5549M
Oil Filter Full Flow.....	C-5522			Air Filter Secondary.....	A-5550
		950F SERIES II (LOADERS) S/N: 2LM188-UP		Air Filter Primary.....	A-5549
950F SERIES II (LOADERS) CAT (S/N: 98Z8114-8479)		Air Filter Primary.....	A-5549	Air Filter Set.....	A-5549M-S
Fuel Filter.....	FC-5508			Fuel Filter Secondary.....	FC-5507
Fuel Filter.....	FC-5516			Fuel Filter.....	F-5505
Fuel Filter Secondary.....	FC-55151				
Fuel Filter.....	FC-5501				
Fuel Filter.....	FC-5523				
Fuel Filter Secondary.....	FC-5515				
Oil Filter Full Flow.....	C-5522				

MODEL/APPLICATION	SAKURA NO	MODEL/APPLICATION	SAKURA NO	MODEL/APPLICATION	SAKURA NO
CATERPILLAR		CATERPILLAR		CATERPILLAR	
950F SERIES II (LOADERS) S/N: 55K1-742		Air Filter Secondary.....	A-5550	Air Filter Secondary.....	A-5567
Hydraulic Oil Filter.....	H-5506	Air Filter Primary.....	A-5549	Air Filter Primary.....	A-5507
Oil Filter Full Flow.....	C-5510	Air Filter Set.....	A-5549M-S	Air Filter Primary.....	A-5566
950F SERIES II (LOADERS) S/N: 55K1990-UP		Air Filter Primary.....	A-5549M	Air Filter Secondary.....	A-5508
Air Filter Primary.....	A-5549	Fuel Filter.....	FC-5508	Air Filter Set.....	A-55071-S
Air Filter Secondary.....	A-5550	Fuel Filter Secondary.....	FC-55151	Air Filter Set.....	A-5507-S
Air Filter Set.....	A-5549M-S	Fuel Filter Secondary.....	FC-5515	Air Filter Set.....	A-5568-S
Air Filter Primary.....	A-5549M	Fuel Filter.....	FC-5516	Fuel Filter Secondary.....	FC-5507
Cabin Air Filter.....	CA-55070	Hydraulic Oil Filter.....	H-5506	Hydraulic Oil Filter.....	H-5504
Hydraulic Oil Filter.....	H-5506	Oil Filter Full Flow.....	C-5510	Hydraulic Oil Filter.....	H-5502
950F SERIES II (LOADERS) S/N: 55K743-UP		950F SERIES II (LOADERS) S/N: 8TK816-3230		Oil Filter Full Flow.....	O-5502
Air Filter Primary.....	A-5549M	Air Filter Primary.....	A-5549	951B (LOADERS) S/N: 86J1-1991	
Air Filter Set.....	A-5549M-S	Air Filter Primary.....	A-5549M	Air Filter Set.....	A-55071-S
Air Filter Primary.....	A-5549	Air Filter Set.....	A-5549M-S	Air Filter Primary.....	A-5507
Air Filter Secondary.....	A-5550	Air Filter Secondary.....	A-5550	Air Filter Secondary.....	A-5508
Fuel Filter Secondary.....	FC-5515	Cabin Air Filter.....	CA-55070	Air Filter Secondary.....	A-5567
Fuel Filter.....	FC-5508	Hydraulic Oil Filter.....	H-5506	Air Filter Set.....	A-5507-S
Fuel Filter.....	FC-5516	950 GC (LOADERS) CAT C7.1		Air Filter Primary.....	A-5566
Fuel Filter Secondary.....	FC-55151	Fuel Filter.....	EF-55050	Air Filter Set.....	A-5568-S
Hydraulic Oil Filter.....	H-5506	950K (LOADERS) CAT C7.1		Fuel Filter Secondary.....	FC-5507
Oil Filter Full Flow.....	C-5510	Fuel Filter.....	EF-55050	Hydraulic Oil Filter.....	H-5502
950F SERIES II (LOADERS) S/N: 8TK1-4489		950M Z (LOADERS) CAT C7.1		Hydraulic Oil Filter.....	H-5504
Air Filter Set.....	A-5549M-S	Fuel Filter.....	EF-55050	Oil Filter Full Flow.....	O-5502
Air Filter Primary.....	A-5549M	951 (LOADERS)		951C (LOADERS) S/N: 19H1-UP	
Air Filter Secondary.....	A-5550	Hydraulic Oil Filter.....	H-55320	Hydraulic Oil Filter.....	H-55320
Air Filter Primary.....	A-5549	951 (LOADERS) S/N: 69H1-UP		951C (LOADERS) S/N: 19H1-UP	
Fuel Filter.....	F-5505	Air Filter Set.....	A-5507-S	Air Filter Secondary.....	A-5567
Fuel Filter Secondary.....	FC-55151	Air Filter Set.....	A-55071-S	Air Filter Set.....	A-5568-S
Fuel Filter.....	FC-5508	Air Filter Secondary.....	A-5508	Air Filter Primary.....	A-5566
Fuel Filter.....	FC-5516	Air Filter Primary.....	A-5507	Air Filter Primary.....	A-5507
Fuel Filter Secondary.....	FC-5515	Hydraulic Oil Filter.....	H-5504	Air Filter Set.....	A-55071-S
Hydraulic Oil Filter.....	H-5506	Hydraulic Oil Filter.....	H-5502	Air Filter Secondary.....	A-5508
Oil Filter Full Flow.....	C-5510	Hydraulic Oil Filter.....	H-5502	Air Filter Set.....	A-5507-S
950F SERIES II (LOADERS) S/N: 8TK1-815		Oil Filter Full Flow.....	O-5502	Fuel Filter Secondary.....	FC-5507
Air Filter Set.....	A-5549M-S	951B (LOADERS)		Hydraulic Oil Filter.....	H-5502
Air Filter Primary.....	A-5549M	Hydraulic Oil Filter.....	H-55320	Oil Filter Full Flow.....	C-5510
Air Filter Primary.....	A-5549	951B (LOADERS) S/N: 69H1-1868		Oil Filter Full Flow.....	O-5502
Air Filter Secondary.....	A-5550	Air Filter Primary.....	A-5566	951C (LOADERS) S/N: 86J1992-2597	
Cabin Air Filter.....	CA-55070	Air Filter Primary.....	A-5507	Air Filter Set.....	A-55071-S
Hydraulic Oil Filter.....	H-5506	Air Filter Secondary.....	A-5567	Air Filter Secondary.....	A-5508
950F SERIES II (LOADERS) S/N: 8TK3231-4187		Air Filter Set.....	A-5507-S	Air Filter Set.....	A-5507-S
Air Filter Secondary.....	A-5550	Air Filter Set.....	A-55071-S	Air Filter Secondary.....	A-5567
Cabin Air Filter.....	CA-55070	Air Filter Secondary.....	A-5508	Air Filter Primary.....	A-5507
Hydraulic Oil Filter.....	H-5506	Air Filter Primary.....	A-5507	Air Filter Set.....	A-5568-S
950F SERIES II (LOADERS) S/N: 8TK4188-UP		Hydraulic Oil Filter.....	H-5504	Air Filter Primary.....	A-5566
Air Filter Secondary.....	A-5550	Hydraulic Oil Filter.....	H-5502	Fuel Filter Secondary.....	FC-5507
Cabin Air Filter.....	CA-55070	Hydraulic Oil Filter.....	H-5504	Hydraulic Oil Filter.....	H-5502
Hydraulic Oil Filter.....	H-5506	Oil Filter Full Flow.....	C-5510	Hydraulic Oil Filter.....	H-5504
950F SERIES II (LOADERS) S/N: 8TK4490-UP		Oil Filter Full Flow.....	O-5502	Oil Filter Full Flow.....	C-5510
Air Filter Secondary.....	A-5550	951B (LOADERS) S/N: 79H1-UP		Oil Filter Full Flow.....	O-5502
Cabin Air Filter.....	CA-55070	Air Filter Secondary.....	A-5508	951C (LOADERS) S/N: 86J2598-4041	
Hydraulic Oil Filter.....	H-5506	Air Filter Primary.....	A-5507	Air Filter Secondary.....	A-5508
950F SERIES II (LOADERS)		Air Filter Set.....	A-55071-S	Air Filter Primary.....	A-5507
Air Filter Secondary.....	A-5550			Air Filter Set.....	A-55071-S

MODEL/APPLICATION	SAKURA NO	MODEL/APPLICATION	SAKURA NO	MODEL/APPLICATION	SAKURA NO
CATERPILLAR		CATERPILLAR		CATERPILLAR	
951C (LOADERS) S/N: 86J2598-4041 Air Filter Primary..... A-5566 Air Filter Secondary..... A-5567 Air Filter Set..... A-5507-S Air Filter Set..... A-5568-S Fuel Filter Secondary..... FC-5507 Hydraulic Oil Filter..... H-5504 Hydraulic Oil Filter..... H-5502 Oil Filter Full Flow..... C-5510 Oil Filter Full Flow..... O-5502		Hydraulic Oil Filter..... H-5503 Hydraulic Oil Filter..... H-5506 Oil Filter Full Flow..... C-5505 953 (LOADERS) S/N: 63Y1-UP Oil Filter Full Flow..... C-5505 953 (LOADERS) S/N: 73Y1-UP Oil Filter Full Flow..... C-5505 953 (LOADERS) S/N: 76Y1-UP Air Filter Set..... A-5522-S Air Filter Secondary..... A-5522 Air Filter Primary..... A-5509 Fuel Filter..... F-5505 Fuel Filter Secondary..... FC-5507 Hydraulic Oil Filter..... H-5506 Hydraulic Oil Filter..... H-5526 Hydraulic Oil Filter..... H-5503 Hydraulic Oil Filter..... H-55280 Oil Filter Full Flow..... C-5505 953 (LOADERS) S/N: 77Y1093-UP Air Filter Secondary..... A-5522 Air Filter Set..... A-5522-S Air Filter Primary..... A-5509 Fuel Filter..... F-5505 Fuel Filter Secondary..... FC-5507 Hydraulic Oil Filter..... H-5526 Hydraulic Oil Filter..... H-5506 Oil Filter Full Flow..... C-5505 953 (LOADERS) S/N: 77Y1093-UP Air Filter Secondary..... A-5522 Air Filter Set..... A-5522-S Air Filter Primary..... A-5509 Fuel Filter..... F-5505 Fuel Filter Secondary..... FC-5507 Hydraulic Oil Filter..... H-5526 Hydraulic Oil Filter..... H-5506 Oil Filter Full Flow..... C-5505 953 (LOADERS) S/N: 77Y1-1092 Air Filter Set..... A-5522-S Air Filter Primary..... A-5509 Air Filter Secondary..... A-5522 Fuel Filter..... F-5505 Fuel Filter Secondary..... FC-5507 Hydraulic Oil Filter..... H-5503 Hydraulic Oil Filter..... H-55280 Hydraulic Oil Filter..... H-5526 Hydraulic Oil Filter..... H-5506 Oil Filter Full Flow..... C-5505 953 (LOADERS) S/N: 78Y1061-UP Air Filter Primary..... A-5549M Air Filter Secondary..... A-5550 Air Filter Primary..... A-5549 Air Filter Secondary..... A-5525 Air Filter Primary..... A-5542 Air Filter Set..... A-5542-S Air Filter Set..... A-5549M-S Fuel Filter..... FC-5503 Hydraulic Oil Filter..... H-5503 Oil Filter Full Flow..... C-5505 953 (LOADERS) S/N: 78Y1-UP Air Filter Set..... A-5522-S		Air Filter Secondary..... A-5522-S Air Filter Primary..... A-5509 Fuel Filter..... F-5505 Fuel Filter Secondary..... FC-5507 Hydraulic Oil Filter..... H-5506 Hydraulic Oil Filter..... H-55280 Hydraulic Oil Filter..... H-5506 Hydraulic Oil Filter..... H-55280 Hydraulic Oil Filter..... H-5526 Oil Filter Full Flow..... C-5505 953 LGP (LOADERS) S/N: 05Z1-UP Air Filter Set..... A-5522-S Air Filter Primary..... A-5509 Air Filter Secondary..... A-5522 Fuel Filter Secondary..... FC-5507 Fuel Filter..... F-5505 Hydraulic Oil Filter..... H-5503 Hydraulic Oil Filter..... H-5506 Hydraulic Oil Filter..... H-55280 Hydraulic Oil Filter..... H-5526 Oil Filter Full Flow..... C-5505 953 LGP (LOADERS) S/N: 20Z1-266 Air Filter Secondary..... A-5522 Air Filter Set..... A-5522-S Air Filter Primary..... A-5509 Fuel Filter Secondary..... FC-5507 Fuel Filter..... F-5505 Hydraulic Oil Filter..... H-5506 Hydraulic Oil Filter..... H-5526 Hydraulic Oil Filter..... H-5503 Hydraulic Oil Filter..... H-55280 Oil Filter Full Flow..... C-5505 953B (LOADERS) S/N: 5MK1-UP Air Filter Secondary..... A-5567 Air Filter Set..... A-5568-S Air Filter Primary..... A-5566 Fuel Filter Secondary..... FC-5507 Hydraulic Oil Filter..... H-5503 Hydraulic Oil Filter..... H-5506 Oil Filter Full Flow..... C-5510 953C (LOADERS) CAT 3126B Air Filter Secondary..... A-5534 Air Filter Primary..... A-5535 Air Filter Set..... A-5573-S Fuel Filter..... FC-5517 Hydraulic Oil Filter..... H-5506 Oil Filter Full Flow..... C-5510 953C (LOADERS) w/3126B Eng. Air Filter Set..... A-5573M-S Air Filter Primary..... A-5535M Hydraulic Oil Filter..... HC-55280	
951C (LOADERS) S/N: 86J4042-UP Air Filter Primary..... A-5566 Air Filter Set..... A-5568-S Air Filter Set..... A-5507-S Air Filter Primary..... A-5507 Air Filter Secondary..... A-5508 Air Filter Set..... A-55071-S Air Filter Secondary..... A-5567 Fuel Filter Secondary..... FC-5507 Hydraulic Oil Filter..... H-5504 Hydraulic Oil Filter..... H-5502 Oil Filter Full Flow..... C-5510 Oil Filter Full Flow..... O-5502					
953 (LOADERS) S/N: 20Z1-UP Air Filter Set..... A-5542-S Air Filter Secondary..... A-5550 Air Filter Primary..... A-5549M Air Filter Primary..... A-5549 Air Filter Primary..... A-5542 Air Filter Set..... A-5549M-S Air Filter Secondary..... A-5525 Fuel Filter..... FC-5503 Hydraulic Oil Filter..... H-5503 Oil Filter Full Flow..... C-5505					
953 (LOADERS) S/N: 44Z1-UP Air Filter Primary..... A-5509 Air Filter Secondary..... A-5522 Air Filter Set..... A-5522-S Fuel Filter..... F-5505 Fuel Filter Secondary..... FC-5507 Hydraulic Oil Filter..... H-55280 Hydraulic Oil Filter..... H-5506 Hydraulic Oil Filter..... H-5526 Hydraulic Oil Filter..... H-5503 Oil Filter Full Flow..... C-5505					
953 (LOADERS) S/N: 5Z1-UP Air Filter Primary..... A-5549 Air Filter Secondary..... A-5522 Air Filter Set..... A-5522-S Air Filter Primary..... A-5509 Air Filter Primary..... A-5549M Air Filter Set..... A-5549M-S Air Filter Secondary..... A-5550 Fuel Filter Secondary..... FC-5507					

MODEL/APPLICATION	SAKURA NO	MODEL/APPLICATION	SAKURA NO	MODEL/APPLICATION	SAKURA NO
CATERPILLAR		CATERPILLAR		CATERPILLAR	
953C (LOADERS) W/3116 ENG. Air Filter Primary..... A-5535M Air Filter Set..... A-5573M-S		Air Filter Primary..... A-5509 Air Filter Secondary..... A-5510 Air Filter Set..... A-5522-S Hydraulic Oil Filter..... H-5504 Hydraulic Oil Filter..... H-5506 Oil Filter Full Flow..... C-5510		955K (LOADERS) S/N: 61H1-UP Air Filter Primary..... A-5549M Air Filter Primary..... A-5549 Air Filter Set..... A-5549M-S Air Filter Primary..... A-5509 Air Filter Secondary..... A-5550 Air Filter Set..... A-5522-S Air Filter Secondary..... A-5510 Fuel Filter..... F-5501 Hydraulic Oil Filter..... H-5504 Oil Filter Full Flow..... O-5502	
953D (LOADERS) Air Filter Set..... A-5555-S Air Filter Secondary..... A-5556 Air Filter Primary..... A-5555 Fuel Filter..... FC-5509 Hydraulic Oil Filter..... H-5522 Hydraulic Oil Filter..... H-5526 Hydraulic Oil Filter..... HC-55170 Hydraulic Oil Filter..... HC-5801 Oil Filter Full Flow..... C-5516		955 (LOADERS) S/N: 8511-4729 Air Filter Set..... A-5522-S Air Filter Secondary..... A-5510 Air Filter Primary..... A-5509 Hydraulic Oil Filter..... H-5504 Hydraulic Oil Filter..... H-5504 Hydraulic Oil Filter..... H-5503 Oil Filter Full Flow..... O-5502		955K (LOADERS) S/N: 85J1-4671 Air Filter Secondary..... A-5550 Air Filter Primary..... A-5549 Air Filter Primary..... A-5509 Air Filter Primary..... A-5549M Air Filter Set..... A-5522-S Air Filter Set..... A-5549M-S Air Filter Secondary..... A-5510 Fuel Filter Secondary..... FC-5507 Hydraulic Oil Filter..... H-5504 Hydraulic Oil Filter..... H-5503 Oil Filter Full Flow..... O-5502	
953D (LOADERS) S/N: C6E1-UP Fuel Filter Primary..... FC-55300		955 (LOADERS) S/N: 85J4732-4733 Air Filter Secondary..... A-5510 Air Filter Set..... A-5522-S Air Filter Primary..... A-5509 Hydraulic Oil Filter..... H-5504 Hydraulic Oil Filter..... H-5503 Oil Filter Full Flow..... O-5502		955K (LOADERS) S/N: 85J1-4671 Air Filter Secondary..... A-5550 Air Filter Primary..... A-5549 Air Filter Primary..... A-5509 Air Filter Primary..... A-5549M Air Filter Set..... A-5522-S Air Filter Set..... A-5549M-S Air Filter Secondary..... A-5510 Fuel Filter Secondary..... FC-5507 Hydraulic Oil Filter..... H-5504 Hydraulic Oil Filter..... H-5503 Oil Filter Full Flow..... O-5502	
953D III (LOADERS) S/N: LBP1-UP Hydraulic Oil Filter..... HC-5504		955 (LOADERS) S/N: 85J4737-85J4737 Air Filter Secondary..... A-5510 Air Filter Set..... A-5522-S Air Filter Primary..... A-5509 Hydraulic Oil Filter..... H-5504 Hydraulic Oil Filter..... H-5503 Oil Filter Full Flow..... O-5502		955K (LOADERS) w/3304 Eng. Hydraulic Oil Filter..... H-55320	
953C WH (LOADERS) w/3126B Eng. Air Filter Primary..... A-5535M Air Filter Set..... A-5573M-S Hydraulic Oil Filter..... HC-55280		955 (LOADERS) S/N: 85J4732-4733 Air Filter Secondary..... A-5510 Air Filter Set..... A-5522-S Air Filter Primary..... A-5509 Hydraulic Oil Filter..... H-5504 Hydraulic Oil Filter..... H-5503 Oil Filter Full Flow..... O-5502		955K (LOADERS) w/3304 Eng. Hydraulic Oil Filter..... H-55320	
953K (LOADERS) CAT C7.1 Fuel Filter..... EF-55050		955 (LOADERS) S/N: 8Y1-UP Air Filter Set..... A-5522-S Air Filter Secondary..... A-5510 Air Filter Primary..... A-5509 Hydraulic Oil Filter..... H-5506 Hydraulic Oil Filter..... H-5504 Oil Filter Full Flow..... C-5510		955L (LOADERS) Excluding: S/N: 85J4732,4733,4737 Air Filter Set..... A-5549M-S Air Filter Secondary..... A-5510 Air Filter Primary..... A-5549 Air Filter Primary..... A-5549M Air Filter Set..... A-5522-S Air Filter Secondary..... A-5550 Air Filter Primary..... A-5509 Fuel Filter Secondary..... FC-5507 Hydraulic Oil Filter..... H-5504 Hydraulic Oil Filter..... H-5503 Hydraulic Oil Filter..... H-55270 Hydraulic Oil Filter..... H-55280 Oil Filter Full Flow..... O-5502 Oil Filter Full Flow..... C-5510	
955 (LOADERS) S/N: 12A1-8259 Hydraulic Oil Filter..... H-5503 Oil Filter Full Flow..... O-5501		955 (LOADERS) S/N: 12A8260-UP Air Filter Primary..... A-5511 Air Filter Set..... A-5511-S Air Filter Secondary..... A-5512 Hydraulic Oil Filter..... H-5503 Oil Filter Full Flow..... O-5502		955L (LOADERS) S/N: 13X1-UP Air Filter Secondary..... A-5510 Air Filter Primary..... A-5549M Air Filter Secondary..... A-5550 Air Filter Set..... A-5549M-S Air Filter Set..... A-5522-S Air Filter Primary..... A-5509 Air Filter Primary..... A-5549 Fuel Filter Secondary..... FC-5507 Hydraulic Oil Filter..... H-5506 Hydraulic Oil Filter..... H-5504 Oil Filter Full Flow..... C-5510	
955 (LOADERS) S/N: 13X1-UP Air Filter Set..... A-5522-S Air Filter Primary..... A-5509 Air Filter Secondary..... A-5510 Hydraulic Oil Filter..... H-5506 Hydraulic Oil Filter..... H-5504 Oil Filter Full Flow..... C-5510		955H (LOADERS) S/N: 60A1-UP Air Filter Set..... A-5507-S Air Filter Set..... A-5568-S Air Filter Set..... A-55071-S Air Filter Secondary..... A-5508 Air Filter Primary..... A-5566 Air Filter Secondary..... A-5567 Air Filter Primary..... A-5507 Fuel Filter..... F-5501 Hydraulic Oil Filter..... H-5503 Oil Filter Full Flow..... O-5502		955L (LOADERS) S/N: 13X1-UP Air Filter Secondary..... A-5510 Air Filter Primary..... A-5549M Air Filter Secondary..... A-5550 Air Filter Set..... A-5549M-S Air Filter Set..... A-5522-S Air Filter Primary..... A-5509 Air Filter Primary..... A-5549 Fuel Filter Secondary..... FC-5507 Hydraulic Oil Filter..... H-5506 Hydraulic Oil Filter..... H-5504 Oil Filter Full Flow..... C-5510	
955 (LOADERS) S/N: 26A-UP Air Filter Secondary..... A-5512 Air Filter Set..... A-5511-S Air Filter Primary..... A-5511		955 (LOADERS) S/N: 45A-UP Air Filter Primary..... A-5511 Air Filter Secondary..... A-5512 Air Filter Set..... A-5511-S			
955 (LOADERS) S/N: 57M1-UP					

MODEL/APPLICATION	SAKURA NO
CATERPILLAR	
955L (LOADERS) S/N: 57M1-UP	
Air Filter Secondary.....	A-5550
Air Filter Primary.....	A-5509
Air Filter Primary.....	A-5549M
Air Filter Set.....	A-5549M-S
Air Filter Set.....	A-5522-S
Air Filter Secondary.....	A-5510
Air Filter Primary.....	A-5549
Fuel Filter Secondary.....	FC-5507
Hydraulic Oil Filter.....	H-5506
Hydraulic Oil Filter.....	H-5504
Oil Filter Full Flow.....	C-5510
955L (LOADERS) S/N: 85J4672-4729	
Air Filter Primary.....	A-5549M
Air Filter Set.....	A-5549M-S
Air Filter Secondary.....	A-5510
Air Filter Secondary.....	A-5550
Air Filter Primary.....	A-5549
Fuel Filter Secondary.....	FC-5507
Hydraulic Oil Filter.....	H-5503
Hydraulic Oil Filter.....	H-5504
Oil Filter Full Flow.....	C-5510
Oil Filter Full Flow.....	O-5502
955L (LOADERS) S/N: 85J4730-9509	
Air Filter Primary.....	A-5549M
Air Filter Primary.....	A-5549
Air Filter Secondary.....	A-5550
Air Filter Set.....	A-5549M-S
Air Filter Primary.....	A-5509
Air Filter Set.....	A-5522-S
Air Filter Secondary.....	A-5510
Fuel Filter Secondary.....	FC-5507
Hydraulic Oil Filter.....	H-55280
Hydraulic Oil Filter.....	H-5503
Hydraulic Oil Filter.....	H-55270
Hydraulic Oil Filter.....	H-5504
Oil Filter Full Flow.....	O-5502
Oil Filter Full Flow.....	C-5510
955L (LOADERS) S/N: 85J9510-UP	
Air Filter Primary.....	A-5549
Air Filter Set.....	A-5549M-S
Air Filter Secondary.....	A-5550
Air Filter Primary.....	A-5509
Air Filter Set.....	A-5522-S
Air Filter Primary.....	A-5549M
Air Filter Secondary.....	A-5510
Fuel Filter Secondary.....	FC-5507
Hydraulic Oil Filter.....	H-5504
Hydraulic Oil Filter.....	H-55270
Hydraulic Oil Filter.....	H-55280
Hydraulic Oil Filter.....	H-5503
Oil Filter Full Flow.....	O-5502
Oil Filter Full Flow.....	C-5510
955L (LOADERS) w/3304 Eng.	

MODEL/APPLICATION	SAKURA NO
CATERPILLAR	
Hydraulic Oil Filter.....	H-55320
960F (LOADERS) CAT (S/N: 4TF10150-13336)	
Fuel Filter.....	FC-5523
Fuel Filter Secondary.....	FC-5515
Fuel Filter Secondary.....	FC-55151
Fuel Filter.....	FC-5516
Fuel Filter.....	FC-5501
Oil Filter Full Flow.....	C-5522
960F (LOADERS) CAT (S/N: 4TF13337-17862)	
Fuel Filter.....	FC-5516
Fuel Filter Secondary.....	FC-5515
Fuel Filter Secondary.....	FC-55151
Oil Filter Full Flow.....	C-5522
960F (LOADERS) CAT (S/N: 4TF17863-31504)	
Fuel Filter Secondary.....	FC-55151
Fuel Filter.....	FC-5516
Fuel Filter Secondary.....	FC-5515
Oil Filter Full Flow.....	C-5522
960F (LOADERS) CAT (S/N: 4TF31505-32564)	
Fuel Filter.....	FC-5508
Oil Filter Full Flow.....	C-5522
960F (LOADERS) CAT (S/N: 4TF32565-UP)	
Fuel Filter Secondary.....	FC-55151
Fuel Filter.....	FC-5516
Fuel Filter.....	FC-5508
Fuel Filter Secondary.....	FC-5515
Oil Filter Full Flow.....	C-5522
960F (LOADERS) CAT (S/N: 98Z17224-21189)	
Fuel Filter.....	FC-5501
Fuel Filter.....	FC-5523
Fuel Filter.....	FC-5508
Oil Filter Full Flow.....	C-5522
960F (LOADERS) CAT (S/N: 98Z1750-5539)	
Fuel Filter Secondary.....	FC-55151
Fuel Filter.....	FC-5501
Fuel Filter.....	FC-5523
Fuel Filter Secondary.....	FC-5515
Fuel Filter.....	FC-5516
Oil Filter Full Flow.....	C-5522
960F (LOADERS) CAT (S/N: 98Z5540-12352)	
Fuel Filter Secondary.....	FC-55151
Fuel Filter.....	FC-5501
Fuel Filter.....	FC-5523
Fuel Filter Secondary.....	FC-5515
Fuel Filter.....	FC-5516
Oil Filter Full Flow.....	C-5522
960F (LOADERS) CAT (S/N: 98Z12353-17223)	
Fuel Filter.....	FC-5508

MODEL/APPLICATION	SAKURA NO
CATERPILLAR	
Fuel Filter.....	FC-5501
Fuel Filter.....	FC-5516
Fuel Filter.....	FC-5523
Fuel Filter Secondary.....	FC-5515
Fuel Filter Secondary.....	FC-55151
Oil Filter Full Flow.....	C-5522
960F (LOADERS) CAT S/N: 98Z21190-UP	
Fuel Filter Secondary.....	FC-55151
Fuel Filter.....	FC-5501
Fuel Filter.....	FC-5516
Fuel Filter.....	FC-5523
Fuel Filter Secondary.....	FC-5515
Fuel Filter.....	FC-5508
Oil Filter Full Flow.....	C-5522
960F (LOADERS) CAT 3116DITA	
Hydraulic Oil Filter Suction.....	H-5516
960F (LOADERS) S/N: 1YM1-UP	
Air Filter Primary.....	A-5549
Air Filter Set.....	A-5549M-S
Air Filter Secondary.....	A-5550
Air Filter Primary.....	A-5549M
Fuel Filter Secondary.....	FC-55151
Fuel Filter.....	FC-5516
Fuel Filter.....	FC-5508
Fuel Filter Secondary.....	FC-5515
Hydraulic Oil Filter.....	H-5506
Oil Filter Full Flow.....	C-5510
960F (LOADERS) S/N: 4CL1-328	
Air Filter Set.....	A-5549M-S
Air Filter Primary.....	A-5549M
Air Filter Secondary.....	A-5550
Air Filter Primary.....	A-5549
Cabin Air Filter.....	CA-55070
Hydraulic Oil Filter.....	H-5506
960F (LOADERS) S/N: 4CL1-446	
Air Filter Set.....	A-5549M-S
Air Filter Primary.....	A-5549M
Air Filter Primary.....	A-5549
Air Filter Secondary.....	A-5550
Fuel Filter Secondary.....	FC-55151
Fuel Filter Secondary.....	FC-5515
Fuel Filter.....	FC-5516
Fuel Filter.....	F-5505
Fuel Filter.....	FC-5508
Hydraulic Oil Filter.....	H-5506
Oil Filter Full Flow.....	C-5510
960F (LOADERS) S/N: 4CL329-UP	
Air Filter Set.....	A-5549M-S
Air Filter Secondary.....	A-5550
Air Filter Primary.....	A-5549
Air Filter Primary.....	A-5549M
Cabin Air Filter.....	CA-55070
Hydraulic Oil Filter.....	H-5506

MODEL/APPLICATION	SAKURA NO
CATERPILLAR	
960F (LOADERS) S/N: 4CL329-UP	
Air Filter Secondary.....	A-5550
Air Filter Set.....	A-5549M-S
Air Filter Primary.....	A-5549M
Air Filter Primary.....	A-5549
Fuel Filter Secondary.....	FC-55151
Fuel Filter Secondary.....	FC-5515
Fuel Filter.....	FC-5516
Fuel Filter.....	FC-5508
Hydraulic Oil Filter.....	H-5506
Oil Filter Full Flow.....	C-5510
960F (LOADERS) S/N: 6XL1-272	
Air Filter Primary.....	A-5549M
Air Filter Primary.....	A-5549
Air Filter Secondary.....	A-5550
Air Filter Set.....	A-5549M-S
Fuel Filter.....	FC-5516
Fuel Filter Secondary.....	FC-55151
Fuel Filter.....	F-5505
Fuel Filter Secondary.....	FC-5515
Hydraulic Oil Filter.....	H-5506
Oil Filter Full Flow.....	C-5510
960F (LOADERS) S/N: 6XL273-UP	
Air Filter Primary.....	A-5549M
Air Filter Primary.....	A-5549
Air Filter Set.....	A-5549M-S
Air Filter Secondary.....	A-5550
Fuel Filter.....	FC-5508
Fuel Filter Secondary.....	FC-5515
Fuel Filter Secondary.....	FC-55151
Fuel Filter.....	F-5505
Fuel Filter.....	FC-5516
Hydraulic Oil Filter.....	H-5506
Oil Filter Full Flow.....	C-5510
960F (LOADERS) S/N: 9ZJ1-UP	
Air Filter Set.....	A-5549M-S
Air Filter Primary.....	A-5549
Air Filter Primary.....	A-5549M
Air Filter Secondary.....	A-5550
Fuel Filter.....	FC-5508
Fuel Filter.....	FC-5516
Fuel Filter.....	F-5505
Fuel Filter Secondary.....	FC-5507
Fuel Filter Secondary.....	FC-55151
Fuel Filter Secondary.....	FC-5515
Hydraulic Oil Filter.....	H-5506
Oil Filter Full Flow.....	C-5510
962G (LOADERS) CAT (S/N: 55K1-2283)	
Fuel Filter.....	FC-5516
Fuel Filter Secondary.....	FC-5515
Fuel Filter Secondary.....	FC-55151

MODEL/APPLICATION	SAKURA NO
CATERPILLAR	
Fuel Filter.....	FC-5508
Oil Filter Full Flow.....	C-5522
962G (LOADERS) CAT (S/N: 55K2284-UP)	
Fuel Filter.....	FC-5508
Fuel Filter.....	FC-5516
Fuel Filter Secondary.....	FC-5515
Fuel Filter Secondary.....	FC-55151
Oil Filter Full Flow.....	C-5522
962G (LOADERS) CAT (S/N: 6JK1-UP)	
Fuel Filter.....	FC-5516
Fuel Filter Secondary.....	FC-5515
Fuel Filter Secondary.....	FC-55151
Fuel Filter.....	FC-5508
Oil Filter Full Flow.....	C-5522
962G (LOADERS) CAT 3126B ATAAC HEUI	
Hydraulic Oil Filter.....	H-86080-05
962G (LOADERS) CAT 3126B ATAAC HEUI (S/N: 3BS1-UP)	
Air Filter Secondary.....	A-5550
Fuel Filter Secondary.....	FC-5515
Fuel Filter Secondary.....	FC-55151
Fuel Filter.....	FC-5516
Fuel Filter.....	FC-5508
Hydraulic Oil Filter.....	HC-5504
Hydraulic Oil Filter.....	HC-5505
Hydraulic Oil Filter.....	HC-55170
Oil Filter Full Flow.....	C-5510
962G (LOADERS) CAT 3126B ATAAC HEUI (S/N: 4PW1-UP)	
Air Filter Secondary.....	A-5550
Fuel Filter.....	FC-5508
Fuel Filter Secondary.....	FC-5515
Fuel Filter Secondary.....	FC-55151
Fuel Filter.....	FC-5516
Hydraulic Oil Filter.....	HC-5504
Oil Filter Full Flow.....	C-5510
962G (LOADERS) CAT 3126B ATAAC HEUI (S/N: 5AS1-UP)	
Air Filter Secondary.....	A-5550
Fuel Filter.....	FC-5508
Fuel Filter.....	FC-5516
Fuel Filter Secondary.....	FC-55151
Fuel Filter Secondary.....	FC-5515
Hydraulic Oil Filter.....	HC-5504
Oil Filter Full Flow.....	C-5510
962G (LOADERS) CAT 3126B ATAAC HEUI (S/N: 5RS1-226)	
Air Filter Secondary.....	A-5550
Fuel Filter.....	FC-5508
Fuel Filter Secondary.....	FC-5515
Fuel Filter.....	FC-5516
Fuel Filter Secondary.....	FC-55151
Hydraulic Oil Filter.....	HC-5504
Oil Filter Full Flow.....	C-5510

MODEL/APPLICATION	SAKURA NO
CATERPILLAR	
962G (LOADERS) CAT 3126B ATAAC HEUI (S/N: 5RS227-UP)	
Air Filter Secondary.....	A-5550
Fuel Filter Secondary.....	FC-55151
Fuel Filter Secondary.....	FC-5515
Fuel Filter.....	FC-5508
Fuel Filter.....	FC-5516
Hydraulic Oil Filter.....	HC-5504
Oil Filter Full Flow.....	C-5510
962G (LOADERS) CAT 3126B ATAAC HEUI (S/N: 6EW1-UP)	
Air Filter Secondary.....	A-5550
Fuel Filter.....	FC-5508
Fuel Filter Secondary.....	FC-55151
Fuel Filter Secondary.....	FC-5515
Fuel Filter.....	FC-5516
Hydraulic Oil Filter.....	HC-5504
Oil Filter Full Flow.....	C-5510
962G (LOADERS) CAT 3126B ATAAC HEUI (S/N: 6HW1-UP)	
Air Filter Secondary.....	A-5550
Fuel Filter.....	FC-5508
Fuel Filter.....	FC-5516
Fuel Filter Secondary.....	FC-5515
Fuel Filter Secondary.....	FC-55151
Hydraulic Oil Filter.....	HC-5504
Oil Filter Full Flow.....	C-5510
962G (LOADERS) CAT 3126B ATAAC HEUI (S/N: 7BW1-UP)	
Air Filter Secondary.....	A-5550
Fuel Filter Secondary.....	FC-55151
Fuel Filter.....	FC-5516
Fuel Filter Secondary.....	FC-5515
Fuel Filter.....	FC-5508
Hydraulic Oil Filter.....	HC-5504
Oil Filter Full Flow.....	C-5510
962G (LOADERS) CAT 3126B ATAAC HEUI (S/N: BDP1-UP)	
Air Filter Secondary.....	A-5550
Fuel Filter.....	FC-5508
Fuel Filter Secondary.....	FC-55151
Fuel Filter Secondary.....	FC-5515
Fuel Filter.....	FC-5516
Hydraulic Oil Filter.....	HC-5504
Oil Filter Full Flow.....	C-5510
962G (LOADERS) S/N: 5AS1-217	
Air Filter.....	A-25460
Air Filter Secondary.....	A-5550
Air Filter.....	A-5584
Hydraulic Oil Filter.....	HC-5504
962G (LOADERS) S/N: 5AS218-UP	
Air Filter.....	A-5584
Air Filter Secondary.....	A-5550
Air Filter.....	A-25460
Hydraulic Oil Filter.....	HC-5504

Sakura Filter

ENGINE APPLICATION

MODEL/APPLICATION	SAKURA NO	MODEL/APPLICATION	SAKURA NO	MODEL/APPLICATION	SAKURA NO
CATERPILLAR		CATERPILLAR		CATERPILLAR	
962H (LOADERS) CAT S/N: C7C1-UP , 2006-UP Cabin Air Filter..... CA-55070 Fuel Filter..... FC-5517 Hydraulic Oil Filter..... HC-5504 Oil Filter Full Flow..... C-5522		Air Filter Secondary..... A-5559 Air Filter..... A-25460 Cabin Air Filter..... CA-55070 Hydraulic Oil Filter..... HC-5504 Hydraulic Oil Filter..... HC-55170 Hydraulic Oil Filter..... HC-5505		Air Filter Secondary..... A-5534 Air Filter Set..... A-5573-S Fuel Filter Secondary..... FC-5504 Hydraulic Oil Filter..... H-5506 Hydraulic Oil Filter..... H-5503 Oil Filter Full Flow..... C-5510	
962H (LOADERS) CAT S/N: K6K1-UP , 2006-UP Cabin Air Filter..... CA-55070 Fuel Filter..... FC-5517 Hydraulic Oil Filter..... HC-5504 Oil Filter Full Flow..... C-5522		962G II (LOADERS) S/N: BAB1-UP Air Filter Primary..... A-5558 Air Filter Secondary..... A-5559 Air Filter..... A-25460 Cabin Air Filter..... CA-55070 Hydraulic Oil Filter..... HC-5504		963B (LOADERS) W/3116 ENG. Air Filter Primary..... A-5535M Air Filter Set..... A-5573M-S	
962H (LOADERS) CAT S/N: KHX1-UP , 2006-UP Cabin Air Filter..... CA-55070 Fuel Filter..... FC-5517 Hydraulic Oil Filter..... HC-5504 Oil Filter Full Flow..... C-5522		962G II (LOADERS) S/N: BAD1-UP Air Filter Primary..... A-5558 Air Filter Secondary..... A-5559 Cabin Air Filter..... CA-55070 Hydraulic Oil Filter..... HC-5504		963C (LOADERS) CAT (S/N: 4TF29400-UP) Fuel Filter..... FC-5508 Fuel Filter..... FC-5516 Fuel Filter Secondary..... FC-5515 Fuel Filter Secondary..... FC-55151 Oil Filter Full Flow..... C-5522	
962H (LOADERS) CAT S/N: M3G1-UP , 2006-UP Cabin Air Filter..... CA-55070 Fuel Filter..... FC-5517 Hydraulic Oil Filter..... HC-5504 Oil Filter Full Flow..... C-5522		962K (LOADERS) CAT C7.1 Fuel Filter..... EF-55050		963C (LOADERS) CAT (S/N: BMA1-UP) Fuel Filter..... FC-5517 Oil Filter Full Flow..... C-5522	
962H (LOADERS) CAT S/N: N4A1-UP , 2006-UP Cabin Air Filter..... CA-55070 Fuel Filter..... FC-5517 Hydraulic Oil Filter..... HC-5504 Oil Filter Full Flow..... C-5522		963 (LOADERS) Air Filter Set..... A-5573M-S Air Filter Primary..... A-5535M		963C (LOADERS) S/N: 2DS1-2562-UP Air Filter Set..... A-5573-S Air Filter Primary..... A-5535 Air Filter Secondary..... A-5534 Hydraulic Oil Filter..... HC-5512 Hydraulic Oil Filter..... HC-5506 Hydraulic Oil Filter..... HC-5503 Hydraulic Oil Filter..... HC-55290 Hydraulic Oil Filter..... H-5506 Hydraulic Oil Filter..... HC-5511	
962H (LOADERS) w/C7 Eng. Hydraulic Oil Filter..... HC-55280		963 (LOADERS) S/N: 11Z1-UP Air Filter Primary..... A-5501 Air Filter Secondary..... A-5534 Air Filter Primary..... A-5535 Air Filter Set..... A-5573-S Air Filter Secondary..... A-5502 Fuel Filter Secondary..... FC-5507 Hydraulic Oil Filter..... H-5506 Hydraulic Oil Filter..... H-55280 Oil Filter Full Flow..... C-5510		963C (LOADERS) S/N: 2DS2563-UP Air Filter Primary..... A-5535 Air Filter Set..... A-5573-S Air Filter Secondary..... A-5534 Hydraulic Oil Filter..... HC-5512 Hydraulic Oil Filter..... HC-5511 Hydraulic Oil Filter..... HC-5506 Hydraulic Oil Filter..... HC-5503 Hydraulic Oil Filter..... HC-55290 Hydraulic Oil Filter..... H-5506	
962G II (LOADERS) CAT (S/N: 5GG1-UP) Fuel Filter..... FC-5517 Oil Filter Full Flow..... C-5522		963 (LOADERS) S/N: 48Z1-UP Air Filter Set..... A-5573-S Air Filter Secondary..... A-5534 Air Filter Primary..... A-5535 Hydraulic Oil Filter..... H-5503 Oil Filter Full Flow..... C-5510		963C (LOADERS) S/N: BBD1-2904-UP Air Filter Set..... A-5573-S Air Filter Primary..... A-5535 Air Filter Secondary..... A-5534 Hydraulic Oil Filter..... HC-5512 Hydraulic Oil Filter..... HC-5511 Hydraulic Oil Filter..... HC-5506 Hydraulic Oil Filter..... HC-5503 Hydraulic Oil Filter..... HC-55290 Hydraulic Oil Filter..... H-5506	
962G II (LOADERS) CAT (S/N: BMA1-UP) Fuel Filter..... FC-5517 Oil Filter Full Flow..... C-5522		963 (LOADERS) S/N: 6Z1-UP Air Filter Primary..... A-5535 Air Filter Set..... A-5573-S Air Filter Secondary..... A-5502 Air Filter Secondary..... A-5534 Air Filter Primary..... A-5501 Fuel Filter Secondary..... FC-5507 Hydraulic Oil Filter..... H-55280 Hydraulic Oil Filter..... H-5506 Oil Filter Full Flow..... C-5510		963C (LOADERS) S/N: BBD2905-2905-UP Air Filter Primary..... A-5535 Air Filter Set..... A-5573-S	
962G II (LOADERS) S/N: AXS1-UP Air Filter Secondary..... A-5559 Air Filter Primary..... A-5558 Cabin Air Filter..... CA-55070 Hydraulic Oil Filter..... HC-5504		963 (LOADERS) S/N: 9BL1-UP Air Filter Primary..... A-5535			
962G II (LOADERS) S/N: AXY1-UP Air Filter Primary..... A-5558 Air Filter Secondary..... A-5559 Cabin Air Filter..... CA-55070 Hydraulic Oil Filter..... HC-5504					
962G II (LOADERS) S/N: AYE1-UP Air Filter Primary..... A-5558					

Sakura Filter

ENGINE APPLICATION

MODEL/APPLICATION	SAKURA NO	MODEL/APPLICATION	SAKURA NO	MODEL/APPLICATION	SAKURA NO
CATERPILLAR		CATERPILLAR		CATERPILLAR	
963C (LOADERS) S/N: BBD2905-2905-UP Air Filter Secondary..... A-5534 Hydraulic Oil Filter..... HC-5503 Hydraulic Oil Filter..... HC-5512 Hydraulic Oil Filter..... HC-5506 Hydraulic Oil Filter..... H-5506 Hydraulic Oil Filter..... HC-5511 Hydraulic Oil Filter..... HC-55290		Hydraulic Oil Filter..... HC-5512 Hydraulic Oil Filter..... HC-5511 Hydraulic Oil Filter..... HC-5506 Hydraulic Oil Filter..... HC-55290 Hydraulic Oil Filter..... H-5506 963C (LOADERS) S/N: BBD2943-2943-UP Air Filter Primary..... A-5535 Air Filter Set..... A-5573-S Air Filter Secondary..... A-5534 Hydraulic Oil Filter..... HC-5503 Hydraulic Oil Filter..... H-5506 Hydraulic Oil Filter..... HC-55290 Hydraulic Oil Filter..... HC-5512 Hydraulic Oil Filter..... HC-5506 Hydraulic Oil Filter..... HC-5511		Hydraulic Oil Filter..... H-5506 Hydraulic Oil Filter..... H-5503 Oil Filter Full Flow..... C-5510 963C WH (LOADERS) w/3126B Eng. Air Filter Primary..... A-5535M Air Filter Set..... A-5573M-S Hydraulic Oil Filter..... HC-55280 963K (LOADERS) CAT C7.1 Fuel Filter..... EF-55050 966F SERIES II (LOADERS) CAT (S/N: 08Z68825-73069) Fuel Filter..... FC-5509 Fuel Filter Secondary..... FC-5507 Oil Filter Full Flow..... C-5510	
963C (LOADERS) S/N: BBD2906-2910-UP Air Filter Secondary..... A-5534 Air Filter Primary..... A-5535 Air Filter Set..... A-5573-S Hydraulic Oil Filter..... HC-5506 Hydraulic Oil Filter..... HC-5503 Hydraulic Oil Filter..... HC-5511 Hydraulic Oil Filter..... HC-5512 Hydraulic Oil Filter..... H-5506 Hydraulic Oil Filter..... HC-55290		963C (LOADERS) S/N: BBD2944-2945-UP Air Filter Secondary..... A-5534 Air Filter Set..... A-5573-S Air Filter Primary..... A-5535 Hydraulic Oil Filter..... HC-5503 Hydraulic Oil Filter..... HC-5512 Hydraulic Oil Filter..... HC-5506 Hydraulic Oil Filter..... HC-55290 Hydraulic Oil Filter..... H-5506 Hydraulic Oil Filter..... HC-5511		966F SERIES II (LOADERS) CAT (S/N: 13Z28100-30333) Fuel Filter Secondary..... FC-5507 Oil Filter Full Flow..... C-5510 Oil Filter Full Flow..... C-5522 966F SERIES II (LOADERS) CAT (S/N: 13Z30334-UP) Fuel Filter Secondary..... FC-5507 Oil Filter Full Flow..... C-5522 Oil Filter Full Flow..... C-5510	
963C (LOADERS) S/N: BBD2911-2911-UP Air Filter Primary..... A-5535 Air Filter Secondary..... A-5534 Air Filter Set..... A-5573-S Hydraulic Oil Filter..... HC-5511 Hydraulic Oil Filter..... HC-5506 Hydraulic Oil Filter..... HC-5512 Hydraulic Oil Filter..... HC-5503 Hydraulic Oil Filter..... H-5506 Hydraulic Oil Filter..... HC-55290		963C (LOADERS) S/N: BBD2946-UP Air Filter Set..... A-5573-S Air Filter Primary..... A-5535 Air Filter Secondary..... A-5534 Hydraulic Oil Filter..... HC-5511 Hydraulic Oil Filter..... HC-5512 Hydraulic Oil Filter..... HC-5506 Hydraulic Oil Filter..... HC-55290 Hydraulic Oil Filter..... HC-5506 Hydraulic Oil Filter..... HC-5503		966F SERIES II (LOADERS) CAT (S/N: 6NC1-UP) Fuel Filter..... FC-5509 Fuel Filter Secondary..... FC-5507 Oil Filter Full Flow..... C-5516 Oil Filter Full Flow..... C-5522	
963C (LOADERS) S/N: BBD2912-2925-UP Air Filter Primary..... A-5535 Air Filter Set..... A-5573-S Air Filter Secondary..... A-5534 Hydraulic Oil Filter..... HC-5511 Hydraulic Oil Filter..... HC-5503 Hydraulic Oil Filter..... H-5506 Hydraulic Oil Filter..... HC-55290 Hydraulic Oil Filter..... HC-5512 Hydraulic Oil Filter..... HC-5506		963C (LOADERS) S/N: BBD2946-UP Air Filter Set..... A-5573-S Air Filter Primary..... A-5535 Air Filter Secondary..... A-5534 Hydraulic Oil Filter..... HC-5511 Hydraulic Oil Filter..... HC-5512 Hydraulic Oil Filter..... H-5506 Hydraulic Oil Filter..... HC-55290 Hydraulic Oil Filter..... HC-5506 Hydraulic Oil Filter..... HC-5503		966F SERIES II (LOADERS) CAT (S/N: UP) Fuel Filter Secondary..... FC-5507 Fuel Filter..... FC-5509 Oil Filter Full Flow..... C-5522 Oil Filter Full Flow..... C-5510	
963C (LOADERS) S/N: BBD2926-2934-UP Air Filter Secondary..... A-5534 Air Filter Primary..... A-5535 Air Filter Set..... A-5573-S Hydraulic Oil Filter..... HC-5511 Hydraulic Oil Filter..... HC-55290 Hydraulic Oil Filter..... H-5506 Hydraulic Oil Filter..... HC-5512 Hydraulic Oil Filter..... HC-5506 Hydraulic Oil Filter..... HC-5503		963C (LOADERS) S/N: BBD2946-UP Air Filter Set..... A-5573-S Air Filter Primary..... A-5535M Air Filter Set..... A-5573M-S Hydraulic Oil Filter..... HC-55280		966F SERIES II (LOADERS) CAT S/N: 08Z57583-68824 Fuel Filter Secondary..... FC-5507 Oil Filter Full Flow..... C-5510	
963C (LOADERS) S/N: BBD2935-2942-UP Air Filter Set..... A-5573-S Air Filter Primary..... A-5535 Air Filter Secondary..... A-5534 Hydraulic Oil Filter..... HC-5503		963C (LOADERS) S/N: BBD2946-UP Air Filter Set..... A-5573-S Air Filter Primary..... A-5535M Air Filter Set..... A-5573M-S Hydraulic Oil Filter..... HC-55280		966F SERIES II (LOADERS) CAT S/N: 13Z22389-28099 Fuel Filter Secondary..... FC-5507 Oil Filter Full Flow..... C-5510	
963C (LOADERS) S/N: BBD2935-2942-UP Air Filter Set..... A-5573-S Air Filter Primary..... A-5535 Air Filter Secondary..... A-5534 Hydraulic Oil Filter..... HC-5503		963D (LOADERS) S/N: C6E1-UP Fuel Filter Primary..... FC-55300		966F SERIES II (LOADERS) S/N: 1SL1665-UP Air Filter Secondary..... A-5559 Air Filter Primary..... A-5558 Cabin Air Filter..... CA-55070 Hydraulic Oil Filter..... H-5506 Hydraulic Oil Filter..... H-55270	
963C (LOADERS) S/N: BBD2935-2942-UP Air Filter Set..... A-5573-S Air Filter Primary..... A-5535 Air Filter Secondary..... A-5534 Hydraulic Oil Filter..... HC-5503		963 LGP (LOADERS) S/N: 21Z1-UP Air Filter Primary..... A-5535 Air Filter Set..... A-5573-S Air Filter Secondary..... A-5502 Air Filter Primary..... A-5501 Air Filter Secondary..... A-5534 Fuel Filter Secondary..... FC-5507		966F SERIES II (LOADERS) S/N: 1SL507-UP Air Filter Primary..... A-5549M	

MODEL/APPLICATION	SAKURA NO	MODEL/APPLICATION	SAKURA NO	MODEL/APPLICATION	SAKURA NO
CATERPILLAR		CATERPILLAR		CATERPILLAR	
966F SERIES II (LOADERS) S/N: 15L507-UP Air Filter Primary..... A-5549 Air Filter Primary..... A-5558 Air Filter Secondary..... A-5559 Air Filter Set..... A-5549M-S Air Filter Secondary..... A-5550 Fuel Filter Secondary..... FC-5507 Fuel Filter..... F-5505 Hydraulic Oil Filter..... H-5504 Hydraulic Oil Filter..... H-5506 Hydraulic Oil Filter..... H-55270 Oil Filter Full Flow..... C-5510		966C (LOADERS) CAT (S/N: 03N97021-UP) Oil Filter Full Flow..... C-5510 966C (LOADERS) CAT (S/N: 47V16712-UP) Oil Filter Full Flow..... C-5510 966C (LOADERS) CAT (S/N: 8TD1317-UP) Fuel Filter..... FC-5501 Fuel Filter Secondary..... FC-5507 Fuel Filter..... FC-5523 966C (LOADERS) CAT (S/N: 8TD1-960) Fuel Filter Secondary..... FC-5507 Oil Filter Full Flow..... C-5510 Oil Filter Full Flow..... C-5522 966C (LOADERS) CAT (S/N: 8TD961-1316) Fuel Filter Secondary..... FC-5507 966C (LOADERS) CAT S/N: 47V15899-16711 Oil Filter Full Flow..... C-5510 966C (LOADERS) CAT (S/N: 49V9319-UP) Oil Filter Full Flow..... C-5510 966C (LOADERS) S/N: 18B1016-UP Air Filter Set..... A-5522-S Air Filter Primary..... A-5509 Air Filter Secondary..... A-5510 Hydraulic Oil Filter..... H-5503 Hydraulic Oil Filter..... H-55270 966C (LOADERS) S/N: 18B1-199 Hydraulic Oil Filter..... H-5503 966C (LOADERS) S/N: 18B1266-UP Air Filter Secondary..... A-5510 Air Filter Primary..... A-5509 Air Filter Set..... A-5522-S Fuel Filter..... F-5505 Fuel Filter Secondary..... FC-5507 Hydraulic Oil Filter..... H-5504 Hydraulic Oil Filter..... H-5526 Hydraulic Oil Filter..... H-55280 Hydraulic Oil Filter..... H-5503 Hydraulic Oil Filter..... H-55270 Oil Filter Full Flow..... C-5510 966C (LOADERS) S/N: 18B200-1015 Air Filter Set..... A-5522-S Air Filter Primary..... A-5509 Air Filter Secondary..... A-5510 Hydraulic Oil Filter..... H-55270 Hydraulic Oil Filter..... H-5503		966C (LOADERS) S/N: 18B200-1265 Air Filter Primary..... A-5509 Air Filter Set..... A-5522-S Air Filter Secondary..... A-5510 Fuel Filter Secondary..... FC-5507 Fuel Filter..... F-5505 Hydraulic Oil Filter..... H-5503 Hydraulic Oil Filter..... H-55280 Hydraulic Oil Filter..... H-5504 Hydraulic Oil Filter..... H-55270 Hydraulic Oil Filter..... H-5526 Oil Filter Full Flow..... C-5510 966C (LOADERS) S/N: 18B374-UP Air Filter Secondary..... A-5550 Air Filter Primary..... A-5549M Air Filter Set..... A-5549M-S Air Filter Primary..... A-5549 Fuel Filter..... F-5505 Hydraulic Oil Filter..... H-5504 Oil Filter Full Flow..... C-5510 966C (LOADERS) S/N: 30K1-1337 Air Filter Primary..... A-5543 Air Filter Secondary..... A-5520 Air Filter Set..... A-5544-S Air Filter Primary..... A-5558 Air Filter Secondary..... A-5559 Fuel Filter Secondary..... FC-5507 Hydraulic Oil Filter..... H-5504 Hydraulic Oil Filter..... H-5503 Oil Filter Full Flow..... C-5510 966C (LOADERS) S/N: 30K1338-1400 Air Filter Primary..... A-5509 Air Filter Secondary..... A-5550 Air Filter Set..... A-5522-S Air Filter Secondary..... A-5510 Air Filter Primary..... A-5549M Air Filter Set..... A-5549M-S Air Filter Primary..... A-5549 Fuel Filter Secondary..... FC-5507 Hydraulic Oil Filter..... H-5503 Hydraulic Oil Filter..... H-5504 Oil Filter Full Flow..... O-5502 966C (LOADERS) S/N: 30K1401-UP Air Filter Set..... A-5549M-S Air Filter Secondary..... A-5550 Air Filter Primary..... A-5549M Air Filter Primary..... A-5509 Air Filter Secondary..... A-5510 Air Filter Primary..... A-5549 Air Filter Set..... A-5522-S Fuel Filter Secondary..... FC-5507 Hydraulic Oil Filter..... H-5504 Hydraulic Oil Filter..... H-5503 Oil Filter Full Flow..... C-5510	
966F SERIES II (LOADERS) S/N: 88G2000-2680 Air Filter Secondary..... A-5522 Air Filter Set..... A-5522-S Air Filter Primary..... A-5509 Fuel Filter..... F-5505 Fuel Filter Secondary..... FC-5507 Hydraulic Oil Filter..... H-5504 Hydraulic Oil Filter..... H-5506 Oil Filter Full Flow..... C-5510		966F SERIES II (LOADERS) S/N: 9YJ1-UP Air Filter Secondary..... A-5550 Air Filter Primary..... A-5549M Air Filter Set..... A-5549M-S Air Filter Primary..... A-5558 Air Filter Primary..... A-5549 Air Filter Secondary..... A-5559 Fuel Filter Secondary..... FC-5507 Fuel Filter..... F-5505 Hydraulic Oil Filter..... H-5506 Hydraulic Oil Filter..... H-55270 Hydraulic Oil Filter..... H-5504 Oil Filter Full Flow..... C-5510		966 (LOADERS) S/N: 25Z1-UP Air Filter Secondary..... A-5522 Air Filter Set..... A-5522-S Air Filter Primary..... A-5509 Fuel Filter..... FC-5523 Fuel Filter..... FC-5501 Fuel Filter..... F-5505 Hydraulic Oil Filter..... H-5506 Hydraulic Oil Filter..... H-5504 Oil Filter Full Flow..... C-5510	
966 (LOADERS) S/N: 35S1-UP Air Filter Set..... A-5522-S Air Filter Primary..... A-5509 Air Filter Secondary..... A-5522 Fuel Filter..... F-5505 Fuel Filter..... FC-5523 Fuel Filter..... FC-5501 Hydraulic Oil Filter..... H-5504 Hydraulic Oil Filter..... H-5506 Oil Filter Full Flow..... C-5510					

Sakura Filter

ENGINE APPLICATION

MODEL/APPLICATION	SAKURA NO	MODEL/APPLICATION	SAKURA NO	MODEL/APPLICATION	SAKURA NO
CATERPILLAR		CATERPILLAR		CATERPILLAR	
966C (LOADERS) S/N: 76J1-4836 Air Filter Secondary..... A-5559 Air Filter Secondary..... A-5520 Air Filter Primary..... A-5543 Air Filter Primary..... A-5558 Air Filter Set..... A-5544-S Fuel Filter Secondary..... FC-5507 Hydraulic Oil Filter..... H-5504 Hydraulic Oil Filter..... H-5503 Oil Filter Full Flow..... C-5510		Hydraulic Oil Filter..... H-5504 Hydraulic Oil Filter..... H-5503 Oil Filter Full Flow..... 0-5502 966C (LOADERS) S/N: TO-76J4836 Air Filter Secondary..... A-5559 Air Filter Primary..... A-5543 Air Filter Secondary..... A-5520 Air Filter Primary..... A-5558 Air Filter Set..... A-5544-S Fuel Filter..... F-5505 Fuel Filter Secondary..... FC-5507 Hydraulic Oil Filter..... H-5503 Hydraulic Oil Filter..... H-5504 Oil Filter Full Flow..... 0-5502 966C (LOADERS) w/3306 Eng. Hydraulic Oil Filter..... H-55320		966D (LOADERS) CAT (S/N: 1329002-20083) Fuel Filter Secondary..... FC-5507 966D (LOADERS) CAT S/N: 08Z47762-UP Fuel Filter Secondary..... FC-5507 Oil Filter Full Flow..... C-5510 966D (LOADERS) CAT S/N: 13Z20084-UP Fuel Filter Secondary..... FC-5507 Oil Filter Full Flow..... C-5510 966D (LOADERS) S/N: 35S1-UP Air Filter Set..... A-5522-S Air Filter Secondary..... A-5522 Air Filter Primary..... A-5509 Fuel Filter Secondary..... FC-5507 Fuel Filter..... F-5505 Hydraulic Oil Filter..... H-5506 Hydraulic Oil Filter..... H-5504 Hydraulic Oil Filter..... H-55270 Oil Filter Full Flow..... C-5510 966D (LOADERS) S/N: 94X1-6488 Air Filter Secondary..... A-5522 Air Filter Primary..... A-5509 Air Filter Set..... A-5522-S Fuel Filter Secondary..... FC-5507 Fuel Filter..... F-5505 Hydraulic Oil Filter..... H-5504 Hydraulic Oil Filter..... H-55270 Hydraulic Oil Filter..... H-5506 Oil Filter Full Flow..... C-5510 966D (LOADERS) S/N: 94X1-7031 Hydraulic Oil Filter..... H-5504 966D (LOADERS) S/N: 94X7032-UP Air Filter Set..... A-5549M-S Air Filter Primary..... A-5549M Air Filter Set..... A-5522-S Air Filter Secondary..... A-5550 Air Filter Primary..... A-5509 Air Filter Primary..... A-5549 Hydraulic Oil Filter..... H-55270 Hydraulic Oil Filter..... H-5504 966D (LOADERS) S/N: 99Y1-3801 Air Filter Primary..... A-5509 Air Filter Secondary..... A-5522 Air Filter Set..... A-5522-S Hydraulic Oil Filter..... H-55270 966D (LOADERS) S/N: 99Y1-5314 Air Filter Set..... A-5522-S Air Filter Primary..... A-5509	
966C (LOADERS) S/N: 76J4837-5269 Air Filter Primary..... A-5549 Air Filter Set..... A-5522-S Air Filter Secondary..... A-5510 Air Filter Secondary..... A-5550 Air Filter Set..... A-5549M-S Air Filter Primary..... A-5509 Air Filter Primary..... A-5549M Fuel Filter Secondary..... FC-5507 Hydraulic Oil Filter..... H-5503 Hydraulic Oil Filter..... H-5504 Oil Filter Full Flow..... C-5510		966D (LOADERS) CAT (Excluding S/N: 0) Fuel Filter..... FC-5523 Fuel Filter..... FC-5501 Oil Filter Full Flow..... C-5510 966D (LOADERS) CAT (S/N: 08Z1731-21156) Fuel Filter..... FC-5501 Fuel Filter..... FC-5523 Oil Filter Full Flow..... C-5510 Oil Filter Full Flow..... C-5522 966D (LOADERS) CAT (S/N: 08Z21157-26313) Fuel Filter..... FC-5501 Fuel Filter..... FC-5523 Oil Filter Full Flow..... C-5522 966D (LOADERS) CAT (S/N: 08Z26314-41501) Fuel Filter Secondary..... FC-5507 Oil Filter Full Flow..... C-5522		966D (LOADERS) S/N: 94X1-7031 Hydraulic Oil Filter..... H-5504 966D (LOADERS) S/N: 94X7032-UP Air Filter Set..... A-5549M-S Air Filter Primary..... A-5549M Air Filter Set..... A-5522-S Air Filter Secondary..... A-5550 Air Filter Primary..... A-5509 Air Filter Primary..... A-5549 Hydraulic Oil Filter..... H-55270 Hydraulic Oil Filter..... H-5504 966D (LOADERS) S/N: 99Y1-3801 Air Filter Primary..... A-5509 Air Filter Secondary..... A-5522 Air Filter Set..... A-5522-S Hydraulic Oil Filter..... H-55270 966D (LOADERS) S/N: 99Y1-5314 Air Filter Set..... A-5522-S Air Filter Primary..... A-5509	
966C (LOADERS) S/N: 76J5270-UP Air Filter Set..... A-5549M-S Air Filter Primary..... A-5549 Air Filter Primary..... A-5509 Air Filter Set..... A-5522-S Air Filter Primary..... A-5549M Air Filter Secondary..... A-5550 Air Filter Secondary..... A-5510 Fuel Filter Secondary..... FC-5507 Hydraulic Oil Filter..... H-5503 Hydraulic Oil Filter..... H-5504 Oil Filter Full Flow..... C-5510		966D (LOADERS) CAT (S/N: 08Z21157-26313) Fuel Filter..... FC-5501 Fuel Filter..... FC-5523 Oil Filter Full Flow..... C-5522 966D (LOADERS) CAT (S/N: 08Z26314-41501) Fuel Filter Secondary..... FC-5507 Oil Filter Full Flow..... C-5522		966D (LOADERS) S/N: 94X1-7031 Hydraulic Oil Filter..... H-5504 966D (LOADERS) S/N: 94X7032-UP Air Filter Set..... A-5549M-S Air Filter Primary..... A-5549M Air Filter Set..... A-5522-S Air Filter Secondary..... A-5550 Air Filter Primary..... A-5509 Air Filter Primary..... A-5549 Hydraulic Oil Filter..... H-55270 Hydraulic Oil Filter..... H-5504 966D (LOADERS) S/N: 99Y1-3801 Air Filter Primary..... A-5509 Air Filter Secondary..... A-5522 Air Filter Set..... A-5522-S Hydraulic Oil Filter..... H-55270 966D (LOADERS) S/N: 99Y1-5314 Air Filter Set..... A-5522-S Air Filter Primary..... A-5509	
966C (LOADERS) S/N: 9KC1-UP Air Filter Primary..... A-5509 Air Filter Set..... A-5522-S Air Filter Secondary..... A-5510 Fuel Filter Secondary..... FC-5507 Fuel Filter..... F-5505 Hydraulic Oil Filter..... H-5504 Hydraulic Oil Filter..... H-55270 Hydraulic Oil Filter..... H-55280 Hydraulic Oil Filter..... H-5503 Hydraulic Oil Filter..... H-5526 Oil Filter Full Flow..... C-5510		966D (LOADERS) CAT (S/N: 08Z41502-47761) Fuel Filter Secondary..... FC-5507 Oil Filter Full Flow..... C-5510 Oil Filter Full Flow..... C-5522 966D (LOADERS) CAT (S/N: 13Z1-6034) Oil Filter Full Flow..... C-5510 966D (LOADERS) CAT (S/N: 13Z6035-7247) Fuel Filter..... FC-5523 Fuel Filter..... FC-5501 Oil Filter Full Flow..... C-5510 966D (LOADERS) CAT (S/N: 13Z7248-9001) Fuel Filter..... FC-5501 Fuel Filter..... FC-5523		966D (LOADERS) S/N: 94X1-7031 Hydraulic Oil Filter..... H-5504 966D (LOADERS) S/N: 94X7032-UP Air Filter Set..... A-5549M-S Air Filter Primary..... A-5549M Air Filter Set..... A-5522-S Air Filter Secondary..... A-5550 Air Filter Primary..... A-5509 Air Filter Primary..... A-5549 Hydraulic Oil Filter..... H-55270 Hydraulic Oil Filter..... H-5504 966D (LOADERS) S/N: 99Y1-3801 Air Filter Primary..... A-5509 Air Filter Secondary..... A-5522 Air Filter Set..... A-5522-S Hydraulic Oil Filter..... H-55270 966D (LOADERS) S/N: 99Y1-5314 Air Filter Set..... A-5522-S Air Filter Primary..... A-5509	
966C (LOADERS) S/N: TO-30K1337 Air Filter Primary..... A-5543 Air Filter Secondary..... A-5559 Air Filter Primary..... A-5558 Air Filter Set..... A-5544-S Air Filter Secondary..... A-5520 Fuel Filter..... F-5505 Fuel Filter Secondary..... FC-5507		966D (LOADERS) CAT (S/N: 13Z7248-9001) Fuel Filter..... FC-5501 Fuel Filter..... FC-5523		966D (LOADERS) S/N: 94X1-7031 Hydraulic Oil Filter..... H-5504 966D (LOADERS) S/N: 94X7032-UP Air Filter Set..... A-5549M-S Air Filter Primary..... A-5549M Air Filter Set..... A-5522-S Air Filter Secondary..... A-5550 Air Filter Primary..... A-5509 Air Filter Primary..... A-5549 Hydraulic Oil Filter..... H-55270 Hydraulic Oil Filter..... H-5504 966D (LOADERS) S/N: 99Y1-3801 Air Filter Primary..... A-5509 Air Filter Secondary..... A-5522 Air Filter Set..... A-5522-S Hydraulic Oil Filter..... H-55270 966D (LOADERS) S/N: 99Y1-5314 Air Filter Set..... A-5522-S Air Filter Primary..... A-5509	

Sakura Filter

ENGINE APPLICATION

MODEL/APPLICATION	SAKURA NO	MODEL/APPLICATION	SAKURA NO	MODEL/APPLICATION	SAKURA NO
CATERPILLAR		CATERPILLAR		CATERPILLAR	
966D (LOADERS) S/N: 99Y1-5314		966F (LOADERS) CAT S/N: 08Z57583-68824		Oil Filter Full Flow	C-5510
Air Filter Secondary.....	A-5522	Fuel Filter Secondary.....	FC-5507	966F (LOADERS) S/N: 9YJ1-1984	
Fuel Filter Secondary.....	FC-5507	Oil Filter Full Flow.....	C-5510	Air Filter Secondary.....	A-5550
Fuel Filter.....	F-5505	966F (LOADERS) CAT S/N: 13Z22389-28099		Air Filter Set.....	A-5549M-S
Hydraulic Oil Filter.....	H-5504	Fuel Filter Secondary.....	FC-5507	Air Filter Primary.....	A-5549
Hydraulic Oil Filter.....	H-5506	Oil Filter Full Flow.....	C-5510	Air Filter Primary.....	A-5549M
Hydraulic Oil Filter.....	H-55270	966F (LOADERS) S/N: 15L1-1664		Fuel Filter.....	F-5505
Oil Filter Full Flow.....	C-5510	Air Filter Set.....	A-5549M-S	Hydraulic Oil Filter.....	H-5504
966D (LOADERS) S/N: 99Y3802-UP		Air Filter Primary.....	A-5549M	Hydraulic Oil Filter.....	H-5506
Air Filter Set.....	A-5522-S	Air Filter Secondary.....	A-5550	Oil Filter Full Flow.....	C-5510
Air Filter Primary.....	A-5509	Air Filter Primary.....	A-5549	966G (LOADERS) 08Z1-ON	
Air Filter Secondary.....	A-5522	Cabin Air Filter.....	CA-55070	Oil Filter Full Flow.....	C-5506
Hydraulic Oil Filter.....	H-55270	Hydraulic Oil Filter.....	H-5506	966G (LOADERS) CAT (S/N: 6NC1-UP)	
966D (LOADERS) S/N: 99Y3803-UP		Hydraulic Oil Filter.....	H-55270	Fuel Filter.....	FC-5509
Air Filter Secondary.....	A-5522	966F (LOADERS) S/N: 15L1-506		Fuel Filter Secondary.....	FC-5507
Air Filter Primary.....	A-5509	Air Filter Secondary.....	A-5550	Oil Filter Full Flow.....	C-5522
Air Filter Set.....	A-5522-S	Air Filter Primary.....	A-5549	Oil Filter Full Flow.....	C-5516
Hydraulic Oil Filter.....	H-55270	Air Filter Primary.....	A-5549M	966G (LOADERS) CAT 3306 (S/N: 3PW1-UP)	
966D (LOADERS) w/3306 Eng.		Air Filter Set.....	A-5549M-S	Air Filter Secondary.....	A-5559
Hydraulic Oil Filter.....	H-55320	Fuel Filter.....	F-5505	Air Filter Primary.....	A-5558
966E (LOADERS) w/3306 Eng.		Fuel Filter Secondary.....	FC-5507	Fuel Filter Secondary.....	FC-5507
Hydraulic Oil Filter.....	H-55320	Hydraulic Oil Filter.....	H-5504	Fuel Filter.....	F-5505
966F (LOADERS) S/N: 3XJ01192-UP , 1993		Hydraulic Oil Filter.....	H-5506	Hydraulic Oil Filter.....	HC-5504
Air Filter Set.....	A-5522-S	Hydraulic Oil Filter.....	H-55270	Hydraulic Oil Filter.....	H-5504
Air Filter Primary.....	A-5509	Oil Filter Full Flow.....	C-5510	Oil Filter Full Flow.....	C-5510
Air Filter Secondary.....	A-5522	966F (LOADERS) S/N: 4YG1-UP		966G (LOADERS) CAT 3306 (S/N: 3SW1-UP)	
Hydraulic Oil Filter.....	H-5504	Air Filter Set.....	A-5522-S	Air Filter Secondary.....	A-5559
Hydraulic Oil Filter.....	H-5506	Air Filter Primary.....	A-5549M	Air Filter Primary.....	A-5558
Hydraulic Oil Filter.....	HC-5505	Air Filter Secondary.....	A-5550	Fuel Filter Secondary.....	FC-5507
Oil Filter Full Flow.....	C-5510	Air Filter Secondary.....	A-5522	Fuel Filter.....	F-5505
966F (LOADERS) CAT (S/N: 08Z68825-73069)		Air Filter Primary.....	A-5549	Hydraulic Oil Filter.....	HC-5504
Fuel Filter Secondary.....	FC-5507	Air Filter Primary.....	A-5509	Hydraulic Oil Filter.....	H-5504
Fuel Filter.....	FC-5509	Air Filter Set.....	A-5549M-S	Oil Filter Full Flow.....	C-5510
Oil Filter Full Flow.....	C-5510	Fuel Filter Secondary.....	FC-5507	966G (LOADERS) CAT 3306 (S/N: 3ZS1-UP)	
966F (LOADERS) CAT (S/N: 08Z73070-UP)		Fuel Filter.....	F-5505	Air Filter Secondary.....	A-5559
Fuel Filter.....	FC-5509	Hydraulic Oil Filter.....	H-55270	Air Filter Primary.....	A-5558
Fuel Filter Secondary.....	FC-5507	Hydraulic Oil Filter.....	H-5506	Fuel Filter.....	F-5505
Oil Filter Full Flow.....	C-5510	Hydraulic Oil Filter.....	H-5504	Hydraulic Oil Filter.....	HC-5504
Oil Filter Full Flow.....	C-5522	Oil Filter Full Flow.....	C-5510	Hydraulic Oil Filter.....	H-5504
966F (LOADERS) CAT (S/N: 13Z28100-30333)		966F (LOADERS) S/N: 8BG1-UP		Oil Filter Full Flow.....	C-5510
Fuel Filter Secondary.....	FC-5507	Air Filter Secondary.....	A-5550	966G (LOADERS) CAT 3306 (S/N: 8XW1-346-UP)	
Oil Filter Full Flow.....	C-5510	Air Filter Secondary.....	A-5522	Air Filter Secondary.....	A-5559
Oil Filter Full Flow.....	C-5522	Air Filter Set.....	A-5522-S	Air Filter Primary.....	A-5558
966F (LOADERS) CAT (S/N: 13Z30334-UP)		Air Filter Set.....	A-5549M-S	Fuel Filter Secondary.....	FC-5507
Fuel Filter Secondary.....	FC-5507	Air Filter Primary.....	A-5549	Fuel Filter.....	F-5505
Oil Filter Full Flow.....	C-5510	Air Filter Primary.....	A-5509	Hydraulic Oil Filter.....	H-5504
Oil Filter Full Flow.....	C-5522	Air Filter Primary.....	A-5549M	Hydraulic Oil Filter.....	HC-5504
966F (LOADERS) CAT (S/N: 13Z30334-UP)		Fuel Filter.....	F-5505	Oil Filter Full Flow.....	C-5510
Fuel Filter Secondary.....	FC-5507	Fuel Filter.....	FC-5523	966G (LOADERS) CAT 3306 (S/N: 8XW347-UP)	
Oil Filter Full Flow.....	C-5510	Fuel Filter.....	FC-5501	Air Filter Secondary.....	A-5559
966F (LOADERS) CAT (S/N: 13Z30334-UP)		Hydraulic Oil Filter.....	H-5504	Air Filter Primary.....	A-5558
Fuel Filter Secondary.....	FC-5507	Hydraulic Oil Filter.....	H-5506	Fuel Filter Secondary.....	FC-5507
Oil Filter Full Flow.....	C-5510			Fuel Filter.....	F-5505

MODEL/APPLICATION	SAKURA NO	MODEL/APPLICATION	SAKURA NO	MODEL/APPLICATION	SAKURA NO
CATERPILLAR		CATERPILLAR		CATERPILLAR	
966G (LOADERS) CAT 3306 (S/N: 8XW347-UP) Air Filter Primary..... A-5558 Air Filter Secondary..... A-5559 Fuel Filter..... F-5505 Fuel Filter Secondary..... FC-5507 Hydraulic Oil Filter..... HC-5504 Hydraulic Oil Filter..... H-5504 Oil Filter Full Flow..... C-5510		966G (LOADERS) S/N: 3Z5791-UP Air Filter..... A-5584 Hydraulic Oil Filter..... H-55270 Hydraulic Oil Filter..... HC-5504 966G (LOADERS) S/N: 9R51-1631 Air Filter Secondary..... A-5559 Air Filter..... A-5584 Air Filter Primary..... A-5558 Hydraulic Oil Filter..... HC-5505 Hydraulic Oil Filter..... HC-5504 Hydraulic Oil Filter..... H-55270 Hydraulic Oil Filter..... HC-55170 966G (LOADERS) S/N: 9R51632-UP Air Filter..... A-5584 Air Filter Primary..... A-5558 Air Filter Secondary..... A-5559 Hydraulic Oil Filter..... HC-5504 Hydraulic Oil Filter..... H-55270 Hydraulic Oil Filter..... H-55270 966G (LOADERS) S/N: HDH1-28 Air Filter..... A-5584 Air Filter Primary..... A-5558 Air Filter Secondary..... A-5559 Hydraulic Oil Filter..... H-55270 Hydraulic Oil Filter..... HC-5504 966G (LOADERS) S/N: HDH29-UP Air Filter..... A-5584 Hydraulic Oil Filter..... HC-5504 Hydraulic Oil Filter..... H-55270 966H (LOADERS) CAT C11 ATAAC , 2006-UP Air Filter Secondary..... A-8103 Cabin Air Filter..... CA-55070 Fuel Filter..... FC-5517 966H (LOADERS) CAT S/N: A6D1-UP Air Filter Secondary..... A-8103 Cabin Air Filter..... CA-55070 Fuel Filter..... FC-5517 966H (LOADERS) CAT S/N: A6G1-UP Air Filter Secondary..... A-8103 Cabin Air Filter..... CA-55070 Fuel Filter..... FC-5517 966H (LOADERS) CAT S/N: RSX1-UP Air Filter Secondary..... A-8103 Cabin Air Filter..... CA-55070 Fuel Filter..... FC-5517 966H (LOADERS) w/C11 Eng. Hydraulic Oil Filter..... HC-55280		966A (LOADERS) S/N: 33A1-UP Air Filter Secondary..... A-5550 Air Filter Primary..... A-5549 Air Filter Secondary..... A-5510 Air Filter Set..... A-5549M-S Air Filter Primary..... A-5509 Air Filter Primary..... A-5549M Air Filter Set..... A-5522-S Fuel Filter..... F-5501 Hydraulic Oil Filter..... H-5503 Oil Filter Full Flow..... O-5502 966A (LOADERS) S/N: 75A1-UP Air Filter Set..... A-5549M-S Air Filter Primary..... A-5549M Air Filter Secondary..... A-5550 Air Filter Set..... A-5522-S Air Filter Primary..... A-5549 Air Filter Secondary..... A-5510 Air Filter Primary..... A-5509 Fuel Filter..... F-5501 Hydraulic Oil Filter..... H-5503 Oil Filter Full Flow..... O-5502 966G SERIES II (LOADERS) CAT (S/N: 3PD1-215) Fuel Filter..... FC-5517 Oil Filter Full Flow..... C-5516 966G SERIES II (LOADERS) CAT (S/N: 3PD216-UP) Fuel Filter..... FC-5517 Oil Filter Full Flow..... C-5516 966G SERIES II (LOADERS) CAT 3176C ATAAC EUI (S/N: AXJ1-UP) Air Filter Secondary..... A-5556 Air Filter Primary..... A-5555 Air Filter Set..... A-5555-S Fuel Filter..... FC-5517 Hydraulic Oil Filter..... H-5504 Hydraulic Oil Filter..... HC-5504 Hydraulic Oil Filter..... H-55270 Oil Filter Full Flow..... C-5516 966G SERIES II (LOADERS) CAT S/N: ANT1-UP Air Filter Secondary..... A-5556 Air Filter Set..... A-5555-S Air Filter Primary..... A-5555 Cabin Air Filter..... CA-55070 Hydraulic Oil Filter..... H-55270 Hydraulic Oil Filter..... HC-5504 966G SERIES II (LOADERS) CAT S/N: ANZ1-UP Air Filter Primary..... A-5555 Air Filter Secondary..... A-5556 Air Filter Set..... A-5555-S Cabin Air Filter..... CA-55070 Hydraulic Oil Filter..... H-55270 Hydraulic Oil Filter..... HC-5504	
966G (LOADERS) CAT 3306 (S/N: 9R51-UP) Air Filter Secondary..... A-5559 Air Filter Primary..... A-5558 Fuel Filter Secondary..... FC-5507 Fuel Filter..... F-5505 Hydraulic Oil Filter..... HC-5504 Hydraulic Oil Filter..... H-5504 Hydraulic Oil Filter..... HC-5505 Oil Filter Full Flow..... C-5510		966G (LOADERS) CAT 3306 (S/N: AAH1-UP) Air Filter Secondary..... A-5559 Air Filter Primary..... A-5558 Fuel Filter..... F-5505 Fuel Filter Secondary..... FC-5507 Hydraulic Oil Filter..... H-5504 Hydraulic Oil Filter..... HC-5504 Oil Filter Full Flow..... C-5510		966G (LOADERS) CAT 3306 (S/N: HDH1-UP) Air Filter Secondary..... A-5559 Air Filter Primary..... A-5558 Fuel Filter Secondary..... FC-5507 Fuel Filter..... F-5505 Hydraulic Oil Filter..... H-5504 Hydraulic Oil Filter..... HC-5504 Oil Filter Full Flow..... C-5510	
966G (LOADERS) S/N: 35W1-1689 Air Filter Primary..... A-5558 Air Filter Secondary..... A-5559 Air Filter..... A-5584 Hydraulic Oil Filter..... HC-5504 Hydraulic Oil Filter..... H-55270		966G (LOADERS) S/N: 35W1690-UP Air Filter..... A-5584 Hydraulic Oil Filter..... H-55270 Hydraulic Oil Filter..... HC-5504		966G (LOADERS) S/N: 3Z51-790 Air Filter Secondary..... A-5559 Air Filter..... A-5584 Air Filter Primary..... A-5558 Hydraulic Oil Filter..... H-55270 Hydraulic Oil Filter..... HC-5504	

MODEL/APPLICATION	SAKURA NO	MODEL/APPLICATION	SAKURA NO	MODEL/APPLICATION	SAKURA NO
CATERPILLAR		CATERPILLAR		CATERPILLAR	
966G SERIES II (LOADERS) S/N: AMY1-UP Air Filter Secondary..... A-5556 Air Filter Primary..... A-5555 Air Filter Set..... A-5555-S Cabin Air Filter..... CA-55070 Hydraulic Oil Filter..... HC-5504 Hydraulic Oil Filter..... HC-5505 Hydraulic Oil Filter..... H-55270 Hydraulic Oil Filter..... HC-55170		Fuel Filter Secondary..... FC-5507 Oil Filter Full Flow..... C-5522 Oil Filter Full Flow..... C-5510 970F (LOADERS) CAT S/N: 13Z28100-UP Fuel Filter Secondary..... FC-5507 Oil Filter Full Flow..... C-5522 Oil Filter Full Flow..... C-5510 970F (LOADERS) S/N: 9JK1-491 Air Filter Primary..... A-5558 Air Filter Secondary..... A-5559 Cabin Air Filter..... CA-55070 Hydraulic Oil Filter..... H-5506 Hydraulic Oil Filter..... H-5504 Hydraulic Oil Filter..... H-55270 970F (LOADERS) S/N: 9JK492-UP Air Filter Secondary..... A-5559 Air Filter Primary..... A-5558 Cabin Air Filter..... CA-55070 Hydraulic Oil Filter..... H-5504 Hydraulic Oil Filter..... H-5506 Hydraulic Oil Filter..... H-55270 972G (LOADERS) CAT (S/N: 13Z1-UP) Fuel Filter Secondary..... FC-5507 972G (LOADERS) CAT (S/N: 6NC1-UP) Fuel Filter..... FC-5509 Oil Filter Full Flow..... C-5516 Oil Filter Full Flow..... C-5522 970F (LOADERS) CAT 3196 ATAAC-EUI (S/N: 7PL1-UP) Air Filter Primary..... A-5558 Air Filter Secondary..... A-5559 Fuel Filter Secondary..... FC-5507 Fuel Filter..... F-5505 Hydraulic Oil Filter..... HC-5504 Hydraulic Oil Filter..... H-5504 Hydraulic Oil Filter..... H-55270 Oil Filter Full Flow..... C-5510 970F (LOADERS) CAT 3196 ATAAC-EUI (S/N: 7SK1-UP) Air Filter Secondary..... A-5559 Air Filter Primary..... A-5558 Fuel Filter..... F-5505 Fuel Filter Secondary..... FC-5507 Hydraulic Oil Filter..... HC-5504 Hydraulic Oil Filter..... H-55270 Hydraulic Oil Filter..... H-5504 Oil Filter Full Flow..... C-5510 970F (LOADERS) CAT 3196 ATAAC-EUI (S/N: 9JK1-UP) Air Filter Secondary..... A-5559 Air Filter Primary..... A-5558 Fuel Filter Secondary..... FC-5507 Fuel Filter..... F-5505 Hydraulic Oil Filter..... H-55270 Hydraulic Oil Filter..... HC-5504 Hydraulic Oil Filter..... H-5504 Oil Filter Full Flow..... C-5510 970F (LOADERS) CAT S/N: 08Z70280-UP		972H (LOADERS) CAT S/N: A7D1-UP , 2006-UP Air Filter Secondary..... A-8103 Cabin Air Filter..... CA-55070 Fuel Filter..... FC-5510 Fuel Filter..... FC-5517 972H (LOADERS) CAT S/N: A7G1-UP , 2006-UP Air Filter Secondary..... A-8103 Cabin Air Filter..... CA-55070 Fuel Filter..... FC-5517 Fuel Filter..... FC-5510 972H (LOADERS) CAT S/N: MHX1-UP , 2006-UP Air Filter Secondary..... A-8103 Cabin Air Filter..... CA-55070 Fuel Filter..... FC-5517 Fuel Filter..... FC-5510 972H (LOADERS) w/C13 Eng. Hydraulic Oil Filter..... HC-55280 972E (PIPE LAYERS) S/N: 65A1-UP Air Filter Primary..... A-5514 Air Filter Set..... A-5514-S Fuel Filter..... F-5501 Hydraulic Oil Filter..... H-5504 Oil Filter Full Flow..... O-5503 972G SERIES II (LOADERS) CAT (S/N: 5ED1-UP) Fuel Filter..... FC-5517 Oil Filter Full Flow..... C-5516 972G SERIES II (LOADERS) CAT 3196 ATAAC-EUI (S/N: AX1-UP) Air Filter Secondary..... A-5556 Air Filter Primary..... A-5555 Air Filter Set..... A-5555-S Fuel Filter..... FC-5517 Hydraulic Oil Filter..... HC-5504 Hydraulic Oil Filter..... HC-5505 Hydraulic Oil Filter..... H-55270 Hydraulic Oil Filter..... HC-55170 Hydraulic Oil Filter..... H-5504 Oil Filter Full Flow..... C-5516 972G SERIES II (LOADERS) CAT 3196 ATAAC-EUI (S/N: AXN1-UP) Air Filter Primary..... A-5555 Air Filter Secondary..... A-5556 Air Filter Set..... A-5555-S Fuel Filter..... FC-5517 Hydraulic Oil Filter..... H-55270 Hydraulic Oil Filter..... HC-5504 Hydraulic Oil Filter..... H-5504 Oil Filter Full Flow..... C-5516 972G SERIES II (LOADERS) S/N: ANY1-UP Air Filter Primary..... A-5555	

Sakura Filter

ENGINE APPLICATION

MODEL/APPLICATION	SAKURA NO	MODEL/APPLICATION	SAKURA NO	MODEL/APPLICATION	SAKURA NO
CATERPILLAR		CATERPILLAR		CATERPILLAR	
972G SERIES II (LOADERS) S/N: ANY1-UP Air Filter Secondary..... A-5556 Air Filter Set..... A-5555-S Cabin Air Filter..... CA-55070 Hydraulic Oil Filter..... HC-5504 Hydraulic Oil Filter..... H-55270		973C (LOADERS) CAT (S/N: 4ZF1-UP) Fuel Filter..... FC-5517 973C (LOADERS) CAT (S/N: SAN221-UP) Fuel Filter..... FC-5517 973C (LOADERS) CAT (S/N: THY1-UP) Fuel Filter..... FC-5517 973C (LOADERS) S/N: 3RZ1-639-UP Air Filter Secondary..... A-5534 Air Filter Set..... A-5573-S Air Filter Primary..... A-5535 Hydraulic Oil Filter..... HC-5503 Hydraulic Oil Filter..... HC-5506 Hydraulic Oil Filter..... H-5506 Hydraulic Oil Filter..... HC-5512 973C (LOADERS) S/N: 3RZ640-UP Air Filter Secondary..... A-5534 Air Filter Set..... A-5573-S Air Filter Primary..... A-5535 Hydraulic Oil Filter..... HC-5503 Hydraulic Oil Filter..... HC-5506 Hydraulic Oil Filter..... H-5506 Hydraulic Oil Filter..... HC-5512 973C (LOADERS) S/N: BCP1-UP Air Filter Secondary..... A-5534 Air Filter Set..... A-5573-S Air Filter Primary..... A-5535 Hydraulic Oil Filter..... H-5506 Hydraulic Oil Filter..... HC-5506 Hydraulic Oil Filter..... HC-5512 Hydraulic Oil Filter..... HC-5503 973C (LOADERS) S/N: LDX1-278-UP Air Filter Secondary..... A-5556 Air Filter Primary..... A-5555 Air Filter Set..... A-5555-S Hydraulic Oil Filter..... H-5506 973C (LOADERS) S/N: LDX279-UP Air Filter Secondary..... A-5556 Air Filter Primary..... A-5555 Air Filter Set..... A-5555-S Hydraulic Oil Filter..... H-5506 973C (LOADERS) w/3306 Eng. Air Filter Primary..... A-5535M Air Filter Set..... A-5573M-S 973C (LOADERS) w/C9 Eng. Air Filter Set..... A-5573M-S Air Filter Primary..... A-5535M Hydraulic Oil Filter..... HC-55280		973 LGP (LOADERS) S/N: 86G1-UP Air Filter Primary..... A-5535 Air Filter Set..... A-5573-S Air Filter Secondary..... A-5502 Air Filter Secondary..... A-5534 Air Filter Primary..... A-5501 Fuel Filter Secondary..... FC-5507 Hydraulic Oil Filter..... H-5506 Hydraulic Oil Filter..... H-5503 Oil Filter Full Flow..... C-5510 973C WH (LOADERS) w/C9 Eng. Air Filter Primary..... A-5535M Air Filter Set..... A-5573M-S Hydraulic Oil Filter..... HC-55280 977 (LOADERS) S/N: 10A1-826 Air Filter Set..... A-5507-S Air Filter Secondary..... A-5508 Air Filter Primary..... A-5507 Air Filter Set..... A-55071-S Oil Filter Full Flow..... O-5501 977 (LOADERS) S/N: 10A827-UP Air Filter Secondary..... A-5508 Air Filter Set..... A-55071-S Air Filter Set..... A-5507-S Air Filter Primary..... A-5507 Oil Filter Full Flow..... O-5501 Oil Filter Full Flow..... O-5503 977 (LOADERS) S/N: 14X1-806 Air Filter Secondary..... A-5520 Air Filter Primary..... A-5543 Air Filter Set..... A-5544-S Air Filter Primary..... A-5558 Air Filter Secondary..... A-5559 Fuel Filter Secondary..... FC-5507 Hydraulic Oil Filter..... H-5503 Hydraulic Oil Filter..... H-5506 Oil Filter Full Flow..... C-5510 977 (LOADERS) S/N: 14X807-UP Air Filter Primary..... A-5543 Air Filter Secondary..... A-5520 Air Filter Set..... A-5544-S Hydraulic Oil Filter..... H-5503 Hydraulic Oil Filter..... H-5506 Oil Filter Full Flow..... C-5510 977 (LOADERS) S/N: 20A-20A Air Filter Secondary..... A-5508 Air Filter Set..... A-55071-S Air Filter Set..... A-5507-S Air Filter Primary..... A-5507 Hydraulic Oil Filter..... H-5503 Oil Filter Full Flow..... O-5501	
972G SERIES II (LOADERS) S/N: AWP1-UP Air Filter Secondary..... A-5556 Air Filter Primary..... A-5555 Air Filter Set..... A-5555-S Cabin Air Filter..... CA-55070 Hydraulic Oil Filter..... H-55270 Hydraulic Oil Filter..... HC-5504					
973 (LOADERS) S/N: 26Z1-UP Fuel Filter Secondary..... FC-5507 Hydraulic Oil Filter..... H-55280 Hydraulic Oil Filter..... H-5506 Oil Filter Full Flow..... C-5510					
973 (LOADERS) S/N: 32Z1-UP Air Filter Primary..... A-5535 Air Filter Set..... A-5573-S Air Filter Secondary..... A-5534 Air Filter Primary..... A-5501 Air Filter Secondary..... A-5502 Fuel Filter Secondary..... FC-5507 Hydraulic Oil Filter..... H-55280 Hydraulic Oil Filter..... H-5506 Oil Filter Full Flow..... C-5510					
973 (LOADERS) S/N: 86G1-UP Air Filter Secondary..... A-5502 Air Filter Secondary..... A-5534 Air Filter Primary..... A-5501 Air Filter Set..... A-5573-S Air Filter Primary..... A-5535 Fuel Filter Secondary..... FC-5507 Hydraulic Oil Filter..... H-55280 Hydraulic Oil Filter..... H-5506 Oil Filter Full Flow..... C-5510					
973 (LOADERS) S/N: 91L1-UP Air Filter Secondary..... A-5502 Air Filter Set..... A-5573-S Air Filter Primary..... A-5501 Air Filter Secondary..... A-5534 Air Filter Primary..... A-5535 Hydraulic Oil Filter..... H-5503 Hydraulic Oil Filter..... H-5506 Oil Filter Full Flow..... C-5510					
973 (LOADERS) w/3306 Eng. Air Filter Set..... A-5573M-S Air Filter Primary..... A-5535M					

Sakura Filter

ENGINE APPLICATION

MODEL/APPLICATION	SAKURA NO	MODEL/APPLICATION	SAKURA NO	MODEL/APPLICATION	SAKURA NO
CATERPILLAR		CATERPILLAR		CATERPILLAR	
977K (LOADERS) S/N: 53A1-UP Fuel Filter..... F-5501 Hydraulic Oil Filter..... H-5503 Oil Filter Full Flow..... 0-5502		Air Filter Set..... A-5549M-S Fuel Filter..... F-5501 Hydraulic Oil Filter..... H-5504 Hydraulic Oil Filter..... H-5503 Oil Filter Full Flow..... 0-5502		980B (LOADERS) S/N: 89P4784-UP Air Filter Secondary..... A-5502 Air Filter Set..... A-5573-S Air Filter Primary..... A-5535 Air Filter Primary..... A-5501 Air Filter Secondary..... A-5534 Fuel Filter Secondary..... FC-5507 Hydraulic Oil Filter..... H-5503 Hydraulic Oil Filter..... H-5504 Oil Filter Full Flow..... C-5510	
977K (LOADERS) S/N: 11K1-3918 Air Filter Primary..... A-5543 Air Filter Primary..... A-5558 Air Filter Secondary..... A-5520 Air Filter Secondary..... A-5559 Air Filter Set..... A-5544-S Fuel Filter Secondary..... FC-5507 Hydraulic Oil Filter..... H-5503 Oil Filter Full Flow..... 0-5502		980B (LOADERS) CAT 3306 Air Filter Primary..... A-44150 Air Filter Set..... A-44150-S		980B (LOADERS) S/N: 89P1539-EXC 89P1539 Air Filter Secondary..... A-5550 Air Filter Primary..... A-5549M Air Filter Set..... A-5522-S Air Filter Primary..... A-5549 Air Filter Primary..... A-5509 Air Filter Secondary..... A-5510 Air Filter Set..... A-5549M-S Fuel Filter Secondary..... FC-5507 Hydraulic Oil Filter..... H-5503 Hydraulic Oil Filter..... H-5504 Oil Filter Full Flow..... C-5510	
977K (LOADERS) S/N: 46H1-UP Air Filter Primary..... A-5543 Air Filter Secondary..... A-5559 Air Filter Secondary..... A-5520 Air Filter Set..... A-5544-S Air Filter Primary..... A-5558 Fuel Filter..... F-5501 Hydraulic Oil Filter..... H-5503 Oil Filter Full Flow..... 0-5502		980B (LOADERS) S/N: 89P1530-1878 Air Filter Set..... A-5549M-S Air Filter Secondary..... A-5550 Air Filter Secondary..... A-5510 Air Filter Set..... A-5522-S Air Filter Primary..... A-5509 Air Filter Primary..... A-5549 Air Filter Primary..... A-5549M Fuel Filter Secondary..... FC-5507 Hydraulic Oil Filter..... H-5504 Hydraulic Oil Filter..... H-5503 Oil Filter Full Flow..... C-5510		980C (LOADERS) CAT 3406 Air Filter Primary..... A-44150 Air Filter Set..... A-44150-S	
977L (LOADERS) S/N: 11K3919-4070 Fuel Filter Secondary..... FC-5507 Oil Filter Full Flow..... C-5510		980B (LOADERS) S/N: 89P1539-UP Air Filter Set..... A-5549M-S Air Filter Primary..... A-5509 Air Filter Primary..... A-5549 Air Filter Primary..... A-5549M Fuel Filter Secondary..... FC-5507 Hydraulic Oil Filter..... H-5504 Hydraulic Oil Filter..... H-5503 Oil Filter Full Flow..... C-5510		980C (LOADERS) CAT (S/N: 11N1-UP) Fuel Filter..... FC-5509 Fuel Filter..... FC-5519	
977L (LOADERS) S/N: 11K4071-UP Air Filter Primary..... A-5558 Air Filter Set..... A-5544-S Air Filter Primary..... A-5543 Air Filter Secondary..... A-5559 Air Filter Secondary..... A-5520 Fuel Filter Secondary..... FC-5507 Hydraulic Oil Filter..... H-5503 Oil Filter Full Flow..... C-5510		980B (LOADERS) S/N: 89P1539-UP Air Filter Set..... A-5549M-S Air Filter Primary..... A-5509 Air Filter Primary..... A-5549 Air Filter Set..... A-5522-S Air Filter Secondary..... A-5550 Air Filter Primary..... A-5549M Air Filter Secondary..... A-5510 Fuel Filter Secondary..... FC-5507 Hydraulic Oil Filter..... H-5504 Hydraulic Oil Filter..... H-5503 Oil Filter Full Flow..... C-5510		980C (LOADERS) CAT (S/N: 70V14539-16375) Fuel Filter..... FC-5509	
977L (LOADERS) S/N: 95X1-UP Air Filter Primary..... A-5558 Air Filter Set..... A-5544-S Air Filter Secondary..... A-5520 Air Filter Primary..... A-5543 Air Filter Secondary..... A-5559 Fuel Filter Secondary..... FC-5507 Hydraulic Oil Filter..... H-5503 Hydraulic Oil Filter..... H-5506 Oil Filter Full Flow..... C-5510		980B (LOADERS) S/N: 89P1879-4783 Air Filter Secondary..... A-5534 Air Filter Secondary..... A-5502 Air Filter Primary..... A-5535 Air Filter Set..... A-5573-S Air Filter Primary..... A-5501 Fuel Filter Secondary..... FC-5507 Hydraulic Oil Filter..... H-5503 Hydraulic Oil Filter..... H-5504 Oil Filter Full Flow..... C-5510		980C (LOADERS) S/N: 70V16376-UP Fuel Filter..... FC-5509	
980 (LOADERS) S/N: 42H1-UP Air Filter Secondary..... A-5510 Air Filter Primary..... A-5549 Air Filter Primary..... A-5509 Air Filter Set..... A-5522-S Air Filter Primary..... A-5549M Air Filter Secondary..... A-5550		980C (LOADERS) S/N: 2EB1-UP Fuel Filter..... FC-5509 Hydraulic Oil Filter..... H-5504 Hydraulic Oil Filter..... H-5506 Oil Filter Full Flow..... C-5510		980C (LOADERS) S/N: 13B300-UP Air Filter Primary..... A-5501 Air Filter Secondary..... A-5502 Fuel Filter..... F-5505 Fuel Filter..... FC-5509 Hydraulic Oil Filter..... H-5504 Hydraulic Oil Filter..... H-5506 Oil Filter Full Flow..... C-5510	
		980C (LOADERS) S/N: 2XD1-UP Air Filter Primary..... A-5501 Air Filter Secondary..... A-5502			

MODEL/APPLICATION	SAKURA NO	MODEL/APPLICATION	SAKURA NO	MODEL/APPLICATION	SAKURA NO
CATERPILLAR		CATERPILLAR		CATERPILLAR	
980C (LOADERS) S/N: 2XD1-UP		Air Filter Secondary.....	A-5502	Air Filter Set.....	A-5573-S
Fuel Filter.....	F-5505	Air Filter Primary.....	A-5501	Air Filter Secondary.....	A-5534
Fuel Filter.....	FC-5509	Hydraulic Oil Filter.....	H-55270	Air Filter Primary.....	A-5501
Hydraulic Oil Filter.....	H-5504	Hydraulic Oil Filter.....	H-5504	Fuel Filter.....	F-5505
Hydraulic Oil Filter.....	H-5506	Hydraulic Oil Filter.....	H-5506	Fuel Filter.....	FC-5509
Hydraulic Oil Filter.....	H-55270			Hydraulic Oil Filter.....	H-5504
Oil Filter Full Flow.....	C-5516	980C (LOADERS) S/N: 63X6549-6574		Hydraulic Oil Filter.....	H-55270
		Air Filter Secondary.....	A-5502	Hydraulic Oil Filter.....	H-5506
		Air Filter Primary.....	A-5501	Oil Filter Full Flow.....	C-5516
		Hydraulic Oil Filter.....	H-5506		
980C (LOADERS) S/N: 5XJ1-UP		980C (LOADERS) S/N: 63X6575-8791		980F (LOADERS) S/N: 3HK721-UP	
Air Filter Secondary.....	A-5502	Air Filter Primary.....	A-5501	Air Filter Set.....	A-5573-S
Air Filter Primary.....	A-5501	Hydraulic Oil Filter.....	H-5506	Air Filter Secondary.....	A-5534
Fuel Filter.....	F-5505	Air Filter Secondary.....	A-5502	Air Filter Primary.....	A-5535
Fuel Filter.....	FC-5509	Hydraulic Oil Filter.....	H-55270	Hydraulic Oil Filter.....	H-55270
Hydraulic Oil Filter.....	H-5504	Hydraulic Oil Filter.....	H-5504	Hydraulic Oil Filter.....	H-5504
Hydraulic Oil Filter.....	H-5506	Hydraulic Oil Filter.....	H-5506		
Oil Filter Full Flow.....	C-5516			980F (LOADERS) S/N: 3HK-UP	
		980C (LOADERS) S/N: 63X1-2818		Air Filter Set.....	A-5555-S
		Air Filter Primary.....	A-5501	Air Filter Secondary.....	A-5556
		Air Filter Secondary.....	A-5502	Air Filter Secondary.....	A-5502
		Hydraulic Oil Filter.....	H-55270	Air Filter Secondary.....	A-5534
980C (LOADERS) S/N: 63X1-UP				Air Filter Primary.....	A-5501
Air Filter Set.....	A-5573-S	980C (LOADERS) S/N: 63X8792-8862		Air Filter Primary.....	A-5555
Air Filter Secondary.....	A-5502	Air Filter Primary.....	A-5501	Air Filter Primary.....	A-5535
Air Filter Primary.....	A-5501	Air Filter Secondary.....	A-5502	Air Filter Set.....	A-5573-S
Air Filter Secondary.....	A-5534	Hydraulic Oil Filter.....	H-5506	Coolant Filter.....	WC-5705
Air Filter Primary.....	A-5535	Hydraulic Oil Filter.....	H-55270	Fuel Filter.....	F-5505
Fuel Filter.....	F-5505	Hydraulic Oil Filter.....	H-5504	Fuel Filter.....	FC-5502
Fuel Filter.....	FC-5519	Hydraulic Oil Filter.....	H-5506	Fuel Filter.....	FC-5509
Hydraulic Oil Filter.....	H-5506	Hydraulic Oil Filter.....	H-55270	Hydraulic Oil Filter.....	H-5506
Hydraulic Oil Filter.....	H-5504			Hydraulic Oil Filter.....	H-5504
Oil Filter Full Flow.....	C-5516	980F (LOADERS) CAT 3406C		Oil Filter Full Flow.....	C-5510
		Air Filter Primary.....	A-44150		
		Air Filter Set.....	A-44150-S	980F (LOADERS) S/N: 5XJ-UP	
980C (LOADERS) S/N: 63X2819-5062				Air Filter Secondary.....	A-5502
Air Filter Primary.....	A-5501	980F (LOADERS) CAT (S/N: 11N1-UP)		Air Filter Set.....	A-5573-S
Air Filter Secondary.....	A-5502	Fuel Filter.....	FC-5519	Air Filter Secondary.....	A-5556
Hydraulic Oil Filter.....	H-55270	Fuel Filter.....	FC-5509	Air Filter Set.....	A-5555-S
		Oil Filter Full Flow.....	C-5516	Air Filter Primary.....	A-5555
980C (LOADERS) S/N: 63X5063-5184				Air Filter Primary.....	A-5535
Air Filter Secondary.....	A-5502	980F (LOADERS) CAT 3406 DIT		Air Filter Secondary.....	A-5534
Air Filter Primary.....	A-5501	Air Filter Primary.....	A-5535	Air Filter Primary.....	A-5501
Hydraulic Oil Filter.....	H-55270	Air Filter Set.....	A-5573-S	Coolant Filter.....	WC-5705
Hydraulic Oil Filter.....	H-5506	Air Filter Secondary.....	A-5534	Fuel Filter.....	FC-5502
		Fuel Filter.....	FC-5502	Fuel Filter.....	F-5505
980C (LOADERS) S/N: 63X5185-6474		Hydraulic Oil Filter.....	H-5504	Fuel Filter.....	FC-5509
Air Filter Secondary.....	A-5502	Hydraulic Oil Filter.....	H-5506	Hydraulic Oil Filter.....	H-5504
Air Filter Primary.....	A-5501	Oil Filter Full Flow.....	C-5516	Hydraulic Oil Filter.....	H-5506
Hydraulic Oil Filter.....	H-5506			Oil Filter Full Flow.....	C-5510
		980F (LOADERS) S/N: 3HK1-720			
980C (LOADERS) S/N: 63X6475-6547		Hydraulic Oil Filter.....	H-55270	980F (LOADERS) S/N: 8CJ1-540	
Air Filter Primary.....	A-5501	Hydraulic Oil Filter.....	H-5504	Air Filter Secondary.....	A-5502
Air Filter Secondary.....	A-5502			Air Filter Primary.....	A-5501
Hydraulic Oil Filter.....	H-5506	980F (LOADERS) S/N: 3HK1-UP		Hydraulic Oil Filter.....	H-5506
		Air Filter Secondary.....	A-5502	Hydraulic Oil Filter.....	H-55270
980C (LOADERS) S/N: 63X6548-6548		Air Filter Primary.....	A-5535		
				980F (LOADERS) S/N: 8CJ1-UP	
				Air Filter Set.....	A-5573-S

MODEL/APPLICATION	SAKURA NO
CATERPILLAR	
980F (LOADERS) S/N: 8CJ1-UP	
Air Filter Primary.....	A-5535
Air Filter Secondary.....	A-5502
Air Filter Secondary.....	A-5534
Air Filter Primary.....	A-5501
Fuel Filter.....	F-5505
Fuel Filter.....	FC-5509
Hydraulic Oil Filter.....	H-5506
Hydraulic Oil Filter.....	H-55270
Hydraulic Oil Filter.....	H-5504
Oil Filter Full Flow.....	C-5516
980F (LOADERS) S/N: 8CJ541-UP	
Air Filter Set.....	A-5573-S
Air Filter Secondary.....	A-5534
Air Filter Primary.....	A-5535
Hydraulic Oil Filter.....	H-55270
Hydraulic Oil Filter.....	H-5506
980F (LOADERS) S/N: 8CJ-UP	
Air Filter Primary.....	A-5501
Air Filter Secondary.....	A-5534
Air Filter Secondary.....	A-5556
Air Filter Secondary.....	A-5502
Air Filter Set.....	A-5555-S
Air Filter Set.....	A-5573-S
Air Filter Primary.....	A-5555
Air Filter Primary.....	A-5535
Coolant Filter.....	WC-5705
Fuel Filter.....	FC-5509
Fuel Filter.....	F-5505
Fuel Filter.....	FC-5502
Hydraulic Oil Filter.....	H-5506
Hydraulic Oil Filter.....	H-5504
Oil Filter Full Flow.....	C-5510
980F (LOADERS) S/N: 8NJ-UP	
Air Filter Set.....	A-5555-S
Air Filter Secondary.....	A-5534
Air Filter Secondary.....	A-5502
Air Filter Primary.....	A-5501
Air Filter Primary.....	A-5555
Air Filter Primary.....	A-5535
Air Filter Set.....	A-5573-S
Air Filter Secondary.....	A-5556
Coolant Filter.....	WC-5705
Fuel Filter.....	FC-5509
Fuel Filter.....	FC-5502
Fuel Filter.....	F-5505
Hydraulic Oil Filter.....	H-5506
Hydraulic Oil Filter.....	H-5504
Oil Filter Full Flow.....	C-5510
980F (LOADERS) w/3406, 3406C Eng's.	
Air Filter Primary.....	A-5535M
Air Filter Set.....	A-5573M-S

MODEL/APPLICATION	SAKURA NO
CATERPILLAR	
980G (LOADERS) CAT (S/N: 41Z1-UP)	
Fuel Filter.....	FC-5519
Fuel Filter.....	FC-5509
Oil Filter Full Flow.....	C-5516
980G (LOADERS) CAT 3406C (S/N: 2KR1-UP)	
Air Filter Set.....	A-5573-S
Air Filter Primary.....	A-5535
Air Filter Primary.....	A-5555
Air Filter Secondary.....	A-5534
Air Filter Secondary.....	A-5556
Air Filter Set.....	A-5555-S
Fuel Filter.....	FC-5509
Fuel Filter.....	F-5505
Hydraulic Oil Filter.....	H-5506
Hydraulic Oil Filter.....	H-5504
Oil Filter Full Flow.....	C-5516
980G (LOADERS) CAT 3406C (S/N: 2SR1-650)	
Air Filter Set.....	A-5555-S
Air Filter Primary.....	A-5535
Air Filter Secondary.....	A-5556
Air Filter Primary.....	A-5555
Air Filter Set.....	A-5573-S
Air Filter Secondary.....	A-5534
Fuel Filter.....	FC-5509
Fuel Filter.....	F-5505
Hydraulic Oil Filter.....	H-5504
Hydraulic Oil Filter.....	H-5506
Oil Filter Full Flow.....	C-5516
980G (LOADERS) CAT 3406C (S/N: 2SR651-UP)	
Air Filter Secondary.....	A-5556
Air Filter Primary.....	A-5555
Air Filter Set.....	A-5555-S
Fuel Filter.....	FC-5509
Fuel Filter.....	F-5505
Hydraulic Oil Filter.....	H-5506
Hydraulic Oil Filter.....	H-5504
Oil Filter Full Flow.....	C-5516
980G (LOADERS) CAT 3406C (S/N: 9CM1-UP)	
Air Filter Set.....	A-5573-S
Air Filter Primary.....	A-5535
Air Filter Primary.....	A-5555
Air Filter Secondary.....	A-5534
Air Filter Set.....	A-5555-S
Air Filter Secondary.....	A-5556
Fuel Filter.....	FC-5509
Fuel Filter.....	F-5505
Hydraulic Oil Filter.....	H-5506
Hydraulic Oil Filter.....	H-5504
Oil Filter Full Flow.....	C-5516
980G (LOADERS) CAT 3406E ATAAC EUI (S/N: 2KR1-UP)	
Air Filter Primary.....	A-5535
Air Filter Primary.....	A-5555

MODEL/APPLICATION	SAKURA NO
CATERPILLAR	
Air Filter Secondary.....	A-5534
Air Filter Secondary.....	A-5556
Air Filter Set.....	A-5555-S
Air Filter Set.....	A-5573-S
Fuel Filter.....	FC-5509
Fuel Filter.....	F-5505
Hydraulic Oil Filter.....	H-5506
Hydraulic Oil Filter.....	H-5504
Hydraulic Oil Filter.....	H-55270
Oil Filter Full Flow.....	C-5516
980G (LOADERS) CAT 3406E ATAAC EUI (S/N: 2KR500-UP)	
Air Filter Primary.....	A-5555
Air Filter Secondary.....	A-5556
Air Filter Set.....	A-5555-S
Fuel Filter.....	FC-5509
Hydraulic Oil Filter.....	H-5506
Hydraulic Oil Filter.....	H-5504
Oil Filter Full Flow.....	C-5516
980G (LOADERS) CAT 3406E ATAAC EUI (S/N: 2SR1-UP)	
Air Filter Secondary.....	A-5556
Air Filter Secondary.....	A-5534
Fuel Filter.....	FC-5509
Fuel Filter.....	F-5505
Hydraulic Oil Filter.....	H-55270
Hydraulic Oil Filter.....	H-5506
Hydraulic Oil Filter.....	H-5504
Oil Filter Full Flow.....	C-5516
980G (LOADERS) CAT 3406E ATAAC EUI (S/N: 2SR651-UP)	
Air Filter Secondary.....	A-5556
Air Filter Set.....	A-5555-S
Air Filter Primary.....	A-5555
Fuel Filter.....	FC-5509
Fuel Filter.....	F-5505
Hydraulic Oil Filter.....	H-5506
Hydraulic Oil Filter.....	H-5504
Oil Filter Full Flow.....	C-5516
980G (LOADERS) CAT 3406E ATAAC EUI (S/N: 9CM00714-UP)	
Air Filter Secondary.....	A-5534
Air Filter Set.....	A-5573-S
Air Filter Primary.....	A-5535
Fuel Filter.....	FC-5509
980G (LOADERS) CAT 3406E ATAAC EUI (S/N: 9CM1125-1422)	
Air Filter Primary.....	A-5555
Air Filter.....	A-5584
Air Filter Secondary.....	A-5556
Air Filter Set.....	A-5555-S
Coolant Filter.....	WC-5705
Fuel Filter.....	FC-5509
Hydraulic Oil Filter.....	H-5506
Hydraulic Oil Filter.....	H-5504
Oil Filter Full Flow.....	C-5516
980G (LOADERS) CAT 3406E ATAAC EUI (S/N: 9CM1-UP)	
Air Filter Set.....	A-5555-S

MODEL/APPLICATION	SAKURA NO
CATERPILLAR	
980G (LOADERS) CAT 3406E ATAAC EUI (S/N: 9CM1-UP)	
Air Filter Secondary.....	A-5534
Air Filter Primary.....	A-5535
Air Filter Secondary.....	A-5556
Air Filter Set.....	A-5573-S
Air Filter Primary.....	A-5555
Fuel Filter.....	FC-5509
Fuel Filter.....	F-5505
Hydraulic Oil Filter.....	H-5506
Hydraulic Oil Filter.....	H-5504
Oil Filter Full Flow.....	C-5516
980G (LOADERS) S/N: 2KR1-505	
Air Filter Secondary.....	A-5534
Air Filter Set.....	A-5573-S
Air Filter Primary.....	A-5535
Air Filter.....	A-5584
Hydraulic Oil Filter.....	H-55270
Hydraulic Oil Filter.....	H-5506
980G (LOADERS) S/N: 2KR3565-UP	
Air Filter Secondary.....	A-5556
Air Filter Set.....	A-5555-S
Air Filter.....	A-5584
Air Filter Primary.....	A-5555
Hydraulic Oil Filter.....	H-55270
Hydraulic Oil Filter.....	H-5506
980G (LOADERS) S/N: 2KR506-3564	
Air Filter Secondary.....	A-5534
Air Filter Primary.....	A-5535
Air Filter Set.....	A-5573-S
Air Filter.....	A-5584
Hydraulic Oil Filter.....	H-5506
Hydraulic Oil Filter.....	H-55270
980G (LOADERS) S/N: 9CM1-372	
Air Filter.....	A-5584
Air Filter Primary.....	A-5535
Air Filter Set.....	A-5573-S
Air Filter Secondary.....	A-5534
Hydraulic Oil Filter.....	H-5504
Hydraulic Oil Filter.....	H-5506
Hydraulic Oil Filter.....	H-55270
980G (LOADERS) S/N: 9CM2142-UP	
Air Filter Primary.....	A-5555
Air Filter.....	A-5584
Air Filter Set.....	A-5555-S
Air Filter Secondary.....	A-5556
Hydraulic Oil Filter.....	H-5506
Hydraulic Oil Filter.....	H-55270
Hydraulic Oil Filter.....	H-5504
980G (LOADERS) S/N: 9CM373-2141	
Air Filter Primary.....	A-5555
Air Filter Secondary.....	A-5556

MODEL/APPLICATION	SAKURA NO
CATERPILLAR	
Air Filter.....	A-5584
Air Filter Set.....	A-5555-S
Hydraulic Oil Filter.....	H-5504
Hydraulic Oil Filter.....	H-5506
Hydraulic Oil Filter.....	H-55270
980G (LOADERS) w/3406, 3406C Eng.	
Air Filter Set.....	A-5573M-S
Air Filter Primary.....	A-5535M
980H (LOADERS) CAT S/N: JMS1-UP, 2007-UP	
Air Filter Secondary.....	A-5563
Air Filter Set.....	A-5565-S
Air Filter Primary.....	A-5564
Cabin Air Filter.....	CA-55070
Fuel Filter.....	FC-5517
980H (LOADERS) CAT S/N: LHX1-UP, 2007-UP	
Air Filter Primary.....	A-5564
Air Filter Set.....	A-5565-S
Air Filter Secondary.....	A-5563
Cabin Air Filter.....	CA-55070
Fuel Filter.....	FC-5517
980H (LOADERS) CAT S/N: MHG1-UP, 2007-UP	
Air Filter Set.....	A-5565-S
Air Filter Secondary.....	A-5563
Air Filter Primary.....	A-5564
Cabin Air Filter.....	CA-55070
Fuel Filter.....	FC-5517
980H (LOADERS) S/N: MHG1-UP	
Cabin Air Filter.....	CA-55160
980F SERIES II (LOADERS) CAT (S/N: 11N9825-UP)	
Fuel Filter.....	FC-5509
Oil Filter Full Flow.....	C-5516
980F SERIES II (LOADERS) S/N: 5XJ617-UP	
Air Filter Set.....	A-5573-S
Air Filter Secondary.....	A-5534
Air Filter Primary.....	A-5535
Fuel Filter.....	F-5505
Fuel Filter.....	FC-5509
Hydraulic Oil Filter.....	H-5504
Hydraulic Oil Filter.....	H-5506
Hydraulic Oil Filter.....	H-55270
Oil Filter Full Flow.....	C-5516
980F SERIES II (LOADERS) S/N: 8JN1-UP	
Air Filter Secondary.....	A-5534
Air Filter Set.....	A-5573-S
Air Filter Primary.....	A-5535
Fuel Filter.....	FC-5509
Fuel Filter.....	F-5505
Hydraulic Oil Filter.....	H-5504
Hydraulic Oil Filter.....	H-5506

MODEL/APPLICATION	SAKURA NO
CATERPILLAR	
Hydraulic Oil Filter.....	H-55270
Oil Filter Full Flow.....	C-5516
980F SERIES II (LOADERS) w/3406, 3406C Eng.	
Air Filter Set.....	A-5573M-S
Air Filter Primary.....	A-5535M
980G SERIES II (LOADERS) CAT (S/N: BET1-UP)	
Fuel Filter.....	FC-5517
Fuel Filter.....	FC-5509
Fuel/Water Separator Secondary... SFC-5504-10	
Fuel/Water Separator Secondary.. SFC-5504-10B	
Oil Filter Full Flow.....	C-5516
980G SERIES II (LOADERS) CAT 3406E ATAAC EUI (S/N: AWH1-UP)	
Air Filter Set.....	A-5555-S
Air Filter Secondary.....	A-5556
Air Filter Primary.....	A-5555
Fuel Filter.....	FC-5517
Hydraulic Oil Filter.....	H-55270
Hydraulic Oil Filter.....	H-5504
Oil Filter Full Flow.....	C-5516
980G SERIES II (LOADERS) S/N: AWH1-759	
Air Filter Primary.....	A-5555
Air Filter Set.....	A-5555-S
Air Filter.....	A-5584
Cabin Air Filter.....	CA-55070
Hydraulic Oil Filter.....	H-55270
980G SERIES II (LOADERS) S/N: AWH760-UP	
Air Filter Secondary.....	A-5556
Air Filter.....	A-5584
Air Filter Primary.....	A-5555
Air Filter Set.....	A-5555-S
Cabin Air Filter.....	CA-55070
Hydraulic Oil Filter.....	H-55270
980G SERIES II (LOADERS) S/N: AXG1-UP	
Air Filter Secondary.....	A-5556
Air Filter Primary.....	A-5555
Air Filter Set.....	A-5555-S
Cabin Air Filter.....	CA-55060
Cabin Air Filter.....	CA-55070
Hydraulic Oil Filter.....	H-55270
Hydraulic Oil Filter.....	H-5504
983B (LOADERS) S/N: 58X1-UP	
Air Filter Secondary.....	A-5502
Air Filter Primary.....	A-5501
Fuel Filter.....	FC-5509
983 (LOADERS) S/N: 38K1-UP	
Air Filter Primary.....	A-5557
Air Filter Set.....	A-5557-S
Air Filter Secondary.....	A-5526
Fuel Filter Secondary.....	FC-5507
Hydraulic Oil Filter.....	H-5503

Sakura Filter

ENGINE APPLICATION

MODEL/APPLICATION	SAKURA NO
CATERPILLAR	
983 (LOADERS) S/N: 38K1-UP Oil Filter Full Flow.....	0-5503
983G (LOADERS) S/N: 6W502513-UP , 2000-UP Air Filter Secondary..... Fuel Filter Secondary..... Fuel Filter..... Fuel Filter..... Fuel Filter Secondary..... Oil Filter Full Flow.....	A-5550 FC-55151 FC-5516 FC-5508 FC-5515 C-5522
988 (LOADERS) S/N: 87A9075-UP Air Filter Secondary..... Air Filter Set..... Air Filter Primary..... Fuel Filter..... Hydraulic Oil Filter..... Oil Filter Full Flow.....	A-5529 A-5521-S A-5521 F-5501 H-5503 0-5503
988B (LOADERS) CAT (S/N: 48W1-13172) Fuel Filter.....	FC-5509
988B (LOADERS) CAT (S/N: 48W13173-26423) Fuel Filter.....	FC-5509
988B (LOADERS) CAT (S/N: 48W26424-UP) Fuel Filter.....	FC-5509
988B (LOADERS) CAT (S/N: 99C9850-UP) Fuel Filter.....	FC-5509
988B (LOADERS) CAT S/N: 48W8433-UP Air Filter Set..... Air Filter Secondary..... Air Filter Primary..... Hydraulic Oil Filter.....	A-5521-S A-5529 A-5521 H-5509
988B (LOADERS) CAT S/N: 50W4034-UP Air Filter Set..... Air Filter Primary..... Air Filter Secondary..... Hydraulic Oil Filter.....	A-5521-S A-5521 A-5529 H-5509
988B (LOADERS) S/N: 50W1-1285 Hydraulic Oil Filter.....	H-55270
988B (LOADERS) S/N: 50W1286-1492 Air Filter Set..... Air Filter Primary..... Air Filter Secondary..... Hydraulic Oil Filter.....	A-5521-S A-5521 A-5529 H-55270
988B (LOADERS) S/N: 50W1493-6040 Air Filter Set..... Air Filter Primary.....	A-5521-S A-5521

MODEL/APPLICATION	SAKURA NO
CATERPILLAR	
Air Filter Secondary..... Hydraulic Oil Filter.....	A-5529 H-55270
988B (LOADERS) S/N: 50W1-UP Air Filter Primary..... Air Filter Set..... Air Filter Set..... Air Filter Secondary..... Air Filter Primary..... Fuel Filter..... Fuel Filter..... Hydraulic Oil Filter..... Oil Filter Full Flow.....	A-5521 A-5521-S A-5555-S A-5556 A-5529 A-5555 FC-5519 FC-5509 H-5504 C-5516
988B (LOADERS) S/N: 50W6041-8176 Air Filter Secondary..... Air Filter Primary..... Air Filter Set..... Hydraulic Oil Filter.....	A-5529 A-5521 A-5521-S H-55270
988B (LOADERS) S/N: 50W8177-8184 Air Filter Primary..... Air Filter Set..... Air Filter Secondary..... Hydraulic Oil Filter.....	A-5555 A-5555-S A-5556 H-55270
988B (LOADERS) S/N: 50W8185-8224 Air Filter Set..... Air Filter Primary..... Air Filter Secondary..... Air Filter Primary..... Air Filter Set..... Air Filter Secondary..... Hydraulic Oil Filter.....	A-5555-S A-5521 A-5529 A-5555 A-5521-S A-5556 H-55270
988B (LOADERS) S/N: 50W8225-9164 Air Filter Primary..... Air Filter Set..... Air Filter Secondary..... Hydraulic Oil Filter.....	A-5555 A-5555-S A-5556 H-55270
988B (LOADERS) S/N: 50W9165-UP Air Filter Set..... Air Filter Secondary..... Air Filter Primary..... Hydraulic Oil Filter.....	A-5555-S A-5556 A-5555 H-55270
988B (LOADERS) w/3408 Eng. Hydraulic Oil Filter.....	H-55320
988F (LOADERS) CAT (S/N: 48W34250-UP) Fuel Filter.....	FC-5509
988F (LOADERS) CAT (S/N: 99C9764-UP) Fuel Filter.....	FC-5509

MODEL/APPLICATION	SAKURA NO
CATERPILLAR	
988F (LOADERS) S/N: 8YG1-UP Air Filter Primary..... Air Filter Secondary..... Air Filter Set..... Fuel Filter..... Fuel Filter..... Hydraulic Oil Filter..... Hydraulic Oil Filter..... Hydraulic Oil Filter..... Oil Filter Full Flow.....	A-5555 A-5556 A-5555-S F-5505 FC-5509 H-5504 H-5509 H-55270 C-5516
988F II (LOADERS) S/N: 2ZR1-UP Air Filter Secondary..... Air Filter Set..... Air Filter Primary..... Fuel Filter..... Hydraulic Oil Filter..... Oil Filter Full Flow.....	A-5556 A-5555-S A-5555 FC-5509 H-5504 C-5516
988G (LOADERS) CAT 3456 ATAAC-EUI (S/N: 2TW1-UP) Air Filter Primary..... Air Filter Set..... Air Filter Secondary..... Fuel Filter..... Hydraulic Oil Filter..... Hydraulic Oil Filter..... Oil Filter Full Flow.....	A-5564 A-5565-S A-5563 FC-5509 HC-5504 HC-5512 C-5516
988G (LOADERS) CAT 3456 ATAAC-EUI (S/N: BNH1-UP) Air Filter Set..... Air Filter Secondary..... Air Filter Primary..... Fuel Filter..... Hydraulic Oil Filter..... Hydraulic Oil Filter..... Oil Filter Full Flow.....	A-5565-S A-5563 A-5564 FC-5509 HC-5504 HC-5512 C-5516
988G (LOADERS) CAT S/N: 7RC1-1514 Fuel Filter..... Oil Filter Full Flow.....	FC-5509 C-5516
988G (LOADERS) CAT S/N: 7RC1515-UP Fuel Filter.....	FC-5509
988G (LOADERS) CAT S/N: BNT10129-UP Fuel Filter.....	FC-5509
988G (LOADERS) CAT S/N: BNT1-10128 Fuel Filter..... Oil Filter Full Flow.....	FC-5509 C-5516
988G (LOADERS) S/N: 1NZ1-UP Air Filter Set..... Air Filter Secondary..... Air Filter..... Air Filter Primary.....	A-5565-S A-5563 A-5584 A-5564

MODEL/APPLICATION	SAKURA NO
CATERPILLAR	
988G (LOADERS) S/N: 1NZ1-UP	
Fuel/Water Separator Secondary..	SFC-5504-10B
Fuel/Water Separator Secondary..	SFC-5504-10
Hydraulic Oil Filter.....	HC-5504
Hydraulic Oil Filter.....	H-55270
Hydraulic Oil Filter.....	HC-5503
Hydraulic Oil Filter.....	HC-5506
Hydraulic Oil Filter.....	HC-5512
988H (LOADERS) CAT S/N: BXY1-UP , 2006-UP	
Air Filter Secondary.....	A-5594
Air Filter Primary.....	A-5593
Air Filter.....	A-5584
Air Filter Set.....	A-5595-S
Fuel Filter.....	FC-5510
Fuel Filter.....	FC-5517
Hydraulic Oil Filter.....	HC-5512
Hydraulic Oil Filter.....	HC-5504
988H (LOADERS) CAT S/N: RHX1-UP , 2006-UP	
Air Filter.....	A-5584
Air Filter Secondary.....	A-5594
Air Filter Set.....	A-5595-S
Air Filter Primary.....	A-5593
Fuel Filter.....	FC-5510
Fuel Filter.....	FC-5517
Hydraulic Oil Filter.....	HC-5504
Hydraulic Oil Filter.....	HC-5512
988H (LOADERS) CAT C18TA ACERT	
Cabin Air Filter.....	CA-55120
988A (LOADERS) S/N: 87A1-1308	
Air Filter Primary.....	A-5555
Air Filter Secondary.....	A-5520
Air Filter Primary.....	A-5543
Air Filter Set.....	A-5555-S
Air Filter Set.....	A-5544-S
Air Filter Secondary.....	A-5556
Fuel Filter.....	F-5501
Hydraulic Oil Filter.....	H-5503
Oil Filter Full Flow.....	O-5503
988A (LOADERS) S/N: 87A1309-1878	
Air Filter Set.....	A-5544-S
Air Filter Primary.....	A-5543
Air Filter Secondary.....	A-5556
Air Filter Primary.....	A-5555
Air Filter Secondary.....	A-5520
Air Filter Set.....	A-5555-S
Fuel Filter.....	F-5501
Hydraulic Oil Filter.....	H-5503
Oil Filter Full Flow.....	O-5503
988A (LOADERS) S/N: 87A1879-5627	
Air Filter Primary.....	A-5543
Air Filter Set.....	A-5544-S

MODEL/APPLICATION	SAKURA NO
CATERPILLAR	
Air Filter Secondary.....	A-5559
Air Filter Secondary.....	A-5520
Air Filter Primary.....	A-5558
Fuel Filter Secondary.....	FC-5507
Hydraulic Oil Filter.....	H-5503
Oil Filter Full Flow.....	O-5503
988A (LOADERS) S/N: 87A5628-UP	
Air Filter Primary.....	A-5558
Air Filter Secondary.....	A-5520
Air Filter Set.....	A-5544-S
Air Filter Secondary.....	A-5559
Air Filter Primary.....	A-5543
Fuel Filter Secondary.....	FC-5507
Hydraulic Oil Filter.....	H-5503
Oil Filter Full Flow.....	O-5503
988A (LOADERS) S/N: 87A8490-UP	
Air Filter Primary.....	A-5543
Air Filter Set.....	A-5544-S
Air Filter Secondary.....	A-5520
988F SERIES II (LOADERS) CAT (S/N: 5XD1-UP)	
Fuel Filter.....	FC-5509
Fuel/Water Separator Secondary..	SFC-5504-10B
Fuel/Water Separator Secondary..	SFC-5504-10
988F SERIES II (LOADERS) CAT (S/N: 99C1-UP)	
Fuel Filter.....	FC-5509
Fuel/Water Separator Secondary..	SFC-5504-10
Fuel/Water Separator Secondary..	SFC-5504-10B
Oil Filter Full Flow.....	C-5516
988F SERIES II (LOADERS) S/N: 2ZR1-UP	
Air Filter Primary.....	A-5555
Air Filter Set.....	A-5555-S
Air Filter Secondary.....	A-5556
Hydraulic Oil Filter.....	H-55270
Hydraulic Oil Filter.....	H-5509
Hydraulic Oil Filter.....	HC-5504
990 (LOADERS) CAT 3412E HEUI	
Air Filter Primary.....	A-5521
Air Filter Set.....	A-5521-S
Air Filter Secondary.....	A-5529
Fuel Filter.....	FC-5519
Hydraulic Oil Filter.....	H-5506
Oil Filter Full Flow.....	C-5516
990 (LOADERS) CAT (S/N: 73W14650-UP)	
Fuel Filter.....	FC-5509
Oil Filter Full Flow.....	C-5516
990 (LOADERS) CAT (S/N: 80M7883-UP)	
Fuel Filter.....	FC-5509
Oil Filter Full Flow.....	C-5516

MODEL/APPLICATION	SAKURA NO
CATERPILLAR	
990 (LOADERS) CAT 3412E TA	
Cabin Air Filter.....	CA-55120
990 (LOADERS) CAT 3412E HEUI (S/N: 7HK1-UP)	
Air Filter Set.....	A-5555-S
Air Filter Secondary.....	A-5556
Air Filter Primary.....	A-5555
Fuel Filter.....	FC-5509
Hydraulic Oil Filter.....	H-5526
Hydraulic Oil Filter.....	H-5506
Oil Filter Full Flow.....	C-5516
990 II (LOADERS) CAT 3412 TAE1	
Cabin Air Filter.....	CA-55120
990H (LOADERS) CAT S/N: BWX1-UP , 2006-UP	
Air Filter Secondary.....	A-5556
Air Filter Primary.....	A-5555
Air Filter Set.....	A-5555-S
Fuel Filter.....	FC-5510
Hydraulic Oil Filter.....	H-5526
Hydraulic Oil Filter.....	HC-5504
Hydraulic Oil Filter.....	H-55280
Hydraulic Oil Filter.....	H-5506
Oil Filter Full Flow.....	C-5516
990H (LOADERS) CAT S/N: EHX1-2699-UP , 2006-UP	
Air Filter Set.....	A-5555-S
Air Filter Secondary.....	A-5556
Air Filter Primary.....	A-5555
Fuel Filter.....	FC-5510
Hydraulic Oil Filter.....	H-5526
Hydraulic Oil Filter.....	HC-5504
Hydraulic Oil Filter.....	H-5506
990H (LOADERS) CAT S/N: EHX2700-UP , 2006-UP	
Air Filter Secondary.....	A-5556
Air Filter Set.....	A-5555-S
Air Filter Primary.....	A-5555
Fuel Filter.....	FC-5510
Hydraulic Oil Filter.....	HC-5504
Hydraulic Oil Filter.....	H-55280
Hydraulic Oil Filter.....	H-5526
Hydraulic Oil Filter.....	H-5506
Oil Filter Full Flow.....	C-5516
990H (LOADERS) CAT C27TA ACERT	
Cabin Air Filter.....	CA-55120
990 SERIES II (LOADERS) CAT (S/N: 5JJ4077-4369)	
Fuel Filter.....	FC-5509
990 SERIES II (LOADERS) CAT (S/N: 80M1-UP)	
Fuel Filter.....	FC-5517
Fuel Filter.....	FC-5509
Oil Filter Full Flow.....	C-5516

MODEL/APPLICATION	SAKURA NO
CATERPILLAR	
990 SERIES II (LOADERS) CAT S/N: 3412E HEUI (S/N: 4FR1-UP)	
Air Filter Primary.....	A-5555
Air Filter Secondary.....	A-5556
Air Filter Set.....	A-5555-S
Fuel Filter.....	FC-5509
Hydraulic Oil Filter.....	H-5526
Hydraulic Oil Filter.....	H-5506
Oil Filter Full Flow.....	C-5516
990 SERIES II (LOADERS) CAT S/N: 5JJ251-4076	
Fuel Filter.....	FC-5509
Oil Filter Full Flow.....	C-5516
990 SERIES II (LOADERS) CAT S/N: 5JJ4370-UP	
Fuel Filter.....	FC-5509
Oil Filter Full Flow.....	C-5516
990 SERIES II (LOADERS) S/N: BCR1-UP	
Air Filter Set.....	A-5555-S
Air Filter Primary.....	A-5555
Air Filter Secondary.....	A-5556
Fuel/Water Separator Secondary..	SFC-5504-10
Fuel/Water Separator Secondary..	SFC-5504-10B
Hydraulic Oil Filter.....	H-55280
Hydraulic Oil Filter.....	H-5506
Hydraulic Oil Filter.....	H-5526
992C (LOADERS) CAT (S/N: 80M1-UP)	
Fuel Filter.....	FC-5509
Fuel Filter.....	FC-5517
Oil Filter Full Flow.....	C-5516
992C (LOADERS) S/N: 42X1-647	
Hydraulic Oil Filter.....	H-5526
Hydraulic Oil Filter.....	H-5502
992C (LOADERS) S/N: 42X1-UP	
Air Filter Secondary.....	A-5529
Air Filter Primary.....	A-5555
Air Filter Set.....	A-5555-S
Air Filter Set.....	A-5521-S
Air Filter Secondary.....	A-5556
Air Filter Primary.....	A-5521
Fuel Filter.....	FC-5509
Hydraulic Oil Filter.....	H-5503
Hydraulic Oil Filter.....	H-5502
Oil Filter Full Flow.....	C-5516
992C (LOADERS) S/N: 42X648-899	
Air Filter Secondary.....	A-5529
Air Filter Set.....	A-5521-S
Air Filter Primary.....	A-5521
Hydraulic Oil Filter.....	H-5526
Hydraulic Oil Filter.....	H-5502
Hydraulic Oil Filter.....	H-55280

MODEL/APPLICATION	SAKURA NO
CATERPILLAR	
992C (LOADERS) S/N: 42X900-UP	
Air Filter Secondary.....	A-5529
Air Filter Primary.....	A-5521
Air Filter Set.....	A-5521-S
Hydraulic Oil Filter.....	H-5504
Hydraulic Oil Filter.....	H-5526
Hydraulic Oil Filter.....	H-55280
Hydraulic Oil Filter.....	H-55270
Hydraulic Oil Filter.....	H-5502
992C (LOADERS) S/N: 49Z1176-UP	
Air Filter Primary.....	A-5521
Air Filter Secondary.....	A-5529
Air Filter Set.....	A-5521-S
Hydraulic Oil Filter.....	H-5502
Hydraulic Oil Filter.....	H-5504
Hydraulic Oil Filter.....	H-55280
Hydraulic Oil Filter.....	H-5503
Hydraulic Oil Filter.....	H-55270
Hydraulic Oil Filter.....	H-5526
992C (LOADERS) S/N: 49Z1-560	
Air Filter Primary.....	A-5521
Air Filter Set.....	A-5521-S
Air Filter Secondary.....	A-5529
Hydraulic Oil Filter.....	H-55270
Hydraulic Oil Filter.....	H-5504
Hydraulic Oil Filter.....	H-5526
Hydraulic Oil Filter.....	H-5502
Hydraulic Oil Filter.....	H-55280
992C (LOADERS) S/N: 49Z1-UP	
Air Filter Primary.....	A-5521
Air Filter Set.....	A-5521-S
Air Filter Secondary.....	A-5529
Fuel Filter.....	FC-5509
Hydraulic Oil Filter.....	H-5504
Hydraulic Oil Filter.....	H-5503
Hydraulic Oil Filter.....	H-5509
Oil Filter Full Flow.....	C-5516
992C (LOADERS) S/N: 49Z561-977	
Air Filter Secondary.....	A-5529
Air Filter Primary.....	A-5521
Air Filter Set.....	A-5521-S
Hydraulic Oil Filter.....	H-5526
Hydraulic Oil Filter.....	H-55280
Hydraulic Oil Filter.....	H-55270
Hydraulic Oil Filter.....	H-5502
Hydraulic Oil Filter.....	H-5504
992C (LOADERS) S/N: 49Z978-1175	
Air Filter Secondary.....	A-5529
Air Filter Set.....	A-5521-S
Air Filter Primary.....	A-5521
Hydraulic Oil Filter.....	H-5504
Hydraulic Oil Filter.....	H-55270

MODEL/APPLICATION	SAKURA NO
CATERPILLAR	
Hydraulic Oil Filter.....	H-55280
Hydraulic Oil Filter.....	H-5526
Hydraulic Oil Filter.....	H-5502
992C (LOADERS) w/3412 Eng.	
Hydraulic Oil Filter.....	H-55320
992D (LOADERS) CAT (S/N: 73M13888-UP)	
Fuel Filter.....	FC-5509
Oil Filter Full Flow.....	C-5516
992D (LOADERS) CAT (S/N: 80M1-UP)	
Fuel Filter.....	FC-5517
Fuel Filter.....	FC-5509
Oil Filter Full Flow.....	C-5516
992D (LOADERS) S/N: 7MJ1-147	
Air Filter Set.....	A-5521-S
Air Filter Primary.....	A-5521
Air Filter Secondary.....	A-5529
Hydraulic Oil Filter.....	H-55280
Hydraulic Oil Filter.....	H-5502
Hydraulic Oil Filter.....	H-55270
Hydraulic Oil Filter.....	H-5503
Hydraulic Oil Filter.....	H-5509
Hydraulic Oil Filter.....	H-5526
Hydraulic Oil Filter.....	H-5504
992D (LOADERS) S/N: 7MJ148-UP	
Air Filter Primary.....	A-5555
Air Filter Set.....	A-5555-S
Air Filter Secondary.....	A-5556
Hydraulic Oil Filter.....	H-5503
Hydraulic Oil Filter.....	H-55270
Hydraulic Oil Filter.....	H-5502
Hydraulic Oil Filter.....	H-5509
Hydraulic Oil Filter.....	H-5526
Hydraulic Oil Filter.....	H-5504
Hydraulic Oil Filter.....	H-55280
992D (LOADERS) S/N: 7MJ1-UP	
Air Filter Primary.....	A-5521
Air Filter Secondary.....	A-5556
Air Filter Secondary.....	A-5529
Air Filter Primary.....	A-5555
Air Filter Set.....	A-5521-S
Air Filter Set.....	A-5555-S
Fuel Filter.....	FC-5509
Hydraulic Oil Filter.....	H-5504
Hydraulic Oil Filter.....	H-5526
Hydraulic Oil Filter.....	H-5509
Hydraulic Oil Filter.....	H-55270
Hydraulic Oil Filter.....	H-55280
Hydraulic Oil Filter.....	H-5503
Hydraulic Oil Filter.....	H-5502
Oil Filter Full Flow.....	C-5516
992D (LOADERS) w/3412 Eng.	

MODEL/APPLICATION	SAKURA NO
CATERPILLAR	
992D (LOADERS) w/3412 Eng. Hydraulic Oil Filter.....	H-55320
992G (LOADERS) CAT (S/N: 2GR1-2632) Air Filter Secondary..... Air Filter Set..... Air Filter Primary..... Air Filter Secondary..... Air Filter Secondary..... Air Filter Primary..... Air Filter Set..... Fuel Filter.....	A-44230 A-5595-S A-5593 A-5594 A-5715 A-44220 A-44240-S FC-5510
992G (LOADERS) CAT (S/N: 2GR2633-UP) Air Filter Secondary..... Air Filter Primary..... Air Filter Secondary..... Air Filter Secondary..... Air Filter Set..... Air Filter Set..... Air Filter Primary..... Fuel Filter.....	A-44230 A-44220 A-5594 A-5715 A-5595-S A-44240-S A-5593 FC-5510
992G (LOADERS) CAT 3508B EUI (S/N: 7HR1-UP) Air Filter Primary..... Air Filter Secondary..... Air Filter Set..... Fuel Filter..... Hydraulic Oil Filter..... Hydraulic Oil Filter..... Hydraulic Oil Filter..... Oil Filter Full Flow.....	A-44220 A-44230 A-44240-S FC-5510 HC-5512 HC-5504 H-5526 C-5516
992G (LOADERS) CAT 3508B EUI (S/N: ADZ1-UP) Air Filter Set..... Air Filter Secondary..... Air Filter Primary..... Fuel Filter..... Hydraulic Oil Filter..... Hydraulic Oil Filter..... Hydraulic Oil Filter..... Oil Filter Full Flow.....	A-44240-S A-44230 A-44220 FC-5510 H-5526 HC-5504 HC-5512 C-5516
992G (LOADERS) CAT 3508TA Cabin Air Filter.....	CA-55120
992G (LOADERS) S/N: ADZ1-540 Hydraulic Oil Filter..... Hydraulic Oil Filter..... Hydraulic Oil Filter..... Hydraulic Oil Filter.....	H-5526 HC-5504 H-55280 HC-5512
992G (LOADERS) S/N: ADZ541-UP Hydraulic Oil Filter..... Hydraulic Oil Filter..... Hydraulic Oil Filter..... Hydraulic Oil Filter.....	HC-5504 HC-5512 H-55280 H-5526

MODEL/APPLICATION	SAKURA NO
CATERPILLAR	
992G (LOADERS) S/N: AZX1-UP Hydraulic Oil Filter..... Hydraulic Oil Filter..... Hydraulic Oil Filter..... Hydraulic Oil Filter.....	HC-5504 H-55280 HC-5512 H-5526
992K (LOADERS) CAT C32 ACERT Cabin Air Filter.....	CA-55120
992 (LOADERS) S/N: 25K1-1169 Air Filter Primary..... Air Filter Secondary..... Air Filter Primary..... Air Filter Secondary..... Air Filter Set..... Fuel Filter..... Hydraulic Oil Filter..... Hydraulic Oil Filter..... Oil Filter Full Flow.....	A-5558 A-5520 A-5543 A-5559 A-5544-S F-5501 H-5502 H-5503 O-5502
992B (LOADERS) S/N: 25K1170-UP Air Filter Primary..... Air Filter Secondary..... Air Filter Secondary..... Air Filter Primary..... Air Filter Set..... Fuel Filter..... Hydraulic Oil Filter..... Hydraulic Oil Filter..... Oil Filter Full Flow.....	A-5501 A-5534 A-5502 A-5535 A-5573-S F-5501 H-5502 H-5503 O-5502
994 (LOADERS) CAT (S/N: 54Z1201-UP) Fuel Filter.....	FC-5510
994 (LOADERS) CAT (S/N: 54Z486-1200) Fuel Filter.....	FC-5510
994 (LOADERS) S/N: 54Z1-UP Air Filter Set..... Air Filter Secondary..... Air Filter Primary..... Air Filter Primary..... Air Filter Secondary..... Air Filter Set..... Fuel Filter..... Hydraulic Oil Filter..... Hydraulic Oil Filter..... Hydraulic Oil Filter..... Oil Filter Full Flow.....	A-5562-S A-5560 A-5521 A-5561 A-5552 A-5521-S FC-5510 H-5506 H-55280 H-5503 C-5516
994 (LOADERS) S/N: 9TF1-UP Air Filter Secondary..... Air Filter Primary..... Air Filter Set..... Air Filter Secondary..... Air Filter Set.....	A-5556 A-5521 A-5555-S A-5552 A-5521-S

MODEL/APPLICATION	SAKURA NO
CATERPILLAR	
Air Filter Primary..... Fuel Filter..... Hydraulic Oil Filter..... Hydraulic Oil Filter..... Hydraulic Oil Filter..... Hydraulic Oil Filter..... Hydraulic Oil Filter..... Hydraulic Oil Filter.....	A-5555 FC-5510 HC-5504 H-5526 H-5504 H-55270 H-5503 H-55280
994 (LOADERS) S/N: 9Y49-55 Air Filter Set..... Air Filter Secondary..... Air Filter Primary..... Hydraulic Oil Filter..... Hydraulic Oil Filter..... Hydraulic Oil Filter..... Hydraulic Oil Filter..... Hydraulic Oil Filter.....	A-5555-S A-5556 A-5555 H-55270 HC-5504 HC-5508 H-55280 H-5526
994 (LOADERS) S/N: 9Y56-109 Air Filter Set..... Air Filter Primary..... Air Filter Secondary..... Hydraulic Oil Filter..... Hydraulic Oil Filter..... Hydraulic Oil Filter..... Hydraulic Oil Filter.....	A-5555-S A-5555 A-5556 H-55280 HC-5504 HC-5508 H-5526 H-55270
994 (LOADERS) S/N: 9YF110-UP Air Filter Primary..... Air Filter Set..... Air Filter Secondary..... Hydraulic Oil Filter..... Hydraulic Oil Filter..... Hydraulic Oil Filter..... Hydraulic Oil Filter.....	A-5555 A-5555-S A-5556 H-55280 HC-5504 HC-5508 H-5526 H-55280
994 (LOADERS) S/N: 9YF1-19 Air Filter Primary..... Air Filter Set..... Air Filter Secondary..... Hydraulic Oil Filter..... Hydraulic Oil Filter..... Hydraulic Oil Filter..... Hydraulic Oil Filter.....	A-5521 A-5521-S A-5552 HC-5504 H-55270 H-55280 H-5526
994 (LOADERS) S/N: 9YF1-UP Air Filter Set..... Air Filter Secondary..... Air Filter Secondary..... Air Filter Set..... Air Filter Primary..... Air Filter Primary..... Fuel Filter..... Hydraulic Oil Filter..... Hydraulic Oil Filter..... Hydraulic Oil Filter.....	A-5521-S A-5552 A-5556 A-5555-S A-5521 A-5555 FC-5510 H-5504 H-5503 HC-5504

MODEL/APPLICATION SAKURA NO

CATERPILLAR

994
(LOADERS)
S/N: 9YF20-20
Air Filter Primary..... A-5521
Air Filter Set..... A-5521-S
Air Filter Secondary..... A-5552
Hydraulic Oil Filter..... HC-5504
Hydraulic Oil Filter..... HC-5508
Hydraulic Oil Filter..... H-55280
Hydraulic Oil Filter..... H-55270
Hydraulic Oil Filter..... H-5526

994
(LOADERS)
S/N: 9YF21-27
Air Filter Secondary..... A-5552
Air Filter Primary..... A-5521
Air Filter Set..... A-5521-S
Hydraulic Oil Filter..... H-55280
Hydraulic Oil Filter..... H-5526
Hydraulic Oil Filter..... H-55270
Hydraulic Oil Filter..... HC-5504
Hydraulic Oil Filter..... HC-5508
Hydraulic Oil Filter..... H-5503

994
(LOADERS)
S/N: 9YF28-48
Air Filter Set..... A-5521-S
Air Filter Primary..... A-5521
Air Filter Secondary..... A-5552
Hydraulic Oil Filter..... HC-5508
Hydraulic Oil Filter..... HC-5504
Hydraulic Oil Filter..... H-55270
Hydraulic Oil Filter..... H-5526
Hydraulic Oil Filter..... H-55280

994D
(LOADERS)
CAT (S/N: 7TR1057-UP)
Fuel Filter..... FC-5510

994D
(LOADERS)
CAT (S/N: 7TR360-1056)
Fuel Filter..... FC-5510

994D
(LOADERS)
CAT 3516B (S/N: 3TZ1-UP)
Air Filter Set..... A-5555-S
Air Filter Secondary..... A-5556
Air Filter Primary..... A-5555
Fuel Filter..... FC-5510
Hydraulic Oil Filter..... H-55270
Hydraulic Oil Filter..... H-55280
Hydraulic Oil Filter..... HC-5504
Hydraulic Oil Filter..... H-5526
Hydraulic Oil Filter..... H-5504

994F
(LOADERS)
CAT S/N: 4421-UP , 2007-UP
Air Filter Set..... A-5565-S
Air Filter Primary..... A-5564
Air Filter Secondary..... A-5563
Fuel Filter..... FC-5510
Fuel Filter Secondary..... FC-5507
Hydraulic Oil Filter..... HC-5512
Hydraulic Oil Filter..... HC-5504
Hydraulic Oil Filter..... H-5526

MODEL/APPLICATION SAKURA NO

CATERPILLAR

Hydraulic Oil Filter..... H-55280

994F
(LOADERS)
CAT S/N: 8WM1-UP , 2007-UP
Air Filter Set..... A-5565-S
Air Filter Secondary..... A-5563
Air Filter Primary..... A-5564
Fuel Filter Secondary..... FC-5507
Fuel Filter..... FC-5510
Hydraulic Oil Filter..... HC-5512
Hydraulic Oil Filter..... HC-5504
Hydraulic Oil Filter..... H-5526
Hydraulic Oil Filter..... H-55280

994F
(LOADERS)
CAT 3516BTA
Cabin Air Filter..... CA-55120

994G
(LOADERS)
CAT S/N: 7TR1-UP
Air Filter Primary..... A-5555
Air Filter Set..... A-5555-S
Air Filter Secondary..... A-5556
Fuel Filter Secondary..... FC-5507
Fuel Filter..... FC-5510
Hydraulic Oil Filter..... H-5526
Hydraulic Oil Filter..... H-55280
Hydraulic Oil Filter..... H-55270

994G
(LOADERS)
CAT S/N: 8FR1-UP
Air Filter Set..... A-5555-S
Air Filter Secondary..... A-5556
Air Filter Primary..... A-5555
Fuel Filter..... FC-5510
Fuel Filter Secondary..... FC-5507
Hydraulic Oil Filter..... H-55270
Hydraulic Oil Filter..... H-55280
Hydraulic Oil Filter..... H-5526

994G
(LOADERS)
CAT 3516BTA
Cabin Air Filter..... CA-55120

998A
(LOADERS)
Air Filter Set..... A-5521-S
Air Filter Primary..... A-5521
Air Filter Secondary..... A-5529
Air Filter Secondary..... A-5520
Air Filter Set..... A-5544-S
Air Filter Primary..... A-5543
Fuel Filter..... F-5501
Fuel Filter..... FC-5523
Fuel Filter..... FC-5501
Hydraulic Oil Filter..... H-5503
Oil Filter Full Flow..... 0-5503

998B
(LOADERS)
Air Filter Primary..... A-5521
Air Filter Set..... A-5521-S
Air Filter Secondary..... A-5529
Fuel Filter..... FC-5519
Hydraulic Oil Filter..... H-5504

MODEL/APPLICATION SAKURA NO

CATERPILLAR

Oil Filter Full Flow..... C-5516

AD45
(ARTICULATED TRUCKS)
S/N: BKZ181-UP
Air Filter Secondary..... A-5715
Fuel Filter..... FC-5509
Hydraulic Oil Filter..... H-5504
Hydraulic Oil Filter..... H-5526
Hydraulic Oil Filter..... H-55270
Hydraulic Oil Filter..... H-5503
Hydraulic Oil Filter..... H-55280
Oil Filter Full Flow..... C-5516

AD55
(ARTICULATED TRUCKS)
CAT C18 DITA ATAAC
Cabin Air Filter..... CA-55100

AD55
(ARTICULATED TRUCKS)
S/N: ANW1-UP
Air Filter Secondary..... A-5715
Fuel Filter..... FC-5509
Hydraulic Oil Filter..... HC-5503
Hydraulic Oil Filter..... HC-5516
Hydraulic Oil Filter..... HC-5504
Hydraulic Oil Filter..... HC-55300
Hydraulic Oil Filter..... HC-5512
Hydraulic Oil Filter..... HC-5506
Oil Filter Full Flow..... C-5516

AE40
(ARTICULATED TRUCKS)
S/N: 1ZZ1-UP
Air Filter Secondary..... A-5715
Fuel Filter..... FC-5509
Hydraulic Oil Filter..... H-5526
Hydraulic Oil Filter..... H-55270
Hydraulic Oil Filter..... H-5503
Hydraulic Oil Filter..... H-55280
Hydraulic Oil Filter..... H-5504
Oil Filter Full Flow..... C-5516

AE40 SERIES II
(ARTICULATED TRUCKS)
S/N: BLW181-UP
Air Filter Secondary..... A-5715
Fuel Filter..... FC-5509
Hydraulic Oil Filter..... H-5504
Hydraulic Oil Filter..... H-5503
Hydraulic Oil Filter..... H-55270
Hydraulic Oil Filter..... H-55280
Hydraulic Oil Filter..... H-5526
Oil Filter Full Flow..... C-5516

AG55
(MOTOR GRADERS)
Air Filter..... A-85400

AP-1000
(ASPHALT PAVER)
CAT 3116TA
Air Filter Primary..... A-44180
Air Filter Set..... A-44180-S

AP-1000
(ASPHALT PAVER)
S/N: 1HD1-UP
Air Filter Set..... A-5507-S
Air Filter Set..... A-5568-S
Air Filter Secondary..... A-5567
Air Filter Primary..... A-5507

MODEL/APPLICATION	SAKURA NO	MODEL/APPLICATION	SAKURA NO	MODEL/APPLICATION	SAKURA NO
CATERPILLAR		CATERPILLAR		CATERPILLAR	
AP-1000 (ASPHALT PAVER) S/N: 1HD1-UP Air Filter Set..... A-55071-S Air Filter Primary..... A-5566 Fuel Filter Secondary..... FC-5507 Oil Filter Full Flow..... C-5510		Air Filter Primary..... A-5558 Air Filter Secondary..... A-5559 Hydraulic Oil Filter..... HC-55220 Hydraulic Oil Filter..... H-5517 Hydraulic Oil Filter..... HC-5507		AP-1055D (ASPHALT PAVER) CAT S/N: FAC1-UP Air Filter Secondary..... A-5559 Air Filter Primary..... A-5558 Fuel Filter..... FC-5517 Hydraulic Oil Filter..... H-5517 Hydraulic Oil Filter..... HC-5504 Oil Filter Full Flow..... C-5522	
AP-1000B (ASPHALT PAVER) CAT S/N: 98Z16051-30399-UP Fuel Filter..... FC-5508 Fuel Filter Secondary..... FC-5515 Fuel Filter Secondary..... FC-55151 Fuel Filter..... FC-5516 Oil Filter Full Flow..... C-5522		AP-1000B (ASPHALT PAVER) S/N: AGP176-UP Air Filter Secondary..... A-5559 Air Filter Primary..... A-5558 Hydraulic Oil Filter..... HC-5507 Hydraulic Oil Filter..... HC-55220 Hydraulic Oil Filter..... H-5517		AP-1055D (ASPHALT PAVER) CAT S/N: KHX1-UP Air Filter Secondary..... A-5559 Air Filter Primary..... A-5558 Fuel Filter..... FC-5517 Hydraulic Oil Filter..... HC-5504 Hydraulic Oil Filter..... H-5517 Oil Filter Full Flow..... C-5522	
AP-1000B (ASPHALT PAVER) CAT S/N: 4TF84000-UP Fuel Filter Secondary..... FC-55151 Fuel Filter Secondary..... FC-5515 Fuel Filter..... FC-5516 Fuel Filter..... FC-5508 Oil Filter Full Flow..... C-5522		AP-1000D (ASPHALT PAVER) CAT S/N: EAD1-UP Air Filter Primary..... A-5558 Air Filter Secondary..... A-5559 Fuel Filter..... FC-5517 Hydraulic Oil Filter..... H-5517 Hydraulic Oil Filter..... HC-5504 Oil Filter Full Flow..... C-5522		AP-1000B (ASPHALT PAVER) CAT S/N: KHX1-UP Air Filter Secondary..... A-5567 Air Filter Set..... A-5568-S Air Filter Primary..... A-5566 Fuel Filter..... FC-5508 Oil Filter Full Flow..... C-5510	
AP-1000B (ASPHALT PAVER) CAT S/N: 98Z30400-UP Fuel Filter..... FC-5516 Fuel Filter Secondary..... FC-55151 Fuel Filter..... FC-5508 Fuel Filter Secondary..... FC-5515 Oil Filter Full Flow..... C-5522		AP-1000D (ASPHALT PAVER) CAT S/N: KHX1-UP Air Filter Primary..... A-5558 Air Filter Secondary..... A-5559 Fuel Filter..... FC-5517 Hydraulic Oil Filter..... H-5517 Hydraulic Oil Filter..... HC-5504 Oil Filter Full Flow..... C-5522		AP-1055 (ASPHALT PAVER) Air Filter Primary..... A-5566 Air Filter Set..... A-5568-S Air Filter Secondary..... A-5567 Fuel Filter Secondary..... FC-55151 Fuel Filter Secondary..... FC-5515 Fuel Filter..... FC-5508 Fuel Filter..... FC-5516 Oil Filter Full Flow..... C-5510	
AP-1000B (ASPHALT PAVER) S/N: 7HN1-253-UP Air Filter Primary..... A-5566 Air Filter Secondary..... A-5567 Air Filter Set..... A-5568-S Hydraulic Oil Filter..... HC-5507 Hydraulic Oil Filter..... HC-55220 Hydraulic Oil Filter..... H-5517		AP-1050B (ASPHALT PAVER) CAT 3116T Air Filter Set..... A-44180-S Air Filter Primary..... A-44180		AP-1055 (ASPHALT PAVER) Fuel Filter..... EF-55050	
AP-1000B (ASPHALT PAVER) S/N: 7HN254-311-UP Air Filter Set..... A-5568-S Air Filter Secondary..... A-5567 Air Filter Primary..... A-5566 Air Filter Primary..... A-5558 Air Filter Secondary..... A-5559 Hydraulic Oil Filter..... HC-5507 Hydraulic Oil Filter..... HC-55220 Hydraulic Oil Filter..... H-5517		AP-1050B (ASPHALT PAVER) CAT 3116 Air Filter Set..... A-5568-S Air Filter Set..... A-55071-S Air Filter Secondary..... A-5567 Air Filter Set..... A-5507-S Air Filter..... A-5530 Air Filter Primary..... A-5566 Air Filter Primary..... A-5507 Fuel Filter Secondary..... FC-5507 Fuel Filter Secondary..... FC-55151 Fuel Filter..... FC-5516 Fuel Filter..... F-5505 Fuel Filter..... FC-5508 Hydraulic Oil Filter..... H-57030 Hydraulic Oil Filter..... H-5517 Oil Filter Full Flow..... C-5510		AP1000F (ASPHALT PAVER) CAT C7.1 Fuel Filter..... EF-55050	
AP-1000B (ASPHALT PAVER) S/N: 7HN312-UP Air Filter Secondary..... A-5559 Air Filter Primary..... A-5558 Air Filter Primary..... A-5566 Air Filter Secondary..... A-5567 Air Filter Set..... A-5568-S Hydraulic Oil Filter..... H-5517 Hydraulic Oil Filter..... HC-55220 Hydraulic Oil Filter..... HC-5507		AP-1050B (ASPHALT PAVER) CAT S/N: A6P1-UP Air Filter Secondary..... A-5559 Air Filter Primary..... A-5558 Fuel Filter..... FC-5517 Hydraulic Oil Filter..... HC-5504 Hydraulic Oil Filter..... H-5517 Oil Filter Full Flow..... C-5522		AP1055F (ASPHALT PAVER) CAT C7.1 Fuel Filter..... EF-55050	
AP-1000B (ASPHALT PAVER) S/N: 7HN312-UP Air Filter Secondary..... A-5559 Air Filter Primary..... A-5558 Air Filter Primary..... A-5566 Air Filter Secondary..... A-5567 Air Filter Set..... A-5568-S Hydraulic Oil Filter..... H-5517 Hydraulic Oil Filter..... HC-55220 Hydraulic Oil Filter..... HC-5507		AP-1055D (ASPHALT PAVER) CAT S/N: A6P1-UP Air Filter Secondary..... A-5559 Air Filter Primary..... A-5558 Fuel Filter..... FC-5517 Hydraulic Oil Filter..... HC-5504 Hydraulic Oil Filter..... H-5517 Oil Filter Full Flow..... C-5522		AP-200 (ASPHALT PAVER) HATZ 2M40 Air Filter..... A-8678	
AP-1000B (ASPHALT PAVER) S/N: 7HN312-UP Air Filter Secondary..... A-5559 Air Filter Primary..... A-5558 Air Filter Primary..... A-5566 Air Filter Secondary..... A-5567 Air Filter Set..... A-5568-S Hydraulic Oil Filter..... H-5517 Hydraulic Oil Filter..... HC-55220 Hydraulic Oil Filter..... HC-5507		AP-1055D (ASPHALT PAVER) CAT S/N: A6P1-UP Air Filter Secondary..... A-5559 Air Filter Primary..... A-5558 Fuel Filter..... FC-5517 Hydraulic Oil Filter..... HC-5504 Hydraulic Oil Filter..... H-5517 Oil Filter Full Flow..... C-5522		AP-200B (ASPHALT PAVER) S/N: 2NK1-UP Air Filter..... A-8678 Fuel Filter..... FC-6205	
AP-1000B (ASPHALT PAVER) S/N: 7HN312-UP Air Filter Secondary..... A-5559 Air Filter Primary..... A-5558 Air Filter Primary..... A-5566 Air Filter Secondary..... A-5567 Air Filter Set..... A-5568-S Hydraulic Oil Filter..... H-5517 Hydraulic Oil Filter..... HC-55220 Hydraulic Oil Filter..... HC-5507		AP-1055D (ASPHALT PAVER) CAT S/N: A6P1-UP Air Filter Secondary..... A-5559 Air Filter Primary..... A-5558 Fuel Filter..... FC-5517 Hydraulic Oil Filter..... HC-5504 Hydraulic Oil Filter..... H-5517 Oil Filter Full Flow..... C-5522		AP-300 (ASPHALT PAVER) w/3054C Eng. Fuel/Water Separator..... SFC-43040	
AP-1000B (ASPHALT PAVER) S/N: 7HN312-UP Air Filter Secondary..... A-5559 Air Filter Primary..... A-5558 Air Filter Primary..... A-5566 Air Filter Secondary..... A-5567 Air Filter Set..... A-5568-S Hydraulic Oil Filter..... H-5517 Hydraulic Oil Filter..... HC-55220 Hydraulic Oil Filter..... HC-5507		AP-1055D (ASPHALT PAVER) CAT S/N: A6P1-UP Air Filter Secondary..... A-5559 Air Filter Primary..... A-5558 Fuel Filter..... FC-5517 Hydraulic Oil Filter..... HC-5504 Hydraulic Oil Filter..... H-5517 Oil Filter Full Flow..... C-5522		AP-300D (ASPHALT PAVER) w/C4.4 Eng. , 4400 Fuel/Water Separator..... SFC-43040	
AP-1000B (ASPHALT PAVER) S/N: 7HN312-UP Air Filter Secondary..... A-5559 Air Filter Primary..... A-5558 Air Filter Primary..... A-5566 Air Filter Secondary..... A-5567 Air Filter Set..... A-5568-S Hydraulic Oil Filter..... H-5517 Hydraulic Oil Filter..... HC-55220 Hydraulic Oil Filter..... HC-5507		AP-1055D (ASPHALT PAVER) CAT S/N: A6P1-UP Air Filter Secondary..... A-5559 Air Filter Primary..... A-5558 Fuel Filter..... FC-5517 Hydraulic Oil Filter..... HC-5504 Hydraulic Oil Filter..... H-5517 Oil Filter Full Flow..... C-5522		AP-650B (ASPHALT PAVER) CAT 3054C Air Filter Primary..... A-56731 Air Filter Set..... A-56731-S	

Sakura Filter

ENGINE APPLICATION

MODEL/APPLICATION	SAKURA NO	MODEL/APPLICATION	SAKURA NO	MODEL/APPLICATION	SAKURA NO
CATERPILLAR		CATERPILLAR		CATERPILLAR	
AP-650B (<i>ASPHALT PAVER</i>) CAT 3054C		AP-800C (<i>ASPHALT PAVER</i>) S/N: 1PM1-UP		Fuel Filter Secondary.....	FC-5515
Air Filter Secondary.....	A-56741	Air Filter Primary.....	A-5581	Hydraulic Oil Filter.....	H-5517
AP-650B (<i>ASPHALT PAVER</i>) CAT 7BJ1-UP		Air Filter Secondary.....	A-5582	Hydraulic Oil Filter.....	HC-5507
Air Filter Set.....	A-56731-S	Air Filter Set.....	A-5583-S	Hydraulic Oil Filter.....	HC-55220
Air Filter Secondary.....	A-56741	Hydraulic Oil Filter.....	H-5517	Oil Filter Full Flow.....	C-5522
Air Filter Primary.....	A-56731	Hydraulic Oil Filter.....	HC-5507	BG-2255C (<i>ASPHALT PAVER</i>) CAT (S/N: CPT1-UP)	
AP-650B (<i>ASPHALT PAVER</i>) CAT 3054TA		Hydraulic Oil Filter.....	HC-55220	Fuel Filter.....	FC-5517
Air Filter Set.....	A-4212-S	Hydraulic Oil Filter.....	HC-76080	Oil Filter Full Flow.....	C-5522
Air Filter Secondary.....	A-4211	AP-800D (<i>ASPHALT PAVER</i>) CAT (S/N: CRS1-UP)		BG-2255C (<i>ASPHALT PAVER</i>) S/N: B9G1-UP	
Air Filter Primary.....	A-4210	Oil Filter Full Flow.....	C-5102	Air Filter Secondary.....	A-5559
AP-650B (<i>ASPHALT PAVER</i>)		AP-800D (<i>ASPHALT PAVER</i>) S/N: A5P1-151-UP		Air Filter Primary.....	A-5558
Air Filter Primary.....	A-76600	Air Filter Set.....	A-5675-S	Hydraulic Oil Filter.....	H-5517
Oil Filter Full Flow.....	C-5102	Air Filter Primary.....	A-5673	Hydraulic Oil Filter.....	HC-5504
AP-650B (<i>ASPHALT PAVER</i>) w/3054C Eng.		Air Filter Secondary.....	A-8670	BG-2255C (<i>ASPHALT PAVER</i>) S/N: CKR1-UP	
Fuel/Water Separator.....	SFC-43040	Hydraulic Oil Filter.....	HC-55220	Air Filter Secondary.....	A-5559
AP-655C (<i>ASPHALT PAVER</i>) CAT (S/N: CPT1-UP)		Hydraulic Oil Filter.....	HC-5507	Air Filter Primary.....	A-5558
Fuel Filter.....	FC-5517	Hydraulic Oil Filter.....	H-5517	Hydraulic Oil Filter.....	HC-5504
Oil Filter Full Flow.....	C-5522	AP-800D (<i>ASPHALT PAVER</i>) S/N: A5P152-UP		Hydraulic Oil Filter.....	H-5517
AP-655C (<i>ASPHALT PAVER</i>) S/N: AYP1-UP		Air Filter Set.....	A-5675-S	BG-225C (<i>ASPHALT PAVER</i>) CAT 7BJ1-UP , 2011	
Air Filter Primary.....	A-5558	Air Filter Primary.....	A-5673	Air Filter Primary.....	A-56731
Air Filter Secondary.....	A-5559	Air Filter Secondary.....	A-8670	Air Filter Secondary.....	A-56741
Hydraulic Oil Filter.....	HC-5504	Hydraulic Oil Filter.....	HC-55220	Air Filter Set.....	A-56731-S
Hydraulic Oil Filter.....	H-5517	Hydraulic Oil Filter.....	HC-5507	BG-225C (<i>ASPHALT PAVER</i>) CAT (S/N: 5HK59985-UP)	
AP-655C (<i>ASPHALT PAVER</i>) S/N: CDG1-UP		Hydraulic Oil Filter.....	H-5517	Oil Filter Full Flow.....	C-5102
Air Filter Secondary.....	A-5559	AP-800D (<i>ASPHALT PAVER</i>) w/3054C Eng.		BG-225C (<i>ASPHALT PAVER</i>) CAT (S/N: 7BJ1-UP)	
Air Filter Primary.....	A-5558	Fuel/Water Separator.....	SFC-43040	Air Filter Primary.....	A-5673
Hydraulic Oil Filter.....	H-5517	AP-800 (<i>ASPHALT PAVER</i>) PERKINS 4.236		Air Filter Secondary.....	A-8670
Hydraulic Oil Filter.....	HC-5504	Air Filter Set.....	AS-5656-S	Air Filter Set.....	A-5675-S
AP-800B (<i>ASPHALT PAVER</i>) S/N: 1BF1-224		Air Filter Primary.....	AS-7805	Oil Filter Full Flow.....	C-5102
Air Filter Set.....	AS-5656-S	Fuel Filter.....	FC-5103	BG-225C (<i>ASPHALT PAVER</i>) CAT (S/N: CRS2700-UP)	
Air Filter Primary.....	AS-7805	AP-900B (<i>ASPHALT PAVER</i>) CAT S/N: 98Z31739-UP		Oil Filter Full Flow.....	C-5102
Fuel Filter.....	FC-5103	Air Filter Secondary.....	A-5567	BG-225C (<i>ASPHALT PAVER</i>) CAT 3054C	
AP-800C (<i>ASPHALT PAVER</i>) CAT (S/N: 5HK1-UP)		Air Filter Set.....	A-5568-S	Air Filter Primary.....	A-4210
Oil Filter Full Flow.....	C-5102	Air Filter Primary.....	A-5566	Air Filter Secondary.....	A-4211
AP-800C (<i>ASPHALT PAVER</i>) CAT (S/N: 7BJ1-UP)		Fuel Filter Secondary.....	FC-55151	Air Filter Set.....	A-4212-S
Air Filter Primary.....	A-5673	Fuel Filter.....	FC-5508	BG-225C (<i>ASPHALT PAVER</i>) S/N: 5GN1-503-UP	
Air Filter Secondary.....	A-8670	Fuel Filter.....	FC-5516	Air Filter Primary.....	A-76600
Air Filter Set.....	A-5675-S	Fuel Filter Secondary.....	FC-5515	Hydraulic Oil Filter.....	H-5517
Oil Filter Full Flow.....	C-5102	Hydraulic Oil Filter.....	H-5517	Hydraulic Oil Filter.....	HC-55220
AP-800C (<i>ASPHALT PAVER</i>) CAT 7BJ1-UP		Hydraulic Oil Filter.....	HC-55220	Hydraulic Oil Filter.....	HC-5507
Air Filter Set.....	A-56731-S	Hydraulic Oil Filter.....	HC-5507	BG-225C (<i>ASPHALT PAVER</i>) S/N: 5GN504-UP	
Air Filter Primary.....	A-56731	Oil Filter Full Flow.....	C-5522	Air Filter Primary.....	A-76600
Air Filter Secondary.....	A-56741	AP-900B (<i>ASPHALT PAVER</i>) CAT S/N: AGJ1-UP		Hydraulic Oil Filter.....	HC-55220
AP-800C (<i>ASPHALT PAVER</i>) CAT 7BJ1-UP		Air Filter Secondary.....	A-5567	Hydraulic Oil Filter.....	HC-5507
Air Filter Set.....	A-56731-S	Air Filter Primary.....	A-5566	BG-225C (<i>ASPHALT PAVER</i>) S/N: 5GN504-UP	
Air Filter Primary.....	A-56731	Air Filter Set.....	A-5568-S	Air Filter Primary.....	A-76600
Air Filter Secondary.....	A-56741	Fuel Filter Secondary.....	FC-55151	Hydraulic Oil Filter.....	HC-55220
AP-800C (<i>ASPHALT PAVER</i>) CAT 7BJ1-UP		Fuel Filter.....	FC-5516	Hydraulic Oil Filter.....	H-5517
Air Filter Set.....	A-56731-S	Fuel Filter.....	FC-5508	Hydraulic Oil Filter.....	HC-5507
Air Filter Primary.....	A-56731	Fuel Filter.....	FC-5508		
Air Filter Secondary.....	A-56741				

MODEL/APPLICATION	SAKURA NO	MODEL/APPLICATION	SAKURA NO	MODEL/APPLICATION	SAKURA NO
CATERPILLAR		CATERPILLAR		CATERPILLAR	
BG-225C (<i>ASPHALT PAVER</i>) S/N: B6G1-UP		Hydraulic Oil Filter.....	HC-5507	Hydraulic Oil Filter.....	H-5517
Hydraulic Oil Filter.....	HC-5507	Hydraulic Oil Filter.....	H-5517	Hydraulic Oil Filter.....	HC-55220
Hydraulic Oil Filter.....	H-5517	Oil Filter Full Flow.....	C-5522	Hydraulic Oil Filter.....	HC-5507
Hydraulic Oil Filter.....	HC-55220	BG-2455C (<i>ASPHALT PAVER</i>) CAT (S/N: 98Z1135-16275-UP)		BG-2455D (<i>ASPHALT PAVER</i>) CAT S/N: BNM1-UP	
BG-225C (<i>ASPHALT PAVER</i>) w/3054C Eng.		Fuel Filter Secondary.....	FC-5515	Air Filter Primary.....	A-5558
Fuel/Water Separator.....	SFC-43040	Fuel Filter.....	FC-5516	Air Filter Secondary.....	A-5559
BG-230 (<i>ASPHALT PAVER</i>) CAT (S/N: 5HK1-UP)		Fuel Filter Secondary.....	FC-55151	Fuel Filter.....	FC-5517
Oil Filter Full Flow.....	C-5102	Oil Filter Full Flow.....	C-5510	Hydraulic Oil Filter.....	H-5517
BG-230 (<i>ASPHALT PAVER</i>) CAT (S/N: 7BJ1-UP)		Oil Filter Full Flow.....	C-5522	Hydraulic Oil Filter.....	HC-5504
Air Filter Secondary.....	A-8670	BG-2455C (<i>ASPHALT PAVER</i>) CAT (S/N: 98Z16276-30399-UP)		Oil Filter Full Flow.....	C-5522
Air Filter Primary.....	A-5673	Fuel Filter.....	FC-5508	BG-2455D (<i>ASPHALT PAVER</i>) CAT S/N: BXW1-UP	
Air Filter Set.....	A-5675-S	Fuel Filter Secondary.....	FC-5515	Air Filter Primary.....	A-5558
Oil Filter Full Flow.....	C-5102	Fuel Filter Secondary.....	FC-55151	Air Filter Secondary.....	A-5559
BG-230 (<i>ASPHALT PAVER</i>) CAT (S/N: 9RM1-UP)		Fuel Filter.....	FC-5516	Fuel Filter.....	FC-5517
Oil Filter Full Flow.....	C-5102	Oil Filter Full Flow.....	C-5522	Hydraulic Oil Filter.....	HC-5504
BG-230 (<i>ASPHALT PAVER</i>) CAT 7B31-UP		BG-2455C (<i>ASPHALT PAVER</i>) CAT S/N: 4TF84000-UP		Hydraulic Oil Filter.....	H-5517
Air Filter Primary.....	A-56731	Fuel Filter Secondary.....	FC-5515	Oil Filter Full Flow.....	C-5522
Air Filter Set.....	A-56731-S	Fuel Filter.....	FC-5516	BG-2455D (<i>ASPHALT PAVER</i>) CAT S/N: KHX1-UP	
Air Filter Secondary.....	A-56741	Fuel Filter.....	FC-5508	Air Filter Secondary.....	A-5559
BG-230 (<i>ASPHALT PAVER</i>) S/N: 9AL1-UP		Fuel Filter Secondary.....	FC-55151	Air Filter Primary.....	A-5558
Air Filter Set.....	A-5583-S	Fuel Filter.....	FC-5516	Fuel Filter.....	FC-5517
Air Filter Primary.....	A-5581	Fuel Filter Secondary.....	FC-5515	Hydraulic Oil Filter.....	HC-5504
Air Filter Secondary.....	A-5582	Fuel Filter.....	FC-5508	Hydraulic Oil Filter.....	H-5517
Hydraulic Oil Filter.....	HC-76080	Oil Filter Full Flow.....	C-5522	Hydraulic Oil Filter.....	HC-55220
Hydraulic Oil Filter.....	H-5517	BG-2455C (<i>ASPHALT PAVER</i>) S/N: 6TN1-UP		Hydraulic Oil Filter.....	HC-5507
Hydraulic Oil Filter.....	HC-55220	Air Filter Set.....	A-5568-S	BG-245C (<i>ASPHALT PAVER</i>) CAT (S/N: 98Z1135-16275-UP)	
Hydraulic Oil Filter.....	HC-5507	Air Filter Primary.....	A-5566	Fuel Filter.....	FC-5516
BG-240C (<i>ASPHALT PAVER</i>) CAT S/N: 98Z31739-UP		Air Filter Secondary.....	A-5567	Fuel Filter Secondary.....	FC-55151
Air Filter Set.....	A-5568-S	Hydraulic Oil Filter.....	H-5517	Fuel Filter Secondary.....	FC-5515
Air Filter Secondary.....	A-5567	Hydraulic Oil Filter.....	HC-5507	Fuel Filter.....	FC-5508
Air Filter Primary.....	A-5566	Hydraulic Oil Filter.....	HC-55220	Oil Filter Full Flow.....	C-5522
Fuel Filter Secondary.....	FC-55151	BG-2455C (<i>ASPHALT PAVER</i>) S/N: ACM1-252-UP		BG-245C (<i>ASPHALT PAVER</i>) CAT (S/N: 98Z30400-UP)	
Fuel Filter.....	FC-5516	Air Filter Set.....	A-5568-S	Fuel Filter.....	FC-5508
Fuel Filter Secondary.....	FC-5515	Air Filter Secondary.....	A-5567	Fuel Filter.....	FC-5516
Fuel Filter.....	FC-5508	Air Filter Primary.....	A-5566	Fuel Filter Secondary.....	FC-5515
Hydraulic Oil Filter.....	H-5517	Hydraulic Oil Filter.....	HC-5507	Fuel Filter.....	FC-5508
Hydraulic Oil Filter.....	HC-55220	Hydraulic Oil Filter.....	H-5517	Fuel Filter Secondary.....	FC-55151
Hydraulic Oil Filter.....	HC-5507	Hydraulic Oil Filter.....	HC-55220	Oil Filter Full Flow.....	C-5522
Oil Filter Full Flow.....	C-5522	BG-2455C (<i>ASPHALT PAVER</i>) S/N: ACM253-UP		BG-245C (<i>ASPHALT PAVER</i>) S/N: 4XN1-109-UP	
BG-240C (<i>ASPHALT PAVER</i>) CAT S/N: AGL1-UP		Air Filter Secondary.....	A-5559	Air Filter Set.....	A-5568-S
Air Filter Set.....	A-5568-S	Air Filter Primary.....	A-5558	Air Filter Secondary.....	A-5567
Air Filter Secondary.....	A-5567	Hydraulic Oil Filter.....	HC-5507	Air Filter Primary.....	A-5566
Air Filter Primary.....	A-5566	Hydraulic Oil Filter.....	H-5517	Hydraulic Oil Filter.....	H-5517
Fuel Filter Secondary.....	FC-55151	Hydraulic Oil Filter.....	HC-55220	Hydraulic Oil Filter.....	HC-55220
Fuel Filter Secondary.....	FC-5515	BG-2455C (<i>ASPHALT PAVER</i>) S/N: B2G1-UP		Hydraulic Oil Filter.....	HC-5507
Fuel Filter.....	FC-5516	Air Filter Secondary.....	A-5559	BG-245C (<i>ASPHALT PAVER</i>) S/N: 4XN110-UP	
Fuel Filter.....	FC-5508	Air Filter Primary.....	A-5558	Air Filter Set.....	A-5568-S
Hydraulic Oil Filter.....	H-5517	Hydraulic Oil Filter.....	HC-5507	Air Filter Secondary.....	A-5567
Hydraulic Oil Filter.....	HC-55220	Hydraulic Oil Filter.....	H-5517	Air Filter Primary.....	A-5566
Hydraulic Oil Filter.....	HC-5507	Hydraulic Oil Filter.....	HC-55220	Hydraulic Oil Filter.....	H-5517
Oil Filter Full Flow.....	C-5522	BG-2455C (<i>ASPHALT PAVER</i>) S/N: B2G1-UP		Hydraulic Oil Filter.....	HC-55220
BG-240C (<i>ASPHALT PAVER</i>) CAT S/N: AGL1-UP		Air Filter Secondary.....	A-5559	Hydraulic Oil Filter.....	HC-5507
Air Filter Set.....	A-5568-S	Air Filter Primary.....	A-5558	BG-245C (<i>ASPHALT PAVER</i>) S/N: 4XN110-UP	
Air Filter Secondary.....	A-5567	Hydraulic Oil Filter.....	HC-5507	Air Filter Set.....	A-5568-S
Air Filter Primary.....	A-5566	Hydraulic Oil Filter.....	H-5517	Air Filter Secondary.....	A-5567
Fuel Filter Secondary.....	FC-55151	Hydraulic Oil Filter.....	HC-55220	Air Filter Primary.....	A-5566
Fuel Filter Secondary.....	FC-5515	BG-2455C (<i>ASPHALT PAVER</i>) S/N: B2G1-UP		Hydraulic Oil Filter.....	H-5517
Fuel Filter.....	FC-5516	Air Filter Secondary.....	A-5559	Hydraulic Oil Filter.....	HC-55220
Fuel Filter.....	FC-5508	Air Filter Primary.....	A-5558	Hydraulic Oil Filter.....	HC-5507
Hydraulic Oil Filter.....	H-5517	Hydraulic Oil Filter.....	HC-5507	BG-245C (<i>ASPHALT PAVER</i>) S/N: 4XN110-UP	
Hydraulic Oil Filter.....	HC-55220	Air Filter Secondary.....	A-5559	Air Filter Set.....	A-5568-S
Hydraulic Oil Filter.....	HC-5507	Air Filter Primary.....	A-5558	Air Filter Secondary.....	A-5567
Oil Filter Full Flow.....	C-5522	Hydraulic Oil Filter.....	HC-5507	Air Filter Primary.....	A-5566
BG-240C (<i>ASPHALT PAVER</i>) CAT S/N: AGL1-UP		Hydraulic Oil Filter.....	H-5517	Hydraulic Oil Filter.....	H-5517
Air Filter Set.....	A-5568-S	Hydraulic Oil Filter.....	HC-55220	Hydraulic Oil Filter.....	HC-55220
Air Filter Secondary.....	A-5567	BG-2455C (<i>ASPHALT PAVER</i>) S/N: B2G1-UP		Hydraulic Oil Filter.....	HC-5507
Air Filter Primary.....	A-5566	Air Filter Secondary.....	A-5559	BG-245C (<i>ASPHALT PAVER</i>) S/N: 4XN110-UP	
Fuel Filter Secondary.....	FC-55151	Air Filter Primary.....	A-5558	Air Filter Set.....	A-5568-S
Fuel Filter Secondary.....	FC-5515	Hydraulic Oil Filter.....	HC-5507	Air Filter Secondary.....	A-5567
Fuel Filter.....	FC-5516	Hydraulic Oil Filter.....	H-5517	Air Filter Primary.....	A-5566
Fuel Filter.....	FC-5508	Hydraulic Oil Filter.....	HC-55220	Hydraulic Oil Filter.....	H-5517
Hydraulic Oil Filter.....	H-5517	BG-2455C (<i>ASPHALT PAVER</i>) S/N: B2G1-UP		Hydraulic Oil Filter.....	HC-55220
Hydraulic Oil Filter.....	HC-55220	Air Filter Secondary.....	A-5559	Hydraulic Oil Filter.....	HC-5507
Hydraulic Oil Filter.....	HC-5507	Air Filter Primary.....	A-5558	BG-245C (<i>ASPHALT PAVER</i>) S/N: 4XN110-UP	
Oil Filter Full Flow.....	C-5522	Hydraulic Oil Filter.....	HC-5507	Air Filter Set.....	A-5568-S
BG-240C (<i>ASPHALT PAVER</i>) CAT S/N: AGL1-UP		Hydraulic Oil Filter.....	H-5517	Air Filter Secondary.....	A-5567
Air Filter Set.....	A-5568-S	Hydraulic Oil Filter.....	HC-55220	Air Filter Primary.....	A-5566
Air Filter Secondary.....	A-5567	BG-2455C (<i>ASPHALT PAVER</i>) S/N: B2G1-UP		Hydraulic Oil Filter.....	H-5517
Air Filter Primary.....	A-5566	Air Filter Secondary.....	A-5559	Hydraulic Oil Filter.....	HC-55220
Fuel Filter Secondary.....	FC-55151	Air Filter Primary.....	A-5558	Hydraulic Oil Filter.....	HC-5507
Fuel Filter Secondary.....	FC-5515	Hydraulic Oil Filter.....	HC-5507	BG-245C (<i>ASPHALT PAVER</i>) S/N: 4XN110-UP	
Fuel Filter.....	FC-5516	Hydraulic Oil Filter.....	H-5517	Air Filter Set.....	A-5568-S
Fuel Filter.....	FC-5508	Hydraulic Oil Filter.....	HC-55220	Air Filter Secondary.....	A-5567
Hydraulic Oil Filter.....	H-5517	BG-2455C (<i>ASPHALT PAVER</i>) S/N: B2G1-UP		Air Filter Primary.....	A-5566
Hydraulic Oil Filter.....	HC-55220	Air Filter Secondary.....	A-5559	Hydraulic Oil Filter.....	H-5517
Hydraulic Oil Filter.....	HC-5507	Air Filter Primary.....	A-5558	Hydraulic Oil Filter.....	HC-55220
Oil Filter Full Flow.....	C-5522	Hydraulic Oil Filter.....	HC-5507	Hydraulic Oil Filter.....	HC-5507

MODEL/APPLICATION	SAKURA NO	MODEL/APPLICATION	SAKURA NO	MODEL/APPLICATION	SAKURA NO
CATERPILLAR		CATERPILLAR		CATERPILLAR	
BG-245C (<i>ASPHALT PAVER</i>) S/N: 4XN110-UP		Hydraulic Oil Filter.....	HC-5507	Cabin Air Filter.....	CA-55150
Air Filter Primary.....	A-5566	BG-260C (<i>ASPHALT PAVER</i>) S/N: BYG1-UP		CB-14 (<i>COMPACTORS</i>) S/N: CAA1-UP , 2007-UP	
Air Filter Secondary.....	A-5559	Air Filter Primary.....	A-5558	Oil Filter Full Flow.....	C-1123
Air Filter Set.....	A-5568-S	Air Filter Secondary.....	A-5559	CB-214C (<i>COMPACTORS</i>) S/N: 9XK00826-UP	
Air Filter Secondary.....	A-5567	Hydraulic Oil Filter.....	H-5517	Air Filter.....	A-8678
Air Filter Primary.....	A-5558	Hydraulic Oil Filter.....	HC-55220	Hydraulic Oil Filter.....	HC-5504
Hydraulic Oil Filter.....	HC-5507	Hydraulic Oil Filter.....	HC-5507	CB-214C (<i>COMPACTORS</i>) S/N: 9XK1-UP	
Hydraulic Oil Filter.....	HC-55220	BG-260C (<i>ASPHALT PAVER</i>) S/N: BYG205-UP		Air Filter.....	A-8678
Hydraulic Oil Filter.....	H-5517	Air Filter Secondary.....	A-5559	Hydraulic Oil Filter.....	HC-5504
BG-260C (<i>ASPHALT PAVER</i>) CAT (S/N: 98Z16051-30399-UP)		Air Filter Primary.....	A-5558	CB-214D (<i>COMPACTORS</i>) CAT S/N: 1T21-UP , 2007-UP	
Fuel Filter.....	FC-5516	Hydraulic Oil Filter.....	HC-5507	Air Filter Secondary.....	A-5569
Fuel Filter Secondary.....	FC-5515	Hydraulic Oil Filter.....	H-5517	Hydraulic Oil Filter.....	HC-5507
Fuel Filter.....	FC-5508	Hydraulic Oil Filter.....	HC-55220	Hydraulic Oil Filter.....	HC-55220
Fuel Filter Secondary.....	FC-55151	BG-260D (<i>ASPHALT PAVER</i>) CAT S/N: BPW1-UP		Oil Filter Full Flow.....	C-1906
Oil Filter Full Flow.....	C-5522	Air Filter Secondary.....	A-5559	Oil Filter Full Flow.....	C-1123
BG-260C (<i>ASPHALT PAVER</i>) CAT S/N: 4TF84000-UP		Air Filter Primary.....	A-5558	CB-214D (<i>COMPACTORS</i>) CAT S/N: 4ZW1-UP , 2007-UP	
Fuel Filter.....	FC-5516	Fuel Filter.....	FC-5517	Air Filter Secondary.....	A-5569
Fuel Filter Secondary.....	FC-55151	Hydraulic Oil Filter.....	HC-5504	Hydraulic Oil Filter.....	HC-5507
Fuel Filter Secondary.....	FC-5515	Hydraulic Oil Filter.....	H-5517	Hydraulic Oil Filter.....	HC-55220
Fuel Filter.....	FC-5508	Oil Filter Full Flow.....	C-5522	Oil Filter Full Flow.....	C-1123
Oil Filter Full Flow.....	C-5522	BG-260D (<i>ASPHALT PAVER</i>) CAT S/N: KHX1-UP		Oil Filter Full Flow.....	C-1906
BG-260C (<i>ASPHALT PAVER</i>) CAT S/N: 98Z30400-UP		Air Filter Secondary.....	A-5559	CB-224D (<i>COMPACTORS</i>) CAT 3013 (S/N: 8RZ1-UP)	
Fuel Filter.....	FC-5508	Air Filter Primary.....	A-5558	Air Filter Secondary.....	A-5569
Fuel Filter Secondary.....	FC-55151	Fuel Filter.....	FC-5517	Hydraulic Oil Filter.....	HC-5507
Fuel Filter Secondary.....	FC-5515	Hydraulic Oil Filter.....	H-5517	Hydraulic Oil Filter.....	HC-55220
Fuel Filter.....	FC-5516	Hydraulic Oil Filter.....	HC-5504	Oil Filter Full Flow.....	C-1123
Oil Filter Full Flow.....	C-5522	Oil Filter Full Flow.....	C-5522	Oil Filter Full Flow.....	C-1906
BG-260C (<i>ASPHALT PAVER</i>) S/N: 8GN1-547-UP		BG-230D (<i>ASPHALT PAVER</i>) CAT S/N: B4G1-UP		CB-225D (<i>COMPACTORS</i>) CAT S/N: 4ZW1-UP	
Air Filter Primary.....	A-5566	Air Filter Primary.....	A-5673	Air Filter Secondary.....	A-5569
Air Filter Set.....	A-5568-S	Air Filter Secondary.....	A-8670	Hydraulic Oil Filter.....	HC-5507
Air Filter Secondary.....	A-5567	Air Filter Set.....	A-5675-S	Oil Filter Full Flow.....	C-1123
Hydraulic Oil Filter.....	HC-55220	Hydraulic Oil Filter.....	HC-55220	Oil Filter Full Flow.....	C-1906
Hydraulic Oil Filter.....	H-5517	Hydraulic Oil Filter.....	H-5517	CB-225D (<i>COMPACTORS</i>) CAT S/N: 9FZ1-UP	
Hydraulic Oil Filter.....	HC-5507	Hydraulic Oil Filter.....	HC-5507	Air Filter Secondary.....	A-5569
BG-260C (<i>ASPHALT PAVER</i>) S/N: 8GN548-576-UP		Oil Filter Full Flow.....	C-5102	Hydraulic Oil Filter.....	HC-5507
Air Filter Secondary.....	A-5559	BG-230D (<i>ASPHALT PAVER</i>) CAT S/N: CRS1-UP		Oil Filter Full Flow.....	C-1123
Air Filter Set.....	A-5568-S	Air Filter Secondary.....	A-8670	CB-214B (<i>COMPACTORS</i>) S/N: 6LF1-UP	
Air Filter Secondary.....	A-5567	Air Filter Primary.....	A-5673	Air Filter.....	A-8678
Air Filter Primary.....	A-5566	Air Filter Set.....	A-5675-S	CB-214E (<i>COMPACTORS</i>) CAT 3013C (S/N: 2141-UP)	
Air Filter Primary.....	A-5558	Hydraulic Oil Filter.....	HC-5507	Air Filter Secondary.....	A-5569
Hydraulic Oil Filter.....	HC-5507	Hydraulic Oil Filter.....	HC-55220	Hydraulic Oil Filter.....	HC-5507
Hydraulic Oil Filter.....	H-5517	Hydraulic Oil Filter.....	H-5517	Oil Filter Full Flow.....	C-1123
Hydraulic Oil Filter.....	HC-55220	Oil Filter Full Flow.....	C-5102	CB-224E (<i>COMPACTORS</i>) CAT 3013C (S/N: 2241-UP)	
BG-260C (<i>ASPHALT PAVER</i>) S/N: 8GN577-UP		BG-650 (<i>ASPHALT PAVER</i>) CAT (S/N: 5HK1-UP)		Air Filter Secondary.....	A-5569
Air Filter Primary.....	A-5566	Oil Filter Full Flow.....	C-5102	Hydraulic Oil Filter.....	HC-5507
Air Filter Set.....	A-5568-S	BG-650 (<i>ASPHALT PAVER</i>) CAT (S/N: 9RM1-UP)		Oil Filter Full Flow.....	C-1123
Air Filter Secondary.....	A-5567	Oil Filter Full Flow.....	C-5102	CB-224E (<i>COMPACTORS</i>) CAT 3013C (S/N: 2241-UP)	
Air Filter Primary.....	A-5558	C54B (<i>COMPACTORS</i>) w/C4.4 Eng. , 4400		Air Filter Secondary.....	A-5569
Air Filter Secondary.....	A-5559			Hydraulic Oil Filter.....	HC-5507
Air Filter Secondary.....	A-5567			Oil Filter Full Flow.....	C-1123
Hydraulic Oil Filter.....	H-5517				
Hydraulic Oil Filter.....	HC-55220				

MODEL/APPLICATION	SAKURA NO	MODEL/APPLICATION	SAKURA NO	MODEL/APPLICATION	SAKURA NO
CATERPILLAR		CATERPILLAR		CATERPILLAR	
CB-434 (COMPACTORS) CAT S/N: 3TF1-UP		CB-434C (COMPACTORS) CAT S/N: 4DN1-UP , 2005-UP		Oil Filter Full Flow.....	C-5102
Hydraulic Oil Filter.....	H-7916	Air Filter Set.....	A-5675-S	CB-534B (COMPACTORS) CAT 3054T	
Oil Filter Full Flow.....	C-5522	Air Filter Set.....	A-5537-S	Air Filter Primary.....	A-4210
Oil Filter Full Flow.....	C-5505	Air Filter Secondary.....	A-5536	Air Filter Set.....	A-4212-S
		Air Filter Secondary.....	A-8670	Air Filter Secondary.....	A-4211
		Air Filter Primary.....	A-5537		
CB-434 (COMPACTORS) CAT S/N: 5EF1-UP		Air Filter Primary.....	A-5673	CB-534B (COMPACTORS) S/N: 4JL1-UP	
Air Filter Set.....	A-5568-S	Hydraulic Oil Filter.....	HC-5504	Hydraulic Oil Filter.....	HC-5504
Air Filter.....	A-5530	Oil Filter Full Flow.....	C-5102	Oil Filter Full Flow.....	C-5102
Air Filter Set.....	A-5507-S				
Air Filter Set.....	A-55071-S	CB-434C (COMPACTORS) CAT S/N: 4MW1-UP , 2005-UP		CB-534C (COMPACTORS) CAT 7BJ1-UP , 2011	
Air Filter Primary.....	A-5566	Air Filter Set.....	A-5675-S	Air Filter Primary.....	A-56731
Air Filter Secondary.....	A-5567	Air Filter Set.....	A-5537-S	Air Filter Set.....	A-56731-S
Air Filter Primary.....	A-5507	Air Filter Secondary.....	A-8670	Air Filter Secondary.....	A-56741
Fuel Filter Secondary.....	FC-5507	Air Filter Primary.....	A-5537		
Oil Filter Full Flow.....	C-5505	Air Filter Secondary.....	A-5536	CB-534C (COMPACTORS) CAT 3054T	
Oil Filter Full Flow.....	C-5522	Air Filter Primary.....	A-5673	Air Filter Primary.....	A-4210
		Hydraulic Oil Filter.....	HC-5504	Air Filter Set.....	A-4212-S
		Oil Filter Full Flow.....	C-5102	Air Filter Secondary.....	A-4211
CB-434 (COMPACTORS) CAT S/N: 97Z1-UP					
Air Filter Primary.....	A-5507	CB-434C (COMPACTORS) CAT S/N: 5H5330-UP , 2005-UP		CB-534D (COMPACTORS) CAT 3054C (S/N: FGH1-UP) , 2004-UP	
Air Filter Primary.....	A-5566	Air Filter Set.....	A-5537-S	Air Filter Primary.....	A-5673
Air Filter Set.....	A-55071-S	Air Filter Primary.....	A-5537	Air Filter Set.....	A-5675-S
Air Filter Set.....	A-5568-S	Air Filter Secondary.....	A-5536	Air Filter Secondary.....	A-8670
Air Filter.....	A-5530	Hydraulic Oil Filter.....	HC-5504	Hydraulic Oil Filter.....	HC-5504
Air Filter Set.....	A-5507-S			Oil Filter Full Flow.....	C-5102
Air Filter Secondary.....	A-5567	CB-434C (COMPACTORS) CAT S/N: 7BJ1-UP , 2005-UP		CB-534D (COMPACTORS) CAT 3054C	
Fuel Filter Secondary.....	FC-5507	Air Filter Primary.....	A-5537	Air Filter Primary.....	A-56731
Hydraulic Oil Filter.....	H-7916	Air Filter Primary.....	A-5673	Air Filter Set.....	A-56731-S
Oil Filter Full Flow.....	C-5522	Air Filter Set.....	A-5675-S	Air Filter Secondary.....	A-56741
Oil Filter Full Flow.....	C-5505	Air Filter Secondary.....	A-8670		
		Air Filter Set.....	A-5537-S	CB-534D (COMPACTORS) w/3054C Eng.	
		Air Filter Secondary.....	A-5536	Fuel/Water Separator.....	SFC-43040
CB-434B (COMPACTORS) CAT S/N: 5HK1-20499-UP		Hydraulic Oil Filter.....	HC-5504	CB-534D (COMPACTORS) CAT 3054C	
Air Filter Set.....	A-5537-S	Oil Filter Full Flow.....	C-5102	Air Filter Primary.....	A-56731
Air Filter Secondary.....	A-5536			Air Filter Set.....	A-56731-S
Air Filter Primary.....	A-5537	CB-434C (COMPACTORS) CAT S/N: 7BJ1-UP , 2005-UP		Air Filter Secondary.....	A-56741
Hydraulic Oil Filter.....	HC-5504	Air Filter Primary.....	A-5537	Air Filter Set.....	A-56731-S
Oil Filter Full Flow.....	C-5102	Air Filter Primary.....	A-5673		
		Air Filter Set.....	A-5675-S	CB-534D (COMPACTORS) w/3054C Eng.	
CB-434B (COMPACTORS) CAT S/N: 6AL1-87-UP		Air Filter Secondary.....	A-8670	Fuel/Water Separator.....	SFC-43040
Air Filter Set.....	A-5537-S	Air Filter Set.....	A-5537-S	CB-535B (COMPACTORS) CAT 7BJ1-UP , 2011	
Air Filter Primary.....	A-5537	Air Filter Secondary.....	A-5536	Air Filter Primary.....	A-56731
Air Filter Secondary.....	A-5536	Hydraulic Oil Filter.....	HC-5504	Air Filter Secondary.....	A-56741
Hydraulic Oil Filter.....	HC-5504	Oil Filter Full Flow.....	C-5102	Air Filter Set.....	A-56731-S
Oil Filter Full Flow.....	C-5102				
CB-434B (COMPACTORS) CAT S/N: 7YN1-UP		CB-434D (COMPACTORS) w/3054C Eng.		CB-535B (COMPACTORS) CAT (S/N: 5HK20500-UP)	
Air Filter Set.....	A-5537-S	Fuel/Water Separator.....	SFC-43040	Oil Filter Full Flow.....	C-5102
Air Filter Primary.....	A-5537	CB-434D XW (COMPACTORS) w/3054C Eng.		CB-535B (COMPACTORS) CAT (S/N: 7BJ1-UP)	
Air Filter Secondary.....	A-5536	Fuel/Water Separator.....	SFC-43040	Air Filter Set.....	A-5675-S
Hydraulic Oil Filter.....	HC-5504	CB44B (COMPACTORS) W/C3.4 ENG. , 3400		Air Filter Secondary.....	A-8670
Oil Filter Full Flow.....	C-5102	Cabin Air Filter.....	CA-55150	Air Filter Primary.....	A-5673
		CB46B (COMPACTORS) W/C3.4 ENG. , 3400		Oil Filter Full Flow.....	C-5102
CB-434B (COMPACTORS) S/N: 6AL1-UP		Cabin Air Filter.....	CA-55150	CB-535B (COMPACTORS) CAT (S/N: 9RM1-UP)	
Air Filter Primary.....	A-5537	CB-534B (COMPACTORS) PERKINS , 2008-UP		Oil Filter Full Flow.....	C-5102
Air Filter Secondary.....	A-5536	Air Filter Primary.....	A-76600	CB-535B (COMPACTORS) CAT 3054T	
Air Filter Set.....	A-5537-S	Hydraulic Oil Filter.....	HC-5504	Air Filter Set.....	A-4212-S
Oil Filter Full Flow.....	C-5102			Air Filter Secondary.....	A-4211

Sakura Filter

ENGINE APPLICATION

MODEL/APPLICATION	SAKURA NO	MODEL/APPLICATION	SAKURA NO	MODEL/APPLICATION	SAKURA NO
CATERPILLAR		CATERPILLAR		CATERPILLAR	
CB-535B (COMPACTORS) CAT 3054T Air Filter Primary.....	A-4210	Hydraulic Oil Filter.....	HC-5504	CB-534D XW (COMPACTORS) w/3054C Eng. Fuel/Water Separator.....	SFC-43040
CB-535B (COMPACTORS) CAT 7B31-UP Air Filter Set.....	A-56731-S	CB-564D (COMPACTORS) S/N: C6D1-108-UP Air Filter Secondary.....	A-8670	CB-54 (COMPACTORS) CAT C4.4 , 4400, 2012 Air Filter Primary.....	A-56731
Air Filter Primary.....	A-56731	Air Filter Set.....	A-5675-S	Air Filter Set.....	A-56731-S
Air Filter Secondary.....	A-56741	Air Filter Primary.....	A-5673	Air Filter Secondary.....	A-56741
CB-535B (COMPACTORS) S/N: 3AR1-UP Air Filter Primary.....	A-76600	Hydraulic Oil Filter.....	HC-5504	CB-54 XW (COMPACTORS) CAT C4.4 , 4400, 2012 Air Filter Primary.....	A-56731
Hydraulic Oil Filter.....	HC-5504	CB-564D (COMPACTORS) S/N: D4M1-UP Air Filter Secondary.....	A-8670	Air Filter Set.....	A-56731-S
CB-544 (COMPACTORS) CAT (S/N: 5HK22000-UP) Oil Filter Full Flow.....	C-5102	Air Filter Set.....	A-5675-S	Air Filter Secondary.....	A-56741
CB-544 (COMPACTORS) CAT (S/N: 9RM1-UP) Oil Filter Full Flow.....	C-5102	Air Filter Primary.....	A-5673	CB-54 XW (COMPACTORS) w/C4.4 Eng. Fuel/Water Separator.....	SFC-55170
CB-544 (COMPACTORS) S/N: 8FM1-148-UP Air Filter Primary.....	A-5541	Hydraulic Oil Filter.....	HC-5504	CB54B (COMPACTORS) w/C4.4 Eng. , 4400 Cabin Air Filter.....	CA-55150
Air Filter Primary.....	A-5541M	CB-564D (COMPACTORS) S/N: 3054C Eng. Fuel/Water Separator.....	SFC-43040	CB-634C (COMPACTORS) CAT (S/N: 9821230-3713-UP) Fuel Filter Secondary.....	FC-5507
Air Filter Secondary.....	A-5540	CB-514 (COMPACTORS) S/N: 6YD1-UP Fuel Filter.....	F-6505	Oil Filter Full Flow.....	C-5510
Air Filter Primary.....	A-76231	CB-524 (COMPACTORS) S/N: 6TD1-UP Fuel Filter.....	FC-5704	Oil Filter Full Flow.....	C-5522
Air Filter Set.....	A-5541M-S	CB-524 (COMPACTORS) S/N: 6WD1-UP Fuel Filter.....	FC-5704	CB-634C (COMPACTORS) CAT (S/N: 98221647-UP) Fuel Filter Secondary.....	FC-55151
Hydraulic Oil Filter.....	HC-5504	CB-525 (COMPACTORS) S/N: 6XD1-16-UP Fuel Filter.....	FC-5704	Fuel Filter.....	FC-5516
CB-544 (COMPACTORS) S/N: 8FM149-UP Air Filter Primary.....	A-5541	CB-525 (COMPACTORS) S/N: 6XD17-UP Fuel Filter.....	FC-5704	Fuel Filter Secondary.....	FC-5515
Air Filter Set.....	A-5541M-S	CB-534 (COMPACTORS) S/N: 2EG1-UP Fuel Filter.....	F-5505	Fuel Filter Secondary.....	FC-55151
Air Filter Primary.....	A-5541M	Oil Filter Full Flow.....	C-5510	Oil Filter Full Flow.....	C-5510
Air Filter Secondary.....	A-5540	CB-534 (COMPACTORS) S/N: 2YF1-UP Fuel Filter.....	F-5505	Oil Filter Full Flow.....	C-5522
Air Filter Primary.....	A-76231	Oil Filter Full Flow.....	C-5510	CB-634C (COMPACTORS) S/N: 3BR1-UP Air Filter Secondary.....	A-5567
Hydraulic Oil Filter.....	HC-5504	CB-534 (COMPACTORS) S/N: 2YF1-UP Fuel Filter.....	F-5505	Air Filter Set.....	A-5568-S
CB-545 (COMPACTORS) CAT (S/N: 5HK22000-UP) Oil Filter Full Flow.....	C-5102	Oil Filter Full Flow.....	C-5510	Air Filter Primary.....	A-5566
CB-545 (COMPACTORS) CAT (S/N: 9RM1-UP) Oil Filter Full Flow.....	C-5102	CB-534 (COMPACTORS) S/N: 2YF1-UP Fuel Filter.....	F-5505	Hydraulic Oil Filter.....	HC-5504
CB-545 (COMPACTORS) S/N: 2FS1-UP Air Filter Primary.....	A-76231	Oil Filter Full Flow.....	C-5510	CB-634C (COMPACTORS) S/N: 5CL1-UP Air Filter Set.....	A-5568-S
Air Filter Secondary.....	A-5540	CB-534D EAA1 (COMPACTORS) CAT 3054C , 2004 Air Filter Primary.....	A-56731	Air Filter Secondary.....	A-5567
Air Filter Primary.....	A-5541	Air Filter Set.....	A-56731-S	Air Filter Primary.....	A-5566
Air Filter Primary.....	A-5541M	Air Filter Secondary.....	A-56741	Hydraulic Oil Filter.....	HC-5504
Air Filter Set.....	A-5541M-S	CB-534D FGH1 (COMPACTORS) CAT 3054C , 2004 Air Filter Primary.....	A-56731	CB-634C (COMPACTORS) S/N: 7CD1-UP Fuel Filter Secondary.....	FC-5507
Hydraulic Oil Filter.....	HC-5504	Air Filter Set.....	A-56731-S	Oil Filter Full Flow.....	C-5519
CB-564D (COMPACTORS) CAT (S/N: CRS1-UP) Oil Filter Full Flow.....	C-5102	Air Filter Secondary.....	A-56741	CB-614 (COMPACTORS) S/N: 7CD1-UP Fuel Filter Secondary.....	FC-5507
CB-564D (COMPACTORS) S/N: C6D109-UP Air Filter Secondary.....	A-8670	CB-534D XW (COMPACTORS) CAT 3054C Air Filter Primary.....	A-56731	Oil Filter Full Flow.....	C-5519
Air Filter Set.....	A-5675-S	Air Filter Secondary.....	A-56741		
Air Filter Primary.....	A-5673	Air Filter Set.....	A-56731-S		

MODEL/APPLICATION	SAKURA NO
CATERPILLAR	
CB-624 (COMPACTORS) S/N: 7DD1-UP	
Air Filter Secondary.....	A-5550
Air Filter Secondary.....	A-5510
Air Filter Set.....	A-5522-S
Air Filter Primary.....	A-5549
Air Filter Set.....	A-5549M-S
Air Filter Primary.....	A-5549M
Air Filter Primary.....	A-5509
Fuel Filter Secondary.....	FC-5507
Oil Filter Full Flow.....	C-5519
CB-634 (COMPACTORS) S/N: 5CL1-UP	
Fuel Filter.....	FC-5516
Fuel Filter Secondary.....	FC-55151
Fuel Filter Secondary.....	FC-5507
Fuel Filter Secondary.....	FC-5515
Oil Filter Full Flow.....	C-5510
CB-64 (COMPACTORS) w/C4.4 Eng.	
Fuel/Water Separator.....	SFC-55170
CD44B (COMPACTORS) W/C3.4 ENG. , 3400	
Cabin Air Filter.....	CA-55150
CD-54 (COMPACTORS) w/3054C Eng.	
Fuel/Water Separator.....	SFC-43040
CHALLENGER 65 (TRACTORS) S/N: 7YC1-1116	
Air Filter Set.....	A-5544-S
Air Filter Primary.....	A-5558
Air Filter Primary.....	A-5543
Air Filter Secondary.....	A-5559
Fuel Filter Secondary.....	FC-5507
Hydraulic Oil Filter.....	HC-5503
Hydraulic Oil Filter.....	HC-5508
Oil Filter Full Flow.....	C-5510
CHALLENGER 65 (TRACTORS) S/N: 7YC1117-1899	
Air Filter Primary.....	A-5558
Air Filter Set.....	A-5544-S
Air Filter Primary.....	A-5543
Air Filter Secondary.....	A-5559
Fuel Filter Secondary.....	FC-5507
Hydraulic Oil Filter.....	HC-5503
Oil Filter Full Flow.....	C-5510
CHALLENGER 65B (TRACTORS) CAT 3306	
Air Filter Primary.....	A-5543
Air Filter Set.....	A-5573-S
Air Filter Primary.....	A-5535
Air Filter Set.....	A-5544-S
Air Filter Secondary.....	A-5534
Fuel Filter.....	FC-5523
Fuel Filter Secondary.....	FC-5507
Fuel Filter.....	FC-5501
Hydraulic Oil Filter.....	HC-5503

MODEL/APPLICATION	SAKURA NO
CATERPILLAR	
Hydraulic Oil Filter.....	HC-5508
Hydraulic Oil Filter.....	HC-5506
Oil Filter Full Flow.....	C-5510
CHALLENGER 65B (TRACTORS) S/N: 7YC1900-UP	
Air Filter Secondary.....	A-5559
Air Filter Primary.....	A-5558
Air Filter Set.....	A-5544-S
Air Filter Primary.....	A-5543
Fuel Filter Secondary.....	FC-5507
Hydraulic Oil Filter.....	HC-5503
Oil Filter Full Flow.....	C-5510
CHALLENGER 70C (TRACTORS) CAT 3306TA (S/N: 2YL1-UP)	
Air Filter Secondary.....	A-5534
Air Filter Primary.....	A-5509
Air Filter Set.....	A-5522-S
Air Filter Primary.....	A-5535
Air Filter Set.....	A-5573-S
Fuel Filter Secondary.....	FC-5507
Fuel Filter.....	F-5505
Fuel/Water Separator.....	SF-5704
Hydraulic Oil Filter.....	HC-5503
Oil Filter Full Flow.....	C-5510
CHALLENGER 70C (TRACTORS) w/3306 Eng.	
Air Filter Primary.....	A-5535M
Air Filter Set.....	A-5573M-S
CHALLENGER 75 (TRACTORS) CAT 3176 (S/N: 4CJ1-UP)	
Air Filter Primary.....	A-5558
Air Filter Set.....	A-5522-S
Air Filter Set.....	A-5544-S
Air Filter Primary.....	A-5543
Air Filter Secondary.....	A-5559
Air Filter Primary.....	A-5509
Air Filter Secondary.....	A-5522
Coolant Filter.....	WC-5708
Coolant Filter.....	WC-5705
Fuel Filter.....	FC-5509
Hydraulic Oil Filter.....	HC-5503
Hydraulic Oil Filter.....	HC-5508
Oil Filter Full Flow.....	C-5516
CHALLENGER 85C (TRACTORS) CAT (S/N: 43Z2487-UP)	
Fuel Filter.....	FC-5509
Oil Filter Full Flow.....	C-5516
CHALLENGER 85C (TRACTORS) CAT (S/N: 43Z720-2486-UP)	
Fuel Filter.....	FC-5509
Oil Filter Full Flow.....	C-5516
CHALLENGER 85C (TRACTORS) CAT 3176 (S/N: 9TK1-1399)	
Air Filter Set.....	A-5522-S
Air Filter Primary.....	A-5555
Air Filter Primary.....	A-5509
Air Filter Secondary.....	A-5522
Air Filter Set.....	A-5555-S

MODEL/APPLICATION	SAKURA NO
CATERPILLAR	
Air Filter Secondary.....	A-5556
Coolant Filter.....	WC-5705
Coolant Filter.....	WC-5708
Fuel Filter.....	FC-5509
Fuel Filter.....	FC-5519
Hydraulic Oil Filter.....	HC-5503
Oil Filter Full Flow.....	C-5516
CHALLENGER 85C (TRACTORS) CAT 3176 (S/N: 9TK1400-UP)	
Air Filter Primary.....	A-5555
Air Filter Secondary.....	A-5522
Air Filter Primary.....	A-5509
Air Filter Set.....	A-5555-S
Air Filter Set.....	A-5522-S
Air Filter Secondary.....	A-5556
Coolant Filter.....	WC-5708
Coolant Filter.....	WC-5705
Fuel Filter.....	FC-5509
Fuel Filter.....	FC-5519
Hydraulic Oil Filter.....	HC-5503
Oil Filter Full Flow.....	C-5516
CHALLENGER 85C (TRACTORS) S/N: 9TK1-UP	
Air Filter Primary.....	A-5555
Air Filter Set.....	A-5555-S
Air Filter Secondary.....	A-5556
Hydraulic Oil Filter.....	HC-5503
Hydraulic Oil Filter.....	HC-5506
Hydraulic Oil Filter.....	HC-5512
CHALLENGER 35 (TRACTORS) CAT 3116 (Excluding S/N: 550, 557, 558, 567)	
Air Filter Set.....	A-5549M-S
Air Filter.....	A-5596
Air Filter Secondary.....	A-5550
Air Filter Primary.....	A-5549
Air Filter Primary.....	A-5549M
Coolant Filter.....	WC-5707
Fuel Filter Secondary.....	FC-55151
Fuel Filter.....	FC-5516
Fuel Filter.....	FC-5508
Fuel Filter Secondary.....	FC-5515
Hydraulic Oil Filter.....	HC-5506
Oil Filter Full Flow.....	C-5510
CHALLENGER 35 (TRACTORS) CAT 3116 (S/N: 8DN1-204)	
Air Filter.....	A-5596
Coolant Filter.....	WC-5707
Fuel Filter Secondary.....	FC-55151
Fuel Filter Secondary.....	FC-5515
Fuel Filter.....	FC-5516
Hydraulic Oil Filter.....	HC-5506
Hydraulic Oil Filter.....	HC-5504
Oil Filter Full Flow.....	C-5510
CHALLENGER 35 (TRACTORS) CAT 3116 (S/N: 8DN205-548)	
Air Filter.....	A-5596
Air Filter Set.....	A-5549M-S
Air Filter Primary.....	A-5549M
Air Filter Primary.....	A-5549

MODEL/APPLICATION	SAKURA NO
CATERPILLAR	
CHALLENGER 35 (TRACTORS) CAT 3116 (S/N: 8DN205-548)	
Air Filter Secondary.....	A-5550
Coolant Filter.....	WC-5707
Fuel Filter.....	FC-5516
Fuel Filter Secondary.....	FC-5515
Fuel Filter Secondary.....	FC-55151
Hydraulic Oil Filter.....	HC-5504
Hydraulic Oil Filter.....	HC-5506
Oil Filter Full Flow.....	C-5510
CHALLENGER 35 (TRACTORS) CAT 3116 (S/N: 8DN549-UP)	
Air Filter Primary.....	A-5549M
Air Filter Primary.....	A-5549
Air Filter.....	A-5596
Air Filter Secondary.....	A-5550
Air Filter Set.....	A-5549M-S
Coolant Filter.....	WC-5707
Fuel Filter Secondary.....	FC-55151
Fuel Filter Secondary.....	FC-5515
Fuel Filter.....	FC-5516
Fuel Filter.....	FC-5508
Hydraulic Oil Filter.....	HC-5506
Oil Filter Full Flow.....	C-5510
CHALLENGER 36 (TRACTORS) S/N: 8DN205-548	
Air Filter Primary.....	A-5549
Air Filter Secondary.....	A-5550
Air Filter Primary.....	A-5549M
Air Filter Set.....	A-5549M-S
Fuel Filter.....	FC-5516
Fuel Filter Secondary.....	FC-5515
Fuel Filter Secondary.....	FC-55151
Hydraulic Oil Filter.....	HC-5504
Hydraulic Oil Filter.....	HC-5506
Oil Filter Full Flow.....	C-5510
CHALLENGER 45 (TRACTORS) CAT 3116 (Excluding S/N: 1117, 1122, 1124,1126)	
Air Filter Set.....	A-5549M-S
Air Filter Primary.....	A-5549
Air Filter Primary.....	A-5549M
Air Filter.....	A-5596
Coolant Filter.....	WC-5707
Fuel Filter.....	FC-5508
Fuel Filter Secondary.....	FC-5515
Fuel Filter Secondary.....	FC-55151
Fuel Filter.....	FC-5516
Hydraulic Oil Filter.....	HC-5506
Oil Filter Full Flow.....	C-5510
CHALLENGER 45 (TRACTORS) CAT 3116 (S/N: 1DR1106-UP)	
Air Filter Set.....	A-5549M-S
Air Filter Primary.....	A-5549M
Air Filter Primary.....	A-5549
Air Filter.....	A-5596
Coolant Filter.....	WC-5707
Fuel Filter Secondary.....	FC-55151
Fuel Filter.....	FC-5516
Fuel Filter.....	FC-5508

MODEL/APPLICATION	SAKURA NO
CATERPILLAR	
Fuel Filter Secondary.....	FC-5515
Hydraulic Oil Filter.....	HC-5506
Oil Filter Full Flow.....	C-5510
CHALLENGER 45 (TRACTORS) CAT 3116 (S/N: 1DR205-1DR1105)	
Air Filter Set.....	A-5549M-S
Air Filter.....	A-5596
Air Filter Primary.....	A-5549M
Air Filter Primary.....	A-5549
Coolant Filter.....	WC-5707
Fuel Filter Secondary.....	FC-5515
Fuel Filter Secondary.....	FC-55151
Fuel Filter.....	FC-5516
Hydraulic Oil Filter.....	HC-5506
Hydraulic Oil Filter.....	HC-5504
Oil Filter Full Flow.....	C-5510
CHALLENGER 55 (TRACTORS) CAT 3126 (S/N: 7DM1-UP)	
Air Filter Primary.....	A-5549
Air Filter Primary.....	A-5549M
Air Filter Secondary.....	A-5550
Air Filter Set.....	A-5549M-S
Fuel Filter.....	FC-5516
Fuel Filter Secondary.....	FC-5515
Fuel Filter Secondary.....	FC-55151
Oil Filter Full Flow.....	C-5510
CHALLENGER 65C (TRACTORS) S/N: 2ZJ1-1679	
Air Filter Set.....	A-5573-S
Air Filter Secondary.....	A-5534
Air Filter Primary.....	A-5535
Fuel Filter Secondary.....	FC-5507
Hydraulic Oil Filter.....	HC-5503
Oil Filter Full Flow.....	C-5510
CHALLENGER 65C (TRACTORS) w/3306 Eng.	
Air Filter Set.....	A-5573M-S
Air Filter Primary.....	A-5535M
CHALLENGER 65D (TRACTORS) S/N: 2ZJ1680-1964	
Fuel Filter Secondary.....	FC-5507
CHALLENGER 65D (TRACTORS) S/N: 2ZJ1965-UP	
Fuel Filter.....	FC-5509
CHALLENGER 65D (TRACTORS) w/3306 Eng.	
Air Filter Primary.....	A-5535M
Air Filter Set.....	A-5573M-S
CHALLENGER 65E (TRACTORS) CAT 3176C	
Air Filter Set.....	A-5573-S
Air Filter Secondary.....	A-5534
Air Filter Primary.....	A-5535
Fuel Filter.....	FC-5502
Fuel Filter.....	FC-5517
Fuel Filter.....	FC-5509
Fuel/Water Separator Secondary..	SFC-5504-10
Fuel/Water Separator Secondary..	SFC-5504-10B

MODEL/APPLICATION	SAKURA NO
CATERPILLAR	
Oil Filter Full Flow.....	C-5516
CHALLENGER 65E (TRACTORS) W/3176 ENG.	
Air Filter Set.....	A-5573M-S
Air Filter Primary.....	A-5535M
CHALLENGER 670 (TRACTORS)	
Fuel Filter.....	FC-5516
Fuel Filter Secondary.....	FC-55151
Fuel Filter Secondary.....	FC-5515
Fuel/Water Separator Secondary..	SFC-5504-10B
Fuel/Water Separator Secondary..	SFC-5504-10
Hydraulic Oil Filter Full Flow.....	HC-79331
Oil Filter Full Flow.....	C-5516
CHALLENGER 75B (TRACTORS) CAT 3176	
Air Filter Primary.....	A-5535
Air Filter Secondary.....	A-5502
Air Filter Primary.....	A-5501
Air Filter Secondary.....	A-5534
Air Filter Set.....	A-5573-S
Coolant Filter.....	WC-5708
Coolant Filter.....	WC-5705
Fuel Filter.....	FC-5509
Fuel/Water Separator Secondary..	SFC-5504-10
Fuel/Water Separator Secondary..	SFC-5504-10B
Hydraulic Oil Filter.....	HC-5511
Hydraulic Oil Filter.....	HC-5503
Hydraulic Oil Filter.....	HC-5508
CHALLENGER 75B (TRACTORS) CAT 3176 (S/N: 4CJ1-UP)	
Air Filter Set.....	A-5522-S
Air Filter Primary.....	A-5509
Air Filter Secondary.....	A-5522
Air Filter Primary.....	A-5501
Air Filter Secondary.....	A-5502
Coolant Filter.....	WC-5708
Coolant Filter.....	WC-5705
Fuel Filter.....	FC-5509
Fuel Filter.....	FC-5519
Hydraulic Oil Filter.....	HC-5503
Hydraulic Oil Filter.....	HC-5508
Oil Filter Full Flow.....	C-5516
CHALLENGER 75C (TRACTORS) CAT 3176 (S/N: 4KK1-4KK1849)	
Air Filter Set.....	A-5522-S
Air Filter Primary.....	A-5509
Air Filter Secondary.....	A-5534
Air Filter Set.....	A-5573-S
Air Filter Primary.....	A-5535
Air Filter Secondary.....	A-5522
Fuel Filter.....	FC-5519
Fuel Filter.....	FC-5509
Hydraulic Oil Filter.....	HC-5508
Hydraulic Oil Filter.....	HC-5503
Oil Filter Full Flow.....	C-5516
CHALLENGER 75C (TRACTORS) CAT 3176 (S/N: 4KK1850-UP)	

MODEL/APPLICATION	SAKURA NO	MODEL/APPLICATION	SAKURA NO	MODEL/APPLICATION	SAKURA NO
CATERPILLAR		CATERPILLAR		CATERPILLAR	
CHALLENGER 75C (TRACTORS) CAT 3176 (S/N: 4KK1850-UP)		CHALLENGER MT655 (TRACTORS) SISU C8.4L		CHALLENGER 75E (TRACTORS) W/3176 ENG.	
Air Filter Set.....	A-5522-S	Air Filter.....	A-5434	Air Filter Primary.....	A-5535M
Air Filter Set.....	A-5573-S	Fuel Filter.....	FC-5101	Air Filter Set.....	A-5573M-S
Air Filter Primary.....	A-5535	Hydraulic Oil Filter.....	H-5001		
Air Filter Primary.....	A-5509	Oil Filter Full Flow.....	C-7955		
Air Filter Secondary.....	A-5522			CP-323C (COMPACTORS) CAT 3054 (S/N: EAS1-UP)	
Air Filter Secondary.....	A-5534			Air Filter Set.....	A-5537-S
Fuel Filter.....	FC-5519	CHALLENGER MT655 (TRACTORS) SISU C8.4L		Air Filter Primary.....	A-5537
Fuel Filter.....	FC-5509	Air Filter.....	A-5434	Air Filter Secondary.....	A-5536
Hydraulic Oil Filter.....	HC-5508	Fuel Filter.....	FC-5101	Hydraulic Oil Filter.....	HC-5504
Hydraulic Oil Filter.....	HC-5503	Hydraulic Oil Filter.....	H-5001	Oil Filter Full Flow.....	C-5102
Oil Filter Full Flow.....	C-5516				
		CHALLENGER MT735 (TRACTORS)		CP-323C (COMPACTORS) W/3054B Eng.	
CHALLENGER 75C (TRACTORS) W/3176 ENG.		Oil Filter Full Flow.....	C-5516	Fuel/Water Separator.....	SFC-43040
Air Filter Set.....	A-5573M-S				
Air Filter Primary.....	A-5535M	CHALLENGER MT745 (TRACTORS)		CP-323 (COMPACTORS) S/N: 6JD1-UP	
		Air Filter Secondary.....	A-5534	Fuel Filter.....	FC-5103
CHALLENGER 85D (TRACTORS) CAT 3196 (S/N: 4GR1-UP)		Air Filter Primary.....	A-5535		
Air Filter Primary.....	A-5555	Air Filter Set.....	A-5573-S	CP-323D (COMPACTORS) CAT (S/N: CRS1-UP)	
Air Filter Set.....	A-5555-S	Hydraulic Oil Filter.....	HC-5504	Oil Filter Full Flow.....	C-5102
Air Filter Secondary.....	A-5556	Oil Filter Full Flow.....	C-5516		
Fuel Filter.....	FC-5509			CP-323D (COMPACTORS) CAT (S/N: G4D1-UP)	
Hydraulic Oil Filter.....	HC-5503	CHALLENGER MT835 (TRACTORS)		Oil Filter Full Flow.....	C-5102
Oil Filter Full Flow.....	C-5516	Oil Filter Full Flow.....	C-5516		
				CP-323D (COMPACTORS) S/N: EAS1-UP	
CHALLENGER 85E (TRACTORS) CAT 3196		CHALLENGER MT845 (TRACTORS)		Air Filter Set.....	A-5537-S
Air Filter Secondary.....	A-5556	Air Filter Secondary.....	A-5563	Air Filter Secondary.....	A-5536
Air Filter Set.....	A-5555-S	Air Filter Set.....	A-5555-S	Air Filter Primary.....	A-5537
Air Filter Primary.....	A-5555	Air Filter Primary.....	A-5564	Hydraulic Oil Filter.....	HC-5504
Fuel/Water Separator Secondary..	SFC-5504-10B	Air Filter Secondary.....	A-5556		
Fuel/Water Separator Secondary..	SFC-5504-10	Air Filter Primary.....	A-5555	CP-433C (COMPACTORS) CAT 7BJ1-UP , 2011	
Hydraulic Oil Filter.....	HC-5506	Air Filter Set.....	A-5565-S	Air Filter Secondary.....	A-56741
Hydraulic Oil Filter.....	HC-5503	Oil Filter Full Flow.....	C-5516	Air Filter Primary.....	A-56731
Oil Filter Full Flow.....	C-5516			Air Filter Set.....	A-56731-S
		CHALLENGER MT855 (TRACTORS)			
CHALLENGER MT265 (TRACTORS)		Air Filter Primary.....	A-5555	CP-433C (COMPACTORS) CAT 3054T	
Fuel Filter.....	F-5210	Air Filter Secondary.....	A-5556	Air Filter Set.....	A-4212-S
Hydraulic Oil Filter.....	HC-7940	Air Filter Set.....	A-5555-S	Air Filter Secondary.....	A-4211
		Oil Filter Full Flow.....	C-5516	Air Filter Primary.....	A-4210
CHALLENGER MT285 (TRACTORS)					
Fuel Filter.....	F-5210	CHALLENGER MT865 (TRACTORS)		CP-433C (COMPACTORS) S/N: 2JM1-UP	
Hydraulic Oil Filter.....	HC-7940	Oil Filter Full Flow.....	C-5516	Air Filter Set.....	A-5541M-S
				Air Filter Primary.....	A-5541
CHALLENGER MT425 (TRACTORS)		CHALLENGER SP110 (TRACTORS)		Air Filter Primary.....	A-76231
Air Filter Primary.....	A-6703	Fuel Filter Secondary.....	FC-7903	Air Filter Primary.....	A-5541M
Air Filter Primary.....	A-8553	Fuel/Water Separator.....	SFC-5706	Oil Filter Full Flow.....	C-5102
Air Filter.....	A-8554	Oil Filter Full Flow.....	C-5703		
				CP-433E (COMPACTORS) CAT 7BJ1-UP , 2011	
CHALLENGER MT535 (TRACTORS)		CHALLENGER SP165 (TRACTORS)		Air Filter Secondary.....	A-56741
Air Filter Primary.....	A-5105	Fuel Filter Secondary.....	FC-7903	Air Filter Primary.....	A-56731
Air Filter Secondary.....	A-5106	Fuel/Water Separator.....	SFC-5706	Air Filter Set.....	A-56731-S
		Oil Filter Full Flow.....	C-5704		
CHALLENGER MT565 (TRACTORS)		CHALLENGER 75D (TRACTORS) W/3176 ENG.		CP-433E (COMPACTORS) CAT 3054C	
Air Filter.....	A-5434	Air Filter Primary.....	A-5535M	Cabin Air Filter.....	CA-55130
Fuel Filter.....	FC-5101	Air Filter Set.....	A-5573M-S		
Oil Filter Full Flow.....	C-7955				

MODEL/APPLICATION	SAKURA NO	MODEL/APPLICATION	SAKURA NO	MODEL/APPLICATION	SAKURA NO
CATERPILLAR		CATERPILLAR		CATERPILLAR	
CP-433E (COMPACTORS) w/3054C Eng. Fuel/Water Separator.....	SFC-43040	Air Filter Set.....	A-56731-S	CP-563 (COMPACTORS) S/N: 5AJ1-UP Fuel Filter Secondary.....	FC-5507
CP-44 (COMPACTORS) CAT C4.4 ACERT , 4400, 2012 Air Filter Primary.....	A-56731	CP-533E (COMPACTORS) S/N: ASM1-UP Air Filter Primary.....	A-5673	CP-563 (COMPACTORS) S/N: 8XF1-650 Air Filter Primary.....	A-5566
Air Filter Set.....	A-56731-S	Air Filter Secondary.....	A-8670	Air Filter.....	A-5530
Air Filter Secondary.....	A-56741	Air Filter Set.....	A-5675-S	Air Filter Set.....	A-5507-S
CP-44 (COMPACTORS) w/C4.4 Eng. Fuel/Water Separator.....	SFC-55250	Hydraulic Oil Filter.....	HC-5504	Air Filter Primary.....	A-5507
CP-533 (COMPACTORS) S/N: 3ZL1-UP Fuel Filter Secondary.....	FC-5507	CP-533E (COMPACTORS) S/N: BZG1-UP Air Filter Set.....	A-5675-S	Air Filter Set.....	A-5568-S
Oil Filter Full Flow.....	C-5510	Air Filter Primary.....	A-5673	Air Filter Set.....	A-55071-S
CP-533D (COMPACTORS) CAT 316T Cabin Air Filter.....	CA-55130	Air Filter Secondary.....	A-8670	Air Filter Secondary.....	A-5567
CP-533D (COMPACTORS) CAT (S/N: 4TF1-UP) Air Filter Secondary.....	A-5567	Hydraulic Oil Filter.....	HC-5504	Fuel Filter.....	FC-5516
Air Filter Primary.....	A-5566	CP-533E (COMPACTORS) w/3054C Eng. Fuel/Water Separator.....	SFC-43040	Fuel Filter Secondary.....	FC-5507
Air Filter Set.....	A-5568-S	CP-54 (COMPACTORS) CAT C4.4 , 4400, 2012 Air Filter Primary.....	A-56731	Fuel Filter Secondary.....	FC-55151
Fuel Filter Secondary.....	FC-5507	Air Filter Set.....	A-56731-S	Fuel Filter.....	FC-5516
Fuel Filter.....	FC-5516	Air Filter Secondary.....	A-56741	Hydraulic Oil Filter.....	HC-5504
Fuel Filter.....	FC-5508	CP-54 (COMPACTORS) CAT C4E1-UP , 2011 Air Filter Primary.....	A-56731	Oil Filter Full Flow.....	C-5510
Fuel Filter Secondary.....	FC-55151	Air Filter Set.....	A-56731-S	Oil Filter Full Flow.....	C-5522
Fuel Filter Secondary.....	FC-5515	Air Filter Secondary.....	A-56741	CP-563E (COMPACTORS) CAT (S/N: CPT1-UP) Fuel Filter.....	FC-5517
Oil Filter Full Flow.....	C-5510	CP-54 (COMPACTORS) CAT C4.4 Cabin Air Filter.....	CA-55130	Oil Filter Full Flow.....	C-5522
Oil Filter Full Flow.....	C-5522	CP-56 (COMPACTORS) CAT C6.6 Cabin Air Filter.....	CA-55130	CP-563E (COMPACTORS) CAT 3056E ATAAC Cabin Air Filter.....	CA-55130
CP-533D (COMPACTORS) S/N: 6AZ1-UP Air Filter Set.....	A-8508M-S	CP-56 (COMPACTORS) w/C6.6 Eng. Fuel/Water Separator.....	SFC-55170	CP-563E (COMPACTORS) S/N: ASV1-UP Air Filter Secondary.....	A-8507
Air Filter Secondary.....	A-8507	CP-563 (COMPACTORS) S/N: 1YJ1-UP Air Filter Set.....	A-55071-S	Air Filter Primary.....	A-8508M
Air Filter Primary.....	A-8508	Air Filter Secondary.....	A-5567	Air Filter Primary.....	A-8508
Air Filter Primary.....	A-8508M	Air Filter Primary.....	A-5507	Air Filter Set.....	A-8508M-S
Air Filter Primary.....	A-8508M	Air Filter Secondary.....	A-5566	Air Filter Set.....	A-8604-S
Air Filter Set.....	A-8604-S	Air Filter Primary.....	A-5507-S	Hydraulic Oil Filter.....	HC-5504
Air Filter Set.....	A-8604-S	Air Filter Secondary.....	A-5568-S	CP-563E (COMPACTORS) S/N: ASZ1-UP Air Filter Set.....	A-8604-S
Hydraulic Oil Filter.....	HC-5504	Air Filter.....	A-5530	Air Filter Secondary.....	A-8507
CP-533D (COMPACTORS) S/N: AFC1-UP Air Filter Set.....	A-8508M-S	Fuel Filter Secondary.....	FC-5507	Air Filter Primary.....	A-8508
Air Filter Primary.....	A-8508	Fuel Filter Secondary.....	FC-5515	Air Filter Primary.....	A-8508M
Air Filter Primary.....	A-8508M	Fuel Filter.....	FC-5516	Air Filter Set.....	A-8508M-S
Air Filter Set.....	A-8604-S	Fuel Filter Secondary.....	FC-55151	Hydraulic Oil Filter.....	HC-5504
Air Filter Secondary.....	A-8507	Fuel Filter.....	FC-5516	CP-563E (COMPACTORS) S/N: BWE1-UP Air Filter Set.....	A-8604-S
Hydraulic Oil Filter.....	HC-5504	Fuel Filter Secondary.....	FC-55151	Air Filter Primary.....	A-8508M
CP-533E (COMPACTORS) CAT (S/N: CRS1-UP) Oil Filter Full Flow.....	C-5102	Hydraulic Oil Filter.....	HC-5504	Air Filter Secondary.....	A-8507
CP-533E (COMPACTORS) CAT (S/N: G4D1-UP) Oil Filter Full Flow.....	C-5102	Oil Filter Full Flow.....	C-5510	Air Filter Primary.....	A-8508
CP-533E (COMPACTORS) CAT 3054C Air Filter Primary.....	A-56731	CP-563E (COMPACTORS) S/N: BWE1-UP Air Filter Set.....	A-8604-S	Air Filter Secondary.....	A-8507
Air Filter Secondary.....	A-56741	Air Filter Primary.....	A-8508M	Air Filter Primary.....	A-8508

MODEL/APPLICATION	SAKURA NO	MODEL/APPLICATION	SAKURA NO	MODEL/APPLICATION	SAKURA NO
CATERPILLAR		CATERPILLAR		CATERPILLAR	
CP-563E (COMPACTORS) S/N: BWEL-UP Air Filter Set..... A-8508M-S Hydraulic Oil Filter..... HC-5504		Hydraulic Oil Filter..... HC-5504		Cabin Air Filter..... CA-55130	
CP-563E (COMPACTORS) S/N: CNT1-UP Air Filter Secondary..... A-8507 Air Filter Set..... A-8604-S Air Filter Primary..... A-8508 Air Filter Primary..... A-8508M Air Filter Set..... A-8508M-S Hydraulic Oil Filter..... HC-5504		CP-563D (COMPACTORS) S/N: 9ZW1-122-UP Air Filter Secondary..... A-8507 Air Filter Primary..... A-8508M Air Filter Set..... A-8508M-S Air Filter Primary..... A-8508 Air Filter Set..... A-8604-S Hydraulic Oil Filter..... HC-5504		CP-76 (COMPACTORS) w/C6.6 Eng. Fuel/Water Separator..... SFC-55170	
CP-573E (COMPACTORS) CAT 3056E Cabin Air Filter..... CA-55130		CP-563D (COMPACTORS) S/N: 9ZW123-581-UP Air Filter Set..... A-8508M-S Air Filter Primary..... A-8508M Air Filter Set..... A-8604-S Air Filter Secondary..... A-8507 Air Filter Primary..... A-8508 Hydraulic Oil Filter..... HC-5504		CP-72 (COMPACTORS) w/C6.6 Eng. Fuel/Water Separator..... SFC-55170	
CP-553 (COMPACTORS) S/N: 7AD90-UP Air Filter Primary..... A-6113 Air Filter Secondary..... A-5408 Fuel Filter..... FC-6503 Oil Filter Full Flow..... C-7005		CP-563D (COMPACTORS) S/N: 9ZN582-UP Air Filter Primary..... A-8508M Air Filter Secondary..... A-8507 Air Filter Set..... A-8508M-S Air Filter Set..... A-8604-S Air Filter Primary..... A-8508 Hydraulic Oil Filter..... HC-5504		CP-74B (COMPACTORS) C7.1 Oil Filter Full Flow..... C-51070	
CP-553 (COMPACTORS) S/N: 7BD1-UP Hydraulic Oil Filter..... HC-69031		CP-64 (COMPACTORS) S/N: 9ZM522-UP Cabin Air Filter..... CA-55130		CP-76B (COMPACTORS) C7.1 Oil Filter Full Flow..... C-51070	
CP-553 (COMPACTORS) S/N: 7BD22-UP Air Filter Secondary..... A-5408 Air Filter Primary..... A-6113 Fuel Filter..... FC-6503 Oil Filter Full Flow..... C-7005		CP-64 (COMPACTORS) CAT C6.6 Cabin Air Filter..... CA-55130		CS-323C (COMPACTORS) CAT 3054 (S/N: DAR1-UP) Air Filter Set..... A-5537-S Air Filter Primary..... A-5537 Air Filter Secondary..... A-5536 Hydraulic Oil Filter..... HC-5504 Oil Filter Full Flow..... C-5102	
CP-553 (COMPACTORS) S/N: 8CD1-UP Hydraulic Oil Filter..... HC-69031		CP-64 (COMPACTORS) w/C6.6 Eng. Fuel/Water Separator..... SFC-55170		CS-323C (COMPACTORS) w/3054B Eng. Fuel/Water Separator..... SFC-43040	
CP-563D (COMPACTORS) CAT 3116T Cabin Air Filter..... CA-55130		CP-663E (COMPACTORS) CAT 3056 (S/N: ASF1-UP) Air Filter Set..... A-8604-S Air Filter Set..... A-8508M-S Air Filter Primary..... A-8508 Air Filter Primary..... A-8508M Hydraulic Oil Filter..... HC-5504		CS-323 (COMPACTORS) S/N: 6JD1-UP Fuel Filter..... FC-5103	
CP-563D (COMPACTORS) CAT S/N: 4TF44156-UP Fuel Filter Secondary..... FC-55151 Fuel Filter Secondary..... FC-5515 Fuel Filter..... FC-5508 Fuel Filter..... FC-5516 Oil Filter Full Flow..... C-5522		CP-663E (COMPACTORS) CAT 3056 (S/N: DAF1-UP) Air Filter Primary..... A-8508 Air Filter Set..... A-8508M-S Air Filter Set..... A-8604-S Air Filter Primary..... A-8508M Hydraulic Oil Filter..... HC-5504		CS-323D (COMPACTORS) CAT (S/N: CRS1-UP) Oil Filter Full Flow..... C-5102	
CP-563D (COMPACTORS) CAT S/N: 98Z29296-38205-UP Fuel Filter Secondary..... FC-5515 Fuel Filter..... FC-5508 Fuel Filter..... FC-5516 Fuel Filter Secondary..... FC-55151 Oil Filter Full Flow..... C-5522		CP-663E (COMPACTORS) CAT 3056E (S/N: DCL1-UP) Air Filter Secondary..... A-5540 Hydraulic Oil Filter..... HC-5504 Oil Filter Full Flow..... C-5102		CS-323D (COMPACTORS) S/N: DAR1-UP Air Filter Primary..... A-5537 Air Filter Secondary..... A-5536 Air Filter Set..... A-5537-S Hydraulic Oil Filter..... HC-5504	
CP-563D (COMPACTORS) S/N: 5LZ1-UP Air Filter Set..... A-8604-S Air Filter Primary..... A-8508M Air Filter Set..... A-8508M-S Air Filter Secondary..... A-8507 Air Filter Primary..... A-8508		CP-74 (COMPACTORS) CAT C6.6 Cabin Air Filter..... CA-55130		CS-423E (COMPACTORS) CAT 3054B (S/N: ASH1-UP) Air Filter Secondary..... A-5540 Hydraulic Oil Filter..... HC-5504 Oil Filter Full Flow..... C-5102	
		CP-74 (COMPACTORS) w/C6.6 Eng. Fuel/Water Separator..... SFC-55170		CS-423E (COMPACTORS) CAT 3054C Cabin Air Filter..... CA-55130	
		CP-76 (COMPACTORS) CAT C6.6		CS-423E (COMPACTORS) w/3054C Eng. Fuel/Water Separator..... SFC-43040	

MODEL/APPLICATION	SAKURA NO	MODEL/APPLICATION	SAKURA NO	MODEL/APPLICATION	SAKURA NO
CATERPILLAR		CATERPILLAR		CATERPILLAR	
CS-431C <i>(COMPACTORS)</i> CAT 7BJ1-UP , 2011 Air Filter Set..... A-56731-S Air Filter Primary..... A-56731 Air Filter Secondary..... A-56741		CS-433C <i>(COMPACTORS)</i> CAT 5HK13000 - UP , 2011 Air Filter Secondary..... A-56741 Air Filter Primary..... A-56731 Air Filter Set..... A-56731-S		CS-433E <i>(COMPACTORS)</i> CAT 3054 (S/N: DAC1-UP) Air Filter Secondary..... A-5540 Hydraulic Oil Filter..... HC-5504 Oil Filter Full Flow..... C-5102	
CS-431C <i>(COMPACTORS)</i> CAT (S/N: 5HK20500-UP) Oil Filter Full Flow..... C-5102		CS-433C <i>(COMPACTORS)</i> CAT 7BJ1-UP , 2011 Air Filter Primary..... A-56731 Air Filter Set..... A-56731-S Air Filter Secondary..... A-56741		CS-433E <i>(COMPACTORS)</i> CAT 3054C Cabin Air Filter..... CA-55130	
CS-431C <i>(COMPACTORS)</i> CAT (S/N: 7BJ1-UP) Air Filter Secondary..... A-8670 Air Filter Set..... A-5675-S Air Filter Primary..... A-5673 Oil Filter Full Flow..... C-5102		CS-433C <i>(COMPACTORS)</i> CAT 9RM1 - UP , 2011 Air Filter Set..... A-56731-S Air Filter Secondary..... A-56741 Air Filter Primary..... A-56731		CS-433E <i>(COMPACTORS)</i> w/3054C Eng. Fuel/Water Separator..... SFC-43040	
CS-431C <i>(COMPACTORS)</i> CAT (S/N: 9RM1-UP) Oil Filter Full Flow..... C-5102		CS-433C <i>(COMPACTORS)</i> CAT 3054NA Air Filter Primary..... A-76600 Oil Filter Full Flow..... C-5102		CS-433 <i>(COMPACTORS)</i> S/N: 2JM1-UP Air Filter Primary..... A-76600 Hydraulic Oil Filter..... HC-5504 Oil Filter Full Flow..... C-5102	
CS-431C <i>(COMPACTORS)</i> CAT 3054T Air Filter Secondary..... A-4211 Air Filter Primary..... A-4210 Air Filter Set..... A-4212-S		CS-433C <i>(COMPACTORS)</i> CAT 3054T Air Filter Primary..... A-76600 Air Filter Primary..... A-4210 Air Filter Set..... A-4212-S Air Filter Secondary..... A-4211 Cabin Air Filter..... CA-55130 Oil Filter Full Flow..... C-5102		CS-433 <i>(COMPACTORS)</i> S/N: 3TM1-UP Air Filter Primary..... A-76600 Hydraulic Oil Filter..... HC-5504 Oil Filter Full Flow..... C-5102	
CS-431C <i>(COMPACTORS)</i> S/N: 3WZ1-UP Air Filter Secondary..... A-5540 Air Filter Primary..... A-5541M Air Filter Primary..... A-76231 Air Filter Primary..... A-5541 Air Filter Set..... A-5541M-S Hydraulic Oil Filter..... HC-5504		CS-433C <i>(COMPACTORS)</i> CAT 5HK1 - 12999 Air Filter Primary..... A-56731 Air Filter Set..... A-56731-S Air Filter Secondary..... A-56741		CS-44 <i>(COMPACTORS)</i> CAT C4.4 ACERT , 4400, 2012 Air Filter Primary..... A-56731 Air Filter Set..... A-56731-S Air Filter Secondary..... A-56741	
CS-431C <i>(COMPACTORS)</i> S/N: 9XL1-UP Air Filter Primary..... A-76600 Hydraulic Oil Filter..... HC-5504		CS-433C <i>(COMPACTORS)</i> CAT 5HK13000 - UP Air Filter Secondary..... A-56741 Air Filter Primary..... A-56731 Air Filter Set..... A-56731-S		CS-44 <i>(COMPACTORS)</i> w/C4.4 Eng. Fuel/Water Separator..... SFC-55250	
CS-431C <i>(COMPACTORS)</i> S/N: 9XL204-UP Air Filter Set..... A-5541M-S Air Filter Primary..... A-5541 Air Filter Primary..... A-5541M Air Filter Secondary..... A-5540 Air Filter Primary..... A-76231 Hydraulic Oil Filter..... HC-5504		CS-433C <i>(COMPACTORS)</i> CAT 9RM1 - UP Air Filter Set..... A-56731-S Air Filter Secondary..... A-56741 Air Filter Primary..... A-56731		CS-563 <i>(COMPACTORS)</i> S/N: 7GG1-UP Fuel Filter Secondary..... FC-5507 Hydraulic Oil Filter..... H-7916 Oil Filter Full Flow..... C-5510	
CS-431C <i>(COMPACTORS)</i> S/N: GEN1-UP Air Filter Primary..... A-5541M Air Filter Set..... A-5541M-S Air Filter Secondary..... A-5540 Air Filter Primary..... A-76600 Air Filter Primary..... A-5541 Air Filter Primary..... A-76231 Hydraulic Oil Filter..... HC-5504		CS-433C <i>(COMPACTORS)</i> CAT 7BJ1-UP Air Filter Set..... A-56731-S Air Filter Secondary..... A-56741 Air Filter Primary..... A-56731		CS-563 <i>(COMPACTORS)</i> S/N: 8XF1-UP Fuel Filter Secondary..... FC-5507 Hydraulic Oil Filter..... H-7916 Oil Filter Full Flow..... C-5510	
CS-433C <i>(COMPACTORS)</i> CAT 5HK1 - 12999 , 2011 Air Filter Secondary..... A-56741 Air Filter Set..... A-56731-S Air Filter Primary..... A-56731		CS-433C <i>(COMPACTORS)</i> PERKINS Cabin Air Filter..... CA-55130		CS-563 <i>(COMPACTORS)</i> S/N: 8XF651-UP Air Filter Primary..... A-5507 Air Filter Set..... A-55071-S Air Filter Set..... A-5507-S Air Filter Set..... A-5568-S Air Filter..... A-5530 Air Filter Secondary..... A-5567 Air Filter Primary..... A-5566 Fuel Filter Secondary..... FC-5507 Hydraulic Oil Filter..... HC-5504 Oil Filter Full Flow..... C-5510	
		CS-433E <i>(COMPACTORS)</i> CAT 7BJ1-UP , 2011 Air Filter Primary..... A-56731 Air Filter Set..... A-56731-S Air Filter Secondary..... A-56741		CS-531C <i>(COMPACTORS)</i> CAT (S/N: 4TF17600-42391-UP) Fuel Filter Secondary..... FC-5515 Fuel Filter Secondary..... FC-55151 Fuel Filter..... FC-5516	

MODEL/APPLICATION	SAKURA NO	MODEL/APPLICATION	SAKURA NO	MODEL/APPLICATION	SAKURA NO
CATERPILLAR		CATERPILLAR		CATERPILLAR	
CS-531C (COMPACTORS) CAT (S/N: 4TF17600-42391-UP) Oil Filter Full Flow..... C-5510		CS-531D (COMPACTORS) S/N: 4M21-UP Air Filter Set..... A-8508M-S Air Filter Set..... A-8604-S Air Filter Primary..... A-8508M Air Filter Primary..... A-8508 Air Filter Secondary..... A-8507 Hydraulic Oil Filter..... HC-5504		Air Filter Set..... A-5568-S Hydraulic Oil Filter..... HC-5504 CS-533C (COMPACTORS) S/N: 2XN1-458-UP Air Filter Set..... A-5568-S Air Filter Secondary..... A-5567 Air Filter Primary..... A-5566 Hydraulic Oil Filter..... HC-5504	
CS-531C (COMPACTORS) CAT (S/N: 4TF42392-UP) Fuel Filter Secondary..... FC-5515 Fuel Filter..... FC-5516 Fuel Filter..... FC-5508 Fuel Filter Secondary..... FC-55151 Oil Filter Full Flow..... C-5510		CS-531D (COMPACTORS) S/N: AGH1-UP Air Filter Primary..... A-8508M Air Filter Set..... A-8604-S Air Filter Set..... A-8508M-S Air Filter Primary..... A-8508 Air Filter Secondary..... A-8507 Hydraulic Oil Filter..... HC-5504		CS-533C (COMPACTORS) S/N: 2XN459-459-UP Air Filter Secondary..... A-5567 Air Filter Set..... A-5568-S Air Filter Primary..... A-5566 Hydraulic Oil Filter..... HC-5504	
CS-531C (COMPACTORS) CAT (S/N: 98Z16285-23026-UP) Fuel Filter..... FC-5516 Fuel Filter Secondary..... FC-5515 Fuel Filter Secondary..... FC-55151		CS-533C (COMPACTORS) S/N: 2XN460-490-UP Air Filter Set..... A-5568-S Air Filter Primary..... A-5566 Air Filter Secondary..... A-5567 Hydraulic Oil Filter..... HC-5504		CS-533C (COMPACTORS) S/N: 2XN491-UP Air Filter Set..... A-5568-S Air Filter Secondary..... A-5567 Air Filter Primary..... A-5566 Hydraulic Oil Filter..... HC-5504	
CS-531C (COMPACTORS) CAT (S/N: 98Z23027-UP) Fuel Filter Secondary..... FC-5515 Fuel Filter..... FC-5508 Fuel Filter..... FC-5516 Fuel Filter Secondary..... FC-55151		CS-533C (COMPACTORS) CAT (S/N: 4TF20600-42391-UP) Fuel Filter..... FC-5516 Fuel Filter Secondary..... FC-55151 Fuel Filter Secondary..... FC-5515 Oil Filter Full Flow..... C-5510		CS-533D (COMPACTORS) CAT 3116 Cabin Air Filter..... CA-55130	
CS-531C (COMPACTORS) CAT (S/N: 98Z8537-16284-UP) Fuel Filter..... FC-5516 Fuel Filter Secondary..... FC-55151 Fuel Filter Secondary..... FC-5515 Oil Filter Full Flow..... C-5510 Oil Filter Full Flow..... C-5522		CS-533C (COMPACTORS) CAT (S/N: 4TF42392-UP) Fuel Filter..... FC-5508 Fuel Filter Secondary..... FC-55151 Fuel Filter..... FC-5516 Fuel Filter Secondary..... FC-5515 Oil Filter Full Flow..... C-5510		CS-533D (COMPACTORS) CAT (S/N: 4TF1-UP) Air Filter Set..... A-5568-S Air Filter Secondary..... A-5567 Air Filter Primary..... A-5566 Fuel Filter..... FC-5516 Fuel Filter Secondary..... FC-5507 Fuel Filter..... FC-5508 Fuel Filter Secondary..... FC-5515 Fuel Filter Secondary..... FC-55151 Oil Filter Full Flow..... C-5510 Oil Filter Full Flow..... C-5522	
CS-531C (COMPACTORS) S/N: 5ZN1-171-UP Air Filter Set..... A-5568-S Air Filter Primary..... A-5566 Air Filter Secondary..... A-5567 Hydraulic Oil Filter..... HC-5504		CS-533C (COMPACTORS) CAT (S/N: 98Z16285-23026-UP) Fuel Filter Secondary..... FC-55151 Fuel Filter..... FC-5516 Fuel Filter Secondary..... FC-5515		CS-533D (COMPACTORS) S/N: 5C21-UP Air Filter Primary..... A-8508M Air Filter Primary..... A-8508 Air Filter Set..... A-8604-S Air Filter Set..... A-8508M-S Air Filter Secondary..... A-8507 Hydraulic Oil Filter..... HC-5504	
CS-531C (COMPACTORS) S/N: 5ZN172-UP Air Filter Primary..... A-5566 Air Filter Set..... A-5568-S Air Filter Secondary..... A-5567 Hydraulic Oil Filter..... HC-5504		CS-533C (COMPACTORS) CAT (S/N: 98Z23027-UP) Fuel Filter Secondary..... FC-5515 Fuel Filter Secondary..... FC-55151 Fuel Filter..... FC-5508 Fuel Filter..... FC-5516		CS-533D (COMPACTORS) S/N: AET1-UP Air Filter Primary..... A-8508M Air Filter Set..... A-8508M-S Air Filter Secondary..... A-8507 Air Filter Primary..... A-8508 Air Filter Set..... A-8604-S Hydraulic Oil Filter..... HC-5504	
CS-531C (COMPACTORS) S/N: 9RN1-UP Air Filter Secondary..... A-5567 Air Filter Primary..... A-5566 Air Filter Set..... A-5568-S Hydraulic Oil Filter..... HC-5504		CS-533C (COMPACTORS) S/N: 2HN1-183-UP Air Filter Primary..... A-5566 Air Filter Set..... A-5568-S Air Filter Secondary..... A-5567 Hydraulic Oil Filter..... HC-5504		CS-533D (COMPACTORS) S/N: 2HN184-UP Air Filter Secondary..... A-5567 Air Filter Primary..... A-5566	
CS-531D (COMPACTORS) CAT 3116 Cabin Air Filter..... CA-55130		CS-533C (COMPACTORS) S/N: 2HN184-UP Air Filter Secondary..... A-5567 Air Filter Primary..... A-5566			
CS-531D (COMPACTORS) CAT (S/N: 4TF52183-UP) Fuel Filter..... FC-5508 Fuel Filter Secondary..... FC-5515 Fuel Filter Secondary..... FC-55151 Fuel Filter..... FC-5516 Oil Filter Full Flow..... C-5522					

MODEL/APPLICATION	SAKURA NO	MODEL/APPLICATION	SAKURA NO	MODEL/APPLICATION	SAKURA NO
CATERPILLAR		CATERPILLAR		CATERPILLAR	
CS-533E (COMPACTORS) CAT 3116 (S/N: ASL1-UP) Air Filter Secondary..... A-8670 Air Filter Set..... A-5675-S Air Filter Primary..... A-5673 Hydraulic Oil Filter..... HC-5504 Oil Filter Full Flow..... C-5102 CS-533E (COMPACTORS) CAT 3116 (S/N: DAK1-UP) Air Filter Set..... A-5675-S Air Filter Primary..... A-5673 Air Filter Secondary..... A-8670 Hydraulic Oil Filter..... HC-5504 Oil Filter Full Flow..... C-5102 CS-533E (COMPACTORS) CAT 3054C Air Filter Set..... A-56731-S Air Filter Secondary..... A-56741 Air Filter Primary..... A-56731 Cabin Air Filter..... CA-55130 CS-533E (COMPACTORS) w/3054C Eng. Fuel/Water Separator..... SFC-43040 CS-54 (COMPACTORS) CAT C4.4 , 4400, 2012 Air Filter Secondary..... A-56741 Air Filter Primary..... A-56731 Air Filter Set..... A-56731-S CS-54 (COMPACTORS) CAT C4.4 Cabin Air Filter..... CA-55130 CS-56 (COMPACTORS) CAT C6.6 Cabin Air Filter..... CA-55130 CS-56 (COMPACTORS) w/C6.6 Eng. Fuel/Water Separator..... SFC-55170 CS-563C (COMPACTORS) S/N: 4KN1-UP Air Filter Secondary..... A-5567 Air Filter Set..... A-5568-S Air Filter Primary..... A-5566 Fuel Filter Secondary..... FC-5515 Fuel Filter Secondary..... FC-55151 Fuel Filter..... FC-5516 Hydraulic Oil Filter..... HC-5504 Oil Filter Full Flow..... C-5510 CS-563D (COMPACTORS) CAT 3116T Cabin Air Filter..... CA-55130 CS-563D (COMPACTORS) CAT (S/N: 98Z1-20404-UP) Oil Filter Full Flow..... C-5522 CS-563D (COMPACTORS) CAT S/N: 4TF44156-UP Fuel Filter..... FC-5508	Fuel Filter Secondary..... FC-5515 Fuel Filter Secondary..... FC-55151 Fuel Filter..... FC-5516 Oil Filter Full Flow..... C-5522 CS-563D (COMPACTORS) CAT S/N: 98Z20405-38205-UP Fuel Filter Secondary..... FC-55151 Fuel Filter..... FC-5516 Fuel Filter..... FC-5508 Fuel Filter Secondary..... FC-5515 Oil Filter Full Flow..... C-5522 CS-563D (COMPACTORS) S/N: 1S21-20404-UP Air Filter Set..... A-8508M-S Air Filter Secondary..... A-8507 Air Filter Primary..... A-8508 Air Filter Set..... A-8604-S Air Filter Primary..... A-8508M Hydraulic Oil Filter..... HC-5504 Oil Filter Full Flow..... C-5510 Oil Filter Full Flow..... C-5522 CS-563D (COMPACTORS) S/N: 1S220405-UP Air Filter Set..... A-8508M-S Air Filter Set..... A-8604-S Air Filter Secondary..... A-8507 Air Filter Primary..... A-8508M Air Filter Primary..... A-8508 Hydraulic Oil Filter..... HC-5504 Oil Filter Full Flow..... C-5510 Oil Filter Full Flow..... C-5510 CS-563D (COMPACTORS) S/N: 2R21-UP Air Filter Set..... A-8604-S Air Filter Primary..... A-8508M Air Filter Set..... A-8508M-S Air Filter Primary..... A-8508 Air Filter Secondary..... A-8507 Hydraulic Oil Filter..... HC-5504 CS-563D (COMPACTORS) S/N: 9MM1-144-UP Air Filter Set..... A-8604-S Air Filter Set..... A-8508M-S Air Filter Secondary..... A-8507 Air Filter Primary..... A-8508M Air Filter Primary..... A-8508 Hydraulic Oil Filter..... HC-5504 CS-563D (COMPACTORS) S/N: 9MM145-979-UP Air Filter Set..... A-8508M-S Air Filter Secondary..... A-8507 Air Filter Primary..... A-8508M Air Filter Primary..... A-8508 Air Filter Set..... A-8604-S Hydraulic Oil Filter..... HC-5504 CS-563D (COMPACTORS) S/N: 9MM980-UP Air Filter Set..... A-8508M-S	Air Filter Secondary..... A-8507 Air Filter Primary..... A-8508M Air Filter Set..... A-8604-S Air Filter Primary..... A-8508 Hydraulic Oil Filter..... HC-5504 CS-563E (COMPACTORS) CAT 3056E (S/N: ASA1-UP) Air Filter Secondary..... A-8507 Air Filter Set..... A-8604-S Air Filter Set..... A-8508M-S Air Filter Primary..... A-8508 Air Filter Primary..... A-8508M Hydraulic Oil Filter..... HC-5504 CS-563E (COMPACTORS) CAT 3056E (S/N: CNG1-UP) Air Filter Set..... A-8508M-S Air Filter Primary..... A-8508M Air Filter Primary..... A-8508 Air Filter Set..... A-8604-S Air Filter Secondary..... A-8507 Hydraulic Oil Filter..... HC-5504 CS-563E (COMPACTORS) CAT 3056E ATAAC Cabin Air Filter..... CA-55130 CS-573C (COMPACTORS) CAT (S/N: 4TF23400-47634-UP) Air Filter Set..... A-5568-S Air Filter Primary..... A-5566 Air Filter Secondary..... A-5567 Fuel Filter..... FC-5508 Fuel Filter Secondary..... FC-55151 Fuel Filter..... FC-5516 Fuel Filter Secondary..... FC-5515 Fuel Filter Secondary..... FC-5507 Oil Filter Full Flow..... C-5510 CS-573C (COMPACTORS) CAT S/N: 4TF1-23399-UP Air Filter Secondary..... A-5567 Air Filter Set..... A-5568-S Air Filter Primary..... A-5566 Fuel Filter..... FC-5508 Fuel Filter Secondary..... FC-55151 Fuel Filter..... FC-5516 Fuel Filter Secondary..... FC-5515 Fuel Filter Secondary..... FC-5507 Oil Filter Full Flow..... C-5510 Oil Filter Full Flow..... C-5522 CS-573C (COMPACTORS) CAT S/N: 4TF47635-UP Air Filter Secondary..... A-5567 Air Filter Primary..... A-5566 Air Filter Set..... A-5568-S Fuel Filter..... FC-5508 Fuel Filter Secondary..... FC-55151 Fuel Filter Secondary..... FC-5515 Fuel Filter Secondary..... FC-5507 Fuel Filter..... FC-5516 Oil Filter Full Flow..... C-5522 Oil Filter Full Flow..... C-5510			

Sakura Filter

ENGINE APPLICATION

MODEL/APPLICATION	SAKURA NO	MODEL/APPLICATION	SAKURA NO	MODEL/APPLICATION	SAKURA NO
CATERPILLAR		CATERPILLAR		CATERPILLAR	
CS-573C (COMPACTORS) CAT S/N: 4TF47635-UP		Fuel Filter Secondary..... FC-55151 Oil Filter Full Flow..... C-5522		CS-551 (COMPACTORS) S/N: 6ZD1-UP	
CS-573C (COMPACTORS) S/N: 6LN1-69-UP	HC-5504	CS-583D (COMPACTORS) S/N: 2CZ1-131-UP	A-8604-S A-8507 A-8508 A-8508M-S A-8508M HC-5504	Air Filter..... AS-5708 Air Filter..... A-5708 Fuel Filter Secondary..... FC-5507 Hydraulic Oil Filter..... HC-69031 Oil Filter Full Flow..... C-5519	
CS-573C (COMPACTORS) S/N: 6LN70-83-UP	HC-5504	Air Filter Set..... A-8604-S Air Filter Secondary..... A-8507 Air Filter Primary..... A-8508 Air Filter Set..... A-8508M-S Air Filter Primary..... A-8508M Hydraulic Oil Filter..... HC-5504		CS-553 (COMPACTORS) S/N: 7AD1-UP	HC-69031
CS-573C (COMPACTORS) S/N: 6LN84-UP	HC-5504	CS-583D (COMPACTORS) S/N: 2CZ132-182-UP	A-8508 A-8508M A-8508M-S A-8507 HC-5504	CS-553 (COMPACTORS) S/N: 7BD1-UP	HC-69031
CS-573E (COMPACTORS) CAT 3056E (S/N: CEB1-UP)	A-8508 A-8508M-S A-8507 A-8508M A-8604-S HC-5504	Air Filter Primary..... A-8508 Air Filter Set..... A-8508M Air Filter Secondary..... A-8507 Air Filter Primary..... A-8508M Air Filter Set..... A-8604-S Hydraulic Oil Filter..... HC-5504		CS-553 (COMPACTORS) S/N: 8BD1-UP	HC-69031
CS-573E (COMPACTORS) CAT 3056E (S/N: CNN1-UP)	A-8508 A-8507 A-8604-S A-8508M-S A-8508M HC-5504	CS-583D (COMPACTORS) S/N: 2CZ183-UP	A-8508M-S A-8507 A-8508 A-8508M A-8604-S A-8508M HC-5504	CS-553 (COMPACTORS) S/N: 8BD1-UP	HC-69031
CS-573E (COMPACTORS) CAT 3056E ATAAC	CA-55130	CS-583D (COMPACTORS) S/N: 3GZ1-UP	A-8507 A-8508M A-8508 A-8604-S A-8508M-S HC-5504	CS-573 (COMPACTORS) CAT (S/N: 4TF42392-UP)	FC-5516 FC-55151 FC-5515 C-5510
CS-583C (COMPACTORS)	A-5567 A-5568-S A-5566 FC-5508 FC-55151 FC-5515 FC-5516 HC-5504 C-5510	Air Filter Secondary..... A-8507 Air Filter Primary..... A-8508M Air Filter Primary..... A-8508 Air Filter Set..... A-8604-S Air Filter Set..... A-8508M-S Hydraulic Oil Filter..... HC-5504		CS-573 (COMPACTORS) CAT (S/N: 4TF42399-42391-UP)	FC-5516 FC-55151 FC-5515 C-5510
CS-583D (COMPACTORS) CAT S/N: 4TF44156-UP	CA-55130	CS-531 (COMPACTORS) S/N: 3WM1-UP	FC-5507 C-5510	CS-573 (COMPACTORS) CAT (S/N: 4TF5805-13298-UP)	FC-55151 FC-5516 FC-5508 FC-5515 C-5510
CS-583D (COMPACTORS) S/N: 4TF44156-UP	FC-5515 FC-5508 FC-55151 FC-5516 C-5522	Fuel Filter Secondary..... FC-5507 Oil Filter Full Flow..... C-5510		CS-573 (COMPACTORS) S/N: 8PK1-UP	A-5530 A-5507 A-55071-S A-5507-S HC-5504
CS-583D (COMPACTORS) S/N: 98Z29296-38205-UP	FC-5515 FC-5516 FC-5508	CS-531 (COMPACTORS) S/N: 4KM1-UP	FC-5507 C-5510	CS-573D (COMPACTORS) CAT 3116	CA-55130
		Fuel Filter Secondary..... FC-5507 Oil Filter Full Flow..... C-5510		CS-573D (COMPACTORS) CAT S/N: 4TF44156-UP	FC-5508 FC-5516 FC-55151 FC-5515 C-5522
		CS-533 (COMPACTORS) S/N: 3BL1-UP	FC-5507 C-5510	CS-573D (COMPACTORS) CAT S/N: 98Z33158-38205-UP	FC-5515 FC-55151 FC-5508 FC-5516
		Fuel Filter Secondary..... FC-5507 Oil Filter Full Flow..... C-5510			
		CS-533 (COMPACTORS) S/N: 4HL1-UP	FC-5507 C-5510		
		Fuel Filter Secondary..... FC-5507 Oil Filter Full Flow..... C-5510			
		CS-551 (COMPACTORS) S/N: 62D114-UP	A-5708 AS-5708 FC-5523 FC-5501 C-5519		
		Air Filter..... A-5708 Air Filter..... AS-5708 Fuel Filter..... FC-5523 Fuel Filter..... FC-5501 Oil Filter Full Flow..... C-5519			

Sakura Filter

ENGINE APPLICATION

MODEL/APPLICATION	SAKURA NO	MODEL/APPLICATION	SAKURA NO	MODEL/APPLICATION	SAKURA NO
CATERPILLAR		CATERPILLAR		CATERPILLAR	
CS-573D (COMPACTORS) CAT S/N: 98Z33158-38205-UP Oil Filter Full Flow.....	C-5522	Air Filter Secondary..... Air Filter Set..... Air Filter Primary.....	A-56741 A-56731-S A-56731	Air Filter Primary..... Air Filter Set..... Air Filter Set..... Air Filter Primary..... Hydraulic Oil Filter.....	A-8508 A-8604-S A-8508M-S A-8508M HC-5504
CS-573D (COMPACTORS) S/N: 2YZ1-UP Air Filter Primary..... Air Filter Primary..... Air Filter Set..... Air Filter Secondary..... Air Filter Set..... Hydraulic Oil Filter.....	A-8508M A-8508 A-8508M-S A-8507 A-8604-S HC-5504	CS-533E DAK1 (COMPACTORS) CAT 3116 Air Filter Secondary..... Air Filter Primary..... Air Filter Set.....	A-56741 A-56731 A-56731-S	CS-663E (COMPACTORS) CAT 3056 (S/N: DAG1-UP) Air Filter Set..... Air Filter Primary..... Air Filter Primary..... Air Filter Set..... Hydraulic Oil Filter.....	A-8604-S A-8508M A-8508 A-8508M-S HC-5504
CS-573D (COMPACTORS) S/N: CMK1-197-UP Air Filter Secondary..... Air Filter Set..... Air Filter Set..... Air Filter Primary..... Air Filter Primary..... Hydraulic Oil Filter.....	A-8507 A-8508M-S A-8604-S A-8508 A-8508M HC-5504	CS-56B (COMPACTORS) C7.1 Oil Filter Full Flow.....	A-56741 A-56731 A-56731-S C-51070	CS-663E (COMPACTORS) CAT 3056E ATAAC Cabin Air Filter.....	CA-55130
CS-573D (COMPACTORS) S/N: CMK198-UP Air Filter Secondary..... Air Filter Set..... Air Filter Primary..... Air Filter Primary..... Hydraulic Oil Filter.....	A-8507 A-8604-S A-8508 A-8508M HC-5504	CS-643 (COMPACTORS) CAT S/N: 12Z1-UP Air Filter Set..... Air Filter Secondary..... Air Filter Primary..... Fuel Filter Secondary..... Hydraulic Oil Filter..... Hydraulic Oil Filter..... Oil Filter Full Flow.....	A-5522-S A-5522 A-5509 FC-5507 H-5506 H-5504 C-5522	CS-683E (COMPACTORS) CAT 3056 (S/N: ASG1-UP) Air Filter Primary..... Air Filter Set..... Air Filter Set..... Air Filter Primary..... Hydraulic Oil Filter.....	A-8508 A-8604-S A-8508M-S A-8508M HC-5504
CS-573D (COMPACTORS) S/N: CMK198-UP Air Filter Secondary..... Air Filter Set..... Air Filter Primary..... Air Filter Set..... Air Filter Primary..... Hydraulic Oil Filter.....	A-8507 A-8604-S A-8508 A-8508M-S A-8508M HC-5504	CS-643 (COMPACTORS) CAT S/N: 7FD1-UP Air Filter Secondary..... Air Filter Set..... Air Filter Primary..... Fuel Filter Secondary..... Hydraulic Oil Filter..... Hydraulic Oil Filter..... Oil Filter Full Flow.....	A-5522 A-5522-S A-5509 FC-5507 H-5504 H-5506 C-5522	CS-683E (COMPACTORS) CAT 3056 (S/N: DAD1-UP) Air Filter Set..... Air Filter Primary..... Air Filter Set..... Air Filter Primary..... Hydraulic Oil Filter.....	A-8604-S A-8508 A-8508M-S A-8508M HC-5504
CS-583 (COMPACTORS) S/N: 1EL1-UP Fuel Filter Secondary..... Oil Filter Full Flow.....	FC-5507 C-5510	CS-643 (COMPACTORS) CAT S/N: 7GD1-UP Air Filter Set..... Air Filter Primary..... Air Filter Secondary..... Fuel Filter Secondary..... Hydraulic Oil Filter..... Hydraulic Oil Filter..... Oil Filter Full Flow.....	A-5522-S A-5509 A-5522 FC-5507 H-5504 H-5506 C-5522	CS-683E (COMPACTORS) CAT 3056E ATAAC Cabin Air Filter.....	CA-55130
CS-583 (COMPACTORS) S/N: 8YJ1-UP Fuel Filter Secondary..... Hydraulic Oil Filter..... Oil Filter Full Flow.....	FC-5507 HC-5504 C-5510	CS-643 (COMPACTORS) CAT S/N: 7HD1-UP Air Filter Secondary..... Air Filter Set..... Air Filter Primary..... Fuel Filter Secondary..... Hydraulic Oil Filter..... Hydraulic Oil Filter..... Oil Filter Full Flow.....	A-5522 A-5509 A-5522 FC-5507 H-5504 H-5506 C-5522	CS-64 (COMPACTORS) CAT C6.6 Cabin Air Filter.....	CA-55130
CS-583E (COMPACTORS) CAT 3056E (S/N: CNX1-UP) , 2004-UP Air Filter Primary..... Air Filter Set..... Air Filter Secondary..... Air Filter Set..... Air Filter Primary..... Hydraulic Oil Filter.....	A-8508M A-8604-S A-8507 A-8508M-S A-8508 HC-5504	CS-643 (COMPACTORS) CAT S/N: 7JD1-UP Air Filter Secondary..... Air Filter Set..... Air Filter Primary..... Fuel Filter Secondary..... Hydraulic Oil Filter..... Hydraulic Oil Filter..... Oil Filter Full Flow.....	A-5522 A-5522-S A-5509 FC-5507 H-5506 H-5504 C-5522	CS-64 (COMPACTORS) w/C6.6 Eng. Fuel/Water Separator.....	SFC-55170
CS-583E (COMPACTORS) CAT 3056E (S/N: DAJ1-UP) Air Filter Set..... Air Filter Primary..... Air Filter Primary..... Air Filter Set..... Air Filter Secondary..... Hydraulic Oil Filter.....	A-8508M-S A-8508 A-8508M A-8604-S A-8507 HC-5504	CS-643 (COMPACTORS) CAT S/N: 7J1-UP Air Filter Secondary..... Air Filter Primary..... Air Filter Set..... Fuel Filter Secondary..... Hydraulic Oil Filter..... Hydraulic Oil Filter..... Oil Filter Full Flow.....	A-5522 A-5509 A-5522-S FC-5507 H-5506 H-5504 C-5522	CS-68B (COMPACTORS) C7.1 Oil Filter Full Flow.....	C-51070
CS-583E (COMPACTORS) CAT 3056E ATAAC Cabin Air Filter.....	CA-55130	CS-643 (COMPACTORS) CAT S/N: 7JD1-UP Air Filter Secondary..... Air Filter Primary..... Air Filter Set..... Fuel Filter Secondary..... Hydraulic Oil Filter..... Hydraulic Oil Filter..... Oil Filter Full Flow.....	A-5522 A-5509 A-5522-S FC-5507 H-5506 H-5504 C-5522	CS-68B (COMPACTORS) w/C6.6 Eng. Oil Filter Full Flow.....	C-51070
CS-533E ASL1 (COMPACTORS) CAT 3116		CS-643 (COMPACTORS) CAT S/N: 7JD1-UP Air Filter Secondary..... Air Filter Primary..... Air Filter Set..... Fuel Filter Secondary..... Hydraulic Oil Filter..... Hydraulic Oil Filter..... Oil Filter Full Flow.....	A-5522 A-5509 A-5522-S FC-5507 H-5506 H-5504 C-5522	CS-74 (COMPACTORS) CAT C6.6 Cabin Air Filter.....	CA-55130
		CS-663E (COMPACTORS) CAT 3056 (S/N: ASB1-UP)		CS-74 (COMPACTORS) w/C6.6 Eng. Fuel/Water Separator.....	SFC-55170
				CS-76 (COMPACTORS) CAT C6.6 Cabin Air Filter.....	CA-55130
				CS-76 (COMPACTORS) w/C6.6 Eng.	

Sakura Filter

ENGINE APPLICATION

MODEL/APPLICATION	SAKURA NO	MODEL/APPLICATION	SAKURA NO	MODEL/APPLICATION	SAKURA NO
CATERPILLAR		CATERPILLAR		CATERPILLAR	
CS-76 (COMPACTORS) w/C6.6 Eng. Fuel/Water Separator.....	SFC-55170	D10 (DOZERS) S/N: 84W1-609 Air Filter Primary.....	A-5501	D10T (DOZERS) CAT C27 Fuel/Water Separator.....	SFC-55250
CS72 (COMPACTORS) w/C6.6 Eng. Fuel/Water Separator.....	SFC-55170	Air Filter Secondary.....	A-5534	D10N (DOZERS) S/N: 2YD1-UP Fuel Filter.....	FC-5509
CS-74B (COMPACTORS) C7.1 Oil Filter Full Flow.....	C-51070	Air Filter Secondary.....	A-5502	Hydraulic Oil Filter.....	H-5509
CS-74B (COMPACTORS) w/C6.6 Eng. Oil Filter Full Flow.....	C-51070	Air Filter Set.....	A-5573-S	Hydraulic Oil Filter.....	H-5504
CS-78B (COMPACTORS) w/C6.6 Eng. Oil Filter Full Flow.....	C-51070	Air Filter Primary.....	A-5535	Hydraulic Oil Filter.....	H-55270
CS-79B (COMPACTORS) w/C6.6 Eng. Oil Filter Full Flow.....	C-51070	Fuel Filter.....	FC-5501	Hydraulic Oil Filter.....	H-5510
CW34 (COMPACTORS) W/C4.4 ENG. (S/N 3G4) , 4400 Cabin Air Filter.....	CA-55150	Fuel Filter.....	FC-5509	Oil Filter Full Flow.....	C-5516
CW34 (COMPACTORS) W/C4.4 ENG. (S/N AL3) , 4400 Cabin Air Filter.....	CA-55150	Fuel Filter.....	FC-5523	D10N (DOZERS) S/N: 3SK1-UP Air Filter Primary.....	A-5593
CW34 (COMPACTORS) W/C4.4 ENG. (S/N B7L) , 4400 Cabin Air Filter.....	CA-55150	Fuel Filter.....	FC-5509	Air Filter Set.....	A-5595-S
CW34 (COMPACTORS) W/C4.4 ENG. (S/N C34, J3H) , 4400 Cabin Air Filter.....	CA-55150	Hydraulic Oil Filter.....	H-5503	Fuel Filter.....	FC-5509
CW34 (COMPACTORS) W/C4.4 ENG. (S/N CT3, TLJ) , 4400 Cabin Air Filter.....	CA-55150	Oil Filter Full Flow.....	C-5516	Hydraulic Oil Filter.....	H-5510
D10 (DOZERS) S/N: 76X359-UP Air Filter Primary.....	A-5501	D10 (DOZERS) S/N: 84W610-640 Air Filter Primary.....	A-5535	Hydraulic Oil Filter.....	H-55270
Air Filter Secondary.....	A-5502	Air Filter Secondary.....	A-5552	Hydraulic Oil Filter.....	HC-5504
Fuel Filter.....	FC-5523	Air Filter Set.....	A-5573-S	Hydraulic Oil Filter.....	H-5510
Fuel Filter.....	FC-5509	Air Filter Primary.....	A-5534	Hydraulic Oil Filter.....	H-5504
Fuel Filter.....	FC-5501	Air Filter Secondary.....	A-5534	Hydraulic Oil Filter.....	H-55270
Hydraulic Oil Filter.....	H-5503	Air Filter Set.....	A-5521-S	Oil Filter Full Flow.....	C-5516
Oil Filter Full Flow.....	C-5516	Air Filter Primary.....	A-5521	D10R (DOZERS) CAT (S/N: 5J11-UP) Fuel Filter.....	FC-5509
D10 (DOZERS) S/N: 76X359-UP Air Filter Set.....	A-5573-S	Fuel Filter.....	FC-5519	Oil Filter Full Flow.....	C-5516
Air Filter Primary.....	A-5535	Fuel Filter.....	FC-5501	D10R (DOZERS) CAT (S/N: 80M1-UP) Fuel Filter.....	FC-5509
Air Filter Secondary.....	A-5521	Fuel Filter.....	FC-5523	Fuel Filter.....	FC-5517
Air Filter Secondary.....	A-5534	Hydraulic Oil Filter.....	H-5503	Oil Filter Full Flow.....	C-5516
Air Filter Set.....	A-5521-S	Oil Filter Full Flow.....	C-5516	D10R (DOZERS) CAT (S/N: 9EA1-UP) Hydraulic Oil Filter.....	H-5501
Air Filter Secondary.....	A-5552	D10 (DOZERS) S/N: 84W641-645 Air Filter Secondary.....	A-5502	D10R (DOZERS) CAT 3412 (S/N: 3KR1-UP) Air Filter Secondary.....	A-5594
Fuel Filter.....	FC-5519	Air Filter Primary.....	A-5501	Air Filter Primary.....	A-5593
Fuel Filter.....	FC-5501	Air Filter Secondary.....	A-5501	Air Filter Set.....	A-5595-S
Fuel Filter.....	FC-5523	Fuel Filter.....	FC-5501	Fuel Filter.....	FC-5509
Fuel Filter.....	FC-5509	Fuel Filter.....	FC-5523	Fuel/Water Separator Secondary..	SFC-5504-10
Hydraulic Oil Filter.....	H-5503	Hydraulic Oil Filter.....	H-5503	Fuel/Water Separator Secondary..	SFC-5504-10B
Oil Filter Full Flow.....	C-5516	Oil Filter Full Flow.....	C-5516	Hydraulic Oil Filter.....	H-5510
D10 (DOZERS) S/N: 76X359-UP Air Filter Set.....	A-5573-S	D10 (DOZERS) S/N: 84W641-645 Air Filter Primary.....	A-5501	Hydraulic Oil Filter.....	H-5526
Air Filter Primary.....	A-5535	Air Filter Secondary.....	A-5501	Oil Filter Full Flow.....	C-5516
Air Filter Secondary.....	A-5521	Air Filter Set.....	A-5573-S	D10R (DOZERS) CAT 3412 (S/N: AKT1-UP) Air Filter Set.....	A-5555-S
Air Filter Secondary.....	A-5534	Air Filter Primary.....	A-5535	Air Filter Primary.....	A-8506
Air Filter Set.....	A-5521-S	Air Filter Secondary.....	A-5521-S	Air Filter Primary.....	A-5555
Air Filter Secondary.....	A-5552	Air Filter Set.....	A-5552	D10R (DOZERS) S/N: 84W610-640 Air Filter Primary.....	A-5593
Fuel Filter.....	FC-5519	Air Filter Secondary.....	A-5552	Air Filter Secondary.....	A-5595-S
Fuel Filter.....	FC-5501	Fuel Filter.....	FC-5519	Fuel Filter.....	FC-5509
Fuel Filter.....	FC-5523	Fuel Filter.....	FC-5501	Hydraulic Oil Filter.....	H-5510
Fuel Filter.....	FC-5509	Fuel Filter.....	FC-5523	Hydraulic Oil Filter.....	H-5526
Hydraulic Oil Filter.....	H-5503	Hydraulic Oil Filter.....	H-5503	Oil Filter Full Flow.....	C-5516
Oil Filter Full Flow.....	C-5516	Oil Filter Full Flow.....	C-5516	D10R (DOZERS) S/N: 84W641-645 Air Filter Primary.....	A-5593
D10 (DOZERS) S/N: 76X359-UP Air Filter Set.....	A-5573-S	D10 (DOZERS) S/N: 84W641-645 Air Filter Secondary.....	A-5502	Air Filter Secondary.....	A-5595-S
Air Filter Primary.....	A-5535	Air Filter Primary.....	A-5501	Fuel Filter.....	FC-5509
Air Filter Secondary.....	A-5521	Air Filter Secondary.....	A-5501	Hydraulic Oil Filter.....	H-5510
Air Filter Secondary.....	A-5534	Fuel Filter.....	FC-5501	Hydraulic Oil Filter.....	H-5526
Air Filter Set.....	A-5521-S	Fuel Filter.....	FC-5523	Oil Filter Full Flow.....	C-5516
Air Filter Secondary.....	A-5552	Hydraulic Oil Filter.....	H-5503	D10R (DOZERS) S/N: 84W641-645 Air Filter Primary.....	A-5593
Fuel Filter.....	FC-5519	Oil Filter Full Flow.....	C-5516	Air Filter Secondary.....	A-5595-S
Fuel Filter.....	FC-5501	D10 (DOZERS) S/N: 84W641-645 Air Filter Primary.....	A-5501	Fuel Filter.....	FC-5509
Fuel Filter.....	FC-5523	Air Filter Secondary.....	A-5501	Hydraulic Oil Filter.....	H-5510
Fuel Filter.....	FC-5509	Air Filter Secondary.....	A-5501	Hydraulic Oil Filter.....	H-5526
Hydraulic Oil Filter.....	H-5503	Fuel Filter.....	FC-5519	Oil Filter Full Flow.....	C-5516
Oil Filter Full Flow.....	C-5516	Hydraulic Oil Filter.....	H-5503	D10R (DOZERS) S/N: 84W641-645 Air Filter Primary.....	A-5593
D10 (DOZERS) S/N: 76X359-UP Air Filter Set.....	A-5573-S	D10 (DOZERS) S/N: 84W641-645 Air Filter Secondary.....	A-5502	Air Filter Secondary.....	A-5595-S
Air Filter Primary.....	A-5535	Air Filter Primary.....	A-5501	Fuel Filter.....	FC-5509
Air Filter Secondary.....	A-5521	Air Filter Secondary.....	A-5501	Hydraulic Oil Filter.....	H-5510
Air Filter Secondary.....	A-5534	Fuel Filter.....	FC-5501	Hydraulic Oil Filter.....	H-5526
Air Filter Set.....	A-5521-S	Fuel Filter.....	FC-5523	Oil Filter Full Flow.....	C-5516
Air Filter Secondary.....	A-5552	Hydraulic Oil Filter.....	H-5503	D10R (DOZERS) S/N: 84W641-645 Air Filter Primary.....	A-5593
Fuel Filter.....	FC-5519	Oil Filter Full Flow.....	C-5516	Air Filter Secondary.....	A-5595-S
Fuel Filter.....	FC-5501	D10 (DOZERS) S/N: 84W641-645 Air Filter Primary.....	A-5501	Fuel Filter.....	FC-5509
Fuel Filter.....	FC-5523	Air Filter Secondary.....	A-5501	Hydraulic Oil Filter.....	H-5510
Fuel Filter.....	FC-5509	Air Filter Secondary.....	A-5501	Hydraulic Oil Filter.....	H-5526
Hydraulic Oil Filter.....	H-5503	Fuel Filter.....	FC-5519	Oil Filter Full Flow.....	C-5516
Oil Filter Full Flow.....	C-5516	Hydraulic Oil Filter.....	H-5503	D10R (DOZERS) S/N: 84W641-645 Air Filter Primary.....	A-5593

MODEL/APPLICATION	SAKURA NO
CATERPILLAR	
D10R (DOZERS) CAT 3412 (S/N: AKT1-UP)	
Air Filter Secondary.....	A-5556
Air Filter Set.....	A-8506-S
Fuel Filter.....	FC-5509
Fuel/Water Separator Secondary..	SFC-5504-10B
Fuel/Water Separator Secondary...	SFC-5504-10
Hydraulic Oil Filter.....	H-5001
Hydraulic Oil Filter.....	H-55280
Hydraulic Oil Filter.....	H-5510
Hydraulic Oil Filter.....	H-5526
Oil Filter Full Flow.....	C-5516
D10R (DOZERS) CAT 3412E (S/N: 3KR1-UP)	
Air Filter Primary.....	A-5593
Air Filter Secondary.....	A-5594
Air Filter Set.....	A-5595-S
Fuel Filter.....	FC-5509
Fuel/Water Separator Secondary..	SFC-5504-10B
Fuel/Water Separator Secondary...	SFC-5504-10
Hydraulic Oil Filter.....	H-5510
Hydraulic Oil Filter.....	H-5526
Oil Filter Full Flow.....	C-5516
D10R (DOZERS) CAT 3412E (S/N: AKT1-UP)	
Air Filter Primary.....	A-8506
Air Filter Secondary.....	A-5556
Air Filter Set.....	A-8506-S
Air Filter Set.....	A-5555-S
Air Filter Primary.....	A-5555
Fuel Filter.....	FC-5509
Fuel/Water Separator Secondary..	SFC-5504-10
Fuel/Water Separator Secondary...	SFC-5504-10B
Hydraulic Oil Filter.....	H-5526
Hydraulic Oil Filter.....	H-5510
Hydraulic Oil Filter.....	H-55280
Hydraulic Oil Filter.....	H-5001
Oil Filter Full Flow.....	C-5516
D10R (DOZERS) S/N: 3KR1463-UP	
Air Filter Set.....	A-8506-S
Air Filter Primary.....	A-5593
Air Filter Secondary.....	A-5594
Air Filter Set.....	A-5595-S
Air Filter Primary.....	A-8506
Fuel/Water Separator Secondary..	SFC-5504-10B
Fuel/Water Separator Secondary...	SFC-5504-10
Hydraulic Oil Filter.....	H-5510
Hydraulic Oil Filter.....	H-55270
Hydraulic Oil Filter.....	H-55280
Hydraulic Oil Filter.....	HC-5504
Hydraulic Oil Filter.....	H-5526
D10R (DOZERS) S/N: 3KR1-619	
Air Filter Primary.....	A-8506
Air Filter Primary.....	A-5593
Air Filter Set.....	A-5595-S
Air Filter Set.....	A-8506-S
Air Filter Secondary.....	A-5594

MODEL/APPLICATION	SAKURA NO
CATERPILLAR	
Fuel/Water Separator Secondary...	SFC-5504-10
Fuel/Water Separator Secondary..	SFC-5504-10B
Hydraulic Oil Filter.....	H-55270
Hydraulic Oil Filter.....	HC-5504
Hydraulic Oil Filter.....	H-5510
D10R (DOZERS) S/N: 3KR620-1462	
Air Filter Primary.....	A-8506
Air Filter Secondary.....	A-5594
Air Filter Set.....	A-5595-S
Air Filter Primary.....	A-5593
Air Filter Set.....	A-8506-S
Fuel/Water Separator Secondary..	SFC-5504-10B
Fuel/Water Separator Secondary...	SFC-5504-10
Hydraulic Oil Filter.....	HC-5504
Hydraulic Oil Filter.....	H-55280
Hydraulic Oil Filter.....	H-5526
Hydraulic Oil Filter.....	H-55270
Hydraulic Oil Filter.....	H-5510
D11N (DOZERS) CAT (S/N: 2GR1-2632-UP)	
Air Filter Set.....	A-5595-S
Air Filter Primary.....	A-5593
Air Filter Secondary.....	A-5715
Air Filter Secondary.....	A-44230
Air Filter Primary.....	A-44220
Air Filter Secondary.....	A-5594
Air Filter Set.....	A-44240-S
Fuel Filter.....	FC-5510
D11N (DOZERS) CAT (S/N: 2GR2633-UP)	
Air Filter Primary.....	A-5593
Air Filter Set.....	A-5595-S
Air Filter Secondary.....	A-5715
Air Filter Secondary.....	A-44230
Air Filter Primary.....	A-44220
Air Filter Secondary.....	A-5594
Air Filter Set.....	A-44240-S
Fuel Filter.....	FC-5510
D11N (DOZERS) S/N: 4HK1-UP	
Air Filter Primary.....	A-5555
Air Filter Primary.....	A-44220
Air Filter Secondary.....	A-5556
Air Filter Secondary.....	A-44230
Air Filter Set.....	A-44240-S
Air Filter Set.....	A-5555-S
Fuel Filter.....	FC-5510
Hydraulic Oil Filter.....	H-55280
Hydraulic Oil Filter.....	H-5503
Hydraulic Oil Filter.....	H-5526
Hydraulic Oil Filter.....	H-5509
D11N (DOZERS) S/N: 4HK1-UP	
Air Filter Set.....	A-5555-S
Air Filter Secondary.....	A-5556
Air Filter Primary.....	A-5555
Fuel Filter.....	FC-5510
Hydraulic Oil Filter.....	H-5503

MODEL/APPLICATION	SAKURA NO
CATERPILLAR	
Oil Filter Full Flow.....	C-5516
D11N (DOZERS) S/N: 74Z1-UP	
Air Filter Set.....	A-5555-S
Air Filter Secondary.....	A-5529
Air Filter Primary.....	A-5555
Air Filter Set.....	A-5521-S
Air Filter Primary.....	A-5521
Fuel Filter.....	FC-5510
Hydraulic Oil Filter.....	H-5509
Hydraulic Oil Filter.....	H-55280
Hydraulic Oil Filter.....	H-5503
Hydraulic Oil Filter.....	H-5526
D11R (DOZERS) CAT 3508 (S/N: 7PZ1-UP)	
Air Filter Set.....	A-44240-S
Air Filter Primary.....	A-44220
Air Filter Secondary.....	A-44230
Fuel Filter.....	FC-5510
Hydraulic Oil Filter.....	H-5001
Hydraulic Oil Filter.....	H-5526
D11R (DOZERS) CAT 3508 (S/N: 8ZR1-UP)	
Air Filter Secondary.....	A-44230
Air Filter Primary.....	A-44220
Air Filter Set.....	A-44240-S
Fuel Filter.....	FC-5510
Hydraulic Oil Filter.....	H-5509
Hydraulic Oil Filter.....	H-5526
D11R (DOZERS) CAT 3508 (S/N: 9TR1-UP)	
Air Filter Primary.....	A-44220
Air Filter Set.....	A-44240-S
Air Filter Secondary.....	A-44230
Fuel Filter.....	FC-5510
Hydraulic Oil Filter.....	H-5509
Hydraulic Oil Filter.....	H-5526
D11R (DOZERS) CAT 3508 (S/N: 9XR1-UP)	
Air Filter Secondary.....	A-44230
Air Filter Primary.....	A-44220
Air Filter Set.....	A-44240-S
Fuel Filter.....	FC-5510
Hydraulic Oil Filter.....	H-5001
Hydraulic Oil Filter.....	H-5526
D11R (DOZERS) CAT 3508 (S/N: AAF1-UP)	
Air Filter Primary.....	A-44220
Air Filter Set.....	A-44240-S
Air Filter Secondary.....	A-44230
Fuel Filter.....	FC-5510
Hydraulic Oil Filter.....	H-5001
Hydraulic Oil Filter.....	H-5526
D11R (DOZERS) S/N: 7PZ289-681-UP	
Air Filter Primary.....	A-5593
Air Filter Set.....	A-8506-S
Air Filter Set.....	A-5595-S

MODEL/APPLICATION	SAKURA NO
-------------------	-----------

CATERPILLAR

**D11R
(DOZERS)
S/N: 7PZ289-681-UP**

Air Filter Primary.....	A-8506
Hydraulic Oil Filter.....	H-5001
Hydraulic Oil Filter.....	H-55280
Hydraulic Oil Filter.....	H-5526
Hydraulic Oil Filter.....	H-55270

**D11R
(DOZERS)
S/N: 7PZ682-717-UP**

Air Filter Set.....	A-8506-S
Air Filter Primary.....	A-8506
Air Filter Primary.....	A-5593
Air Filter Set.....	A-5595-S
Hydraulic Oil Filter.....	H-5001
Hydraulic Oil Filter.....	H-5526
Hydraulic Oil Filter.....	H-55280
Hydraulic Oil Filter.....	H-55270

**D11R
(DOZERS)
S/N: 7PZ718-UP**

Air Filter Primary.....	A-5593
Air Filter Set.....	A-5595-S
Air Filter Set.....	A-8506-S
Air Filter Primary.....	A-8506
Hydraulic Oil Filter.....	H-5001
Hydraulic Oil Filter.....	H-55270
Hydraulic Oil Filter.....	H-5526
Hydraulic Oil Filter.....	H-55280

**D11R
(DOZERS)
S/N: AAF1-132-UP**

Air Filter Set.....	A-8506-S
Air Filter Primary.....	A-5593
Air Filter Set.....	A-5595-S
Air Filter Primary.....	A-8506
Hydraulic Oil Filter.....	H-55270
Hydraulic Oil Filter.....	H-5001
Hydraulic Oil Filter.....	H-5526
Hydraulic Oil Filter.....	H-55280

**D11R
(DOZERS)
S/N: AAF437-UP**

Air Filter Set.....	A-8506-S
Air Filter Primary.....	A-5593
Air Filter Primary.....	A-8506
Air Filter Set.....	A-5595-S
Hydraulic Oil Filter.....	H-55270
Hydraulic Oil Filter.....	H-5001
Hydraulic Oil Filter.....	H-55280
Hydraulic Oil Filter.....	H-5526

**D20D
(ARTICULATED TRUCKS)
CAT 3116 (S/N: 6NG1-UP) , 2005-UP**

Air Filter Set.....	A-5544-S
Air Filter Secondary.....	A-5520
Air Filter Primary.....	A-5543
Fuel Filter Secondary.....	FC-55151
Fuel Filter.....	F-5505
Fuel Filter.....	FC-5516
Fuel Filter Secondary.....	FC-5515
Hydraulic Oil Filter.....	H-5503
Hydraulic Oil Filter.....	H-5504
Oil Filter Full Flow.....	C-5510

MODEL/APPLICATION	SAKURA NO
-------------------	-----------

CATERPILLAR

**D20D
(ARTICULATED TRUCKS)
CAT 3116 (S/N: 9MG1-UP) , 2005-UP**

Air Filter Secondary.....	A-5520
Air Filter Set.....	A-5544-S
Air Filter Primary.....	A-5543
Fuel Filter Secondary.....	FC-5515
Fuel Filter.....	FC-5516
Fuel Filter.....	F-5505
Fuel Filter Secondary.....	FC-55151
Hydraulic Oil Filter.....	H-5504
Hydraulic Oil Filter.....	H-5503
Oil Filter Full Flow.....	C-5510

**D20D
(ARTICULATED TRUCKS)
S/N: 6NG1-UP**

Air Filter Primary.....	A-5543
Air Filter Secondary.....	A-5520
Air Filter Set.....	A-5544-S
Fuel Filter Secondary.....	FC-55151
Fuel Filter Secondary.....	FC-5515
Fuel Filter.....	F-5505
Fuel Filter.....	FC-5516
Hydraulic Oil Filter.....	H-55280
Hydraulic Oil Filter.....	H-5504
Hydraulic Oil Filter.....	H-55270
Hydraulic Oil Filter.....	H-5503
Hydraulic Oil Filter.....	H-5526
Oil Filter Full Flow.....	C-5510

**D20D
(ARTICULATED TRUCKS)
S/N: 9MG1-UP**

Air Filter Set.....	A-5544-S
Air Filter Secondary.....	A-5520
Air Filter Primary.....	A-5543
Fuel Filter Secondary.....	FC-5515
Fuel Filter Secondary.....	FC-55151
Fuel Filter.....	FC-5516
Fuel Filter.....	F-5505
Hydraulic Oil Filter.....	H-55270
Hydraulic Oil Filter.....	H-55280
Hydraulic Oil Filter.....	H-5526
Hydraulic Oil Filter.....	H-5503
Hydraulic Oil Filter.....	H-5504
Oil Filter Full Flow.....	C-5510

**D22
(DOZERS)
S/N: 9VA1-UP**

Air Filter Secondary.....	A-5502
Air Filter Primary.....	A-5501
Hydraulic Oil Filter.....	H-5504
Hydraulic Oil Filter.....	H-5503
Oil Filter Full Flow.....	C-5510

**D250E
(ARTICULATED TRUCKS)
CAT 3306 (S/N: 5TN1-UP) , 2005-UP**

Air Filter Primary.....	A-5535
Air Filter Set.....	A-5573-S
Air Filter Secondary.....	A-5534
Fuel Filter.....	F-5505
Fuel Filter Secondary.....	FC-5507
Hydraulic Oil Filter.....	H-5504
Hydraulic Oil Filter.....	H-5503
Oil Filter Full Flow.....	C-5510

MODEL/APPLICATION	SAKURA NO
-------------------	-----------

CATERPILLAR

**D250E
(ARTICULATED TRUCKS)
S/N: 4PS1-UP**

Air Filter Primary.....	A-5535
Air Filter Set.....	A-5573-S
Air Filter Secondary.....	A-5534
Fuel Filter.....	F-5505
Fuel Filter Secondary.....	FC-5507
Hydraulic Oil Filter.....	H-55270
Hydraulic Oil Filter.....	H-55280
Hydraulic Oil Filter.....	H-5503
Hydraulic Oil Filter.....	H-5504
Hydraulic Oil Filter.....	H-5526
Oil Filter Full Flow.....	C-5510

**D250E
(ARTICULATED TRUCKS)
S/N: 5TN1-UP**

Air Filter Set.....	A-5573-S
Air Filter Primary.....	A-5535
Air Filter Secondary.....	A-5534
Fuel Filter.....	F-5505
Fuel Filter Secondary.....	FC-5507
Hydraulic Oil Filter.....	H-5526
Hydraulic Oil Filter.....	H-5504
Hydraulic Oil Filter.....	H-55270
Hydraulic Oil Filter.....	H-55280
Hydraulic Oil Filter.....	H-5503
Oil Filter Full Flow.....	C-5510

**D250E
(ARTICULATED TRUCKS)
w/3306 Eng.**

Air Filter Set.....	A-5573M-S
Air Filter Primary.....	A-5535M

**D250E II
(ARTICULATED TRUCKS)
CAT 3116 (S/N: 4PS1-UP) , 2005-UP**

Air Filter Secondary.....	A-5534
Air Filter Primary.....	A-5535
Air Filter Set.....	A-5573-S
Fuel Filter.....	F-5505
Fuel Filter Secondary.....	FC-5507
Hydraulic Oil Filter.....	H-5504
Hydraulic Oil Filter.....	H-5503
Oil Filter Full Flow.....	C-5510

**D250E II
(ARTICULATED TRUCKS)
CAT 3306 (S/N: 4PS1-UP) , 2005-UP**

Air Filter Secondary.....	A-5534
Air Filter Primary.....	A-5535
Air Filter Set.....	A-5573-S
Cabin Air Filter.....	CA-55060
Fuel Filter Secondary.....	FC-5507
Hydraulic Oil Filter.....	H-5504
Oil Filter Full Flow.....	C-5510

**D25C
(ARTICULATED TRUCKS)
CAT 3306 (S/N: 9YC1-1011) , 2005-UP**

Air Filter Primary.....	A-5501
Air Filter Secondary.....	A-5502
Fuel Filter Secondary.....	FC-5507
Fuel Filter.....	F-5505
Hydraulic Oil Filter.....	H-5504
Hydraulic Oil Filter.....	H-5503
Oil Filter Full Flow.....	C-5510

MODEL/APPLICATION	SAKURA NO	MODEL/APPLICATION	SAKURA NO	MODEL/APPLICATION	SAKURA NO
CATERPILLAR		CATERPILLAR		CATERPILLAR	
D25C (ARTICULATED TRUCKS) CAT 3306 Air Filter Primary..... A-44150 Air Filter Set..... A-44150-S		Air Filter Primary..... A-5501 Air Filter Primary..... A-5535 Fuel Filter..... F-5505 Fuel Filter Secondary..... FC-5507 Hydraulic Oil Filter..... H-5526 Hydraulic Oil Filter..... H-5503 Hydraulic Oil Filter..... H-55270 Hydraulic Oil Filter..... H-55280 Hydraulic Oil Filter..... H-5504 Oil Filter Full Flow..... C-5510		D250B (ARTICULATED TRUCKS) CAT 3306 Air Filter Primary..... A-44150 Air Filter Set..... A-44150-S	
D25C (ARTICULATED TRUCKS) S/N: 9YC1-1011 Air Filter Secondary..... A-5502 Air Filter Primary..... A-5501 Fuel Filter..... F-5505 Fuel Filter Secondary..... FC-5507 Hydraulic Oil Filter..... H-5526 Hydraulic Oil Filter..... H-55280 Hydraulic Oil Filter..... H-5503 Hydraulic Oil Filter..... H-55270 Hydraulic Oil Filter..... H-5504 Oil Filter Full Flow..... C-5510		D25D (ARTICULATED TRUCKS) S/N: 3A1415-UP Air Filter Secondary..... A-5534 Air Filter Set..... A-5573-S Air Filter Primary..... A-5535 Fuel Filter..... F-5505 Hydraulic Oil Filter..... H-55280 Hydraulic Oil Filter..... H-5503 Hydraulic Oil Filter..... H-5526 Hydraulic Oil Filter..... H-5504 Hydraulic Oil Filter..... H-55270 Oil Filter Full Flow..... C-5510		D250B (ARTICULATED TRUCKS) S/N: 5WD1-550 Air Filter Secondary..... A-5502 Air Filter Primary..... A-5501 Fuel Filter Secondary..... FC-5507 Fuel Filter..... F-5505 Hydraulic Oil Filter..... H-5504 Hydraulic Oil Filter..... H-5526 Hydraulic Oil Filter..... H-55280 Hydraulic Oil Filter..... H-5503 Hydraulic Oil Filter..... H-55270 Oil Filter Full Flow..... C-5510	
D25D (ARTICULATED TRUCKS) CAT 3306 (S/N: 1HK-UP) , 2005-UP Air Filter Secondary..... A-5502 Air Filter Secondary..... A-5534 Air Filter Set..... A-5573-S Air Filter Primary..... A-5535 Fuel Filter Secondary..... FC-5507 Hydraulic Oil Filter..... H-5503 Hydraulic Oil Filter..... H-5504 Oil Filter Full Flow..... C-5510		D25D (ARTICULATED TRUCKS) S/N: 9RF1-UP Air Filter Primary..... A-5535 Air Filter Secondary..... A-5534 Air Filter Primary..... A-5501 Air Filter Secondary..... A-5502 Air Filter Set..... A-5573-S Fuel Filter Secondary..... FC-5507 Fuel Filter..... F-5505 Hydraulic Oil Filter..... H-5504 Hydraulic Oil Filter..... H-5526 Hydraulic Oil Filter..... H-55270 Hydraulic Oil Filter..... H-5503 Hydraulic Oil Filter..... H-55280 Oil Filter Full Flow..... C-5510		D250D (ARTICULATED TRUCKS) CAT 3116 (S/N: 6NG1-UP) , 2005-UP Air Filter Primary..... A-5543 Air Filter Secondary..... A-5520 Air Filter Set..... A-5544-S Fuel Filter..... F-5505 Fuel Filter..... FC-5516 Fuel Filter Secondary..... FC-55151 Fuel Filter Secondary..... FC-5515 Hydraulic Oil Filter..... H-5503 Hydraulic Oil Filter..... H-5504 Oil Filter Full Flow..... C-5510	
D25D (ARTICULATED TRUCKS) S/N: 1HK1-673 Air Filter Primary..... A-5535 Air Filter Set..... A-5573-S Air Filter Secondary..... A-5502 Air Filter Secondary..... A-5534 Air Filter Primary..... A-5501 Fuel Filter Secondary..... FC-5507 Fuel Filter..... F-5505 Hydraulic Oil Filter..... H-55270 Hydraulic Oil Filter..... H-5504 Hydraulic Oil Filter..... H-5503 Hydraulic Oil Filter..... H-55280 Hydraulic Oil Filter..... H-5526 Oil Filter Full Flow..... C-5510		D25D (ARTICULATED TRUCKS) S/N: 9VA1-UP Air Filter Secondary..... A-5502 Air Filter Primary..... A-5501 Hydraulic Oil Filter..... H-5503 Hydraulic Oil Filter..... H-5504 Oil Filter Full Flow..... C-5510		D250D (ARTICULATED TRUCKS) CAT 3116 (S/N: 9MG1-UP) , 2005-UP Air Filter Secondary..... A-5520 Air Filter Set..... A-5544-S Air Filter Primary..... A-5543 Fuel Filter Secondary..... FC-55151 Fuel Filter..... FC-5516 Fuel Filter Secondary..... FC-5515 Fuel Filter..... F-5505 Hydraulic Oil Filter..... H-5504 Hydraulic Oil Filter..... H-5503 Oil Filter Full Flow..... C-5510	
D25D (ARTICULATED TRUCKS) S/N: 1HK674-UP Air Filter Set..... A-5573-S Air Filter Secondary..... A-5534 Air Filter Primary..... A-5535 Fuel Filter..... F-5505 Hydraulic Oil Filter..... H-5526 Hydraulic Oil Filter..... H-55280 Hydraulic Oil Filter..... H-5504 Hydraulic Oil Filter..... H-55270 Hydraulic Oil Filter..... H-5503 Oil Filter Full Flow..... C-5510		D25D (ARTICULATED TRUCKS) S/N: 3AJ1-414 Air Filter Set..... A-5573-S Air Filter Secondary..... A-5534 Air Filter Secondary..... A-5502		D250D (ARTICULATED TRUCKS) S/N: 6NG1-UP Air Filter Set..... A-5544-S Air Filter Secondary..... A-5520 Air Filter Primary..... A-5543 Fuel Filter Secondary..... FC-55151 Fuel Filter..... FC-5516 Fuel Filter..... F-5505 Fuel Filter Secondary..... FC-5515 Hydraulic Oil Filter..... H-5504 Hydraulic Oil Filter..... H-5503 Oil Filter Full Flow..... C-5510	
D25D (ARTICULATED TRUCKS) S/N: 3AJ1-414 Air Filter Set..... A-5573-S Air Filter Secondary..... A-5534 Air Filter Secondary..... A-5502		D250B (ARTICULATED TRUCKS) CAT 3306 (S/N: 5WD1-550) , 2005-UP Air Filter Secondary..... A-5502 Air Filter Primary..... A-5501 Fuel Filter Secondary..... FC-5507 Fuel Filter..... F-5505 Hydraulic Oil Filter..... H-5503 Hydraulic Oil Filter..... H-5504 Oil Filter Full Flow..... C-5510		D250D (ARTICULATED TRUCKS) S/N: 9MG1-UP Air Filter Secondary..... A-5520	

MODEL/APPLICATION	SAKURA NO
CATERPILLAR	
D250D (ARTICULATED TRUCKS) S/N: 9M61-UP	
Air Filter Set.....	A-5544-S
Air Filter Primary.....	A-5543
Fuel Filter Secondary.....	FC-5515
Fuel Filter.....	F-5505
Fuel Filter.....	FC-5516
Fuel Filter Secondary.....	FC-55151
Hydraulic Oil Filter.....	H-5504
Hydraulic Oil Filter.....	H-55270
Hydraulic Oil Filter.....	H-5503
Hydraulic Oil Filter.....	H-55280
Hydraulic Oil Filter.....	H-5526
Oil Filter Full Flow.....	C-5510
D250E SERIES II (ARTICULATED TRUCKS)	
Air Filter Set.....	A-5573-S
Air Filter Primary.....	A-5535
Fuel Filter.....	F-5505
Fuel Filter Secondary.....	FC-5507
Hydraulic Oil Filter.....	H-5503
Hydraulic Oil Filter.....	H-5504
Hydraulic Oil Filter.....	H-5526
Hydraulic Oil Filter.....	H-55270
Hydraulic Oil Filter.....	H-55280
Oil Filter Full Flow.....	C-5510
D250E SERIES II (ARTICULATED TRUCKS) w/3306 Eng.	
Air Filter Primary.....	A-5535M
Air Filter Set.....	A-5573M-S
D300B (ARTICULATED TRUCKS) CAT 3306 (S/N: 4SD1-573) , 2005-UP	
Air Filter Secondary.....	A-5502
Air Filter Primary.....	A-5501
Fuel Filter.....	F-5505
Fuel Filter Secondary.....	FC-5507
Hydraulic Oil Filter.....	H-5504
Hydraulic Oil Filter.....	H-5503
Oil Filter Full Flow.....	C-5510
D300E (ARTICULATED TRUCKS) CAT 3306 (S/N: 7FN1-UP) , 2005-UP	
Air Filter Set.....	A-5573-S
Air Filter Primary.....	A-5535
Air Filter Secondary.....	A-5534
Fuel Filter.....	F-5505
Fuel Filter Secondary.....	FC-5507
Hydraulic Oil Filter.....	H-5504
Hydraulic Oil Filter.....	H-5503
Oil Filter Full Flow.....	C-5510
D300E (ARTICULATED TRUCKS) S/N: 5KS1-UP	
Air Filter Primary.....	A-5535
Air Filter Set.....	A-5573-S
Air Filter Secondary.....	A-5534
Fuel Filter Secondary.....	FC-5507
Fuel Filter.....	F-5505
Hydraulic Oil Filter.....	H-5504
Hydraulic Oil Filter.....	H-5526
Hydraulic Oil Filter.....	H-55270
Hydraulic Oil Filter.....	H-55280
Oil Filter Full Flow.....	C-5510

MODEL/APPLICATION	SAKURA NO
CATERPILLAR	
Hydraulic Oil Filter.....	H-5503
Hydraulic Oil Filter.....	H-55280
Oil Filter Full Flow.....	C-5510
D300E (ARTICULATED TRUCKS) S/N: 7FN1-UP	
Air Filter Secondary.....	A-5534
Air Filter Primary.....	A-5535
Air Filter Set.....	A-5573-S
Fuel Filter Secondary.....	FC-5507
Fuel Filter.....	F-5505
Hydraulic Oil Filter.....	H-55270
Hydraulic Oil Filter.....	H-5503
Hydraulic Oil Filter.....	H-5526
Hydraulic Oil Filter.....	H-5504
Hydraulic Oil Filter.....	H-55280
Oil Filter Full Flow.....	C-5510
D300E (ARTICULATED TRUCKS) w/3306 Eng.	
Air Filter Primary.....	A-5535M
Air Filter Set.....	A-5573M-S
D300E II (ARTICULATED TRUCKS) CAT 3306 (S/N: 5KS1-UP) , 2005-UP	
Air Filter Set.....	A-5573-S
Air Filter Primary.....	A-5535
Air Filter Secondary.....	A-5534
Fuel Filter Secondary.....	FC-5507
Fuel Filter.....	F-5505
Hydraulic Oil Filter.....	H-5504
Hydraulic Oil Filter.....	H-5503
Oil Filter Full Flow.....	C-5510
D30C (ARTICULATED TRUCKS) CAT 3306 (S/N: 7ZC1-257) , 2005-UP	
Air Filter Secondary.....	A-5502
Air Filter Primary.....	A-5501
Fuel Filter Secondary.....	FC-5507
Fuel Filter.....	F-5505
Hydraulic Oil Filter.....	H-5503
Hydraulic Oil Filter.....	H-5504
Oil Filter Full Flow.....	C-5510
D30C (ARTICULATED TRUCKS) CAT 3306	
Air Filter Primary.....	A-44150
Air Filter Set.....	A-44150-S
D30C (ARTICULATED TRUCKS) S/N: 7ZC1-257	
Air Filter Primary.....	A-5501
Air Filter Secondary.....	A-5502
Fuel Filter Secondary.....	FC-5507
Fuel Filter.....	F-5505
Hydraulic Oil Filter.....	H-5503
Hydraulic Oil Filter.....	H-5504
Hydraulic Oil Filter.....	H-5526
Hydraulic Oil Filter.....	H-55270
Hydraulic Oil Filter.....	H-55280
Oil Filter Full Flow.....	C-5510
D30D (ARTICULATED TRUCKS) CAT 3306 (S/N: 3AJ1-UP) , 2005-UP	
Air Filter Secondary.....	A-5502

MODEL/APPLICATION	SAKURA NO
CATERPILLAR	
Fuel Filter Secondary.....	FC-5507
Hydraulic Oil Filter.....	H-5503
Hydraulic Oil Filter.....	H-5504
Oil Filter Full Flow.....	C-5510
D30D (ARTICULATED TRUCKS) S/N: 1HK1-673	
Air Filter Primary.....	A-5535
Air Filter Primary.....	A-5501
Air Filter Secondary.....	A-5534
Air Filter Secondary.....	A-5502
Air Filter Set.....	A-5573-S
Fuel Filter.....	F-5505
Fuel Filter Secondary.....	FC-5507
Hydraulic Oil Filter.....	H-5526
Hydraulic Oil Filter.....	H-55270
Hydraulic Oil Filter.....	H-5504
Hydraulic Oil Filter.....	H-5503
Hydraulic Oil Filter.....	H-55280
Oil Filter Full Flow.....	C-5510
D30D (ARTICULATED TRUCKS) S/N: 1HK674-UP	
Air Filter Secondary.....	A-5534
Air Filter Primary.....	A-5535
Air Filter Set.....	A-5573-S
Fuel Filter Secondary.....	FC-5507
Fuel Filter.....	F-5505
Hydraulic Oil Filter.....	H-55280
Hydraulic Oil Filter.....	H-5503
Hydraulic Oil Filter.....	H-5526
Hydraulic Oil Filter.....	H-5504
Hydraulic Oil Filter.....	H-55270
Oil Filter Full Flow.....	C-5510
D30D (ARTICULATED TRUCKS) S/N: 3AJ1-414	
Air Filter Primary.....	A-5535
Air Filter Set.....	A-5573-S
Air Filter Secondary.....	A-5502
Air Filter Secondary.....	A-5534
Air Filter Primary.....	A-5501
Fuel Filter Secondary.....	FC-5507
Fuel Filter.....	F-5505
Hydraulic Oil Filter.....	H-55270
Hydraulic Oil Filter.....	H-55280
Hydraulic Oil Filter.....	H-5504
Hydraulic Oil Filter.....	H-5526
Hydraulic Oil Filter.....	H-5503
Oil Filter Full Flow.....	C-5510
D30D (ARTICULATED TRUCKS) S/N: 3AJ415-UP	
Air Filter Primary.....	A-5535
Air Filter Set.....	A-5573-S
Air Filter Secondary.....	A-5534
Fuel Filter Secondary.....	FC-5507
Fuel Filter.....	F-5505
Hydraulic Oil Filter.....	H-5504
Hydraulic Oil Filter.....	H-5526
Hydraulic Oil Filter.....	H-55280
Hydraulic Oil Filter.....	H-5503
Hydraulic Oil Filter.....	H-55270

MODEL/APPLICATION	SAKURA NO	MODEL/APPLICATION	SAKURA NO	MODEL/APPLICATION	SAKURA NO
CATERPILLAR		CATERPILLAR		CATERPILLAR	
D350E (ARTICULATED TRUCKS) CAT 3406 (S/N: 2XW1-UP) , 2005-UP Air Filter Primary..... A-5535 Air Filter Set..... A-5573-S Air Filter Secondary..... A-5534 Air Filter..... AH-7001 Fuel Filter..... FC-5509 Fuel/Water Separator Secondary.. SFC-5504-10 Fuel/Water Separator Secondary.. SFC-5504-10B Hydraulic Oil Filter..... H-5526 Hydraulic Oil Filter..... H-5504 Oil Filter Full Flow..... C-5516		D35C (ARTICULATED TRUCKS) S/N: 2GD1-124 Air Filter Primary..... A-5501 Air Filter Secondary..... A-5502 Fuel Filter..... F-5505 Fuel Filter Secondary..... FC-5507 Hydraulic Oil Filter..... H-5504 Hydraulic Oil Filter..... H-55280 Hydraulic Oil Filter..... H-5526 Hydraulic Oil Filter..... H-5503 Hydraulic Oil Filter..... H-55270 Oil Filter Full Flow..... C-5510		Fuel Filter..... FC-5501 Oil Filter Full Flow..... C-5519 Oil Filter Full Flow..... C-5505 D3B (DOZERS) S/N: 23Y1-UP Air Filter Primary..... A-5542 Air Filter Set..... A-5542-S Air Filter Secondary..... A-5525 Fuel Filter..... FC-5503 Hydraulic Oil Filter..... H-5504 Oil Filter Full Flow..... C-5519 D3B (DOZERS) S/N: 24Y1-UP Air Filter Set..... A-5542-S Air Filter Primary..... A-5542 Air Filter Secondary..... A-5525 Fuel Filter..... FC-5503 Hydraulic Oil Filter..... H-5504 Oil Filter Full Flow..... C-5519 D3B (DOZERS) S/N: 27Y1-UP Air Filter Secondary..... A-5525 Air Filter Set..... A-5542-S Air Filter Primary..... A-5542 Fuel Filter..... FC-5503 Hydraulic Oil Filter..... H-5504 Oil Filter Full Flow..... C-5519 D3B (DOZERS) S/N: 28Y1-UP Air Filter Secondary..... A-5525 Air Filter Primary..... A-5542 Air Filter Set..... A-5542-S Fuel Filter..... FC-5503 Hydraulic Oil Filter..... H-5504 Oil Filter Full Flow..... C-5519 D3B (DOZERS) S/N: 2PC1-245 Air Filter Secondary..... A-5522 Air Filter Primary..... A-5509 Air Filter Set..... A-5522-S Hydraulic Oil Filter..... H-5501 D3B (DOZERS) S/N: 2PC1-UP Air Filter Primary..... A-5509 Air Filter Secondary..... A-5522 Air Filter Set..... A-5522-S Fuel Filter Secondary..... FC-5507 Hydraulic Oil Filter..... H-5504 Hydraulic Oil Filter..... H-55270 Oil Filter Full Flow..... C-5505 D3B (DOZERS) S/N: 2PC246-UP Air Filter Primary..... A-5509 Air Filter Set..... A-5522-S Air Filter Secondary..... A-5522 Hydraulic Oil Filter..... H-5501 Hydraulic Oil Filter..... H-5504	
D350E (ARTICULATED TRUCKS) CAT 3406 (S/N: 9LR1-UP) , 2005-UP Air Filter Set..... A-5573-S Air Filter Primary..... A-5535 Air Filter Secondary..... A-5534 Fuel Filter..... F-5505 Fuel Filter..... FC-5509 Hydraulic Oil Filter..... H-5503 Hydraulic Oil Filter..... H-5504 Oil Filter Full Flow..... C-5516		D35 HP (ARTICULATED TRUCKS) CAT 3406 (S/N: 3FD1-79) , 2005-UP Air Filter Primary..... A-5501 Air Filter Secondary..... A-5502 Fuel Filter..... F-5505 Fuel Filter..... FC-5509 Hydraulic Oil Filter..... H-5504 Hydraulic Oil Filter..... H-5503 Oil Filter Full Flow..... C-5516			
D350E (ARTICULATED TRUCKS) Hydraulic Oil Filter Suction..... H-5516		D350E SERIES II (ARTICULATED TRUCKS) CAT 3406E (S/N: 2XW1-UP) Air Filter Set..... A-5573-S Air Filter Primary..... A-5535 Air Filter Secondary..... A-5534 Fuel Filter..... FC-5509 Fuel/Water Separator Secondary.. SFC-5504-10 Fuel/Water Separator Secondary.. SFC-5504-10B Hydraulic Oil Filter..... H-55270 Hydraulic Oil Filter..... H-5504 Hydraulic Oil Filter..... H-5526 Oil Filter Full Flow..... C-5516			
D350E (ARTICULATED TRUCKS) S/N: 9LR1-UP Air Filter Set..... A-5573-S Air Filter Primary..... A-5535 Air Filter Secondary..... A-5534 Fuel Filter..... FC-5509 Hydraulic Oil Filter..... H-5504 Hydraulic Oil Filter..... H-5526 Hydraulic Oil Filter..... H-55270 Hydraulic Oil Filter..... H-55280 Hydraulic Oil Filter..... H-5503 Oil Filter Full Flow..... C-5516		D350E SERIES II (ARTICULATED TRUCKS) w/3406E Eng. Air Filter Set..... A-5573M-S Air Filter Primary..... A-5535M			
D350E (ARTICULATED TRUCKS) w/3406 Eng. Air Filter Set..... A-5573M-S Air Filter Primary..... A-5535M		D35C HP (ARTICULATED TRUCKS) S/N: 3FD1-UP Air Filter Secondary..... A-5502 Air Filter Primary..... A-5501 Fuel Filter..... FC-5519 Hydraulic Oil Filter..... H-5503 Hydraulic Oil Filter..... H-5504 Oil Filter Full Flow..... C-5516			
D350E II (ARTICULATED TRUCKS) CAT 3406E Hydraulic Oil Filter..... H-71190-12		D35C (ARTICULATED TRUCKS) CAT 3306 (S/N: 2GD1-124) , 2005-UP Air Filter Primary..... A-5501 Air Filter Secondary..... A-5502 Fuel Filter Secondary..... FC-5507 Fuel Filter..... F-5505 Hydraulic Oil Filter..... H-5503 Hydraulic Oil Filter..... H-5504 Oil Filter Full Flow..... C-5510			
D35C (ARTICULATED TRUCKS) CAT 3306 (S/N: 2GD1-124) , 2005-UP Air Filter Primary..... A-5501 Air Filter Secondary..... A-5502 Fuel Filter Secondary..... FC-5507 Fuel Filter..... F-5505 Hydraulic Oil Filter..... H-5503 Hydraulic Oil Filter..... H-5504 Oil Filter Full Flow..... C-5510		D3B (DOZERS) CAT (S/N: 45V32894-40546) Oil Filter Full Flow..... C-5519 D3B (DOZERS) CAT (S/N: 45V40547-72653) Fuel Filter Secondary..... FC-5507 Oil Filter Full Flow..... C-5519 Oil Filter Full Flow..... C-5505			
D35C (ARTICULATED TRUCKS) CAT 3306 Air Filter Primary..... A-44150 Air Filter Set..... A-44150-S		D3B (DOZERS) CAT (S/N: 45V72654-UP) Fuel Filter Secondary..... FC-5507 Fuel Filter..... FC-5523			

Sakura Filter

ENGINE APPLICATION

MODEL/APPLICATION	SAKURA NO	MODEL/APPLICATION	SAKURA NO	MODEL/APPLICATION	SAKURA NO
CATERPILLAR		CATERPILLAR		CATERPILLAR	
D3B (DOZERS) S/N: 3YC1-UP Hydraulic Oil Filter..... H-5501 Hydraulic Oil Filter..... H-5504		D3C (DOZERS) S/N: 3RF1-UP Air Filter Secondary..... A-5525 Air Filter Primary..... A-5542 Air Filter Set..... A-5542-S Fuel Filter Secondary..... FC-5507 Hydraulic Oil Filter..... H-5504 Hydraulic Oil Filter..... H-55270 Oil Filter Full Flow..... C-5519		D3C (DOZERS) S/N: 5ZG1-UP Air Filter Set..... A-5542-S Air Filter Secondary..... A-5525 Air Filter Primary..... A-5542 Fuel Filter Secondary..... FC-5507 Hydraulic Oil Filter..... H-55270 Hydraulic Oil Filter..... H-5504 Oil Filter Full Flow..... C-5519	
D3B (DOZERS) S/N: 5MC1-UP Hydraulic Oil Filter..... H-5501 Hydraulic Oil Filter..... H-5504		D3C (DOZERS) S/N: 4HJ1-UP Air Filter Primary..... A-5542 Air Filter Secondary..... A-5525 Air Filter Set..... A-5542-S Fuel Filter Secondary..... FC-5507 Hydraulic Oil Filter..... H-5504 Hydraulic Oil Filter..... H-55270 Oil Filter Full Flow..... C-5519		D3C (DOZERS) S/N: 6PF1-UP Air Filter Secondary..... A-5525 Air Filter Primary..... A-5542 Air Filter Set..... A-5542-S Fuel Filter Secondary..... FC-5507 Hydraulic Oil Filter..... H-5504 Hydraulic Oil Filter..... H-55270 Oil Filter Full Flow..... C-5519	
D3B (DOZERS) w/3204 Eng. Air Filter Secondary..... A-5590 Hydraulic Oil Filter..... H-55320		D3C (DOZERS) S/N: 4KS1-UP Air Filter Secondary..... A-5525 Air Filter Set..... A-5542-S Air Filter Primary..... A-5542 Hydraulic Oil Filter..... HC-5504 Oil Filter Full Flow..... C-5504		D3C (DOZERS) S/N: 6SL1-UP Air Filter Secondary..... A-5525 Air Filter Primary..... A-5542 Air Filter Set..... A-5542-S Hydraulic Oil Filter..... H-5504 Hydraulic Oil Filter..... H-55270 Oil Filter Full Flow..... C-5504	
D3B LGP (DOZERS) S/N: 3YC1-UP Air Filter Set..... A-5542-S Air Filter Secondary..... A-5525 Air Filter Primary..... A-5542 Fuel Filter Secondary..... FC-5507 Fuel Filter..... FC-5503 Hydraulic Oil Filter..... H-5504 Hydraulic Oil Filter..... H-55270 Oil Filter Full Flow..... C-5519		D3C (DOZERS) S/N: 4TS1-UP Air Filter Secondary..... A-5525 Air Filter Set..... A-5542-S Air Filter Primary..... A-5542 Hydraulic Oil Filter..... HC-5504 Oil Filter Full Flow..... C-5504		D3C (DOZERS) S/N: 7JF1-UP Air Filter Set..... A-5522-S Air Filter Secondary..... A-5522 Air Filter Primary..... A-5509 Fuel Filter Secondary..... FC-5507 Hydraulic Oil Filter..... H-5504 Hydraulic Oil Filter..... H-55270 Oil Filter Full Flow..... C-5505	
D3B LGP (DOZERS) S/N: 5MC1-UP Air Filter Secondary..... A-5525 Air Filter Primary..... A-5542 Air Filter Set..... A-5542-S Fuel Filter Secondary..... FC-5507 Fuel Filter..... FC-5503 Hydraulic Oil Filter..... H-5504 Hydraulic Oil Filter..... H-55270 Oil Filter Full Flow..... C-5519		D3C (DOZERS) S/N: 5CJ1-UP Air Filter Set..... A-5542-S Air Filter Primary..... A-5542 Air Filter Secondary..... A-5525 Fuel Filter Secondary..... FC-5507 Hydraulic Oil Filter..... H-5504 Hydraulic Oil Filter..... H-55270 Oil Filter Full Flow..... C-5519		D3C (DOZERS) S/N: 7JG1-UP Air Filter Primary..... A-5542 Air Filter Set..... A-5542-S Air Filter Secondary..... A-5525 Fuel Filter Secondary..... FC-5507 Hydraulic Oil Filter..... H-5504 Hydraulic Oil Filter..... H-55270 Oil Filter Full Flow..... C-5519	
D3C (DOZERS) CAT (S/N: 45V1-69305) Oil Filter Full Flow..... C-5505		D3C (DOZERS) S/N: 5GS1-UP Air Filter Primary..... A-5542 Air Filter Set..... A-5542-S Air Filter Secondary..... A-5525 Fuel Filter Secondary..... FC-5507 Hydraulic Oil Filter..... H-5504 Hydraulic Oil Filter..... H-55270 Oil Filter Full Flow..... C-5519		D3C (DOZERS) S/N: 7XL1-UP Air Filter Primary..... A-5542 Air Filter Set..... A-5542-S Air Filter Secondary..... A-5525 Fuel Filter Secondary..... FC-5507 Hydraulic Oil Filter..... H-5504 Hydraulic Oil Filter..... H-55270 Oil Filter Full Flow..... C-5519	
D3C (DOZERS) CAT (S/N: 45V69306-70377) Fuel Filter..... FC-5523 Fuel Filter..... FC-5501 Oil Filter Full Flow..... C-5519 Oil Filter Full Flow..... C-5505		D3C (DOZERS) S/N: 5KG1-UP Air Filter Primary..... A-5542 Air Filter Set..... A-5542-S Air Filter Secondary..... A-5525 Hydraulic Oil Filter..... HC-5504 Oil Filter Full Flow..... C-5504		D3C (DOZERS) S/N: 7YJ1-UP Fuel Filter Secondary..... FC-5507 Fuel Filter..... FC-5523 Fuel Filter..... FC-5501 Oil Filter Full Flow..... C-5519	
D3C (DOZERS) CAT (S/N: 45V70378-UP) Fuel Filter..... FC-5523 Fuel Filter Secondary..... FC-5507 Fuel Filter..... FC-5501 Oil Filter Full Flow..... C-5505 Oil Filter Full Flow..... C-5519		D3C (DOZERS) S/N: 5KJ1-UP Air Filter Primary..... A-5542 Air Filter Set..... A-5542-S Air Filter Secondary..... A-5525 Fuel Filter Secondary..... FC-5507 Hydraulic Oil Filter..... H-5504 Hydraulic Oil Filter..... H-55270 Oil Filter Full Flow..... C-5519		D3C (DOZERS) S/N: 7YJ1-UP Fuel Filter Secondary..... FC-5507 Fuel Filter..... FC-5523 Fuel Filter..... FC-5501 Oil Filter Full Flow..... C-5519	
D3C (DOZERS) S/N: 1PJ1-UP Air Filter Secondary..... A-5525 Air Filter Primary..... A-5542 Air Filter Set..... A-5542-S Fuel Filter Secondary..... FC-5507 Hydraulic Oil Filter..... H-5504 Hydraulic Oil Filter..... H-55270 Oil Filter Full Flow..... C-5519					

Sakura Filter

ENGINE APPLICATION

MODEL/APPLICATION	SAKURA NO	MODEL/APPLICATION	SAKURA NO	MODEL/APPLICATION	SAKURA NO
CATERPILLAR		CATERPILLAR		CATERPILLAR	
D3C (DOZERS) S/N: 7YJ1-UP		Air Filter Primary.....	A-5542	Fuel Filter.....	FC-5501
Oil Filter Full Flow.....	C-5505	Air Filter Secondary.....	A-5525	Oil Filter Full Flow.....	C-5505
		Fuel Filter Secondary.....	FC-5507	Oil Filter Full Flow.....	C-5519
D3C (DOZERS) S/N: 8BF1-UP		Hydraulic Oil Filter.....	H-5504		
Air Filter Secondary.....	A-5525	Hydraulic Oil Filter.....	H-55270	D3C SERIES II (DOZERS) CAT (S/N: 7YJ2722-UP)	
Air Filter Primary.....	A-5542	Oil Filter Full Flow.....	C-5519	Fuel Filter.....	FC-5523
Air Filter Set.....	A-5542-S			Fuel Filter.....	FC-5501
Fuel Filter Secondary.....	FC-5507	D3C LGP XL SERIES III (DOZERS) S/N: 4KS1-UP		Fuel Filter Secondary.....	FC-5507
Hydraulic Oil Filter.....	H-55270	Air Filter Secondary.....	A-5525	Oil Filter Full Flow.....	C-5505
Hydraulic Oil Filter.....	H-5504	Air Filter Primary.....	A-5542	Oil Filter Full Flow.....	C-5519
Oil Filter Full Flow.....	C-5519	Air Filter Set.....	A-5542-S		
		Hydraulic Oil Filter.....	HC-5504	D3C SERIES II (DOZERS) S/N: 8DG1-UP	
D3C (DOZERS) S/N: 8DG1-UP		Oil Filter Full Flow.....	C-5504	Air Filter Secondary.....	A-5525
Air Filter Secondary.....	A-5525			Air Filter Primary.....	A-5542
Air Filter Primary.....	A-5542	D3C LGP XL SERIES III (DOZERS) S/N: 4TS1-UP		Air Filter Set.....	A-5542-S
Air Filter Set.....	A-5542-S	Air Filter Primary.....	A-5542	Hydraulic Oil Filter.....	H-5504
Fuel Filter Secondary.....	FC-5507	Air Filter Set.....	A-5542-S	Hydraulic Oil Filter.....	H-55270
Hydraulic Oil Filter.....	H-5504	Air Filter Secondary.....	A-5525		
Hydraulic Oil Filter.....	H-55270	Hydraulic Oil Filter.....	HC-5504	D3C SERIES II (DOZERS) w/3204 Eng.	
Oil Filter Full Flow.....	C-5519	Oil Filter Full Flow.....	C-5504	Hydraulic Oil Filter.....	H-55320
D3C (DOZERS) S/N: 9CL1-UP		D3C LGP XL SERIES III (DOZERS) S/N: 5GS1-UP		D3C SERIES III (DOZERS) CAT (S/N: 5XK1-UP)	
Oil Filter Full Flow.....	C-5519	Air Filter Primary.....	A-5542	Fuel Filter.....	FC-5516
		Air Filter Set.....	A-5542-S	Fuel Filter.....	FC-1010
D3C (DOZERS) S/N: 9TS1-UP		Air Filter Secondary.....	A-5525	Fuel Filter Secondary.....	FC-5515
Air Filter Secondary.....	A-5525	Hydraulic Oil Filter.....	HC-5504	Fuel Filter Secondary.....	FC-55151
Air Filter Primary.....	A-5542	Oil Filter Full Flow.....	C-5504	Oil Filter Full Flow.....	C-5504
Air Filter Set.....	A-5542-S				
Oil Filter Full Flow.....	C-5504	D3C LGP XL SERIES III (DOZERS) S/N: 6SL1-UP		D3C SERIES III (DOZERS) S/N: 4KS1-394	
		Air Filter Set.....	A-5542-S	Air Filter Set.....	A-5542-S
D3C (DOZERS) w/3046 Eng.		Air Filter Secondary.....	A-5525	Air Filter Secondary.....	A-5525
Air Filter Secondary.....	A-5590	Air Filter Primary.....	A-5542	Air Filter Primary.....	A-5542
		Hydraulic Oil Filter.....	H-5504	Air Filter Primary.....	A-5542
D3C (DOZERS) w/3204 Eng.		Hydraulic Oil Filter.....	H-55270	Cabin Air Filter.....	CA-55070
Hydraulic Oil Filter.....	H-55320	Oil Filter Full Flow.....	C-5504	Hydraulic Oil Filter.....	HC-5504
D3C LGP (DOZERS) S/N: 1PJ1-UP		D3C LGP XL SERIES III (DOZERS) S/N: 7XL1-UP		D3C SERIES III (DOZERS) S/N: 4KS395-UP	
Air Filter Primary.....	A-5542	Air Filter Primary.....	A-5542	Air Filter Secondary.....	A-5525
Air Filter Secondary.....	A-5525	Air Filter Set.....	A-5542-S	Air Filter Set.....	A-5542-S
Air Filter Set.....	A-5542-S	Air Filter Secondary.....	A-5525	Air Filter Primary.....	A-5542
Fuel Filter Secondary.....	FC-5507	Hydraulic Oil Filter.....	H-55270	Cabin Air Filter.....	CA-55070
Hydraulic Oil Filter.....	H-5504	Hydraulic Oil Filter.....	H-5504	Hydraulic Oil Filter.....	HC-5504
Hydraulic Oil Filter.....	H-55270	Oil Filter Full Flow.....	C-5504		
Oil Filter Full Flow.....	C-5519			D3C SERIES III (DOZERS) S/N: 5GS1-373	
		D3C LGP XL SERIES III (DOZERS) S/N: 9TS1-UP		Air Filter Primary.....	A-5542
D3C LGP (DOZERS) S/N: 5KG1-UP		Air Filter Primary.....	A-5542	Air Filter Set.....	A-5542-S
Air Filter Set.....	A-5542-S	Air Filter Secondary.....	A-5525	Air Filter Secondary.....	A-5525
Air Filter Primary.....	A-5542	Air Filter Set.....	A-5542-S	Cabin Air Filter.....	CA-55070
Air Filter Secondary.....	A-5525	Oil Filter Full Flow.....	C-5504	Hydraulic Oil Filter.....	HC-5504
Fuel Filter Secondary.....	FC-5507				
Hydraulic Oil Filter.....	H-5504	D3C SERIES II (DOZERS) CAT (S/N: 45V90750-UP)		D3C SERIES III (DOZERS) S/N: 5GS374-UP	
Hydraulic Oil Filter.....	H-55270	Fuel Filter.....	FC-5501	Air Filter Secondary.....	A-5525
Oil Filter Full Flow.....	C-5519	Fuel Filter.....	FC-5523	Air Filter Primary.....	A-5542
		Oil Filter Full Flow.....	C-5519	Air Filter Set.....	A-5542-S
D3C LGP (DOZERS) S/N: 8BF1-UP				Cabin Air Filter.....	CA-55070
Air Filter Set.....	A-5542-S	D3C SERIES II (DOZERS) CAT (S/N: 7YJ1-2721)		Hydraulic Oil Filter.....	HC-5504
		Fuel Filter.....	FC-5523		
Air Filter Primary.....	A-5542	Fuel Filter Secondary.....	FC-5507	D3C SERIES III (DOZERS) S/N: 6SL1-2555	

MODEL/APPLICATION	SAKURA NO	MODEL/APPLICATION	SAKURA NO	MODEL/APPLICATION	SAKURA NO
CATERPILLAR		CATERPILLAR		CATERPILLAR	
D3C SERIES III (DOZERS) S/N: 6SL1-2555		Hydraulic Oil Filter..... HC-5504		Air Filter Set..... A-5573-S	
Air Filter Secondary.....	A-5525	D3G (DOZERS) S/N: CFF1-UP		Air Filter Primary.....	A-5535
Air Filter Primary.....	A-5542	Hydraulic Oil Filter.....	HC-55220	Air Filter Primary.....	A-5501
Air Filter Set.....	A-5542-S	Hydraulic Oil Filter.....	HC-5507	Air Filter Secondary.....	A-5534
Cabin Air Filter.....	CA-55070	Hydraulic Oil Filter.....	HC-5504	Fuel Filter.....	FC-5509
Hydraulic Oil Filter.....	H-5501	D3G (DOZERS) S/N: JMH1-UP		Fuel Filter.....	FC-5502
Hydraulic Oil Filter.....	H-55270	Hydraulic Oil Filter.....	HC-5504	Hydraulic Oil Filter.....	H-5504
D3C SERIES III (DOZERS) S/N: 6SL2556-UP		Hydraulic Oil Filter.....	HC-5507	Hydraulic Oil Filter.....	H-55270
Air Filter Primary.....	A-5542	D3 G LGP (DOZERS) CAT 3046 T		D400 (ARTICULATED TRUCKS) CAT 3406 (S/N: 2YR-UP)	
Air Filter Set.....	A-5542-S	Air Filter Secondary.....	A-4402	Air Filter Secondary.....	A-5502
Air Filter Secondary.....	A-5525	Oil Filter Full Flow.....	C-6218	Air Filter Primary.....	A-5501
Cabin Air Filter.....	CA-55070	D3K (DOZERS) CAT S/N: C4E1-49-UP , 2007-UP		Air Filter Secondary.....	A-5534
Hydraulic Oil Filter.....	H-5501	Hydraulic Oil Filter.....	HC-5504	Air Filter Set.....	A-5573-S
Hydraulic Oil Filter.....	H-55270	Oil Filter Full Flow.....	C-5102	Air Filter Primary.....	A-5535
D3C SERIES III (DOZERS) S/N: 7XL1108-UP		D3K (DOZERS) CAT S/N: C4E50-UP , 2007-UP		Fuel Filter.....	FC-5502
Air Filter Secondary.....	A-5525	Hydraulic Oil Filter.....	HC-5504	Fuel Filter.....	FC-5509
Air Filter Primary.....	A-5542	Oil Filter Full Flow.....	C-5102	Hydraulic Oil Filter.....	H-55270
Air Filter Set.....	A-5542-S	D3K (DOZERS) CAT S/N: C4E50-UP , 2007-UP		Hydraulic Oil Filter.....	H-5504
Cabin Air Filter.....	CA-55070	Hydraulic Oil Filter.....	HC-5504	Hydraulic Oil Filter.....	H-5504
Hydraulic Oil Filter.....	H-5501	Oil Filter Full Flow.....	C-5102	D400 (ARTICULATED TRUCKS) CAT 3406 (S/N: 8TF-UP)	
Hydraulic Oil Filter.....	H-55270	D3K (DOZERS) CAT S/N: FFF1-UP , 2007-UP		Air Filter Set.....	A-5573-S
D3C SERIES III (DOZERS) S/N: 7XL1-1107		Oil Filter Full Flow.....	C-5102	Air Filter Primary.....	A-5535
Air Filter Secondary.....	A-5525	D3K (DOZERS) CAT S/N: LLL1-UP , 2007-UP		Air Filter Primary.....	A-5501
Air Filter Set.....	A-5542-S	Hydraulic Oil Filter.....	HC-5504	Air Filter Secondary.....	A-5534
Air Filter Primary.....	A-5542	Oil Filter Full Flow.....	C-5102	Air Filter Secondary.....	A-5502
Cabin Air Filter.....	CA-55070	D3K XL (DOZERS) CAT C4.4		Fuel Filter.....	FC-5509
Hydraulic Oil Filter.....	H-5501	Fuel/Water Separator.....	SFC-55241	Fuel Filter.....	FC-5502
Hydraulic Oil Filter.....	H-55270	Fuel/Water Separator.....	SFC-55240	Hydraulic Oil Filter.....	H-5503
D3G (DOZERS) CAT (S/N: 5XK1-UP)		D400 (ARTICULATED TRUCKS) CAT 3406B (S/N: 1MD1-246) , 2005-UP		Hydraulic Oil Filter.....	H-5504
Fuel Filter.....	FC-1010	Air Filter Primary.....	A-5501	Hydraulic Oil Filter.....	H-5504
Fuel Filter.....	FC-5516	Air Filter Secondary.....	A-5502	Hydraulic Oil Filter.....	H-55270
Fuel Filter Secondary.....	FC-55151	Fuel Filter.....	F-5505	Hydraulic Oil Filter.....	H-5503
Fuel Filter Secondary.....	FC-5515	Fuel Filter.....	FC-5509	Hydraulic Oil Filter.....	H-55280
Oil Filter Full Flow.....	C-5504	Hydraulic Oil Filter.....	H-5504	Hydraulic Oil Filter.....	H-5504
D3G (DOZERS) CAT (S/N: MHK1-UP)		Hydraulic Oil Filter.....	H-5503	Hydraulic Oil Filter.....	H-5526
Fuel Filter.....	FC-5516	Oil Filter Full Flow.....	C-5516	Oil Filter Full Flow.....	C-5516
Fuel Filter Secondary.....	FC-5515	D400 (ARTICULATED TRUCKS) CAT 3406 (S/N: 1MD-UP)		D400 (ARTICULATED TRUCKS) CAT 3406TA	
Fuel Filter Secondary.....	FC-55151	Air Filter Primary.....	A-5501	Air Filter Set.....	A-44150-S
Oil Filter Full Flow.....	C-5504	Air Filter Secondary.....	A-5534	Air Filter Primary.....	A-44150
D3G (DOZERS) CAT 3046		Air Filter Secondary.....	A-5502	D400 (ARTICULATED TRUCKS) S/N: 1MD1-246	
Air Filter Secondary.....	A-4402	Air Filter Primary.....	A-5535	Air Filter Primary.....	A-5501
Oil Filter Full Flow.....	C-6218	Air Filter Set.....	A-5573-S	Air Filter Secondary.....	A-5502
D3G (DOZERS) S/N: BYR1-UP		Fuel Filter.....	FC-5509	Fuel Filter.....	FC-5509
Hydraulic Oil Filter.....	HC-5507	Fuel Filter.....	FC-5502	Hydraulic Oil Filter.....	H-55270
Hydraulic Oil Filter.....	HC-5504	Hydraulic Oil Filter.....	H-5503	Hydraulic Oil Filter.....	H-5503
D3G (DOZERS) S/N: CFC1-UP		Hydraulic Oil Filter.....	H-55270	Hydraulic Oil Filter.....	H-5504
Hydraulic Oil Filter.....	HC-5507	Hydraulic Oil Filter.....	H-5504	Hydraulic Oil Filter.....	H-5503
Hydraulic Oil Filter.....	HC-55220	D400 (ARTICULATED TRUCKS) CAT 3406 (S/N: 2JJ-UP)		Oil Filter Full Flow.....	C-5516
		Air Filter Secondary.....	A-5502	D400D (ARTICULATED TRUCKS) CAT 3406 (S/N: 8TF1-UP) , 2005-UP	
				Air Filter Secondary.....	A-5502
				Air Filter Primary.....	A-5501
				Coolant Filter.....	WC-6901
				Fuel Filter.....	FC-5509
				Hydraulic Oil Filter.....	H-5504
				Hydraulic Oil Filter.....	H-5503
				Oil Filter Full Flow.....	C-5516

MODEL/APPLICATION	SAKURA NO
CATERPILLAR	
D400D (ARTICULATED TRUCKS) S/N: 8TF1-UP	
Air Filter Secondary.....	A-5534
Air Filter Primary.....	A-5535
Air Filter Set.....	A-5573-S
Air Filter Primary.....	A-5501
Fuel Filter.....	FC-5509
Fuel Filter.....	FC-5519
Hydraulic Oil Filter.....	H-5503
Hydraulic Oil Filter.....	H-5504
Oil Filter Full Flow.....	C-5516
D400E (ARTICULATED TRUCKS) CAT 3406 (S/N: 2YR1-UP) , 2005-UP	
Air Filter Set.....	A-5573-S
Air Filter Secondary.....	A-5534
Air Filter Primary.....	A-5535
Fuel Filter.....	F-5505
Fuel Filter.....	FC-5509
Hydraulic Oil Filter.....	H-5504
Hydraulic Oil Filter.....	H-5503
Oil Filter Full Flow.....	C-5516
D400E (ARTICULATED TRUCKS) CAT 3406 (S/N: 8PS1-UP) , 2005-UP	
Air Filter.....	AH-7001
Air Filter Set.....	A-44240-S
Air Filter Secondary.....	A-44230
Air Filter Primary.....	A-44220
Fuel Filter.....	FC-5509
Fuel/Water Separator Secondary..	SFC-5504-10
Fuel/Water Separator Secondary..	SFC-5504-10B
Hydraulic Oil Filter.....	H-5526
Hydraulic Oil Filter.....	H-5504
Oil Filter Full Flow.....	C-5516
D400E (ARTICULATED TRUCKS) CAT 3406 (S/N: APF00274-UP) , 2005-UP	
Air Filter Secondary.....	A-44230
Air Filter Set.....	A-44240-S
Air Filter Primary.....	A-44220
Air Filter.....	AH-7001
Fuel Filter.....	FC-5509
Fuel/Water Separator Secondary..	SFC-5504-10B
Fuel/Water Separator Secondary..	SFC-5504-10
Hydraulic Oil Filter.....	H-5526
Hydraulic Oil Filter.....	H-5504
Oil Filter Full Flow.....	C-5516
D400E (ARTICULATED TRUCKS) CAT 3406E (S/N: APF-UP)	
Air Filter Secondary.....	A-44230
Air Filter Primary.....	A-44220
Air Filter Set.....	A-44240-S
Fuel Filter.....	FC-5509
Fuel/Water Separator Secondary..	SFC-5504-10
Fuel/Water Separator Secondary..	SFC-5504-10B
Hydraulic Oil Filter.....	H-5504
Hydraulic Oil Filter.....	H-55270
Oil Filter Full Flow.....	C-5516
D400E (ARTICULATED TRUCKS) S/N: 2YR1-UP	

MODEL/APPLICATION	SAKURA NO
CATERPILLAR	
Air Filter Primary.....	A-5535
Air Filter Set.....	A-5573-S
Air Filter Secondary.....	A-5534
Fuel Filter.....	FC-5509
Hydraulic Oil Filter.....	H-5526
Hydraulic Oil Filter.....	H-55270
Hydraulic Oil Filter.....	H-55280
Hydraulic Oil Filter.....	H-5503
Hydraulic Oil Filter.....	H-5504
Oil Filter Full Flow.....	C-5516
D400E (ARTICULATED TRUCKS) w/3406 Eng.	
Air Filter Primary.....	A-5535M
Air Filter Set.....	A-5573M-S
D400E II (ARTICULATED TRUCKS) CAT 3406B (S/N: 8PS1-UP) , 2005-UP	
Air Filter Set.....	A-44240-S
Air Filter Secondary.....	A-44230
Air Filter Primary.....	A-44220
Fuel Filter.....	FC-5509
Fuel/Water Separator Secondary..	SFC-5504-10
Fuel/Water Separator Secondary..	SFC-5504-10B
Hydraulic Oil Filter.....	H-5526
Hydraulic Oil Filter.....	H-5504
Oil Filter Full Flow.....	C-5516
D40D (ARTICULATED TRUCKS) CAT 3406 (S/N: 2JJ1-UP) , 2005-UP	
Air Filter Secondary.....	A-5502
Air Filter Primary.....	A-5501
Fuel Filter.....	FC-5509
Fuel Filter.....	F-5505
Hydraulic Oil Filter.....	H-5504
Hydraulic Oil Filter.....	H-5503
Oil Filter Full Flow.....	C-5516
D40D (ARTICULATED TRUCKS) CAT 3406 (S/N: 8TF1-UP) , 2005-UP	
Air Filter Primary.....	A-5501
Air Filter Secondary.....	A-5502
Fuel Filter.....	F-5505
Fuel Filter.....	FC-5509
Hydraulic Oil Filter.....	H-5504
Hydraulic Oil Filter.....	H-5503
Oil Filter Full Flow.....	C-5516
D40D (ARTICULATED TRUCKS) S/N: 1TF-UP	
Air Filter Primary.....	A-5521
Air Filter Set.....	A-5521-S
Fuel Filter.....	FC-5509
Fuel Filter.....	FC-5502
Fuel Filter.....	F-5505
Hydraulic Oil Filter.....	H-5503
Hydraulic Oil Filter.....	H-5504
D40D (ARTICULATED TRUCKS) S/N: 2JJ-UP	
Air Filter Set.....	A-5521-S
Air Filter Primary.....	A-5521
Fuel Filter.....	FC-5502
Fuel Filter.....	FC-5509
Fuel Filter.....	F-5505

MODEL/APPLICATION	SAKURA NO
CATERPILLAR	
Hydraulic Oil Filter.....	H-5504
Hydraulic Oil Filter.....	H-5503
D4 (DOZERS) Excluding S/N: 82J3256	
Air Filter Primary.....	A-5566
Air Filter Set.....	A-5507-S
Air Filter Set.....	A-5568-S
Air Filter Set.....	A-55071-S
Air Filter Secondary.....	A-5567
Air Filter Primary.....	A-5507
Air Filter Secondary.....	A-5508
Hydraulic Oil Filter.....	H-5504
Oil Filter Full Flow.....	O-5502
D4 (DOZERS) S/N: 6U1-UP	
Oil Filter Full Flow.....	O-5501
D4 (DOZERS) S/N: 7U1-UP	
Oil Filter Full Flow.....	O-5501
D4 (DOZERS) S/N: 82J1-3259	
Air Filter Primary.....	A-5507
Air Filter Set.....	A-5568-S
Air Filter Secondary.....	A-5567
Air Filter Set.....	A-5507-S
Air Filter Set.....	A-55071-S
Air Filter Primary.....	A-5566
Air Filter Secondary.....	A-5508
Hydraulic Oil Filter.....	H-5504
Oil Filter Full Flow.....	O-5502
D4 (DOZERS) S/N: 82J1811-UP	
Air Filter Set.....	A-55071-S
Air Filter Set.....	A-5507-S
Air Filter Primary.....	A-5507
Air Filter Set.....	A-5568-S
Air Filter Secondary.....	A-5508
Air Filter Primary.....	A-5566
Air Filter Secondary.....	A-5567
Hydraulic Oil Filter.....	H-5504
Oil Filter Full Flow.....	C-5510
D4 (DOZERS) S/N: 82J3256-UP	
Air Filter Set.....	A-55071-S
Air Filter Secondary.....	A-5508
Air Filter Set.....	A-5507-S
Air Filter Set.....	A-5568-S
Air Filter Primary.....	A-5507
Air Filter Primary.....	A-5566
Air Filter Secondary.....	A-5567
Hydraulic Oil Filter.....	H-5504
Oil Filter Full Flow.....	C-5510
D4 (DOZERS) S/N: 82J3260-UP	
Air Filter Primary.....	A-5566
Air Filter Set.....	A-5507-S
Air Filter Set.....	A-5568-S
Air Filter Primary.....	A-5507

MODEL/APPLICATION	SAKURA NO
CATERPILLAR	
D4 (DOZERS) S/N: 82J3260-UP	
Air Filter Secondary.....	A-5508
Air Filter Set.....	A-55071-S
Air Filter Secondary.....	A-5567
Hydraulic Oil Filter.....	H-5504
Oil Filter Full Flow.....	C-5510
D4 (DOZERS) S/N: 83J1-1810	
Air Filter Primary.....	A-5566
Air Filter Set.....	A-5568-S
Air Filter Set.....	A-5507-S
Air Filter Secondary.....	A-5508
Air Filter Set.....	A-55071-S
Air Filter Primary.....	A-5507
Air Filter Secondary.....	A-5567
Hydraulic Oil Filter.....	H-5504
Oil Filter Full Flow.....	O-5502
D4 (DOZERS) S/N: 84J1-1389	
Air Filter Primary.....	A-5566
Air Filter Set.....	A-5568-S
Air Filter Set.....	A-5507-S
Air Filter Set.....	A-55071-S
Air Filter Primary.....	A-5507
Air Filter Secondary.....	A-5567
Air Filter Secondary.....	A-5508
Hydraulic Oil Filter.....	H-5504
Oil Filter Full Flow.....	O-5502
D4 (DOZERS) S/N: 84J1390-UP	
Air Filter Set.....	A-55071-S
Air Filter Set.....	A-5507-S
Air Filter Secondary.....	A-5567
Air Filter Primary.....	A-5507
Air Filter Primary.....	A-5566
Air Filter Secondary.....	A-5508
Air Filter Set.....	A-5568-S
Hydraulic Oil Filter.....	H-5504
Oil Filter Full Flow.....	C-5510
D400 SERIES II (ARTICULATED TRUCKS) S/N: 2YR-UP	
Air Filter Secondary.....	A-5534
Air Filter Set.....	A-5573-S
Air Filter Primary.....	A-5535
Fuel Filter.....	FC-5519
Fuel Filter.....	FC-5509
Hydraulic Oil Filter.....	H-5504
Hydraulic Oil Filter.....	H-5503
Hydraulic Oil Filter.....	H-55270
D400 SERIES II (ARTICULATED TRUCKS) S/N: 8PS-UP	
Air Filter Primary.....	A-5535
Air Filter Set.....	A-5573-S
Air Filter Secondary.....	A-5534
Fuel Filter.....	FC-5519
Fuel Filter.....	FC-5509
Hydraulic Oil Filter.....	H-5503

MODEL/APPLICATION	SAKURA NO
CATERPILLAR	
Hydraulic Oil Filter.....	H-5504
Hydraulic Oil Filter.....	H-55270
D400E SERIES II (ARTICULATED TRUCKS) CAT 3406E (S/N: 8PS1-UP)	
Air Filter Primary.....	A-44220
Air Filter Secondary.....	A-44230
Air Filter Set.....	A-44240-S
Fuel Filter.....	FC-5509
Fuel/Water Separator Secondary..	SFC-5504-10
Fuel/Water Separator Secondary..	SFC-5504-10B
Hydraulic Oil Filter.....	H-5526
Hydraulic Oil Filter.....	H-5504
Hydraulic Oil Filter.....	H-55270
Oil Filter Full Flow.....	C-5516
D44 (ARTICULATED TRUCKS) S/N: 2LD1-UP	
Air Filter Set.....	A-5555-S
Air Filter Secondary.....	A-5529
Air Filter Primary.....	A-5555
Air Filter Set.....	A-5521-S
Air Filter Secondary.....	A-5556
Air Filter Primary.....	A-5521
Fuel Filter.....	FC-5519
Hydraulic Oil Filter.....	H-5503
Oil Filter Full Flow.....	C-5516
D44B (ARTICULATED TRUCKS) CAT 3408 (S/N: 8SD1-UP) , 2005-UP	
Air Filter Set.....	A-5521-S
Air Filter Secondary.....	A-5529
Air Filter Primary.....	A-5521
Fuel Filter.....	F-5505
Hydraulic Oil Filter.....	H-5503
Hydraulic Oil Filter.....	H-5504
Oil Filter Full Flow.....	C-5516
D44B (ARTICULATED TRUCKS) S/N: 8SD1-UP	
Air Filter Set.....	A-5521-S
Air Filter Secondary.....	A-5529
Air Filter Primary.....	A-5521
Hydraulic Oil Filter.....	H-55270
Hydraulic Oil Filter.....	H-5503
Hydraulic Oil Filter.....	H-5504
Hydraulic Oil Filter.....	H-5526
Hydraulic Oil Filter.....	H-55280
Oil Filter Full Flow.....	C-5516
D4B (DOZERS)	
Air Filter Secondary.....	A-5590
Hydraulic Oil Filter.....	H-55320
D4B (DOZERS) S/N: 1SG1-UP	
Air Filter Secondary.....	A-5525
Air Filter Primary.....	A-5542
Air Filter Set.....	A-5542-S
Fuel Filter.....	FC-5503
Hydraulic Oil Filter.....	H-55270
Hydraulic Oil Filter.....	H-5504
Oil Filter Full Flow.....	C-5519

MODEL/APPLICATION	SAKURA NO
CATERPILLAR	
D4B (DOZERS) S/N: 2XF1-UP	
Air Filter Primary.....	A-5542
Air Filter Set.....	A-5542-S
Air Filter Secondary.....	A-5525
Fuel Filter.....	FC-5503
Hydraulic Oil Filter.....	H-55270
Hydraulic Oil Filter.....	H-5504
Oil Filter Full Flow.....	C-5519
D4C (DOZERS) CAT (S/N: 45V69350-84090)	
Fuel Filter.....	FC-5501
Fuel Filter.....	FC-5523
Oil Filter Full Flow.....	C-5519
D4C (DOZERS) CAT (S/N: 45V84091-UP)	
Fuel Filter.....	FC-5523
Fuel Filter.....	FC-5501
Oil Filter Full Flow.....	C-5519
D4C (DOZERS) S/N: 1FW1-UP	
Air Filter Secondary.....	A-5525
Air Filter Primary.....	A-5542
Air Filter Set.....	A-5542-S
Fuel Filter.....	FC-5509
Hydraulic Oil Filter.....	H-5504
Hydraulic Oil Filter.....	H-55270
Oil Filter Full Flow.....	C-5504
D4C (DOZERS) S/N: 24A1-UP	
Oil Filter Full Flow.....	C-5519
D4C (DOZERS) S/N: 39A1-UP	
Air Filter Set.....	A-5511-S
Air Filter Primary.....	A-5511
Air Filter Secondary.....	A-5512
Fuel Filter.....	F-5501
Oil Filter Full Flow.....	C-5519
D4C (DOZERS) S/N: 40A1-UP	
Air Filter Secondary.....	A-5512
Air Filter Set.....	A-5511-S
Air Filter Primary.....	A-5511
Fuel Filter.....	F-5501
Oil Filter Full Flow.....	C-5519
D4C (DOZERS) S/N: 4LS1-UP	
Air Filter Primary.....	A-5542
Air Filter Set.....	A-5542-S
Air Filter Secondary.....	A-5525
Hydraulic Oil Filter.....	HC-5504
Oil Filter Full Flow.....	C-5504
D4C (DOZERS) S/N: 54A1-UP	
Oil Filter Full Flow.....	C-5519
D4C (DOZERS) S/N: 55A1-UP	

Sakura Filter

ENGINE APPLICATION

MODEL/APPLICATION	SAKURA NO	MODEL/APPLICATION	SAKURA NO	MODEL/APPLICATION	SAKURA NO
CATERPILLAR		CATERPILLAR		CATERPILLAR	
D4C (DOZERS) S/N: 55A1-UP		D4C LGP XL SERIES III (DOZERS) S/N: 8CS1-UP		Air Filter Secondary.....	A-5525
Oil Filter Full Flow.....	C-5519	Air Filter Secondary.....	A-5525	Air Filter Set.....	A-5542-S
D4C (DOZERS) S/N: 69A1-UP		Air Filter Set.....	A-5542-S	Cabin Air Filter.....	CA-55070
Oil Filter Full Flow.....	C-5519	Air Filter Primary.....	A-5542	Hydraulic Oil Filter.....	HC-5504
D4C (DOZERS) S/N: 6BS1-UP		Hydraulic Oil Filter.....	HC-5504		
Air Filter Secondary.....	A-5525	Oil Filter Full Flow.....	C-5504	D4C XL Series III (DOZERS) w/3046 Eng.	
Air Filter Primary.....	A-5542			Air Filter Secondary.....	A-5590
Air Filter Set.....	A-5542-S	D4C SERIES II (DOZERS) CAT (S/N: 45V90750-UP)			
Hydraulic Oil Filter.....	HC-5504	Fuel Filter.....	FC-5501		
Oil Filter Full Flow.....	C-5504	Fuel Filter.....	FC-5523		
D4C (DOZERS) S/N: 6YL1-UP		Oil Filter Full Flow.....	C-5519		
Air Filter Secondary.....	A-5525	D4C SERIES II (DOZERS) CAT (S/N: 7YJ1-2721)			
Air Filter Set.....	A-5542-S	Fuel Filter.....	FC-5501		
Air Filter Primary.....	A-5542	Fuel Filter.....	FC-5523		
Hydraulic Oil Filter.....	H-55270	Fuel Filter Secondary.....	FC-5507		
Hydraulic Oil Filter.....	H-5504	Oil Filter Full Flow.....	C-5505		
Oil Filter Full Flow.....	C-5504	Oil Filter Full Flow.....	C-5519		
D4C (DOZERS) S/N: 7SL1-UP		D4C SERIES II (DOZERS) CAT (S/N: 7YJ2722-UP)			
Air Filter Secondary.....	A-5525	Fuel Filter.....	FC-5523		
Air Filter Primary.....	A-5542	Fuel Filter.....	FC-5501		
Air Filter Set.....	A-5542-S	Fuel Filter Secondary.....	FC-5507		
Hydraulic Oil Filter.....	H-5504	Oil Filter Full Flow.....	C-5505		
Oil Filter Full Flow.....	C-5519	Oil Filter Full Flow.....	C-5519		
D4C (DOZERS) S/N: 8CS1-UP		D4C SERIES III (DOZERS) CAT (S/N: 5XK1-UP)			
Air Filter Secondary.....	A-5525	Fuel Filter.....	FC-5523		
Air Filter Primary.....	A-5542	Fuel Filter.....	FC-5501		
Air Filter Set.....	A-5542-S	Fuel Filter Secondary.....	FC-5507		
Hydraulic Oil Filter.....	H-5504	Oil Filter Full Flow.....	C-5505		
Oil Filter Full Flow.....	C-5519	Oil Filter Full Flow.....	C-5519		
D4C (DOZERS) S/N: 8CS1-UP		D4C SERIES III (DOZERS) CAT (S/N: 5XK1-UP)			
Air Filter Secondary.....	A-5525	Fuel Filter Secondary.....	FC-55151		
Air Filter Primary.....	A-5542	Fuel Filter Secondary.....	FC-5515		
Air Filter Set.....	A-5542-S	Fuel Filter.....	FC-5516		
Hydraulic Oil Filter.....	HC-5504	Fuel Filter.....	FC-1010		
Oil Filter Full Flow.....	C-5504	Oil Filter Full Flow.....	C-5504		
D4C (DOZERS) S/N: 8EL1-UP		D4C SERIES III (DOZERS) S/N: 6BS1-320			
Oil Filter Full Flow.....	C-5519	Air Filter Secondary.....	A-5525		
D4C (DOZERS) w/3046 Eng.		Air Filter Primary.....	A-5542		
Air Filter Secondary.....	A-5590	Air Filter Set.....	A-5542-S		
D4C LGP XL SERIES III (DOZERS) S/N: 4LS1-UP		Cabin Air Filter.....	CA-55070		
Air Filter Secondary.....	A-5525	Hydraulic Oil Filter.....	HC-5504		
Air Filter Set.....	A-5542-S	D4C SERIES III (DOZERS) S/N: 6BS321-UP			
Air Filter Primary.....	A-5542	Air Filter Secondary.....	A-5525		
Hydraulic Oil Filter.....	HC-5504	Air Filter Set.....	A-5542-S		
Oil Filter Full Flow.....	C-5504	Air Filter Primary.....	A-5542		
D4C LGP XL SERIES III (DOZERS) S/N: 6BS1-UP		Cabin Air Filter.....	CA-55070		
Air Filter Primary.....	A-5542	Hydraulic Oil Filter.....	HC-5504		
Air Filter Set.....	A-5542-S	D4C SERIES III (DOZERS) S/N: 8CS1-373			
Air Filter Secondary.....	A-5525	Air Filter Secondary.....	A-5525		
Hydraulic Oil Filter.....	HC-5504	Air Filter Set.....	A-5542-S		
Oil Filter Full Flow.....	C-5504	Air Filter Primary.....	A-5542		
D4C SERIES III (DOZERS) S/N: 8CS374-UP		Hydraulic Oil Filter.....	HC-5504		
Air Filter Primary.....	A-5542	D4C SERIES III (DOZERS) S/N: 8CS374-UP			
		Air Filter Secondary.....	A-5525		
		Air Filter Set.....	A-5542-S		
		Cabin Air Filter.....	CA-55070		
		Hydraulic Oil Filter.....	HC-5504		
		D4C SERIES III (DOZERS) S/N: 82J1-3443			
		Air Filter Secondary.....	A-5508		
		Air Filter Set.....	A-5568-S		
		Air Filter Secondary.....	A-5567		
		Air Filter Primary.....	A-5566		
		Air Filter Set.....	A-5507-S		
		Air Filter Primary.....	A-5507		
		Air Filter Set.....	A-55071-S		

Sakura Filter

ENGINE APPLICATION

MODEL/APPLICATION	SAKURA NO	MODEL/APPLICATION	SAKURA NO	MODEL/APPLICATION	SAKURA NO
CATERPILLAR		CATERPILLAR		CATERPILLAR	
D4D (DOZERS) S/N: 82J1-3443 Fuel Filter Secondary..... FC-5507 Hydraulic Oil Filter..... H-5504		Air Filter Set..... A-55071-S Air Filter Secondary..... A-5508 Air Filter Set..... A-5568-S Air Filter Primary..... A-5507 Air Filter Secondary..... A-5567 Air Filter Primary..... A-5566 Fuel Filter Secondary..... FC-5507 Oil Filter Full Flow..... C-5510		Fuel Filter..... FC-5523 Oil Filter Full Flow..... C-5510 Oil Filter Full Flow..... C-5522	
D4D (DOZERS) S/N: 82J3260-UP Air Filter Secondary..... A-5567 Air Filter Primary..... A-5507 Air Filter Primary..... A-5566 Air Filter Set..... A-5568-S Air Filter Secondary..... A-5508 Air Filter Set..... A-55071-S Air Filter Set..... A-5507-S		D4E (DOZERS) CAT 3304 Air Filter Primary..... A-44180 Air Filter Set..... A-44180-S		D4E (DOZERS) CAT (S/N: 4YD1256-UP) Fuel Filter..... FC-5501 Fuel Filter..... FC-5523 Oil Filter Full Flow..... C-5522	
D4D (DOZERS) S/N: 82J3444-4150 Air Filter Primary..... A-5507 Air Filter Set..... A-5507-S Air Filter Set..... A-5568-S Air Filter Secondary..... A-5567 Air Filter Primary..... A-5566 Air Filter Secondary..... A-5508 Air Filter Set..... A-55071-S		D4E (DOZERS) CAT (S/N: 07Z1004-5174) Fuel Filter Secondary..... FC-5507 Oil Filter Full Flow..... C-5522 Oil Filter Full Flow..... C-5510		D4E (DOZERS) CAT (S/N: 59Z1024-1385) Fuel Filter..... FC-5523 Fuel Filter..... FC-5501 Oil Filter Full Flow..... C-5510	
D4D (DOZERS) S/N: 82J4151-UP Air Filter Secondary..... A-5567 Air Filter Primary..... A-5507 Air Filter Set..... A-5507-S Air Filter Primary..... A-5566 Air Filter Set..... A-5568-S Air Filter Secondary..... A-5508 Air Filter Set..... A-55071-S Fuel Filter Secondary..... FC-5507 Hydraulic Oil Filter..... H-5504 Oil Filter Full Flow..... C-5510		D4E (DOZERS) CAT (S/N: 07Z5175-7053) Fuel Filter Secondary..... FC-5507 Oil Filter Full Flow..... C-5510 Oil Filter Full Flow..... C-5522		D4E (DOZERS) CAT (S/N: 59Z1-1023) Fuel Filter..... FC-5501 Fuel Filter..... FC-5523 Oil Filter Full Flow..... C-5510	
D4D (DOZERS) S/N: 83J1-1810 Air Filter Set..... A-5568-S Air Filter Secondary..... A-5508 Air Filter Set..... A-5507-S Air Filter Primary..... A-5507 Air Filter Primary..... A-5566 Air Filter Set..... A-55071-S Fuel Filter Secondary..... FC-5507 Hydraulic Oil Filter..... H-5504 Oil Filter Full Flow..... C-5510		D4E (DOZERS) CAT (S/N: 07Z7054-32316) Fuel Filter Secondary..... FC-5507 Oil Filter Full Flow..... C-5510 Oil Filter Full Flow..... C-5522		D4E (DOZERS) CAT (S/N: 59Z1386-UP) Fuel Filter..... FC-5501 Fuel Filter..... FC-5523 Oil Filter Full Flow..... C-5510	
D4D (DOZERS) S/N: 84J1-1389 Air Filter Primary..... A-5507 Air Filter Set..... A-5507-S Air Filter Set..... A-5568-S Air Filter Secondary..... A-5567 Air Filter Set..... A-55071-S Air Filter Primary..... A-5566 Air Filter Secondary..... A-5508 Fuel Filter Secondary..... FC-5507		D4E (DOZERS) CAT (S/N: 12Z1-11157) Air Filter Primary..... A-5509 Air Filter Set..... A-5522-S Air Filter Secondary..... A-5522 Fuel Filter Secondary..... FC-5507 Oil Filter Full Flow..... C-5522 Oil Filter Full Flow..... C-5510		D4E (DOZERS) CAT (S/N: 9C81-141) Fuel Filter Secondary..... FC-5507 Oil Filter Full Flow..... C-5522 Oil Filter Full Flow..... C-5510	
D4D (DOZERS) S/N: 84J1390-UP Air Filter Set..... A-5507-S		D4E (DOZERS) CAT (S/N: 46V1-9499) Oil Filter Full Flow..... C-5510		D4E (DOZERS) CAT S/N: 07Z238-1003 Fuel Filter Secondary..... FC-5507	
		D4E (DOZERS) CAT (S/N: 12Z11158-UP) Air Filter Primary..... A-5509 Air Filter Secondary..... A-5522 Air Filter Set..... A-5522-S Fuel Filter Secondary..... FC-5507 Oil Filter Full Flow..... C-5522		D4E (DOZERS) CAT S/N: 07Z32317-UP Fuel Filter Secondary..... FC-5507 Oil Filter Full Flow..... C-5522 Oil Filter Full Flow..... C-5510	
		D4E (DOZERS) CAT (S/N: 46V9500-UP) Oil Filter Full Flow..... C-5510		D4E (DOZERS) CAT S/N: 78P34523-46310 Fuel Filter Secondary..... FC-5507	
		D4E (DOZERS) CAT (S/N: 4YD1-1227) Fuel Filter..... FC-5501 Fuel Filter..... FC-5523 Oil Filter Full Flow..... C-5522 Oil Filter Full Flow..... C-5510		D4E (DOZERS) CAT S/N: 9CB683-UP Fuel Filter Secondary..... FC-5507 Oil Filter Full Flow..... C-5522 Oil Filter Full Flow..... C-5510	
		D4E (DOZERS) CAT (S/N: 4YD1228-1255) Fuel Filter..... FC-5501		D4E (DOZERS) S/N: 27X1-UP Air Filter Primary..... A-5507 Air Filter Secondary..... A-5508	

Sakura Filter

ENGINE APPLICATION

MODEL/APPLICATION	SAKURA NO	MODEL/APPLICATION	SAKURA NO	MODEL/APPLICATION	SAKURA NO
CATERPILLAR		CATERPILLAR		CATERPILLAR	
D4E (DOZERS) S/N: 27X1-UP Air Filter Set..... A-55071-S Air Filter Primary..... A-5566 Air Filter Secondary..... A-5567 Air Filter Set..... A-5507-S Air Filter Set..... A-5568-S Fuel Filter Secondary..... FC-5507 Hydraulic Oil Filter..... H-5504 Oil Filter Full Flow..... C-5510		Air Filter Set..... A-5522-S Air Filter Set..... A-5507-S Air Filter..... A-5530 Fuel Filter Secondary..... FC-5507 Fuel Filter..... F-5505 Hydraulic Oil Filter..... H-55270 Hydraulic Oil Filter..... H-5504 Oil Filter Full Flow..... C-5510		Air Filter Set..... A-5507-S Air Filter Set..... A-55071-S Air Filter Secondary..... A-5508 Air Filter Primary..... A-5507 Fuel Filter..... F-5505 Fuel Filter Secondary..... FC-5507 Hydraulic Oil Filter..... H-55270 Hydraulic Oil Filter..... H-5504 Oil Filter Full Flow..... C-5510	
D4E (DOZERS) S/N: 28X1-1726 Air Filter Secondary..... A-5567 Air Filter Set..... A-5568-S Air Filter Secondary..... A-5508 Air Filter Set..... A-55071-S Air Filter Primary..... A-5507 Air Filter Set..... A-5507-S Air Filter Primary..... A-5566 Fuel Filter Secondary..... FC-5507 Hydraulic Oil Filter..... H-5504 Oil Filter Full Flow..... C-5510		D4E (DOZERS) S/N: 2CB382-UP Air Filter..... A-5530 Air Filter Set..... A-5507-S Air Filter Primary..... A-5507 Air Filter Set..... A-55071-S Hydraulic Oil Filter..... H-5504		D4E (DOZERS) S/N: 31C314-UP Air Filter Set..... A-5507-S Air Filter Primary..... A-5507 Air Filter Secondary..... A-5508 Air Filter Set..... A-55071-S Hydraulic Oil Filter..... H-5504 Hydraulic Oil Filter..... H-55270	
D4E (DOZERS) S/N: 28X1727-UP Air Filter Secondary..... A-5567 Air Filter Set..... A-5568-S Air Filter Secondary..... A-5508 Air Filter Primary..... A-5507 Air Filter Primary..... A-5566 Air Filter Set..... A-5507-S Air Filter Set..... A-55071-S Fuel Filter Secondary..... FC-5507 Hydraulic Oil Filter..... H-5504 Oil Filter Full Flow..... C-5510		D4E (DOZERS) S/N: 2D11766-1831 Air Filter..... A-5530 Air Filter Primary..... A-5507 Air Filter Set..... A-55071-S Air Filter Set..... A-5507-S Hydraulic Oil Filter..... HC-5506 Hydraulic Oil Filter..... H-5504 Hydraulic Oil Filter..... HC-5503 Hydraulic Oil Filter..... HC-5512		D4E (DOZERS) S/N: 34C100-UP Air Filter Secondary..... A-5508 Air Filter Set..... A-5507-S Air Filter Primary..... A-5507 Air Filter Set..... A-55071-S Fuel Filter Secondary..... FC-5507 Hydraulic Oil Filter..... H-5504 Hydraulic Oil Filter..... H-55270 Oil Filter Full Flow..... C-5510	
D4E (DOZERS) S/N: 28X1-UP Hydraulic Oil Filter..... H-5504 Hydraulic Oil Filter..... H-55270		D4E (DOZERS) S/N: 2DJ1-828 Air Filter Set..... A-5507-S Air Filter Primary..... A-5507 Air Filter..... A-5530 Air Filter Set..... A-55071-S Hydraulic Oil Filter..... H-5504		D4E (DOZERS) S/N: 50X754-UP Air Filter Set..... A-5507-S Air Filter Primary..... A-5507 Air Filter Set..... A-55071-S Air Filter Secondary..... A-5508 Fuel Filter Secondary..... FC-5507 Hydraulic Oil Filter..... H-5504 Oil Filter Full Flow..... C-5510	
D4E (DOZERS) S/N: 29X1-UP Air Filter Primary..... A-5507 Air Filter Set..... A-55071-S Air Filter Set..... A-5507-S Air Filter Secondary..... A-5508 Air Filter Set..... A-5568-S Air Filter Primary..... A-5566 Air Filter Secondary..... A-5567 Fuel Filter Secondary..... FC-5507 Hydraulic Oil Filter..... H-5504 Oil Filter Full Flow..... C-5510		D4E (DOZERS) S/N: 2DJ1832-UP Air Filter Primary..... A-5566 Air Filter Secondary..... A-5567 Air Filter Set..... A-5568-S Hydraulic Oil Filter..... H-5504 Hydraulic Oil Filter..... HC-5512 Hydraulic Oil Filter..... HC-5503 Hydraulic Oil Filter..... HC-5506		D4E (DOZERS) S/N: 51X1-841 Air Filter Primary..... A-5507 Air Filter Set..... A-55071-S Air Filter Set..... A-5507-S Air Filter Secondary..... A-5508 Fuel Filter Secondary..... FC-5507 Hydraulic Oil Filter..... H-5504 Oil Filter Full Flow..... C-5510	
D4E (DOZERS) S/N: 2CB1-381 Hydraulic Oil Filter..... H-5504		D4E (DOZERS) S/N: 2D1829-1765 Air Filter Primary..... A-5507 Air Filter..... A-5530 Air Filter Set..... A-55071-S Air Filter Set..... A-5507-S Hydraulic Oil Filter..... H-5504		D4E (DOZERS) S/N: 51X842-UP Air Filter Primary..... A-5507 Air Filter Set..... A-5507-S Air Filter Set..... A-55071-S Air Filter Secondary..... A-5508 Fuel Filter Secondary..... FC-5507 Hydraulic Oil Filter..... H-5504 Hydraulic Oil Filter..... H-55270 Oil Filter Full Flow..... C-5510	
D4E (DOZERS) S/N: 2CB1-UP Air Filter Primary..... A-5509 Air Filter Set..... A-55071-S Air Filter Primary..... A-5507		D4E (DOZERS) S/N: 31C100-313 Air Filter Primary..... A-5507 Air Filter Set..... A-5507-S Air Filter Set..... A-55071-S Air Filter Secondary..... A-5508 Hydraulic Oil Filter..... H-55270 Hydraulic Oil Filter..... H-5504		D4E (DOZERS) S/N: 52X1-1162 Air Filter Primary..... A-5507 Air Filter Set..... A-55071-S	

MODEL/APPLICATION	SAKURA NO	MODEL/APPLICATION	SAKURA NO	MODEL/APPLICATION	SAKURA NO
CATERPILLAR		CATERPILLAR		CATERPILLAR	
D4E (DOZERS) S/N: 77W1-UP Air Filter Primary..... A-5507 Air Filter Set..... A-5507-S Air Filter Set..... A-5568-S Air Filter Primary..... A-5566 Air Filter Set..... A-55071-S Air Filter Secondary..... A-5508 Air Filter Secondary..... A-5567 Fuel Filter Secondary..... FC-5507 Hydraulic Oil Filter..... H-5504 Oil Filter Full Flow..... C-5510		D4G (DOZERS) S/N: CFN1-UP Hydraulic Oil Filter..... HC-55220 Hydraulic Oil Filter..... HC-5504 Hydraulic Oil Filter..... HC-5507 D4G (DOZERS) S/N: FDC1-UP Hydraulic Oil Filter..... HC-5507 Hydraulic Oil Filter..... HC-5504 Hydraulic Oil Filter..... HC-55220 D4G (DOZERS) S/N: HYD1-UP Hydraulic Oil Filter..... HC-55220 Hydraulic Oil Filter..... HC-5507 Hydraulic Oil Filter..... HC-5504		Air Filter Primary..... A-5507 Air Filter Set..... A-55071-S Hydraulic Oil Filter..... H-55270 D4H (DOZERS) S/N: 2AC1-3999 Air Filter..... A-5530 Air Filter Set..... A-5507-S Air Filter Primary..... A-5507 Air Filter Set..... A-55071-S Fuel Filter Secondary..... FC-5507 Hydraulic Oil Filter..... H-5504 Hydraulic Oil Filter..... H-55270 Oil Filter Full Flow..... C-5505 D4H (DOZERS) S/N: 2AC376-551 Air Filter..... A-5530 Air Filter Primary..... A-5507 Air Filter Set..... A-55071-S Air Filter Set..... A-5507-S Hydraulic Oil Filter..... H-55270 D4H (DOZERS) S/N: 2AC4000-UP Air Filter..... A-5530 Air Filter Primary..... A-5507 Air Filter Set..... A-55071-S Air Filter Set..... A-5507-S Fuel Filter Secondary..... FC-5507 Fuel Filter..... F-5505 Hydraulic Oil Filter..... H-5504 Hydraulic Oil Filter..... H-55270 Oil Filter Full Flow..... C-5505 D4H (DOZERS) S/N: 2AC5500-UP Hydraulic Oil Filter..... H-5504 Hydraulic Oil Filter..... H-55270	
D4E (DOZERS) S/N: 7PB1-649 Hydraulic Oil Filter..... H-5504		D4G (DOZERS) S/N: TLX1-UP Hydraulic Oil Filter..... HC-55220 Hydraulic Oil Filter..... HC-5504 Hydraulic Oil Filter..... HC-5507 D4 G XL (DOZERS) CAT 3046 T Air Filter Secondary..... A-4402 Oil Filter Full Flow..... C-6218 D4H (DOZERS) CAT (S/N: 45V47656-69452) Oil Filter Full Flow..... C-5505		Fuel Filter..... A-5530 Air Filter Primary..... A-5507 Air Filter Set..... A-55071-S Air Filter Set..... A-5507-S Fuel Filter Secondary..... FC-5507 Fuel Filter..... F-5505 Hydraulic Oil Filter..... H-5504 Hydraulic Oil Filter..... H-55270 Oil Filter Full Flow..... C-5505 D4H (DOZERS) S/N: 2AC552-5499 Air Filter Set..... A-5507-S Air Filter Set..... A-55071-S Air Filter..... A-5530 Air Filter Primary..... A-5507 Hydraulic Oil Filter..... H-55270 Hydraulic Oil Filter..... H-5504 D4H (DOZERS) S/N: 2CC1-UP Hydraulic Oil Filter..... H-5501 D4H (DOZERS) S/N: 3AC1-388 Air Filter Set..... A-55071-S Air Filter Set..... A-5507-S Air Filter Primary..... A-5507 Air Filter..... A-5530 Hydraulic Oil Filter..... H-55270 D4H (DOZERS) S/N: 3AC1-3999 Air Filter Set..... A-5507-S Air Filter Primary..... A-5507 Air Filter Secondary..... A-5567	
D4E (DOZERS) S/N: 7PB1-UP Air Filter Primary..... A-5507 Air Filter Set..... A-5522-S Air Filter Primary..... A-5509 Air Filter..... A-5530 Air Filter Set..... A-55071-S Air Filter Set..... A-5507-S Fuel Filter Secondary..... FC-5507 Fuel Filter..... F-5505 Hydraulic Oil Filter..... H-5504 Hydraulic Oil Filter..... H-55270 Oil Filter Full Flow..... C-5510		D4H (DOZERS) S/N: 45V69453-UP Fuel Filter..... FC-5501 Fuel Filter..... FC-5523 Oil Filter Full Flow..... C-5505 D4H (DOZERS) CAT (S/N: 7YJ1-3152) Fuel Filter..... FC-5501 Fuel Filter..... FC-5523 Fuel Filter Secondary..... FC-5507 Oil Filter Full Flow..... C-5519 Oil Filter Full Flow..... C-5505		Fuel Filter..... H-55320 D4E SR (DOZERS) w/3304 Eng. Hydraulic Oil Filter..... H-55320 D4G (DOZERS) CAT (S/N: 5XK30700-UP) Fuel Filter..... FC-5516 Fuel Filter Secondary..... FC-55151 Fuel Filter Secondary..... FC-5515 Oil Filter Full Flow..... C-5504	
D4E (DOZERS) w/3304 Eng. Hydraulic Oil Filter..... H-55320		D4H (DOZERS) CAT (S/N: 7YJ3153-UP) Fuel Filter..... FC-5501 Fuel Filter Secondary..... FC-5507 Fuel Filter..... FC-5523 Oil Filter Full Flow..... C-5519 Oil Filter Full Flow..... C-5505		Fuel Filter..... H-55320 D4H (DOZERS) CAT 3204 Cabin Air Filter..... CA-55140 D4H (DOZERS) S/N: 1WB1-UP Hydraulic Oil Filter..... H-5501 D4H (DOZERS) S/N: 2AC1-375 Air Filter Set..... A-5507-S Air Filter..... A-5530	
D4E (DOZERS) w/3304 Eng. Hydraulic Oil Filter..... H-55320		D4H (DOZERS) CAT (S/N: MHK1-UP) Fuel Filter..... FC-5516 Fuel Filter Secondary..... FC-55151 Fuel Filter Secondary..... FC-5515 Oil Filter Full Flow..... C-5504		Fuel Filter..... H-55320 D4H (DOZERS) S/N: 2AC1-375 Air Filter Set..... A-5507-S Air Filter..... A-5530	
D4G (DOZERS) CAT 3046 T Air Filter Secondary..... A-4402 Oil Filter Full Flow..... C-6218		D4H (DOZERS) CAT 3204 Cabin Air Filter..... CA-55140 D4H (DOZERS) S/N: 1WB1-UP Hydraulic Oil Filter..... H-5501 D4H (DOZERS) S/N: 2AC1-375 Air Filter Set..... A-5507-S Air Filter..... A-5530		Fuel Filter..... H-55320 D4H (DOZERS) S/N: 2AC1-375 Air Filter Set..... A-5507-S Air Filter..... A-5530	

MODEL/APPLICATION	SAKURA NO	MODEL/APPLICATION	SAKURA NO	MODEL/APPLICATION	SAKURA NO
CATERPILLAR		CATERPILLAR		CATERPILLAR	
D4H (DOZERS) S/N: 3AC1-3999 Air Filter Set..... A-55071-S Air Filter..... A-5530 Air Filter Primary..... A-5566 Air Filter Set..... A-5568-S Fuel Filter Secondary..... FC-5507 Hydraulic Oil Filter..... H-5504 Hydraulic Oil Filter..... H-55280 Oil Filter Full Flow..... C-5505		Air Filter Primary..... A-5507 Air Filter..... A-5530 Hydraulic Oil Filter..... H-55270 D4H (DOZERS) S/N: 8PB4000-UP Air Filter Set..... A-55071-S Air Filter Primary..... A-5507 Air Filter Set..... A-5507-S Air Filter..... A-5530 Fuel Filter Secondary..... FC-5507 Fuel Filter..... F-5505 Hydraulic Oil Filter..... H-55270 Hydraulic Oil Filter..... H-5504 Oil Filter Full Flow..... C-5505		D4H III (DOZERS) CAT 3204 Cabin Air Filter..... CA-55140 D4H LGP (DOZERS) CAT 3204 Cabin Air Filter..... CA-55140 D4H LGP (DOZERS) S/N: 2AC1-3999 Air Filter Set..... A-5507-S Air Filter Set..... A-55071-S Air Filter Primary..... A-5507 Air Filter..... A-5530 Fuel Filter Secondary..... FC-5507 Hydraulic Oil Filter..... H-55270 Hydraulic Oil Filter..... H-5504 Oil Filter Full Flow..... C-5505	
D4H (DOZERS) S/N: 3AC389-581 Air Filter Primary..... A-5507 Air Filter Set..... A-55071-S Air Filter Set..... A-5507-S Air Filter..... A-5530 Hydraulic Oil Filter..... H-55270		D4H (DOZERS) S/N: 9DB1-3999 Air Filter Primary..... A-5507 Air Filter Set..... A-5507-S Air Filter Set..... A-55071-S Air Filter..... A-5530 Fuel Filter Secondary..... FC-5507 Hydraulic Oil Filter..... H-55270 Hydraulic Oil Filter..... H-5504 Oil Filter Full Flow..... C-5505		D4H LGP (DOZERS) S/N: 2AC4000-UP Air Filter..... A-5530 Air Filter Primary..... A-5507 Air Filter Set..... A-5507-S Air Filter Set..... A-55071-S Fuel Filter Secondary..... FC-5507 Fuel Filter..... F-5505 Hydraulic Oil Filter..... H-55270 Hydraulic Oil Filter..... H-5504 Oil Filter Full Flow..... C-5505	
D4H (DOZERS) S/N: 3AC4000-UP Air Filter Set..... A-5507-S Air Filter Set..... A-55071-S Air Filter..... A-5530 Air Filter Primary..... A-5507 Fuel Filter Secondary..... FC-5507 Fuel Filter..... F-5505 Hydraulic Oil Filter..... H-55270 Hydraulic Oil Filter..... H-5504 Oil Filter Full Flow..... C-5505		D4H (DOZERS) S/N: 9DB1-UP Air Filter Set..... A-55071-S Air Filter Primary..... A-5507 Air Filter..... A-5530 Air Filter Set..... A-5507-S Hydraulic Oil Filter..... H-55270		D4H LGP (DOZERS) S/N: 3AC1-3999 Air Filter..... A-5530 Air Filter Primary..... A-5507 Air Filter Set..... A-55071-S Air Filter Set..... A-55071-S Fuel Filter Secondary..... FC-5507 Hydraulic Oil Filter..... H-5504 Hydraulic Oil Filter..... H-55270 Oil Filter Full Flow..... C-5505	
D4H (DOZERS) S/N: 3AC582-UP Air Filter Set..... A-5507-S Air Filter..... A-5530 Air Filter Set..... A-55071-S Air Filter Primary..... A-5507 Hydraulic Oil Filter..... H-55270 Hydraulic Oil Filter..... H-5504		D4H (DOZERS) S/N: 9DB4000-UP Air Filter..... A-5530 Air Filter Set..... A-5507-S Air Filter Primary..... A-5507 Air Filter Set..... A-55071-S Fuel Filter..... F-5505 Fuel Filter Secondary..... FC-5507 Hydraulic Oil Filter..... H-5504 Hydraulic Oil Filter..... H-55270 Oil Filter Full Flow..... C-5505		D4H LGP (DOZERS) S/N: 4NK1-4NK1 Air Filter Primary..... A-5566 Air Filter Set..... A-5568-S Air Filter Secondary..... A-5567	
D4H (DOZERS) S/N: 4NK1-UP Air Filter Set..... A-55071-S Air Filter Primary..... A-5507 Air Filter Set..... A-5507-S Air Filter..... A-5530 Hydraulic Oil Filter..... H-5504 Oil Filter Full Flow..... C-5505		D4H (DOZERS) S/N: 9FB1-UP Hydraulic Oil Filter..... H-5501		D4H LGP (DOZERS) S/N: 4NK1-UP Air Filter Primary..... A-5566 Air Filter Set..... A-5507-S Air Filter Set..... A-55071-S Air Filter..... A-5530 Air Filter Secondary..... A-5567 Air Filter Set..... A-5568-S Air Filter Primary..... A-5507 Fuel Filter Secondary..... FC-5507 Hydraulic Oil Filter..... H-5504 Hydraulic Oil Filter..... H-55270 Oil Filter Full Flow..... C-5510	
D4H (DOZERS) S/N: 8PB1-3999 Air Filter Set..... A-5507-S Air Filter..... A-5530 Air Filter Primary..... A-5507 Air Filter Set..... A-55071-S Fuel Filter Secondary..... FC-5507 Hydraulic Oil Filter..... H-5504 Hydraulic Oil Filter..... H-55270 Oil Filter Full Flow..... C-5505		D4H (DOZERS) S/N: 9GJ1-UP Air Filter Primary..... A-5507 Air Filter Set..... A-55071-S Air Filter Set..... A-5507-S Air Filter..... A-5530 Fuel Filter Secondary..... FC-5507 Hydraulic Oil Filter..... H-5504 Oil Filter Full Flow..... C-5505		D4H LGP (DOZERS) S/N: 8PB1-3999 Air Filter Primary..... A-5566 Air Filter Set..... A-5568-S	
D4H (DOZERS) S/N: 8PB1-UP Air Filter Set..... A-55071-S Air Filter Set..... A-5507-S		D4H II (DOZERS) CAT 3204 Cabin Air Filter..... CA-55140		D4H LGP (DOZERS) S/N: 8PB1-3999	

MODEL/APPLICATION	SAKURA NO	MODEL/APPLICATION	SAKURA NO	MODEL/APPLICATION	SAKURA NO
CATERPILLAR		CATERPILLAR		CATERPILLAR	
D4H SERIES III (DOZERS) CAT S/N: 09Z10600-UP Air Filter Set..... A-5507-S Air Filter Secondary..... A-5567 Air Filter Set..... A-55071-S Air Filter..... A-5530 Air Filter Primary..... A-5507 Air Filter Primary..... A-5566 Air Filter Set..... A-5568-S Fuel Filter Secondary..... FC-5507 Hydraulic Oil Filter..... H-5504 Hydraulic Oil Filter..... H-55270 Oil Filter Full Flow..... C-5522		Oil Filter Full Flow..... C-5510 D4H XL (DOZERS) S/N: 9GJ1-9GJ1 Air Filter Primary..... A-5566 Air Filter Set..... A-5568-S Air Filter Secondary..... A-5567 D4H XL (DOZERS) S/N: 9GJ1-UP Air Filter Primary..... A-5566 Air Filter..... A-5530 Air Filter Primary..... A-5507 Air Filter Secondary..... A-5567 Air Filter Set..... A-5507-S Air Filter Set..... A-5568-S Air Filter Set..... A-55071-S Fuel Filter..... F-5505 Fuel Filter Secondary..... FC-5507 Hydraulic Oil Filter..... H-55270 Hydraulic Oil Filter..... H-5504 Oil Filter Full Flow..... C-5510 D4H TSK II (DOZERS) CAT S/N: 45V1-UP Air Filter Set..... A-55071-S Air Filter Primary..... A-5507 Air Filter..... A-5530 Air Filter Set..... A-5507-S Fuel Filter..... FC-5501 Fuel Filter..... FC-5523 Hydraulic Oil Filter..... H-55270 Oil Filter Full Flow..... C-5505 D4H TSK III (DOZERS) S/N: 7PK107-UP Air Filter Set..... A-55071-S Air Filter Set..... A-5507-S Air Filter Set..... A-5568-S Air Filter Primary..... A-5507 Air Filter Secondary..... A-5567 Air Filter Primary..... A-5566 Air Filter..... A-5530 Hydraulic Oil Filter..... H-55270 D4H TSK III (DOZERS) S/N: 7PK1-106-UP Air Filter Primary..... A-5566 Air Filter Set..... A-55071-S Air Filter Secondary..... A-5567 Air Filter Set..... A-5568-S Air Filter Set..... A-5507-S Air Filter Primary..... A-5507 Air Filter..... A-5530 Hydraulic Oil Filter..... H-55270 D4K (DOZERS) CAT S/N: C4E1-49-UP , 2005-UP Hydraulic Oil Filter..... HC-5504 Oil Filter Full Flow..... C-5102 D4K (DOZERS) CAT S/N: C4E50-UP , 2005-UP Hydraulic Oil Filter..... HC-5504 Oil Filter Full Flow..... C-5102 D4K (DOZERS) CAT S/N: MMM1-UP , 2005-UP Hydraulic Oil Filter..... HC-5504 Oil Filter Full Flow..... C-5102 D4K (DOZERS) CAT S/N: RRR1-UP , 2005-UP Oil Filter Full Flow..... C-5102 D4K LGP (DOZERS) CAT C4.4 Fuel/Water Separator..... SFC-55240 Fuel/Water Separator..... SFC-55241 D4K XL (DOZERS) CAT C4.4 Fuel/Water Separator..... SFC-55241 Fuel/Water Separator..... SFC-55240 D5 (DOZERS) CAT 3116 Fuel Filter..... F-5503 D5 (DOZERS) Fuel Filter..... F-5503			
D4H SERIES III (DOZERS) CAT S/N: 4NK1-UP Air Filter Secondary..... A-5567 Air Filter Set..... A-55071-S Air Filter Primary..... A-5507 Air Filter Primary..... A-5566 Air Filter..... A-5530 Air Filter Set..... A-5507-S Air Filter Set..... A-5568-S Fuel Filter Secondary..... FC-5507 Hydraulic Oil Filter..... H-55270 Hydraulic Oil Filter..... H-5504 Oil Filter Full Flow..... C-5522		D4H TSK III (DOZERS) S/N: 8ZF1-UP Air Filter Set..... A-5507-S Air Filter..... A-5530 Air Filter Primary..... A-5507 Air Filter Set..... A-55071-S Fuel Filter Secondary..... FC-5507 Hydraulic Oil Filter..... H-5504 Oil Filter Full Flow..... C-5505 D4H XL (DOZERS) S/N: 4NK1-UP Air Filter Set..... A-5568-S Air Filter Primary..... A-5566 Air Filter Secondary..... A-5567 D4H XL (DOZERS) S/N: 8PG1-UP Air Filter Primary..... A-5566 Air Filter Secondary..... A-5567 Air Filter Set..... A-5568-S D4H XL (DOZERS) S/N: 8PJ1-UP Air Filter Primary..... A-5507 Air Filter Primary..... A-5566 Air Filter Secondary..... A-5567 Air Filter Set..... A-5507-S Air Filter..... A-5530 Air Filter Set..... A-5568-S Air Filter Set..... A-55071-S Fuel Filter..... F-5505 Fuel Filter Secondary..... FC-5507 Hydraulic Oil Filter..... H-55270 Hydraulic Oil Filter..... H-5504		D4H TSK III (DOZERS) S/N: 2EJ1-UP Hydraulic Oil Filter..... H-5501 D4H TSK III (DOZERS) S/N: 2EJ1-UP Hydraulic Oil Filter..... H-5501 D4H TSK III (DOZERS) S/N: 7PK107-UP Air Filter Set..... A-55071-S Air Filter Set..... A-5507-S Air Filter Set..... A-5568-S Air Filter Primary..... A-5507 Air Filter Secondary..... A-5567 Air Filter Primary..... A-5566 Air Filter..... A-5530 Hydraulic Oil Filter..... H-55270 D4H TSK III (DOZERS) S/N: 7PK1-106-UP Air Filter Primary..... A-5566 Air Filter Set..... A-55071-S Air Filter Secondary..... A-5567 Air Filter Set..... A-5568-S Air Filter Set..... A-5507-S Air Filter Primary..... A-5507 Air Filter..... A-5530 Hydraulic Oil Filter..... H-55270 D4K (DOZERS) CAT S/N: C4E1-49-UP , 2005-UP Hydraulic Oil Filter..... HC-5504 Oil Filter Full Flow..... C-5102 D4K (DOZERS) CAT S/N: C4E50-UP , 2005-UP Hydraulic Oil Filter..... HC-5504 Oil Filter Full Flow..... C-5102 D4K (DOZERS) CAT S/N: MMM1-UP , 2005-UP Hydraulic Oil Filter..... HC-5504 Oil Filter Full Flow..... C-5102 D4K (DOZERS) CAT S/N: RRR1-UP , 2005-UP Oil Filter Full Flow..... C-5102 D4K LGP (DOZERS) CAT C4.4 Fuel/Water Separator..... SFC-55240 Fuel/Water Separator..... SFC-55241 D4K XL (DOZERS) CAT C4.4 Fuel/Water Separator..... SFC-55241 Fuel/Water Separator..... SFC-55240 D5 (DOZERS) CAT 3116 Fuel Filter..... F-5503 D5 (DOZERS) Fuel Filter..... F-5503	

Sakura Filter

ENGINE APPLICATION

MODEL/APPLICATION	SAKURA NO
CATERPILLAR	
D5 (DOZERS) S/N: 12R1-UP	
Air Filter Secondary.....	A-5510
Air Filter Set.....	A-5522-S
Air Filter Primary.....	A-5509
Fuel Filter Secondary.....	FC-5507
Hydraulic Oil Filter.....	H-5504
D5 (DOZERS) S/N: 21J1-UP	
Air Filter Secondary.....	A-5510
Air Filter Set.....	A-5522-S
Air Filter Primary.....	A-5509
Fuel Filter.....	F-5501
D5 (DOZERS) S/N: 6R1-UP	
Air Filter Set.....	A-5522-S
Air Filter Primary.....	A-5509
Air Filter Secondary.....	A-5510
Fuel Filter Secondary.....	FC-5507
Hydraulic Oil Filter.....	H-5504
D5 (DOZERS) S/N: 81H1-UP	
Air Filter Set.....	A-5568-S
Air Filter Set.....	A-55071-S
Air Filter Secondary.....	A-5567
Air Filter Primary.....	A-5566
Air Filter Primary.....	A-5507
Air Filter Secondary.....	A-5508
Air Filter Set.....	A-5507-S
Air Filter Primary.....	A-5566
Air Filter Secondary.....	A-5508
Air Filter Secondary.....	A-5567
Air Filter Set.....	A-5568-S
Hydraulic Oil Filter.....	H-5504
Oil Filter Full Flow.....	O-5502
D5 (DOZERS) S/N: 82H1-UP	
Air Filter Set.....	A-55071-S
Air Filter Primary.....	A-5507
Air Filter Set.....	A-5507-S
Air Filter Primary.....	A-5566
Air Filter Secondary.....	A-5508
Air Filter Secondary.....	A-5567
Air Filter Set.....	A-5568-S
Hydraulic Oil Filter.....	H-5504
Oil Filter Full Flow.....	O-5502
D5 (DOZERS) S/N: 83H1-455	
Air Filter Primary.....	A-5507
Air Filter Set.....	A-5507-S
Air Filter Set.....	A-5568-S
Air Filter Primary.....	A-5566
Air Filter Secondary.....	A-5508
Air Filter Secondary.....	A-5567
Air Filter Set.....	A-55071-S
Hydraulic Oil Filter.....	H-5504
Oil Filter Full Flow.....	O-5502
D5 (DOZERS) S/N: 84H1-809	
Air Filter Set.....	A-55071-S
Air Filter Secondary.....	A-5508
Air Filter Secondary.....	A-5567

MODEL/APPLICATION	SAKURA NO
CATERPILLAR	
Air Filter Primary.....	A-5507
Air Filter Primary.....	A-5566
Air Filter Set.....	A-5507-S
Air Filter Set.....	A-5568-S
Hydraulic Oil Filter.....	H-5504
Oil Filter Full Flow.....	O-5502
D5 (DOZERS) S/N: 93J1-731	
Air Filter Primary.....	A-5509
Air Filter Set.....	A-5522-S
Air Filter Primary.....	A-5549M
Air Filter Primary.....	A-5549
Air Filter Secondary.....	A-5510
Air Filter Set.....	A-5549M-S
Air Filter Secondary.....	A-5550
Fuel Filter Secondary.....	FC-5507
Hydraulic Oil Filter.....	H-5504
Oil Filter Full Flow.....	C-5510
D5 (DOZERS) S/N: 93J732-904	
Air Filter Secondary.....	A-5510
Air Filter Primary.....	A-5509
Air Filter Set.....	A-5549M-S
Air Filter Primary.....	A-5549
Air Filter Primary.....	A-5549M
Air Filter Set.....	A-5522-S
Air Filter Secondary.....	A-5550
Fuel Filter Secondary.....	FC-5507
Hydraulic Oil Filter.....	H-5504
Oil Filter Full Flow.....	C-5510
D5 (DOZERS) S/N: 93J905-UP	
Air Filter Secondary.....	A-5550
Air Filter Secondary.....	A-5510
Air Filter Primary.....	A-5549M
Air Filter Primary.....	A-5549
Air Filter Set.....	A-5549M-S
Air Filter Primary.....	A-5509
Air Filter Set.....	A-5522-S
Fuel Filter Secondary.....	FC-5507
Hydraulic Oil Filter.....	H-5504
Oil Filter Full Flow.....	C-5510
D5 (DOZERS) S/N: 94J1-1704	
Air Filter Secondary.....	A-5550
Air Filter Secondary.....	A-5510
Air Filter Primary.....	A-5549M
Air Filter Primary.....	A-5549
Air Filter Primary.....	A-5509
Air Filter Set.....	A-5522-S
Air Filter Set.....	A-5549M-S
Fuel Filter Secondary.....	FC-5507
Hydraulic Oil Filter.....	H-5504
Oil Filter Full Flow.....	O-5502
D5 (DOZERS) S/N: 94J1705-2448	
Air Filter Primary.....	A-5549
Air Filter Secondary.....	A-5510
Air Filter Set.....	A-5522-S

MODEL/APPLICATION	SAKURA NO
CATERPILLAR	
Air Filter Primary.....	A-5509
Air Filter Primary.....	A-5549M
Air Filter Set.....	A-5549M-S
Air Filter Secondary.....	A-5550
Fuel Filter Secondary.....	FC-5507
Hydraulic Oil Filter.....	H-5504
Oil Filter Full Flow.....	C-5510
D5 (DOZERS) S/N: 94J2449-UP	
Air Filter Primary.....	A-5549
Air Filter Secondary.....	A-5550
Air Filter Primary.....	A-5509
Air Filter Secondary.....	A-5510
Air Filter Primary.....	A-5549M
Air Filter Set.....	A-5549M-S
Air Filter Set.....	A-5522-S
Fuel Filter Secondary.....	FC-5507
Hydraulic Oil Filter.....	H-5504
Oil Filter Full Flow.....	C-5510
D5 (DOZERS) S/N: 95J1-356	
Air Filter Primary.....	A-5549M
Air Filter Set.....	A-5522-S
Air Filter Primary.....	A-5549
Air Filter Set.....	A-5549M-S
Air Filter Primary.....	A-5509
Air Filter Secondary.....	A-5550
Air Filter Secondary.....	A-5510
Hydraulic Oil Filter.....	H-5504
Oil Filter Full Flow.....	C-5510
D5 (DOZERS) S/N: 95J357-UP	
Air Filter Secondary.....	A-5550
Air Filter Set.....	A-5549M-S
Air Filter Primary.....	A-5549
Air Filter Primary.....	A-5549M
Air Filter Secondary.....	A-5510
Air Filter Set.....	A-5522-S
Air Filter Primary.....	A-5509
Hydraulic Oil Filter.....	H-5504
Oil Filter Full Flow.....	C-5510
D5 (DOZERS) S/N: 96J1-3587	
Air Filter Secondary.....	A-5510
Air Filter Primary.....	A-5509
Air Filter Set.....	A-5549M-S
Air Filter Secondary.....	A-5550
Air Filter Primary.....	A-5549
Air Filter Primary.....	A-5549M
Air Filter Set.....	A-5522-S
Hydraulic Oil Filter.....	H-5504
Oil Filter Full Flow.....	C-5510
D5 (DOZERS) S/N: 96J3588-5261	
Air Filter Primary.....	A-5509
Air Filter Set.....	A-5549M-S
Air Filter Set.....	A-5522-S
Air Filter Primary.....	A-5549
Air Filter Primary.....	A-5549M

Sakura Filter

ENGINE APPLICATION

MODEL/APPLICATION	SAKURA NO	MODEL/APPLICATION	SAKURA NO	MODEL/APPLICATION	SAKURA NO
CATERPILLAR		CATERPILLAR		CATERPILLAR	
D5 (DOZERS) S/N: 96J3588-5261		D550B (ARTICULATED TRUCKS) CAT 340B (S/N: 5ND1-UP) , 2005-UP		Oil Filter Full Flow.....	C-5522
Air Filter Secondary.....	A-5510	Air Filter Secondary.....	A-5529	D5B (DOZERS) CAT (S/N: 7YJ1768-UP)	
Air Filter Secondary.....	A-5550	Air Filter Primary.....	A-5521	Fuel Filter.....	FC-5523
Hydraulic Oil Filter.....	H-5504	Air Filter Set.....	A-5521-S	Fuel Filter Secondary.....	FC-5507
Oil Filter Full Flow.....	C-5510	Fuel Filter.....	F-5505	Fuel Filter.....	FC-5501
D5 (DOZERS) S/N: 98J1-1133		Hydraulic Oil Filter.....	H-5503	Oil Filter Full Flow.....	C-5519
Air Filter Secondary.....	A-5550	Hydraulic Oil Filter.....	H-5504	Oil Filter Full Flow.....	C-5505
Air Filter Set.....	A-5549M-S	Oil Filter Full Flow.....	C-5516	D5B (DOZERS) CAT S/N: 08Z19205-20403	
Air Filter Secondary.....	A-5510	D550B (ARTICULATED TRUCKS) S/N: 5ND1-UP		Fuel Filter Secondary.....	FC-5507
Air Filter Primary.....	A-5509	Air Filter Set.....	A-5521-S	D5B (DOZERS) CAT S/N: 13Z9002-UP	
Air Filter Primary.....	A-5549M	Air Filter Secondary.....	A-5529	Fuel Filter Secondary.....	FC-5507
Air Filter Primary.....	A-5549	Air Filter Primary.....	A-5521	D5B (DOZERS)	
Air Filter Set.....	A-5522-S	Hydraulic Oil Filter.....	H-55270	Fuel Filter.....	F-5503
Fuel Filter Secondary.....	FC-5507	Hydraulic Oil Filter.....	H-5526	D5B (DOZERS)	
Hydraulic Oil Filter.....	H-5504	Hydraulic Oil Filter.....	H-5504	Fuel Filter.....	F-5503
Oil Filter Full Flow.....	C-5510	Hydraulic Oil Filter.....	H-55280	D5B (DOZERS) S/N: 21Y1-557	
D5 (DOZERS) S/N: 98J1134-1590		Hydraulic Oil Filter.....	H-5503	Hydraulic Oil Filter.....	H-5504
Air Filter Set.....	A-5522-S	Oil Filter Full Flow.....	C-5516	D5B (DOZERS) S/N: 21Y1-557	
Air Filter Primary.....	A-5549M	D5B (DOZERS) CAT (S/N: 08Z20404-UP)		Hydraulic Oil Filter.....	H-5504
Air Filter Secondary.....	A-5510	Fuel Filter Secondary.....	FC-5507	D5B (DOZERS) S/N: 21Y1-UP	
Air Filter Primary.....	A-5509	Oil Filter Full Flow.....	C-5510	Air Filter Set.....	A-5522-S
Air Filter Set.....	A-5549M-S	Oil Filter Full Flow.....	C-5522	Air Filter Secondary.....	A-5510
Air Filter Primary.....	A-5549	D5B (DOZERS) CAT (S/N: 08Z446-19204)		Air Filter Primary.....	A-5509
Air Filter Secondary.....	A-5550	Fuel Filter Secondary.....	FC-5507	Fuel Filter Secondary.....	FC-5507
Fuel Filter Secondary.....	FC-5507	Oil Filter Full Flow.....	C-5522	Hydraulic Oil Filter.....	H-5504
Hydraulic Oil Filter.....	H-5504	Oil Filter Full Flow.....	C-5510	Oil Filter Full Flow.....	C-5510
Oil Filter Full Flow.....	C-5510	D5B (DOZERS) CAT (S/N: 13Z1-7767)		D5B (DOZERS) S/N: 21Y558-UP	
D5 (DOZERS) S/N: 98J1591-UP		Fuel Filter Secondary.....	FC-5507	Hydraulic Oil Filter.....	H-5504
Air Filter Set.....	A-5549M-S	Fuel Filter.....	FC-5523	D5B (DOZERS) S/N: 22X1-UP	
Air Filter Set.....	A-5522-S	Fuel Filter.....	FC-5501	Air Filter Secondary.....	A-5510
Air Filter Primary.....	A-5509	Oil Filter Full Flow.....	C-5522	Air Filter Set.....	A-5522-S
Air Filter Primary.....	A-5549M	Oil Filter Full Flow.....	C-5510	Air Filter Primary.....	A-5509
Air Filter Primary.....	A-5549	D5B (DOZERS) CAT (S/N: 13Z7768-9001)		Fuel Filter Secondary.....	FC-5507
Air Filter Secondary.....	A-5510	Fuel Filter Secondary.....	FC-5507	Hydraulic Oil Filter.....	H-5504
Air Filter Secondary.....	A-5550	Fuel Filter.....	FC-5523	Hydraulic Oil Filter.....	H-5502
Fuel Filter Secondary.....	FC-5507	Fuel Filter.....	FC-5501	Oil Filter Full Flow.....	C-5510
Hydraulic Oil Filter.....	H-5504	D5B (DOZERS) CAT (S/N: 1AF1-977)		D5B (DOZERS) S/N: 23X1-UP	
Oil Filter Full Flow.....	C-5510	Fuel Filter.....	FC-5501	Air Filter Secondary.....	A-5510
D5 (DOZERS) w/3306 Eng.		Fuel Filter.....	FC-5523	Air Filter Set.....	A-5522-S
Hydraulic Oil Filter.....	H-55320	Oil Filter Full Flow.....	C-5510	Air Filter Primary.....	A-5509
D550 (ARTICULATED TRUCKS) S/N: 4RD1-UP		D5B (DOZERS) CAT (S/N: 1AF978-992)		Fuel Filter Secondary.....	FC-5507
Air Filter Set.....	A-5521-S	Fuel Filter.....	FC-5523	Hydraulic Oil Filter.....	H-5502
Air Filter Primary.....	A-5521	Oil Filter Full Flow.....	C-5510	Hydraulic Oil Filter.....	H-5504
Air Filter Secondary.....	A-5556	D5B (DOZERS) CAT (S/N: 1AF993-UP)		Oil Filter Full Flow.....	C-5510
Air Filter Set.....	A-5555-S	Fuel Filter.....	FC-5523	D5B (DOZERS) S/N: 24X1-UP	
Air Filter Secondary.....	A-5529	Oil Filter Full Flow.....	FC-5501	Air Filter Secondary.....	A-5550
Air Filter Primary.....	A-5555	Oil Filter Full Flow.....	C-5510	Air Filter Primary.....	A-5509
Fuel Filter.....	FC-5509	Oil Filter Full Flow.....	C-5522	Air Filter Set.....	A-5522-S
Hydraulic Oil Filter.....	H-5504	D5B (DOZERS)		Air Filter Primary.....	A-5549M
Hydraulic Oil Filter.....	H-5503	Fuel Filter.....	FC-5501	Air Filter Set.....	A-5549M-S
Oil Filter Full Flow.....	C-5516	Fuel Filter.....	FC-5523	Air Filter Primary.....	A-5549

Sakura Filter

ENGINE APPLICATION

MODEL/APPLICATION	SAKURA NO	MODEL/APPLICATION	SAKURA NO	MODEL/APPLICATION	SAKURA NO
CATERPILLAR		CATERPILLAR		CATERPILLAR	
D5B <i>(DOZERS)</i> S/N: 24X1-UP		Hydraulic Oil Filter.....	H-5502	Oil Filter Full Flow.....	C-5510
Air Filter Secondary.....	A-5510	Hydraulic Oil Filter.....	H-5504	D5B <i>(DOZERS)</i> S/N: 8HD1-620	
Fuel Filter Secondary.....	FC-5507	Oil Filter Full Flow.....	C-5510	Air Filter Set.....	A-5522-S
Hydraulic Oil Filter.....	H-5504	D5B <i>(DOZERS)</i> S/N: 44X1-UP		Air Filter Primary.....	A-5509
Hydraulic Oil Filter.....	H-5502	Air Filter Set.....	A-5522-S	Air Filter Secondary.....	A-5510
Oil Filter Full Flow.....	C-5510	Air Filter Primary.....	A-5509	Fuel Filter.....	F-5505
D5B <i>(DOZERS)</i> S/N: 25X1-UP		Air Filter Secondary.....	FC-5507	Fuel Filter Secondary.....	FC-5507
Air Filter Primary.....	A-5549	Hydraulic Oil Filter.....	H-5504	Hydraulic Oil Filter.....	H-5504
Air Filter Primary.....	A-5549M	Hydraulic Oil Filter.....	H-5502	Hydraulic Oil Filter.....	H-5502
Air Filter Primary.....	A-5509	Oil Filter Full Flow.....	C-5510	Hydraulic Oil Filter.....	H-55270
Air Filter Set.....	A-5522-S	D5B <i>(DOZERS)</i> S/N: 45X1-UP		Oil Filter Full Flow.....	C-5510
Air Filter Set.....	A-5549M-S	Air Filter Primary.....	A-5509	D5B <i>(DOZERS)</i> S/N: 8BD1-UP	
Air Filter Secondary.....	A-5550	Air Filter Secondary.....	A-5510	Air Filter Set.....	A-5522-S
Air Filter Secondary.....	A-5510	Air Filter Set.....	A-5522-S	Air Filter Primary.....	A-5509
Fuel Filter Secondary.....	FC-5507	Air Filter Set.....	A-5522-S	Air Filter Secondary.....	A-5510
Hydraulic Oil Filter.....	H-5502	Fuel Filter Secondary.....	FC-5507	Hydraulic Oil Filter.....	H-5502
Hydraulic Oil Filter.....	H-5504	Hydraulic Oil Filter.....	H-5504	D5B <i>(DOZERS)</i> S/N: 8MB1-UP	
Oil Filter Full Flow.....	C-5510	Hydraulic Oil Filter.....	H-5502	Air Filter Set.....	A-5522-S
D5B <i>(DOZERS)</i> S/N: 26X1-826		Oil Filter Full Flow.....	C-5510	Air Filter Secondary.....	A-5510
Hydraulic Oil Filter.....	H-55270	D5B <i>(DOZERS)</i> S/N: 46X1-UP		Air Filter Primary.....	A-5509
Hydraulic Oil Filter.....	H-5504	Air Filter Secondary.....	A-5510	Air Filter Set.....	A-5522-S
D5B <i>(DOZERS)</i> S/N: 26X1-UP		Air Filter Primary.....	A-5509	Fuel Filter Secondary.....	FC-5507
Air Filter Primary.....	A-5549M	Air Filter Set.....	A-5522-S	Hydraulic Oil Filter.....	H-55270
Air Filter Set.....	A-5522-S	Air Filter Set.....	A-5522-S	Hydraulic Oil Filter.....	H-5502
Air Filter Primary.....	A-5509	Fuel Filter Secondary.....	FC-5507	Hydraulic Oil Filter.....	H-5504
Air Filter Primary.....	A-5549	Hydraulic Oil Filter.....	H-5504	Oil Filter Full Flow.....	C-5510
Air Filter Secondary.....	A-5510	Oil Filter Full Flow.....	C-5510	D5B <i>(DOZERS)</i> w/3306 Eng.	
Air Filter Secondary.....	A-5550	D5B <i>(DOZERS)</i> S/N: 47X1-UP		Hydraulic Oil Filter.....	H-55320
Air Filter Set.....	A-5549M-S	Air Filter Set.....	A-5522-S	D5C <i>(DOZERS)</i> CAT (S/N: 45V97770-UP)	
Fuel Filter Secondary.....	FC-5507	Air Filter Secondary.....	A-5510	Fuel Filter.....	FC-5523
Hydraulic Oil Filter.....	H-5504	Air Filter Primary.....	A-5509	Fuel Filter.....	FC-5501
Oil Filter Full Flow.....	C-5510	Fuel Filter Secondary.....	FC-5507	Oil Filter Full Flow.....	C-5519
D5B <i>(DOZERS)</i> S/N: 26X827-UP		Hydraulic Oil Filter.....	H-5504	D5C <i>(DOZERS)</i> CAT (S/N: 7YJ1-1767)	
Hydraulic Oil Filter.....	H-55270	Hydraulic Oil Filter.....	H-55270	Fuel Filter.....	FC-5501
Hydraulic Oil Filter.....	H-5504	Oil Filter Full Flow.....	C-5510	Fuel Filter Secondary.....	FC-5507
D5B <i>(DOZERS)</i> S/N: 27Y1-UP		D5B <i>(DOZERS)</i> S/N: 48X1-UP		Fuel Filter.....	FC-5523
Air Filter Secondary.....	A-5510	Air Filter Primary.....	A-5509	Oil Filter Full Flow.....	C-5505
Air Filter Primary.....	A-5509	Air Filter Secondary.....	A-5510	Oil Filter Full Flow.....	C-5519
Air Filter Set.....	A-5549M-S	Air Filter Set.....	A-5522-S	D5C <i>(DOZERS)</i> S/N: 3MK1-UP	
Air Filter Secondary.....	A-5550	Fuel Filter Secondary.....	FC-5507	Air Filter Secondary.....	A-5525
Air Filter Primary.....	A-5549	Hydraulic Oil Filter.....	H-5504	Air Filter Primary.....	A-5542
Air Filter Set.....	A-5522-S	Hydraulic Oil Filter.....	H-5502	Air Filter Set.....	A-5542-S
Air Filter Primary.....	A-5549M	Hydraulic Oil Filter.....	H-55270	Fuel Filter Secondary.....	FC-5507
Fuel Filter Secondary.....	FC-5507	Oil Filter Full Flow.....	C-5510	Hydraulic Oil Filter.....	H-5504
Hydraulic Oil Filter.....	H-5504	D5B <i>(DOZERS)</i> S/N: 5LD1-UP		Hydraulic Oil Filter.....	H-55270
Oil Filter Full Flow.....	C-5510	Air Filter Primary.....	A-5509	Oil Filter Full Flow.....	C-5519
D5B <i>(DOZERS)</i> S/N: 43X1-UP		Air Filter Set.....	A-5522-S	D5C <i>(DOZERS)</i> S/N: 5HS1-UP	
Air Filter Secondary.....	A-5510	Air Filter Secondary.....	A-5510	Air Filter Secondary.....	A-5525
Air Filter Primary.....	A-5509	Fuel Filter Secondary.....	FC-5507	Air Filter Primary.....	A-5542
Air Filter Set.....	A-5522-S	Fuel Filter.....	F-5505	Air Filter Set.....	A-5542-S
Fuel Filter Secondary.....	FC-5507	Hydraulic Oil Filter.....	H-55270	D5C <i>(DOZERS)</i> S/N: 5HS1-UP	
D5B <i>(DOZERS)</i> S/N: 24X1-UP		Hydraulic Oil Filter.....	H-5504	Air Filter Secondary.....	A-5525
Air Filter Secondary.....	A-5510	Hydraulic Oil Filter.....	H-5502	Air Filter Primary.....	A-5542
Air Filter Primary.....	A-5509	Hydraulic Oil Filter.....	H-5504	Air Filter Set.....	A-5542-S
Air Filter Set.....	A-5522-S	Hydraulic Oil Filter.....	H-5502		
Fuel Filter Secondary.....	FC-5507				

Sakura Filter

ENGINE APPLICATION

MODEL/APPLICATION	SAKURA NO	MODEL/APPLICATION	SAKURA NO	MODEL/APPLICATION	SAKURA NO
CATERPILLAR		CATERPILLAR		CATERPILLAR	
D5E (DOZERS) S/N: 9RG1-UP		D5G (DOZERS) S/N: WGB1-UP		Air Filter Primary.....	A-5549M
Hydraulic Oil Filter.....	H-5502	Hydraulic Oil Filter.....	HC-5504	Hydraulic Oil Filter.....	H-5504
Hydraulic Oil Filter.....	H-5504	Hydraulic Oil Filter.....	HC-55220	Hydraulic Oil Filter.....	H-5510
Hydraulic Oil Filter.....	H-55270	Hydraulic Oil Filter.....	HC-5507		
Oil Filter Full Flow.....	C-5510			D5H (DOZERS) S/N: 1TD4027-UP	
D5E (DOZERS) S/N: 9RG354-UP		D5 G XL (DOZERS) CAT 3046 T TIER2		Air Filter Primary.....	A-5509
Air Filter Primary.....	A-5549	Air Filter Secondary.....	A-4402	Air Filter Set.....	A-5522-S
Air Filter Secondary.....	A-5550			Air Filter Secondary.....	A-5522
Air Filter Primary.....	A-5549M	D5H (DOZERS) CAT 3304		Fuel Filter Secondary.....	FC-5507
Air Filter Set.....	A-5549M-S	Cabin Air Filter.....	CA-55140	Fuel Filter.....	F-5505
Hydraulic Oil Filter.....	H-5504			Hydraulic Oil Filter.....	H-5504
D5E (DOZERS) w/3306 Eng.		D5H (DOZERS) CAT (S/N: 12Z10967-38999)		Hydraulic Oil Filter.....	H-5510
Hydraulic Oil Filter.....	H-55320	Oil Filter Full Flow.....	C-5510	Hydraulic Oil Filter.....	H-55270
D5E DD (DOZERS) S/N: 9RG1-UP		D5H (DOZERS) CAT (S/N: 12Z39000-46243)		D5H (DOZERS) S/N: 1WB1-UP	
Air Filter Set.....	A-5522-S	Fuel Filter Secondary.....	FC-5507	Hydraulic Oil Filter.....	H-5501
Air Filter Primary.....	A-5509	Fuel Filter.....	FC-5523		
Air Filter Secondary.....	A-5510	Fuel Filter.....	FC-5501	D5H (DOZERS) S/N: 1YD1-4026	
Fuel Filter Secondary.....	FC-5507	Oil Filter Full Flow.....	C-5510	Air Filter Primary.....	A-5509
Hydraulic Oil Filter.....	H-5504			Air Filter Set.....	A-5522-S
Hydraulic Oil Filter.....	H-5502	D5H (DOZERS) CAT (S/N: 12Z46244-UP)		Air Filter Secondary.....	A-5522
Oil Filter Full Flow.....	C-5510	Fuel Filter Secondary.....	FC-5507	Fuel Filter.....	F-5505
D5G (DOZERS) CAT (S/N: 5XK30700-UP)		Oil Filter Full Flow.....	C-5510	Fuel Filter Secondary.....	FC-5507
Fuel Filter Secondary.....	FC-5515			Hydraulic Oil Filter.....	H-5504
Fuel Filter Secondary.....	FC-55151	D5H (DOZERS) S/N: 1DD1-3999		Hydraulic Oil Filter.....	H-5510
Fuel Filter.....	FC-5516	Air Filter Secondary.....	A-5522	Hydraulic Oil Filter.....	H-5510
Oil Filter Full Flow.....	C-5504	Air Filter Primary.....	A-5509	Hydraulic Oil Filter.....	H-55270
D5G (DOZERS) CAT (S/N: MHK1-UP)		Air Filter Set.....	A-5522-S	Air Filter Primary.....	A-5509
Fuel Filter Secondary.....	FC-5515	Fuel Filter Secondary.....	FC-5507	Air Filter Primary.....	A-5549M
Fuel Filter Secondary.....	FC-55151	Fuel Filter.....	F-5505	Air Filter Secondary.....	A-5550
Fuel Filter.....	FC-5516	Hydraulic Oil Filter.....	H-55270	Air Filter Secondary.....	A-5522
Oil Filter Full Flow.....	C-5504	Hydraulic Oil Filter.....	H-5504	Air Filter Primary.....	A-5549
D5G (DOZERS) CAT 3046 T		Oil Filter Full Flow.....	C-5510	Fuel Filter Secondary.....	FC-5507
Air Filter Secondary.....	A-4402	D5H (DOZERS) S/N: 1DD1-5759		Hydraulic Oil Filter.....	H-5510
Oil Filter Full Flow.....	C-6218	Air Filter Set.....	A-5522-S	Hydraulic Oil Filter.....	H-5504
D5G (DOZERS) S/N: FDH1-UP		Air Filter Primary.....	A-5509	Oil Filter Full Flow.....	C-5510
Hydraulic Oil Filter.....	HC-5504	Air Filter Secondary.....	A-5522	D5H (DOZERS) S/N: 2CC1-UP	
Hydraulic Oil Filter.....	HC-5507	Hydraulic Oil Filter.....	H-5504	Hydraulic Oil Filter.....	H-5501
Hydraulic Oil Filter.....	HC-55220	Hydraulic Oil Filter.....	H-5510		
D5G (DOZERS) S/N: FDW1-UP		D5H (DOZERS) S/N: 1DD4000-UP		D5H (DOZERS) S/N: 2EJ1-UP	
Hydraulic Oil Filter.....	HC-5507	Air Filter Set.....	A-5549M-S	Hydraulic Oil Filter.....	H-5501
Hydraulic Oil Filter.....	HC-55220	Air Filter Primary.....	A-5549M		
Hydraulic Oil Filter.....	HC-5504	Air Filter Secondary.....	A-5550	D5H (DOZERS) S/N: 2SD1-4078	
D5G (DOZERS) S/N: RKG1-UP		Air Filter Primary.....	A-5549	Air Filter Secondary.....	A-5522
Hydraulic Oil Filter.....	HC-5507	Fuel Filter.....	F-5505	Air Filter Set.....	A-5522-S
Hydraulic Oil Filter.....	HC-55220	Fuel Filter Secondary.....	FC-5507	Air Filter Primary.....	A-5509
Hydraulic Oil Filter.....	HC-5504	Hydraulic Oil Filter.....	H-5504	Fuel Filter.....	F-5505
D5G (DOZERS) S/N: 1DD5760-UP		Hydraulic Oil Filter.....	H-55270	Fuel Filter Secondary.....	FC-5507
Hydraulic Oil Filter.....	HC-5507	Oil Filter Full Flow.....	C-5510	Hydraulic Oil Filter.....	H-5510
Hydraulic Oil Filter.....	HC-5504	D5H (DOZERS) S/N: 1DD5760-UP		Hydraulic Oil Filter.....	H-5504
Hydraulic Oil Filter.....	HC-55220	Air Filter Secondary.....	A-5550	Hydraulic Oil Filter.....	H-55270
		Air Filter Primary.....	A-5549		
		Air Filter Set.....	A-5549M-S	D5H (DOZERS) S/N: 2SD1-UP	

Sakura Filter

ENGINE APPLICATION

MODEL/APPLICATION	SAKURA NO	MODEL/APPLICATION	SAKURA NO	MODEL/APPLICATION	SAKURA NO
CATERPILLAR		CATERPILLAR		CATERPILLAR	
D5H (DOZERS) S/N: 25D1-UP Air Filter Set..... A-5522-S Air Filter Set..... A-5549M-S Air Filter Secondary..... A-5522 Air Filter Primary..... A-5509 Air Filter Primary..... A-5549 Air Filter Primary..... A-5549M Air Filter Secondary..... A-5550 Fuel Filter Secondary..... FC-5507 Hydraulic Oil Filter..... H-5510 Hydraulic Oil Filter..... H-5504 Oil Filter Full Flow..... C-5510		Air Filter Set..... A-5522-S Air Filter Primary..... A-5509 Fuel Filter Secondary..... FC-5507 Hydraulic Oil Filter..... H-5510 Hydraulic Oil Filter..... H-5504 Oil Filter Full Flow..... C-5510 D5H (DOZERS) S/N: 4KD1-4069 Air Filter Primary..... A-5509 Air Filter Set..... A-5522-S Air Filter Secondary..... A-5522 Fuel Filter..... F-5505 Fuel Filter Secondary..... FC-5507 Hydraulic Oil Filter..... H-5510 Hydraulic Oil Filter..... H-55270 Hydraulic Oil Filter..... H-5504 D5H (DOZERS) S/N: 4KD1-4070 Air Filter Primary..... A-5509 Air Filter Secondary..... A-5522 Air Filter Set..... A-5522-S Fuel Filter Secondary..... FC-5507 Hydraulic Oil Filter..... H-5504 Hydraulic Oil Filter..... H-5510 Oil Filter Full Flow..... C-5510 D5H (DOZERS) S/N: 4KD4070-UP Air Filter Secondary..... A-5522 Air Filter Primary..... A-5509 Air Filter Set..... A-5522-S Fuel Filter Secondary..... FC-5507 Fuel Filter..... F-5505 Hydraulic Oil Filter..... H-5510 Hydraulic Oil Filter..... H-55270 Hydraulic Oil Filter..... H-5504 D5H (DOZERS) S/N: 3MD1-4025 Air Filter Secondary..... A-5522 Air Filter Primary..... A-5509 Air Filter Set..... A-5522-S Fuel Filter Secondary..... FC-5507 Fuel Filter..... F-5505 Hydraulic Oil Filter..... H-55270 Hydraulic Oil Filter..... H-5504 Hydraulic Oil Filter..... H-5510 D5H (DOZERS) S/N: 3MD1-4026 Air Filter Secondary..... A-5522 Air Filter Secondary..... A-5550 Air Filter Primary..... A-5549 Air Filter Set..... A-5549M-S Air Filter Set..... A-5522-S Air Filter Primary..... A-5509 Air Filter Primary..... A-5549M Fuel Filter Secondary..... FC-5507 Hydraulic Oil Filter..... H-5504 Hydraulic Oil Filter..... H-5510 Oil Filter Full Flow..... C-5510 D5H (DOZERS) S/N: 3MD4026-UP Air Filter Secondary..... A-5522 Air Filter Set..... A-5522-S Air Filter Primary..... A-5509 Fuel Filter..... F-5505 Fuel Filter Secondary..... FC-5507 Hydraulic Oil Filter..... H-55270 Hydraulic Oil Filter..... H-5510 Hydraulic Oil Filter..... H-5504 D5H (DOZERS) S/N: 3MD4027-UP Air Filter Secondary..... A-5522		Air Filter Set..... A-5522-S Air Filter Primary..... A-5509 Fuel Filter Secondary..... FC-5507 Hydraulic Oil Filter..... H-5510 Hydraulic Oil Filter..... H-5504 Oil Filter Full Flow..... C-5510 D5H (DOZERS) S/N: 7NC1-5499 Air Filter Set..... A-5522-S Air Filter Secondary..... A-5522 Air Filter Primary..... A-5509 Hydraulic Oil Filter..... H-5504 Hydraulic Oil Filter..... H-5510 Hydraulic Oil Filter..... H-55270 D5H (DOZERS) S/N: 7NC4000-UP Air Filter Primary..... A-5549 Air Filter Primary..... A-5549M Air Filter Set..... A-5549M-S Air Filter Secondary..... A-5550 Fuel Filter Secondary..... FC-5507 Fuel Filter..... F-5505 Hydraulic Oil Filter..... H-55270 Hydraulic Oil Filter..... H-5504 Oil Filter Full Flow..... C-5510 D5H (DOZERS) S/N: 7NC5500-5524 Air Filter Secondary..... A-5522 Air Filter Primary..... A-5509 Air Filter Set..... A-5522-S Hydraulic Oil Filter..... H-5504 Hydraulic Oil Filter..... H-55270 Hydraulic Oil Filter..... H-5510 D5H (DOZERS) S/N: 7NC5525-UP Air Filter Secondary..... A-5550 Air Filter Primary..... A-5549 Air Filter Set..... A-5549M-S Air Filter Primary..... A-5549M Hydraulic Oil Filter..... H-5510 Hydraulic Oil Filter..... H-55270 Hydraulic Oil Filter..... H-5504 D5H (DOZERS) S/N: 8RC1-3999 Air Filter Set..... A-5522-S Air Filter Primary..... A-5509 Air Filter Secondary..... A-5522 Fuel Filter Secondary..... FC-5507 Fuel Filter..... F-5505 Hydraulic Oil Filter..... H-55270 Hydraulic Oil Filter..... H-5504 Oil Filter Full Flow..... C-5510 D5H (DOZERS) S/N: 8RC1-5846 Air Filter Set..... A-5522-S Air Filter Primary..... A-5509 Air Filter Secondary..... A-5522 Hydraulic Oil Filter..... H-5510 Hydraulic Oil Filter..... H-5504 D5H (DOZERS) S/N: 8RC4000-UP Air Filter Primary..... A-5549 Air Filter Primary..... A-5549M Air Filter Set..... A-5549M-S	

Sakura Filter

ENGINE APPLICATION

MODEL/APPLICATION	SAKURA NO	MODEL/APPLICATION	SAKURA NO	MODEL/APPLICATION	SAKURA NO
CATERPILLAR		CATERPILLAR		CATERPILLAR	
D5H (DOZERS) S/N: 8RC4000-UP Air Filter Secondary..... A-5550 Fuel Filter Secondary..... FC-5507 Fuel Filter..... F-5505 Hydraulic Oil Filter..... H-5504 Hydraulic Oil Filter..... H-55270 Oil Filter Full Flow..... C-5510		Air Filter Secondary..... A-5550 Air Filter Set..... A-5549M-S Fuel Filter Secondary..... FC-5507 Fuel Filter..... F-5505 Hydraulic Oil Filter..... H-5504 Hydraulic Oil Filter..... H-55270 Oil Filter Full Flow..... C-5510		Hydraulic Oil Filter..... H-5510 Hydraulic Oil Filter..... H-5504 D5H LGP (DOZERS) S/N: 2SD1-UP Air Filter Set..... A-5522-S Air Filter Primary..... A-5509 Air Filter Secondary..... A-5522 Fuel Filter..... F-5505 Fuel Filter Secondary..... FC-5507 Hydraulic Oil Filter..... H-5510 Hydraulic Oil Filter..... H-5504	
D5H (DOZERS) S/N: 8RC5847-UP Air Filter Secondary..... A-5550 Air Filter Set..... A-5549M-S Air Filter Primary..... A-5549M Air Filter Primary..... A-5549 Hydraulic Oil Filter..... H-5510 Hydraulic Oil Filter..... H-5504		D5H (DOZERS) S/N: 9HC5500-5518 Air Filter Secondary..... A-5522 Air Filter Set..... A-5522-S Air Filter Primary..... A-5509 Hydraulic Oil Filter..... H-5510 Hydraulic Oil Filter..... H-55270 Hydraulic Oil Filter..... H-5504		D5H LGP (DOZERS) S/N: 4KD1-UP Air Filter Primary..... A-5509 Air Filter Secondary..... A-5522 Air Filter Set..... A-5522-S Fuel Filter..... F-5505 Fuel Filter Secondary..... FC-5507 Hydraulic Oil Filter..... H-5510 Hydraulic Oil Filter..... H-55270 Hydraulic Oil Filter..... H-5504	
D5H (DOZERS) S/N: 8SC1-UP Air Filter Primary..... A-5509 Air Filter Secondary..... A-5522 Air Filter Set..... A-5522-S Fuel Filter Secondary..... FC-5507 Fuel Filter..... F-5505 Oil Filter Full Flow..... C-5510		D5H (DOZERS) S/N: 9HC5519-UP Air Filter Primary..... A-5549 Air Filter Set..... A-5549M-S Air Filter Primary..... A-5549M Air Filter Secondary..... A-5550 Hydraulic Oil Filter..... H-5510 Hydraulic Oil Filter..... H-5504 Hydraulic Oil Filter..... H-55270		D5H LGP (DOZERS) S/N: 7NC1-3999 Air Filter Secondary..... A-5522 Air Filter Primary..... A-5509 Air Filter Set..... A-5522-S Fuel Filter..... F-5505 Fuel Filter Secondary..... FC-5507 Hydraulic Oil Filter..... H-5504 Hydraulic Oil Filter..... H-55270 Hydraulic Oil Filter..... H-5504 Oil Filter Full Flow..... C-5510	
D5H (DOZERS) S/N: 9HC1-3999 Air Filter Primary..... A-5509 Air Filter Set..... A-5522-S Air Filter Secondary..... A-5522 Fuel Filter Secondary..... FC-5507 Fuel Filter..... F-5505 Hydraulic Oil Filter..... H-5504 Hydraulic Oil Filter..... H-55270 Oil Filter Full Flow..... C-5510		D5H II (DOZERS) CAT 3304 Cabin Air Filter..... CA-55140		D5H LGP (DOZERS) S/N: 3MD1-UP , TO-2001 Air Filter Secondary..... A-5522 Air Filter Set..... A-5522-S Air Filter Primary..... A-5509 Fuel Filter Secondary..... FC-5507 Fuel Filter..... F-5505 Hydraulic Oil Filter..... H-55270 Hydraulic Oil Filter..... H-5504 Hydraulic Oil Filter..... H-5510	
D5H (DOZERS) S/N: 9HC1-5499 Air Filter Secondary..... A-5522 Air Filter Set..... A-5522-S Air Filter Primary..... A-5509 Hydraulic Oil Filter..... H-55270 Hydraulic Oil Filter..... H-5504 Hydraulic Oil Filter..... H-5510		D5H LGP (DOZERS) CAT 3304 Cabin Air Filter..... CA-55140		D5H LGP (DOZERS) S/N: 8RC1-3999 Air Filter Set..... A-5522-S Air Filter Secondary..... A-5522 Air Filter Primary..... A-5509 Fuel Filter..... F-5505 Fuel Filter Secondary..... FC-5507 Hydraulic Oil Filter..... H-55270 Hydraulic Oil Filter..... H-5504 Oil Filter Full Flow..... C-5510	
D5H (DOZERS) S/N: 9HC1-UP Air Filter Primary..... A-5509 Air Filter Primary..... A-5549 Air Filter Secondary..... A-5522 Air Filter Secondary..... A-5550 Air Filter Primary..... A-5549M Air Filter Set..... A-5522-S Air Filter Set..... A-5549M-S Fuel Filter Secondary..... FC-5507 Hydraulic Oil Filter..... H-5504 Oil Filter Full Flow..... C-5510		D5H LGP (DOZERS) S/N: 1DD1-3999 Air Filter Secondary..... A-5522 Air Filter Set..... A-5522-S Air Filter Primary..... A-5509 Fuel Filter Secondary..... FC-5507 Fuel Filter..... F-5505 Hydraulic Oil Filter..... H-5504 Hydraulic Oil Filter..... H-55270 Oil Filter Full Flow..... C-5510		D5H LGP (DOZERS) S/N: 85C1-UP Air Filter Set..... A-5522-S Air Filter Primary..... A-5509 Air Filter Secondary..... A-5522 Fuel Filter Secondary..... FC-5507 Fuel Filter..... F-5505 Oil Filter Full Flow..... C-5510	
D5H (DOZERS) S/N: 9HC4000-UP Air Filter Primary..... A-5549 Air Filter Primary..... A-5549M		D5H LGP (DOZERS) S/N: 1YD1-UP Air Filter Primary..... A-5509 Air Filter Secondary..... A-5522 Air Filter Set..... A-5522-S Fuel Filter..... F-5505 Fuel Filter Secondary..... FC-5507 Hydraulic Oil Filter..... H-55270		D5H LGP (DOZERS) S/N: 9HC1-3999 Air Filter Primary..... A-5509 Air Filter Secondary..... A-5522 Air Filter Set..... A-5522-S Fuel Filter Secondary..... FC-5507 Fuel Filter..... F-5505 Hydraulic Oil Filter..... H-5504 Hydraulic Oil Filter..... H-55270 Oil Filter Full Flow..... C-5510	

MODEL/APPLICATION	SAKURA NO	MODEL/APPLICATION	SAKURA NO	MODEL/APPLICATION	SAKURA NO
CATERPILLAR		CATERPILLAR		CATERPILLAR	
D5H LGP (DOZERS) S/N: 9HC1-3999		D5H SERIES II (DOZERS) CAT (S/N: 12Z39000-46243)		Hydraulic Oil Filter..... H-5504 Hydraulic Oil Filter..... H-55270	
D5H LGP SERIES II (DOZERS) S/N: 1DD4000-UP		Fuel Filter..... FC-5501 Fuel Filter Secondary..... FC-5507 Fuel Filter..... FC-5523 Oil Filter Full Flow..... C-5510		D5H SERIES II (DOZERS) S/N: 9HC5500-5518	
Air Filter Secondary..... A-5522 Air Filter Set..... A-5522-S Air Filter Primary..... A-5509 Fuel Filter Secondary..... FC-5507 Fuel Filter..... F-5505 Hydraulic Oil Filter..... H-55270 Hydraulic Oil Filter..... H-5504 Oil Filter Full Flow..... C-5510		D5H SERIES II (DOZERS) CAT (S/N: 12Z46244-UP)		Air Filter Secondary..... A-5522 Air Filter Set..... A-5522-S Air Filter Primary..... A-5509 Hydraulic Oil Filter..... H-5504 Hydraulic Oil Filter..... H-5510 Hydraulic Oil Filter..... H-55270	
D5H LGP SERIES II (DOZERS) S/N: 2SD4079-UP		Fuel Filter Secondary..... FC-5507 Fuel Filter..... F-5505 Hydraulic Oil Filter..... H-55270 Hydraulic Oil Filter..... H-5504 Hydraulic Oil Filter..... H-5510		D5H SERIES II (DOZERS) S/N: 9HC5519-UP	
Air Filter Primary..... A-5509 Air Filter Set..... A-5522-S Air Filter Secondary..... A-5522 Fuel Filter..... F-5505 Fuel Filter Secondary..... FC-5507 Hydraulic Oil Filter..... H-55270 Hydraulic Oil Filter..... H-5504 Hydraulic Oil Filter..... H-5510		D5H SERIES II (DOZERS) S/N: 1DD1-5759		Air Filter Set..... A-5549M-S Air Filter Primary..... A-5549 Air Filter Primary..... A-5549M Air Filter Secondary..... A-5550 Hydraulic Oil Filter..... H-55270 Hydraulic Oil Filter..... H-5510 Hydraulic Oil Filter..... H-5504	
D5H LGP SERIES II (DOZERS) S/N: 3MD4026-UP		Air Filter Set..... A-5522-S Air Filter Primary..... A-5509 Fuel Filter..... F-5505 Fuel Filter Secondary..... FC-5507 Hydraulic Oil Filter..... H-55270 Hydraulic Oil Filter..... H-5510 Hydraulic Oil Filter..... H-5504		D5H TSK (SKIDDERS) S/N: 7EG1-UP	
Air Filter Secondary..... A-5522 Air Filter Set..... A-5522-S Air Filter Primary..... A-5509 Fuel Filter..... F-5505 Fuel Filter Secondary..... FC-5507 Hydraulic Oil Filter..... H-55270 Hydraulic Oil Filter..... H-5504 Hydraulic Oil Filter..... H-5510		D5H SERIES II (DOZERS) S/N: 1DD5760-UP		Air Filter Primary..... A-5509 Air Filter Set..... A-5522-S Air Filter Secondary..... A-5522 Fuel Filter..... F-5505 Hydraulic Oil Filter..... H-5510 Oil Filter Full Flow..... C-5510	
D5H LGP SERIES II (DOZERS) S/N: 4KD4070-UP		Air Filter Primary..... A-5549 Air Filter Secondary..... A-5549M Hydraulic Oil Filter..... H-5504 Hydraulic Oil Filter..... H-5510		D5H XL (DOZERS) CAT 3304	
Air Filter Secondary..... A-5522 Air Filter Set..... A-5522-S Air Filter Primary..... A-5509 Fuel Filter..... F-5505 Fuel Filter Secondary..... FC-5507 Hydraulic Oil Filter..... H-55270 Hydraulic Oil Filter..... H-5510 Hydraulic Oil Filter..... H-5504		D5H SERIES II (DOZERS) S/N: 2EJ1-UP		Cabin Air Filter..... CA-55140	
Air Filter Secondary..... A-5522 Air Filter Set..... A-5522-S Air Filter Primary..... A-5509 Fuel Filter..... F-5505 Fuel Filter Secondary..... FC-5507 Hydraulic Oil Filter..... H-55270 Hydraulic Oil Filter..... H-5510 Hydraulic Oil Filter..... H-5504		D5H SERIES II (DOZERS) S/N: 8RC1-5846		D5H XL (DOZERS) S/N: 8RJ1-UP	
Air Filter Secondary..... A-5522 Air Filter Set..... A-5522-S Air Filter Primary..... A-5509 Fuel Filter..... F-5505 Fuel Filter Secondary..... FC-5507 Hydraulic Oil Filter..... H-55270 Hydraulic Oil Filter..... H-5510 Hydraulic Oil Filter..... H-5504		Air Filter Set..... A-5522-S Air Filter Primary..... A-5509 Air Filter Secondary..... A-5522 Hydraulic Oil Filter..... H-5510 Hydraulic Oil Filter..... H-5504		Air Filter Primary..... A-5549M Air Filter Primary..... A-5549 Air Filter Set..... A-5549M-S Air Filter Secondary..... A-5550 Fuel Filter Secondary..... FC-5507 Fuel Filter..... F-5505 Hydraulic Oil Filter..... H-5504 Hydraulic Oil Filter..... H-55270 Oil Filter Full Flow..... C-5510	
D5H LGP SERIES II (DOZERS) S/N: 9HC4000-UP		D5H SERIES II (DOZERS) S/N: 8RC5847-UP		Oil Filter Full Flow..... C-5510	
Air Filter Primary..... A-5549M Air Filter Secondary..... A-5550 Air Filter Set..... A-5549M-S Air Filter Primary..... A-5549 Fuel Filter..... F-5505 Fuel Filter Secondary..... FC-5507 Hydraulic Oil Filter..... H-5504 Hydraulic Oil Filter..... H-55270 Oil Filter Full Flow..... C-5510		Air Filter Secondary..... A-5550 Air Filter Primary..... A-5549M Air Filter Set..... A-5549M-S Air Filter Primary..... A-5549 Hydraulic Oil Filter..... H-5510 Hydraulic Oil Filter..... H-5504		D5K (DOZERS) CAT S/N: C4E50-UP , 2005-UP	
D5H LGP SERIES II (DOZERS) S/N: 9HC1-5499		D5H SERIES II (DOZERS) S/N: 8RJ1-UP		Oil Filter Full Flow..... C-5102	
Air Filter Secondary..... A-5522 Air Filter Set..... A-5522-S Air Filter Primary..... A-5509 Fuel Filter..... F-5505 Fuel Filter Secondary..... FC-5507 Hydraulic Oil Filter..... H-55270 Hydraulic Oil Filter..... H-5504 Oil Filter Full Flow..... C-5510		Air Filter Primary..... A-5549 Air Filter Set..... A-5549M-S Air Filter Primary..... A-5549M Air Filter Secondary..... A-5550 Hydraulic Oil Filter..... H-5510 Hydraulic Oil Filter..... H-5504		D5K (DOZERS) CAT S/N: JLF1-UP , 2005-UP	
D5H SERIES II (DOZERS) CAT (S/N: 12Z10967-38999)		D5H SERIES II (DOZERS) S/N: 9HC1-5499		Oil Filter Full Flow..... C-5102	
Oil Filter Full Flow..... C-5510		Air Filter Secondary..... A-5522 Air Filter Set..... A-5522-S Air Filter Primary..... A-5509 Hydraulic Oil Filter..... H-5510		D5K (DOZERS) CAT S/N: WW1-UP , 2005-UP	
				Oil Filter Full Flow..... C-5102	
				D5K (DOZERS) CAT S/N: C4E1-49-UP , 2004-UP	
				Oil Filter Full Flow..... C-5102	

Sakura Filter

ENGINE APPLICATION

MODEL/APPLICATION	SAKURA NO
CATERPILLAR	
D5K (DOZERS) CAT S/N: JLF1-UP , 2004-UP Oil Filter Full Flow.....	C-5102
D5K (DOZERS) CAT S/N: WWM1-UP , 2004-UP Oil Filter Full Flow.....	C-5102
D5K (DOZERS) CAT S/N: YYY1-UP , 2004-UP Oil Filter Full Flow.....	C-5102
DSM (DOZERS) CAT (S/N: 4TF23390-28928) Fuel Filter..... Oil Filter Full Flow.....	FC-5508 C-5522
DSM (DOZERS) CAT (S/N: 4TF28929-29016) Fuel Filter Secondary..... Fuel Filter Secondary..... Fuel Filter..... Fuel Filter..... Oil Filter Full Flow.....	FC-55151 FC-5515 FC-5508 FC-5516 C-5522
DSM (DOZERS) CAT (S/N: 4TF29017-UP) Fuel Filter Secondary..... Fuel Filter Secondary..... Fuel Filter..... Oil Filter Full Flow.....	FC-55151 FC-5515 FC-5516 C-5522
DSM (DOZERS) S/N: 3CR1033-UP Air Filter Primary..... Air Filter Set..... Air Filter Secondary..... Hydraulic Oil Filter..... Hydraulic Oil Filter..... Hydraulic Oil Filter..... Hydraulic Oil Filter.....	A-5566 A-5568-S A-5567 H-5526 H-55270 H-55280 H-5504
DSM (DOZERS) S/N: 3CR1-1032 Air Filter Primary..... Air Filter Set..... Air Filter Secondary..... Hydraulic Oil Filter.....	A-5566 A-5568-S A-5567 H-55270
DSM (DOZERS) S/N: 3CR1-UP Air Filter Primary..... Air Filter Set..... Air Filter Secondary..... Fuel Filter Secondary..... Fuel Filter Secondary..... Fuel Filter..... Fuel Filter..... Hydraulic Oil Filter..... Hydraulic Oil Filter..... Hydraulic Oil Filter..... Oil Filter Full Flow.....	A-5566 A-5568-S A-5567 FC-5515 FC-55151 FC-5516 FC-5508 H-5526 H-5504 H-55270 C-5510
DSM (DOZERS) S/N: 3DR1-423 Air Filter Primary.....	A-5566

MODEL/APPLICATION	SAKURA NO
CATERPILLAR	
Air Filter Secondary..... Air Filter Set..... Hydraulic Oil Filter.....	A-5567 A-5568-S H-55270
DSM (DOZERS) S/N: 3DR424-UP Air Filter Set..... Air Filter Primary..... Air Filter Secondary..... Hydraulic Oil Filter..... Hydraulic Oil Filter..... Hydraulic Oil Filter..... Hydraulic Oil Filter.....	A-5568-S A-5566 A-5567 H-55280 H-5504 H-55270 H-5526
DSM (DOZERS) S/N: 4BR1-532 Air Filter Set..... Air Filter Secondary..... Air Filter Primary..... Hydraulic Oil Filter.....	A-5568-S A-5567 A-5566 H-55270
DSM (DOZERS) S/N: 4BR1-UP Air Filter Primary..... Air Filter Set..... Air Filter Secondary..... Fuel Filter..... Fuel Filter..... Fuel Filter Secondary..... Fuel Filter Secondary..... Hydraulic Oil Filter..... Hydraulic Oil Filter..... Hydraulic Oil Filter..... Oil Filter Full Flow.....	A-5566 A-5568-S A-5567 FC-5516 FC-5508 FC-55151 FC-5515 H-55270 H-5526 H-5504 C-5510
DSM (DOZERS) S/N: 4BR533-UP Air Filter Secondary..... Air Filter Primary..... Air Filter Set..... Hydraulic Oil Filter..... Hydraulic Oil Filter..... Hydraulic Oil Filter..... Hydraulic Oil Filter..... Hydraulic Oil Filter.....	A-5567 A-5566 A-5568-S H-5504 H-5526 H-55280 H-55270
DSM (DOZERS) S/N: 6DR1-UP Air Filter Set..... Air Filter Secondary..... Air Filter Primary..... Fuel Filter Secondary..... Fuel Filter Secondary..... Fuel Filter..... Fuel Filter..... Hydraulic Oil Filter..... Hydraulic Oil Filter..... Hydraulic Oil Filter..... Oil Filter Full Flow.....	A-5568-S A-5567 A-5566 FC-5515 FC-55151 FC-5516 FC-5508 H-5504 H-55270 H-5526 C-5510
DSM (DOZERS) S/N: 6GN1-1334 Air Filter Primary..... Air Filter Set..... Air Filter Secondary.....	A-5566 A-5568-S A-5567

MODEL/APPLICATION	SAKURA NO
CATERPILLAR	
Hydraulic Oil Filter.....	H-55270
DSM (DOZERS) S/N: 6GN1335-UP Air Filter Secondary..... Air Filter Primary..... Air Filter Set..... Hydraulic Oil Filter..... Hydraulic Oil Filter..... Hydraulic Oil Filter.....	A-5567 A-5566 A-5568-S H-5504 H-55280 H-55270 H-5526
DSM (DOZERS) S/N: 6GN1-UP Air Filter Secondary..... Air Filter Set..... Air Filter Primary..... Fuel Filter Secondary..... Fuel Filter Secondary..... Fuel Filter..... Fuel Filter..... Hydraulic Oil Filter..... Hydraulic Oil Filter..... Hydraulic Oil Filter..... Oil Filter Full Flow.....	A-5567 A-5568-S A-5566 FC-55151 FC-5515 FC-5508 FC-5516 H-5526 H-55270 H-5504 C-5510
DSM LGP (DOZERS) CAT 3116 Cabin Air Filter.....	CA-55140
DSM LGP (DOZERS) S/N: 4J51-UP Air Filter Secondary..... Air Filter Set..... Air Filter Primary..... Fuel Filter Secondary..... Fuel Filter Secondary..... Fuel Filter..... Hydraulic Oil Filter..... Hydraulic Oil Filter..... Hydraulic Oil Filter..... Hydraulic Oil Filter..... Oil Filter Full Flow.....	A-5567 A-5568-S A-5566 FC-5515 FC-55151 FC-5516 HC-55220 HC-5507 H-5504 H-55270 C-5510
DSM LGP (DOZERS) S/N: 5E51-UP Air Filter Primary..... Air Filter Secondary..... Air Filter Set..... Fuel Filter Secondary..... Fuel Filter Secondary..... Fuel Filter..... Hydraulic Oil Filter..... Hydraulic Oil Filter..... Hydraulic Oil Filter..... Hydraulic Oil Filter..... Oil Filter Full Flow.....	A-5566 A-5567 A-5568-S FC-5515 FC-55151 FC-5516 H-5001 H-55270 H-5526 H-5504 C-5510
DSM LGP (DOZERS) S/N: 5F51-UP Air Filter Primary..... Air Filter Secondary..... Air Filter Set..... Fuel Filter Secondary..... Fuel Filter Secondary.....	A-5566 A-5567 A-5568-S FC-5515 FC-55151

MODEL/APPLICATION	SAKURA NO
CATERPILLAR	
DSM LGP (DOZERS) S/N: 5FS1-UP	
Fuel Filter.....	FC-5516
Hydraulic Oil Filter.....	H-5504
Hydraulic Oil Filter.....	H-55270
Hydraulic Oil Filter.....	HC-55220
Hydraulic Oil Filter.....	HC-5507
Oil Filter Full Flow.....	C-5510
DSM LGP (DOZERS) S/N: 6AS1-UP	
Air Filter Secondary.....	A-5567
Air Filter Set.....	A-5568-S
Air Filter Primary.....	A-5566
Fuel Filter.....	FC-5516
Fuel Filter Secondary.....	FC-55151
Fuel Filter Secondary.....	FC-5515
Hydraulic Oil Filter.....	H-5526
Hydraulic Oil Filter.....	H-5504
Hydraulic Oil Filter.....	H-55270
Oil Filter Full Flow.....	C-5510
DSM LGP (DOZERS) S/N: 6GN1-UP	
Air Filter Primary.....	A-5566
Air Filter Secondary.....	A-5567
Air Filter Set.....	A-5568-S
Fuel Filter.....	FC-5508
Fuel Filter Secondary.....	FC-5515
Fuel Filter.....	FC-5516
Fuel Filter Secondary.....	FC-55151
Hydraulic Oil Filter.....	H-55270
Hydraulic Oil Filter.....	H-5526
Hydraulic Oil Filter.....	H-5504
Oil Filter Full Flow.....	C-5510
DSM LGPXL (DOZERS) CAT 3116	
Air Filter Secondary.....	A-5567
Air Filter Set.....	A-5568-S
Air Filter Primary.....	A-5566
Fuel Filter.....	FC-5516
Fuel Filter.....	FC-5508
Fuel Filter Secondary.....	FC-5515
Fuel Filter Secondary.....	FC-55151
Hydraulic Oil Filter.....	HC-5507
Hydraulic Oil Filter.....	H-5504
Oil Filter Full Flow.....	C-5510
DSM XL (DOZERS) CAT 3116	
Cabin Air Filter.....	CA-55140
DSM XL (DOZERS) S/N: 4JS1-UP	
Air Filter Set.....	A-5568-S
Air Filter Secondary.....	A-5567
Air Filter Primary.....	A-5566
Fuel Filter Secondary.....	FC-5515
Fuel Filter Secondary.....	FC-55151
Fuel Filter.....	FC-5516
Hydraulic Oil Filter.....	H-55270
Hydraulic Oil Filter.....	H-5504

MODEL/APPLICATION	SAKURA NO
CATERPILLAR	
Hydraulic Oil Filter.....	HC-55220
Hydraulic Oil Filter.....	HC-5507
Oil Filter Full Flow.....	C-5510
DSM XL (DOZERS) S/N: 5ES1-UP	
Air Filter Set.....	A-5568-S
Air Filter Secondary.....	A-5567
Air Filter Primary.....	A-5566
Fuel Filter Secondary.....	FC-5515
Fuel Filter.....	FC-5516
Fuel Filter Secondary.....	FC-55151
Hydraulic Oil Filter.....	H-5504
Hydraulic Oil Filter.....	H-55270
Hydraulic Oil Filter.....	H-5526
Oil Filter Full Flow.....	C-5510
DSM XL (DOZERS) S/N: 5FS1-UP	
Air Filter Secondary.....	A-5567
Air Filter Primary.....	A-5566
Air Filter Set.....	A-5568-S
Fuel Filter.....	FC-5516
Fuel Filter Secondary.....	FC-5515
Fuel Filter Secondary.....	FC-55151
Hydraulic Oil Filter.....	H-55270
Hydraulic Oil Filter.....	H-5526
Hydraulic Oil Filter.....	HC-5507
Hydraulic Oil Filter.....	H-5504
Hydraulic Oil Filter.....	HC-55220
Oil Filter Full Flow.....	C-5510
DSM XL (DOZERS) S/N: 6AS1-UP	
Air Filter Set.....	A-5568-S
Air Filter Secondary.....	A-5567
Air Filter Primary.....	A-5566
Fuel Filter Secondary.....	FC-5515
Fuel Filter.....	FC-5516
Fuel Filter Secondary.....	FC-55151
Hydraulic Oil Filter.....	H-55270
Hydraulic Oil Filter.....	H-5504
Hydraulic Oil Filter.....	H-5526
Oil Filter Full Flow.....	C-5510
DSN (DOZERS) CAT (S/N: BMA1-UP)	
Fuel Filter.....	FC-5517
Oil Filter Full Flow.....	C-5522
DSN (DOZERS) S/N: AGG1-195-UP	
Air Filter.....	A-5547
Air Filter Primary.....	A-5558
Air Filter Secondary.....	A-5550
Hydraulic Oil Filter.....	H-55280
Hydraulic Oil Filter.....	H-5510
Hydraulic Oil Filter.....	HC-55220
Hydraulic Oil Filter.....	HC-5507
Hydraulic Oil Filter.....	H-5526
Hydraulic Oil Filter.....	H-55280
Hydraulic Oil Filter.....	H-5510
DSN (DOZERS) S/N: AGG196-331-UP	
Air Filter Secondary.....	A-5550
Air Filter Primary.....	A-5549
Air Filter Set.....	A-5549M-S

MODEL/APPLICATION	SAKURA NO
CATERPILLAR	
Air Filter Primary.....	A-5549M
Air Filter.....	A-5547
Hydraulic Oil Filter.....	H-5526
Hydraulic Oil Filter.....	H-5510
Hydraulic Oil Filter.....	HC-55220
Hydraulic Oil Filter.....	HC-5507
DSN (DOZERS) S/N: AGG332-UP	
Air Filter Set.....	A-5549M-S
Air Filter.....	A-5547
Air Filter Primary.....	A-5549
Air Filter Secondary.....	A-5550
Air Filter Primary.....	A-5549M
Hydraulic Oil Filter.....	H-55280
Hydraulic Oil Filter.....	H-5510
Hydraulic Oil Filter.....	H-5526
DSN (DOZERS) S/N: AKD1-315-UP	
Air Filter Primary.....	A-5558
Air Filter Secondary.....	A-5550
Air Filter.....	A-5547
Hydraulic Oil Filter.....	H-55280
Hydraulic Oil Filter.....	H-5510
Hydraulic Oil Filter.....	HC-55220
Hydraulic Oil Filter.....	H-5526
Hydraulic Oil Filter.....	HC-5507
DSN (DOZERS) S/N: AKD316-411-UP	
Air Filter Primary.....	A-5549
Air Filter Primary.....	A-5549M
Air Filter Secondary.....	A-5550
Air Filter Set.....	A-5549M-S
Air Filter.....	A-5547
Hydraulic Oil Filter.....	HC-55220
Hydraulic Oil Filter.....	HC-5507
Hydraulic Oil Filter.....	H-5510
Hydraulic Oil Filter.....	H-5526
DSN (DOZERS) S/N: AKD412-UP	
Air Filter Primary.....	A-5549M
Air Filter Primary.....	A-5549
Air Filter.....	A-5547
Air Filter Secondary.....	A-5550
Air Filter Set.....	A-5549M-S
Hydraulic Oil Filter.....	H-5526
Hydraulic Oil Filter.....	H-55280
Hydraulic Oil Filter.....	H-5510
DSN (DOZERS) w/3126B Eng.	
Hydraulic Oil Filter.....	HC-55280
DSN LGP (DOZERS) CAT 3126B	
Fuel Filter.....	EF-55050
DSN XL (DOZERS) CAT 3126B	
Fuel Filter.....	EF-55050

Sakura Filter

ENGINE APPLICATION

MODEL/APPLICATION	SAKURA NO	MODEL/APPLICATION	SAKURA NO	MODEL/APPLICATION	SAKURA NO
CATERPILLAR		CATERPILLAR		CATERPILLAR	
D5R LGP (DOZERS) w/C6.6 Eng. Fuel/Water Separator.....	SFC-55170	Hydraulic Oil Filter..... Oil Filter Full Flow.....	H-5502 C-5510	Oil Filter Full Flow.....	0-5502
D5R XL (DOZERS) w/C6.6 Eng. Fuel/Water Separator.....	SFC-55170	D6 (DOZERS) S/N: 74A1-1751 Air Filter Primary..... Air Filter Primary..... Air Filter Secondary..... Air Filter Set..... Air Filter Set..... Air Filter Secondary..... Air Filter Primary..... Air Filter Secondary..... Fuel Filter..... Hydraulic Oil Filter..... Oil Filter Full Flow.....	A-5549M A-5549 A-5550 A-5549M-S A-5522-S A-5510 A-5509 A-5509 F-5501 H-5504 0-5502	D6B (DOZERS) S/N: 44A1-UP Air Filter Primary..... Air Filter Set..... Air Filter Set..... Air Filter Set..... Air Filter Primary..... Air Filter Secondary..... Air Filter Secondary..... Fuel Filter..... Hydraulic Oil Filter..... Oil Filter Full Flow.....	A-5566 A-5568-S A-5507-S A-55071-S A-5507 A-5508 A-5567 F-5501 H-5504 0-5502
D5 TURBO (DOZERS) Air Filter Set..... Air Filter Secondary..... Air Filter Set..... Air Filter Set..... Air Filter Primary..... Air Filter Secondary..... Air Filter Primary..... Fuel Filter..... Fuel Filter..... Fuel Filter Secondary..... Fuel Filter..... Hydraulic Oil Filter..... Oil Filter Full Flow..... Oil Filter Full Flow.....	A-5507-S A-5510 A-55071-S A-5522-S A-5507 A-5508 A-5509 FC-5523 F-5501 FC-5507 FC-5501 H-5504 C-5510 0-5502	D6 (DOZERS) S/N: 75M1-UP Air Filter Primary..... Air Filter Secondary..... Air Filter Secondary..... Air Filter Primary..... Air Filter Set..... Hydraulic Oil Filter..... Hydraulic Oil Filter..... Oil Filter Full Flow.....	A-5501 A-5534 A-5502 A-5535 A-5573-S H-5503 H-5502 C-5510	D6B (DOZERS) S/N: 56A1-UP Air Filter Primary..... Air Filter Set..... Air Filter Set..... Air Filter Set..... Air Filter Primary..... Air Filter Secondary..... Air Filter Secondary..... Fuel Filter..... Hydraulic Oil Filter..... Oil Filter Full Flow.....	A-5566 A-5568-S A-55071-S A-5507-S A-5507 A-5567 A-5508 F-5501 H-5504 0-5502
D6 (DOZERS) CAT 3306 Fuel Filter.....	F-5503	D6 (DOZERS) S/N: 76A1-2891 Air Filter Primary..... Air Filter Set..... Air Filter Primary..... Air Filter Secondary..... Air Filter Secondary..... Air Filter Primary..... Air Filter Set..... Hydraulic Oil Filter..... Hydraulic Oil Filter..... Oil Filter Full Flow.....	A-5503 A-5549 A-5522-S A-5509 A-5550 A-5510 A-5549M A-5549M-S F-5501 H-5504 0-5502	D6B (DOZERS) S/N: 57A1-UP Air Filter Primary..... Air Filter Set..... Air Filter Set..... Air Filter Set..... Air Filter Secondary..... Air Filter Secondary..... Air Filter Secondary..... Air Filter Primary..... Fuel Filter..... Hydraulic Oil Filter..... Oil Filter Full Flow.....	A-5566 A-5507-S A-55071-S A-5568-S A-5508 A-5567 A-5507 F-5501 H-5504 0-5502
D6 (DOZERS) S/N: 10K2691-UP Air Filter Secondary..... Air Filter Secondary..... Air Filter Set..... Air Filter Primary..... Air Filter Primary..... Hydraulic Oil Filter..... Oil Filter Full Flow.....	A-5502 A-5534 A-5573-S A-5501 A-5535 H-5503 C-5510	D6 (DOZERS) S/N: 8U1-UP Oil Filter Full Flow.....	0-5501	D6C (DOZERS) S/N: 10K11940-UP Air Filter Secondary..... Air Filter Primary..... Air Filter Primary..... Air Filter Secondary..... Air Filter Set..... Fuel Filter Secondary..... Hydraulic Oil Filter..... Hydraulic Oil Filter..... Oil Filter Full Flow.....	A-5502 A-5501 A-5535 A-5534 A-5573-S FC-5507 H-5503 H-5502 C-5510
D6 (DOZERS) S/N: 1Y1-UP Air Filter Secondary..... Air Filter Primary..... Air Filter Set..... Air Filter Primary..... Air Filter Primary..... Air Filter Set..... Air Filter Set..... Air Filter Secondary..... Hydraulic Oil Filter..... Oil Filter Full Flow..... Oil Filter Full Flow.....	A-5550 A-5549 A-5549M-S A-5549M A-5509 A-5522-S A-5510 H-5503 0-5502 C-5510	D6 (DOZERS) S/N: 9911593-UP Air Filter Primary..... Air Filter Set..... Air Filter Primary..... Air Filter Secondary..... Air Filter Secondary..... Hydraulic Oil Filter..... Oil Filter Full Flow.....	A-5501 A-5573-S A-5535 A-5502 A-5534 H-5503 C-5510	D6C (DOZERS) S/N: 10K1-5984 Air Filter Secondary..... Air Filter Primary..... Air Filter Primary..... Air Filter Secondary..... Air Filter Set..... Air Filter Set..... Air Filter Secondary..... Air Filter Primary..... Fuel Filter Secondary..... Hydraulic Oil Filter.....	A-5550 A-5549 A-5549M A-5522-S A-5510 A-5509 FC-5507 H-5503
D6 (DOZERS) S/N: 33X1-UP Air Filter Primary..... Air Filter Secondary..... Air Filter Set..... Air Filter Primary..... Air Filter Secondary..... Hydraulic Oil Filter.....	A-5501 A-5534 A-5573-S A-5535 A-5502 H-5503	D6B (DOZERS) S/N: 37A1-UP Air Filter Primary..... Air Filter Primary..... Air Filter Secondary..... Air Filter Set..... Air Filter Set..... Air Filter Set..... Air Filter Set..... Air Filter Secondary..... Fuel Filter..... Hydraulic Oil Filter.....	A-5507 A-5566 A-5508 A-5507-S A-5568-S A-55071-S A-5567 A-5509 F-5501 H-5504		

Sakura Filter

ENGINE APPLICATION

MODEL/APPLICATION	SAKURA NO	MODEL/APPLICATION	SAKURA NO	MODEL/APPLICATION	SAKURA NO
CATERPILLAR		CATERPILLAR		CATERPILLAR	
D6C (DOZERS) S/N: 10K1-5984 Oil Filter Full Flow..... 0-5502		Air Filter Secondary..... A-5502 Air Filter Primary..... A-5501 Fuel Filter Secondary..... FC-5507 Hydraulic Oil Filter..... H-5503 Oil Filter Full Flow..... C-5510		D6C (DOZERS) S/N: 74A1752-UP Air Filter Primary..... A-5549 Air Filter Secondary..... A-5550 Air Filter Set..... A-5549M-S Air Filter Primary..... A-5509 Air Filter Set..... A-5522-S Air Filter Primary..... A-5549M Air Filter Secondary..... A-5510 Fuel Filter..... F-5501 Hydraulic Oil Filter..... H-5503 Oil Filter Full Flow..... 0-5502	
D6C (DOZERS) S/N: 10K5985-6290 Air Filter Secondary..... A-5502 Air Filter Primary..... A-5501 Air Filter Primary..... A-5535 Air Filter Set..... A-5573-S Air Filter Secondary..... A-5534 Fuel Filter Secondary..... FC-5507 Hydraulic Oil Filter..... H-5503 Oil Filter Full Flow..... 0-5502		D6C (DOZERS) S/N: 4X-UP Air Filter Primary..... A-5501 Air Filter Secondary..... A-5534 Air Filter Secondary..... A-5502 Air Filter Set..... A-5573-S Air Filter Primary..... A-5535 Fuel Filter Secondary..... FC-5507 Hydraulic Oil Filter..... H-5503 Oil Filter Full Flow..... C-5510		D6C (DOZERS) S/N: 76A1-2891 Air Filter Set..... A-5522-S Air Filter Set..... A-5549M-S Air Filter Primary..... A-5509 Air Filter Secondary..... A-5510 Air Filter Primary..... A-5549M Air Filter Secondary..... A-5550 Air Filter Primary..... A-5549 Fuel Filter..... F-5501 Hydraulic Oil Filter..... H-5504 Oil Filter Full Flow..... 0-5502	
D6C (DOZERS) S/N: 10K5985-7952 Air Filter Secondary..... A-5550 Air Filter Primary..... A-5549 Air Filter Set..... A-5549M-S Air Filter Secondary..... A-5502 Air Filter Primary..... A-5501 Air Filter Primary..... A-5549M Fuel Filter Secondary..... FC-5507 Hydraulic Oil Filter..... H-5503 Oil Filter Full Flow..... C-5510		D6C (DOZERS) S/N: 5X-UP Air Filter Primary..... A-5535 Air Filter Secondary..... A-5534 Air Filter Set..... A-5573-S Air Filter Primary..... A-5501 Air Filter Secondary..... A-5502 Fuel Filter Secondary..... FC-5507 Hydraulic Oil Filter..... H-5503 Oil Filter Full Flow..... C-5510		D6C (DOZERS) S/N: 76A2892-UP Air Filter Secondary..... A-5510 Air Filter Secondary..... A-5550 Air Filter Primary..... A-5549 Air Filter Set..... A-5549M-S Air Filter Primary..... A-5509 Air Filter Set..... A-5522-S Air Filter Primary..... A-5549M Fuel Filter..... F-5501 Hydraulic Oil Filter..... H-5503 Oil Filter Full Flow..... 0-5502	
D6C (DOZERS) S/N: 10K7953-11939 Air Filter Set..... A-5573-S Air Filter Primary..... A-5535 Air Filter Secondary..... A-5534 Air Filter Primary..... A-5501 Hydraulic Oil Filter..... H-5503 Oil Filter Full Flow..... C-5510		D6C (DOZERS) S/N: 69U1-UP Air Filter Primary..... A-5501 Air Filter Secondary..... A-5534 Air Filter Secondary..... A-5502 Air Filter Primary..... A-5535 Air Filter Set..... A-5573-S Fuel Filter Secondary..... FC-5507 Hydraulic Oil Filter..... H-5503 Oil Filter Full Flow..... C-5510		D6C (DOZERS) S/N: 82A1-UP Hydraulic Oil Filter..... H-5502	
D6C (DOZERS) S/N: 17R1284-UP Air Filter Secondary..... A-5510 Air Filter Primary..... A-5509 Air Filter Set..... A-5522-S Fuel Filter Secondary..... FC-5507 Hydraulic Oil Filter..... H-5503 Oil Filter Full Flow..... C-5510 Oil Filter Full Flow..... 0-5501		D6C (DOZERS) S/N: 6X-UP Air Filter Primary..... A-5501 Air Filter Secondary..... A-5502 Air Filter Secondary..... A-5534 Air Filter Primary..... A-5535 Air Filter Set..... A-5573-S Fuel Filter Secondary..... FC-5507 Hydraulic Oil Filter..... H-5503 Oil Filter Full Flow..... C-5510		D6C (DOZERS) S/N: 99J1-1550 Air Filter Primary..... A-5549 Air Filter Set..... A-5549M-S Air Filter Secondary..... A-5510 Air Filter Set..... A-5522-S Air Filter Primary..... A-5509 Air Filter Secondary..... A-5550 Air Filter Primary..... A-5549M Fuel Filter Secondary..... FC-5507 Hydraulic Oil Filter..... H-5503 Oil Filter Full Flow..... 0-5502	
D6C (DOZERS) S/N: 17R465-1283 Air Filter Primary..... A-5549 Air Filter Secondary..... A-5510 Air Filter Primary..... A-5549M Air Filter Primary..... A-5509 Air Filter Set..... A-5549M-S Air Filter Set..... A-5522-S Air Filter Secondary..... A-5550 Fuel Filter Secondary..... FC-5507 Hydraulic Oil Filter..... H-5503 Oil Filter Full Flow..... C-5510		D6C (DOZERS) S/N: 74A1-1751 Air Filter Secondary..... A-5510 Air Filter Secondary..... A-5550 Air Filter Set..... A-5522-S Air Filter Primary..... A-5549M Air Filter Primary..... A-5549 Air Filter Set..... A-5549M-S Air Filter Primary..... A-5509 Fuel Filter..... F-5501 Hydraulic Oil Filter..... H-5504 Oil Filter Full Flow..... 0-5502		D6C (DOZERS) S/N: 99J1551-1592 Air Filter Secondary..... A-5502 Air Filter Secondary..... A-5534 Air Filter Primary..... A-5535 Air Filter Set..... A-5573-S Air Filter Primary..... A-5501	
D6C (DOZERS) S/N: 3X-UP Air Filter Primary..... A-5535 Air Filter Set..... A-5573-S Air Filter Secondary..... A-5534					

MODEL/APPLICATION	SAKURA NO	MODEL/APPLICATION	SAKURA NO	MODEL/APPLICATION	SAKURA NO
CATERPILLAR		CATERPILLAR		CATERPILLAR	
D6C (DOZERS) S/N: 99J1551-1592		Air Filter Secondary.....	A-5502	Hydraulic Oil Filter.....	H-5502
Fuel Filter Secondary.....	FC-5507	Fuel Filter Secondary.....	FC-5507	Oil Filter Full Flow.....	C-5510
Hydraulic Oil Filter.....	H-5503	Hydraulic Oil Filter.....	H-5502		
Oil Filter Full Flow.....	0-5502	Hydraulic Oil Filter.....	H-5503		
		Oil Filter Full Flow.....	C-5510		
D6C (DOZERS) S/N: 99J1593-1753		D6D (DOZERS) S/N: 1Y460-UP		D6D (DOZERS) S/N: 32X1-1179	
Air Filter Set.....	A-5573-S	Air Filter Primary.....	A-5549	Air Filter Primary.....	A-5535
Air Filter Primary.....	A-5535	Air Filter Set.....	A-5522-S	Air Filter Set.....	A-5573-S
Air Filter Secondary.....	A-5502	Air Filter Primary.....	A-5509	Air Filter Secondary.....	A-5534
Air Filter Secondary.....	A-5534	Air Filter Secondary.....	A-5510		
Air Filter Primary.....	A-5501	Air Filter Set.....	A-5549M-S		
Fuel Filter Secondary.....	FC-5507	Air Filter Secondary.....	A-5550		
Hydraulic Oil Filter.....	H-5503	Air Filter Primary.....	A-5549M		
Oil Filter Full Flow.....	C-5510	Fuel Filter Secondary.....	FC-5507		
		Hydraulic Oil Filter.....	H-5503		
D6C (DOZERS) S/N: 99J1754-2534		Oil Filter Full Flow.....	C-5510	D6D (DOZERS) S/N: 32X1181-UP	
Air Filter Secondary.....	A-5502			Air Filter Set.....	A-5573-S
Air Filter Primary.....	A-5501	D6D (DOZERS) S/N: 20X3042-UP		Air Filter Secondary.....	A-5534
Air Filter Secondary.....	A-5534	Air Filter Secondary.....	A-5502	Air Filter Secondary.....	A-5502
Air Filter Set.....	A-5573-S	Air Filter Primary.....	A-5501	Fuel Filter Secondary.....	FC-5507
Air Filter Primary.....	A-5535	Fuel Filter Secondary.....	FC-5507	Hydraulic Oil Filter.....	H-5502
Fuel Filter Secondary.....	FC-5507	Hydraulic Oil Filter.....	H-5503	Hydraulic Oil Filter.....	H-5526
Hydraulic Oil Filter.....	H-5503	Hydraulic Oil Filter.....	H-5502	Hydraulic Oil Filter.....	H-55280
Oil Filter Full Flow.....	C-5510	Oil Filter Full Flow.....	C-5510	Hydraulic Oil Filter.....	H-5503
				Oil Filter Full Flow.....	C-5510
D6C (DOZERS) S/N: 99J2535-UP		D6D (DOZERS) S/N: 30X1-2069		D6D (DOZERS) S/N: 33X410-UP	
Air Filter Secondary.....	A-5534	Air Filter Set.....	A-5573-S	Air Filter Primary.....	A-5501
Air Filter Primary.....	A-5501	Air Filter Primary.....	A-5501	Air Filter Secondary.....	A-5502
Air Filter Secondary.....	A-5502	Fuel Filter Secondary.....	FC-5507	Fuel Filter Secondary.....	FC-5507
Air Filter Primary.....	A-5535	Hydraulic Oil Filter.....	H-5503	Hydraulic Oil Filter.....	H-5502
Air Filter Set.....	A-5573-S	Hydraulic Oil Filter.....	H-5502	Hydraulic Oil Filter.....	H-5526
Fuel Filter Secondary.....	FC-5507	Oil Filter Full Flow.....	C-5510	Hydraulic Oil Filter.....	H-55280
Hydraulic Oil Filter.....	H-5503			Hydraulic Oil Filter.....	H-5502
Oil Filter Full Flow.....	C-5510	D6D (DOZERS) S/N: 30X1-UP		Oil Filter Full Flow.....	C-5510
		Air Filter Primary.....	A-5501		
D6D (DOZERS) CAT 3306		Air Filter Secondary.....	A-5502	D6D (DOZERS) S/N: 36C100-UP	
Air Filter Set.....	A-44150-S	Fuel Filter Secondary.....	FC-5507	Air Filter Secondary.....	A-5502
Air Filter Primary.....	A-44150	Hydraulic Oil Filter.....	H-5526	Air Filter Primary.....	A-5501
		Hydraulic Oil Filter.....	H-5502	Fuel Filter Secondary.....	FC-5507
D6D (DOZERS)		Hydraulic Oil Filter.....	H-5503	Hydraulic Oil Filter.....	H-5503
Fuel Filter.....	F-5503	Hydraulic Oil Filter.....	H-55280	Hydraulic Oil Filter.....	H-5526
		Oil Filter Full Flow.....	C-5510	Hydraulic Oil Filter.....	H-5502
D6D (DOZERS) S/N: 19B400-UP		D6D (DOZERS) S/N: 30X2070-UP		Oil Filter Full Flow.....	C-5510
Air Filter Set.....	A-5522-S	Air Filter Secondary.....	A-5502		
Air Filter Secondary.....	A-5510	Air Filter Primary.....	A-5501	D6D (DOZERS) S/N: 37C200-UP	
Air Filter Primary.....	A-5509	Fuel Filter Secondary.....	FC-5507	Air Filter Secondary.....	A-5502
Fuel Filter.....	F-5505	Hydraulic Oil Filter.....	H-5503	Air Filter Primary.....	A-5501
Fuel Filter Secondary.....	FC-5507	Hydraulic Oil Filter.....	H-5502	Fuel Filter Secondary.....	FC-5507
Hydraulic Oil Filter.....	H-5503	Oil Filter Full Flow.....	C-5510	Hydraulic Oil Filter.....	H-5503
Hydraulic Oil Filter.....	H-55280			Hydraulic Oil Filter.....	H-5526
Hydraulic Oil Filter.....	H-55270	D6D (DOZERS) S/N: 31X1497-UP		Oil Filter Full Flow.....	C-5510
Hydraulic Oil Filter.....	H-5526	Air Filter Set.....	A-5573-S		
Hydraulic Oil Filter.....	H-5504	Air Filter Primary.....	A-5535	D6D (DOZERS) S/N: 38C100-UP	
Oil Filter Full Flow.....	C-5510	Air Filter Secondary.....	A-5502	Air Filter Secondary.....	A-5510
		Air Filter Secondary.....	A-5534	Air Filter Secondary.....	A-5522
D6D (DOZERS) S/N: 19X767-UP		Air Filter Primary.....	A-5501	Air Filter Primary.....	A-5509
Air Filter Primary.....	A-5501	Fuel Filter Secondary.....	FC-5507	Air Filter Set.....	A-5522-S
		Hydraulic Oil Filter.....	H-5503	Fuel Filter.....	F-5505
				Fuel Filter Secondary.....	FC-5507
				Hydraulic Oil Filter.....	H-5503
				Hydraulic Oil Filter.....	H-55270
				Hydraulic Oil Filter.....	H-5504

MODEL/APPLICATION	SAKURA NO
CATERPILLAR	
D6D (DOZERS) S/N: 38C100-UP	
Hydraulic Oil Filter.....	H-5526
Hydraulic Oil Filter.....	H-55280
Oil Filter Full Flow.....	C-5510
D6D (DOZERS) S/N: 3X1-UP	
Air Filter Primary.....	A-5535
Air Filter Secondary.....	A-5534
Air Filter Secondary.....	A-5502
Air Filter Set.....	A-5573-S
Air Filter Primary.....	A-5501
Fuel Filter.....	F-5505
Hydraulic Oil Filter.....	H-5502
Hydraulic Oil Filter.....	H-5503
Oil Filter Full Flow.....	C-5510
D6D (DOZERS) S/N: 4X1-UP	
Air Filter Secondary.....	A-5502
Air Filter Secondary.....	A-5534
Air Filter Set.....	A-5573-S
Air Filter Primary.....	A-5535
Air Filter Primary.....	A-5501
Fuel Filter Secondary.....	FC-5507
Hydraulic Oil Filter.....	H-5503
Hydraulic Oil Filter.....	H-5502
Oil Filter Full Flow.....	C-5510
D6D (DOZERS) S/N: 5X1-UP	
Air Filter Primary.....	A-5535
Air Filter Primary.....	A-5509
Air Filter Secondary.....	A-5510
Air Filter Secondary.....	A-5534
Air Filter Set.....	A-5522-S
Air Filter Set.....	A-5573-S
Fuel Filter.....	F-5505
Hydraulic Oil Filter.....	H-5503
Oil Filter Full Flow.....	O-5502
Oil Filter Full Flow.....	C-5510
D6D (DOZERS) S/N: 5YB800-UP	
Fuel Filter.....	F-5505
Fuel Filter Secondary.....	FC-5507
Hydraulic Oil Filter.....	H-5526
Hydraulic Oil Filter.....	H-55280
Hydraulic Oil Filter.....	H-5503
D6D (DOZERS) S/N: 6HC1-2574	
Air Filter Secondary.....	A-5534
Air Filter Set.....	A-5573-S
Air Filter Primary.....	A-5535
D6D (DOZERS) S/N: 6HC1-UP	
Air Filter Secondary.....	A-5502
Air Filter Primary.....	A-5501
Fuel Filter Secondary.....	FC-5507
Fuel Filter.....	F-5505
Hydraulic Oil Filter.....	H-5502

MODEL/APPLICATION	SAKURA NO
CATERPILLAR	
Hydraulic Oil Filter.....	H-55280
Hydraulic Oil Filter.....	H-5526
Hydraulic Oil Filter.....	H-5503
Oil Filter Full Flow.....	C-5510
D6D (DOZERS) S/N: 6X1-UP	
Air Filter Set.....	A-5573-S
Air Filter Primary.....	A-5501
Air Filter Secondary.....	A-5534
Air Filter Secondary.....	A-5502
Air Filter Primary.....	A-5535
Fuel Filter Secondary.....	FC-5507
Hydraulic Oil Filter.....	H-5502
Hydraulic Oil Filter.....	H-5503
Oil Filter Full Flow.....	C-5510
D6D (DOZERS) S/N: 74W1-2560	
Air Filter Primary.....	A-5535
Air Filter Set.....	A-5573-S
Air Filter Secondary.....	A-5534
D6D (DOZERS) S/N: 74W2561-UP	
Air Filter Secondary.....	A-5534
Air Filter Secondary.....	A-5502
Air Filter Primary.....	A-5501
Air Filter Primary.....	A-5535
Air Filter Set.....	A-5573-S
Fuel Filter.....	F-5505
Hydraulic Oil Filter.....	H-5502
Hydraulic Oil Filter.....	H-5503
Oil Filter Full Flow.....	C-5510
D6D (DOZERS) S/N: 75W1-UP	
Air Filter Set.....	A-5573-S
Air Filter Primary.....	A-5501
Air Filter Primary.....	A-5535
Air Filter Secondary.....	A-5502
Air Filter Secondary.....	A-5534
Fuel Filter Secondary.....	FC-5507
Hydraulic Oil Filter.....	H-5503
Hydraulic Oil Filter.....	H-5502
Oil Filter Full Flow.....	C-5510
D6D (DOZERS) S/N: 7YK1-UP	
Air Filter Primary.....	A-5501
Air Filter Secondary.....	A-5502
Fuel Filter Secondary.....	FC-5507
Fuel Filter.....	F-5505
Hydraulic Oil Filter.....	H-5526
Hydraulic Oil Filter.....	H-5503
Hydraulic Oil Filter.....	H-55280
Hydraulic Oil Filter.....	H-5502
Oil Filter Full Flow.....	C-5510
D6D (DOZERS) S/N: 9FK1-UP	
Air Filter Primary.....	A-5501
Air Filter Secondary.....	A-5502
Fuel Filter.....	F-5505

MODEL/APPLICATION	SAKURA NO
CATERPILLAR	
Fuel Filter Secondary.....	FC-5507
Hydraulic Oil Filter.....	H-5502
Hydraulic Oil Filter.....	H-55280
Hydraulic Oil Filter.....	H-5526
Hydraulic Oil Filter.....	H-5503
Oil Filter Full Flow.....	C-5510
D6E (DOZERS) S/N: 1207-1207	
Air Filter Primary.....	A-5535
Air Filter Secondary.....	A-5534
Air Filter Set.....	A-5573-S
D6E (DOZERS) S/N: 2MJ1-1206	
Air Filter Set.....	A-5573-S
Air Filter Primary.....	A-5535
Air Filter Secondary.....	A-5534
D6E (DOZERS) S/N: 2MJ1158-2653	
Air Filter Secondary.....	A-5502
Air Filter Primary.....	A-5501
Fuel Filter Secondary.....	FC-5507
Hydraulic Oil Filter.....	H-5503
Hydraulic Oil Filter.....	H-5502
Oil Filter Full Flow.....	C-5510
D6E (DOZERS) S/N: 2MJ1-UP	
Air Filter Primary.....	A-5501
Air Filter Secondary.....	A-5502
Fuel Filter.....	F-5505
Fuel Filter Secondary.....	FC-5507
Hydraulic Oil Filter.....	H-55280
Hydraulic Oil Filter.....	H-5526
Hydraulic Oil Filter.....	H-5503
Hydraulic Oil Filter.....	H-5502
Oil Filter Full Flow.....	C-5510
D6E (DOZERS) S/N: 8FG1-UP	
Air Filter Primary.....	A-5549
Air Filter Primary.....	A-5549M
Air Filter Secondary.....	A-5550
Air Filter Set.....	A-5549M-S
D6E (DOZERS) w/3306 Eng.	
Air Filter Primary.....	A-5535M
Air Filter Set.....	A-5573M-S
D6E SR (DOZERS) S/N: 8FJ1-UP	
Air Filter Primary.....	A-5509
Air Filter Secondary.....	A-5510
Air Filter Set.....	A-5522-S
Fuel Filter.....	F-5505
Hydraulic Oil Filter.....	H-5502
Oil Filter Full Flow.....	C-5510
D6E SR (DOZERS) w/3306 Eng.	
Air Filter Primary.....	A-5535M
Air Filter Set.....	A-5573M-S

MODEL/APPLICATION	SAKURA NO
-------------------	-----------

CATERPILLAR

D6F SR (DOZERS)
CAT 3306T (S/N: 5FR1-UP)

Air Filter Set.....	A-5573-S
Air Filter Primary.....	A-5535
Air Filter Secondary.....	A-5534
Fuel Filter.....	F-5505
Fuel Filter Secondary.....	FC-5507
Hydraulic Oil Filter.....	HC-5506
Hydraulic Oil Filter.....	H-5503
Hydraulic Oil Filter.....	HC-5503
Hydraulic Oil Filter.....	HC-5512
Hydraulic Oil Filter.....	H-5526
Hydraulic Oil Filter.....	H-55280
Oil Filter Full Flow.....	C-5510

D6F SR (DOZERS)
w/3306 Eng.

Air Filter Primary.....	A-5535M
Air Filter Set.....	A-5573M-S

D6G (DOZERS)
CAT 3306T (S/N: 3SR1-UP)

Air Filter Primary.....	A-5535
Air Filter Set.....	A-5573-S
Air Filter Secondary.....	A-5534
Fuel Filter Secondary.....	FC-5507
Fuel Filter.....	F-5505
Hydraulic Oil Filter.....	H-5526
Hydraulic Oil Filter.....	HC-5506
Hydraulic Oil Filter.....	H-5503
Hydraulic Oil Filter.....	H-55280
Hydraulic Oil Filter.....	HC-5503
Hydraulic Oil Filter.....	HC-5512
Oil Filter Full Flow.....	C-5510

D6G II (DOZERS)
CAT S/N: 1021-UP

Air Filter Secondary.....	A-5550
Fuel Filter Secondary.....	FC-5507
Fuel/Water Separator Secondary..	SFC-5504-10B
Fuel/Water Separator Secondary..	SFC-5504-10
Hydraulic Oil Filter.....	HC-5512
Hydraulic Oil Filter.....	H-5526
Hydraulic Oil Filter.....	HC-5506
Hydraulic Oil Filter.....	HC-5503
Hydraulic Oil Filter.....	H-55280
Oil Filter Full Flow.....	C-5522

D6G II (DOZERS)
CAT S/N: C6G1000-UP

Air Filter Secondary.....	A-5550
Fuel Filter Secondary.....	FC-5507
Fuel/Water Separator Secondary..	SFC-5504-10
Fuel/Water Separator Secondary..	SFC-5504-10B
Hydraulic Oil Filter.....	HC-5506
Hydraulic Oil Filter.....	H-5526
Hydraulic Oil Filter.....	HC-5512
Hydraulic Oil Filter.....	HC-5503
Hydraulic Oil Filter.....	H-55280
Oil Filter Full Flow.....	C-5522

D6G SR (DOZERS)
S/N: 2MJ,3SR-UP

MODEL/APPLICATION	SAKURA NO
-------------------	-----------

CATERPILLAR

Air Filter Primary.....	A-5535
Air Filter Set.....	A-5573-S
Air Filter Secondary.....	A-5534
Fuel Filter.....	F-5505
Fuel Filter Secondary.....	FC-5507
Hydraulic Oil Filter.....	HC-5503
Hydraulic Oil Filter.....	HC-5506
Hydraulic Oil Filter.....	H-5503
Oil Filter Full Flow.....	C-5510

D6G SR (DOZERS)
w/3306 Eng.

Air Filter Primary.....	A-5535M
Air Filter Set.....	A-5573M-S

D6H (DOZERS)
CAT 3306

Cabin Air Filter.....	CA-55140
-----------------------	----------

D6H (DOZERS)
Excluding S/N: UP

Air Filter Secondary.....	A-5522
Air Filter Primary.....	A-5509
Air Filter Set.....	A-5522-S
Hydraulic Oil Filter.....	HC-55310
Hydraulic Oil Filter.....	H-5526
Hydraulic Oil Filter.....	H-55280

D6H (DOZERS)
S/N: 1FJ1-481

Air Filter Secondary.....	A-5522
Air Filter Set.....	A-5522-S
Air Filter Primary.....	A-5509
Hydraulic Oil Filter.....	H-5503

D6H (DOZERS)
S/N: 1FJ1-UP

Air Filter Primary.....	A-5509
Air Filter Set.....	A-5522-S
Air Filter Secondary.....	A-5522
Fuel Filter.....	F-5505
Fuel Filter Secondary.....	FC-5507
Hydraulic Oil Filter.....	H-55280
Hydraulic Oil Filter.....	H-5510
Hydraulic Oil Filter.....	H-5526
Hydraulic Oil Filter.....	HC-5511
Hydraulic Oil Filter.....	H-5503
Oil Filter Full Flow.....	C-5510

D6H (DOZERS)
S/N: 1FJ4000-5499

Air Filter Secondary.....	A-5522
Air Filter Set.....	A-5522-S
Air Filter Primary.....	A-5509
Hydraulic Oil Filter.....	H-5510
Hydraulic Oil Filter.....	H-5503

D6H (DOZERS)
S/N: 1FJ482-3999

Air Filter Secondary.....	A-5522
Air Filter Primary.....	A-5509
Air Filter Set.....	A-5522-S
Hydraulic Oil Filter.....	H-5510
Hydraulic Oil Filter.....	H-5503

MODEL/APPLICATION	SAKURA NO
-------------------	-----------

CATERPILLAR

D6H (DOZERS)
S/N: 1FJ5500-5540

Air Filter Secondary.....	A-5522
Air Filter Set.....	A-5522-S
Air Filter Primary.....	A-5509
Hydraulic Oil Filter.....	H-5510
Hydraulic Oil Filter.....	H-5503

D6H (DOZERS)
S/N: 1FJ5541-5541

Air Filter Secondary.....	A-5550
Air Filter Primary.....	A-5549M
Air Filter Set.....	A-5549M-S
Air Filter Primary.....	A-5549
Hydraulic Oil Filter.....	H-5510
Hydraulic Oil Filter.....	H-5503

D6H (DOZERS)
S/N: 1FJ5542-UP

Air Filter Primary.....	A-5549M
Air Filter Primary.....	A-5549
Air Filter Secondary.....	A-5550
Air Filter Set.....	A-5549M-S
Hydraulic Oil Filter.....	H-5510
Hydraulic Oil Filter.....	H-5503

D6H (DOZERS)
S/N: 1KD1-5499

Air Filter Set.....	A-5549M-S
Air Filter Primary.....	A-5549M
Air Filter Primary.....	A-5509
Air Filter Secondary.....	A-5522
Air Filter Primary.....	A-5549
Air Filter Set.....	A-5522-S
Air Filter Secondary.....	A-5550
Hydraulic Oil Filter.....	H-5503
Hydraulic Oil Filter.....	HC-55310
Oil Filter Full Flow.....	C-5510

D6H (DOZERS)
S/N: 1KD1-UP

Air Filter Primary.....	A-5509
Air Filter Set.....	A-5522-S
Air Filter Secondary.....	A-5522
Fuel Filter.....	F-5505
Fuel Filter Secondary.....	FC-5507
Hydraulic Oil Filter.....	HC-55310
Hydraulic Oil Filter.....	H-5526
Hydraulic Oil Filter.....	H-55280
Hydraulic Oil Filter.....	H-5503
Hydraulic Oil Filter.....	HC-5511
Oil Filter Full Flow.....	C-5510

D6H (DOZERS)
S/N: 1KD4074-UP

Air Filter Set.....	A-5522-S
Air Filter Secondary.....	A-5522
Air Filter Primary.....	A-5509
Fuel Filter Secondary.....	FC-5507
Fuel Filter.....	F-5505
Hydraulic Oil Filter.....	H-5526
Hydraulic Oil Filter.....	H-5510
Hydraulic Oil Filter.....	H-5503

Sakura Filter

ENGINE APPLICATION

MODEL/APPLICATION	SAKURA NO	MODEL/APPLICATION	SAKURA NO	MODEL/APPLICATION	SAKURA NO
CATERPILLAR		CATERPILLAR		CATERPILLAR	
D6H (DOZERS) S/N: 1KD4074-UP Hydraulic Oil Filter..... H-55280 Oil Filter Full Flow..... C-5510		Hydraulic Oil Filter..... H-5503 Hydraulic Oil Filter..... HC-5511 Oil Filter Full Flow..... C-5510		Hydraulic Oil Filter..... H-5526 Hydraulic Oil Filter..... H-55280	
D6H (DOZERS) S/N: 1KD5500-UP Air Filter Primary..... A-5549M Air Filter Primary..... A-5509 Air Filter Primary..... A-5549 Air Filter Secondary..... A-5550 Air Filter Secondary..... A-5522 Air Filter Set..... A-5549M-S Air Filter Set..... A-5522-S Fuel Filter Secondary..... FC-5507 Hydraulic Oil Filter..... H-5503 Oil Filter Full Flow..... C-5510		D6H (DOZERS) S/N: 2TG4000-UP Air Filter Set..... A-5549M-S Air Filter Secondary..... A-5550 Air Filter Primary..... A-5549 Air Filter Primary..... A-5549M Fuel Filter..... F-5505 Fuel Filter Secondary..... FC-5507 Hydraulic Oil Filter..... H-5503 Hydraulic Oil Filter..... H-55280 Hydraulic Oil Filter..... H-5510 Hydraulic Oil Filter..... H-5526 Oil Filter Full Flow..... C-5510		D6H (DOZERS) S/N: 3YG1-UP Air Filter Set..... A-5549M-S Air Filter Primary..... A-5549M Air Filter Secondary..... A-5550 Air Filter Primary..... A-5549 Fuel Filter..... F-5505 Fuel Filter Secondary..... FC-5507 Hydraulic Oil Filter..... H-5503 Hydraulic Oil Filter..... H-5510 Oil Filter Full Flow..... C-5510	
D6H (DOZERS) S/N: 2KD1-UP Air Filter Secondary..... A-5522 Air Filter Set..... A-5522-S Air Filter Primary..... A-5509 Fuel Filter Secondary..... FC-5507 Fuel Filter..... F-5505 Hydraulic Oil Filter..... HC-55310 Hydraulic Oil Filter..... H-55280 Hydraulic Oil Filter..... H-5526 Hydraulic Oil Filter..... H-5503 Hydraulic Oil Filter..... HC-5511 Oil Filter Full Flow..... C-5510		D6H (DOZERS) S/N: 3ED1-4082 Air Filter Secondary..... A-5522 Air Filter Primary..... A-5509 Air Filter Set..... A-5522-S Fuel Filter Secondary..... FC-5507 Fuel Filter..... F-5505 Hydraulic Oil Filter..... HC-5511 Hydraulic Oil Filter..... H-55280 Hydraulic Oil Filter..... H-5526 Hydraulic Oil Filter..... HC-55310 Hydraulic Oil Filter..... H-5503 Oil Filter Full Flow..... C-5510		D6H (DOZERS) S/N: 3YG4000-UP Air Filter Primary..... A-5549 Air Filter Set..... A-5549M-S Air Filter Primary..... A-5549M Air Filter Secondary..... A-5550 Fuel Filter..... F-5505 Fuel Filter Secondary..... FC-5507 Hydraulic Oil Filter..... H-5503 Hydraulic Oil Filter..... HC-5511 Hydraulic Oil Filter..... H-5510 Hydraulic Oil Filter..... H-5526 Hydraulic Oil Filter..... H-55280 Oil Filter Full Flow..... C-5510	
D6H (DOZERS) S/N: 2KD4033-UP Air Filter Secondary..... A-5522 Air Filter Primary..... A-5509 Air Filter Set..... A-5522-S Fuel Filter..... F-5505 Fuel Filter Secondary..... FC-5507 Hydraulic Oil Filter..... H-5510 Hydraulic Oil Filter..... H-55280 Hydraulic Oil Filter..... H-5503 Hydraulic Oil Filter..... H-5526 Oil Filter Full Flow..... C-5510		D6H (DOZERS) S/N: 3ED4083-UP Air Filter Secondary..... A-5522 Air Filter Set..... A-5522-S Air Filter Primary..... A-5509 Fuel Filter..... F-5505 Fuel Filter Secondary..... FC-5507 Hydraulic Oil Filter..... H-5526 Hydraulic Oil Filter..... H-5510 Hydraulic Oil Filter..... H-5503 Hydraulic Oil Filter..... H-55280 Oil Filter Full Flow..... C-5510		D6H (DOZERS) S/N: 3YG4255-4284 Air Filter Set..... A-5522-S Air Filter Secondary..... A-5522 Air Filter Primary..... A-5509 Hydraulic Oil Filter..... HC-5511 Hydraulic Oil Filter..... HC-55290 Hydraulic Oil Filter..... H-5526 Hydraulic Oil Filter..... H-5510 Hydraulic Oil Filter..... H-55280	
D6H (DOZERS) S/N: 2KD5500-UP Air Filter Primary..... A-5509 Air Filter Set..... A-5522-S Air Filter Secondary..... A-5522 Fuel Filter..... F-5505 Hydraulic Oil Filter..... H-5503 Oil Filter Full Flow..... C-5510		D6H (DOZERS) S/N: 3YG1-3999 Air Filter Set..... A-5522-S Air Filter Primary..... A-5509 Air Filter Secondary..... A-5522 Fuel Filter Secondary..... FC-5507 Fuel Filter..... F-5505 Hydraulic Oil Filter..... H-5510 Hydraulic Oil Filter..... H-5526 Hydraulic Oil Filter..... HC-5511 Hydraulic Oil Filter..... H-55280 Hydraulic Oil Filter..... H-5503 Oil Filter Full Flow..... C-5510		D6H (DOZERS) S/N: 3YG4285-5499 Air Filter Secondary..... A-5522 Air Filter Set..... A-5522-S Air Filter Primary..... A-5509 Hydraulic Oil Filter..... H-5510 Hydraulic Oil Filter..... HC-55290 Hydraulic Oil Filter..... H-5526 Hydraulic Oil Filter..... H-5510 Hydraulic Oil Filter..... H-55280	
D6H (DOZERS) S/N: 2TG1-3999 Air Filter Secondary..... A-5522 Air Filter Set..... A-5522-S Air Filter Primary..... A-5509 Fuel Filter Secondary..... FC-5507 Fuel Filter..... F-5505 Hydraulic Oil Filter..... H-55280 Hydraulic Oil Filter..... HC-55310 Hydraulic Oil Filter..... H-5526		D6H (DOZERS) S/N: 3YG1-4254 Air Filter Set..... A-5522-S Air Filter Secondary..... A-5522 Air Filter Primary..... A-5509		D6H (DOZERS) S/N: 3YG5500-5733 Air Filter Primary..... A-5549 Air Filter Secondary..... A-5550 Air Filter Primary..... A-5549M Air Filter Set..... A-5549M-S Hydraulic Oil Filter..... HC-5511 Hydraulic Oil Filter..... H-5503 Hydraulic Oil Filter..... HC-55290 Hydraulic Oil Filter..... H-5510 Hydraulic Oil Filter..... H-5526	

Sakura Filter

ENGINE APPLICATION

MODEL/APPLICATION	SAKURA NO	MODEL/APPLICATION	SAKURA NO	MODEL/APPLICATION	SAKURA NO
CATERPILLAR		CATERPILLAR		CATERPILLAR	
D6H (DOZERS) S/N: 3YG5500-5733		Hydraulic Oil Filter..... H-5510 Hydraulic Oil Filter..... H-5503 Hydraulic Oil Filter..... H-55280 Hydraulic Oil Filter..... H-5526 Hydraulic Oil Filter..... HC-55290		Hydraulic Oil Filter..... H-5526 Hydraulic Oil Filter..... H-5503 Hydraulic Oil Filter..... H-55280 Hydraulic Oil Filter..... HC-55310 Oil Filter Full Flow..... C-5510	
D6H (DOZERS) S/N: 3YG5734-UP		D6H (DOZERS) S/N: 3ZF5500-5717		D6H (DOZERS) S/N: 4LG4000-UP	
Air Filter Primary..... A-5549 Air Filter Set..... A-5549M-S Air Filter Secondary..... A-5550 Air Filter Primary..... A-5549M Hydraulic Oil Filter..... HC-55290 Hydraulic Oil Filter..... H-5526 Hydraulic Oil Filter..... H-5503 Hydraulic Oil Filter..... H-55280 Hydraulic Oil Filter..... HC-5511 Hydraulic Oil Filter..... H-5510		Air Filter Secondary..... A-5550 Air Filter Primary..... A-5549 Air Filter Primary..... A-5549M Air Filter Set..... A-5549M-S Hydraulic Oil Filter..... H-5526 Hydraulic Oil Filter..... H-55280 Hydraulic Oil Filter..... H-5510 Hydraulic Oil Filter..... HC-5511 Hydraulic Oil Filter..... HC-55290 Hydraulic Oil Filter..... H-5503		Air Filter Primary..... A-5549 Air Filter Primary..... A-5549M Air Filter Secondary..... A-5550 Air Filter Set..... A-5549M-S Fuel Filter..... F-5505 Fuel Filter Secondary..... FC-5507 Hydraulic Oil Filter..... H-5503 Hydraulic Oil Filter..... H-5526 Hydraulic Oil Filter..... H-55280 Hydraulic Oil Filter..... H-5510 Oil Filter Full Flow..... C-5510	
D6H (DOZERS) S/N: 3ZF1-1319		D6H (DOZERS) S/N: 3ZF5718-UP		D6H (DOZERS) S/N: 4RC1050-2444	
Air Filter Set..... A-5522-S Air Filter Primary..... A-5509 Air Filter Secondary..... A-5522 Hydraulic Oil Filter..... H-55280 Hydraulic Oil Filter..... H-5526		Air Filter Primary..... A-5549 Air Filter Set..... A-5549M-S Air Filter Secondary..... A-5550 Air Filter Primary..... A-5549M Hydraulic Oil Filter..... HC-5511 Hydraulic Oil Filter..... H-5503 Hydraulic Oil Filter..... H-55280 Hydraulic Oil Filter..... H-5510 Hydraulic Oil Filter..... HC-55290 Hydraulic Oil Filter..... H-5526		Air Filter Primary..... A-5509 Air Filter Secondary..... A-5522 Air Filter Set..... A-5522-S Hydraulic Oil Filter..... H-55280 Hydraulic Oil Filter..... HC-55310 Hydraulic Oil Filter..... H-5526 Hydraulic Oil Filter..... H-5510	
D6H (DOZERS) S/N: 3ZF1320-4382		D6H (DOZERS) S/N: 3ZF5718-UP		D6H (DOZERS) S/N: 4RC1-1049	
Air Filter Primary..... A-5509 Air Filter Secondary..... A-5522 Air Filter Set..... A-5522-S Hydraulic Oil Filter..... H-5526 Hydraulic Oil Filter..... H-55280		Air Filter Primary..... A-5549 Air Filter Set..... A-5549M-S Air Filter Secondary..... A-5550 Air Filter Primary..... A-5549M Hydraulic Oil Filter..... HC-5511 Hydraulic Oil Filter..... H-5503 Hydraulic Oil Filter..... H-55280 Hydraulic Oil Filter..... H-5510 Hydraulic Oil Filter..... HC-55290 Hydraulic Oil Filter..... H-5526		Air Filter Set..... A-5522-S Air Filter Primary..... A-5509 Air Filter Secondary..... A-5522 Hydraulic Oil Filter..... H-5510 Hydraulic Oil Filter..... HC-55310	
D6H (DOZERS) S/N: 3ZF4000-UP		D6H (DOZERS) S/N: 4GG1-UP		D6H (DOZERS) S/N: 4RC1-2444	
Air Filter Set..... A-5549M-S Air Filter Primary..... A-5549 Air Filter Secondary..... A-5550 Air Filter Primary..... A-5549M Fuel Filter Secondary..... FC-5507 Fuel Filter..... F-5505 Hydraulic Oil Filter..... H-55280 Hydraulic Oil Filter..... H-5503 Hydraulic Oil Filter..... H-55280 Hydraulic Oil Filter..... H-5526 Hydraulic Oil Filter..... H-5510 Hydraulic Oil Filter..... HC-5511 Oil Filter Full Flow..... C-5510		Air Filter Secondary..... A-5522 Air Filter Primary..... A-5509 Air Filter Set..... A-5522-S Fuel Filter Secondary..... FC-5507 Fuel Filter..... F-5505 Hydraulic Oil Filter..... H-55280 Hydraulic Oil Filter..... H-5526 Hydraulic Oil Filter..... HC-5511 Hydraulic Oil Filter..... H-5510 Hydraulic Oil Filter..... H-5503 Oil Filter Full Flow..... C-5510		Air Filter Secondary..... A-5522 Air Filter Secondary..... A-5550 Air Filter Primary..... A-5549M Air Filter Set..... A-5549M-S Air Filter Set..... A-5522-S Air Filter Primary..... A-5509 Air Filter Primary..... A-5549 Hydraulic Oil Filter..... HC-55310 Hydraulic Oil Filter..... H-5503 Oil Filter Full Flow..... C-5510	
D6H (DOZERS) S/N: 3ZF4383-4441		D6H (DOZERS) S/N: 4LG00603-UP		D6H (DOZERS) S/N: 4RC2445-2550-UP	
Air Filter Set..... A-5522-S Air Filter Secondary..... A-5522 Air Filter Primary..... A-5509 Hydraulic Oil Filter..... H-5526 Hydraulic Oil Filter..... H-55280 Hydraulic Oil Filter..... H-5510 Hydraulic Oil Filter..... HC-55290 Hydraulic Oil Filter..... HC-5511		Air Filter Primary..... A-5509 Air Filter Set..... A-5522-S Air Filter Secondary..... A-5522 Fuel Filter Secondary..... FC-5507 Hydraulic Oil Filter..... HC-55310 Hydraulic Oil Filter..... H-5503 Oil Filter Full Flow..... C-5510		Air Filter Secondary..... A-5522 Air Filter Primary..... A-5509 Air Filter Set..... A-5522-S Hydraulic Oil Filter..... HC-55310 Hydraulic Oil Filter..... H-5526 Hydraulic Oil Filter..... H-5510 Hydraulic Oil Filter..... H-55280	
D6H (DOZERS) S/N: 3ZF4442-5499		D6H (DOZERS) S/N: 4LG1-3999		D6H (DOZERS) S/N: 4RC2445-3999	
Air Filter Set..... A-5522-S Air Filter Secondary..... A-5522 Air Filter Primary..... A-5509 Hydraulic Oil Filter..... HC-5511		Air Filter Secondary..... A-5522 Air Filter Set..... A-5522-S Air Filter Primary..... A-5509 Fuel Filter..... F-5505 Fuel Filter Secondary..... FC-5507 Hydraulic Oil Filter..... HC-5511		Air Filter Set..... A-5522-S Air Filter Primary..... A-5509 Air Filter Set..... A-5522-S Hydraulic Oil Filter..... HC-55310 Hydraulic Oil Filter..... H-5526 Hydraulic Oil Filter..... H-5510 Hydraulic Oil Filter..... H-55280	

MODEL/APPLICATION	SAKURA NO
CATERPILLAR	
D6H (DOZERS) S/N: 4RC2445-3999	
Air Filter Primary.....	A-5509
Air Filter Secondary.....	A-5522
Air Filter Secondary.....	A-5550
Air Filter Set.....	A-5549M-S
Air Filter Primary.....	A-5549M
Air Filter Primary.....	A-5549
Hydraulic Oil Filter.....	H-5503
Oil Filter Full Flow.....	C-5510
D6H (DOZERS) S/N: 4RC2551-4050	
Air Filter Set.....	A-5522-S
Air Filter Primary.....	A-5509
Air Filter Secondary.....	A-5522
Hydraulic Oil Filter.....	H-5526
Hydraulic Oil Filter.....	H-55280
Hydraulic Oil Filter.....	H-5510
Hydraulic Oil Filter.....	HC-55310
D6H (DOZERS) S/N: 4RC4000-UP	
Air Filter Secondary.....	A-5550
Air Filter Primary.....	A-5549M
Air Filter Primary.....	A-5549
Air Filter Set.....	A-5549M-S
Fuel Filter.....	F-5505
Fuel Filter Secondary.....	FC-5507
Hydraulic Oil Filter.....	H-5526
Hydraulic Oil Filter.....	H-5510
Hydraulic Oil Filter.....	H-5503
Hydraulic Oil Filter.....	H-55280
Oil Filter Full Flow.....	C-5510
D6H (DOZERS) S/N: 4RC4051-4217	
Air Filter Set.....	A-5522-S
Air Filter Secondary.....	A-5522
Air Filter Primary.....	A-5509
Hydraulic Oil Filter.....	H-5526
Hydraulic Oil Filter.....	HC-55310
Hydraulic Oil Filter.....	H-55280
Hydraulic Oil Filter.....	H-5510
Hydraulic Oil Filter.....	H-5503
D6H (DOZERS) S/N: 4RC4218-4302	
Air Filter Set.....	A-5522-S
Air Filter Primary.....	A-5509
Air Filter Secondary.....	A-5522
Hydraulic Oil Filter.....	H-55280
Hydraulic Oil Filter.....	H-5510
Hydraulic Oil Filter.....	HC-55310
Hydraulic Oil Filter.....	H-5526
D6H (DOZERS) S/N: 4RC4303-5499	
Air Filter Secondary.....	A-5522
Air Filter Primary.....	A-5509
Air Filter Set.....	A-5522-S
Hydraulic Oil Filter.....	HC-55310
Hydraulic Oil Filter.....	H-5526
Hydraulic Oil Filter.....	H-5503

MODEL/APPLICATION	SAKURA NO
CATERPILLAR	
Hydraulic Oil Filter.....	H-55280
Hydraulic Oil Filter.....	H-5510
D6H (DOZERS) S/N: 4RC5500-UP	
Air Filter Set.....	A-5549M-S
Air Filter Secondary.....	A-5550
Air Filter Primary.....	A-5549
Air Filter Primary.....	A-5549M
Hydraulic Oil Filter.....	H-5510
Hydraulic Oil Filter.....	H-5526
Hydraulic Oil Filter.....	HC-55310
Hydraulic Oil Filter.....	H-5503
Hydraulic Oil Filter.....	H-55280
D6H (DOZERS) S/N: 4RD1-3999	
Air Filter Primary.....	A-5509
Air Filter Set.....	A-5522-S
Air Filter Secondary.....	A-5522
Fuel Filter.....	F-5505
Fuel Filter Secondary.....	FC-5507
Hydraulic Oil Filter.....	H-5503
Hydraulic Oil Filter.....	H-55280
Hydraulic Oil Filter.....	HC-55310
Hydraulic Oil Filter.....	H-5526
Hydraulic Oil Filter.....	HC-5511
Hydraulic Oil Filter.....	H-5510
Oil Filter Full Flow.....	C-5510
D6H (DOZERS) S/N: 4YF1-UP	
Air Filter Primary.....	A-5509
Air Filter Set.....	A-5522-S
Air Filter Secondary.....	A-5522
Fuel Filter Secondary.....	FC-5507
Fuel Filter.....	F-5505
Hydraulic Oil Filter.....	H-5510
Hydraulic Oil Filter.....	H-5503
Hydraulic Oil Filter.....	H-5526
Hydraulic Oil Filter.....	H-55280
Hydraulic Oil Filter.....	HC-5511
Oil Filter Full Flow.....	C-5510
D6H (DOZERS) S/N: 4YF5500-UP	
Air Filter Set.....	A-5522-S
Air Filter Primary.....	A-5509
Fuel Filter.....	F-5505
Hydraulic Oil Filter.....	H-5510
Hydraulic Oil Filter.....	H-5503
Oil Filter Full Flow.....	C-5510
D6H (DOZERS) S/N: 5HF1-3999	
Air Filter Secondary.....	A-5522
Air Filter Set.....	A-5522-S
Air Filter Primary.....	A-5509
Fuel Filter.....	F-5505
Fuel Filter Secondary.....	FC-5507
Hydraulic Oil Filter.....	H-5526
Hydraulic Oil Filter.....	HC-5511
Hydraulic Oil Filter.....	H-5510
Hydraulic Oil Filter.....	H-5510
Hydraulic Oil Filter.....	H-55280

MODEL/APPLICATION	SAKURA NO
CATERPILLAR	
Hydraulic Oil Filter.....	H-5503
Oil Filter Full Flow.....	C-5510
D6H (DOZERS) S/N: 5HF1-4159	
Air Filter Set.....	A-5522-S
Air Filter Secondary.....	A-5522
Air Filter Primary.....	A-5509
Hydraulic Oil Filter.....	H-5510
Hydraulic Oil Filter.....	HC-5511
Hydraulic Oil Filter.....	HC-55290
Hydraulic Oil Filter.....	H-5503
D6H (DOZERS) S/N: 5HF4000-UP	
Air Filter Primary.....	A-5549M
Air Filter Secondary.....	A-5550
Air Filter Primary.....	A-5549
Air Filter Set.....	A-5549M-S
Fuel Filter.....	F-5505
Fuel Filter Secondary.....	FC-5507
Hydraulic Oil Filter.....	H-5526
Hydraulic Oil Filter.....	H-5510
Hydraulic Oil Filter.....	HC-5511
Hydraulic Oil Filter.....	H-5503
Hydraulic Oil Filter.....	H-55280
Oil Filter Full Flow.....	C-5510
D6H (DOZERS) S/N: 5HF4160-5513	
Air Filter Set.....	A-5522-S
Air Filter Secondary.....	A-5522
Air Filter Primary.....	A-5509
Hydraulic Oil Filter.....	HC-5511
Hydraulic Oil Filter.....	H-5510
Hydraulic Oil Filter.....	HC-55290
Hydraulic Oil Filter.....	H-5503
D6H (DOZERS) S/N: 5HF5514-UP	
Air Filter Set.....	A-5549M-S
Air Filter Primary.....	A-5549M
Air Filter Primary.....	A-5549
Air Filter Secondary.....	A-5550
Hydraulic Oil Filter.....	HC-5511
Hydraulic Oil Filter.....	H-5503
Hydraulic Oil Filter.....	H-5510
Hydraulic Oil Filter.....	HC-55290
D6H (DOZERS) S/N: 6CF1-3999	
Air Filter Primary.....	A-5509
Air Filter Set.....	A-5522-S
Air Filter Secondary.....	A-5522
Fuel Filter Secondary.....	FC-5507
Fuel Filter.....	F-5505
Hydraulic Oil Filter.....	H-55280
Hydraulic Oil Filter.....	H-5503
Hydraulic Oil Filter.....	HC-5511
Hydraulic Oil Filter.....	H-5526
Hydraulic Oil Filter.....	H-5510
Oil Filter Full Flow.....	C-5510

MODEL/APPLICATION	SAKURA NO
CATERPILLAR	
D6H (DOZERS) S/N: 6CF1-4159	
Air Filter Primary.....	A-5509
Air Filter Secondary.....	A-5522
Air Filter Set.....	A-5522-S
Hydraulic Oil Filter.....	HC-5511
Hydraulic Oil Filter.....	H-5510
Hydraulic Oil Filter.....	HC-55290
Hydraulic Oil Filter.....	H-5503
D6H (DOZERS) S/N: 6CF4000-UP	
Air Filter Primary.....	A-5549M
Air Filter Secondary.....	A-5550
Air Filter Primary.....	A-5549
Air Filter Set.....	A-5549M-S
Fuel Filter.....	F-5505
Fuel Filter Secondary.....	FC-5507
Hydraulic Oil Filter.....	H-5526
Hydraulic Oil Filter.....	HC-5511
Hydraulic Oil Filter.....	H-5510
Hydraulic Oil Filter.....	H-55280
Hydraulic Oil Filter.....	H-5503
Oil Filter Full Flow.....	C-5510
D6H (DOZERS) S/N: 6CF4160-5533	
Air Filter Secondary.....	A-5522
Air Filter Set.....	A-5522-S
Air Filter Primary.....	A-5509
Hydraulic Oil Filter.....	HC-55290
Hydraulic Oil Filter.....	H-5503
Hydraulic Oil Filter.....	HC-5511
Hydraulic Oil Filter.....	H-5510
D6H (DOZERS) S/N: 6CF5534-UP	
Air Filter Primary.....	A-5549M
Air Filter Primary.....	A-5549
Air Filter Secondary.....	A-5550
Air Filter Set.....	A-5549M-S
Hydraulic Oil Filter.....	H-5503
Hydraulic Oil Filter.....	HC-55290
Hydraulic Oil Filter.....	H-5510
Hydraulic Oil Filter.....	HC-5511
D6H (DOZERS) S/N: 6FC1-355	
Air Filter Primary.....	A-5509
Air Filter Secondary.....	A-5522
Air Filter Set.....	A-5522-S
Hydraulic Oil Filter.....	H-5510
Hydraulic Oil Filter.....	HC-55310
D6H (DOZERS) S/N: 6FC1-3999	
Air Filter Primary.....	A-5509
Air Filter Secondary.....	A-5522
Air Filter Set.....	A-5522-S
Fuel Filter.....	F-5505
Fuel Filter Secondary.....	FC-5507
Hydraulic Oil Filter.....	H-55280
Hydraulic Oil Filter.....	H-5503

MODEL/APPLICATION	SAKURA NO
CATERPILLAR	
Hydraulic Oil Filter.....	HC-5511
Hydraulic Oil Filter.....	H-5510
Hydraulic Oil Filter.....	H-5526
Hydraulic Oil Filter.....	HC-55310
Oil Filter Full Flow.....	C-5510
D6H (DOZERS) S/N: 6FC1-UP	
Air Filter Set.....	A-5522-S
Air Filter Secondary.....	A-5522
Air Filter Primary.....	A-5509
Hydraulic Oil Filter.....	H-5503
Oil Filter Full Flow.....	C-5510
D6H (DOZERS) S/N: 6FC356-691	
Air Filter Set.....	A-5522-S
Air Filter Secondary.....	A-5522
Air Filter Primary.....	A-5509
Hydraulic Oil Filter.....	H-5510
Hydraulic Oil Filter.....	H-5526
Hydraulic Oil Filter.....	H-55280
Hydraulic Oil Filter.....	HC-55310
D6H (DOZERS) S/N: 6FC4000-UP	
Air Filter Primary.....	A-5549
Air Filter Primary.....	A-5549M
Air Filter Set.....	A-5549M-S
Air Filter Secondary.....	A-5550
Fuel Filter.....	F-5505
Fuel Filter Secondary.....	FC-5507
Hydraulic Oil Filter.....	H-55280
Hydraulic Oil Filter.....	H-5503
Hydraulic Oil Filter.....	H-5510
Hydraulic Oil Filter.....	HC-55310
Hydraulic Oil Filter.....	H-5526
Oil Filter Full Flow.....	C-5510
D6H (DOZERS) S/N: 6FC4034-4076	
Air Filter Set.....	A-5522-S
Air Filter Secondary.....	A-5522
Air Filter Primary.....	A-5509
Hydraulic Oil Filter.....	H-5526
Hydraulic Oil Filter.....	H-5503
Hydraulic Oil Filter.....	H-5510
Hydraulic Oil Filter.....	HC-55310
Hydraulic Oil Filter.....	H-55280
D6H (DOZERS) S/N: 6FC4077-4088	
Air Filter Primary.....	A-5509
Air Filter Set.....	A-5522-S
Air Filter Secondary.....	A-5522
Hydraulic Oil Filter.....	H-5510
Hydraulic Oil Filter.....	H-5526
Hydraulic Oil Filter.....	HC-55310
Hydraulic Oil Filter.....	H-55280
D6H (DOZERS) S/N: 6FC4089-5499	
Air Filter Set.....	A-5522-S
Air Filter Secondary.....	A-5522
Air Filter Primary.....	A-5509

MODEL/APPLICATION	SAKURA NO
CATERPILLAR	
Hydraulic Oil Filter.....	H-5510
Hydraulic Oil Filter.....	H-5526
Hydraulic Oil Filter.....	HC-55310
Hydraulic Oil Filter.....	H-55280
Hydraulic Oil Filter.....	H-5503
D6H (DOZERS) S/N: 6FC5500-UP	
Air Filter Set.....	A-5549M-S
Air Filter Secondary.....	A-5550
Air Filter Primary.....	A-5549
Air Filter Primary.....	A-5549M
Hydraulic Oil Filter.....	HC-55310
Hydraulic Oil Filter.....	H-5526
Hydraulic Oil Filter.....	H-5510
Hydraulic Oil Filter.....	H-5503
Hydraulic Oil Filter.....	H-55280
D6H (DOZERS) S/N: 6FC692-4033	
Air Filter Secondary.....	A-5522
Air Filter Set.....	A-5522-S
Air Filter Primary.....	A-5509
Hydraulic Oil Filter.....	H-5526
Hydraulic Oil Filter.....	H-5510
Hydraulic Oil Filter.....	H-55280
Hydraulic Oil Filter.....	HC-55310
D6H (DOZERS) S/N: 7PC1-UP	
Air Filter Set.....	A-5522-S
Air Filter Primary.....	A-5509
Air Filter Secondary.....	A-5522
Fuel Filter.....	F-5505
Fuel Filter Secondary.....	FC-5507
Hydraulic Oil Filter.....	H-5526
Hydraulic Oil Filter.....	H-55280
Hydraulic Oil Filter.....	HC-5511
Hydraulic Oil Filter.....	H-5503
Hydraulic Oil Filter.....	HC-55310
Oil Filter Full Flow.....	C-5510
D6H (DOZERS) S/N: 8FC1-UP	
Air Filter Primary.....	A-5509
Air Filter Set.....	A-5522-S
Air Filter Secondary.....	A-5522
Fuel Filter.....	F-5505
Fuel Filter Secondary.....	FC-5507
Hydraulic Oil Filter.....	HC-55310
Hydraulic Oil Filter.....	H-5526
Hydraulic Oil Filter.....	H-55280
Hydraulic Oil Filter.....	HC-5511
Hydraulic Oil Filter.....	H-5503
Oil Filter Full Flow.....	C-5510
D6H (DOZERS) S/N: 8FC4092-UP	
Air Filter Secondary.....	A-5522
Air Filter Set.....	A-5522-S
Air Filter Primary.....	A-5509
Fuel Filter Secondary.....	FC-5507
Fuel Filter.....	F-5505
Hydraulic Oil Filter.....	H-5526

MODEL/APPLICATION	SAKURA NO
CATERPILLAR	
D6H (DOZERS) S/N: 8FC4092-UP	
Hydraulic Oil Filter.....	H-5510
Hydraulic Oil Filter.....	H-55280
Hydraulic Oil Filter.....	H-5503
Oil Filter Full Flow.....	C-5510
D6H (DOZERS) S/N: 8FC5500-UP	
Air Filter Secondary.....	A-5522
Air Filter Primary.....	A-5509
Air Filter Set.....	A-5522-S
Fuel Filter Secondary.....	FC-5507
Hydraulic Oil Filter.....	H-5503
Hydraulic Oil Filter.....	H-5510
Oil Filter Full Flow.....	C-5510
D6H (DOZERS) S/N: 8KB1-440	
Air Filter Secondary.....	A-5522
Air Filter Primary.....	A-5509
Air Filter Set.....	A-5522-S
Hydraulic Oil Filter.....	HC-55310
D6H (DOZERS) S/N: 8KB1-UP	
Air Filter Secondary.....	A-5522
Air Filter Set.....	A-5522-S
Air Filter Primary.....	A-5509
Fuel Filter.....	F-5505
Fuel Filter Secondary.....	FC-5507
Hydraulic Oil Filter.....	H-55280
Hydraulic Oil Filter.....	H-5526
Hydraulic Oil Filter.....	HC-55310
Hydraulic Oil Filter.....	HC-5511
Hydraulic Oil Filter.....	H-5503
Oil Filter Full Flow.....	C-5510
D6H (DOZERS) S/N: 8YC1-UP	
Air Filter Set.....	A-5522-S
Air Filter Secondary.....	A-5522
Air Filter Primary.....	A-5509
Fuel Filter.....	F-5505
Fuel Filter Secondary.....	FC-5507
Hydraulic Oil Filter.....	HC-55310
Hydraulic Oil Filter.....	HC-5511
Hydraulic Oil Filter.....	H-55280
Hydraulic Oil Filter.....	H-5503
Hydraulic Oil Filter.....	H-5526
Oil Filter Full Flow.....	C-5510
D6H (DOZERS) S/N: TO-8KB441	
Air Filter Primary.....	A-5509
Air Filter Set.....	A-5522-S
Air Filter Secondary.....	A-5522
Hydraulic Oil Filter.....	H-5526
Hydraulic Oil Filter.....	H-55280
Hydraulic Oil Filter.....	HC-55310
D6H II (DOZERS) CAT 3306	
Cabin Air Filter.....	CA-55140

MODEL/APPLICATION	SAKURA NO
CATERPILLAR	
D6H LGP (DOZERS) CAT 3306	
Cabin Air Filter.....	CA-55140
D6H LGP (DOZERS) S/N: 1KD1-UP	
Air Filter Secondary.....	A-5522
Air Filter Primary.....	A-5509
Air Filter Set.....	A-5522-S
Fuel Filter.....	F-5505
Fuel Filter Secondary.....	FC-5507
Hydraulic Oil Filter.....	HC-55310
Hydraulic Oil Filter.....	H-5503
Hydraulic Oil Filter.....	H-55280
Hydraulic Oil Filter.....	H-5526
Hydraulic Oil Filter.....	HC-5511
Oil Filter Full Flow.....	C-5510
D6H LGP (DOZERS) S/N: 2KD1-UP	
Air Filter Primary.....	A-5509
Air Filter Set.....	A-5522-S
Air Filter Secondary.....	A-5522
Fuel Filter.....	F-5505
Fuel Filter Secondary.....	FC-5507
Hydraulic Oil Filter.....	HC-55310
Hydraulic Oil Filter.....	H-5526
Hydraulic Oil Filter.....	HC-5511
Hydraulic Oil Filter.....	H-5503
Hydraulic Oil Filter.....	H-55280
Oil Filter Full Flow.....	C-5510
D6H LGP (DOZERS) S/N: 2TG1-3999	
Air Filter Primary.....	A-5509
Air Filter Secondary.....	A-5522
Air Filter Set.....	A-5522-S
Fuel Filter.....	F-5505
Fuel Filter Secondary.....	FC-5507
Hydraulic Oil Filter.....	HC-55310
Hydraulic Oil Filter.....	H-55280
Hydraulic Oil Filter.....	HC-5511
Hydraulic Oil Filter.....	H-5526
Hydraulic Oil Filter.....	H-5503
Hydraulic Oil Filter.....	H-55280
Oil Filter Full Flow.....	C-5510
D6H LGP (DOZERS) S/N: 3ED1-UP	
Air Filter Set.....	A-5522-S
Air Filter Primary.....	A-5509
Air Filter Secondary.....	A-5522
Fuel Filter.....	F-5505
Fuel Filter Secondary.....	FC-5507
Hydraulic Oil Filter.....	HC-55310
Hydraulic Oil Filter.....	H-5526
Hydraulic Oil Filter.....	H-55280
Hydraulic Oil Filter.....	HC-5511
Hydraulic Oil Filter.....	H-5503
Oil Filter Full Flow.....	C-5510
D6H LGP (DOZERS) S/N: 3YG1-3999	
Air Filter Primary.....	A-5509

MODEL/APPLICATION	SAKURA NO
CATERPILLAR	
Air Filter Set.....	A-5522-S
Air Filter Secondary.....	A-5522
Fuel Filter Secondary.....	FC-5507
Fuel Filter.....	F-5505
Hydraulic Oil Filter.....	HC-5511
Hydraulic Oil Filter.....	H-5526
Hydraulic Oil Filter.....	H-55280
Hydraulic Oil Filter.....	H-5503
Hydraulic Oil Filter.....	H-5510
Oil Filter Full Flow.....	C-5510
D6H LGP (DOZERS) S/N: 3ZF1-3999	
Air Filter Primary.....	A-5509
Air Filter Set.....	A-5522-S
Air Filter Secondary.....	A-5522
Fuel Filter Secondary.....	FC-5507
Fuel Filter.....	F-5505
Hydraulic Oil Filter.....	H-5526
Hydraulic Oil Filter.....	HC-5511
Hydraulic Oil Filter.....	H-55280
Hydraulic Oil Filter.....	H-5503
Hydraulic Oil Filter.....	H-5510
Oil Filter Full Flow.....	C-5510
D6H LGP (DOZERS) S/N: 4LG1-3999	
Air Filter Set.....	A-5522-S
Air Filter Primary.....	A-5509
Air Filter Secondary.....	A-5522
Fuel Filter Secondary.....	FC-5507
Fuel Filter.....	F-5505
Hydraulic Oil Filter.....	HC-55310
Hydraulic Oil Filter.....	H-5503
Hydraulic Oil Filter.....	H-5526
Hydraulic Oil Filter.....	HC-5511
Hydraulic Oil Filter.....	H-55280
Oil Filter Full Flow.....	C-5510
D6H LGP (DOZERS) S/N: 4RC1-3999	
Air Filter Primary.....	A-5509
Air Filter Secondary.....	A-5522
Air Filter Set.....	A-5522-S
Fuel Filter Secondary.....	FC-5507
Fuel Filter.....	F-5505
Hydraulic Oil Filter.....	HC-55310
Hydraulic Oil Filter.....	H-5510
Hydraulic Oil Filter.....	H-5503
Hydraulic Oil Filter.....	H-55280
Hydraulic Oil Filter.....	HC-5511
Hydraulic Oil Filter.....	H-5526
Oil Filter Full Flow.....	C-5510
D6H LGP (DOZERS) S/N: 6FC1-3999	
Air Filter Set.....	A-5522-S
Air Filter Secondary.....	A-5522
Air Filter Primary.....	A-5509
Fuel Filter.....	F-5505
Fuel Filter Secondary.....	FC-5507
Hydraulic Oil Filter.....	HC-55310
Hydraulic Oil Filter.....	H-5510

MODEL/APPLICATION	SAKURA NO
CATERPILLAR	
D6H LGP (DOZERS) S/N: 6FC1-3999	
Hydraulic Oil Filter.....	H-5526
Hydraulic Oil Filter.....	HC-5511
Hydraulic Oil Filter.....	H-55280
Hydraulic Oil Filter.....	H-5503
Oil Filter Full Flow.....	C-5510
D6H LGP (DOZERS) S/N: 7PC1-UP	
Air Filter Set.....	A-5522-S
Air Filter Primary.....	A-5509
Air Filter Secondary.....	A-5522
Fuel Filter.....	F-5505
Fuel Filter Secondary.....	FC-5507
Hydraulic Oil Filter.....	HC-55310
Hydraulic Oil Filter.....	H-5503
Hydraulic Oil Filter.....	H-55280
Hydraulic Oil Filter.....	H-5526
Hydraulic Oil Filter.....	HC-5511
Oil Filter Full Flow.....	C-5510
D6H LGP (DOZERS) S/N: 8FC1-UP	
Air Filter Set.....	A-5522-S
Air Filter Primary.....	A-5509
Air Filter Secondary.....	A-5522
Fuel Filter Secondary.....	FC-5507
Fuel Filter.....	F-5505
Hydraulic Oil Filter.....	H-5526
Hydraulic Oil Filter.....	HC-5511
Hydraulic Oil Filter.....	HC-55310
Hydraulic Oil Filter.....	H-5503
Hydraulic Oil Filter.....	H-55280
Oil Filter Full Flow.....	C-5510
D6H LGP (DOZERS) S/N: 8YC1-UP	
Air Filter Set.....	A-5522-S
Air Filter Primary.....	A-5509
Air Filter Secondary.....	A-5522
Fuel Filter.....	F-5505
Fuel Filter Secondary.....	FC-5507
Hydraulic Oil Filter.....	H-5526
Hydraulic Oil Filter.....	HC-5511
Hydraulic Oil Filter.....	HC-55310
Hydraulic Oil Filter.....	H-55280
Hydraulic Oil Filter.....	H-5503
Oil Filter Full Flow.....	C-5510
D6H LGP SERIES II (DOZERS) S/N: 4YF5500-UP , TO-2001	
Air Filter Secondary.....	A-5522
Air Filter Primary.....	A-5509
Air Filter Set.....	A-5522-S
Fuel Filter Secondary.....	FC-5507
Fuel Filter.....	F-5505
Hydraulic Oil Filter.....	H-5503
Hydraulic Oil Filter.....	H-55280
Hydraulic Oil Filter.....	H-5526
Hydraulic Oil Filter.....	H-5510
Hydraulic Oil Filter.....	HC-5511
Oil Filter Full Flow.....	C-5510

MODEL/APPLICATION	SAKURA NO
CATERPILLAR	
D6H LGP SERIES II (DOZERS) CAT 3306	
Cabin Air Filter.....	CA-55140
D6H LGP SERIES II (DOZERS) S/N: 1KD4074-UP	
Air Filter Primary.....	A-5509
Air Filter Set.....	A-5522-S
Air Filter Secondary.....	A-5522
Fuel Filter Secondary.....	FC-5507
Fuel Filter.....	F-5505
Hydraulic Oil Filter.....	H-5510
Hydraulic Oil Filter.....	H-5526
Hydraulic Oil Filter.....	H-5503
Hydraulic Oil Filter.....	H-55280
Oil Filter Full Flow.....	C-5510
D6H LGP SERIES II (DOZERS) S/N: 2KD4033-UP	
Air Filter Primary.....	A-5509
Air Filter Set.....	A-5522-S
Air Filter Secondary.....	A-5522
Fuel Filter.....	F-5505
Fuel Filter Secondary.....	FC-5507
Hydraulic Oil Filter.....	H-55280
Hydraulic Oil Filter.....	H-5510
Hydraulic Oil Filter.....	H-5503
Hydraulic Oil Filter.....	H-5526
Oil Filter Full Flow.....	C-5510
D6H LGP SERIES II (DOZERS) S/N: 2TG4000-UP	
Air Filter Primary.....	A-5549M
Air Filter Set.....	A-5549M-S
Air Filter Secondary.....	A-5550
Air Filter Primary.....	A-5549
Fuel Filter Secondary.....	FC-5507
Fuel Filter.....	F-5505
Hydraulic Oil Filter.....	H-5503
Hydraulic Oil Filter.....	H-55280
Hydraulic Oil Filter.....	H-5526
Hydraulic Oil Filter.....	H-5510
Oil Filter Full Flow.....	C-5510
D6H LGP SERIES II (DOZERS) S/N: 2TL1-UP	
Air Filter Set.....	A-5522-S
Air Filter Primary.....	A-5509
Air Filter Secondary.....	A-5522
Fuel Filter Secondary.....	FC-5507
Fuel Filter.....	F-5505
Hydraulic Oil Filter.....	H-5510
Hydraulic Oil Filter.....	H-5526
Hydraulic Oil Filter.....	H-5503
Hydraulic Oil Filter.....	H-55280
Hydraulic Oil Filter.....	HC-5511
Oil Filter Full Flow.....	C-5510
D6H LGP SERIES II (DOZERS) S/N: 3YG4000-UP	
Air Filter Primary.....	A-5549
Air Filter Secondary.....	A-5550
Air Filter Primary.....	A-5549M

MODEL/APPLICATION	SAKURA NO
CATERPILLAR	
Air Filter Set.....	A-5549M-S
Fuel Filter.....	F-5505
Fuel Filter Secondary.....	FC-5507
Hydraulic Oil Filter.....	H-55280
Hydraulic Oil Filter.....	H-5503
Hydraulic Oil Filter.....	HC-5511
Hydraulic Oil Filter.....	H-5526
Hydraulic Oil Filter.....	H-5510
Oil Filter Full Flow.....	C-5510
D6H LGP SERIES II (DOZERS) S/N: 3ZF4000-UP	
Air Filter Secondary.....	A-5550
Air Filter Primary.....	A-5549M
Air Filter Primary.....	A-5549
Air Filter Set.....	A-5549M-S
Fuel Filter.....	F-5505
Fuel Filter Secondary.....	FC-5507
Hydraulic Oil Filter.....	H-5526
Hydraulic Oil Filter.....	HC-5511
Hydraulic Oil Filter.....	H-55280
Hydraulic Oil Filter.....	H-5503
Hydraulic Oil Filter.....	H-5510
Oil Filter Full Flow.....	C-5510
D6H LGP SERIES II (DOZERS) S/N: 4GG5500-UP	
Air Filter Secondary.....	A-5522
Air Filter Set.....	A-5522-S
Air Filter Primary.....	A-5509
Fuel Filter Secondary.....	FC-5507
Fuel Filter.....	F-5505
Hydraulic Oil Filter.....	H-5503
Hydraulic Oil Filter.....	H-5510
Hydraulic Oil Filter.....	H-5526
Hydraulic Oil Filter.....	H-55280
Hydraulic Oil Filter.....	HC-5511
Oil Filter Full Flow.....	C-5510
D6H LGP SERIES II (DOZERS) S/N: 4LG4000-UP	
Air Filter Set.....	A-5549M-S
Air Filter Primary.....	A-5549M
Air Filter Primary.....	A-5549
Air Filter Secondary.....	A-5550
Fuel Filter Secondary.....	FC-5507
Fuel Filter.....	F-5505
Hydraulic Oil Filter.....	H-5510
Hydraulic Oil Filter.....	H-55280
Hydraulic Oil Filter.....	H-5526
Hydraulic Oil Filter.....	H-5503
Oil Filter Full Flow.....	C-5510
D6H LGP SERIES II (DOZERS) S/N: 4RC4000-UP	
Air Filter Primary.....	A-5549M
Air Filter Secondary.....	A-5550
Air Filter Primary.....	A-5549
Air Filter Set.....	A-5549M-S
Fuel Filter.....	F-5505
Fuel Filter Secondary.....	FC-5507
Hydraulic Oil Filter.....	H-5510
Hydraulic Oil Filter.....	H-5526

MODEL/APPLICATION	SAKURA NO	MODEL/APPLICATION	SAKURA NO	MODEL/APPLICATION	SAKURA NO
CATERPILLAR		CATERPILLAR		CATERPILLAR	
D6H LGP SERIES II (DOZERS) S/N: 4RC4000-UP Hydraulic Oil Filter..... H-55280 Hydraulic Oil Filter..... H-5503 Oil Filter Full Flow..... C-5510		D6H LGP SERIES II (DOZERS) S/N: 8SK1-UP Air Filter Secondary..... A-5522 Air Filter Set..... A-5522-S Air Filter Primary..... A-5509 Fuel Filter..... F-5505 Fuel Filter Secondary..... FC-5507 Hydraulic Oil Filter..... H-5510 Hydraulic Oil Filter..... H-5526 Hydraulic Oil Filter..... H-5503 Hydraulic Oil Filter..... H-55280 Hydraulic Oil Filter..... HC-5511 Oil Filter Full Flow..... C-5510		Air Filter Primary..... A-5549M Air Filter Set..... A-5549M-S Air Filter Primary..... A-5549 Fuel Filter..... F-5505 Fuel Filter Secondary..... FC-5507 Hydraulic Oil Filter..... H-5503 Hydraulic Oil Filter..... H-55280 Hydraulic Oil Filter..... H-5510 Hydraulic Oil Filter..... H-5526 Oil Filter Full Flow..... C-5510	
D6H LGP SERIES II (DOZERS) S/N: 5HF4000-UP Air Filter Primary..... A-5549 Air Filter Secondary..... A-5550 Air Filter Set..... A-5549M-S Air Filter Primary..... A-5549M Fuel Filter..... F-5505 Fuel Filter Secondary..... FC-5507 Hydraulic Oil Filter..... H-5526 Hydraulic Oil Filter..... H-5510 Hydraulic Oil Filter..... H-5503 Hydraulic Oil Filter..... HC-5511 Hydraulic Oil Filter..... H-55280 Oil Filter Full Flow..... C-5510		D6H LS (DOZERS) Air Filter Primary..... A-5549M Air Filter Primary..... A-5549 Air Filter Set..... A-5522-S Air Filter Primary..... A-5509 Air Filter Secondary..... A-5522 Air Filter Secondary..... A-5550 Air Filter Set..... A-5549M-S Fuel Filter..... FC-5501 Fuel Filter..... FC-5523 Fuel Filter Secondary..... FC-5507 Hydraulic Oil Filter..... H-5510 Hydraulic Oil Filter..... H-5503 Hydraulic Oil Filter..... HC-5511 Oil Filter Full Flow..... C-5510		D6H SERIES II (DOZERS) S/N: 1FJ482-3999 Air Filter Secondary..... A-5522 Air Filter Primary..... A-5509 Air Filter Set..... A-5522-S Hydraulic Oil Filter..... H-5503 Hydraulic Oil Filter..... H-5510	
D6H LGP SERIES II (DOZERS) S/N: 6CF4000-UP Air Filter Primary..... A-5549M Air Filter Primary..... A-5549 Air Filter Set..... A-5549M-S Air Filter Secondary..... A-5550 Fuel Filter..... F-5505 Fuel Filter Secondary..... FC-5507 Hydraulic Oil Filter..... HC-5511 Hydraulic Oil Filter..... H-5510 Hydraulic Oil Filter..... H-5503 Hydraulic Oil Filter..... H-55280 Hydraulic Oil Filter..... H-5526 Oil Filter Full Flow..... C-5510		D6H LS SERIES II (DOZERS) S/N: 2DK5500-UP Air Filter Primary..... A-5509 Air Filter Secondary..... A-5522 Air Filter Set..... A-5522-S Fuel Filter..... F-5505 Fuel Filter Secondary..... FC-5507 Hydraulic Oil Filter..... H-5510 Hydraulic Oil Filter..... H-55280 Hydraulic Oil Filter..... H-5503 Hydraulic Oil Filter..... HC-5511 Hydraulic Oil Filter..... H-5526 Oil Filter Full Flow..... C-5510		D6H SERIES II (DOZERS) S/N: 1FJ5500-5540 Air Filter Primary..... A-5509 Air Filter Secondary..... A-5522 Air Filter Set..... A-5522-S Hydraulic Oil Filter..... H-5503 Hydraulic Oil Filter..... H-5510	
D6H LGP SERIES II (DOZERS) S/N: 6FC4000-UP Air Filter Secondary..... A-5550 Air Filter Primary..... A-5549 Air Filter Set..... A-5549M-S Air Filter Primary..... A-5549M Fuel Filter..... F-5505 Fuel Filter Secondary..... FC-5507 Hydraulic Oil Filter..... HC-55310 Hydraulic Oil Filter..... H-5526 Hydraulic Oil Filter..... H-5510 Hydraulic Oil Filter..... H-55280 Hydraulic Oil Filter..... H-5503 Oil Filter Full Flow..... C-5510		D6H LS SERIES II (DOZERS) S/N: 2DK5500-UP Air Filter Primary..... A-5509 Air Filter Secondary..... A-5522 Air Filter Set..... A-5522-S Fuel Filter..... F-5505 Fuel Filter Secondary..... FC-5507 Hydraulic Oil Filter..... H-5510 Hydraulic Oil Filter..... H-55280 Hydraulic Oil Filter..... H-5503 Hydraulic Oil Filter..... HC-5511 Hydraulic Oil Filter..... H-5526 Oil Filter Full Flow..... C-5510		D6H SERIES II (DOZERS) S/N: 1FJ5541-5541 Air Filter Primary..... A-5549M Air Filter Set..... A-5549M-S Air Filter Secondary..... A-5550 Air Filter Primary..... A-5549 Hydraulic Oil Filter..... H-5503 Hydraulic Oil Filter..... H-5510	
D6H LGP SERIES II (DOZERS) S/N: 8FC5500-UP Air Filter Secondary..... A-5522 Air Filter Set..... A-5522-S Air Filter Primary..... A-5509 Fuel Filter..... F-5505 Fuel Filter Secondary..... FC-5507 Hydraulic Oil Filter..... H-5526 Hydraulic Oil Filter..... H-5503 Hydraulic Oil Filter..... H-55280 Hydraulic Oil Filter..... H-5510 Oil Filter Full Flow..... C-5510		D6H SERIES II (DOZERS) S/N: 1FJ1-481 Air Filter Set..... A-5522-S Air Filter Primary..... A-5509 Air Filter Secondary..... A-5522 Hydraulic Oil Filter..... H-5503		D6H SERIES II (DOZERS) S/N: 1YL1-318 Air Filter Set..... A-5549M-S Air Filter Primary..... A-5509 Air Filter Set..... A-5522-S Air Filter Secondary..... A-5522 Air Filter Primary..... A-5549M Air Filter Secondary..... A-5550 Air Filter Primary..... A-5549 Hydraulic Oil Filter..... H-5510 Hydraulic Oil Filter..... HC-55290 Hydraulic Oil Filter..... HC-5511 Hydraulic Oil Filter..... H-5503	
		D6H SERIES II (DOZERS) S/N: 1FJ4000-5499 Air Filter Set..... A-5522-S Air Filter Primary..... A-5509 Air Filter Secondary..... A-5522 Hydraulic Oil Filter..... H-5510 Hydraulic Oil Filter..... H-5503		D6H SERIES II (DOZERS) S/N: 1YL319-UP Air Filter Primary..... A-5549M Air Filter Set..... A-5549M-S Air Filter Primary..... A-5549 Air Filter Secondary..... A-5550	

MODEL/APPLICATION	SAKURA NO	MODEL/APPLICATION	SAKURA NO	MODEL/APPLICATION	SAKURA NO
CATERPILLAR		CATERPILLAR		CATERPILLAR	
D6H SERIES II (DOZERS) S/N: 1YL319-UP		Air Filter Primary.....	A-5509	Hydraulic Oil Filter.....	H-55280
Hydraulic Oil Filter.....	HC-55290	Hydraulic Oil Filter.....	H-5510	Hydraulic Oil Filter.....	H-5503
Hydraulic Oil Filter.....	H-5510	Hydraulic Oil Filter.....	H-5503		
Hydraulic Oil Filter.....	H-5503				
Hydraulic Oil Filter.....	HC-5511				
D6H SERIES II (DOZERS) S/N: 2BL1-343		D6H SERIES II (DOZERS) S/N: 2TG525-3999		D6H SERIES II (DOZERS) S/N: 3YG5500-5733	
Air Filter Primary.....	A-5509	Air Filter Set.....	A-5522-S	Air Filter Primary.....	A-5549M
Air Filter Set.....	A-5522-S	Air Filter Primary.....	A-5509	Air Filter Secondary.....	A-5550
Air Filter Primary.....	A-5549	Air Filter Secondary.....	A-5522	Air Filter Set.....	A-5549M-S
Air Filter Primary.....	A-5549M	Hydraulic Oil Filter.....	H-5510	Air Filter Primary.....	A-5549
Air Filter Set.....	A-5549M-S	Hydraulic Oil Filter.....	H-5503	Hydraulic Oil Filter.....	H-5510
Air Filter Secondary.....	A-5522			Hydraulic Oil Filter.....	H-55280
Air Filter Secondary.....	A-5550	D6H SERIES II (DOZERS) S/N: 2TG5500-5587		Hydraulic Oil Filter.....	H-5503
Hydraulic Oil Filter.....	H-5503	Air Filter Secondary.....	A-5522	Hydraulic Oil Filter.....	HC-55290
Hydraulic Oil Filter.....	H-5510	Air Filter Set.....	A-5522-S	Hydraulic Oil Filter.....	HC-5511
		Air Filter Primary.....	A-5509	Hydraulic Oil Filter.....	H-5526
		Hydraulic Oil Filter.....	H-5510		
		Hydraulic Oil Filter.....	H-5503		
				D6H SERIES II (DOZERS) S/N: 3YG5734-UP	
				Air Filter Primary.....	A-5549M
				Air Filter Secondary.....	A-5550
				Air Filter Set.....	A-5549M-S
				Air Filter Primary.....	A-5549
				Hydraulic Oil Filter.....	H-55280
				Hydraulic Oil Filter.....	H-5503
				Hydraulic Oil Filter.....	H-5510
				Hydraulic Oil Filter.....	HC-5511
				Hydraulic Oil Filter.....	H-5526
				D6H SERIES II (DOZERS) S/N: 3ZF1-1319	
				Air Filter Secondary.....	A-5522
				Air Filter Set.....	A-5522-S
				Air Filter Primary.....	A-5509
				Hydraulic Oil Filter.....	H-5526
				Hydraulic Oil Filter.....	H-55280
				D6H SERIES II (DOZERS) S/N: 3ZF1320-4382	
				Air Filter Primary.....	A-5509
				Air Filter Set.....	A-5522-S
				Air Filter Secondary.....	A-5522
				Hydraulic Oil Filter.....	H-5526
				Hydraulic Oil Filter.....	H-55280
				D6H SERIES II (DOZERS) S/N: 3ZF4383-4441	
				Air Filter Secondary.....	A-5522
				Air Filter Set.....	A-5522-S
				Air Filter Primary.....	A-5509
				Hydraulic Oil Filter.....	H-5510
				Hydraulic Oil Filter.....	H-55280
				Hydraulic Oil Filter.....	HC-55290
				Hydraulic Oil Filter.....	H-5526
				Hydraulic Oil Filter.....	HC-5511
				D6H SERIES II (DOZERS) S/N: 3ZF4442-5499	
				Air Filter Secondary.....	A-5522
				Air Filter Set.....	A-5522-S
				Air Filter Primary.....	A-5509
				Hydraulic Oil Filter.....	H-5503
				Hydraulic Oil Filter.....	H-5526
				Hydraulic Oil Filter.....	H-5510
				Hydraulic Oil Filter.....	H-55280
				D6H SERIES II (DOZERS) S/N: 2TG400-4094	
Air Filter Primary.....	A-5509	D6H SERIES II (DOZERS) S/N: 3YG4285-5499		Air Filter Secondary.....	A-5522
Air Filter Set.....	A-5522-S	Air Filter Secondary.....	A-5522	Air Filter Primary.....	A-5509
Air Filter Secondary.....	A-5522	Air Filter Primary.....	A-5509	Air Filter Set.....	A-5522-S
Hydraulic Oil Filter.....	H-5503	Air Filter Set.....	A-5522-S	Hydraulic Oil Filter.....	H-5510
Hydraulic Oil Filter.....	H-5510	Hydraulic Oil Filter.....	H-5510	Hydraulic Oil Filter.....	H-55280
		Hydraulic Oil Filter.....	HC-55290	Hydraulic Oil Filter.....	HC-55290
		Hydraulic Oil Filter.....	H-5526	Hydraulic Oil Filter.....	H-5526
		Hydraulic Oil Filter.....	H-55280	Hydraulic Oil Filter.....	HC-5511
		Hydraulic Oil Filter.....	HC-5511		
				D6H SERIES II (DOZERS) S/N: 2TG495-5499	
				Air Filter Secondary.....	A-5522
				Air Filter Set.....	A-5522-S

MODEL/APPLICATION	SAKURA NO
CATERPILLAR	
D6H SERIES II (DOZERS) S/N: 3ZF4442-5499	
Hydraulic Oil Filter.....	HC-5511
Hydraulic Oil Filter.....	HC-55290
D6H SERIES II (DOZERS) S/N: 3ZF5500-5717	
Air Filter Primary.....	A-5549M
Air Filter Secondary.....	A-5550
Air Filter Primary.....	A-5549
Air Filter Set.....	A-5549M-S
Hydraulic Oil Filter.....	HC-55290
Hydraulic Oil Filter.....	H-5510
Hydraulic Oil Filter.....	H-5526
Hydraulic Oil Filter.....	H-5503
Hydraulic Oil Filter.....	HC-5511
Hydraulic Oil Filter.....	H-55280
D6H SERIES II (DOZERS) S/N: 3ZF5718-UP	
Air Filter Primary.....	A-5549M
Air Filter Secondary.....	A-5550
Air Filter Primary.....	A-5549
Air Filter Set.....	A-5549M-S
Hydraulic Oil Filter.....	H-5510
Hydraulic Oil Filter.....	H-55280
Hydraulic Oil Filter.....	H-5503
Hydraulic Oil Filter.....	HC-5511
Hydraulic Oil Filter.....	HC-55290
Hydraulic Oil Filter.....	H-5526
D6H SERIES II (DOZERS) S/N: 4LG1-934	
Air Filter Set.....	A-5522-S
Air Filter Primary.....	A-5509
Air Filter Secondary.....	A-5522
Hydraulic Oil Filter.....	H-5503
D6H SERIES II (DOZERS) S/N: 4LG4000-4410	
Air Filter Set.....	A-5522-S
Air Filter Primary.....	A-5509
Air Filter Secondary.....	A-5522
Hydraulic Oil Filter.....	H-5510
Hydraulic Oil Filter.....	H-5503
D6H SERIES II (DOZERS) S/N: 4LG4411-5499	
Air Filter Primary.....	A-5509
Air Filter Secondary.....	A-5522
Air Filter Set.....	A-5522-S
Hydraulic Oil Filter.....	H-5510
Hydraulic Oil Filter.....	H-5503
D6H SERIES II (DOZERS) S/N: 4LG5500-5536	
Air Filter Primary.....	A-5509
Air Filter Secondary.....	A-5522
Air Filter Set.....	A-5522-S
Hydraulic Oil Filter.....	H-5503
Hydraulic Oil Filter.....	H-5510
D6H SERIES II (DOZERS) S/N: 4LG5537-5592	

MODEL/APPLICATION	SAKURA NO
CATERPILLAR	
Air Filter Primary.....	A-5549
Air Filter Primary.....	A-5549M
Air Filter Set.....	A-5549M-S
Air Filter Secondary.....	A-5550
Hydraulic Oil Filter.....	H-5503
Hydraulic Oil Filter.....	H-5510
D6H SERIES II (DOZERS) S/N: 4LG5593-UP	
Air Filter Set.....	A-5549M-S
Air Filter Secondary.....	A-5550
Air Filter Primary.....	A-5549M
Air Filter Primary.....	A-5549
Hydraulic Oil Filter.....	H-5510
Hydraulic Oil Filter.....	H-5503
D6H SERIES II (DOZERS) S/N: 4LG935-3999	
Air Filter Secondary.....	A-5522
Air Filter Set.....	A-5522-S
Air Filter Primary.....	A-5509
Hydraulic Oil Filter.....	H-5510
Hydraulic Oil Filter.....	H-5503
D6H SERIES II (DOZERS) S/N: 4RC1050-2444	
Air Filter Secondary.....	A-5522
Air Filter Primary.....	A-5509
Air Filter Set.....	A-5522-S
Hydraulic Oil Filter.....	HC-55310
Hydraulic Oil Filter.....	H-5526
Hydraulic Oil Filter.....	H-55280
Hydraulic Oil Filter.....	H-5510
D6H SERIES II (DOZERS) S/N: 4RC1-1049	
Air Filter Set.....	A-5522-S
Air Filter Secondary.....	A-5522
Air Filter Primary.....	A-5509
Hydraulic Oil Filter.....	H-5510
Hydraulic Oil Filter.....	HC-55310
D6H SERIES II (DOZERS) S/N: 4RC2445-2550	
Air Filter Secondary.....	A-5522
Air Filter Set.....	A-5522-S
Air Filter Primary.....	A-5509
Hydraulic Oil Filter.....	H-5510
Hydraulic Oil Filter.....	HC-55310
Hydraulic Oil Filter.....	H-5526
Hydraulic Oil Filter.....	H-55280
D6H SERIES II (DOZERS) S/N: 4RC2551-4050	
Air Filter Secondary.....	A-5522
Air Filter Set.....	A-5522-S
Air Filter Primary.....	A-5509
Hydraulic Oil Filter.....	H-5526
Hydraulic Oil Filter.....	HC-55310
Hydraulic Oil Filter.....	H-55280
Hydraulic Oil Filter.....	H-5510
D6H SERIES II (DOZERS) S/N: 4RC4051-4217	
Air Filter Set.....	A-5522-S

MODEL/APPLICATION	SAKURA NO
CATERPILLAR	
Air Filter Secondary.....	A-5522
Air Filter Primary.....	A-5509
Hydraulic Oil Filter.....	H-55280
Hydraulic Oil Filter.....	HC-55310
Hydraulic Oil Filter.....	H-5510
Hydraulic Oil Filter.....	H-5503
Hydraulic Oil Filter.....	H-5526
D6H SERIES II (DOZERS) S/N: 4RC4218-4302	
Air Filter Primary.....	A-5509
Air Filter Set.....	A-5522-S
Air Filter Secondary.....	A-5522
Hydraulic Oil Filter.....	H-55280
Hydraulic Oil Filter.....	HC-55310
Hydraulic Oil Filter.....	H-5510
Hydraulic Oil Filter.....	H-5526
D6H SERIES II (DOZERS) S/N: 4RC4303-5499	
Air Filter Set.....	A-5522-S
Air Filter Secondary.....	A-5522
Air Filter Primary.....	A-5509
Hydraulic Oil Filter.....	H-5510
Hydraulic Oil Filter.....	H-5526
Hydraulic Oil Filter.....	H-5503
Hydraulic Oil Filter.....	H-55280
Hydraulic Oil Filter.....	HC-55310
D6H SERIES II (DOZERS) S/N: 4RC5500-UP	
Air Filter Secondary.....	A-5550
Air Filter Set.....	A-5549M-S
Air Filter Primary.....	A-5549M
Air Filter Primary.....	A-5549
Hydraulic Oil Filter.....	H-5526
Hydraulic Oil Filter.....	H-5503
Hydraulic Oil Filter.....	H-55280
Hydraulic Oil Filter.....	H-5510
Hydraulic Oil Filter.....	HC-55310
D6H SERIES II (DOZERS) S/N: 5HF1-4159	
Air Filter Secondary.....	A-5522
Air Filter Primary.....	A-5509
Air Filter Set.....	A-5522-S
Hydraulic Oil Filter.....	H-5510
Hydraulic Oil Filter.....	HC-5511
Hydraulic Oil Filter.....	HC-55290
Hydraulic Oil Filter.....	H-5503
D6H SERIES II (DOZERS) S/N: 5HF4160-5513	
Air Filter Set.....	A-5522-S
Air Filter Primary.....	A-5509
Air Filter Secondary.....	A-5522
Hydraulic Oil Filter.....	HC-5511
Hydraulic Oil Filter.....	HC-55290
Hydraulic Oil Filter.....	H-5510
Hydraulic Oil Filter.....	H-5503
D6H SERIES II (DOZERS) S/N: 5HF5514-UP	
Air Filter Set.....	A-5549M-S
Air Filter Primary.....	A-5549

MODEL/APPLICATION	SAKURA NO	MODEL/APPLICATION	SAKURA NO	MODEL/APPLICATION	SAKURA NO
CATERPILLAR		CATERPILLAR		CATERPILLAR	
D6H SERIES II (DOZERS) S/N: 5HF5514-UP Air Filter Secondary..... A-5550 Air Filter Primary..... A-5549M Hydraulic Oil Filter..... HC-55290 Hydraulic Oil Filter..... H-5503 Hydraulic Oil Filter..... HC-5511 Hydraulic Oil Filter..... H-5510		D6H SERIES II (DOZERS) S/N: 6CK348-UP Air Filter Set..... A-5549M-S Air Filter Primary..... A-5549M Air Filter Primary..... A-5549 Air Filter Secondary..... A-5550 Hydraulic Oil Filter..... H-55280 Hydraulic Oil Filter..... HC-5511 Hydraulic Oil Filter..... HC-55290 Hydraulic Oil Filter..... H-5510 Hydraulic Oil Filter..... H-5503 Hydraulic Oil Filter..... H-5526		Air Filter Set..... A-5549M-S Air Filter Secondary..... A-5550 Air Filter Primary..... A-5549 Air Filter Primary..... A-5549M Hydraulic Oil Filter..... H-5510 Hydraulic Oil Filter..... HC-55310 Hydraulic Oil Filter..... H-5503 Hydraulic Oil Filter..... H-5526 Hydraulic Oil Filter..... H-55280	
D6H SERIES II (DOZERS) S/N: 5KK1-UP Air Filter Primary..... A-5549M Air Filter Secondary..... A-5550 Air Filter Primary..... A-5549 Air Filter Set..... A-5549M-S Hydraulic Oil Filter..... H-5510 Hydraulic Oil Filter..... H-5526 Hydraulic Oil Filter..... H-55280 Hydraulic Oil Filter..... H-5503		D6H SERIES II (DOZERS) S/N: 6FC1-355 Air Filter Primary..... A-5509 Air Filter Secondary..... A-5522 Air Filter Set..... A-5522-S Hydraulic Oil Filter..... H-5510		D6H SERIES II (DOZERS) S/N: 6FC692-4033 Air Filter Primary..... A-5509 Air Filter Set..... A-5522-S Air Filter Secondary..... A-5522 Hydraulic Oil Filter..... H-55280 Hydraulic Oil Filter..... HC-55310 Hydraulic Oil Filter..... H-5510 Hydraulic Oil Filter..... H-5526	
D6H SERIES II (DOZERS) S/N: 6CF1-4159 Air Filter Secondary..... A-5522 Air Filter Set..... A-5522-S Air Filter Primary..... A-5509 Hydraulic Oil Filter..... HC-5511 Hydraulic Oil Filter..... H-5503 Hydraulic Oil Filter..... H-5510 Hydraulic Oil Filter..... HC-55290		D6H SERIES II (DOZERS) S/N: 6FC356-691 Air Filter Secondary..... A-5522 Air Filter Set..... A-5522-S Air Filter Primary..... A-5509 Hydraulic Oil Filter..... H-5510 Hydraulic Oil Filter..... H-55280 Hydraulic Oil Filter..... H-5526 Hydraulic Oil Filter..... HC-55310		D6H SERIES II (DOZERS) S/N: 7ZK1-UP Air Filter Set..... A-5522-S Air Filter Secondary..... A-5522 Air Filter Primary..... A-5509 Fuel Filter..... F-5505 Fuel Filter Secondary..... FC-5507 Hydraulic Oil Filter..... H-5503 Hydraulic Oil Filter..... H-55280 Hydraulic Oil Filter..... H-5526 Hydraulic Oil Filter..... H-5510 Oil Filter Full Flow..... C-5510	
D6H SERIES II (DOZERS) S/N: 6CF4160-5533 Air Filter Secondary..... A-5522 Air Filter Set..... A-5522-S Air Filter Primary..... A-5509 Hydraulic Oil Filter..... H-5510 Hydraulic Oil Filter..... HC-55290 Hydraulic Oil Filter..... H-5503 Hydraulic Oil Filter..... HC-5511		D6H SERIES II (DOZERS) S/N: 6FC4034-4076 Air Filter Set..... A-5522-S Air Filter Secondary..... A-5522 Air Filter Primary..... A-5509 Hydraulic Oil Filter..... H-55280 Hydraulic Oil Filter..... H-5526 Hydraulic Oil Filter..... HC-55310 Hydraulic Oil Filter..... H-5510 Hydraulic Oil Filter..... H-5503		D6H SERIES II (DOZERS) S/N: 8KK1-311 Air Filter Primary..... A-5509 Air Filter Set..... A-5522-S Air Filter Secondary..... A-5522 Hydraulic Oil Filter..... H-5503 Hydraulic Oil Filter..... H-5510	
D6H SERIES II (DOZERS) S/N: 6CF5534-UP Air Filter Primary..... A-5549M Air Filter Set..... A-5549M-S Air Filter Secondary..... A-5550 Air Filter Primary..... A-5549 Hydraulic Oil Filter..... H-5510 Hydraulic Oil Filter..... HC-55290 Hydraulic Oil Filter..... HC-5511 Hydraulic Oil Filter..... H-5503		D6H SERIES II (DOZERS) S/N: 6FC4077-4088 Air Filter Secondary..... A-5522 Air Filter Set..... A-5522-S Air Filter Primary..... A-5509 Hydraulic Oil Filter..... H-5526 Hydraulic Oil Filter..... H-5510 Hydraulic Oil Filter..... H-55280 Hydraulic Oil Filter..... HC-55310		D6H SERIES II (DOZERS) S/N: 8KK312-313 Air Filter Primary..... A-5549M Air Filter Primary..... A-5549 Air Filter Secondary..... A-5550 Air Filter Set..... A-5549M-S Hydraulic Oil Filter..... H-5503 Hydraulic Oil Filter..... H-5510	
D6H SERIES II (DOZERS) S/N: 6CK1-347 Air Filter Set..... A-5549M-S Air Filter Primary..... A-5549 Air Filter Primary..... A-5549M Air Filter Secondary..... A-5550 Hydraulic Oil Filter..... HC-55290 Hydraulic Oil Filter..... HC-5511 Hydraulic Oil Filter..... H-55280 Hydraulic Oil Filter..... H-5510 Hydraulic Oil Filter..... H-5526 Hydraulic Oil Filter..... H-5503		D6H SERIES II (DOZERS) S/N: 6FC4089-5499 Air Filter Set..... A-5522-S Air Filter Secondary..... A-5522 Air Filter Primary..... A-5509 Hydraulic Oil Filter..... H-5526 Hydraulic Oil Filter..... H-5510 Hydraulic Oil Filter..... H-55280 Hydraulic Oil Filter..... HC-55310 Hydraulic Oil Filter..... H-5503		D6H SERIES II (DOZERS) S/N: 8ZJ1-UP Air Filter Primary..... A-5549M Air Filter Primary..... A-5549 Air Filter Set..... A-5549M-S Air Filter Secondary..... A-5550	
D6H SERIES II (DOZERS) S/N: 6FC5500-UP		D6H SERIES II (DOZERS) S/N: 6FC5500-UP		D6H SERIES II (DOZERS) S/N: 8ZJ1-UP Air Filter Primary..... A-5549M Air Filter Primary..... A-5549 Air Filter Set..... A-5549M-S Air Filter Secondary..... A-5550	

MODEL/APPLICATION	SAKURA NO
-------------------	-----------

CATERPILLAR

**D6H SERIES II
(DOZERS)
S/N: 8ZJ1-UP**

Air Filter Secondary.....	A-5522
Hydraulic Oil Filter.....	H-55280
Hydraulic Oil Filter.....	H-5510
Hydraulic Oil Filter.....	H-5526
Hydraulic Oil Filter.....	H-5503

**D6H SERIES II
(DOZERS)
S/N: 9KJ1-429**

Air Filter Set.....	A-5549M-S
Air Filter Primary.....	A-5549M
Air Filter Secondary.....	A-5550
Air Filter Primary.....	A-5549
Hydraulic Oil Filter.....	H-5503
Hydraulic Oil Filter.....	HC-5511
Hydraulic Oil Filter.....	H-5526
Hydraulic Oil Filter.....	H-55280
Hydraulic Oil Filter.....	HC-55290
Hydraulic Oil Filter.....	H-5510

**D6H SERIES II
(DOZERS)
S/N: 9KJ430-UP**

Air Filter Secondary.....	A-5550
Air Filter Primary.....	A-5549
Air Filter Primary.....	A-5549M
Air Filter Set.....	A-5549M-S
Hydraulic Oil Filter.....	H-5510
Hydraulic Oil Filter.....	HC-55290
Hydraulic Oil Filter.....	H-5503
Hydraulic Oil Filter.....	H-5526
Hydraulic Oil Filter.....	HC-5511
Hydraulic Oil Filter.....	H-55280

**D6H SERIES II
(DOZERS)
S/N: 9LK1-360**

Air Filter Set.....	A-5549M-S
Air Filter Secondary.....	A-5550
Air Filter Secondary.....	A-5522
Air Filter Primary.....	A-5509
Air Filter Set.....	A-5522-S
Air Filter Primary.....	A-5549M
Air Filter Primary.....	A-5549
Hydraulic Oil Filter.....	H-5510
Hydraulic Oil Filter.....	H-5503
Hydraulic Oil Filter.....	HC-5511
Hydraulic Oil Filter.....	HC-55290

**D6H SERIES II
(DOZERS)
S/N: 9LK361-UP**

Air Filter Secondary.....	A-5550
Air Filter Primary.....	A-5549
Air Filter Primary.....	A-5549M
Air Filter Set.....	A-5549M-S
Hydraulic Oil Filter.....	HC-55290
Hydraulic Oil Filter.....	HC-5511
Hydraulic Oil Filter.....	H-5503
Hydraulic Oil Filter.....	H-5510

**D6H SERIES II
(DOZERS)
S/N: 9RK1-UP**

Air Filter Secondary.....	A-5522
Air Filter Primary.....	A-5509

MODEL/APPLICATION	SAKURA NO
-------------------	-----------

CATERPILLAR

Air Filter Set.....	A-5522-S
Fuel Filter.....	F-5505
Fuel Filter Secondary.....	FC-5507
Hydraulic Oil Filter.....	H-55280
Hydraulic Oil Filter.....	H-5503
Hydraulic Oil Filter.....	H-5510
Hydraulic Oil Filter.....	H-5526
Oil Filter Full Flow.....	C-5510

**D6H XL
(DOZERS)
S/N: 1YL,5KK,6CK,8KK,8ZJ,9KJ,9LK-UP**

Air Filter Primary.....	A-5549
Air Filter Secondary.....	A-5522
Air Filter Secondary.....	A-5550
Air Filter Primary.....	A-5549M
Air Filter Set.....	A-5549M-S
Fuel Filter Secondary.....	FC-5507
Fuel Filter.....	F-5505
Hydraulic Oil Filter.....	H-5510
Hydraulic Oil Filter.....	HC-5511
Hydraulic Oil Filter.....	H-5503
Oil Filter Full Flow.....	C-5510

**D6H XL
(DOZERS)
S/N: 8KK1-UP**

Air Filter Primary.....	A-5509
Air Filter Set.....	A-5522-S
Air Filter Secondary.....	A-5522
Fuel Filter Secondary.....	FC-5507
Hydraulic Oil Filter.....	H-5503
Hydraulic Oil Filter.....	H-5510
Oil Filter Full Flow.....	C-5510

**D6H XL
(DOZERS)
S/N: 8ZJ1-UP**

Air Filter Set.....	A-5549M-S
Air Filter Primary.....	A-5549M
Air Filter Primary.....	A-5549
Air Filter Secondary.....	A-5550
Fuel Filter Secondary.....	FC-5507
Fuel Filter.....	F-5505
Hydraulic Oil Filter.....	H-5510
Hydraulic Oil Filter.....	H-5503
Oil Filter Full Flow.....	C-5510

**D6H XL
(DOZERS)
S/N: 9KJ1-UP**

Air Filter Secondary.....	A-5550
Air Filter Set.....	A-5549M-S
Air Filter Primary.....	A-5549
Air Filter Primary.....	A-5549M
Fuel Filter Secondary.....	FC-5507
Fuel Filter.....	F-5505
Hydraulic Oil Filter.....	H-5503
Hydraulic Oil Filter.....	HC-5511
Hydraulic Oil Filter.....	H-5526
Hydraulic Oil Filter.....	H-5510
Hydraulic Oil Filter.....	H-55280
Oil Filter Full Flow.....	C-5510

**D6H XL
(DOZERS)
S/N: 9LK1-UP**

Air Filter Set.....	A-5522-S
Air Filter Secondary.....	A-5522

MODEL/APPLICATION	SAKURA NO
-------------------	-----------

CATERPILLAR

Air Filter Primary.....	A-5509
Fuel Filter Secondary.....	FC-5507
Hydraulic Oil Filter.....	H-5510
Hydraulic Oil Filter.....	H-5503
Hydraulic Oil Filter.....	HC-5511
Oil Filter Full Flow.....	C-5510

**D6H XL SERIES II
(DOZERS)
CAT 3306**

Cabin Air Filter.....	CA-55140
-----------------------	----------

**D6H XL SERIES II
(DOZERS)
S/N: 8KK1-UP**

Air Filter Primary.....	A-5509
Air Filter Set.....	A-5522-S
Air Filter Primary.....	A-5549M
Air Filter Set.....	A-5549M-S
Air Filter Primary.....	A-5549
Air Filter Secondary.....	A-5550
Air Filter Secondary.....	A-5522
Fuel Filter Secondary.....	FC-5507
Fuel Filter.....	F-5505
Hydraulic Oil Filter.....	H-55280
Hydraulic Oil Filter.....	H-5510
Hydraulic Oil Filter.....	H-5526
Hydraulic Oil Filter.....	H-5503
Oil Filter Full Flow.....	C-5510

**D6H XL SERIES II
(DOZERS)
S/N: 8ZJ1-UP**

Air Filter Set.....	A-5549M-S
Air Filter Primary.....	A-5549
Air Filter Primary.....	A-5549M
Air Filter Secondary.....	A-5550
Fuel Filter Secondary.....	FC-5507
Fuel Filter.....	F-5505
Hydraulic Oil Filter.....	H-5503
Hydraulic Oil Filter.....	H-5526
Hydraulic Oil Filter.....	H-5510
Hydraulic Oil Filter.....	H-55280
Oil Filter Full Flow.....	C-5510

**D6H XL SERIES II
(DOZERS)
S/N: 9LK1-UP**

Air Filter Set.....	A-5549M-S
Air Filter Secondary.....	A-5550
Air Filter Primary.....	A-5549M
Air Filter Primary.....	A-5549
Fuel Filter Secondary.....	FC-5507
Fuel Filter.....	F-5505
Hydraulic Oil Filter.....	H-5526
Hydraulic Oil Filter.....	H-5510
Hydraulic Oil Filter.....	H-55280
Hydraulic Oil Filter.....	HC-5511
Hydraulic Oil Filter.....	H-55280
Hydraulic Oil Filter.....	H-5503
Oil Filter Full Flow.....	C-5510

**D6H XR
(DOZERS)
S/N: 1YL1-UP**

Air Filter Set.....	A-5522-S
Air Filter Secondary.....	A-5522
Air Filter Primary.....	A-5509
Fuel Filter Secondary.....	FC-5507
Hydraulic Oil Filter.....	H-5503

MODEL/APPLICATION	SAKURA NO	MODEL/APPLICATION	SAKURA NO	MODEL/APPLICATION	SAKURA NO
CATERPILLAR		CATERPILLAR		CATERPILLAR	
D6H XR (DOZERS) S/N: 1YL1-UP		Hydraulic Oil Filter.....	H-5503	Fuel Filter Secondary.....	FC-5515
Oil Filter Full Flow.....	C-5510	Oil Filter Full Flow.....	C-5510	Hydraulic Oil Filter.....	H-5510
D6H XR (DOZERS) S/N: 2BL1-UP		D6H XR SERIES II (DOZERS) S/N: 5KK1-UP		Oil Filter Full Flow.....	C-5510
Air Filter Set.....	A-5522-S	Air Filter Set.....	A-5549M-S	D6M LGP (DOZERS) CAT 3116	
Air Filter Primary.....	A-5509	Air Filter Secondary.....	A-5550	Cabin Air Filter.....	CA-55140
Air Filter Secondary.....	A-5522	Air Filter Primary.....	A-5549	D6M LGP (DOZERS) S/N: 2YS1-UP	
Fuel Filter Secondary.....	FC-5507	Air Filter Primary.....	A-5549M	Air Filter Primary.....	A-5549M
Hydraulic Oil Filter.....	H-5503	Fuel Filter.....	F-5505	Air Filter Set.....	A-5549M-S
Oil Filter Full Flow.....	C-5510	Fuel Filter Secondary.....	FC-5507	Air Filter Primary.....	A-5549
D6H XR (DOZERS) S/N: 5KK1-UP		Hydraulic Oil Filter.....	H-5510	Air Filter Secondary.....	A-5550
Air Filter Secondary.....	A-5550	Hydraulic Oil Filter.....	H-5526	Fuel Filter.....	FC-5516
Air Filter Primary.....	A-5549	Hydraulic Oil Filter.....	H-5503	Fuel Filter Secondary.....	FC-5515
Air Filter Set.....	A-5549M-S	Hydraulic Oil Filter.....	H-5503	Fuel Filter Secondary.....	FC-55151
Air Filter Primary.....	A-5549M	Hydraulic Oil Filter.....	H-55280	Hydraulic Oil Filter.....	HC-55220
Fuel Filter Secondary.....	FC-5507	Oil Filter Full Flow.....	C-5510	Hydraulic Oil Filter.....	HC-5507
Hydraulic Oil Filter.....	H-5510	D6H XR SERIES II (DOZERS) S/N: 6CK1-UP		Hydraulic Oil Filter.....	H-5510
Hydraulic Oil Filter.....	H-5503	Air Filter Primary.....	A-5549	Oil Filter Full Flow.....	C-5510
Oil Filter Full Flow.....	C-5510	Air Filter Set.....	A-5549M-S	D6M LGP (DOZERS) S/N: 4GS1-UP	
D6H XR (DOZERS) S/N: 6CK1-UP		Air Filter Primary.....	A-5549M	Air Filter Set.....	A-5549M-S
Air Filter Primary.....	A-5549M	Air Filter Secondary.....	A-5550	Air Filter Secondary.....	A-5550
Air Filter Set.....	A-5549M-S	Fuel Filter.....	F-5505	Air Filter Primary.....	A-5549M
Air Filter Primary.....	A-5549	Fuel Filter Secondary.....	FC-5507	Air Filter Primary.....	A-5549
Air Filter Secondary.....	A-5550	Hydraulic Oil Filter.....	H-55280	Fuel Filter.....	FC-5516
Fuel Filter Secondary.....	FC-5507	Hydraulic Oil Filter.....	H-5526	Fuel Filter Secondary.....	FC-55151
Hydraulic Oil Filter.....	H-5503	Hydraulic Oil Filter.....	H-5503	Fuel Filter Secondary.....	FC-5515
Hydraulic Oil Filter.....	H-5510	Hydraulic Oil Filter.....	H-5510	Hydraulic Oil Filter.....	HC-55220
Oil Filter Full Flow.....	C-5510	Hydraulic Oil Filter.....	H-5511	Hydraulic Oil Filter.....	HC-5507
D6H XR SERIES II (DOZERS) CAT 3306		Oil Filter Full Flow.....	C-5510	Hydraulic Oil Filter.....	H-5510
Cabin Air Filter.....	CA-55140	D6K (DOZERS) CAT S/N: C6E1-UP , 2007-UP		Oil Filter Full Flow.....	C-5510
D6H XR SERIES II (DOZERS) S/N: 1YL1-UP		Fuel Filter.....	FC-5516	D6M LGP (DOZERS) S/N: 4HS1-UP	
Air Filter Primary.....	A-5549M	Fuel Filter Secondary.....	FC-5515	Air Filter Secondary.....	A-5550
Air Filter Set.....	A-5549M-S	Fuel Filter Secondary.....	FC-55151	Air Filter Set.....	A-5549M-S
Air Filter Primary.....	A-5549	Hydraulic Oil Filter.....	HC-5504	Air Filter Primary.....	A-5549M
Air Filter Secondary.....	A-5550	D6K (DOZERS) S/N: C6E1-UP		Air Filter Primary.....	A-5549
Fuel Filter Secondary.....	FC-5507	Fuel Filter Primary.....	FC-55300	Fuel Filter Secondary.....	FC-5515
Fuel Filter.....	F-5505	D6K LGP (DOZERS) w/C6.6 Eng.		Fuel Filter.....	FC-5516
Hydraulic Oil Filter.....	HC-5511	Fuel/Water Separator.....	SFC-55170	Fuel Filter Secondary.....	FC-55151
Hydraulic Oil Filter.....	H-55280	D6K XL (DOZERS) w/C6.6 Eng.		Hydraulic Oil Filter.....	HC-55220
Hydraulic Oil Filter.....	H-5510	Fuel/Water Separator.....	SFC-55170	Hydraulic Oil Filter.....	H-5510
Hydraulic Oil Filter.....	H-5503	D6M (DOZERS) S/N: 5WF1-UP		Hydraulic Oil Filter.....	HC-5507
Hydraulic Oil Filter.....	H-5526	Air Filter Primary.....	A-5549	Hydraulic Oil Filter.....	H-5526
Oil Filter Full Flow.....	C-5510	Air Filter Secondary.....	A-5550	Hydraulic Oil Filter.....	HC-55220
D6H XR SERIES II (DOZERS) S/N: 2BL1-UP		Air Filter Set.....	A-5549M-S	Oil Filter Full Flow.....	C-5510
Air Filter Primary.....	A-5509	Air Filter Primary.....	A-5549M	D6M LGP (DOZERS) S/N: 5NR1-UP	
Air Filter Set.....	A-5522-S	Fuel Filter Secondary.....	FC-5515	Air Filter Primary.....	A-5549
Air Filter Secondary.....	A-5522	Fuel Filter.....	FC-5516	Air Filter Secondary.....	A-5550
Fuel Filter Secondary.....	FC-5507	Hydraulic Oil Filter.....	H-5510	Air Filter Set.....	A-5549M-S
Fuel Filter.....	F-5505	Hydraulic Oil Filter.....	H-55280	Air Filter Primary.....	A-5549M
Hydraulic Oil Filter.....	H-5526	Hydraulic Oil Filter.....	H-5503	Fuel Filter Secondary.....	FC-55151
Hydraulic Oil Filter.....	H-5510	Hydraulic Oil Filter.....	H-5526	Fuel Filter.....	FC-5516
Hydraulic Oil Filter.....	H-55280	Oil Filter Full Flow.....	C-5510	Fuel Filter Secondary.....	FC-5515

Sakura Filter

ENGINE APPLICATION

MODEL/APPLICATION	SAKURA NO
CATERPILLAR	
D6M LGP (DOZERS) S/N: 92M1-UP	
Air Filter Primary.....	A-5549
Air Filter Secondary.....	A-5550
Air Filter Primary.....	A-5549M
Air Filter Set.....	A-5549M-S
Fuel Filter Secondary.....	FC-55151
Fuel Filter Secondary.....	FC-5515
Fuel Filter.....	FC-5516
Fuel Filter.....	FC-5508
Hydraulic Oil Filter.....	H-5526
Hydraulic Oil Filter.....	H-5510
Oil Filter Full Flow.....	C-5510
D6M XL (DOZERS) CAT 3116	
Cabin Air Filter.....	CA-55140
D6M XL (DOZERS) S/N: 2YS1-UP	
Air Filter Secondary.....	A-5550
Air Filter Set.....	A-5549M-S
Air Filter Primary.....	A-5549M
Air Filter Primary.....	A-5549
Fuel Filter.....	FC-5516
Fuel Filter Secondary.....	FC-55151
Fuel Filter Secondary.....	FC-5515
Hydraulic Oil Filter.....	H-5510
Hydraulic Oil Filter.....	HC-5507
Hydraulic Oil Filter.....	HC-55220
Oil Filter Full Flow.....	C-5510
D6M XL (DOZERS) S/N: 4GS1-UP	
Air Filter Primary.....	A-5549M
Air Filter Primary.....	A-5549
Air Filter Secondary.....	A-5550
Air Filter Set.....	A-5549M-S
Fuel Filter Secondary.....	FC-55151
Fuel Filter.....	FC-5516
Fuel Filter Secondary.....	FC-5515
Hydraulic Oil Filter.....	HC-55220
Hydraulic Oil Filter.....	H-5510
Hydraulic Oil Filter.....	HC-5507
Oil Filter Full Flow.....	C-5510
D6M XL (DOZERS) S/N: 4HS1-UP	
Air Filter Secondary.....	A-5550
Air Filter Primary.....	A-5549M
Air Filter Primary.....	A-5549
Air Filter Set.....	A-5549M-S
Fuel Filter.....	FC-5516
Fuel Filter Secondary.....	FC-5515
Hydraulic Oil Filter.....	HC-55220
Hydraulic Oil Filter.....	H-5510
Hydraulic Oil Filter.....	HC-5507
Oil Filter Full Flow.....	C-5510
D6M XL (DOZERS) S/N: 5NR1-UP	
Air Filter Primary.....	A-5549M

MODEL/APPLICATION	SAKURA NO
CATERPILLAR	
Air Filter Set.....	A-5549M-S
Air Filter Primary.....	A-5549
Air Filter Secondary.....	A-5550
Fuel Filter Secondary.....	FC-55151
Fuel Filter Secondary.....	FC-5515
Fuel Filter.....	FC-5516
Hydraulic Oil Filter.....	HC-55220
Hydraulic Oil Filter.....	H-5510
Hydraulic Oil Filter.....	HC-5507
Oil Filter Full Flow.....	C-5510
D6N (DOZERS) CAT (S/N: BMA1-UP)	
Fuel Filter.....	FC-5517
Oil Filter Full Flow.....	C-5522
D6N (DOZERS) CAT (S/N: C6E1-UP)	
Fuel Filter Secondary.....	FC-55151
Fuel Filter.....	FC-5516
Fuel Filter Secondary.....	FC-5515
D6N (DOZERS) S/N: AKM1-675-UP	
Air Filter Primary.....	A-5549M
Air Filter.....	A-5547
Air Filter Set.....	A-5549M-S
Air Filter Primary.....	A-5549
Air Filter Secondary.....	A-5550
Hydraulic Oil Filter.....	H-55280
Hydraulic Oil Filter.....	H-5526
Hydraulic Oil Filter.....	H-5510
Hydraulic Oil Filter.....	HC-5504
D6N (DOZERS) S/N: AKM1794-1821-UP	
Air Filter Primary.....	A-5549
Air Filter Primary.....	A-5549M
Air Filter Secondary.....	A-5550
Air Filter Set.....	A-5549M-S
Air Filter.....	A-5547
Hydraulic Oil Filter.....	HC-5504
Hydraulic Oil Filter.....	H-5510
D6N (DOZERS) S/N: AKM1822-UP	
Air Filter Primary.....	A-5549M
Air Filter Set.....	A-5549M-S
Air Filter.....	A-5547
Air Filter Secondary.....	A-5550
Air Filter Primary.....	A-5549
Hydraulic Oil Filter.....	H-5510
Hydraulic Oil Filter.....	HC-5504
D6N (DOZERS) S/N: AKM676-1793-UP	
Air Filter Primary.....	A-5549M
Air Filter Primary.....	A-5549
Air Filter.....	A-5547
Air Filter Set.....	A-5549M-S
Air Filter Secondary.....	A-5550
Hydraulic Oil Filter.....	HC-5504
Hydraulic Oil Filter.....	H-5510
Hydraulic Oil Filter.....	HC-5504

MODEL/APPLICATION	SAKURA NO
CATERPILLAR	
D6N (DOZERS) S/N: ALH1-197-UP	
Air Filter Secondary.....	A-5550
Air Filter Primary.....	A-5549
Air Filter Set.....	A-5549M-S
Air Filter.....	A-5547
Air Filter Primary.....	A-5549M
Hydraulic Oil Filter.....	H-5526
Hydraulic Oil Filter.....	HC-55220
Hydraulic Oil Filter.....	H-5510
Hydraulic Oil Filter.....	HC-5507
Hydraulic Oil Filter.....	H-55280
Hydraulic Oil Filter.....	HC-55220
D6N (DOZERS) S/N: ALH198-253-UP	
Air Filter Primary.....	A-5549
Air Filter Secondary.....	A-5550
Air Filter.....	A-5547
Air Filter Set.....	A-5549M-S
Air Filter Primary.....	A-5549M
Hydraulic Oil Filter.....	H-5510
Hydraulic Oil Filter.....	HC-5507
Hydraulic Oil Filter.....	H-5526
Hydraulic Oil Filter.....	H-55280
Hydraulic Oil Filter.....	HC-55220
D6N (DOZERS) S/N: ALH254-346-UP	
Air Filter Set.....	A-5549M-S
Air Filter Primary.....	A-5549M
Air Filter Secondary.....	A-5550
Air Filter.....	A-5547
Air Filter Primary.....	A-5549
Hydraulic Oil Filter.....	H-5510
Hydraulic Oil Filter.....	H-5526
Hydraulic Oil Filter.....	H-55280
D6N (DOZERS) S/N: ALH347-UP	
Air Filter Set.....	A-5549M-S
Air Filter.....	A-5547
Air Filter Primary.....	A-5549M
Air Filter Primary.....	A-5549
Air Filter Secondary.....	A-5550
Hydraulic Oil Filter.....	H-5510
D6N (DOZERS) S/N: ALR1-219-UP	
Air Filter Secondary.....	A-5550
Air Filter.....	A-5547
Air Filter Primary.....	A-5549
Air Filter Set.....	A-5549M-S
Air Filter Primary.....	A-5549M
Hydraulic Oil Filter.....	HC-55220
Hydraulic Oil Filter.....	H-5510
Hydraulic Oil Filter.....	H-55280
Hydraulic Oil Filter.....	H-5526
Hydraulic Oil Filter.....	HC-5507
D6N (DOZERS) S/N: ALR220-251-UP	
Air Filter Set.....	A-5549M-S
Air Filter Primary.....	A-5549

MODEL/APPLICATION	SAKURA NO
CATERPILLAR	
D6N (DOZERS) S/N: ALR220-251-UP	
Air Filter Primary.....	A-5549M
Air Filter.....	A-5547
Air Filter Secondary.....	A-5550
Hydraulic Oil Filter.....	HC-55220
Hydraulic Oil Filter.....	H-5526
Hydraulic Oil Filter.....	H-55280
Hydraulic Oil Filter.....	H-5510
Hydraulic Oil Filter.....	HC-5507
D6N (DOZERS) S/N: ALR252-323-UP	
Air Filter Secondary.....	A-5550
Air Filter Set.....	A-5549M-S
Air Filter.....	A-5547
Air Filter Primary.....	A-5549M
Air Filter Primary.....	A-5549
Hydraulic Oil Filter.....	H-5510
Hydraulic Oil Filter.....	H-5526
Hydraulic Oil Filter.....	H-55280
D6N (DOZERS) S/N: ALR324-UP	
Air Filter Primary.....	A-5549
Air Filter Primary.....	A-5549M
Air Filter Secondary.....	A-5550
Air Filter Set.....	A-5549M-S
Air Filter.....	A-5547
Hydraulic Oil Filter.....	H-5510
D6N (DOZERS) S/N: ALY1-705-UP	
Air Filter Secondary.....	A-5550
Air Filter Primary.....	A-5549
Air Filter Set.....	A-5549M-S
Air Filter Primary.....	A-5549M
Air Filter.....	A-5547
Hydraulic Oil Filter.....	H-55280
Hydraulic Oil Filter.....	H-5526
Hydraulic Oil Filter.....	H-5510
Hydraulic Oil Filter.....	HC-5504
D6N (DOZERS) S/N: ALY2066-2102-UP	
Air Filter Secondary.....	A-5550
Air Filter.....	A-5547
Air Filter Set.....	A-5549M-S
Air Filter Primary.....	A-5549M
Air Filter Primary.....	A-5549
Hydraulic Oil Filter.....	H-5510
Hydraulic Oil Filter.....	HC-5504
D6N (DOZERS) S/N: ALY2103-UP	
Air Filter Secondary.....	A-5550
Air Filter Primary.....	A-5549
Air Filter.....	A-5547
Air Filter Set.....	A-5549M-S
Air Filter Primary.....	A-5549M
Air Filter Primary.....	A-5549
Hydraulic Oil Filter.....	H-5510
Hydraulic Oil Filter.....	HC-5504

MODEL/APPLICATION	SAKURA NO
CATERPILLAR	
D6N (DOZERS) S/N: ALY706-2065-UP	
Air Filter Primary.....	A-5549
Air Filter Set.....	A-5549M-S
Air Filter.....	A-5547
Air Filter Secondary.....	A-5550
Air Filter Primary.....	A-5549M
Hydraulic Oil Filter.....	H-5510
Hydraulic Oil Filter.....	HC-5504
D6N (DOZERS) S/N: CBJ1-259-UP	
Air Filter Secondary.....	A-5550
Air Filter.....	A-5547
Air Filter Set.....	A-5549M-S
Air Filter Primary.....	A-5549
Air Filter Primary.....	A-5549M
Hydraulic Oil Filter.....	HC-5507
Hydraulic Oil Filter.....	H-55280
Hydraulic Oil Filter.....	HC-55220
Hydraulic Oil Filter.....	H-5510
Hydraulic Oil Filter.....	H-5526
D6N (DOZERS) S/N: CBJ260-399-UP	
Air Filter Primary.....	A-5549M
Air Filter.....	A-5547
Air Filter Primary.....	A-5549
Air Filter Set.....	A-5549M-S
Air Filter Secondary.....	A-5550
Hydraulic Oil Filter.....	HC-55220
Hydraulic Oil Filter.....	H-5510
D6N (DOZERS) S/N: CBJ400-504-UP	
Air Filter Set.....	A-5549M-S
Air Filter.....	A-5547
Air Filter Primary.....	A-5549
Air Filter Secondary.....	A-5550
Air Filter Primary.....	A-5549M
Hydraulic Oil Filter.....	HC-5507
Hydraulic Oil Filter.....	H-5510
Hydraulic Oil Filter.....	HC-55220
D6N (DOZERS) S/N: CBJ505-UP	
Air Filter Set.....	A-5549M-S
Air Filter Primary.....	A-5549
Air Filter Primary.....	A-5549M
Air Filter.....	A-5547
Air Filter Secondary.....	A-5550
Hydraulic Oil Filter.....	HC-5507
Hydraulic Oil Filter.....	HC-55220
Hydraulic Oil Filter.....	H-5510
D6N (DOZERS) S/N: CCK1-366-UP	
Air Filter.....	A-5547
Air Filter Set.....	A-5549M-S
Air Filter Secondary.....	A-5550
Air Filter Primary.....	A-5549M
Air Filter Primary.....	A-5549
Hydraulic Oil Filter.....	H-5510

MODEL/APPLICATION	SAKURA NO
CATERPILLAR	
Hydraulic Oil Filter.....	HC-5504
Hydraulic Oil Filter.....	H-5526
Hydraulic Oil Filter.....	H-55280
D6N (DOZERS) S/N: CCK367-691-UP	
Air Filter Primary.....	A-5549M
Air Filter Secondary.....	A-5550
Air Filter Primary.....	A-5549
Air Filter.....	A-5547
Air Filter Set.....	A-5549M-S
Hydraulic Oil Filter.....	H-5510
Hydraulic Oil Filter.....	HC-5504
D6N (DOZERS) S/N: CCK692-701-UP	
Air Filter.....	A-5547
Air Filter Set.....	A-5549M-S
Air Filter Primary.....	A-5549
Air Filter Primary.....	A-5549M
Air Filter Secondary.....	A-5550
Hydraulic Oil Filter.....	H-5510
Hydraulic Oil Filter.....	HC-5504
D6N (DOZERS) S/N: CCK709-UP	
Air Filter Secondary.....	A-5550
Air Filter.....	A-5547
Air Filter Set.....	A-5549M-S
Air Filter Primary.....	A-5549M
Air Filter Primary.....	A-5549
Hydraulic Oil Filter.....	H-5510
Hydraulic Oil Filter.....	HC-5504
D6N (DOZERS) S/N: CCK702-708-UP	
Air Filter Secondary.....	A-5550
Air Filter Set.....	A-5549M-S
Air Filter.....	A-5547
Air Filter Primary.....	A-5549
Air Filter Primary.....	A-5549M
Hydraulic Oil Filter.....	HC-5504
Hydraulic Oil Filter.....	H-5510
D6N (DOZERS) S/N: DJA1-UP	
Air Filter.....	A-5547
Hydraulic Oil Filter.....	HC-5504
Hydraulic Oil Filter.....	H-5510
D6N (DOZERS) S/N: DJY1-UP	
Air Filter.....	A-5547
Hydraulic Oil Filter.....	HC-5504
Hydraulic Oil Filter.....	H-5510
D6N (DOZERS) S/N: PBA1-1007	
Hydraulic Oil Filter Transmission...	EH-55070
D6N (DOZERS) W/3126B Eng.	
Hydraulic Oil Filter.....	HC-55280
D6N (DOZERS) W/C6.6 ENG. (EXC. S/N: PBA, PER)	

MODEL/APPLICATION	SAKURA NO
CATERPILLAR	
D6N (DOZERS) W/C6.6 ENG. (EXC. S/N: PBA, PER) Fuel/Water Separator.....	SFC-55170
D6N (DOZERS) w/C9 Eng. Hydraulic Oil Filter.....	HC-55280
D6N FTC (DOZERS) w/3126B Eng. Hydraulic Oil Filter.....	HC-55280
D6N LGP (DOZERS) CAT 3126B Fuel Filter.....	EF-55050
D6N LGP (DOZERS) w/3126B Eng. Hydraulic Oil Filter.....	HC-55280
D6N LGP (DOZERS) W/C6.6 ENG. (EXC. S/N: PBA, PER) Fuel/Water Separator.....	SFC-55170
D6N XL (DOZERS) CAT 3126B Fuel Filter.....	EF-55050
D6N XL (DOZERS) w/3126B Eng. Hydraulic Oil Filter.....	HC-55280
D6N XL (DOZERS) W/C6.6 ENG. (EXC. S/N: PBA, PER) Fuel/Water Separator.....	SFC-55170
D6N WHA (DOZERS) CAT 3126B Fuel Filter.....	EF-55050
D6R (DOZERS) CAT 3306 Cabin Air Filter.....	CA-55140
D6R (DOZERS) CAT C9 (S/N: 1RW1-UP) Air Filter Secondary..... Air Filter Set..... Air Filter Primary..... Air Filter Primary..... Fuel Filter Secondary..... Fuel Filter..... Hydraulic Oil Filter..... Hydraulic Oil Filter..... Hydraulic Oil Filter..... Oil Filter Full Flow.....	A-5550 A-5549M-S A-5549 A-5549M FC-5507 F-5505 HC-5511 H-5526 H-5510 C-5510
D6R (DOZERS) CAT C9 (S/N: 2HM1-UP) Air Filter Primary..... Air Filter Primary..... Air Filter Set..... Air Filter Secondary..... Fuel Filter..... Fuel Filter Secondary..... Fuel Filter..... Hydraulic Oil Filter.....	A-5549 A-5549M A-5549M-S A-5550 FC-5519 FC-5507 F-5505 HC-5511 H-5510
D6R (DOZERS) CAT C9 (S/N: 4JR1-UP) Air Filter Primary..... Air Filter Primary..... Air Filter Secondary.....	A-5549M A-5549 A-5550

MODEL/APPLICATION	SAKURA NO
CATERPILLAR	
Hydraulic Oil Filter.....	H-5526
Hydraulic Oil Filter.....	HC-5511
Oil Filter Full Flow.....	C-5510
D6R (DOZERS) CAT C9 (S/N: 2YN1-UP) Air Filter Primary..... Air Filter Secondary..... Air Filter Primary..... Air Filter Set..... Fuel Filter..... Fuel Filter..... Fuel Filter Secondary..... Hydraulic Oil Filter..... Hydraulic Oil Filter..... Hydraulic Oil Filter..... Oil Filter Full Flow.....	A-5549 A-5550 A-5549M A-5549M-S FC-5519 F-5505 FC-5507 H-5510 HC-5511 H-5526 C-5510
D6R (DOZERS) CAT C9 (S/N: 3ZN1-UP) Air Filter Set..... Air Filter Primary..... Air Filter Primary..... Air Filter Secondary..... Fuel Filter..... Fuel Filter Secondary..... Fuel Filter..... Fuel Filter..... Hydraulic Oil Filter..... Hydraulic Oil Filter..... Hydraulic Oil Filter..... Hydraulic Oil Filter..... Oil Filter Full Flow.....	A-5549M-S A-5549 A-5549M A-5550 F-5505 FC-5507 FC-5519 H-5526 H-5510 HC-5511 C-5510
D6R (DOZERS) CAT C9 (S/N: 4FM/8TM/9BM-UP) Air Filter Secondary..... Air Filter Primary..... Air Filter Primary..... Air Filter Set..... Fuel Filter Secondary..... Fuel Filter..... Hydraulic Oil Filter..... Hydraulic Oil Filter..... Hydraulic Oil Filter..... Oil Filter Full Flow.....	A-5550 A-5549 A-5549M A-5549M-S FC-5507 F-5505 H-5510 H-5526 HC-5511 C-5510
D6R (DOZERS) CAT C9 (S/N: 4FM1-UP) Air Filter Primary..... Air Filter Set..... Air Filter Secondary..... Air Filter Primary..... Fuel Filter..... Fuel Filter Secondary..... Fuel Filter..... Hydraulic Oil Filter..... Hydraulic Oil Filter..... Hydraulic Oil Filter..... Oil Filter Full Flow.....	A-5549 A-5549M-S A-5550 A-5549M F-5505 FC-5507 FC-5519 H-5526 H-5510 HC-5511 C-5510
D6R (DOZERS) CAT C9 (S/N: 5PR1-UP) Air Filter Set..... Air Filter Secondary..... Air Filter Primary..... Air Filter Primary..... Fuel Filter..... Fuel Filter..... Fuel Filter Secondary..... Hydraulic Oil Filter..... Hydraulic Oil Filter..... Hydraulic Oil Filter..... Oil Filter Full Flow.....	A-5549M-S A-5550 A-5549M A-5549 F-5505 FC-5519 FC-5507 H-5526 H-5510 HC-5511 C-5510

MODEL/APPLICATION	SAKURA NO
CATERPILLAR	
Air Filter Set.....	A-5549M-S
Fuel Filter.....	F-5505
Fuel Filter.....	FC-5519
Fuel Filter Secondary.....	FC-5507
Hydraulic Oil Filter.....	HC-5511
Hydraulic Oil Filter.....	H-5510
Hydraulic Oil Filter.....	H-5526
Oil Filter Full Flow.....	C-5510
D6R (DOZERS) CAT C9 (S/N: 4TR1-UP) Air Filter Secondary..... Air Filter Primary..... Air Filter Primary..... Air Filter Set..... Fuel Filter..... Fuel Filter Secondary..... Fuel Filter..... Hydraulic Oil Filter..... Hydraulic Oil Filter..... Hydraulic Oil Filter..... Oil Filter Full Flow.....	A-5550 A-5549 A-5549M A-5549M-S FC-5519 FC-5507 F-5505 HC-5511 H-5510 H-5526 C-5510
D6R (DOZERS) CAT C9 (S/N: 4WF1-UP) Air Filter Secondary..... Air Filter Primary..... Air Filter Primary..... Air Filter Set..... Fuel Filter..... Fuel Filter Secondary..... Fuel Filter..... Hydraulic Oil Filter..... Hydraulic Oil Filter..... Hydraulic Oil Filter..... Oil Filter Full Flow.....	A-5550 A-5549 A-5549M A-5549M-S F-5505 FC-5507 FC-5519 H-5510 H-5526 HC-5511 C-5510
D6R (DOZERS) CAT C9 (S/N: 5LN1-UP) Air Filter Primary..... Air Filter Primary..... Air Filter Set..... Air Filter Secondary..... Fuel Filter..... Fuel Filter..... Fuel Filter Secondary..... Hydraulic Oil Filter..... Hydraulic Oil Filter..... Hydraulic Oil Filter..... Oil Filter Full Flow.....	A-5549M A-5549 A-5549M-S A-5550 F-5505 FC-5519 FC-5507 H-5526 H-5510 HC-5511 C-5510
D6R (DOZERS) CAT C9 (S/N: 5PR1-UP) Air Filter Set..... Air Filter Secondary..... Air Filter Primary..... Air Filter Primary..... Fuel Filter..... Fuel Filter..... Fuel Filter Secondary..... Hydraulic Oil Filter..... Hydraulic Oil Filter..... Hydraulic Oil Filter..... Oil Filter Full Flow.....	A-5549M-S A-5550 A-5549M A-5549 F-5505 FC-5519 FC-5507 H-5526 H-5510 HC-5511 C-5510

Sakura Filter

ENGINE APPLICATION

MODEL/APPLICATION	SAKURA NO
CATERPILLAR	
D6R (DOZERS) CAT C9 (S/N: 5PR1-UP)	
Oil Filter Full Flow.....	C-5510
D6R (DOZERS) CAT C9 (S/N: 6FR1-UP)	
Air Filter Secondary.....	A-5550
Air Filter Set.....	A-5549M-S
Air Filter Primary.....	A-5549M
Air Filter Primary.....	A-5549
Fuel Filter.....	F-5505
Fuel Filter Secondary.....	FC-5507
Fuel Filter.....	FC-5519
Hydraulic Oil Filter.....	HC-5511
Hydraulic Oil Filter.....	H-5510
Hydraulic Oil Filter.....	H-5526
Oil Filter Full Flow.....	C-5510
D6R (DOZERS) CAT C9 (S/N: 6MR1-UP)	
Air Filter Secondary.....	A-5550
Air Filter Set.....	A-5549M-S
Air Filter Primary.....	A-5549
Air Filter Primary.....	A-5549M
Fuel Filter Secondary.....	FC-5507
Fuel Filter.....	FC-5519
Fuel Filter.....	F-5505
Hydraulic Oil Filter.....	H-5510
Hydraulic Oil Filter.....	H-5526
Hydraulic Oil Filter.....	HC-5511
Oil Filter Full Flow.....	C-5510
D6R (DOZERS) CAT C9 (S/N: 7DR1-UP)	
Air Filter Secondary.....	A-5550
Air Filter Primary.....	A-5549M
Air Filter Primary.....	A-5549
Air Filter Set.....	A-5549M-S
Fuel Filter Secondary.....	FC-5507
Fuel Filter.....	FC-5519
Fuel Filter.....	F-5505
Hydraulic Oil Filter.....	HC-5511
Hydraulic Oil Filter.....	H-5526
Hydraulic Oil Filter.....	H-5510
Oil Filter Full Flow.....	C-5510
D6R (DOZERS) CAT C9 (S/N: 7GR1-UP)	
Air Filter Primary.....	A-5549
Air Filter Set.....	A-5549M-S
Air Filter Primary.....	A-5549M
Air Filter Secondary.....	A-5550
Fuel Filter Secondary.....	FC-5507
Fuel Filter.....	FC-5519
Fuel Filter.....	F-5505
Hydraulic Oil Filter.....	H-5526
Hydraulic Oil Filter.....	H-5510
Hydraulic Oil Filter.....	HC-5511
Oil Filter Full Flow.....	C-5510
D6R (DOZERS) CAT C9 (S/N: 7KN1-UP)	
Air Filter Primary.....	A-5549M
Air Filter Secondary.....	A-5550

MODEL/APPLICATION	SAKURA NO
CATERPILLAR	
Air Filter Set.....	A-5549M-S
Air Filter Primary.....	A-5549
Fuel Filter.....	F-5505
Fuel Filter.....	FC-5519
Fuel Filter Secondary.....	FC-5507
Hydraulic Oil Filter.....	H-5510
Hydraulic Oil Filter.....	HC-5511
Hydraulic Oil Filter.....	H-5526
Oil Filter Full Flow.....	C-5510
D6R (DOZERS) CAT C9 (S/N: 8LN1-UP)	
Air Filter Secondary.....	A-5550
Air Filter Primary.....	A-5549
Air Filter Primary.....	A-5549M
Air Filter Set.....	A-5549M-S
Fuel Filter Secondary.....	FC-5507
Fuel Filter.....	FC-5519
Fuel Filter.....	F-5505
Hydraulic Oil Filter.....	H-5510
Hydraulic Oil Filter.....	HC-5511
Hydraulic Oil Filter.....	H-5526
Oil Filter Full Flow.....	C-5510
D6R (DOZERS) CAT C9 (S/N: 9BM1-UP)	
Air Filter Primary.....	A-5549
Air Filter Primary.....	A-5549M
Air Filter Set.....	A-5549M-S
Air Filter Secondary.....	A-5550
Fuel Filter Secondary.....	FC-5507
Fuel Filter.....	FC-5519
Fuel Filter.....	F-5505
Hydraulic Oil Filter.....	H-5510
Hydraulic Oil Filter.....	H-5526
Hydraulic Oil Filter.....	HC-5511
Oil Filter Full Flow.....	C-5510
D6R (DOZERS) CAT C9 (S/N: 9MN1-UP)	
Air Filter Primary.....	A-5549M
Air Filter Set.....	A-5549M-S
Air Filter Primary.....	A-5549
Air Filter Secondary.....	A-5550
Fuel Filter.....	FC-5519
Fuel Filter.....	F-5505
Fuel Filter Secondary.....	FC-5507
Hydraulic Oil Filter.....	H-5526
Hydraulic Oil Filter.....	H-5510
Hydraulic Oil Filter.....	HC-5511
Oil Filter Full Flow.....	C-5510
D6R (DOZERS) CAT C9 (S/N: 9PN1-UP)	
Air Filter Secondary.....	A-5550
Air Filter Set.....	A-5549M-S
Air Filter Primary.....	A-5549
Air Filter Primary.....	A-5549M
Fuel Filter Secondary.....	FC-5507
Fuel Filter.....	FC-5519
Fuel Filter.....	F-5505
Hydraulic Oil Filter.....	H-5526
Hydraulic Oil Filter.....	H-5510
Hydraulic Oil Filter.....	HC-5511

MODEL/APPLICATION	SAKURA NO
CATERPILLAR	
Hydraulic Oil Filter.....	H-5510
Oil Filter Full Flow.....	C-5510
D6R (DOZERS) CAT C9 (S/N: 9ZS1-UP)	
Air Filter Primary.....	A-5549
Air Filter Primary.....	A-5549M
Air Filter Set.....	A-5549M-S
Air Filter Secondary.....	A-5550
Fuel Filter.....	F-5505
Fuel Filter Secondary.....	FC-5507
Fuel Filter.....	FC-5519
Hydraulic Oil Filter.....	H-5510
Hydraulic Oil Filter.....	HC-5511
Hydraulic Oil Filter.....	H-5526
Oil Filter Full Flow.....	C-5510
D6R (DOZERS) S/N: 1RW1-UP	
Air Filter Primary.....	A-5549M
Air Filter Primary.....	A-5549
Air Filter Set.....	A-5549M-S
Air Filter Secondary.....	A-5550
Hydraulic Oil Filter.....	HC-5511
Hydraulic Oil Filter.....	H-5526
Hydraulic Oil Filter.....	HC-55290
Hydraulic Oil Filter.....	H-55280
Hydraulic Oil Filter.....	H-5510
D6R (DOZERS) S/N: 2HM1-UP	
Air Filter Secondary.....	A-5550
Air Filter Primary.....	A-5549
Air Filter Set.....	A-5549M-S
Air Filter Primary.....	A-5549M
Hydraulic Oil Filter.....	HC-55290
Hydraulic Oil Filter.....	HC-5511
Hydraulic Oil Filter.....	H-55280
Hydraulic Oil Filter.....	H-5510
Hydraulic Oil Filter.....	H-5526
D6R (DOZERS) S/N: 2YN1-UP	
Air Filter Primary.....	A-5549M
Air Filter Set.....	A-5549M-S
Air Filter Secondary.....	A-5550
Air Filter Primary.....	A-5549
Hydraulic Oil Filter.....	H-5510
Hydraulic Oil Filter.....	H-5526
Hydraulic Oil Filter.....	H-55280
Hydraulic Oil Filter.....	HC-5511
Hydraulic Oil Filter.....	HC-55290
D6R (DOZERS) S/N: 3ZN1-UP	
Air Filter Primary.....	A-5549M
Air Filter Secondary.....	A-5550
Air Filter Set.....	A-5549M-S
Air Filter Primary.....	A-5549
Hydraulic Oil Filter.....	H-5510
Hydraulic Oil Filter.....	HC-55290
Hydraulic Oil Filter.....	HC-5511
Hydraulic Oil Filter.....	H-5526
Hydraulic Oil Filter.....	H-55280

MODEL/APPLICATION	SAKURA NO
CATERPILLAR	
D6R (DOZERS) S/N: 4FM1-UP	
Air Filter Primary.....	A-5549M
Air Filter Primary.....	A-5549
Air Filter Secondary.....	A-5550
Air Filter Set.....	A-5549M-S
Hydraulic Oil Filter.....	HC-5511
Hydraulic Oil Filter.....	H-55280
Hydraulic Oil Filter.....	HC-55290
Hydraulic Oil Filter.....	H-5510
Hydraulic Oil Filter.....	H-5526
D6R (DOZERS) S/N: 4HN1-UP	
Air Filter Secondary.....	A-5550
Air Filter Set.....	A-5549M-S
Air Filter Primary.....	A-5549M
Air Filter Primary.....	A-5549
Hydraulic Oil Filter.....	H-5510
Hydraulic Oil Filter.....	H-5526
Hydraulic Oil Filter.....	HC-55290
Hydraulic Oil Filter.....	H-55280
Hydraulic Oil Filter.....	HC-5511
D6R (DOZERS) S/N: 4JR1-UP	
Air Filter Primary.....	A-5549M
Air Filter Secondary.....	A-5550
Air Filter Primary.....	A-5549
Air Filter Set.....	A-5549M-S
Hydraulic Oil Filter.....	HC-5511
Hydraulic Oil Filter.....	H-5510
Hydraulic Oil Filter.....	H-5526
Hydraulic Oil Filter.....	HC-55290
Hydraulic Oil Filter.....	H-5510
Hydraulic Oil Filter.....	H-55280
D6R (DOZERS) S/N: 4MN1-UP	
Air Filter Primary.....	A-5549
Air Filter Primary.....	A-5549M
Air Filter Set.....	A-5549M-S
Air Filter Secondary.....	A-5550
Hydraulic Oil Filter.....	H-55280
Hydraulic Oil Filter.....	HC-55290
Hydraulic Oil Filter.....	HC-5511
Hydraulic Oil Filter.....	H-5510
Hydraulic Oil Filter.....	H-5526
D6R (DOZERS) S/N: 5LN1-UP	
Air Filter Secondary.....	A-5550
Air Filter Primary.....	A-5549M
Air Filter Primary.....	A-5549
Air Filter Set.....	A-5549M-S
Hydraulic Oil Filter.....	H-5526
Hydraulic Oil Filter.....	HC-5511
Hydraulic Oil Filter.....	HC-55290
Hydraulic Oil Filter.....	H-5510
Hydraulic Oil Filter.....	H-55280
Hydraulic Oil Filter.....	H-5510
D6R (DOZERS) S/N: 6JN1-UP	
Air Filter Primary.....	A-5549

MODEL/APPLICATION	SAKURA NO
CATERPILLAR	
Air Filter Secondary.....	A-5550
Air Filter Set.....	A-5549M-S
Air Filter Primary.....	A-5549M
Hydraulic Oil Filter.....	HC-55290
Hydraulic Oil Filter.....	H-55280
Hydraulic Oil Filter.....	HC-5511
Hydraulic Oil Filter.....	H-5510
Hydraulic Oil Filter.....	H-5526
D6R (DOZERS) S/N: 6MR1-UP	
Air Filter Secondary.....	A-5550
Air Filter Primary.....	A-5549M
Air Filter Primary.....	A-5549
Air Filter Set.....	A-5549M-S
Hydraulic Oil Filter.....	HC-55290
Hydraulic Oil Filter.....	H-5526
Hydraulic Oil Filter.....	H-5510
Hydraulic Oil Filter.....	HC-5511
Hydraulic Oil Filter.....	H-55280
D6R (DOZERS) S/N: 7GR1-UP	
Air Filter Primary.....	A-5549
Air Filter Set.....	A-5549M-S
Air Filter Primary.....	A-5549M
Air Filter Secondary.....	A-5550
Hydraulic Oil Filter.....	H-5526
Hydraulic Oil Filter.....	HC-55290
Hydraulic Oil Filter.....	HC-5511
Hydraulic Oil Filter.....	H-55280
Hydraulic Oil Filter.....	H-5510
D6R (DOZERS) S/N: 7KN1-UP	
Air Filter Primary.....	A-5549
Air Filter Set.....	A-5549M-S
Air Filter Primary.....	A-5549M
Air Filter Secondary.....	A-5550
Hydraulic Oil Filter.....	HC-5511
Hydraulic Oil Filter.....	H-55280
Hydraulic Oil Filter.....	H-5526
Hydraulic Oil Filter.....	HC-55290
Hydraulic Oil Filter.....	H-5510
D6R (DOZERS) S/N: 8LN1-UP	
Air Filter Secondary.....	A-5550
Air Filter Primary.....	A-5549
Air Filter Primary.....	A-5549M
Air Filter Set.....	A-5549M-S
Hydraulic Oil Filter.....	H-5510
Hydraulic Oil Filter.....	H-55280
Hydraulic Oil Filter.....	HC-55290
Hydraulic Oil Filter.....	H-5526
Hydraulic Oil Filter.....	HC-5511
D6R (DOZERS) S/N: 8TM1-UP	
Air Filter Secondary.....	A-5550
Air Filter Primary.....	A-5549
Air Filter Set.....	A-5549M-S
Air Filter Primary.....	A-5549M
Hydraulic Oil Filter.....	H-5526

MODEL/APPLICATION	SAKURA NO
CATERPILLAR	
Hydraulic Oil Filter.....	HC-55290
Hydraulic Oil Filter.....	H-5510
Hydraulic Oil Filter.....	HC-5511
Hydraulic Oil Filter.....	H-55280
D6R (DOZERS) S/N: 8XN1-UP	
Air Filter Primary.....	A-5549M
Air Filter Set.....	A-5549M-S
Air Filter Secondary.....	A-5550
Air Filter Primary.....	A-5549
Hydraulic Oil Filter.....	H-5510
Hydraulic Oil Filter.....	HC-55290
Hydraulic Oil Filter.....	H-5526
Hydraulic Oil Filter.....	H-55280
Hydraulic Oil Filter.....	HC-5511
D6R (DOZERS) S/N: 9BM1-UP	
Air Filter Set.....	A-5549M-S
Air Filter Primary.....	A-5549M
Air Filter Secondary.....	A-5550
Air Filter Primary.....	A-5549
Hydraulic Oil Filter.....	H-5510
Hydraulic Oil Filter.....	H-55280
Hydraulic Oil Filter.....	H-5526
Hydraulic Oil Filter.....	HC-55290
Hydraulic Oil Filter.....	HC-5511
D6R (DOZERS) S/N: 9MN1-UP	
Air Filter Secondary.....	A-5550
Air Filter Primary.....	A-5549
Air Filter Set.....	A-5549M-S
Air Filter Primary.....	A-5549M
Hydraulic Oil Filter.....	HC-55290
Hydraulic Oil Filter.....	H-55280
Hydraulic Oil Filter.....	H-5510
Hydraulic Oil Filter.....	H-5526
Hydraulic Oil Filter.....	HC-5511
D6R (DOZERS) S/N: 9PN1-UP	
Air Filter Primary.....	A-5549M
Air Filter Set.....	A-5549M-S
Air Filter Secondary.....	A-5550
Air Filter Primary.....	A-5549
Hydraulic Oil Filter.....	H-5510
Hydraulic Oil Filter.....	H-5526
Hydraulic Oil Filter.....	HC-55290
Hydraulic Oil Filter.....	H-55280
Hydraulic Oil Filter.....	HC-5511
D6R (DOZERS) S/N: 9ZS1-UP	
Air Filter Secondary.....	A-5550
Air Filter Primary.....	A-5549M
Air Filter Primary.....	A-5549
Air Filter Set.....	A-5549M-S
Hydraulic Oil Filter.....	HC-55290
Hydraulic Oil Filter.....	H-5510
Hydraulic Oil Filter.....	H-5526
Hydraulic Oil Filter.....	H-55280
Hydraulic Oil Filter.....	HC-5511

MODEL/APPLICATION	SAKURA NO	MODEL/APPLICATION	SAKURA NO	MODEL/APPLICATION	SAKURA NO
CATERPILLAR		CATERPILLAR		CATERPILLAR	
D6R (DOZERS) S/N: DMP1-UP Air Filter Primary..... A-5549M Air Filter Primary..... A-5564 Air Filter Secondary..... A-5550 Air Filter Set..... A-5565-S Air Filter Secondary..... A-5563 Air Filter Primary..... A-5549 Air Filter Set..... A-5549M-S Hydraulic Oil Filter..... H-5510 Hydraulic Oil Filter..... H-5526 Hydraulic Oil Filter..... HC-5511 Hydraulic Oil Filter..... HC-55290 Hydraulic Oil Filter..... H-55280		Air Filter Primary..... A-5549 Hydraulic Oil Filter..... H-5510 Hydraulic Oil Filter..... HC-5511 Hydraulic Oil Filter..... HC-55290 Hydraulic Oil Filter..... H-5526 Hydraulic Oil Filter..... H-55280		D6R II (DOZERS) S/N: BMJ1-UP Air Filter Primary..... A-5549M Air Filter Primary..... A-5549 Air Filter Set..... A-5549M-S Air Filter Secondary..... A-5550 Hydraulic Oil Filter..... HC-5511 Hydraulic Oil Filter..... H-55280 Hydraulic Oil Filter..... HC-55290 Hydraulic Oil Filter..... H-5526	
D6R II (DOZERS) CAT C9 Cabin Air Filter..... CA-55140		D6R II (DOZERS) S/N: AEP1-UP Air Filter Primary..... A-5549M Air Filter Secondary..... A-5550 Air Filter Set..... A-5549M-S Air Filter Primary..... A-5549 Hydraulic Oil Filter..... HC-55290 Hydraulic Oil Filter..... H-5526 Hydraulic Oil Filter..... H-55280 Hydraulic Oil Filter..... HC-5511 Hydraulic Oil Filter..... H-5510		D6R II (DOZERS) S/N: BMV1-UP Air Filter Secondary..... A-5550 Air Filter Set..... A-5549M-S Air Filter Primary..... A-5549 Air Filter Primary..... A-5549M Hydraulic Oil Filter..... HC-55290 Hydraulic Oil Filter..... H-5526 Hydraulic Oil Filter..... H-55280 Hydraulic Oil Filter..... HC-5511	
D6R II (DOZERS) CAT (S/N: 4ZF1-UP) Fuel Filter..... FC-5517		D6R II (DOZERS) S/N: AFM1-UP Air Filter Primary..... A-5549M Air Filter Set..... A-5549M-S Air Filter Primary..... A-5549 Air Filter Secondary..... A-5550 Hydraulic Oil Filter..... H-5510 Hydraulic Oil Filter..... H-5526 Hydraulic Oil Filter..... HC-55290 Hydraulic Oil Filter..... H-55280 Hydraulic Oil Filter..... HC-5511		D6R II (DOZERS) S/N: BNC1-UP Air Filter Set..... A-5549M-S Air Filter Secondary..... A-5550 Air Filter Primary..... A-5549M Air Filter Primary..... A-5549 Hydraulic Oil Filter..... HC-5511 Hydraulic Oil Filter..... H-5526 Hydraulic Oil Filter..... HC-55290 Hydraulic Oil Filter..... H-55280	
D6R II (DOZERS) S/N: AAX1-UP Air Filter Set..... A-5549M-S Air Filter Primary..... A-5549 Air Filter Secondary..... A-5550 Air Filter Primary..... A-5549M Hydraulic Oil Filter..... H-5526 Hydraulic Oil Filter..... HC-55290 Hydraulic Oil Filter..... H-55280 Hydraulic Oil Filter..... HC-5511 Hydraulic Oil Filter..... H-5510 Hydraulic Oil Filter..... H-5510		D6R II (DOZERS) S/N: AGM1-UP Air Filter Primary..... A-5549M Air Filter Primary..... A-5549 Air Filter Secondary..... A-5550 Air Filter Set..... A-5549M-S Hydraulic Oil Filter..... HC-5511 Hydraulic Oil Filter..... H-55280 Hydraulic Oil Filter..... H-5510 Hydraulic Oil Filter..... H-5526 Hydraulic Oil Filter..... HC-55290		D6R II (DOZERS) S/N: BPM1-UP Air Filter Set..... A-5549M-S Air Filter Secondary..... A-5550 Air Filter Primary..... A-5549 Air Filter Primary..... A-5549M Hydraulic Oil Filter..... HC-5511 Hydraulic Oil Filter..... HC-55290 Hydraulic Oil Filter..... H-55280 Hydraulic Oil Filter..... H-5526	
D6R II (DOZERS) S/N: ACJ1-UP Air Filter Primary..... A-5549 Air Filter Primary..... A-5549M Air Filter Secondary..... A-5550 Air Filter Set..... A-5549M-S Hydraulic Oil Filter..... HC-5511 Hydraulic Oil Filter..... HC-55290 Hydraulic Oil Filter..... H-55280 Hydraulic Oil Filter..... H-5510 Hydraulic Oil Filter..... H-5526		D6R II (DOZERS) S/N: BLE1-UP Air Filter Primary..... A-5549M Air Filter Set..... A-5549M-S Air Filter Primary..... A-5549 Air Filter Secondary..... A-5550 Hydraulic Oil Filter..... H-55280 Hydraulic Oil Filter..... HC-5511 Hydraulic Oil Filter..... HC-55290 Hydraulic Oil Filter..... H-5526		D6R II (DOZERS) S/N: BRJ1-UP Air Filter Primary..... A-5549M Air Filter Set..... A-5549M-S Air Filter Primary..... A-5549 Air Filter Secondary..... A-5550 Hydraulic Oil Filter..... HC-5511 Hydraulic Oil Filter..... HC-55290 Hydraulic Oil Filter..... H-55280 Hydraulic Oil Filter..... H-5526	
D6R II (DOZERS) S/N: ADE1-UP Air Filter Set..... A-5549M-S Air Filter Primary..... A-5549 Air Filter Secondary..... A-5550 Air Filter Primary..... A-5549M Hydraulic Oil Filter..... H-5510 Hydraulic Oil Filter..... H-5526 Hydraulic Oil Filter..... H-55280 Hydraulic Oil Filter..... HC-55290 Hydraulic Oil Filter..... HC-5511		D6R II (DOZERS) S/N: BLT1-UP Air Filter Secondary..... A-5550 Air Filter Set..... A-5549M-S Air Filter Primary..... A-5549M Air Filter Primary..... A-5549 Hydraulic Oil Filter..... H-5526 Hydraulic Oil Filter..... HC-55290 Hydraulic Oil Filter..... HC-5511 Hydraulic Oil Filter..... H-55280		D6R II (DOZERS) S/N: CAD1-UP Air Filter Secondary..... A-5550 Air Filter Set..... A-5549M-S Air Filter Primary..... A-5549M Air Filter Primary..... A-5549 Hydraulic Oil Filter..... H-55280 Hydraulic Oil Filter..... HC-5511	
D6R II (DOZERS) S/N: AEM1-UP Air Filter Primary..... A-5549M Air Filter Secondary..... A-5550 Air Filter Set..... A-5549M-S		Hydraulic Oil Filter..... H-55280 Hydraulic Oil Filter..... HC-5511 Hydraulic Oil Filter..... H-55280			

MODEL/APPLICATION	SAKURA NO	MODEL/APPLICATION	SAKURA NO	MODEL/APPLICATION	SAKURA NO
CATERPILLAR		CATERPILLAR		CATERPILLAR	
D6R II (DOZERS) S/N: CAD1-UP		Air Filter Primary.....	A-5549M	Air Filter Primary.....	A-5549
Hydraulic Oil Filter.....	HC-55290	Air Filter Primary.....	A-5549	Hydraulic Oil Filter.....	H-5510
Hydraulic Oil Filter.....	H-5526	Air Filter Set.....	A-5549M-S		
		Hydraulic Oil Filter.....	H-5510	D6R III (DOZERS) S/N: RFC1-UP	
D6R II (DOZERS) S/N: DAE1-UP		D6R III (DOZERS) S/N: GMT1-UP		Air Filter Secondary.....	A-5550
Air Filter Primary.....	A-5549M	Air Filter Secondary.....	A-5550	Air Filter Primary.....	A-5549
Air Filter Set.....	A-5549M-S	Air Filter Primary.....	A-5549M	Air Filter Primary.....	A-5549M
Air Filter Secondary.....	A-5550	Air Filter Set.....	A-5549M-S	Air Filter Set.....	A-5549M-S
Air Filter Primary.....	A-5549	Air Filter Primary.....	A-5549	Hydraulic Oil Filter.....	H-5510
Hydraulic Oil Filter.....	H-55280	Hydraulic Oil Filter.....	H-5510		
Hydraulic Oil Filter.....	HC-5511	D6R III (DOZERS) S/N: HCD1-UP		D6R III (DOZERS) S/N: TBC1-UP	
Hydraulic Oil Filter.....	H-5526	Air Filter Secondary.....	A-5550	Air Filter Primary.....	A-5549M
Hydraulic Oil Filter.....	HC-5526	Air Filter Primary.....	A-5549	Air Filter Secondary.....	A-5550
Hydraulic Oil Filter.....	HC-5511	Air Filter Primary.....	A-5549M	Air Filter Set.....	A-5549M-S
Hydraulic Oil Filter.....	H-55280	Air Filter Set.....	A-5549M-S	Air Filter Primary.....	A-5549
		Hydraulic Oil Filter.....	H-5510	Hydraulic Oil Filter.....	H-5510
D6R II (DOZERS) S/N: FDT1-UP		D6R III (DOZERS) S/N: HDC1-UP		D6R III (DOZERS) S/N: WCB1-UP	
Air Filter Primary.....	A-5549	Air Filter Secondary.....	A-5550	Air Filter Secondary.....	A-5550
Air Filter Secondary.....	A-5550	Air Filter Primary.....	A-5549	Air Filter Primary.....	A-5549
Air Filter Primary.....	A-5549M	Air Filter Primary.....	A-5549M	Air Filter Primary.....	A-5549M
Air Filter Set.....	A-5549M-S	Air Filter Set.....	A-5549M-S	Air Filter Set.....	A-5549M-S
Hydraulic Oil Filter.....	HC-55290	Air Filter Secondary.....	A-5550	Air Filter Set.....	A-5549M-S
Hydraulic Oil Filter.....	H-5526	Air Filter Secondary.....	A-5550	Hydraulic Oil Filter.....	H-5510
Hydraulic Oil Filter.....	HC-5511	Air Filter Primary.....	A-5549M		
Hydraulic Oil Filter.....	H-55280	Air Filter Primary.....	A-5549	D6R III (DOZERS) S/N: WRG1-UP	
		Hydraulic Oil Filter.....	H-5510	Air Filter Primary.....	A-5549
D6R III (DOZERS) CAT S/N: THX1-UP		D6R III (DOZERS) S/N: HKE1-UP		Air Filter Primary.....	A-5549M
Fuel Filter.....	FC-5517	Air Filter Set.....	A-5549M-S	Air Filter Set.....	A-5549M-S
		Air Filter Secondary.....	A-5550	Air Filter Set.....	A-5549M-S
D6R III (DOZERS) CAT S/N: THY1-UP		Air Filter Primary.....	A-5549M	Air Filter Secondary.....	A-5550
Fuel Filter.....	FC-5517	Air Filter Primary.....	A-5549	Hydraulic Oil Filter.....	H-5510
		Hydraulic Oil Filter.....	H-5510		
D6R III (DOZERS) CAT C9 ACERT		D6R III (DOZERS) S/N: JDL1-UP		D6R LGP (DOZERS) CAT 3306	
Cabin Air Filter.....	CA-55140	Air Filter Secondary.....	A-5550	Cabin Air Filter.....	CA-55140
		Air Filter Set.....	A-5549M-S		
D6R III (DOZERS) S/N: DLM1-UP		Air Filter Primary.....	A-5549M	D6R LGP (DOZERS) CAT 3306T	
Air Filter Secondary.....	A-5550	Air Filter Primary.....	A-5549	Fuel Filter Secondary.....	FC-5504
Air Filter Primary.....	A-5549M	Hydraulic Oil Filter.....	H-5510	Oil Filter Full Flow.....	C-5516
Air Filter Primary.....	A-5549				
Air Filter Set.....	A-5549M-S	D6R III (DOZERS) S/N: LFM1-UP		D6R XL (DOZERS) CAT 3306	
Hydraulic Oil Filter.....	H-5510	Air Filter Secondary.....	A-5550	Air Filter Primary.....	A-5549
		Air Filter Set.....	A-5549M-S	Air Filter Set.....	A-5549M-S
D6R III (DOZERS) S/N: DMK1-UP		Air Filter Primary.....	A-5549M	Air Filter Secondary.....	A-5550
Air Filter Set.....	A-5549M-S	Air Filter Primary.....	A-5549	Air Filter Primary.....	A-5549M
Air Filter Primary.....	A-5549M	Hydraulic Oil Filter.....	H-5510	Cabin Air Filter.....	CA-55140
Air Filter Secondary.....	A-5550			Fuel Filter Secondary.....	FC-5507
Air Filter Primary.....	A-5549	D6R III (DOZERS) S/N: MRT1-UP		Fuel Filter.....	F-5505
Hydraulic Oil Filter.....	H-5510	Air Filter Primary.....	A-5549M	Hydraulic Oil Filter.....	HC-5511
		Air Filter Set.....	A-5549M-S	Hydraulic Oil Filter.....	H-5510
D6R III (DOZERS) S/N: DPS1-UP		Air Filter Secondary.....	A-5550	Oil Filter Full Flow.....	C-5510
Air Filter Set.....	A-5549M-S	Air Filter Primary.....	A-5549		
Air Filter Primary.....	A-5549	Hydraulic Oil Filter.....	H-5510	D6R XL (DOZERS) w/C9 Eng.	
Air Filter Primary.....	A-5549M			Fuel/Water Separator.....	SFC-55170
Air Filter Secondary.....	A-5550	D6R III (DOZERS) S/N: MTJ1-UP			
Hydraulic Oil Filter.....	H-5510	Air Filter Set.....	A-5549M-S	D6R XW (DOZERS) CAT C9 (S/N: DMP1-UP)	
		Air Filter Secondary.....	A-5550	Air Filter Primary.....	A-5549M
D6R III (DOZERS) S/N: GJB1-UP		Air Filter Primary.....	A-5549	Air Filter Primary.....	A-5549
Air Filter Secondary.....	A-5550	Hydraulic Oil Filter.....	H-5510	Air Filter Secondary.....	A-5550
		D6R III (DOZERS) S/N: MTJ1-UP			
		Air Filter Set.....	A-5549M-S		
		Air Filter Secondary.....	A-5550		
		Air Filter Primary.....	A-5549M		

MODEL/APPLICATION	SAKURA NO	MODEL/APPLICATION	SAKURA NO	MODEL/APPLICATION	SAKURA NO
CATERPILLAR		CATERPILLAR		CATERPILLAR	
D6R XW (DOZERS) CAT C9 (S/N: DMP1-UP)		D6T XL (DOZERS) CAT C9.3 ACERT		Oil Filter Full Flow.....	C-5510
Air Filter Set.....	A-5549M-S	Cabin Air Filter.....	CA-55140	D7 (DOZERS) S/N: 93N1-961	
Fuel Filter Secondary.....	FC-5507	D6T XL (DOZERS) w/C9 Eng.		Air Filter Set.....	A-5522-S
Hydraulic Oil Filter.....	H-5510	Fuel/Water Separator.....	SFC-55170	Air Filter Primary.....	A-5549
Hydraulic Oil Filter.....	H-5526	D6T XL (DOZERS) W/C9.3L ENG.		Air Filter Primary.....	A-5509
Hydraulic Oil Filter.....	HC-5511	Fuel/Water Separator.....	SFC-55170	Air Filter Set.....	A-5549M-S
Oil Filter Full Flow.....	C-5510	D6T XL (DOZERS) W/C9.3L ENG.		Air Filter Secondary.....	A-5550
D6R2 (DOZERS) CAT C9		Fuel/Water Separator.....	SFC-55250	Air Filter Primary.....	A-5549M
Fuel Filter.....	FC-5517	D6T XW (DOZERS) CAT C9.3 ACERT		Air Filter Secondary.....	A-5552
Hydraulic Oil Filter.....	H-5526	Cabin Air Filter.....	CA-55140	Air Filter Secondary.....	A-5522
Hydraulic Oil Filter.....	HC-5511	D6T XW (DOZERS) w/C9 Eng.		Hydraulic Oil Filter.....	H-5503
D6R DS (DOZERS) w/C9 Eng.		Fuel/Water Separator.....	SFC-55170	Oil Filter Full Flow.....	O-5502
Fuel/Water Separator.....	SFC-55170	D6T XW (DOZERS) W/C9.3L ENG.		D7 (DOZERS) S/N: 94N1-3356	
D6R FTC (DOZERS) w/C9 Eng.		Fuel/Water Separator.....	SFC-55250	Air Filter Set.....	A-5522-S
Fuel/Water Separator.....	SFC-55170	D6T LGP PAT (DOZERS) W/C9.3L ENG.		Air Filter Primary.....	A-5549
D6R II LGP (DOZERS) CAT C9		Fuel/Water Separator.....	SFC-55250	Air Filter Set.....	A-5549M-S
Cabin Air Filter.....	CA-55140	D6T XL PAT (DOZERS) W/C9.3L ENG.		Air Filter Primary.....	A-5549M
D6R II XL (DOZERS) CAT C9		Fuel/Water Separator.....	SFC-55250	Air Filter Secondary.....	A-5550
Cabin Air Filter.....	CA-55140	D6T XW PAT (DOZERS) W/C9.3L ENG.		Air Filter Secondary.....	A-5522
D6R II XW (DOZERS) CAT C9		Fuel/Water Separator.....	SFC-55250	Air Filter Primary.....	A-5509
Cabin Air Filter.....	CA-55140	D7 (DOZERS) S/N: 45M1-UP		Hydraulic Oil Filter.....	H-5503
D6R III LGP (DOZERS) CAT C9 ACERT		Excluding S/N: 94N3347, 94N3352		Oil Filter Full Flow.....	O-5502
Cabin Air Filter.....	CA-55140	Air Filter Primary.....	A-5549	D7C (TRACTORS)	
D6R III XL (DOZERS) CAT C9 ACERT		Air Filter Set.....	A-5549M-S	Fuel Filter.....	F-5501
Cabin Air Filter.....	CA-55140	Air Filter Primary.....	A-5549M	Oil Filter Full Flow.....	O-5502
D6R III XW (DOZERS) CAT C9 ACERT		Air Filter Secondary.....	A-5550	D7E (DOZERS) S/N: 47A1-3395	
Cabin Air Filter.....	CA-55140	Hydraulic Oil Filter.....	H-5503	Fuel Filter.....	F-5501
D6R XR (DOZERS) CAT 3306		Hydraulic Oil Filter.....	H-5506	Hydraulic Oil Filter.....	H-5504
Cabin Air Filter.....	CA-55140	Oil Filter Full Flow.....	C-5510	Oil Filter Full Flow.....	O-5503
D6T (DOZERS) CAT C9 ACERT		D7 (DOZERS) S/N: 45M1-UP		D7E (DOZERS) S/N: 47A3396-3677	
Cabin Air Filter.....	CA-55140	Air Filter Primary.....	A-5549M	Fuel Filter.....	F-5501
D6T (DOZERS) w/C9 Eng.		Air Filter Set.....	A-5522-S	Hydraulic Oil Filter.....	H-5503
Fuel/Water Separator.....	SFC-55170	Air Filter Set.....	A-5549M-S	Oil Filter Full Flow.....	O-5503
D6T LGP (DOZERS) CAT C9.3 ACERT		Air Filter Primary.....	A-5549	D7E (DOZERS) S/N: 47A3678-UP	
Cabin Air Filter.....	CA-55140	Air Filter Secondary.....	A-5522	Air Filter Primary.....	A-5514
D6T LGP (DOZERS) w/C9 Eng.		Air Filter Primary.....	A-5509	Air Filter Set.....	A-5514-S
Fuel/Water Separator.....	SFC-55170	Air Filter Primary.....	A-5549M	Fuel Filter.....	F-5501
D6T LGP (DOZERS) W/C9.3L ENG.		Air Filter Primary.....	A-5549	Hydraulic Oil Filter.....	H-5503
Fuel/Water Separator.....	SFC-55250	Air Filter Set.....	A-5522-S	Oil Filter Full Flow.....	O-5503
D6T LGP (DOZERS) W/C9.3L ENG.		Air Filter Set.....	A-5549M-S	D7E (DOZERS) S/N: 48A1-6392	
Fuel/Water Separator.....	SFC-55250	Hydraulic Oil Filter.....	H-5503	Fuel Filter.....	F-5501
		Hydraulic Oil Filter.....	H-5506	Hydraulic Oil Filter.....	H-5504
		Oil Filter Full Flow.....	C-5510	Oil Filter Full Flow.....	O-5503
		D7 (DOZERS) S/N: 65V1-UP		D7E (DOZERS) W/C9.3L ENG.	
		Air Filter Secondary.....	A-5550	Air Filter Primary.....	A-5535M
		Air Filter Secondary.....	A-5522	Air Filter Set.....	A-5573M-S
		Air Filter Primary.....	A-5509	Fuel/Water Separator.....	SFC-55250
		Air Filter Primary.....	A-5549M	Fuel/Water Separator.....	SFC-55170
		Air Filter Primary.....	A-5549	D7E LGP (DOZERS) W/C9.3L ENG.	
		Air Filter Set.....	A-5522-S		
		Air Filter Set.....	A-5549M-S		
		Hydraulic Oil Filter.....	H-5503		
		Hydraulic Oil Filter.....	H-5506		

MODEL/APPLICATION	SAKURA NO
CATERPILLAR	
D7E LGP (DOZERS) W/C9.3L ENG. Fuel/Water Separator.....	SFC-55250
D7F (DOZERS) Fuel Filter.....	F-5503
D7F (DOZERS) S/N: 93N1-1174 Air Filter Secondary..... Air Filter Secondary..... Air Filter Set..... Air Filter Primary..... Air Filter Set..... Air Filter Primary..... Air Filter Primary..... Hydraulic Oil Filter..... Oil Filter Full Flow.....	A-5550 A-5522 A-5549M-S A-5509 A-5522-S A-5549M A-5549 H-5503 C-5510
D7F (DOZERS) S/N: 93N1175-UP Air Filter Secondary..... Air Filter Secondary..... Air Filter Set..... Air Filter Primary..... Air Filter Set..... Air Filter Primary..... Air Filter Primary..... Hydraulic Oil Filter..... Oil Filter Full Flow.....	A-5550 A-5522 A-5549M-S A-5509 A-5522-S A-5549 A-5549M H-5503 C-5510
D7F (DOZERS) S/N: 94N1-5191 Air Filter Primary..... Air Filter Set..... Air Filter Secondary..... Air Filter Secondary..... Air Filter Primary..... Fuel Filter Secondary..... Hydraulic Oil Filter..... Oil Filter Full Flow.....	A-5549 A-5549M-S A-5550 A-5522 A-5549M FC-5507 H-5503 C-5510
D7F (DOZERS) S/N: 94N5192-UP Air Filter Primary..... Air Filter Set..... Air Filter Primary..... Air Filter Primary..... Air Filter Set..... Air Filter Secondary..... Air Filter Secondary..... Fuel Filter Secondary..... Hydraulic Oil Filter..... Oil Filter Full Flow.....	A-5549M A-5522-S A-5549 A-5509 A-5549M-S A-5550 A-5522 FC-5507 H-5503 C-5510
D7G II (DOZERS) CAT 3306 DITA Cabin Air Filter.....	CA-55140
D7G (DOZERS) CAT 3306T Fuel Filter.....	F-5503

MODEL/APPLICATION	SAKURA NO
CATERPILLAR	
D7G (DOZERS) CAT 3306T (S/N: 35N1-UP) Air Filter Primary..... Air Filter Secondary..... Air Filter Set..... Fuel Filter Secondary..... Hydraulic Oil Filter..... Hydraulic Oil Filter..... Hydraulic Oil Filter..... Hydraulic Oil Filter..... Oil Filter Full Flow.....	A-5509 A-5510 A-5522-S FC-5507 H-55280 H-5503 H-5506 H-5526 C-5510
D7G (DOZERS) CAT 3306T (S/N: 3GF1-UP) Air Filter Set..... Air Filter Primary..... Air Filter Secondary..... Fuel Filter..... Fuel Filter Secondary..... Hydraulic Oil Filter..... Hydraulic Oil Filter..... Hydraulic Oil Filter..... Oil Filter Full Flow.....	A-5522-S A-5509 A-5522 F-5505 FC-5507 H-5506 H-5526 H-55280 H-5503 C-5510
D7G (DOZERS) CAT 3306T (S/N: 3ZD1-UP) Air Filter Set..... Air Filter Secondary..... Air Filter Primary..... Fuel Filter Secondary..... Fuel Filter..... Hydraulic Oil Filter..... Hydraulic Oil Filter..... Hydraulic Oil Filter..... Oil Filter Full Flow.....	A-5522-S A-5522 A-5509 FC-5507 F-5505 H-5506 H-5526 H-5503 H-55280 C-5510
D7G (DOZERS) CAT 3306T (S/N: 44W1-440) Air Filter Primary..... Air Filter Secondary..... Air Filter Set..... Hydraulic Oil Filter..... Oil Filter Full Flow.....	A-5509 A-5522 A-5522-S H-5503 C-5510
D7G (DOZERS) CAT 3306T (S/N: 44W441-UP) Air Filter Secondary..... Air Filter Set..... Air Filter Primary..... Fuel Filter Secondary..... Fuel Filter..... Hydraulic Oil Filter..... Hydraulic Oil Filter..... Hydraulic Oil Filter..... Hydraulic Oil Filter..... Oil Filter Full Flow.....	A-5522 A-5522-S A-5509 FC-5507 F-5505 H-5506 H-5503 H-5526 H-55280 C-5510
D7G (DOZERS) CAT 3306T (S/N: 45W407-UP) Air Filter Secondary..... Air Filter Primary.....	A-5522 A-5509

MODEL/APPLICATION	SAKURA NO
CATERPILLAR	
Air Filter Set..... Fuel Filter..... Fuel Filter Secondary..... Hydraulic Oil Filter..... Oil Filter Full Flow.....	A-5522-S F-5505 FC-5507 H-5506 C-5510
D7G (DOZERS) CAT 3306T (S/N: 65V1-UP) Air Filter Primary..... Air Filter Primary..... Air Filter Primary..... Air Filter Set..... Air Filter Set..... Air Filter Secondary..... Air Filter Secondary..... Hydraulic Oil Filter..... Hydraulic Oil Filter..... Oil Filter Full Flow.....	A-5509 A-5549M A-5549 A-5549M-S A-5522-S A-5522 A-5550 H-5503 H-5506 C-5510
D7G (DOZERS) CAT 3306T (S/N: 72W1-UP) Air Filter Primary..... Air Filter Primary..... Air Filter Secondary..... Air Filter Set..... Air Filter Set..... Air Filter Primary..... Air Filter Secondary..... Fuel Filter..... Hydraulic Oil Filter..... Oil Filter Full Flow.....	A-5509 A-5549 A-5522 A-5522-S A-5549M-S A-5549M A-5550 F-5505 H-5503 C-5510
D7G (DOZERS) CAT 3306T (S/N: 91V1-UP) Air Filter Set..... Air Filter Primary..... Air Filter Primary..... Air Filter Secondary..... Air Filter Set..... Air Filter Secondary..... Air Filter Secondary..... Air Filter Primary..... Hydraulic Oil Filter.....	A-5522-S A-5549M A-5549 A-5549M-S A-5550 A-5522 A-5509 H-5503
D7G (DOZERS) CAT 3306T (S/N: 92V1-UP) Air Filter Set..... Air Filter Secondary..... Air Filter Secondary..... Air Filter Primary..... Air Filter Set..... Air Filter Primary..... Air Filter Primary..... Fuel Filter..... Hydraulic Oil Filter..... Oil Filter Full Flow.....	A-5549M-S A-5550 A-5522 A-5509 A-5522-S A-5549M A-5549 F-5505 H-5503 C-5510
D7G (DOZERS) CAT 3306T (S/N: 93N962-UP) Air Filter Primary..... Air Filter Primary..... Air Filter Primary..... Air Filter Set..... Air Filter Set..... Air Filter Secondary.....	A-5549M A-5509 A-5549 A-5549M-S A-5522-S A-5522

MODEL/APPLICATION	SAKURA NO
CATERPILLAR	
D7G (DOZERS) CAT 3306T (S/N: 93N962-UP)	
Air Filter Secondary.....	A-5550
Fuel Filter.....	F-5505
Hydraulic Oil Filter.....	H-5503
Oil Filter Full Flow.....	C-5510
D7G (DOZERS) CAT 3306T (S/N: 94N3357-UP)	
Air Filter Primary.....	A-5549
Air Filter Secondary.....	A-5522
Air Filter Secondary.....	A-5550
Air Filter Set.....	A-5522-S
Air Filter Set.....	A-5549M-S
Air Filter Primary.....	A-5549M
Air Filter Primary.....	A-5509
Fuel Filter.....	F-5505
Hydraulic Oil Filter.....	H-5503
Oil Filter Full Flow.....	C-5510
D7G (DOZERS) CAT 3606	
Air Filter Secondary.....	A-5550
Air Filter Secondary.....	A-5522
Air Filter Set.....	A-5522-S
Air Filter Primary.....	A-5549M
Air Filter Primary.....	A-5549
Air Filter Primary.....	A-5509
Air Filter Set.....	A-5549M-S
Hydraulic Oil Filter.....	H-5503
Oil Filter Full Flow.....	C-5510
D7G LGP (DOZERS) S/N: 44W1-547	
Air Filter Set.....	A-5522-S
Air Filter Primary.....	A-5509
Air Filter Secondary.....	A-5522
Fuel Filter Secondary.....	FC-5507
Hydraulic Oil Filter.....	H-5526
Hydraulic Oil Filter.....	H-5503
Hydraulic Oil Filter.....	H-55280
Oil Filter Full Flow.....	C-5510
D7G LGP (DOZERS) S/N: 45W1-UP	
Air Filter Secondary.....	A-5522
Air Filter Primary.....	A-5509
Air Filter Set.....	A-5522-S
Fuel Filter Secondary.....	FC-5507
Hydraulic Oil Filter.....	H-5526
Hydraulic Oil Filter.....	H-55280
Hydraulic Oil Filter.....	H-5503
Oil Filter Full Flow.....	C-5510
D7G SERIES II (DOZERS) w/3306 Eng.	
Air Filter Set.....	A-5573M-S
Air Filter Primary.....	A-5535M
D7H (DOZERS) CAT 3306	
Cabin Air Filter.....	CA-55140
D7H (DOZERS) S/N: 2RG1-UP	

MODEL/APPLICATION	SAKURA NO
CATERPILLAR	
Air Filter Set.....	A-5522-S
Air Filter Primary.....	A-5509
Air Filter Secondary.....	A-5522
Fuel Filter.....	F-5505
Fuel Filter Secondary.....	FC-5507
Hydraulic Oil Filter.....	H-5526
Hydraulic Oil Filter.....	HC-5511
Hydraulic Oil Filter.....	H-5503
Hydraulic Oil Filter.....	H-55280
Oil Filter Full Flow.....	C-5510
D7H (DOZERS) S/N: 2SB1-UP	
Air Filter Primary.....	A-5509
Air Filter Secondary.....	A-5522
Air Filter Set.....	A-5522-S
Fuel Filter Secondary.....	FC-5507
Fuel Filter.....	F-5505
Hydraulic Oil Filter.....	H-5526
Hydraulic Oil Filter.....	H-5510
Hydraulic Oil Filter.....	H-5503
Hydraulic Oil Filter.....	H-55280
Oil Filter Full Flow.....	C-5510
D7H (DOZERS) S/N: 3XG1-UP	
Air Filter Secondary.....	A-5522
Air Filter Set.....	A-5522-S
Air Filter Primary.....	A-5509
Fuel Filter Secondary.....	FC-5507
Fuel Filter.....	F-5505
Hydraulic Oil Filter.....	H-5526
Hydraulic Oil Filter.....	HC-5511
Hydraulic Oil Filter.....	H-5503
Hydraulic Oil Filter.....	H-55280
Oil Filter Full Flow.....	C-5510
D7H (DOZERS) S/N: 4AB1-UP	
Air Filter Secondary.....	A-5522
Air Filter Primary.....	A-5509
Air Filter Set.....	A-5522-S
Fuel Filter.....	F-5505
Fuel Filter Secondary.....	FC-5507
Hydraulic Oil Filter.....	H-5526
Hydraulic Oil Filter.....	H-55280
Hydraulic Oil Filter.....	H-5503
Hydraulic Oil Filter.....	H-5510
Oil Filter Full Flow.....	C-5510
D7H (DOZERS) S/N: 4AB5500-UP	
Air Filter Primary.....	A-5549M
Air Filter Primary.....	A-5549
Air Filter Secondary.....	A-5550
Air Filter Set.....	A-5549M-S
Fuel Filter Secondary.....	FC-5507
Hydraulic Oil Filter.....	H-5510
Hydraulic Oil Filter.....	H-5503
Oil Filter Full Flow.....	C-5510
D7H (DOZERS) S/N: 4AB5500-UP	
Air Filter Primary.....	A-5549M
Air Filter Primary.....	A-5549
Air Filter Secondary.....	A-5550
Air Filter Set.....	A-5549M-S
Fuel Filter Secondary.....	FC-5507
Hydraulic Oil Filter.....	H-5510
Hydraulic Oil Filter.....	H-5503
Oil Filter Full Flow.....	C-5510
D7H (DOZERS) S/N: 4FG1-328	
Air Filter Secondary.....	A-5522

MODEL/APPLICATION	SAKURA NO
CATERPILLAR	
Air Filter Set.....	A-5522-S
Air Filter Primary.....	A-5509
Hydraulic Oil Filter.....	H-5526
Hydraulic Oil Filter.....	H-5503
Hydraulic Oil Filter.....	H-55280
D7H (DOZERS) S/N: 4FG1-UP	
Air Filter Set.....	A-5522-S
Air Filter Primary.....	A-5509
Air Filter Secondary.....	A-5522
Fuel Filter.....	F-5505
Fuel Filter Secondary.....	FC-5507
Hydraulic Oil Filter.....	H-55280
Hydraulic Oil Filter.....	H-5503
Hydraulic Oil Filter.....	HC-5511
Hydraulic Oil Filter.....	H-5526
Oil Filter Full Flow.....	C-5510
D7H (DOZERS) S/N: 4FG329-5499	
Air Filter Secondary.....	A-5522
Air Filter Primary.....	A-5509
Air Filter Set.....	A-5522-S
Hydraulic Oil Filter.....	H-5503
Hydraulic Oil Filter.....	H-55280
Hydraulic Oil Filter.....	H-5526
D7H (DOZERS) S/N: 4FG4000-UP	
Air Filter Secondary.....	A-5534
Air Filter Set.....	A-5573-S
Air Filter Secondary.....	A-5550
Air Filter Primary.....	A-5535
Air Filter Set.....	A-5549M-S
Air Filter Primary.....	A-5549M
Air Filter Primary.....	A-5549
Fuel Filter Secondary.....	FC-5507
Fuel Filter.....	F-5505
Hydraulic Oil Filter.....	H-5503
Hydraulic Oil Filter.....	H-5526
Hydraulic Oil Filter.....	H-55280
Hydraulic Oil Filter.....	HC-5511
Oil Filter Full Flow.....	C-5510
D7H (DOZERS) S/N: 4FG5500-5631	
Air Filter Primary.....	A-5549
Air Filter Primary.....	A-5549M
Air Filter Set.....	A-5549M-S
Air Filter Secondary.....	A-5550
Hydraulic Oil Filter.....	H-5503
Hydraulic Oil Filter.....	H-55280
Hydraulic Oil Filter.....	H-5526
D7H (DOZERS) S/N: 4FG5632-UP	
Air Filter Set.....	A-5573-S
Air Filter Secondary.....	A-5534
Air Filter Primary.....	A-5535
Hydraulic Oil Filter.....	H-5503
Hydraulic Oil Filter.....	H-55280
Hydraulic Oil Filter.....	H-5526

MODEL/APPLICATION	SAKURA NO
CATERPILLAR	
D7H (DOZERS) S/N: 5BF1-3999	
Air Filter Primary.....	A-5509
Air Filter Set.....	A-5522-S
Air Filter Secondary.....	A-5522
Fuel Filter.....	F-5505
Fuel Filter Secondary.....	FC-5507
Hydraulic Oil Filter.....	H-5526
Hydraulic Oil Filter.....	H-5503
Hydraulic Oil Filter.....	H-55280
Hydraulic Oil Filter.....	HC-5511
Oil Filter Full Flow.....	C-5510
D7H (DOZERS) S/N: 5BF1-613	
Air Filter Primary.....	A-5509
Air Filter Set.....	A-5522-S
Air Filter Secondary.....	A-5522
Hydraulic Oil Filter.....	H-55280
Hydraulic Oil Filter.....	H-5503
Hydraulic Oil Filter.....	H-5526
D7H (DOZERS) S/N: 5BF4000-UP	
Air Filter Secondary.....	A-5550
Air Filter Primary.....	A-5549
Air Filter Set.....	A-5549M-S
Air Filter Primary.....	A-5549M
Fuel Filter Secondary.....	FC-5507
Hydraulic Oil Filter.....	H-5503
Oil Filter Full Flow.....	C-5510
D7H (DOZERS) S/N: 5BF5500-6032	
Air Filter Secondary.....	A-5550
Air Filter Set.....	A-5549M-S
Air Filter Primary.....	A-5549M
Air Filter Primary.....	A-5549
Hydraulic Oil Filter.....	H-5526
Hydraulic Oil Filter.....	H-55280
Hydraulic Oil Filter.....	H-5503
D7H (DOZERS) S/N: 5BF6033-UP	
Air Filter Primary.....	A-5535
Air Filter Set.....	A-5573-S
Air Filter Secondary.....	A-5534
Hydraulic Oil Filter.....	H-5526
Hydraulic Oil Filter.....	H-5503
Hydraulic Oil Filter.....	H-55280
D7H (DOZERS) S/N: 5BF614-5499	
Air Filter Secondary.....	A-5522
Air Filter Primary.....	A-5509
Air Filter Set.....	A-5522-S
Hydraulic Oil Filter.....	H-5503
Hydraulic Oil Filter.....	H-55280
Hydraulic Oil Filter.....	H-5526
D7H (DOZERS) S/N: 5WB1-UP	
Air Filter Primary.....	A-5509
Air Filter Set.....	A-5522-S

MODEL/APPLICATION	SAKURA NO
CATERPILLAR	
Air Filter Secondary.....	A-5522
Fuel Filter.....	F-5505
Fuel Filter Secondary.....	FC-5507
Hydraulic Oil Filter.....	H-5510
Hydraulic Oil Filter.....	H-55280
Hydraulic Oil Filter.....	H-5526
Hydraulic Oil Filter.....	H-5503
Oil Filter Full Flow.....	C-5510
D7H (DOZERS) S/N: 5WB5500-UP	
Air Filter Secondary.....	A-5550
Fuel Filter Secondary.....	FC-5507
Hydraulic Oil Filter.....	H-5503
Hydraulic Oil Filter.....	H-5510
Oil Filter Full Flow.....	C-5510
D7H (DOZERS) S/N: 7721-UP	
Air Filter Set.....	A-5522-S
Air Filter Primary.....	A-5509
Air Filter Secondary.....	A-5522
Fuel Filter.....	F-5505
Fuel Filter Secondary.....	FC-5507
Hydraulic Oil Filter.....	H-5503
Hydraulic Oil Filter.....	H-5510
Hydraulic Oil Filter.....	H-5526
Hydraulic Oil Filter.....	H-55280
Oil Filter Full Flow.....	C-5510
D7H (DOZERS) S/N: 7921-3999	
Air Filter Set.....	A-5549M-S
Air Filter Primary.....	A-5549
Air Filter Secondary.....	A-5522
Air Filter Secondary.....	A-5550
Air Filter Primary.....	A-5549M
Fuel Filter Secondary.....	FC-5507
Hydraulic Oil Filter.....	H-5510
Hydraulic Oil Filter.....	H-5503
Oil Filter Full Flow.....	C-5510
D7H (DOZERS) S/N: 7921-744	
Air Filter Set.....	A-5522-S
Air Filter Secondary.....	A-5522
Air Filter Primary.....	A-5509
D7H (DOZERS) S/N: 7922304-2304	
Air Filter Secondary.....	A-5522
Air Filter Set.....	A-5522-S
Air Filter Primary.....	A-5509
Hydraulic Oil Filter.....	H-5526
Hydraulic Oil Filter.....	H-55280
Hydraulic Oil Filter.....	H-5506
D7H (DOZERS) S/N: 7922305-2315	
Air Filter Primary.....	A-5509
Air Filter Set.....	A-5522-S
Air Filter Secondary.....	A-5522
Hydraulic Oil Filter.....	H-5526
Hydraulic Oil Filter.....	H-55280

MODEL/APPLICATION	SAKURA NO
CATERPILLAR	
D7H (DOZERS) S/N: 7922316-5499	
Air Filter Set.....	A-5522-S
Air Filter Secondary.....	A-5522
Air Filter Primary.....	A-5509
Hydraulic Oil Filter.....	H-5506
Hydraulic Oil Filter.....	H-55280
Hydraulic Oil Filter.....	H-5526
D7H (DOZERS) S/N: 7924000-UP	
Air Filter Secondary.....	A-5534
Air Filter Primary.....	A-5535
Air Filter Set.....	A-5573-S
Air Filter Secondary.....	A-5550
Air Filter Primary.....	A-5549
Air Filter Set.....	A-5549M-S
Air Filter Primary.....	A-5549M
Fuel Filter.....	F-5505
Fuel Filter Secondary.....	FC-5507
Hydraulic Oil Filter.....	H-5503
Hydraulic Oil Filter.....	H-55280
Hydraulic Oil Filter.....	H-5506
Hydraulic Oil Filter.....	H-5526
Oil Filter Full Flow.....	C-5510
D7H (DOZERS) S/N: 7925500-5925	
Air Filter Set.....	A-5549M-S
Air Filter Primary.....	A-5549M
Air Filter Secondary.....	A-5550
Air Filter Primary.....	A-5549
Hydraulic Oil Filter.....	H-5506
Hydraulic Oil Filter.....	H-5526
Hydraulic Oil Filter.....	H-55280
D7H (DOZERS) S/N: 7925926-UP	
Air Filter Secondary.....	A-5534
Air Filter Set.....	A-5573-S
Air Filter Primary.....	A-5535
Hydraulic Oil Filter.....	H-55280
Hydraulic Oil Filter.....	H-5526
Hydraulic Oil Filter.....	H-5506
D7H (DOZERS) S/N: 792745-2303	
Air Filter Secondary.....	A-5522
Air Filter Primary.....	A-5509
Air Filter Set.....	A-5522-S
Hydraulic Oil Filter.....	H-5526
Hydraulic Oil Filter.....	H-55280
D7H (DOZERS) S/N: 792F-3999	
Air Filter Secondary.....	A-5522
Air Filter Set.....	A-5522-S
Air Filter Primary.....	A-5509
Fuel Filter.....	F-5505
Fuel Filter Secondary.....	FC-5507
Hydraulic Oil Filter.....	H-5503
Hydraulic Oil Filter.....	H-5506
Hydraulic Oil Filter.....	H-5526

MODEL/APPLICATION	SAKURA NO
CATERPILLAR	
D7H (DOZERS) S/N: 79ZF-3999	
Hydraulic Oil Filter.....	H-55280
Hydraulic Oil Filter.....	H-5510
Oil Filter Full Flow.....	C-5510
D7H (DOZERS) S/N: 80Z1-3999	
Air Filter Set.....	A-5522-S
Air Filter Primary.....	A-5509
Air Filter Secondary.....	A-5522
Fuel Filter Secondary.....	FC-5507
Fuel Filter.....	F-5505
Hydraulic Oil Filter.....	H-5526
Hydraulic Oil Filter.....	H-5503
Hydraulic Oil Filter.....	H-5510
Hydraulic Oil Filter.....	H-55280
Hydraulic Oil Filter.....	H-5506
Oil Filter Full Flow.....	C-5510
D7H (DOZERS) S/N: 80Z1-640	
Air Filter Set.....	A-5522-S
Air Filter Secondary.....	A-5522
Air Filter Primary.....	A-5509
D7H (DOZERS) S/N: 80Z4000-UP	
Air Filter Secondary.....	A-5550
Air Filter Primary.....	A-5535
Air Filter Set.....	A-5573-S
Air Filter Secondary.....	A-5534
Air Filter Primary.....	A-5549M
Air Filter Primary.....	A-5549
Air Filter Set.....	A-5549M-S
Fuel Filter.....	F-5505
Fuel Filter Secondary.....	FC-5507
Hydraulic Oil Filter.....	H-5526
Hydraulic Oil Filter.....	H-55280
Hydraulic Oil Filter.....	H-5506
Hydraulic Oil Filter.....	H-5503
Oil Filter Full Flow.....	C-5510
D7H (DOZERS) S/N: 80Z5500-5525	
Air Filter Primary.....	A-5549
Air Filter Primary.....	A-5549M
Air Filter Set.....	A-5549M-S
Air Filter Secondary.....	A-5550
Hydraulic Oil Filter.....	H-55280
Hydraulic Oil Filter.....	H-5526
Hydraulic Oil Filter.....	H-5506
D7H (DOZERS) S/N: 80Z5526-UP	
Air Filter Secondary.....	A-5534
Air Filter Primary.....	A-5535
Air Filter Set.....	A-5573-S
Hydraulic Oil Filter.....	H-55280
Hydraulic Oil Filter.....	H-5526
Hydraulic Oil Filter.....	H-5506
D7H (DOZERS) S/N: 80Z641-801	

MODEL/APPLICATION	SAKURA NO
CATERPILLAR	
Air Filter Primary.....	A-5509
Air Filter Secondary.....	A-5522
Air Filter Set.....	A-5522-S
Hydraulic Oil Filter.....	H-5526
Hydraulic Oil Filter.....	H-55280
D7H (DOZERS) S/N: 80Z802-5499	
Air Filter Secondary.....	A-5522
Air Filter Set.....	A-5522-S
Air Filter Primary.....	A-5509
Hydraulic Oil Filter.....	H-5506
Hydraulic Oil Filter.....	H-5526
Hydraulic Oil Filter.....	H-55280
D7H (DOZERS) S/N: 82Z4000-UP	
Air Filter Primary.....	A-5509
Air Filter Secondary.....	A-5522
Air Filter Set.....	A-5522-S
Fuel Filter Secondary.....	FC-5507
Fuel Filter.....	F-5505
Hydraulic Oil Filter.....	H-5526
Hydraulic Oil Filter.....	H-55280
Hydraulic Oil Filter.....	H-5503
Hydraulic Oil Filter.....	H-5510
Oil Filter Full Flow.....	C-5510
D7H (DOZERS) w/3306 Eng.	
Air Filter Set.....	A-5573M-S
Air Filter Primary.....	A-5535M
D7H LGP (DOZERS) CAT 3306	
Cabin Air Filter.....	CA-55140
D7H LGP (DOZERS) S/N: 3XG1-UP	
Air Filter Secondary.....	A-5522
Air Filter Set.....	A-5522-S
Air Filter Primary.....	A-5509
Fuel Filter Secondary.....	FC-5507
Fuel Filter.....	F-5505
Hydraulic Oil Filter.....	H-5526
Hydraulic Oil Filter.....	H-5511
Hydraulic Oil Filter.....	H-5503
Hydraulic Oil Filter.....	H-55280
Oil Filter Full Flow.....	C-5510
D7H LGP (DOZERS) S/N: 4FG1-3999	
Air Filter Primary.....	A-5509
Air Filter Set.....	A-5522-S
Air Filter Secondary.....	A-5522
Fuel Filter.....	F-5505
Fuel Filter Secondary.....	FC-5507
Hydraulic Oil Filter.....	H-5526
Hydraulic Oil Filter.....	HC-5511
Hydraulic Oil Filter.....	H-5503
Hydraulic Oil Filter.....	H-55280
Oil Filter Full Flow.....	C-5510
D7H LGP (DOZERS) S/N: 5BF1-3999	

MODEL/APPLICATION	SAKURA NO
CATERPILLAR	
Air Filter Secondary.....	A-5522
Air Filter Primary.....	A-5509
Air Filter Set.....	A-5522-S
Fuel Filter.....	F-5505
Fuel Filter Secondary.....	FC-5507
Hydraulic Oil Filter.....	H-5526
Hydraulic Oil Filter.....	H-55280
Hydraulic Oil Filter.....	H-5503
Hydraulic Oil Filter.....	HC-5511
Oil Filter Full Flow.....	C-5510
D7H LGP (DOZERS) S/N: 79Z1-3999	
Air Filter Set.....	A-5522-S
Air Filter Secondary.....	A-5522
Air Filter Primary.....	A-5509
Fuel Filter Secondary.....	FC-5507
Fuel Filter.....	F-5505
Hydraulic Oil Filter.....	H-55280
Hydraulic Oil Filter.....	H-5503
Hydraulic Oil Filter.....	H-5506
Hydraulic Oil Filter.....	H-5526
Hydraulic Oil Filter.....	H-5510
Oil Filter Full Flow.....	C-5510
D7H LGP (DOZERS) S/N: 80Z1-3999	
Air Filter Set.....	A-5522-S
Air Filter Secondary.....	A-5522
Air Filter Primary.....	A-5509
Fuel Filter.....	F-5505
Fuel Filter Secondary.....	FC-5507
Hydraulic Oil Filter.....	H-55280
Hydraulic Oil Filter.....	H-5510
Hydraulic Oil Filter.....	H-5526
Hydraulic Oil Filter.....	H-5503
Hydraulic Oil Filter.....	H-5506
Oil Filter Full Flow.....	C-5510
D7H LGP (DOZERS) S/N: 82Z1-UP	
Air Filter Primary.....	A-5509
Air Filter Set.....	A-5522-S
Air Filter Secondary.....	A-5522
Fuel Filter.....	F-5505
Fuel Filter Secondary.....	FC-5507
Hydraulic Oil Filter.....	H-5503
Hydraulic Oil Filter.....	H-5510
Hydraulic Oil Filter.....	H-55280
Hydraulic Oil Filter.....	H-5526
Oil Filter Full Flow.....	C-5510
D7H LGP SERIES II (DOZERS) CAT 3306	
Cabin Air Filter.....	CA-55140
D7H LGP SERIES II (DOZERS) S/N: 4FG4000-UP	
Air Filter Primary.....	A-5549M
Air Filter Secondary.....	A-5550
Air Filter Set.....	A-5573-S
Air Filter Primary.....	A-5535
Air Filter Secondary.....	A-5534
Air Filter Primary.....	A-5549

MODEL/APPLICATION	SAKURA NO
-------------------	-----------

CATERPILLAR

**D7H LGP SERIES II
(DOZERS)
S/N: 4FG4000-UP**

Air Filter Set.....	A-5549M-S
Fuel Filter Secondary.....	FC-5507
Fuel Filter.....	F-5505
Hydraulic Oil Filter.....	H-5526
Hydraulic Oil Filter.....	HC-5511
Hydraulic Oil Filter.....	H-55280
Hydraulic Oil Filter.....	H-5503
Oil Filter Full Flow.....	C-5510

**D7H LGP SERIES II
(DOZERS)
S/N: 5BF4000-UP**

Air Filter Primary.....	A-5549M
Air Filter Primary.....	A-5549
Air Filter Secondary.....	A-5534
Air Filter Set.....	A-5549M-S
Air Filter Primary.....	A-5535
Air Filter Set.....	A-5573-S
Air Filter Secondary.....	A-5550
Fuel Filter Secondary.....	FC-5507
Fuel Filter.....	F-5505
Hydraulic Oil Filter.....	H-5503
Hydraulic Oil Filter.....	H-5526
Hydraulic Oil Filter.....	H-55280
Hydraulic Oil Filter.....	HC-5511
Oil Filter Full Flow.....	C-5510

**D7H LGP SERIES II
(DOZERS)
S/N: 79Z4000-UP**

Air Filter Set.....	A-5549M-S
Air Filter Primary.....	A-5549M
Air Filter Set.....	A-5573-S
Air Filter Secondary.....	A-5550
Air Filter Primary.....	A-5535
Air Filter Primary.....	A-5549
Air Filter Secondary.....	A-5534
Fuel Filter.....	F-5505
Fuel Filter Secondary.....	FC-5507
Hydraulic Oil Filter.....	H-5503
Hydraulic Oil Filter.....	H-55280
Hydraulic Oil Filter.....	H-5526
Hydraulic Oil Filter.....	H-5506
Oil Filter Full Flow.....	C-5510

**D7H LGP SERIES II
(DOZERS)
S/N: 80Z4000-UP**

Air Filter Set.....	A-5573-S
Air Filter Primary.....	A-5535
Air Filter Primary.....	A-5549
Air Filter Secondary.....	A-5550
Air Filter Primary.....	A-5549M
Air Filter Set.....	A-5549M-S
Air Filter Secondary.....	A-5534
Fuel Filter.....	F-5505
Fuel Filter Secondary.....	FC-5507
Hydraulic Oil Filter.....	H-5503
Hydraulic Oil Filter.....	H-5526
Hydraulic Oil Filter.....	H-5506
Hydraulic Oil Filter.....	H-55280
Oil Filter Full Flow.....	C-5510

MODEL/APPLICATION	SAKURA NO
-------------------	-----------

CATERPILLAR

**D7H LGP SERIES II
(DOZERS)
S/N: 82Z4000-UP**

Air Filter Secondary.....	A-5522
Air Filter Primary.....	A-5509
Air Filter Set.....	A-5522-S
Fuel Filter.....	F-5505
Fuel Filter Secondary.....	FC-5507
Hydraulic Oil Filter.....	H-5526
Hydraulic Oil Filter.....	H-5510
Hydraulic Oil Filter.....	H-55280
Hydraulic Oil Filter.....	H-5503
Oil Filter Full Flow.....	C-5510

**D7H II
(DOZERS)
CAT 3306**

Cabin Air Filter.....	CA-55140
-----------------------	----------

**D7H SERIES II
(DOZERS)
w/3306 Eng.**

Air Filter Set.....	A-5573M-S
Air Filter Primary.....	A-5535M

**D7H II XR
(DOZERS)
CAT 3306**

Cabin Air Filter.....	CA-55140
-----------------------	----------

**D7H XR
(DOZERS)
CAT 3306**

Cabin Air Filter.....	CA-55140
-----------------------	----------

**D7R
(DOZERS)
CAT C9 ACERT**

Cabin Air Filter.....	CA-55140
Fuel/Water Separator.....	SFC-55180

**D7R
(DOZERS)
S/N: 2EN1-UP**

Air Filter Primary.....	A-5535
Air Filter Secondary.....	A-5534
Air Filter Set.....	A-5573-S
Fuel Filter.....	F-5505
Fuel Filter Secondary.....	FC-5507
Hydraulic Oil Filter.....	HC-55290
Hydraulic Oil Filter.....	H-5526
Hydraulic Oil Filter.....	H-5503
Hydraulic Oil Filter.....	H-55280
Hydraulic Oil Filter.....	HC-5511
Oil Filter Full Flow.....	C-5510

**D7R
(DOZERS)
S/N: 2HR1-UP**

Air Filter Primary.....	A-5535
Air Filter Set.....	A-5573-S
Air Filter Secondary.....	A-5534
Fuel Filter.....	F-5505
Fuel Filter Secondary.....	FC-5507
Hydraulic Oil Filter.....	H-5526
Hydraulic Oil Filter.....	H-5503
Hydraulic Oil Filter.....	H-55280
Oil Filter Full Flow.....	C-5510

**D7R
(DOZERS)
S/N: 3DN1-UP**

Air Filter Secondary.....	A-5534
Air Filter Set.....	A-5573-S

MODEL/APPLICATION	SAKURA NO
-------------------	-----------

CATERPILLAR

Air Filter Primary.....	A-5535
Hydraulic Oil Filter.....	H-55280
Hydraulic Oil Filter.....	HC-5511
Hydraulic Oil Filter.....	H-5503
Hydraulic Oil Filter.....	HC-55290
Hydraulic Oil Filter.....	H-5526

**D7R
(DOZERS)
S/N: 3ZR1-UP**

Air Filter Primary.....	A-5535
Air Filter Set.....	A-5573-S
Air Filter Secondary.....	A-5534
Fuel Filter.....	F-5505
Fuel Filter Secondary.....	FC-5507
Hydraulic Oil Filter.....	H-5526
Hydraulic Oil Filter.....	H-55280
Hydraulic Oil Filter.....	H-5503
Oil Filter Full Flow.....	C-5510

**D7R
(DOZERS)
S/N: 4SR1-UP**

Air Filter Primary.....	A-5535
Air Filter Set.....	A-5573-S
Air Filter Secondary.....	A-5534
Fuel Filter.....	F-5505
Fuel Filter Secondary.....	FC-5507
Hydraulic Oil Filter.....	H-55280
Hydraulic Oil Filter.....	H-5503
Hydraulic Oil Filter.....	H-5526
Oil Filter Full Flow.....	C-5510

**D7R
(DOZERS)
S/N: 5KZ1-UP**

Air Filter Secondary.....	A-5534
Air Filter Primary.....	A-5535
Air Filter Set.....	A-5573-S
Fuel Filter Secondary.....	FC-5507
Fuel Filter.....	F-5505
Hydraulic Oil Filter.....	HC-5511
Hydraulic Oil Filter.....	H-5526
Hydraulic Oil Filter.....	HC-55290
Hydraulic Oil Filter.....	H-5503
Hydraulic Oil Filter.....	H-55280
Oil Filter Full Flow.....	C-5510

**D7R
(DOZERS)
S/N: 5MR1-UP**

Air Filter Primary.....	A-5535
Air Filter Set.....	A-5573-S
Air Filter Secondary.....	A-5534
Fuel Filter Secondary.....	FC-5507
Fuel Filter.....	F-5505
Hydraulic Oil Filter.....	HC-5511
Hydraulic Oil Filter.....	H-55280
Hydraulic Oil Filter.....	H-5503
Hydraulic Oil Filter.....	H-5526
Oil Filter Full Flow.....	C-5510

**D7R
(DOZERS)
S/N: 9HM1-UP**

Air Filter Secondary.....	A-5534
Air Filter Set.....	A-5573-S
Air Filter Primary.....	A-5535
Fuel Filter.....	F-5505

MODEL/APPLICATION	SAKURA NO	MODEL/APPLICATION	SAKURA NO	MODEL/APPLICATION	SAKURA NO
CATERPILLAR		CATERPILLAR		CATERPILLAR	
D7R (DOZERS) S/N: 9HM1-UP		Hydraulic Oil Filter.....	H-5503	Air Filter Secondary.....	A-5534
Fuel Filter Secondary.....	FC-5507	Hydraulic Oil Filter.....	H-5526	Air Filter Set.....	A-5573-S
Hydraulic Oil Filter.....	H-5526			Air Filter Primary.....	A-5535
Hydraulic Oil Filter.....	H-55280	D7R II (DOZERS) S/N: ABJ1500-UP		Hydraulic Oil Filter.....	H-55280
Hydraulic Oil Filter.....	H-5503	Air Filter Secondary.....	A-5534	Hydraulic Oil Filter.....	H-5503
Oil Filter Full Flow.....	C-5510	Air Filter Set.....	A-5573-S	Hydraulic Oil Filter.....	HC-5511
		Air Filter Primary.....	A-5535	Hydraulic Oil Filter.....	H-5526
		Hydraulic Oil Filter.....	H-5510	Hydraulic Oil Filter.....	HC-55290
D7R (DOZERS) S/N: ACS1-UP					
Air Filter Set.....	A-5573-S	D7R II (DOZERS) S/N: ACS1-UP		D7R II (DOZERS) S/N: AGN1500-UP	
Air Filter Primary.....	A-5535	Air Filter Secondary.....	A-5534	Air Filter Secondary.....	A-5534
Air Filter Secondary.....	A-5534	Air Filter Primary.....	A-5535	Air Filter Primary.....	A-5535
Hydraulic Oil Filter.....	H-5526	Air Filter Set.....	A-5573-S	Air Filter Set.....	A-5573-S
Hydraulic Oil Filter.....	HC-55290	Hydraulic Oil Filter.....	H-55280	Hydraulic Oil Filter.....	H-5510
Hydraulic Oil Filter.....	H-55280	Hydraulic Oil Filter.....	HC-5511		
Hydraulic Oil Filter.....	H-5503	Hydraulic Oil Filter.....	H-5526	D7R LGP (DOZERS) CAT 3176C (S/N: 3DN1-UP)	
Hydraulic Oil Filter.....	HC-5511	Hydraulic Oil Filter.....	HC-55290	Air Filter Secondary.....	A-5534
		Hydraulic Oil Filter.....	H-5503	Air Filter Primary.....	A-5535
D7R (DOZERS) S/N: ADW1-UP				Air Filter Set.....	A-5573-S
Air Filter Secondary.....	A-5534	D7R II (DOZERS) S/N: ADW1-UP		Fuel Filter.....	F-5505
Air Filter Primary.....	A-5535	Air Filter Secondary.....	A-5534	Fuel Filter Secondary.....	FC-5507
Air Filter Set.....	A-5573-S	Air Filter Set.....	A-5573-S	Hydraulic Oil Filter.....	H-5526
Fuel/Water Separator Secondary..	SFC-5504-10B	Air Filter Primary.....	A-5535	Hydraulic Oil Filter.....	H-55280
Fuel/Water Separator Secondary..	SFC-5504-10	Hydraulic Oil Filter.....	H-55280	Hydraulic Oil Filter.....	H-5503
Hydraulic Oil Filter.....	HC-55290	Hydraulic Oil Filter.....	HC-5511	Hydraulic Oil Filter.....	HC-5511
Hydraulic Oil Filter.....	H-5526	Hydraulic Oil Filter.....	H-5503	Oil Filter Full Flow.....	C-5510
Hydraulic Oil Filter.....	H-5503	Hydraulic Oil Filter.....	HC-55290		
Hydraulic Oil Filter.....	H-55280	Hydraulic Oil Filter.....	H-5526	D7R LGP (DOZERS) CAT C9 ACERT	
Hydraulic Oil Filter.....	HC-5511			Cabin Air Filter.....	CA-55140
		D7R II (DOZERS) S/N: AEC1-1499			
D7R (DOZERS) S/N: AFG1-UP		Air Filter Primary.....	A-5535	D7RXL (DOZERS) CAT 3306	
Air Filter Secondary.....	A-5534	Air Filter Secondary.....	A-5534	Air Filter Primary.....	A-5535
Air Filter Primary.....	A-5535	Air Filter Set.....	A-5573-S	Air Filter Secondary.....	A-5550
Air Filter Set.....	A-5573-S	Hydraulic Oil Filter.....	H-55280	Air Filter Set.....	A-5573-S
Hydraulic Oil Filter.....	HC-55290	Hydraulic Oil Filter.....	HC-55290	Air Filter Set.....	A-5549M-S
Hydraulic Oil Filter.....	H-5526	Hydraulic Oil Filter.....	H-5526	Air Filter Secondary.....	A-5534
Hydraulic Oil Filter.....	H-55280	Hydraulic Oil Filter.....	H-5503	Air Filter Primary.....	A-5549
Hydraulic Oil Filter.....	HC-5511	Hydraulic Oil Filter.....	HC-5511	Air Filter Primary.....	A-5549M
Hydraulic Oil Filter.....	H-5503			Fuel Filter Secondary.....	FC-5507
		D7R II (DOZERS) S/N: AEC1500-UP		Hydraulic Oil Filter.....	H-5503
D7R (DOZERS) W/3176C Eng.		Air Filter Primary.....	A-5535	Hydraulic Oil Filter.....	HC-5511
Air Filter Primary.....	A-5535M	Air Filter Secondary.....	A-5534	Oil Filter Full Flow.....	C-5510
Air Filter Set.....	A-5573M-S	Air Filter Set.....	A-5573-S		
		Hydraulic Oil Filter.....	H-5510	D7RL (DOZERS) w/3306 Eng.	
D7R (DOZERS) w/3306 Eng.		Hydraulic Oil Filter.....	H-5526	Air Filter Set.....	A-5573M-S
Air Filter Set.....	A-5573M-S	Hydraulic Oil Filter.....	H-55280	Air Filter Primary.....	A-5535M
Air Filter Primary.....	A-5535M				
		D7R II (DOZERS) S/N: AFG1-UP		D7R II LGP (DOZERS) CAT 3176C	
D7R II (DOZERS) CAT 3176C		Air Filter Secondary.....	A-5534	Cabin Air Filter.....	CA-55140
Cabin Air Filter.....	CA-55140	Air Filter Primary.....	A-5535		
		Air Filter Set.....	A-5573-S	D7R II XR (DOZERS) CAT 3176C	
D7R II (DOZERS) S/N: ABJ1-1499		Hydraulic Oil Filter.....	H-5503	Cabin Air Filter.....	CA-55140
Air Filter Secondary.....	A-5534	Hydraulic Oil Filter.....	HC-5511		
Air Filter Set.....	A-5573-S	Hydraulic Oil Filter.....	H-55280	D7R XR (DOZERS) CAT C9 ACERT	
Air Filter Primary.....	A-5535	Hydraulic Oil Filter.....	HC-55290	Cabin Air Filter.....	CA-55140
Hydraulic Oil Filter.....	HC-5511	Hydraulic Oil Filter.....	H-5526		
Hydraulic Oil Filter.....	H-55280			D8 (DOZERS) S/N: 13A-13A	
Hydraulic Oil Filter.....	HC-55290	D7R II (DOZERS) S/N: AGN1-1499			
		Air Filter Secondary.....	A-5534		

Sakura Filter

ENGINE APPLICATION

MODEL/APPLICATION	SAKURA NO	MODEL/APPLICATION	SAKURA NO	MODEL/APPLICATION	SAKURA NO
CATERPILLAR		CATERPILLAR		CATERPILLAR	
D8 (DOZERS) S/N: 13A-13A		Hydraulic Oil Filter.....	H-5503	D8L (DOZERS) S/N: 46A10725-12884	
Oil Filter Full Flow.....	0-5501	Oil Filter Full Flow.....	C-5516	Fuel Filter.....	F-5501
D8 (DOZERS) S/N: 36A4469-4648		D8L (DOZERS) CAT 3408 (S/N: 53Y1-UP)		Hydraulic Oil Filter.....	H-5503
Fuel Filter.....	F-5501	Air Filter Primary.....	A-5521	Oil Filter Full Flow.....	0-5502
Hydraulic Oil Filter.....	H-5503	Air Filter Primary.....	A-5561	D8L (DOZERS) S/N: 46A1-10724	
Oil Filter Full Flow.....	0-5502	Air Filter Set.....	A-5562-S	Air Filter Set.....	A-5521-S
D8D (DOZERS)		Air Filter.....	A-5547	Air Filter Primary.....	A-5521
Fuel Filter.....	F-5501	Air Filter Set.....	A-5521-S	D8L (DOZERS) S/N: 46A12885-25737	
Hydraulic Oil Filter.....	H-5503	Air Filter Secondary.....	A-5560	Air Filter Secondary.....	A-5528
Hydraulic Oil Filter.....	H-5504	Air Filter Secondary.....	A-5552	Air Filter Set.....	A-5515-S
Oil Filter Full Flow.....	0-5502	Coolant Filter.....	WC-5707	Air Filter Primary.....	A-5515
D8E (DOZERS)		Fuel Filter.....	FC-5509	Fuel Filter.....	F-5501
Fuel Filter.....	F-5501	Fuel Filter.....	FC-5519	Hydraulic Oil Filter.....	H-5503
Hydraulic Oil Filter.....	H-5504	Fuel Filter.....	F-5501	Oil Filter Full Flow.....	0-5502
Oil Filter Full Flow.....	0-5502	Hydraulic Oil Filter.....	H-5504	D8L (DOZERS) S/N: 46A25738-25740	
D8G (DOZERS)		Hydraulic Oil Filter.....	H-5503	Air Filter Secondary.....	A-5534
Fuel Filter.....	F-5501	Oil Filter Full Flow.....	0-5502	Air Filter Primary.....	A-5501
Hydraulic Oil Filter.....	H-5503	D8L (DOZERS) S/N: 22A1-UP		Air Filter Secondary.....	A-5502
Hydraulic Oil Filter.....	H-5504	Fuel Filter.....	F-5501	Air Filter Set.....	A-5573-S
Oil Filter Full Flow.....	0-5502	Hydraulic Oil Filter.....	H-5504	Air Filter Primary.....	A-5535
D8H (DOZERS) S/N: 35A1-UP		Oil Filter Full Flow.....	0-5502	Fuel Filter.....	F-5501
Fuel Filter.....	F-5501	D8L (DOZERS) S/N: 35A1-UP		Hydraulic Oil Filter.....	H-5503
Hydraulic Oil Filter.....	H-5504	Fuel Filter.....	F-5501	Oil Filter Full Flow.....	0-5502
Oil Filter Full Flow.....	0-5502	Hydraulic Oil Filter.....	H-5504	D8L (DOZERS) S/N: 46A25741-25742	
D8H (DOZERS) S/N: 68A1-UP		Oil Filter Full Flow.....	0-5502	Air Filter Set.....	A-5521-S
Fuel Filter.....	F-5501	D8L (DOZERS) S/N: 36A1-4468		Air Filter Primary.....	A-5521
Hydraulic Oil Filter.....	H-5504	Air Filter Primary.....	A-5521	D8L (DOZERS) S/N: 46A25743-25743	
Oil Filter Full Flow.....	0-5502	Air Filter Set.....	A-5521-S	Air Filter Set.....	A-5521-S
D8K (DOZERS) S/N: 66V1-UP		D8L (DOZERS) S/N: 36A4649-5383		Air Filter Primary.....	A-5521
Fuel Filter Secondary.....	FC-5507	Fuel Filter.....	F-5501	D8L (DOZERS) S/N: 46A25744-25745	
Hydraulic Oil Filter.....	H-5503	Hydraulic Oil Filter.....	H-5503	Air Filter Primary.....	A-5521
Oil Filter Full Flow.....	C-5516	Oil Filter Full Flow.....	0-5502	Air Filter Set.....	A-5521-S
D8K (DOZERS) S/N: 76V1-UP		D8L (DOZERS) S/N: 36A5384-5524		D8L (DOZERS) S/N: 46A25746-28136	
Air Filter Primary.....	A-5501	Air Filter Secondary.....	A-5534	Air Filter Set.....	A-5573-S
Air Filter Secondary.....	A-5534	Air Filter Secondary.....	A-5502	Air Filter Primary.....	A-5535
Air Filter Primary.....	A-5535	Air Filter Primary.....	A-5501	Air Filter Secondary.....	A-5534
Air Filter Set.....	A-5573-S	Air Filter Set.....	A-5573-S	Air Filter Secondary.....	A-5502
Air Filter Secondary.....	A-5502	Air Filter Primary.....	A-5535	Air Filter Primary.....	A-5501
Fuel Filter Secondary.....	FC-5507	Fuel Filter.....	F-5501	Fuel Filter.....	F-5501
Hydraulic Oil Filter.....	H-5503	Hydraulic Oil Filter.....	H-5503	Hydraulic Oil Filter.....	H-5503
Oil Filter Full Flow.....	C-5516	Oil Filter Full Flow.....	0-5502	Oil Filter Full Flow.....	0-5502
D8K (DOZERS) S/N: 77V1-UP		D8L (DOZERS) S/N: 36A5525-UP		D8L (DOZERS) S/N: 46A28137-29449	
Air Filter Secondary.....	A-5534	Air Filter Set.....	A-5573-S	Air Filter Secondary.....	A-5502
Air Filter Primary.....	A-5535	Air Filter Primary.....	A-5535	Air Filter Secondary.....	A-5534
Air Filter Set.....	A-5573-S	Air Filter Secondary.....	A-5501	Air Filter Set.....	A-5573-S
Air Filter Primary.....	A-5501	Air Filter Primary.....	A-5501	Air Filter Primary.....	A-5535
Air Filter Secondary.....	A-5502	Air Filter Secondary.....	A-5502	Air Filter Primary.....	A-5501
		Fuel Filter Secondary.....	FC-5507	Fuel Filter Secondary.....	FC-5507
		Hydraulic Oil Filter.....	H-5503		
		Oil Filter Full Flow.....	C-5516		

Sakura Filter

ENGINE APPLICATION

MODEL/APPLICATION	SAKURA NO
CATERPILLAR	
D8L (DOZERS) S/N: 46A28137-29449	
Hydraulic Oil Filter.....	H-5503
Oil Filter Full Flow.....	0-5502
D8L (DOZERS) S/N: 46A29450-UP	
Air Filter Primary.....	A-5501
Air Filter Secondary.....	A-5534
Air Filter Secondary.....	A-5502
Air Filter Set.....	A-5573-S
Air Filter Primary.....	A-5535
Fuel Filter Secondary.....	FC-5507
Hydraulic Oil Filter.....	H-5503
Oil Filter Full Flow.....	C-5516
D8L (DOZERS) S/N: 4FB1-UP	
Air Filter Set.....	A-5521-S
Air Filter Secondary.....	A-5552
Air Filter Primary.....	A-5521
Fuel Filter.....	FC-5509
Fuel Filter.....	F-5505
Hydraulic Oil Filter.....	H-5504
Hydraulic Oil Filter.....	H-5509
Hydraulic Oil Filter.....	H-55270
Oil Filter Full Flow.....	C-5516
D8L (DOZERS) S/N: 52A1-UP	
Fuel Filter.....	F-5501
Hydraulic Oil Filter.....	H-5504
Oil Filter Full Flow.....	0-5502
D8L (DOZERS) S/N: 53Y1-UP	
Air Filter Secondary.....	A-5552
Air Filter Set.....	A-5521-S
Air Filter Primary.....	A-5521
Fuel Filter.....	F-5505
Fuel Filter.....	FC-5509
Hydraulic Oil Filter.....	H-55270
Hydraulic Oil Filter.....	H-5504
Hydraulic Oil Filter.....	H-5509
Oil Filter Full Flow.....	C-5516
D8L (DOZERS) S/N: 68A1-UP	
Fuel Filter.....	F-5501
Hydraulic Oil Filter.....	H-5504
Oil Filter Full Flow.....	0-5502
D8L (DOZERS) S/N: 76V1-UP	
Air Filter Secondary.....	A-5502
Air Filter Primary.....	A-5535
Air Filter Set.....	A-5573-S
Air Filter Secondary.....	A-5534
Air Filter Primary.....	A-5501
Fuel Filter Secondary.....	FC-5507
Hydraulic Oil Filter.....	H-5503
Oil Filter Full Flow.....	C-5516
D8L (DOZERS) S/N: 77V1-UP	

MODEL/APPLICATION	SAKURA NO
CATERPILLAR	
Air Filter Secondary.....	A-5502
Air Filter Primary.....	A-5501
Air Filter Secondary.....	A-5534
Air Filter Primary.....	A-5535
Air Filter Set.....	A-5573-S
Fuel Filter Secondary.....	FC-5507
Hydraulic Oil Filter.....	H-5503
Oil Filter Full Flow.....	C-5516
D8L (DOZERS) S/N: 7JC1-UP	
Air Filter Primary.....	A-5521
Air Filter Set.....	A-5521-S
Air Filter Secondary.....	A-5552
Fuel Filter.....	F-5505
Fuel Filter.....	FC-5509
Hydraulic Oil Filter.....	H-5509
Hydraulic Oil Filter.....	H-55270
Hydraulic Oil Filter.....	H-5504
Oil Filter Full Flow.....	C-5516
D8L (DOZERS) S/N: 7YB1-1572	
Air Filter Primary.....	A-5521
Air Filter Set.....	A-5521-S
Air Filter Secondary.....	A-5552
Fuel Filter.....	F-5505
Oil Filter Full Flow.....	C-5516
D8L (DOZERS) S/N: 7YB1573-UP	
Air Filter Secondary.....	A-5552
Air Filter Set.....	A-5521-S
Air Filter Primary.....	A-5521
Fuel Filter.....	F-5505
Hydraulic Oil Filter.....	H-55270
D8L (DOZERS) S/N: 7YB1-UP	
Air Filter Secondary.....	A-5552
Air Filter Secondary.....	A-5560
Air Filter Set.....	A-5521-S
Air Filter Primary.....	A-5521
Air Filter Set.....	A-5562-S
Air Filter Primary.....	A-5561
Fuel Filter.....	F-5505
Hydraulic Oil Filter.....	H-5504
Oil Filter Full Flow.....	C-5516
D8N (DOZERS) CAT 3406	
Cabin Air Filter.....	CA-55140
D8N (DOZERS) S/N: 1XJ1-UP	
Air Filter Secondary.....	A-5534
Air Filter Secondary.....	A-5502
Air Filter Primary.....	A-5501
Air Filter Set.....	A-5573-S
Air Filter Primary.....	A-5535
Fuel Filter.....	F-5505
Hydraulic Oil Filter.....	FC-5509
Hydraulic Oil Filter.....	H-5526
Hydraulic Oil Filter.....	H-5503

MODEL/APPLICATION	SAKURA NO
CATERPILLAR	
Hydraulic Oil Filter.....	HC-5511
Hydraulic Oil Filter.....	H-55280
Oil Filter Full Flow.....	C-5516
D8N (DOZERS) S/N: 5TJ00754-00751	
Air Filter Set.....	A-5573-S
Air Filter Primary.....	A-5535
Air Filter Secondary.....	A-5534
Fuel Filter.....	FC-5519
Hydraulic Oil Filter.....	H-55270
Oil Filter Full Flow.....	C-5516
D8N (DOZERS) S/N: 5TJ1-UP	
Air Filter Set.....	A-5573-S
Air Filter Primary.....	A-5535
Air Filter Secondary.....	A-5534
Air Filter Secondary.....	A-5502
Air Filter Primary.....	A-5501
Fuel Filter.....	F-5505
Fuel Filter.....	FC-5509
Hydraulic Oil Filter.....	H-5510
Hydraulic Oil Filter.....	H-55270
Oil Filter Full Flow.....	C-5516
D8N (DOZERS) S/N: 7TK1-UP	
Air Filter Secondary.....	A-5534
Air Filter Set.....	A-5573-S
Air Filter Primary.....	A-5535
Fuel Filter.....	F-5505
Hydraulic Oil Filter.....	H-5510
Hydraulic Oil Filter.....	H-55270
Oil Filter Full Flow.....	C-5516
D8N (DOZERS) S/N: 9TC1-2453	
Air Filter Set.....	A-5573-S
Air Filter Primary.....	A-5535
Air Filter Secondary.....	A-5534
Air Filter Primary.....	A-5501
Air Filter Secondary.....	A-5502
Hydraulic Oil Filter.....	H-55280
Hydraulic Oil Filter.....	H-5503
Hydraulic Oil Filter.....	H-5526
D8N (DOZERS) S/N: 9TC1-UP	
Air Filter Secondary.....	A-5534
Air Filter Primary.....	A-5501
Air Filter Primary.....	A-5535
Air Filter Secondary.....	A-5502
Air Filter Set.....	A-5573-S
Fuel Filter.....	F-5505
Hydraulic Oil Filter.....	HC-5511
Hydraulic Oil Filter.....	H-55280
Hydraulic Oil Filter.....	H-5503
Hydraulic Oil Filter.....	H-5526
Oil Filter Full Flow.....	C-5516
D8N (DOZERS) S/N: 9TC2454-UP	
Air Filter Set.....	A-5573-S
Air Filter Primary.....	A-5535

MODEL/APPLICATION	SAKURA NO
CATERPILLAR	
D8N (DOZERS) S/N: 9TC2454-UP	
Air Filter Primary.....	A-5501
Air Filter Secondary.....	A-5534
Air Filter Secondary.....	A-5502
Hydraulic Oil Filter.....	H-5526
Hydraulic Oil Filter.....	H-5503
Hydraulic Oil Filter.....	H-55280
D8N (DOZERS) w/3406 Eng.	
Air Filter Primary.....	A-5535M
Air Filter Set.....	A-5573M-S
D8R (DOZERS) CAT 3406C	
Cabin Air Filter.....	CA-55140
D8R (DOZERS) CAT 3406C TA (S/N: 7XM1-UP)	
Air Filter Set.....	A-5555-S
Air Filter Secondary.....	A-5556
Air Filter Primary.....	A-5555
Fuel Filter.....	F-5505
Fuel Filter.....	FC-5509
Hydraulic Oil Filter.....	H-5526
Hydraulic Oil Filter.....	H-55270
Hydraulic Oil Filter.....	H-55280
Oil Filter Full Flow.....	C-5516
D8R (DOZERS) CAT 3406C TA (S/N: 9EM1-UP)	
Air Filter Primary.....	A-5555
Air Filter Set.....	A-5555-S
Air Filter Secondary.....	A-5556
Fuel Filter.....	F-5505
Fuel Filter.....	FC-5509
Hydraulic Oil Filter.....	H-5510
Hydraulic Oil Filter.....	H-55270
Hydraulic Oil Filter.....	H-55280
Oil Filter Full Flow.....	C-5516
D8R (DOZERS) CAT 3406C TA (S/N: AKA1-UP)	
Air Filter Set.....	A-5555-S
Air Filter Secondary.....	A-5556
Air Filter Primary.....	A-5555
Fuel Filter.....	FC-5509
Hydraulic Oil Filter.....	H-5510
Hydraulic Oil Filter.....	H-5526
Hydraulic Oil Filter.....	H-5503
Oil Filter Full Flow.....	C-5516
D8R (DOZERS)	
Air Filter Primary.....	A-5555
Air Filter Secondary.....	A-5556
Air Filter Set.....	A-5555-S
Fuel Filter.....	FC-5509
Hydraulic Oil Filter.....	H-5503
Hydraulic Oil Filter.....	H-5510
Oil Filter Full Flow.....	C-5516

MODEL/APPLICATION	SAKURA NO
CATERPILLAR	
D8R II (DOZERS) CAT 3406E	
Cabin Air Filter.....	CA-55140
D8R SERIES II (DOZERS) CAT 3406E TA	
Air Filter Secondary.....	A-5556
Air Filter Primary.....	A-5555
Air Filter Set.....	A-5555-S
Fuel Filter.....	FC-5509
Hydraulic Oil Filter.....	H-55280
Hydraulic Oil Filter.....	H-5503
Oil Filter Full Flow.....	C-5516
D8R SERIES II (DOZERS) S/N: 6YZ1-UP	
Air Filter Set.....	A-5555-S
Air Filter Secondary.....	A-5556
Air Filter Primary.....	A-5555
Hydraulic Oil Filter.....	H-55270
Hydraulic Oil Filter.....	H-5503
Hydraulic Oil Filter.....	H-5510
Hydraulic Oil Filter.....	H-5526
Hydraulic Oil Filter.....	H-55280
D8R SERIES II (DOZERS) S/N: AKA1-UP	
Air Filter Secondary.....	A-5556
Air Filter Primary.....	A-5555
Air Filter Set.....	A-5555-S
Hydraulic Oil Filter.....	H-5526
Hydraulic Oil Filter.....	H-5510
Hydraulic Oil Filter.....	H-5503
Hydraulic Oil Filter.....	H-55280
D8T (DOZERS) CAT (S/N: LHX1-UP)	
Fuel Filter.....	FC-5517
D8T (DOZERS) S/N: J8B1-UP	
Air Filter Set.....	A-5555-S
Air Filter Primary.....	A-5555
Air Filter Secondary.....	A-5556
Hydraulic Oil Filter.....	H-5526
Hydraulic Oil Filter.....	H-55280
Hydraulic Oil Filter.....	HC-55170
Hydraulic Oil Filter.....	H-5503
Hydraulic Oil Filter.....	H-5510
D8T (DOZERS) S/N: KPZ1-UP	
Air Filter Primary.....	A-5555
Air Filter Set.....	A-5555-S
Air Filter Secondary.....	A-5556
Hydraulic Oil Filter.....	H-5510
Hydraulic Oil Filter.....	H-5526
Hydraulic Oil Filter.....	H-5503
Hydraulic Oil Filter.....	H-55280
Hydraulic Oil Filter.....	HC-55170
Hydraulic Oil Filter.....	HC-5504
D9 (DOZERS) S/N: 66A11908-UP	

MODEL/APPLICATION	SAKURA NO
CATERPILLAR	
Air Filter Primary.....	A-5521
Air Filter Set.....	A-5521-S
Air Filter Secondary.....	A-5556
Air Filter Secondary.....	A-5529
Air Filter Primary.....	A-5555
Air Filter Set.....	A-5555-S
Hydraulic Oil Filter.....	H-5503
Oil Filter Full Flow.....	O-5503
D9 (DOZERS) S/N: 66A9418-9949	
Air Filter Secondary.....	A-5526
Air Filter Primary.....	A-5557
Air Filter Set.....	A-5557-S
Fuel Filter.....	F-5501
Hydraulic Oil Filter.....	H-5503
Oil Filter Full Flow.....	O-5503
D9 (DOZERS) S/N: 66A9950-11907	
Air Filter Secondary.....	A-5526
Air Filter Set.....	A-5557-S
Air Filter Primary.....	A-5557
Hydraulic Oil Filter.....	H-5503
Oil Filter Full Flow.....	O-5503
D9 (DOZERS) S/N: 90V1-UP	
Air Filter Secondary.....	A-5556
Air Filter Primary.....	A-5521
Air Filter Set.....	A-5555-S
Air Filter Secondary.....	A-5529
Air Filter Primary.....	A-5555
Air Filter Set.....	A-5521-S
Fuel Filter.....	F-5505
Hydraulic Oil Filter.....	H-5503
Hydraulic Oil Filter.....	H-5506
Oil Filter Full Flow.....	C-5516
D9D (DOZERS)	
Fuel Filter.....	F-5501
Oil Filter Full Flow.....	O-5503
D9E (DOZERS) S/N: 34A1-UP	
Air Filter Secondary.....	A-5526
Fuel Filter.....	F-5501
Hydraulic Oil Filter.....	H-5504
Oil Filter Full Flow.....	O-5503
D9G (DOZERS) S/N: 66A12016-UP	
Air Filter Primary.....	A-5521
Air Filter Secondary.....	A-5529
Air Filter Set.....	A-5521-S
Hydraulic Oil Filter.....	H-5503
Oil Filter Full Flow.....	O-5503
D9G (DOZERS) S/N: 66A1-3074	
Fuel Filter.....	F-5501
Hydraulic Oil Filter.....	H-5504
Oil Filter Full Flow.....	O-5503

MODEL/APPLICATION	SAKURA NO	MODEL/APPLICATION	SAKURA NO	MODEL/APPLICATION	SAKURA NO
CATERPILLAR		CATERPILLAR		CATERPILLAR	
D9G (DOZERS) S/N: 66A3075-3265 Air Filter Set..... A-5557-S Air Filter Primary..... A-5557 Air Filter Secondary..... A-5526 Fuel Filter..... F-5501 Hydraulic Oil Filter..... H-5504 Oil Filter Full Flow..... 0-5503		D9H (DOZERS) S/N: 98V1-UP Air Filter Primary..... A-5521 Air Filter Secondary..... A-5529 Air Filter Set..... A-5521-S Hydraulic Oil Filter..... H-5503		Air Filter Set..... A-5562-S Air Filter Primary..... A-5561 Air Filter Secondary..... A-5560 Fuel Filter..... F-5505 Fuel Filter..... FC-5509 Hydraulic Oil Filter..... H-5510 Hydraulic Oil Filter..... H-5504 Hydraulic Oil Filter..... H-55270 Hydraulic Oil Filter..... H-5506 Oil Filter Full Flow..... C-5516	
D9G (DOZERS) S/N: 66A3266-4173 Air Filter Set..... A-5557-S Air Filter Secondary..... A-5526 Air Filter Primary..... A-5557 Fuel Filter..... F-5501 Hydraulic Oil Filter..... H-5503 Oil Filter Full Flow..... 0-5503		D9H (DOZERS) S/N: 99V1-UP Air Filter Set..... A-5521-S Air Filter Primary..... A-5521 Air Filter Secondary..... A-5529 Hydraulic Oil Filter..... H-5503		D9R (DOZERS) CAT 3408C (S/N: 7TL1-UP) Air Filter Primary..... A-5561 Air Filter Secondary..... A-5560 Air Filter Set..... A-5562-S Fuel Filter..... FC-5509 Hydraulic Oil Filter..... H-5510 Hydraulic Oil Filter..... H-5504 Oil Filter Full Flow..... C-5516	
D9G (DOZERS) S/N: 66A4174-9417 Air Filter Set..... A-5557-S Air Filter Secondary..... A-5526 Air Filter Primary..... A-5557 Fuel Filter..... F-5501 Hydraulic Oil Filter..... H-5503 Oil Filter Full Flow..... 0-5503		D9L (DOZERS) CAT 3412 (S/N: 14Y1-UP) Air Filter Set..... A-5532-S Air Filter Set..... A-5565-S Air Filter Primary..... A-5532 Air Filter Secondary..... A-5563 Air Filter Secondary..... A-55291 Air Filter..... A-5547 Air Filter Primary..... A-5564 Coolant Filter..... WC-5707 Fuel Filter..... FC-5509 Hydraulic Oil Filter..... H-5504 Oil Filter Full Flow..... C-5516		D9R (DOZERS) CAT 3408C (S/N: 7TL557-851) Air Filter Secondary..... A-5560 Air Filter Primary..... A-5561 Air Filter Set..... A-5562-S Fuel Filter..... FC-5509 Fuel Filter..... F-5505 Hydraulic Oil Filter..... H-5510 Hydraulic Oil Filter..... H-5506 Hydraulic Oil Filter..... H-5504 Hydraulic Oil Filter..... H-55270 Oil Filter Full Flow..... C-5516	
D9G (DOZERS) S/N: 66A9418-12015 Air Filter Set..... A-5521-S Air Filter Secondary..... A-5529 Air Filter Primary..... A-5521 Fuel Filter Secondary..... FC-5507 Oil Filter Full Flow..... 0-5503		D9N (DOZERS) S/N: 13D1-UP Air Filter Secondary..... A-5552 Air Filter Primary..... A-5521 Air Filter Set..... A-5521-S Fuel Filter..... F-5505 Hydraulic Oil Filter..... H-5504 Hydraulic Oil Filter..... H-55270 Oil Filter Full Flow..... C-5516		D9R (DOZERS) CAT 3408C (S/N: 7TL852-UP) Air Filter Set..... A-5562-S Air Filter Primary..... A-5561 Air Filter Secondary..... A-5560 Fuel Filter..... FC-5509 Hydraulic Oil Filter..... H-5506 Hydraulic Oil Filter..... H-55270 Hydraulic Oil Filter..... H-5510 Hydraulic Oil Filter..... H-5504 Oil Filter Full Flow..... C-5516	
D9G (DOZERS) S/N: 90J1-UP Air Filter Primary..... A-5557 Air Filter Set..... A-5557-S Fuel Filter..... F-5505 Hydraulic Oil Filter..... H-5503 Oil Filter Full Flow..... 0-5503		D9N (DOZERS) S/N: 13D2656N-13D2656N Air Filter Set..... A-5562-S Air Filter Secondary..... A-5560 Air Filter Primary..... A-5561		D9R (DOZERS) CAT 3408C (S/N: 8BL1053-UP) Air Filter Secondary..... A-5560 Air Filter Primary..... A-5561 Air Filter Set..... A-5562-S Fuel Filter..... FC-5509 Hydraulic Oil Filter..... H-5506 Hydraulic Oil Filter..... H-55270 Hydraulic Oil Filter..... H-5510 Hydraulic Oil Filter..... H-5504 Oil Filter Full Flow..... C-5516	
D9G (DOZERS) S/N: 91J1-UP Air Filter Primary..... A-5557 Air Filter Set..... A-5557-S Fuel Filter..... F-5505 Hydraulic Oil Filter..... H-5503 Oil Filter Full Flow..... 0-5503		D9N (DOZERS) S/N: 6XJ1-UP Air Filter Set..... A-5562-S Air Filter Primary..... A-5561 Air Filter Secondary..... A-5560 Fuel Filter..... FC-5509 Fuel Filter..... F-5505 Oil Filter Full Flow..... C-5516		D9R (DOZERS) CAT 3408C (S/N: 8BL1-830) Air Filter Set..... A-5562-S Air Filter Secondary..... A-5560 Air Filter Primary..... A-5561 Fuel Filter..... FC-5509	
D9H (DOZERS) S/N: 12U1-UP Air Filter Primary..... A-5521 Air Filter Set..... A-5521-S Air Filter Secondary..... A-5529 Hydraulic Oil Filter..... H-5503		D9N (DOZERS) S/N: 6YF1-540 Air Filter Set..... A-5562-S Air Filter Primary..... A-5561 Air Filter Secondary..... A-5560 Fuel Filter..... FC-5509 Hydraulic Oil Filter..... H-5504 Oil Filter Full Flow..... C-5516		D9R (DOZERS) CAT 3408C (S/N: 8BL1-830) Air Filter Set..... A-5562-S Air Filter Secondary..... A-5560 Air Filter Primary..... A-5561 Fuel Filter..... FC-5509	
D9H (DOZERS) S/N: 97V1-UP Air Filter Primary..... A-5521 Air Filter Secondary..... A-5529 Air Filter Set..... A-5521-S Hydraulic Oil Filter..... H-5503		D9R (DOZERS) CAT 3408C (S/N: 7TL1-556) Air Filter Set..... A-5562-S Air Filter Secondary..... A-5560 Air Filter Primary..... A-5561 Fuel Filter..... FC-5509		D9R (DOZERS) CAT 3408C (S/N: 8BL1-830) Air Filter Set..... A-5562-S Air Filter Secondary..... A-5560 Air Filter Primary..... A-5561 Fuel Filter..... FC-5509	

MODEL/APPLICATION	SAKURA NO	MODEL/APPLICATION	SAKURA NO	MODEL/APPLICATION	SAKURA NO
CATERPILLAR		CATERPILLAR		CATERPILLAR	
D9R (DOZERS) CAT 3408C (S/N: 8BL1-830) Fuel Filter..... F-5505 Hydraulic Oil Filter..... H-5510 Hydraulic Oil Filter..... H-55270 Hydraulic Oil Filter..... H-5506 Hydraulic Oil Filter..... H-5504 Oil Filter Full Flow..... C-5516		Hydraulic Oil Filter..... H-5504 Hydraulic Oil Filter..... H-55270 Hydraulic Oil Filter..... H-5506 Oil Filter Full Flow..... C-5516 D9R (DOZERS) CAT 3408E TA (S/N: 7TL1-UP) Air Filter Set..... A-5562-S Air Filter Primary..... A-5561 Air Filter Secondary..... A-5560 Fuel Filter..... FC-5509 Hydraulic Oil Filter..... H-5510 Hydraulic Oil Filter..... H-5504 Oil Filter Full Flow..... C-5516 D9R (DOZERS) CAT 3408C (S/N: 8BL1-UP) Air Filter Set..... A-5562-S Air Filter Primary..... A-5561 Air Filter Secondary..... A-5560 Fuel Filter..... FC-5509 Hydraulic Oil Filter..... H-5510 Hydraulic Oil Filter..... H-5504 Oil Filter Full Flow..... C-5516 D9R (DOZERS) CAT 3408C (S/N: 8BL830-1052) Air Filter Primary..... A-5561 Air Filter Set..... A-5562-S Air Filter Secondary..... A-5560 Fuel Filter..... FC-5509 Fuel Filter..... F-5505 Hydraulic Oil Filter..... H-5506 Hydraulic Oil Filter..... H-55270 Hydraulic Oil Filter..... H-5504 Hydraulic Oil Filter..... H-5510 Oil Filter Full Flow..... C-5516 D9R (DOZERS) CAT 3408C (S/N: ABK1-UP) Air Filter Primary..... A-5561 Air Filter Set..... A-5562-S Air Filter Secondary..... A-5560 Fuel Filter..... FC-5509 Hydraulic Oil Filter..... H-5510 Hydraulic Oil Filter..... H-5506 Hydraulic Oil Filter..... H-55270 Hydraulic Oil Filter..... H-5504 Hydraulic Oil Filter..... H-5510 Oil Filter Full Flow..... C-5516 D9R (DOZERS) CAT 3408C (S/N: ACL1-UP) Air Filter Primary..... A-5561 Air Filter Secondary..... A-5560 Air Filter Set..... A-5562-S Fuel Filter..... FC-5509 Hydraulic Oil Filter..... H-5510 Hydraulic Oil Filter..... H-5506 Hydraulic Oil Filter..... H-5504 Hydraulic Oil Filter..... H-55270 Hydraulic Oil Filter..... H-5504 Oil Filter Full Flow..... C-5516 D9R (DOZERS) CAT 3408C (S/N: 8BL1053-UP) Air Filter Primary..... A-5561 Air Filter Secondary..... A-5560 Air Filter Set..... A-5562-S Fuel Filter..... FC-5509 Hydraulic Oil Filter..... H-5506 Hydraulic Oil Filter..... H-5504 Hydraulic Oil Filter..... H-5510 Hydraulic Oil Filter..... H-55270 Oil Filter Full Flow..... C-5516 D9R (DOZERS) CAT 3408E TA (S/N: 8BL1-830) Air Filter Secondary..... A-5560 Air Filter Primary..... A-5561 Air Filter Set..... A-5562-S Fuel Filter..... F-5505 Fuel Filter..... FC-5509 Hydraulic Oil Filter..... H-5506 Hydraulic Oil Filter..... H-5504 Hydraulic Oil Filter..... H-55270 Hydraulic Oil Filter..... H-5504 Hydraulic Oil Filter..... H-5510 Oil Filter Full Flow..... C-5516		D9R (DOZERS) CAT 3408E TA (S/N: 8BL1-UP) Air Filter Primary..... A-5561 Air Filter Set..... A-5562-S Air Filter Secondary..... A-5560 Fuel Filter..... FC-5509 Hydraulic Oil Filter..... H-5504 Hydraulic Oil Filter..... H-5510 Oil Filter Full Flow..... C-5516 D9R (DOZERS) CAT 3408E TA (S/N: 8BL830-1052) Air Filter Secondary..... A-5560 Air Filter Primary..... A-5561 Air Filter Set..... A-5562-S Fuel Filter..... F-5505 Fuel Filter..... FC-5509 Hydraulic Oil Filter..... H-5506 Hydraulic Oil Filter..... H-55270 Hydraulic Oil Filter..... H-5510 Hydraulic Oil Filter..... H-5504 Oil Filter Full Flow..... C-5516 D9R (DOZERS) CAT 3408E TA (S/N: ABK1-UP) Air Filter Set..... A-5562-S Air Filter Secondary..... A-5560 Air Filter Primary..... A-5561 Fuel Filter..... FC-5509 Hydraulic Oil Filter..... H-5510 Hydraulic Oil Filter..... H-5504 Hydraulic Oil Filter..... H-55270 Hydraulic Oil Filter..... H-5506 Oil Filter Full Flow..... C-5516 D9R (DOZERS) CAT 3408E TA (S/N: ACL1-UP) Air Filter Set..... A-5562-S Air Filter Secondary..... A-5560 Air Filter Primary..... A-5561 Fuel Filter..... FC-5509 Hydraulic Oil Filter..... H-5510 Hydraulic Oil Filter..... H-5504 Hydraulic Oil Filter..... H-55270 Hydraulic Oil Filter..... H-5506 Oil Filter Full Flow..... C-5516 D9T (DOZERS) CAT S/N: RHX1-UP , 2008-UP Air Filter Set..... A-44240-S Air Filter Secondary..... A-44230 Air Filter Primary..... A-44220 Fuel Filter..... FC-5517 Fuel Filter..... FC-5510 Fuel Filter..... FC-5509 Hydraulic Oil Filter..... HC-55170 Hydraulic Oil Filter..... H-5506 D9T (DOZERS) CAT S/N: RJS1-689-UP , 2008-UP Air Filter Secondary..... A-44230 Air Filter Set..... A-44240-S Air Filter Primary..... A-44220	

Sakura Filter

ENGINE APPLICATION

MODEL/APPLICATION	SAKURA NO	MODEL/APPLICATION	SAKURA NO	MODEL/APPLICATION	SAKURA NO
CATERPILLAR		CATERPILLAR		CATERPILLAR	
D9T (DOZERS) CAT S/N: RJS1-689-UP , 2008-UP		DW-10 (SCRAPERS)		Fuel Filter.....	F-5501
Fuel Filter.....	FC-5510	Air Filter Secondary.....	A-5508	Oil Filter Full Flow.....	0-5503
Fuel Filter.....	FC-5509	Air Filter Set.....	A-5507-S		
Fuel Filter.....	FC-5517	Air Filter Set.....	A-55071-S	DW-21 (SCRAPERS) S/N: 58C-UP	
Hydraulic Oil Filter.....	HC-55170	Air Filter Primary.....	A-5507	Fuel Filter.....	F-5501
Hydraulic Oil Filter.....	H-5506	Oil Filter Full Flow.....	0-5501	Oil Filter Full Flow.....	0-5503
D9T (DOZERS) CAT S/N: RJS690-UP , 2008-UP		DW-15 (SCRAPERS)		DW-21 (SCRAPERS) S/N: 69C-UP	
Air Filter Set.....	A-44240-S	Fuel Filter.....	F-5501	Fuel Filter.....	F-5501
Air Filter Primary.....	A-44220	Oil Filter Full Flow.....	0-5501	Oil Filter Full Flow.....	0-5503
Air Filter Secondary.....	A-44230	Oil Filter Full Flow.....	0-5503	DW-21 (SCRAPERS) S/N: 8W1-1060	
Fuel Filter.....	FC-5517	DW-15 (SCRAPERS) S/N: 45C-UP		Oil Filter Full Flow.....	0-5503
Fuel Filter.....	FC-5509	Oil Filter Full Flow.....	0-5501	DW-21 (SCRAPERS) S/N: 85E-UP	
Fuel Filter.....	FC-5510	Oil Filter Full Flow.....	0-5503	Fuel Filter.....	F-5501
Hydraulic Oil Filter.....	H-5506	DW-15 (SCRAPERS) S/N: 59C-UP		Oil Filter Full Flow.....	0-5503
DP20 (FORKLIFTS)		Fuel Filter.....	F-5501	DW-21 (SCRAPERS) S/N: 86E-UP	
Air Filter.....	A-1096	Oil Filter Full Flow.....	0-5501	Fuel Filter.....	F-5501
Oil Filter Full Flow.....	C-5811	Oil Filter Full Flow.....	0-5503	Oil Filter Full Flow.....	0-5503
DP40 (FORKLIFTS)		DW-15 (SCRAPERS) S/N: 70C1-343		E110 (EXCAVATORS) MITSUBISHI 4D31T (S/N: 3FG1-UP)	
Fuel Filter.....	FC-1007	Fuel Filter.....	F-5501	Hydraulic Oil Filter.....	HC-5801
DP45 (FORKLIFTS)		Oil Filter Full Flow.....	0-5503	E110B (EXCAVATORS) MITSUBISHI 4D32 DIESEL (S/N: 4FJ1-UP)	
Air Filter Secondary.....	A-5525	Oil Filter Full Flow.....	0-5501	Fuel Filter Secondary.....	FC-5507
DP45 (FORKLIFTS) w/Mitsubishi S6E Eng.		DW-20 (SCRAPERS) S/N: 21C1-822		E110B (EXCAVATORS) MITSUBISHI 4D32 DIESEL (S/N: 5GK1-UP)	
Air Filter Secondary.....	A-5590	Oil Filter Full Flow.....	0-5503	Fuel Filter Secondary.....	FC-5507
DP45 (FORKLIFTS) w/Mitsubishi S6S Eng.		DW-20 (SCRAPERS) S/N: 21C823-UP		E110B (EXCAVATORS) MITSUBISHI 4D32 DIESEL (S/N: 8MF1-UP)	
Air Filter Secondary.....	A-5590	Oil Filter Full Flow.....	0-5503	Fuel Filter Secondary.....	FC-5507
DP45K (FORKLIFTS) w/Mitsubishi S6S Eng.		DW-20 (SCRAPERS) S/N: 50C-UP		E110B (EXCAVATORS) MITSUBISHI 4D32 DIESEL (S/N: 9HF1-UP)	
Air Filter Secondary.....	A-5590	Oil Filter Full Flow.....	0-5503	Fuel Filter Secondary.....	FC-5507
DP50 (FORKLIFTS) w/Mitsubishi S6E Eng.		DW-20 (SCRAPERS) S/N: 57C-UP		E110B (EXCAVATORS) MITSUBISHI 4D32 DIESEL (S/N: 8MF1-UP)	
Air Filter Secondary.....	A-5590	Fuel Filter.....	F-5501	Air Filter Set.....	A-5663-S
DP50 (FORKLIFTS) w/Mitsubishi S6S Eng.		Oil Filter Full Flow.....	0-5503	Air Filter Primary.....	A-5627
Air Filter Secondary.....	A-5590	DW-20 (SCRAPERS) S/N: 6W1-274		Fuel Filter.....	FC-5516
DP50K (FORKLIFTS) w/Mitsubishi S6S Eng.		Oil Filter Full Flow.....	0-5503	Fuel Filter.....	F-5505
Air Filter Secondary.....	A-5590	DW-20 (SCRAPERS) S/N: 6W275-324		Fuel Filter Secondary.....	FC-5507
DP70 (FORKLIFTS)		Oil Filter Full Flow.....	0-5503	Fuel Filter Secondary.....	FC-5515
Fuel Filter.....	FC-1007	DW-20 (SCRAPERS) S/N: 67C-UP		Fuel Filter Secondary.....	FC-55151
Oil Filter Full Flow.....	C-5811	Fuel Filter.....	F-5501	Hydraulic Oil Filter.....	HC-5801
DP70 (FORKLIFTS) w/Mitsubishi S6S Eng.		Oil Filter Full Flow.....	0-5503	Oil Filter Full Flow.....	C-5505
Air Filter Secondary.....	A-5590	DW-20 (SCRAPERS) S/N: 87E-UP		E120 (EXCAVATORS) MITSUBISHI 4D32 DIESEL (S/N: 1LF9251-UP)	
DPL40 (FORKLIFTS)		Fuel Filter.....	F-5501	Fuel Filter.....	FC-1010
Air Filter Secondary.....	A-5525	Oil Filter Full Flow.....	0-5503	Hydraulic Oil Filter.....	HC-5801
DW-20 (SCRAPERS) S/N: 88E-UP		DW-20 (SCRAPERS) S/N: 88E-UP		Oil Filter Combination.....	0-1006
				E120 (EXCAVATORS) MITSUBISHI 6D14 (S/N: 1LF1-UP)	
				Hydraulic Oil Filter.....	HC-5801

MODEL/APPLICATION	SAKURA NO
CATERPILLAR	
E120B (EXCAVATORS) MITSUBISHI 4D32 DIESEL (S/N: 4XK1-UP)	
Fuel Filter Secondary.....	FC-5507
E120B (EXCAVATORS) MITSUBISHI 4D32 DIESEL (S/N: 7NF1-UP)	
Fuel Filter Secondary.....	FC-5507
E120B (EXCAVATORS) MITSUBISHI 54K-T (S/N: 6JF1-UP)	
Air Filter Set.....	A-5663-S
Air Filter Primary.....	A-5627
Fuel Filter Secondary.....	FC-5507
Fuel Filter Secondary.....	FC-5515
Fuel Filter.....	F-5505
Fuel Filter Secondary.....	FC-55151
Fuel Filter.....	FC-5516
Hydraulic Oil Filter.....	HC-5801
Oil Filter Full Flow.....	C-5505
E140 (EXCAVATORS) MITSUBISHI 4D32 DIESEL (S/N: 1NF9011-UP)	
Fuel Filter.....	FC-1010
Hydraulic Oil Filter.....	HC-5801
Oil Filter Combination.....	O-1006
E140 (EXCAVATORS) MITSUBISHI 6D14 (S/N: 1NF09041-UP)	
Hydraulic Oil Filter.....	HC-5801
E180 (EXCAVATORS) CAT 3204 (S/N: 1RF1-UP)	
Air Filter Secondary.....	A-5508
Air Filter Primary.....	A-5507
Air Filter Set.....	A-55071-S
Air Filter Set.....	A-5507-S
Fuel Filter Secondary.....	FC-5507
Hydraulic Oil Filter.....	H-5505
Hydraulic Oil Filter.....	HC-5801
Oil Filter Full Flow.....	C-5505
E180 (EXCAVATORS) CAT 3204 (S/N: 4EF1-UP)	
Air Filter Set.....	A-5507-S
Air Filter Secondary.....	A-5508
Air Filter Primary.....	A-5507
Air Filter Set.....	A-55071-S
Fuel Filter Secondary.....	FC-5507
Hydraulic Oil Filter.....	H-5505
Oil Filter Full Flow.....	C-5505
E180 (EXCAVATORS) MITSUBISHI 4D32 DIESEL (S/N: 1RF101-UP)	
Air Filter Secondary.....	A-5525
Air Filter Set.....	A-55071-S
Air Filter Primary.....	A-5507
Air Filter Set.....	A-5507-S
Fuel Filter.....	FC-5503
Hydraulic Oil Filter.....	HC-5801
Oil Filter Full Flow.....	C-5505
E200B (EXCAVATORS) MITSUBISHI 4D32 DIESEL (S/N: 4SG1-UP)	
Fuel Filter Secondary.....	FC-5507

MODEL/APPLICATION	SAKURA NO
CATERPILLAR	
E200B (EXCAVATORS) MITSUBISHI 4D32 DIESEL (S/N: 6KG1-UP)	
Fuel Filter Secondary.....	FC-5507
E200B (EXCAVATORS) MITSUBISHI 56K-T (S/N: 6KF00234-UP)	
Air Filter Primary.....	A-5627
Air Filter Set.....	A-5663-S
Fuel Filter Secondary.....	FC-5507
Fuel Filter.....	F-5505
Hydraulic Oil Filter.....	H-5505
Hydraulic Oil Filter.....	HC-5801
Oil Filter Full Flow.....	C-5510
E200B (EXCAVATORS) MITSUBISHI 56K-T (S/N: 6KF1-00233-UP)	
Air Filter Secondary.....	A-6007
Air Filter Primary.....	A-5627
Air Filter Set.....	A-6118-S
Air Filter Set.....	A-5663-S
Air Filter Primary.....	A-6006
Fuel Filter.....	FC-5516
Fuel Filter.....	F-5505
Fuel Filter Secondary.....	FC-55151
Fuel Filter Secondary.....	FC-5515
Fuel Filter Secondary.....	FC-5507
Hydraulic Oil Filter.....	H-5505
Oil Filter Full Flow.....	C-5510
E200B (EXCAVATORS) MITSUBISHI 56K-T (S/N: 7DF1-UP)	
Air Filter Set.....	A-5663-S
Air Filter Primary.....	A-5627
Air Filter Set.....	A-6118-S
Air Filter Primary.....	A-6006
Air Filter Secondary.....	A-6007
Fuel Filter.....	F-5505
Fuel Filter.....	FC-5516
Fuel Filter Secondary.....	FC-55151
Fuel Filter Secondary.....	FC-5515
Hydraulic Oil Filter.....	H-5505
Oil Filter Full Flow.....	C-5510
E200B (EXCAVATORS) S/N: 6KF1-UP	
Air Filter Primary.....	A-5627
Air Filter Set.....	A-6118-S
Air Filter Secondary.....	A-6007
Air Filter Secondary.....	A-6008
Air Filter Primary.....	A-6006
Air Filter Set.....	A-5663-S
Fuel Filter Secondary.....	FC-5507
Hydraulic Oil Filter.....	HC-5801
Hydraulic Oil Filter.....	H-5505
Hydraulic Oil Filter.....	H-5513
Oil Filter Full Flow.....	C-5510
E240 (EXCAVATORS) CAT 3304 (S/N: 1FG1-UP)	
Air Filter Set.....	A-5522-S
Air Filter Secondary.....	A-5510
Air Filter Primary.....	A-5509
Fuel Filter Secondary.....	FC-5507

MODEL/APPLICATION	SAKURA NO
CATERPILLAR	
Hydraulic Oil Filter.....	H-5505
Hydraulic Oil Filter.....	HC-5801
Oil Filter Full Flow.....	C-5510
E240 (EXCAVATORS) CAT 3304 (S/N: 4JF1-UP)	
Air Filter Secondary.....	A-5520
Air Filter Primary.....	A-5509
Air Filter Set.....	A-5522-S
Fuel Filter Secondary.....	FC-5507
Hydraulic Oil Filter.....	H-5505
Oil Filter Full Flow.....	C-5510
E240 (EXCAVATORS) MITSUBISHI 4D32 DIESEL (S/N: 1FG1-UP)	
Air Filter Secondary.....	A-5510
Air Filter Primary.....	A-5509
Air Filter Set.....	A-5522-S
Fuel Filter Secondary.....	FC-5507
Hydraulic Oil Filter.....	HC-5801
Hydraulic Oil Filter.....	H-5505
Oil Filter Full Flow.....	C-5510
E240-EL240 (EXCAVATORS) S/N: 4JF1-UP	
Air Filter Primary.....	A-5509
Air Filter Set.....	A-5522-S
Air Filter Primary.....	A-5549
Air Filter Primary.....	A-5549M
Air Filter Set.....	A-5549M-S
Air Filter Secondary.....	A-5510
Air Filter Secondary.....	A-5550
Fuel Filter Secondary.....	FC-5507
Hydraulic Oil Filter.....	HC-5801
Oil Filter Full Flow.....	C-5510
E240B (EXCAVATORS) CAT 3116 (S/N: 5WG1-UP) , TO-2001	
Fuel Filter.....	FC-5516
Fuel Filter Secondary.....	FC-5515
Fuel Filter.....	F-5505
Fuel Filter Secondary.....	FC-55151
Hydraulic Oil Filter.....	H-5505
Oil Filter Full Flow.....	C-5510
E240B (EXCAVATORS) CAT 3116 (S/N: 8SF1-UP)	
Fuel Filter Secondary.....	FC-55151
Fuel Filter.....	FC-5516
Fuel Filter.....	F-5505
Fuel Filter Secondary.....	FC-5507
Fuel Filter Secondary.....	FC-5515
Hydraulic Oil Filter.....	H-5505
Hydraulic Oil Filter.....	HC-5801
Oil Filter Full Flow.....	C-5510
E240B (EXCAVATORS) MITSUBISHI 4D32 DIESEL (S/N: 9PF1-UP)	
Fuel Filter Secondary.....	FC-5507
E240C (EXCAVATORS) CAT 3116 (S/N: 2RL1-UP)	
Fuel Filter Secondary.....	FC-55151
Fuel Filter.....	F-5505
Fuel Filter.....	FC-5516

MODEL/APPLICATION	SAKURA NO	MODEL/APPLICATION	SAKURA NO	MODEL/APPLICATION	SAKURA NO
CATERPILLAR		CATERPILLAR		CATERPILLAR	
E240C (EXCAVATORS) CAT 3116 (S/N: 2RL1-UP)		Hydraulic Oil Filter.....	HC-5801	Air Filter Secondary.....	A-5525
Fuel Filter Secondary.....	FC-5515	E450 (EXCAVATORS) MITSUBISHI 6D22TC (S/N: 3HG1-UP)		Fuel Filter.....	FC-5503
Hydraulic Oil Filter.....	H-5505	Air Filter Primary.....	A-6113	Hydraulic Oil Filter.....	HC-5801
Oil Filter Full Flow.....	C-5510	Hydraulic Oil Filter.....	HC-5801	Oil Filter Full Flow.....	C-5504
E240C (EXCAVATORS) CAT 3116 (S/N: 9PK1-UP)		Hydraulic Oil Filter.....	H-5505	EL180 (EXCAVATORS) S/N: 4EF1-100	
Fuel Filter Secondary.....	FC-5515	E650 (EXCAVATORS) MITSUBISHI 56B-TA (S/N: 3KG1-UP)		Air Filter Secondary.....	A-5567
Fuel Filter.....	FC-5516	Hydraulic Oil Filter.....	HC-5801	Air Filter Primary.....	A-5566
Fuel Filter.....	F-5505	Hydraulic Oil Filter.....	H-5505	Air Filter Primary.....	A-5507
Fuel Filter Secondary.....	FC-55151	E70 (EXCAVATORS) MITSUBISHI 4D31 (S/N: 3BG1-UP)		Air Filter Set.....	A-55071-S
Hydraulic Oil Filter.....	H-5505	Fuel Filter.....	FC-1016	Air Filter Set.....	A-5507-S
Oil Filter Full Flow.....	C-5510	E70B (EXCAVATORS) MITSUBISHI 4D32 (S/N: 5TG1-UP)		Air Filter Set.....	A-5568-S
E300 (EXCAVATORS) CAT 3306 (S/N: 2CF1-UP)		Fuel Filter.....	FC-1016	Air Filter Secondary.....	A-5508
Air Filter Secondary.....	A-5510	E70B (EXCAVATORS) MITSUBISHI 4D32 DIESEL		Fuel Filter Secondary.....	FC-5507
Air Filter Set.....	A-5522-S	Fuel Filter.....	FC-1016	Hydraulic Oil Filter.....	HC-5801
Air Filter Primary.....	A-5509	E70B (EXCAVATORS) S/N: 6AK1-UP		Oil Filter Full Flow.....	C-5505
Fuel Filter Secondary.....	FC-5507	Air Filter Secondary.....	A-5580	EL200B (EXCAVATORS) MITSUBISHI 56K-T (S/N: 7DF00688-UP)	
Hydraulic Oil Filter.....	H-5505	E70B (EXCAVATORS) S/N: 7YF1-UP		Air Filter Primary.....	A-5627
Hydraulic Oil Filter.....	HC-5801	Air Filter Secondary.....	A-5580	Air Filter Set.....	A-5663-S
Oil Filter Full Flow.....	C-5510	E70 3BG-ON (EXCAVATORS) w/Mitsubishi 4D31 Eng		Fuel Filter Secondary.....	FC-5507
E300 (EXCAVATORS) CAT 3306 (S/N: 4NF1-UP)		Hydraulic Oil Filter.....	H-5519	Hydraulic Oil Filter.....	HC-5801
Air Filter Set.....	A-5522-S	E70B 5TG-ON (EXCAVATORS) w/Mitsubishi 4D32 Eng		Hydraulic Oil Filter.....	H-5505
Air Filter Primary.....	A-5509	Hydraulic Oil Filter.....	H-5519	Hydraulic Oil Filter.....	HC-5801
Air Filter Secondary.....	A-5510	EL120B (EXCAVATORS) S/N: 6JF1-UP		Hydraulic Oil Filter.....	H-5513
Fuel Filter Secondary.....	FC-5507	Air Filter Set.....	A-5663-S	Oil Filter Full Flow.....	C-5510
Hydraulic Oil Filter.....	H-5505	Air Filter Secondary.....	A-6008	EL200B (EXCAVATORS) S/N: 5EG1-UP	
Oil Filter Full Flow.....	C-5510	Air Filter Primary.....	A-5627	Fuel Filter Secondary.....	FC-5507
E300B (EXCAVATORS) CAT 3306T (S/N: 1WJ1-UP)		Fuel Filter Secondary.....	FC-5515	Hydraulic Oil Filter.....	HC-5801
Fuel Filter Secondary.....	FC-5507	Fuel Filter.....	FC-5516	Hydraulic Oil Filter.....	H-5513
Hydraulic Oil Filter.....	H-5505	Fuel Filter Secondary.....	FC-55151	Oil Filter Full Flow.....	C-5510
Hydraulic Oil Filter.....	HC-5801	Oil Filter Full Flow.....	C-5505	EL200B (EXCAVATORS) S/N: 6FK1-UP	
Oil Filter Full Flow.....	C-5510	EL180 (EXCAVATORS) S/N: 1RF1-100		Air Filter Set.....	A-5663-S
E300B (EXCAVATORS) CAT 3306T (S/N: 3FJ1-UP)		Air Filter Secondary.....	A-5567	Air Filter Secondary.....	A-6008
Fuel Filter Secondary.....	FC-5507	Air Filter Set.....	A-5507-S	Air Filter Primary.....	A-5627
Hydraulic Oil Filter.....	H-5505	Air Filter Set.....	A-5568-S	Fuel Filter Secondary.....	FC-5507
Hydraulic Oil Filter.....	HC-5801	Air Filter Primary.....	A-5566	Hydraulic Oil Filter.....	HC-5801
Oil Filter Full Flow.....	C-5510	Air Filter Primary.....	A-5507	Oil Filter Full Flow.....	C-5510
E300B (EXCAVATORS) MITSUBISHI 4D32 DIESEL (S/N: 2CF101-UP)		Air Filter Set.....	A-55071-S	EL240B (EXCAVATORS) CAT 3116 (S/N: 5WG1-UP)	
Fuel Filter Secondary.....	FC-5507	Air Filter Secondary.....	A-5508	Fuel Filter.....	F-5505
Hydraulic Oil Filter.....	H-5505	Fuel Filter Secondary.....	FC-5507	Fuel Filter Secondary.....	FC-55151
Hydraulic Oil Filter.....	HC-5801	Fuel Filter.....	FC-5516	Fuel Filter Secondary.....	FC-5515
Oil Filter Full Flow.....	C-5510	Fuel Filter Secondary.....	FC-55151	Fuel Filter Secondary.....	FC-5507
E300B (EXCAVATORS) MITSUBISHI 4D32 DIESEL (S/N: 1WJ1-UP)		Oil Filter Full Flow.....	C-5505	Fuel Filter.....	FC-5516
Fuel Filter Secondary.....	FC-5507	EL180 (EXCAVATORS) S/N: 4EF101-UP		Hydraulic Oil Filter.....	H-5505
Oil Filter Full Flow.....	C-5510	Air Filter Primary.....	A-5542	Hydraulic Oil Filter.....	HC-5801
E300B (EXCAVATORS) MITSUBISHI 4D32 DIESEL (S/N: 3FJ1-UP)		Air Filter Set.....	A-5542-S	Oil Filter Full Flow.....	C-5510
Fuel Filter Secondary.....	FC-5507	EL180 (EXCAVATORS) S/N: 4EF101-UP		EL240B (EXCAVATORS) CAT 3116 (S/N: 8SF1-UP)	
Oil Filter Full Flow.....	C-5510	Air Filter Primary.....	A-5542	Fuel Filter Secondary.....	FC-55151
E450 (EXCAVATORS) MITSUBISHI 4D32 DIESEL (S/N: 3HG9201-UP)		Air Filter Set.....	A-5542-S	Fuel Filter Secondary.....	FC-5515
				Fuel Filter.....	F-5505

MODEL/APPLICATION	SAKURA NO	MODEL/APPLICATION	SAKURA NO	MODEL/APPLICATION	SAKURA NO
CATERPILLAR		CATERPILLAR		CATERPILLAR	
EL240B (EXCAVATORS) CAT 3116 (S/N: 8SF1-UP)		Fuel Filter Secondary.....	FC-5507	Hydraulic Oil Filter.....	H-5506
Fuel Filter.....	FC-5516	Fuel Filter.....	F-5505	Oil Filter Full Flow.....	C-5510
Hydraulic Oil Filter.....	H-5505	Hydraulic Oil Filter.....	H-5506		
Oil Filter Full Flow.....	C-5510	Oil Filter Full Flow.....	C-5505		
EL300 (EXCAVATORS) CAT 3306 (S/N: 2CF1-UP)		G916 (LOADERS) S/N: 5GD46-UP		G936 (LOADERS) S/N: 4ND1-UP	
Air Filter Set.....	A-5522-S	Air Filter Set.....	A-5507-S	Air Filter Primary.....	A-5509
Air Filter Primary.....	A-5509	Air Filter Primary.....	A-5507	Air Filter Secondary.....	A-5522
Air Filter Secondary.....	A-5510	Air Filter Set.....	A-55071-S	Air Filter Set.....	A-5522-S
Fuel Filter Secondary.....	FC-5507	Air Filter.....	A-5530	Fuel Filter Secondary.....	FC-5507
Hydraulic Oil Filter.....	HC-5801	Hydraulic Oil Filter.....	H-5501	Fuel Filter.....	F-5505
Hydraulic Oil Filter.....	H-5505	Hydraulic Oil Filter.....	H-5506	Hydraulic Oil Filter.....	H-5506
Oil Filter Full Flow.....	C-5510	Hydraulic Oil Filter.....	H-5506	Oil Filter Full Flow.....	C-5510
EL300 (EXCAVATORS) CAT 3306 (S/N: 4NF1-UP)		G916 (LOADERS) S/N: 5GD-UP		G936 (LOADERS) S/N: 4SB-UP	
Air Filter Set.....	A-5522-S	Air Filter Secondary.....	A-5525	Air Filter Set.....	A-5522-S
Air Filter Primary.....	A-5509	Air Filter Primary.....	A-5542	Air Filter Primary.....	A-5549
Air Filter Secondary.....	A-5510	Air Filter Set.....	A-5542-S	Air Filter Secondary.....	A-5550
Fuel Filter Secondary.....	FC-5507	Fuel Filter.....	FC-5503	Air Filter Primary.....	A-5509
Hydraulic Oil Filter.....	HC-5801	Hydraulic Oil Filter.....	H-5506	Air Filter Primary.....	A-5549M
Hydraulic Oil Filter.....	H-5505	Oil Filter Full Flow.....	C-5504	Air Filter Set.....	A-5549M-S
Oil Filter Full Flow.....	C-5510			Fuel Filter.....	FC-5501
EL70B (EXCAVATORS) S/N: 5TG1-752		G916 (LOADERS) S/N: 8GD-UP		Fuel Filter Secondary.....	FC-5507
Fuel Filter.....	FC-1016	Air Filter Primary.....	A-5542	Fuel Filter.....	FC-5523
Hydraulic Oil Filter.....	H-5513	Air Filter Secondary.....	A-5525	Hydraulic Oil Filter.....	H-5506
		Air Filter Set.....	A-5542-S	Oil Filter Full Flow.....	C-5510
EL70B 5TG-ON (EXCAVATORS) w/Mitsubishi 4D32 Eng		Fuel Filter.....	FC-5503		
Hydraulic Oil Filter.....	H-5519	Hydraulic Oil Filter.....	H-5506	G936 (LOADERS) S/N: 4SZ-UP	
		Oil Filter Full Flow.....	C-5504	Air Filter Primary.....	A-5549
G916 (LOADERS) CAT (S/N: 45V42589-UP)		G910 (LOADERS) S/N: 3SD1-UP		Air Filter Set.....	A-5549M-S
Fuel Filter.....	FC-5523	Air Filter Primary.....	A-5542	Air Filter Set.....	A-5522-S
Fuel Filter.....	FC-5501	Air Filter Secondary.....	A-5525	Air Filter Primary.....	A-5509
Oil Filter Full Flow.....	C-5505	Fuel Filter Secondary.....	FC-5507	Air Filter Secondary.....	A-5550
		Fuel Filter.....	FC-5503	Air Filter Primary.....	A-5549M
G916 (LOADERS) S/N: 1SD-UP		Hydraulic Oil Filter.....	H-55270	Fuel Filter Secondary.....	FC-5507
Air Filter Primary.....	A-5542	Hydraulic Oil Filter.....	H-5504	Fuel Filter.....	FC-5523
Air Filter Set.....	A-5542-S	Oil Filter Full Flow.....	C-5519	Fuel Filter.....	FC-5501
Air Filter Secondary.....	A-5525			Hydraulic Oil Filter.....	H-5506
Fuel Filter.....	FC-5503	G910 (LOADERS) S/N: 8GD1-UP		Oil Filter Full Flow.....	C-5510
Hydraulic Oil Filter.....	H-5506	Air Filter Primary.....	A-5542		
Oil Filter Full Flow.....	C-5504	Air Filter Secondary.....	A-5525	G936 (LOADERS) S/N: 8ED1-UP	
		Air Filter Set.....	A-5542-S	Air Filter Set.....	A-5522-S
G916 (LOADERS) S/N: 5GD1-45-UP		Fuel Filter.....	FC-5503	Air Filter Primary.....	A-5509
Air Filter Set.....	A-5507-S	Hydraulic Oil Filter.....	H-55270	Air Filter Secondary.....	A-5522
Air Filter.....	A-5530	Hydraulic Oil Filter.....	H-5504	Fuel Filter.....	F-5505
Air Filter Primary.....	A-5507	Oil Filter Full Flow.....	C-5519	Fuel Filter Secondary.....	FC-5507
Air Filter Set.....	A-55071-S			Hydraulic Oil Filter.....	H-5506
Hydraulic Oil Filter.....	H-5506	G910 (LOADERS) w/3204 Eng.		Oil Filter Full Flow.....	C-5510
Hydraulic Oil Filter.....	H-5501	Air Filter Secondary.....	A-5590		
		G936 (LOADERS) S/N: 3HD1-UP		GC20N (FORKLIFTS) w/Mitsubishi K21 Eng.	
G916 (LOADERS) S/N: 5GD1-47		Air Filter Secondary.....	A-5522	Air Filter Primary.....	A-85134
Air Filter Primary.....	A-5507	Air Filter Primary.....	A-5509		
Air Filter Set.....	A-5507-S	Air Filter Set.....	A-5522-S	GC20N (FORKLIFTS) w/Mitsubishi K25 Eng.	
Air Filter Set.....	A-55071-S	Fuel Filter Secondary.....	FC-5507	Air Filter Primary.....	A-85134
Air Filter.....	A-5530	Fuel Filter.....	F-5505		
				GC25N (FORKLIFTS) w/Mitsubishi K21 Eng.	
				Air Filter Primary.....	A-85134
				GC25N (FORKLIFTS) w/Mitsubishi K25 Eng.	
				Air Filter Primary.....	A-85134

Sakura Filter

ENGINE APPLICATION

MODEL/APPLICATION	SAKURA NO	MODEL/APPLICATION	SAKURA NO	MODEL/APPLICATION	SAKURA NO
CATERPILLAR		CATERPILLAR		CATERPILLAR	
GC28N (<i>FORKLIFTS</i>) w/Mitsubishi K21 Eng. Air Filter Primary.....	A-85134	Air Filter Primary.....	A-85134	Air Filter Secondary.....	A-5590
GC28N (<i>FORKLIFTS</i>) w/Mitsubishi K25 Eng. Air Filter Primary.....	A-85134	GP20CN (<i>FORKLIFTS</i>) w/Mitsubishi K21 Eng. Air Filter Primary.....	A-85134	GP50K (<i>FORKLIFTS</i>) w/Nissan TB45 (4.5L) Eng. , 4500 Air Filter Secondary.....	A-5590
GC35K (<i>FORKLIFTS</i>) w/GM 4.3L Eng. , 4300 Air Filter Secondary.....	A-5590	GP20CN (<i>FORKLIFTS</i>) w/Mitsubishi K25 Eng. Air Filter Primary.....	A-85134	GPL40 (<i>FORKLIFTS</i>) w/GMC 4.3L Eng. , 4300 Air Filter Secondary.....	A-5590
GC30N (<i>FORKLIFTS</i>) w/Mitsubishi K21 Eng. Air Filter Primary.....	A-85134	GP20HN (<i>FORKLIFTS</i>) w/Mitsubishi K25 Eng. Air Filter Primary.....	A-85134	GPL40 (<i>FORKLIFTS</i>) w/Mitsubishi 6G72 Eng. Air Filter Secondary.....	A-5590
GC30N (<i>FORKLIFTS</i>) w/Mitsubishi K25 Eng. Air Filter Primary.....	A-85134	GP20N (<i>FORKLIFTS</i>) w/Mitsubishi K21 Eng. Air Filter Primary.....	A-85134	IT12F (<i>INTEGRATED TOOL-CARRIERS</i>) CAT 3054 (S/N: 1KF1-UP) Hydraulic Oil Filter.....	H-5510
GC33N (<i>FORKLIFTS</i>) w/Mitsubishi K21 Eng. Air Filter Primary.....	A-85134	GP20N (<i>FORKLIFTS</i>) w/Mitsubishi K25 Eng. Air Filter Primary.....	A-85134	IT12F (<i>INTEGRATED TOOL-CARRIERS</i>) S/N: 1KF820-UP Air Filter Primary.....	A-5627
GC33N (<i>FORKLIFTS</i>) w/Mitsubishi K25 Eng. Air Filter Primary.....	A-85134	GP20ZN (<i>FORKLIFTS</i>) w/Mitsubishi K25 Eng. Air Filter Primary.....	A-85134	Air Filter Secondary.....	A-6008
GC60K (<i>FORKLIFTS</i>) w/GM 4.3L Eng. , 4300 Air Filter Secondary.....	A-5590	GP25HN (<i>FORKLIFTS</i>) w/Mitsubishi K25 Eng. Air Filter Primary.....	A-85134	Air Filter Set.....	A-5663-S
GP15N (<i>FORKLIFTS</i>) w/Mitsubishi K15 Eng. Air Filter Primary.....	A-85134	GP25N (<i>FORKLIFTS</i>) w/Mitsubishi K25 Eng. Air Filter Primary.....	A-85134	Fuel Filter Secondary.....	FC-5515
GP15N (<i>FORKLIFTS</i>) w/Mitsubishi K21 Eng. Air Filter Primary.....	A-85134	GP25N (<i>FORKLIFTS</i>) w/Mitsubishi K21 Eng. Air Filter Primary.....	A-85134	Fuel Filter.....	F-5505
GP15N (<i>FORKLIFTS</i>) w/Mitsubishi K25 Eng. Air Filter Primary.....	A-85134	GP25ZN (<i>FORKLIFTS</i>) w/Mitsubishi K25 Eng. Air Filter Primary.....	A-85134	Fuel Filter.....	FC-5516
GP15Z (<i>FORKLIFTS</i>) w/Mitsubishi K15 Eng. Air Filter Primary.....	A-85134	GP30N (<i>FORKLIFTS</i>) w/Mitsubishi K21 Eng. Air Filter Primary.....	A-85134	Fuel Filter Secondary.....	FC-55151
GP15Z (<i>FORKLIFTS</i>) w/Mitsubishi K21 Eng. Air Filter Primary.....	A-85134	GP30N (<i>FORKLIFTS</i>) w/Mitsubishi K25 Eng. Air Filter Primary.....	A-85134	Hydraulic Oil Filter.....	H-5510
GP15Z (<i>FORKLIFTS</i>) w/Mitsubishi K25 Eng. Air Filter Primary.....	A-85134	GP35N (<i>FORKLIFTS</i>) w/Mitsubishi K21 Eng. Air Filter Primary.....	A-85134	Hydraulic Oil Filter.....	HC-5504
GP18N (<i>FORKLIFTS</i>) w/Mitsubishi K15 Eng. Air Filter Primary.....	A-85134	GP35N (<i>FORKLIFTS</i>) w/Mitsubishi K25 Eng. Air Filter Primary.....	A-85134	Oil Filter Full Flow.....	C-5505
GP18N (<i>FORKLIFTS</i>) w/Mitsubishi K21 Eng. Air Filter Primary.....	A-85134	GP40 (<i>FORKLIFTS</i>) w/GMC 4.3L Eng. , 4300 Air Filter Secondary.....	A-5590	IT12F (<i>INTEGRATED TOOL-CARRIERS</i>) S/N: 1SF1446-UP Fuel Filter Secondary.....	FC-5515
GP18N (<i>FORKLIFTS</i>) w/Mitsubishi K25 Eng. Air Filter Primary.....	A-85134	GP40 (<i>FORKLIFTS</i>) w/Mitsubishi 6G72 Eng. Air Filter Secondary.....	A-5590	Fuel Filter.....	FC-5516
GP18Z (<i>FORKLIFTS</i>) w/Mitsubishi K21 Eng. Air Filter Primary.....	A-85134	GP45 (<i>FORKLIFTS</i>) w/GMC 4.3L Eng. , 4300 Air Filter Secondary.....	A-5590	Fuel Filter Secondary.....	FC-55151
		GP45K (<i>FORKLIFTS</i>) w/Nissan TB45 (4.5L) Eng. , 4500		Oil Filter Full Flow.....	C-5505
				IT14G (<i>INTEGRATED TOOL-CARRIERS</i>) CAT 78J1-UP , 2011 Air Filter Set.....	A-56731-S
				Air Filter Primary.....	A-56731
				Air Filter Secondary.....	A-56741
				IT14G (<i>INTEGRATED TOOL-CARRIERS</i>) CAT 3054T , 1998 Cabin Air Filter.....	CA-55130
				IT14G (<i>INTEGRATED TOOL-CARRIERS</i>) CAT 3054 (S/N: 1WN01379-UP) Air Filter Set.....	A-5663-S
				Air Filter Primary.....	A-5627
				Hydraulic Oil Filter.....	HC-5504
				Oil Filter Full Flow.....	C-5102
				IT14G (<i>INTEGRATED TOOL-CARRIERS</i>) CAT 3054 (S/N: 1WN1-659) Air Filter Primary.....	A-5627
				Air Filter Set.....	A-5663-S
				Hydraulic Oil Filter.....	HC-5504
				Oil Filter Full Flow.....	C-5102
				IT14G (<i>INTEGRATED TOOL-CARRIERS</i>) CAT 3054 (S/N: 1WN660-1378) Air Filter Set.....	A-5663-S
				Air Filter Secondary.....	A-5540
				Air Filter Primary.....	A-5627

MODEL/APPLICATION	SAKURA NO
CATERPILLAR	
IT14G (INTEGRATED TOOL-CARRIERS) CAT 3054 (S/N: 1WN660-1378)	
Hydraulic Oil Filter.....	HC-5504
Oil Filter Full Flow.....	C-5102
IT14G (INTEGRATED TOOL-CARRIERS) CAT 3054 (S/N: 8ZM1-331)	
Air Filter Primary.....	A-5627
Air Filter Set.....	A-5663-S
Hydraulic Oil Filter.....	HC-5504
Oil Filter Full Flow.....	C-5102
IT14G (INTEGRATED TOOL-CARRIERS) CAT 3054 (S/N: 8ZM332-UP)	
Air Filter Set.....	A-5663-S
Air Filter Secondary.....	A-5540
Air Filter Primary.....	A-5627
Hydraulic Oil Filter.....	HC-5504
Oil Filter Full Flow.....	C-5102
IT14G (INTEGRATED TOOL-CARRIERS) CAT 3054C DIT (S/N: 1WN1-UP)	
Air Filter Primary.....	A-5627
Air Filter Set.....	A-5663-S
Fuel Filter.....	FS-5701
Oil Filter Full Flow.....	C-5504
IT14G (INTEGRATED TOOL-CARRIERS) CAT 3054C DIT (S/N: 1WN660-UP)	
Air Filter Secondary.....	A-5540
Air Filter Primary.....	A-76231
Air Filter Primary.....	A-5541M
Air Filter Primary.....	A-5541
Air Filter Set.....	A-5541M-S
Hydraulic Oil Filter.....	HC-5504
Oil Filter Full Flow.....	C-5102
IT14G (INTEGRATED TOOL-CARRIERS) CAT 3054C DIT (S/N: 8ZM1-UP)	
Air Filter Primary.....	A-5627
Air Filter Set.....	A-5663-S
Fuel Filter.....	FS-5701
Oil Filter Full Flow.....	C-5504
IT14G (INTEGRATED TOOL-CARRIERS) CAT 3054C DIT (S/N: 8ZM332-UP)	
Air Filter Primary.....	A-76231
Air Filter Set.....	A-5541M-S
Air Filter Secondary.....	A-5540
Air Filter Primary.....	A-5541M
Air Filter Primary.....	A-5541
Hydraulic Oil Filter.....	HC-5504
Oil Filter Full Flow.....	C-5102
IT18F (INTEGRATED TOOL-CARRIERS) CAT 3114 (S/N: 5E31-UP) , 2005-UP	
Air Filter Primary.....	A-5566
Air Filter Set.....	A-5568-S
Air Filter Secondary.....	A-5567
Cabin Air Filter.....	CA-55070
Fuel Filter Secondary.....	FC-5515
Fuel Filter.....	F-5505
Fuel Filter Secondary.....	FC-55151
Fuel Filter Secondary.....	FC-5507
Fuel Filter.....	FC-5516

MODEL/APPLICATION	SAKURA NO
CATERPILLAR	
Hydraulic Oil Filter..... HC-5504	
Hydraulic Oil Filter..... H-5506	
Oil Filter Full Flow..... C-5505	
IT18F (INTEGRATED TOOL-CARRIERS) CAT 3114 (S/N: 6ZF1-UP) , 2005-UP	
Air Filter Primary.....	A-5566
Air Filter Set.....	A-5568-S
Air Filter Secondary.....	A-5567
Cabin Air Filter.....	CA-55070
Fuel Filter Secondary.....	FC-5515
Fuel Filter Secondary.....	FC-55151
Fuel Filter Secondary.....	FC-5507
Fuel Filter.....	F-5505
Fuel Filter.....	FC-5516
Hydraulic Oil Filter.....	HC-5504
Hydraulic Oil Filter.....	H-5506
Oil Filter Full Flow.....	C-5505
IT18F (INTEGRATED TOOL-CARRIERS) CAT 3114 (S/N: 8GJ1-UP) , 2005-UP	
Air Filter Set.....	A-5568-S
Air Filter Primary.....	A-5566
Air Filter Secondary.....	A-5567
Cabin Air Filter.....	CA-55070
Fuel Filter Secondary.....	FC-5507
Fuel Filter.....	F-5505
Hydraulic Oil Filter.....	H-5506
IT18F (INTEGRATED TOOL-CARRIERS) S/N: 5E31-UP	
Air Filter Set.....	A-5568-S
Air Filter Primary.....	A-5566
Air Filter Secondary.....	A-5567
Fuel Filter Secondary.....	FC-5515
Fuel Filter Secondary.....	FC-55151
Fuel Filter.....	FC-5516
Hydraulic Oil Filter.....	HC-5508
Hydraulic Oil Filter.....	H-5506
Oil Filter Full Flow.....	C-5505
IT18F (INTEGRATED TOOL-CARRIERS) S/N: 6ZF1-UP	
Air Filter Primary.....	A-5566
Air Filter Secondary.....	A-5567
Air Filter Set.....	A-5568-S
Fuel Filter Secondary.....	FC-55151
Fuel Filter.....	FC-5516
Fuel Filter Secondary.....	FC-5515
Hydraulic Oil Filter.....	H-5506
Hydraulic Oil Filter.....	HC-5508
Oil Filter Full Flow.....	C-5505
IT12 (INTEGRATED TOOL-CARRIERS) S/N: 2YC1-UP	
Air Filter Primary.....	A-5542
Air Filter Secondary.....	A-5525
Air Filter Set.....	A-5542-S
Fuel Filter Secondary.....	FC-5507
Fuel Filter.....	F-5505
Fuel Filter.....	FC-5503
Hydraulic Oil Filter.....	H-5504
Hydraulic Oil Filter.....	H-55270
Oil Filter Full Flow.....	C-5519

MODEL/APPLICATION	SAKURA NO
CATERPILLAR	
IT12 (INTEGRATED TOOL-CARRIERS) S/N: 4NC1-UP	
Air Filter Primary.....	A-5542
Air Filter Set.....	A-5542-S
Air Filter Secondary.....	A-5525
Fuel Filter.....	FC-5503
Fuel Filter Secondary.....	FC-5507
Fuel Filter.....	F-5505
Hydraulic Oil Filter.....	H-55270
Hydraulic Oil Filter.....	H-5504
Oil Filter Full Flow.....	C-5519
IT12 (INTEGRATED TOOL-CARRIERS) w/3204 Eng.	
Air Filter Secondary.....	A-5590
IT12B (INTEGRATED TOOL-CARRIERS) S/N: 1KF1-819	
Oil Filter Full Flow.....	C-5505
IT12B (INTEGRATED TOOL-CARRIERS) S/N: 1KF1-UP	
Air Filter Primary.....	A-5627
Air Filter Secondary.....	A-6008
Air Filter Set.....	A-5663-S
Air Filter Set.....	A-5511-S
Air Filter Primary.....	A-5511
Cabin Air Filter.....	CA-5501
Fuel Filter.....	FC-5516
Fuel Filter.....	F-5505
Fuel Filter Secondary.....	FC-55151
Fuel Filter Secondary.....	FC-5515
Fuel Filter Secondary.....	FC-5507
Hydraulic Oil Filter.....	HC-5504
Hydraulic Oil Filter.....	H-5510
Oil Filter Full Flow.....	C-5505
IT14B (INTEGRATED TOOL-CARRIERS) CAT 3114 (S/N: 3NJ1-UP)	
Air Filter Set.....	A-5511-S
Air Filter Primary.....	A-5511
Cabin Air Filter.....	CA-5501
Fuel Filter Secondary.....	FC-5507
Fuel Filter.....	F-5505
Hydraulic Oil Filter.....	H-5510
Oil Filter Full Flow.....	C-5505
IT14B (INTEGRATED TOOL-CARRIERS) CAT 3114 (S/N: 9SF1-UP)	
Air Filter Set.....	A-5511-S
Air Filter Primary.....	A-5511
Cabin Air Filter.....	CA-5501
Fuel Filter Secondary.....	FC-5507
Hydraulic Oil Filter.....	H-5510
Oil Filter Full Flow.....	C-5505
IT14F (INTEGRATED TOOL-CARRIERS) S/N: 4EL1-UP	
Air Filter Set.....	A-5663-S
Air Filter Secondary.....	A-6008
Air Filter Primary.....	A-5627
Fuel Filter Secondary.....	FC-55151
Fuel Filter.....	F-5505
Fuel Filter Secondary.....	FC-5515

MODEL/APPLICATION	SAKURA NO
CATERPILLAR	
IT14F (INTEGRATED TOOL-CARRIERS) S/N: 4EL1-UP	
Fuel Filter.....	FC-5516
Hydraulic Oil Filter.....	HC-5504
Hydraulic Oil Filter.....	H-5510
Oil Filter Full Flow.....	C-5505
IT14G US (INTEGRATED TOOL-CARRIERS) CAT 3054 (S/N: 8ZM1-UP)	
Air Filter Set.....	A-5663-S
Air Filter Primary.....	A-5627
Fuel Filter.....	FS-5701
Hydraulic Oil Filter.....	HC-5504
Oil Filter Full Flow.....	C-5102
IT18 (INTEGRATED TOOL-CARRIERS) CAT 3204 (S/N: 7ZB1-UP) , 2005-UP	
Air Filter.....	A-5530
Air Filter Primary.....	A-5507
Air Filter Set.....	A-5507-S
Air Filter Set.....	A-55071-S
Fuel Filter Secondary.....	FC-5507
Fuel Filter.....	F-5505
Hydraulic Oil Filter.....	H-5506
Oil Filter Full Flow.....	C-5505
IT18 (INTEGRATED TOOL-CARRIERS) CAT 3204 (S/N: 9NB1-UP) , 2005-UP	
Air Filter Primary.....	A-5507
Air Filter Set.....	A-55071-S
Air Filter Set.....	A-5507-S
Air Filter.....	A-5530
Fuel Filter.....	F-5505
Fuel Filter Secondary.....	FC-5507
Hydraulic Oil Filter.....	H-5506
Oil Filter Full Flow.....	C-5505
IT18 (INTEGRATED TOOL-CARRIERS) CAT 3204 (S/N: 4ZD-UP)	
Air Filter Primary.....	A-5507
Air Filter Set.....	A-5507-S
Air Filter Set.....	A-55071-S
Air Filter.....	A-5530
Fuel Filter.....	F-5505
Fuel Filter Secondary.....	FC-5507
Hydraulic Oil Filter.....	H-5506
Oil Filter Full Flow.....	C-5505
IT18 (INTEGRATED TOOL-CARRIERS) S/N: 7ZB1-UP	
Air Filter Set.....	A-55071-S
Air Filter Primary.....	A-5566
Air Filter Secondary.....	A-5567
Air Filter Set.....	A-5507-S
Air Filter Set.....	A-55071-S
Air Filter Set.....	A-5568-S
Air Filter Secondary.....	A-5525
Fuel Filter.....	FC-5501
Fuel Filter Secondary.....	FC-5507
Fuel Filter.....	FC-5523
Hydraulic Oil Filter.....	H-5506
Oil Filter Full Flow.....	C-5505
IT18 (INTEGRATED TOOL-CARRIERS) S/N: 1DF-UP	
Air Filter Primary.....	A-5507
Air Filter Set.....	A-55071-S

MODEL/APPLICATION	SAKURA NO
CATERPILLAR	
IT18 (INTEGRATED TOOL-CARRIERS) S/N: 9NB1-9NB1	
Air Filter Primary.....	A-5507
Air Filter Set.....	A-5507-S
Air Filter Set.....	A-5568-S
Air Filter Set.....	A-55071-S
Air Filter Primary.....	A-5566
Air Filter.....	A-5530
Air Filter Secondary.....	A-5567
Fuel Filter Secondary.....	FC-5507
Hydraulic Oil Filter.....	H-5506
Oil Filter Full Flow.....	C-5505
IT18B (INTEGRATED TOOL-CARRIERS) CAT 3204 (S/N: 1DF1-UP) , 2005-UP	
Air Filter Primary.....	A-5507
Air Filter Set.....	A-55071-S
Air Filter Set.....	A-5507-S
Air Filter.....	A-5530
Fuel Filter Secondary.....	FC-5507
Fuel Filter.....	F-5505
Hydraulic Oil Filter.....	H-5506
Oil Filter Full Flow.....	C-5505
IT18B (INTEGRATED TOOL-CARRIERS) CAT 3204 (S/N: 2NJ340-UP) , 2005-UP	
Air Filter Set.....	A-5507-S
Air Filter Primary.....	A-5507
Air Filter.....	A-5530
Air Filter Set.....	A-55071-S
Fuel Filter.....	F-5505
Fuel Filter Secondary.....	FC-5507
Hydraulic Oil Filter.....	H-5506
Oil Filter Full Flow.....	C-5505
IT18B (INTEGRATED TOOL-CARRIERS) CAT 3204 (S/N: 4ZD1-UP)	
Air Filter Set.....	A-5507-S
Air Filter.....	A-5530
Air Filter Primary.....	A-5507
Air Filter Set.....	A-55071-S
Fuel Filter Secondary.....	FC-5507
Fuel Filter.....	F-5505
Hydraulic Oil Filter.....	H-5506
Oil Filter Full Flow.....	C-5505
IT18B (INTEGRATED TOOL-CARRIERS) S/N: 1DF1-UP	
Air Filter Primary.....	A-5507
Air Filter Secondary.....	A-5525
Air Filter Set.....	A-5507-S
Air Filter Primary.....	A-5566
Air Filter Set.....	A-55071-S
Air Filter Secondary.....	A-5567
Air Filter Set.....	A-5568-S
Air Filter Set.....	A-5507-S
Air Filter Set.....	A-5568-S
Fuel Filter.....	FC-5503
Hydraulic Oil Filter.....	H-5506
Oil Filter Full Flow.....	C-5505
IT18B (INTEGRATED TOOL-CARRIERS) S/N: 1DF-UP	
Air Filter Primary.....	A-5507
Air Filter Set.....	A-55071-S

MODEL/APPLICATION	SAKURA NO
CATERPILLAR	
Air Filter Secondary.....	A-5567
Air Filter Set.....	A-5507-S
Air Filter Set.....	A-5568-S
Air Filter.....	A-5530
Air Filter Primary.....	A-5566
Air Filter Secondary.....	A-5525
Fuel Filter.....	FC-5523
Fuel Filter.....	FC-5501
Fuel Filter Secondary.....	FC-5507
Hydraulic Oil Filter.....	H-5506
Oil Filter Full Flow.....	C-5505
IT18B (INTEGRATED TOOL-CARRIERS) S/N: 2NJ1-UP	
Air Filter Secondary.....	A-5567
Air Filter Primary.....	A-5566
Air Filter Set.....	A-5568-S
IT18B (INTEGRATED TOOL-CARRIERS) S/N: 2NJ340-UP	
Air Filter Primary.....	A-5507
Air Filter Set.....	A-55071-S
Air Filter.....	A-5530
Air Filter Set.....	A-5507-S
Fuel Filter.....	F-5505
Fuel Filter Secondary.....	FC-5507
Hydraulic Oil Filter.....	H-5506
Oil Filter Full Flow.....	C-5505
IT18B (INTEGRATED TOOL-CARRIERS) S/N: 2NS-UP	
Air Filter Set.....	A-55071-S
Air Filter Secondary.....	A-5525
Air Filter.....	A-5530
Air Filter Set.....	A-5507-S
Air Filter Set.....	A-5568-S
Air Filter Primary.....	A-5507
Air Filter Secondary.....	A-5567
Fuel Filter.....	FC-5523
Fuel Filter Secondary.....	FC-5507
Fuel Filter.....	FC-5501
Hydraulic Oil Filter.....	H-5506
Oil Filter Full Flow.....	C-5505
IT18B (INTEGRATED TOOL-CARRIERS) S/N: 4ZD-UP	
Air Filter Primary.....	A-5566
Air Filter.....	A-5530
Air Filter Secondary.....	A-5567
Air Filter Primary.....	A-5507
Air Filter Set.....	A-5507-S
Air Filter Set.....	A-55071-S
Air Filter Set.....	A-5568-S
Air Filter Secondary.....	A-5525
Fuel Filter.....	FC-5501
Fuel Filter Secondary.....	FC-5507
Fuel Filter.....	FC-5523
Hydraulic Oil Filter.....	H-5506
Oil Filter Full Flow.....	C-5505
IT28 (INTEGRATED TOOL-CARRIERS) CAT 3204 (S/N: 2KC1-UP) , 2005-UP	
Air Filter Set.....	A-55071-S

MODEL/APPLICATION	SAKURA NO
CATERPILLAR	
IT28 (INTEGRATED TOOL-CARRIERS) CAT 3204 (S/N: 2K1-UP) , 2005-UP	
Air Filter Set.....	A-5507-S
Air Filter.....	A-5530
Air Filter Primary.....	A-5507
Fuel Filter Secondary.....	FC-5507
Fuel Filter.....	F-5505
Hydraulic Oil Filter.....	H-5506
Oil Filter Full Flow.....	C-5505
IT28 (INTEGRATED TOOL-CARRIERS) CAT 3204 (S/N: 8J81-UP) , 2005-UP	
Air Filter Primary.....	A-5507
Air Filter Set.....	A-5507-S
Air Filter.....	A-5530
Air Filter Set.....	A-55071-S
Fuel Filter Secondary.....	FC-5507
Fuel Filter.....	F-5505
Hydraulic Oil Filter.....	H-5506
Oil Filter Full Flow.....	C-5505
IT28 (INTEGRATED TOOL-CARRIERS) S/N: 1HF1-UP	
Air Filter Set.....	A-55071-S
Air Filter Primary.....	A-5507
Air Filter Set.....	A-5507-S
Air Filter.....	A-5530
Fuel Filter.....	FC-5523
Fuel Filter.....	FC-5501
Hydraulic Oil Filter.....	H-5506
Oil Filter Full Flow.....	C-5505
IT28 (INTEGRATED TOOL-CARRIERS) S/N: 2K1-UP	
Air Filter Primary.....	A-5566
Air Filter.....	A-5530
Air Filter Primary.....	A-5507
Air Filter Set.....	A-5568-S
Air Filter Set.....	A-5507-S
Air Filter Set.....	A-55071-S
Air Filter Secondary.....	A-5567
Fuel Filter.....	FC-5523
Fuel Filter.....	FC-5501
Fuel Filter Secondary.....	FC-5507
Hydraulic Oil Filter.....	H-5506
Oil Filter Full Flow.....	C-5505
IT28 (INTEGRATED TOOL-CARRIERS) S/N: 5SD1-UP	
Air Filter Set.....	A-55071-S
Air Filter.....	A-5530
Air Filter Primary.....	A-5507
Air Filter Set.....	A-5507-S
Fuel Filter.....	FC-5523
Fuel Filter.....	FC-5501
Hydraulic Oil Filter.....	H-5506
Oil Filter Full Flow.....	C-5505
IT28 (INTEGRATED TOOL-CARRIERS) S/N: 8J81-UP	
Air Filter Primary.....	A-5566
Air Filter Set.....	A-5507-S
Air Filter Set.....	A-5568-S
Air Filter Secondary.....	A-5525

MODEL/APPLICATION	SAKURA NO
CATERPILLAR	
Air Filter Secondary.....	A-5567
Air Filter Primary.....	A-5507
Air Filter Set.....	A-55071-S
Fuel Filter.....	FC-5503
Oil Filter Full Flow.....	C-5505
IT28B (INTEGRATED TOOL-CARRIERS) CAT 3204 (S/N: 5SD1-UP)	
Air Filter.....	A-5530
Fuel Filter Secondary.....	FC-5507
Fuel Filter.....	F-5505
Hydraulic Oil Filter.....	H-5506
Oil Filter Full Flow.....	C-5505
IT28B (INTEGRATED TOOL-CARRIERS) CAT 3204 (S/N: 74V02305-UP)	
Air Filter Secondary.....	A-5508
Fuel Filter Secondary.....	FC-5507
Hydraulic Oil Filter.....	H-5504
Oil Filter Full Flow.....	C-5510
IT28B (INTEGRATED TOOL-CARRIERS) S/N: 1HF1-UP	
Air Filter Set.....	A-55071-S
Air Filter Primary.....	A-5507
Air Filter Secondary.....	A-5567
Air Filter Set.....	A-5507-S
Air Filter Set.....	A-5568-S
Air Filter.....	A-5530
Air Filter Primary.....	A-5566
Fuel Filter.....	FC-5523
Fuel Filter.....	FC-5501
Fuel Filter Secondary.....	FC-5507
Hydraulic Oil Filter.....	H-5506
Oil Filter Full Flow.....	C-5505
IT28B (INTEGRATED TOOL-CARRIERS) S/N: 1JK430-UP	
Air Filter.....	A-5530
Air Filter Set.....	A-5507-S
Air Filter Set.....	A-55071-S
Air Filter Primary.....	A-5507
Fuel Filter.....	F-5505
Fuel Filter Secondary.....	FC-5507
Hydraulic Oil Filter.....	H-5506
Oil Filter Full Flow.....	C-5505
IT28B (INTEGRATED TOOL-CARRIERS) S/N: 5SD1302-UP	
Air Filter Set.....	A-55071-S
Air Filter.....	A-5530
Air Filter Primary.....	A-5507
Air Filter Set.....	A-5507-S
Fuel Filter Secondary.....	FC-5507
Fuel Filter.....	F-5505
Hydraulic Oil Filter.....	H-5506
Oil Filter Full Flow.....	C-5505
IT28G (INTEGRATED TOOL-CARRIERS) CAT 3116 (S/N: 8CR1-UP) , 2005-UP	
Air Filter Secondary.....	A-5567
Air Filter Primary.....	A-5566
Air Filter Set.....	A-5568-S
Fuel Filter Secondary.....	FC-5515

MODEL/APPLICATION	SAKURA NO
CATERPILLAR	
Fuel Filter Secondary.....	FC-5515
Fuel Filter.....	FC-5516
Fuel Filter.....	FC-5508
Hydraulic Oil Filter.....	HC-5504
Oil Filter Full Flow.....	C-5510
IT28G (INTEGRATED TOOL-CARRIERS) CAT 3116 (S/N: 9A1-UP) , 2005-UP	
Air Filter Secondary.....	A-5567
Air Filter Set.....	A-5568-S
Air Filter Primary.....	A-5566
Fuel Filter Secondary.....	FC-5515
Fuel Filter Secondary.....	FC-55151
Fuel Filter.....	FC-5516
Hydraulic Oil Filter.....	HC-5504
Oil Filter Full Flow.....	C-5510
IT28G (INTEGRATED TOOL-CARRIERS) CAT 3116 (S/N: DBT1-UP) , 2005-UP	
Air Filter Primary.....	AS-8577
Air Filter Secondary.....	A-8578
Hydraulic Oil Filter.....	HC-5504
Oil Filter Full Flow.....	C-5510
IT28G (INTEGRATED TOOL-CARRIERS) CAT 3116 (S/N: WAC1-UP) , 2005-UP	
Air Filter Secondary.....	A-8578
Air Filter Primary.....	AS-8577
Hydraulic Oil Filter.....	HC-5504
Oil Filter Full Flow.....	C-5510
IT28G (INTEGRATED TOOL-CARRIERS) CAT 3116T , 1998	
Cabin Air Filter.....	CA-55130
IT28G (INTEGRATED TOOL-CARRIERS) CAT 3116	
Air Filter Primary.....	A-5566
Air Filter Set.....	A-5568-S
Air Filter Secondary.....	A-5567
Fuel Filter Secondary.....	FC-55151
Fuel Filter.....	FC-5508
Fuel Filter Secondary.....	FC-5515
Fuel Filter.....	FC-5516
Hydraulic Oil Filter.....	HC-5504
Oil Filter Full Flow.....	C-5510
IT28G (INTEGRATED TOOL-CARRIERS) CAT 3056E	
Air Filter Secondary.....	A-8578
Air Filter Primary.....	AS-8577
Fuel Filter.....	FC-5508
Fuel Filter.....	FC-5516
Fuel Filter Secondary.....	FC-5515
Fuel Filter Secondary.....	FC-55151
Hydraulic Oil Filter.....	HC-5504
Oil Filter Full Flow.....	C-5510
IT24F (INTEGRATED TOOL-CARRIERS) CAT 3114 (S/N: 4NN1-UP)	
Air Filter Set.....	A-5568-S
Air Filter Primary.....	A-5566
Air Filter Secondary.....	A-5567
Fuel Filter Secondary.....	FC-5515
Fuel Filter Secondary.....	FC-55151

MODEL/APPLICATION	SAKURA NO	MODEL/APPLICATION	SAKURA NO	MODEL/APPLICATION	SAKURA NO
CATERPILLAR		CATERPILLAR		CATERPILLAR	
IT24F <i>(INTEGRATED TOOL-CARRIERS)</i> CAT 3114 (S/N: 4NN1-UP)		Fuel Filter Secondary..... FC-5515 Fuel Filter..... FC-5516 Fuel Filter..... F-5505 Fuel Filter Secondary..... FC-55151 Hydraulic Oil Filter..... H-5506 Hydraulic Oil Filter..... H-5506 Oil Filter Full Flow..... C-5510 Oil Filter Full Flow..... C-5505		Fuel Filter..... FC-5516 Fuel Filter Secondary..... FC-5515 Fuel Filter Secondary..... FC-55151 Hydraulic Oil Filter..... HC-5508 Hydraulic Oil Filter..... H-5506 Oil Filter Full Flow..... C-5510	
IT24F <i>(INTEGRATED TOOL-CARRIERS)</i> CAT 3114 (S/N: 6KN1-UP)		IT28F <i>(INTEGRATED TOOL-CARRIERS)</i> CAT 3116 (S/N: 3CL1-1199) , 2005-UP		IT28G EN <i>(INTEGRATED TOOL-CARRIERS)</i> CAT 3056E (S/N: 9AR1-UP)	
Air Filter Set..... A-5568-S Air Filter Primary..... A-5566 Air Filter Secondary..... A-5567 Fuel Filter Secondary..... FC-5515 Fuel Filter Secondary..... FC-55151 Fuel Filter..... FC-5516 Hydraulic Oil Filter..... H-5506 Hydraulic Oil Filter..... HC-5504 Oil Filter Full Flow..... C-5510 Oil Filter Full Flow..... C-5505		Air Filter Secondary..... A-5567 Air Filter Primary..... A-5566 Air Filter Set..... A-5568-S Cabin Air Filter..... CA-55070 Fuel Filter Secondary..... FC-5515 Fuel Filter..... F-5505 Fuel Filter Secondary..... FC-55151 Fuel Filter..... FC-5516 Fuel Filter Secondary..... FC-55151 Fuel Filter..... FC-5516 Hydraulic Oil Filter..... H-5506 Hydraulic Oil Filter..... HC-5504 Hydraulic Oil Filter..... H-5506 Oil Filter Full Flow..... C-5510		Air Filter Secondary..... A-5567 Air Filter Primary..... A-5566 Air Filter Set..... A-5568-S Fuel Filter Secondary..... FC-55151 Fuel Filter..... F-5505 Fuel Filter Secondary..... FC-5515 Fuel Filter..... FC-5516 Hydraulic Oil Filter..... H-5506 Hydraulic Oil Filter..... HC-5504 Oil Filter Full Flow..... C-5505	
IT24F <i>(INTEGRATED TOOL-CARRIERS)</i> S/N: 4NN1-UP		IT28F <i>(INTEGRATED TOOL-CARRIERS)</i> CAT 3116 (S/N: 3CL1200-UP) , 2005-UP		IT28G US <i>(INTEGRATED TOOL-CARRIERS)</i> CAT 3056E (S/N: 8CR1-UP) , 2005-UP	
Air Filter Secondary..... A-5567 Air Filter Set..... A-5568-S Air Filter Primary..... A-5566 Fuel Filter..... FC-5516 Fuel Filter Secondary..... FC-55151 Fuel Filter Secondary..... FC-5515 Hydraulic Oil Filter..... HC-5508 Hydraulic Oil Filter..... H-5506 Oil Filter Full Flow..... C-5505		Air Filter Primary..... A-5566 Air Filter Set..... A-5568-S Air Filter Secondary..... A-5567 Cabin Air Filter..... CA-55070 Fuel Filter Secondary..... FC-55151 Fuel Filter..... FC-5516 Fuel Filter Secondary..... FC-5515 Fuel Filter..... H-5506 Hydraulic Oil Filter..... HC-5504 Hydraulic Oil Filter..... H-5506 Oil Filter Full Flow..... C-5510		Air Filter Primary..... A-5566 Air Filter Secondary..... A-5567 Air Filter Set..... A-5568-S Fuel Filter..... F-5505 Fuel Filter Secondary..... FC-5515 Fuel Filter Secondary..... FC-55151 Fuel Filter..... FC-5516 Hydraulic Oil Filter..... HC-5504 Hydraulic Oil Filter..... H-5506 Oil Filter Full Flow..... C-5505	
IT24F <i>(INTEGRATED TOOL-CARRIERS)</i> S/N: 6KN1-UP		IT28F <i>(INTEGRATED TOOL-CARRIERS)</i> S/N: 1JL1-UP		IT38F <i>(INTEGRATED TOOL-CARRIERS)</i> CAT 3116 (S/N: 5DR1-270) , 2005-UP	
Air Filter Secondary..... A-5567 Fuel Filter..... FC-5516 Fuel Filter Secondary..... FC-55151 Fuel Filter Secondary..... FC-5515 Hydraulic Oil Filter..... HC-5508 Hydraulic Oil Filter..... H-5506 Oil Filter Full Flow..... C-5505		Air Filter Primary..... A-5566 Air Filter Set..... A-5568-S Air Filter Secondary..... A-5567 Cabin Air Filter..... CA-55070 Fuel Filter Secondary..... FC-5515 Fuel Filter..... F-5505 Fuel Filter..... FC-5516 Fuel Filter Secondary..... FC-55151 Fuel Filter..... H-5506 Hydraulic Oil Filter..... HC-5504 Hydraulic Oil Filter..... H-5506 Oil Filter Full Flow..... C-5510		Air Filter Secondary..... A-5550 Air Filter Primary..... A-5549 Air Filter Primary..... A-5549M Air Filter Set..... A-5549M-S Fuel Filter..... F-5505 Fuel Filter Secondary..... FC-55151 Fuel Filter..... FC-5516 Fuel Filter Secondary..... FC-5515 Fuel Filter Secondary..... HC-5504 Hydraulic Oil Filter..... H-5506 Oil Filter Full Flow..... C-5510	
IT24F UK <i>(INTEGRATED TOOL-CARRIERS)</i> CAT 3056E (S/N: 6KN1-UP) , 2005-UP		IT28F <i>(INTEGRATED TOOL-CARRIERS)</i> S/N: 3CL1200-UP		IT38F <i>(INTEGRATED TOOL-CARRIERS)</i> CAT 3116 (S/N: 5DR271-UP) , 2005-UP	
Air Filter Primary..... A-5566 Air Filter Set..... A-5568-S Air Filter Secondary..... A-5567 Cabin Air Filter..... CA-55070 Fuel Filter Secondary..... FC-5515 Fuel Filter..... F-5505 Fuel Filter..... FC-5516 Fuel Filter Secondary..... FC-55151 Hydraulic Oil Filter..... HC-5504 Hydraulic Oil Filter..... H-5506 Oil Filter Full Flow..... C-5505		Air Filter Secondary..... A-5567 Air Filter Primary..... A-5566 Air Filter Set..... A-5568-S Fuel Filter..... FC-5516 Fuel Filter Secondary..... FC-5515 Fuel Filter Secondary..... FC-55151 Fuel Filter..... H-5506 Hydraulic Oil Filter..... HC-5504 Hydraulic Oil Filter..... H-5506 Oil Filter Full Flow..... C-5510		Air Filter Primary..... A-5549 Air Filter Secondary..... A-5550 Air Filter Primary..... A-5549M Air Filter Set..... A-5549M-S Fuel Filter Secondary..... FC-5515 Fuel Filter Secondary..... FC-55151 Fuel Filter..... FC-5508 Fuel Filter..... FC-5516 Hydraulic Oil Filter..... H-5506 Hydraulic Oil Filter..... HC-5504 Oil Filter Full Flow..... C-5510	
IT28F <i>(INTEGRATED TOOL-CARRIERS)</i> CAT 3116 (S/N: 1JL1-UP) , 2005-UP		IT28F <i>(INTEGRATED TOOL-CARRIERS)</i> S/N: 3CL1-UP		IT38F <i>(INTEGRATED TOOL-CARRIERS)</i> CAT 3116 (S/N: 6FN1-UP) , 2005-UP	
Air Filter Primary..... A-5566 Air Filter Secondary..... A-5567 Air Filter Set..... A-5568-S Cabin Air Filter..... CA-55070		Air Filter Set..... A-5568-S Air Filter Primary..... A-5566 Air Filter Secondary..... A-5567		Air Filter Set..... A-5549M-S	

MODEL/APPLICATION	SAKURA NO
-------------------	-----------

CATERPILLAR

IT38F
(INTEGRATED TOOL-CARRIERS)
CAT 3116 (S/N: 6FN1-UP) , 2005-UP

Air Filter Primary.....	A-5549M
Air Filter Primary.....	A-5549
Air Filter Secondary.....	A-5550
Fuel Filter.....	FC-5516
Fuel Filter Secondary.....	FC-5515
Fuel Filter Secondary.....	FC-55151
Fuel Filter.....	F-5505
Fuel Filter.....	FC-5508
Hydraulic Oil Filter.....	H-5506
Hydraulic Oil Filter.....	HC-5504
Oil Filter Full Flow.....	C-5510

IT38F
(INTEGRATED TOOL-CARRIERS)
S/N: 6NF1-UP

Air Filter Secondary.....	A-5550
Air Filter Primary.....	A-5549
Air Filter Primary.....	A-5549M
Air Filter Set.....	A-5549M-S
Fuel Filter Secondary.....	FC-55151
Fuel Filter.....	FC-5516
Fuel Filter Secondary.....	FC-5515
Hydraulic Oil Filter.....	HC-5508
Hydraulic Oil Filter.....	H-5506
Oil Filter Full Flow.....	C-5510

IT38G
(INTEGRATED TOOL-CARRIERS)
CAT 3126 (S/N: 1CW1-328) , 2005-UP

Air Filter Secondary.....	A-5550
Fuel Filter.....	FC-5516
Fuel Filter.....	FC-5508
Fuel Filter Secondary.....	FC-55151
Fuel Filter Secondary.....	FC-5515
Hydraulic Oil Filter.....	H-5506
Hydraulic Oil Filter.....	HC-5504
Oil Filter Full Flow.....	C-5510

IT38G
(INTEGRATED TOOL-CARRIERS)
CAT 3126 (S/N: 1CW329-UP) , 2005-UP

Air Filter Secondary.....	A-5550
Fuel Filter.....	FC-5508
Fuel Filter.....	FC-5516
Fuel Filter Secondary.....	FC-55151
Fuel Filter Secondary.....	FC-5515
Hydraulic Oil Filter.....	H-5506
Hydraulic Oil Filter.....	HC-5504
Oil Filter Full Flow.....	C-5510

IT38G
(INTEGRATED TOOL-CARRIERS)
CAT 3126 (S/N: 7B51-UP) , 2005-UP

Air Filter Primary.....	A-5549M
Air Filter Set.....	A-5549M-S
Air Filter Primary.....	A-5549
Air Filter Secondary.....	A-5550
Fuel Filter.....	FC-5508
Fuel Filter Secondary.....	FC-55151
Fuel Filter Secondary.....	FC-5515
Fuel Filter.....	FC-5516
Hydraulic Oil Filter.....	HC-5504
Hydraulic Oil Filter.....	H-5506
Oil Filter Full Flow.....	C-5510

MODEL/APPLICATION	SAKURA NO
-------------------	-----------

CATERPILLAR

IT38G
(INTEGRATED TOOL-CARRIERS)
CAT 3126 (S/N: CSX1-UP) , 2005-UP

Air Filter Primary.....	A-5558
Air Filter Secondary.....	A-5559
Fuel Filter.....	FC-5517
Hydraulic Oil Filter.....	HC-5504
Hydraulic Oil Filter.....	H-5506
Oil Filter Full Flow.....	C-5510

IT38G
(INTEGRATED TOOL-CARRIERS)
CAT 3126

Cabin Air Filter.....	CA-55130
-----------------------	----------

IT38G
(INTEGRATED TOOL-CARRIERS)

Air Filter Primary.....	A-5549
Air Filter Set.....	A-5549M-S
Air Filter Secondary.....	A-5550
Air Filter Primary.....	A-5549M
Fuel Filter Secondary.....	FC-55151
Fuel Filter.....	FC-5508
Fuel Filter.....	FC-5516
Fuel Filter Secondary.....	FC-5515
Hydraulic Oil Filter.....	HC-5508
Oil Filter Full Flow.....	C-5510

IT38G
(INTEGRATED TOOL-CARRIERS)
S/N: 1CW329-UP

Air Filter Secondary.....	A-5550
Fuel Filter.....	FC-5508
Fuel Filter.....	FC-5516
Fuel Filter Secondary.....	FC-55151
Fuel Filter Secondary.....	FC-5515
Hydraulic Oil Filter.....	HC-5504
Hydraulic Oil Filter.....	H-5506
Oil Filter Full Flow.....	C-5510

IT38G
(INTEGRATED TOOL-CARRIERS)
S/N: 7B51-UP

Air Filter Primary.....	A-5549M
Air Filter Secondary.....	A-5550
Air Filter Set.....	A-5549M-S
Air Filter Primary.....	A-5549
Fuel Filter.....	FC-5516
Fuel Filter.....	FC-5508
Fuel Filter Secondary.....	FC-5515
Fuel Filter Secondary.....	FC-55151
Hydraulic Oil Filter.....	H-5506
Hydraulic Oil Filter.....	HC-5504
Oil Filter Full Flow.....	C-5510

IT38G II
(INTEGRATED TOOL-CARRIERS)
CAT (S/N: 5GG1-UP)

Fuel Filter.....	FC-5517
Oil Filter Full Flow.....	C-5522

IT38G II
(INTEGRATED TOOL-CARRIERS)
CAT (S/N: BMA28000-UP)

Fuel Filter.....	FC-5517
Oil Filter Full Flow.....	C-5522

IT38G II
(INTEGRATED TOOL-CARRIERS)
S/N: CSX1-UP

Air Filter Secondary.....	A-5559
---------------------------	--------

MODEL/APPLICATION	SAKURA NO
-------------------	-----------

CATERPILLAR

Air Filter Primary.....	A-5558
Hydraulic Oil Filter.....	HC-5504
Hydraulic Oil Filter.....	H-5506

IT38G II
(INTEGRATED TOOL-CARRIERS)
S/N: JAN1-UP

Air Filter Primary.....	A-5558
Air Filter Secondary.....	A-5559
Hydraulic Oil Filter.....	HC-5504
Hydraulic Oil Filter.....	H-5506

IT38H
(INTEGRATED TOOL-CARRIERS)
CAT 6.6 ACERT

Fuel/Water Separator.....	SFC-55240
---------------------------	-----------

IT38H
(INTEGRATED TOOL-CARRIERS)
CAT C6.6 with ACERT Technology

Cabin Air Filter.....	CA-55130
-----------------------	----------

IT38H
(INTEGRATED TOOL-CARRIERS)
w/C6.6 Eng.

Hydraulic Oil Filter.....	HC-55280
---------------------------	----------

IT62G
(INTEGRATED TOOL-CARRIERS)
CAT 3126 (S/N: 6PS1-UP) , 2005-UP

Air Filter.....	A-5584
Air Filter Secondary.....	A-5550
Air Filter.....	A-25460
Fuel Filter Secondary.....	FC-5515
Fuel Filter.....	FC-5508
Fuel Filter.....	FC-5516
Fuel Filter Secondary.....	FC-55151
Hydraulic Oil Filter.....	HC-5504
Oil Filter Full Flow.....	C-5510

IT62G
(INTEGRATED TOOL-CARRIERS)
CAT 3126 (S/N: AKP1-UP) , 2005-UP

Air Filter Secondary.....	A-5550
Air Filter.....	A-5584
Fuel Filter.....	FC-5516
Fuel Filter Secondary.....	FC-5515
Fuel Filter Secondary.....	FC-5507
Fuel Filter Secondary.....	FC-55151
Fuel Filter.....	FC-5508
Fuel Filter.....	F-5505
Hydraulic Oil Filter.....	HC-5504
Oil Filter Full Flow.....	C-5510

IT62G
(INTEGRATED TOOL-CARRIERS)
CAT 3126 (S/N: AYA1-UP) , 2005-UP

Air Filter Primary.....	A-5558
Air Filter Secondary.....	A-5559
Cabin Air Filter.....	CA-55070
Fuel Filter.....	FC-5517
Hydraulic Oil Filter.....	HC-5504
Oil Filter Full Flow.....	C-5510

IT62G
(INTEGRATED TOOL-CARRIERS)
S/N: 6PS1-UP

Air Filter Secondary.....	A-5550
Fuel Filter Secondary.....	FC-5515
Fuel Filter Secondary.....	FC-55151
Fuel Filter.....	FC-5508
Fuel Filter.....	FC-5516
Hydraulic Oil Filter.....	HC-5504
Oil Filter Full Flow.....	C-5510

Sakura Filter

ENGINE APPLICATION

MODEL/APPLICATION	SAKURA NO	MODEL/APPLICATION	SAKURA NO	MODEL/APPLICATION	SAKURA NO
CATERPILLAR		CATERPILLAR		CATERPILLAR	
IT62G (INTEGRATED TOOL-CARRIERS) S/N: AKP1-UP		Air Filter Primary.....	A-5509	M315C (EXCAVATORS) w/3054, 3054E Engs.	
Air Filter Secondary.....	A-5550	Air Filter Secondary.....	A-5522	Fuel/Water Separator.....	SFC-43040
Fuel Filter Secondary.....	FC-5515	Fuel Filter.....	FC-5519	M315D (EXCAVATORS) CAT (S/N: C4E1-1-UP)	
Fuel Filter.....	FC-5508	LEXION 480 (COMBINES HARVESTERS) CAT C12		Oil Filter Full Flow.....	C-5102
Fuel Filter Secondary.....	FC-55151	Fuel Filter.....	FC-5517	M315D (EXCAVATORS) CAT (S/N: C4E2-UP)	
Fuel Filter.....	FC-5516	LEXION 410 (TRACTORS) CAT 3126B		Oil Filter Full Flow.....	C-5102
Hydraulic Oil Filter.....	HC-5504	Fuel Filter.....	FC-5517	M315D (EXCAVATORS) CAT C4.4 ACERT	
Oil Filter Full Flow.....	C-5510	Oil Filter Full Flow.....	C-5510	Fuel/Water Separator.....	SFC-55241
IT62G II (INTEGRATED TOOL-CARRIERS) CAT (S/N: AYA1-UP)		M312 (EXCAVATORS) CAT 3054 (S/N: 6TL1-UP)		Fuel/Water Separator.....	SFC-55240
Air Filter Secondary.....	A-5559	Air Filter Secondary.....	A-5540	M315D (EXCAVATORS) S/N: W5M1-UP	
Air Filter Primary.....	A-5558	Oil Filter Full Flow.....	C-5102	Cabin Air Filter.....	CA-55850
Cabin Air Filter.....	CA-55070	M313C (EXCAVATORS) w/3054, 3054E Engs.		M316C (EXCAVATORS) CAT 3056 (S/N: BDX1-09999-UP) , 2002-UP	
Fuel Filter.....	FC-5517	Fuel/Water Separator.....	SFC-43040	Air Filter Primary.....	A-5105
Hydraulic Oil Filter.....	HC-5504	M313D (EXCAVATORS) CAT (S/N: C4E1-UP)		Air Filter Secondary.....	A-5106
Oil Filter Full Flow.....	C-5522	Oil Filter Full Flow.....	C-5102	Cabin Air Filter.....	CA-55850
IT62H (INTEGRATED TOOL-CARRIERS) CAT S/N: C7C1-UP		M313D (EXCAVATORS) CAT (S/N: C4E2-UP)		M316C (EXCAVATORS) CAT 3056 (S/N: BDX1-UP)	
Cabin Air Filter.....	CA-55070	Oil Filter Full Flow.....	C-5102	Air Filter Secondary.....	A-5106
Fuel Filter.....	FC-5517	M313D (EXCAVATORS) CAT S/N: W3H1-UP		Air Filter Primary.....	A-5105
Hydraulic Oil Filter.....	HC-5504	Cabin Air Filter.....	CA-55850	Cabin Air Filter.....	CA-55850
Oil Filter Full Flow.....	C-5522	M315 (EXCAVATORS) CAT 3054 (S/N: 7ML1-UP)		M316D (EXCAVATORS) CAT S/N: C6E1-UP	
IT62H (INTEGRATED TOOL-CARRIERS) CAT S/N: M5G1-UP		Air Filter Secondary.....	A-5540	Cabin Air Filter.....	CA-55850
Cabin Air Filter.....	CA-55070	Oil Filter Full Flow.....	C-5102	Fuel Filter.....	FC-5516
Fuel Filter.....	FC-5517	M313D (EXCAVATORS) CAT C4.4 ACERT		Fuel Filter Secondary.....	FC-55151
Hydraulic Oil Filter.....	HC-5504	Fuel/Water Separator.....	SFC-55240	Fuel Filter Secondary.....	FC-5515
Oil Filter Full Flow.....	C-5522	Fuel/Water Separator.....	SFC-55241	M316D (EXCAVATORS) CAT S/N: W6A1-UP	
IT62H (INTEGRATED TOOL-CARRIERS) w/C7 Eng.		M313D (EXCAVATORS) S/N: W3H1-UP		Cabin Air Filter.....	CA-55850
Hydraulic Oil Filter.....	HC-55280	Cabin Air Filter.....	CA-55850	Fuel Filter.....	FC-5516
LEXION 450 (TRACTORS) CAT 3126		M315 (EXCAVATORS) S/N: 7ML01824-UP		Fuel Filter Secondary.....	FC-55151
Fuel Filter Secondary.....	FC-55151	Air Filter Primary.....	A-5541M	Fuel Filter Secondary.....	FC-55151
Fuel Filter Secondary.....	FC-5515	Air Filter Primary.....	A-5541	Fuel Filter.....	FC-5516
Fuel Filter.....	FC-5516	Air Filter Primary.....	A-76231	M316D (EXCAVATORS) CAT C6.6 ACERT	
Fuel/Water Separator Secondary..	SFC-5504-10B	Air Filter Secondary.....	A-5540	Fuel/Water Separator.....	SFC-55241
Fuel/Water Separator Secondary..	SFC-5504-10	Air Filter Set.....	A-5541M-S	Fuel/Water Separator.....	SFC-55240
Oil Filter Full Flow.....	C-5510	Oil Filter Full Flow.....	C-5102	M318 (EXCAVATORS) CAT 3054 (S/N: 8AL1-UP)	
LEXION 460 (COMBINES HARVESTERS) CAT 3126		M315 (EXCAVATORS) S/N: 7ML860-UP		Air Filter Secondary.....	A-7913
Fuel Filter Secondary.....	FC-5515	Air Filter Set.....	A-5541M-S	Air Filter Primary.....	A-5523
Fuel Filter Secondary.....	FC-55151	Air Filter Primary.....	A-5541M	Air Filter Primary.....	AS-5523
Fuel Filter.....	FC-5516	Air Filter Primary.....	A-76231	Fuel Filter.....	FC-5516
Oil Filter Full Flow.....	C-5510	Air Filter Primary.....	A-5541	Fuel Filter Secondary.....	FC-55151
LEXION 460 (COMBINES HARVESTERS) CAT C9		Air Filter Secondary.....	A-5540	Fuel Filter.....	F-5505
Fuel Filter.....	FC-5517	Oil Filter Full Flow.....	C-5102	Fuel Filter Secondary.....	FC-5515
LEXION 475R (TRACTORS) CAT C9		M315C (EXCAVATORS) CAT 3054 (S/N: BDM1-UP) , 2004-UP		Oil Filter Full Flow.....	C-5510
Fuel/Water Separator Secondary..	SFC-5504-10	Air Filter Primary.....	A-5105	M318 (EXCAVATORS) CAT 3116 (S/N: 6ES1-UP)	
Fuel/Water Separator Secondary..	SFC-5504-10B	Air Filter Secondary.....	A-5106	Air Filter Secondary.....	A-7913
Oil Filter Full Flow.....	C-5516	Cabin Air Filter.....	CA-55850	Air Filter Primary.....	AS-5523
LEXION 480 (COMBINES HARVESTERS) CAT 3176		M315C (EXCAVATORS) S/N: 7ML860-UP		Fuel Filter.....	FC-5516
Air Filter Set.....	A-5522-S	Air Filter Set.....	A-5541M-S	Fuel Filter Secondary.....	FC-55151

Sakura Filter

ENGINE APPLICATION

MODEL/APPLICATION	SAKURA NO	MODEL/APPLICATION	SAKURA NO	MODEL/APPLICATION	SAKURA NO
CATERPILLAR		CATERPILLAR		CATERPILLAR	
M318 (EXCAVATORS) CAT 3116 (S/N: 6ES1-UP)	Fuel Filter..... F-5505 Fuel Filter Secondary..... FC-5515 Fuel Filter..... FC-5516 Fuel Filter Secondary..... FC-55151 Oil Filter Full Flow..... C-5510	M318D (EXCAVATORS) CAT S/N: W8P1-UP Cabin Air Filter..... CA-55850 Fuel Filter..... FC-5516 Fuel Filter Secondary..... FC-55151 Fuel Filter Secondary..... FC-5515		Air Filter Secondary..... A-7913 Fuel Filter Secondary..... FC-55151 Fuel Filter Secondary..... FC-5515 Fuel Filter..... FC-5516 Oil Filter Full Flow..... C-5510	
M318 (EXCAVATORS) CAT 3116 (S/N: 8AL1020-UP)	Air Filter Secondary..... A-7913 Air Filter Primary..... AS-5523 Fuel Filter Secondary..... FC-55151 Fuel Filter Secondary..... FC-5515 Fuel Filter..... FC-5516 Fuel Filter..... F-5505 Oil Filter Full Flow..... C-5510	M318D (EXCAVATORS) CAT S/N: W8R1-UP Cabin Air Filter..... CA-55850 Fuel Filter Secondary..... FC-55151 Fuel Filter..... FC-5516 Fuel Filter Secondary..... FC-5515		M318F (EXCAVATORS) CAT C7.1 Fuel Filter..... EF-55050	
M318 (EXCAVATORS) CAT 3116 (S/N: 8AL1-1019-UP)	Air Filter Primary..... AS-5523 Air Filter Secondary..... A-7913 Fuel Filter..... FC-5516 Fuel Filter Secondary..... FC-5515 Fuel Filter Secondary..... FC-55151 Fuel Filter..... F-5505 Oil Filter Full Flow..... C-5510	M318D (EXCAVATORS) CAT 6.6 ACERT Fuel/Water Separator..... SFC-55240		M320 (EXCAVATORS) CAT 3116 (S/N: 6WL1-UP) Air Filter Primary..... AS-5523 Air Filter Secondary..... A-7913 Fuel Filter Secondary..... FC-55151 Fuel Filter Secondary..... FC-5515 Fuel Filter..... FC-5516 Oil Filter Full Flow..... C-5510	
M318 (EXCAVATORS) CAT 3116 (S/N: 8AL1-1019-UP)	Air Filter Primary..... AS-5523 Air Filter Secondary..... A-7913 Fuel Filter..... FC-5516 Fuel Filter Secondary..... FC-5515 Fuel Filter Secondary..... FC-55151 Fuel Filter..... F-5505 Oil Filter Full Flow..... C-5510	M318D (EXCAVATORS) CAT C6.6 ACERT Fuel/Water Separator..... SFC-55241		M320 (EXCAVATORS) CAT 3116 (S/N: 9PS1-UP) Air Filter Primary..... AS-5523 Air Filter Secondary..... A-7913 Fuel Filter Secondary..... FC-5515 Fuel Filter Secondary..... FC-55151 Fuel Filter..... FC-5516 Oil Filter Full Flow..... C-5510	
M318 (EXCAVATORS) CAT 3116 (S/N: 85S1-UP)	Air Filter Primary..... AS-5523 Air Filter Secondary..... A-7913 Fuel Filter Secondary..... FC-55151 Fuel Filter Secondary..... FC-5515 Fuel Filter..... FC-5516 Oil Filter Full Flow..... C-5510	M318D MH (EXCAVATORS) CAT C6.6 ACERT Fuel/Water Separator..... SFC-55241 Fuel/Water Separator..... SFC-55240		M322C (EXCAVATORS) CAT 3056 (S/N: BDK1-09999-UP) , 2004-UP Air Filter Secondary..... A-5106 Air Filter Primary..... A-5105 Cabin Air Filter..... CA-55850	
M318C (EXCAVATORS) CAT 3056 (S/N: BCZ1-09999-UP) , 2004-UP	Air Filter Primary..... A-5105 Air Filter Secondary..... A-5106 Cabin Air Filter..... CA-55850	M318 HDU (EXCAVATORS) CAT 3054 (S/N: 6ES1-UP) Air Filter Secondary..... A-7913 Air Filter Primary..... AS-5523 Fuel Filter Secondary..... FC-5515 Fuel Filter..... FC-5516 Fuel Filter Secondary..... FC-55151 Oil Filter Full Flow..... C-5510		M322C MH (MATERIAL HANDLERS) CAT 3056 (S/N: BDY1-UP) Air Filter Primary..... A-5105 Air Filter Secondary..... A-5106 Cabin Air Filter..... CA-55850	
M318C (EXCAVATORS) CAT 3056 (S/N: BCZ1-UP) , 2004-UP	Air Filter Primary..... A-5105 Air Filter Secondary..... A-5106 Cabin Air Filter..... CA-55850	M318 HDU (EXCAVATORS) CAT 3054 (S/N: 8AL1-UP) Air Filter Primary..... AS-5523 Air Filter Secondary..... A-7913 Fuel Filter Secondary..... FC-55151 Fuel Filter Secondary..... FC-5515 Fuel Filter..... FC-5516 Oil Filter Full Flow..... C-5510		M322D (EXCAVATORS) CAT S/N: C6E1-UP Cabin Air Filter..... CA-55850 Fuel Filter Secondary..... FC-5515 Fuel Filter Secondary..... FC-55151 Fuel Filter..... FC-5516	
M318C MH (MATERIAL HANDLERS) CAT 3054 (S/N: BEB1-UP)	Air Filter Secondary..... A-5106 Air Filter Primary..... A-5105 Cabin Air Filter..... CA-55850	M318 HDU (EXCAVATORS) CAT 3054 (S/N: 85S1-UP) Air Filter Secondary..... A-7913 Air Filter Primary..... AS-5523 Fuel Filter Secondary..... FC-55151 Fuel Filter Secondary..... FC-5515 Fuel Filter..... FC-5516 Oil Filter Full Flow..... C-5510		M322D (EXCAVATORS) CAT S/N: W2S1-UP Cabin Air Filter..... CA-55850 Fuel Filter Secondary..... FC-55151 Fuel Filter Secondary..... FC-5515 Fuel Filter..... FC-5516	
M318D (EXCAVATORS) 2007-UP	Oil Filter Full Flow..... C-5102	M318 STD (EXCAVATORS) CAT 3054 (S/N: 8AL1-UP) Air Filter Secondary..... A-7913 Air Filter Primary..... AS-5523 Fuel Filter Secondary..... FC-5515 Fuel Filter Secondary..... FC-55151 Fuel Filter..... FC-5516 Oil Filter Full Flow..... C-5510		M322D (EXCAVATORS) CAT S/N: W2T1-UP Cabin Air Filter..... CA-55850 Fuel Filter..... FC-5516 Fuel Filter Secondary..... FC-55151 Fuel Filter Secondary..... FC-5515	
M318D (EXCAVATORS) CAT S/N: C6E1-UP	Cabin Air Filter..... CA-55850 Fuel Filter..... FC-5516 Fuel Filter Secondary..... FC-5515 Fuel Filter Secondary..... FC-55151	M318 STD (EXCAVATORS) CAT 3054 (S/N: 85S1-UP) Air Filter Primary..... AS-5523		M322D (EXCAVATORS) CAT C6.6 ACERT Fuel/Water Separator..... SFC-55240 Fuel/Water Separator..... SFC-55241	

MODEL/APPLICATION	SAKURA NO	MODEL/APPLICATION	SAKURA NO	MODEL/APPLICATION	SAKURA NO
CATERPILLAR		CATERPILLAR		CATERPILLAR	
M322D MH (EXCAVATORS) CAT C6.6 ACERT		Hydraulic Oil Filter.....	H-5522	MH3022 (MATERIAL HANDLERS) CAT C7.1	
Fuel/Water Separator.....	SFC-55241	M325D (EXCAVATORS) S/N: KAE1-UP		Fuel Filter.....	EF-55050
Fuel/Water Separator.....	SFC-55240	Air Filter Secondary.....	A-5559	MH3024 (MATERIAL HANDLERS) CAT C7.1	
M325C (EXCAVATORS) CAT S/N: BMA1-UP		Air Filter Primary.....	A-5558	Fuel Filter.....	EF-55050
Air Filter Primary.....	A-5558	Cabin Air Filter.....	CA-55850	MH3026 (MATERIAL HANDLERS) CAT C7.1	
Air Filter Secondary.....	A-5559	Hydraulic Oil Filter.....	HC-5801	Fuel Filter.....	EF-55050
Cabin Air Filter.....	CA-55850	Hydraulic Oil Filter.....	H-5522	MH3037 (MATERIAL HANDLERS) CAT C7	
Fuel Filter.....	FC-5517	M325D (EXCAVATORS) S/N: KAY1-UP		Fuel Filter.....	EF-55050
Hydraulic Oil Filter.....	H-5522	Air Filter Secondary.....	A-5559	MW500 (ARTICULATED TRUCKS) CAT 3408E	
Hydraulic Oil Filter.....	HC-55170	Air Filter Primary.....	A-5558	Hydraulic Oil Filter.....	H-71190-08
Hydraulic Oil Filter.....	HC-5801	Cabin Air Filter.....	CA-55850	PF-290B (COMPACTORS) CAT 7BJ1-UP , 2011	
Hydraulic Oil Filter.....	H-7942	Hydraulic Oil Filter.....	HC-5801	Air Filter Primary.....	A-56731
Oil Filter Full Flow.....	C-5522	Hydraulic Oil Filter.....	H-5522	Air Filter Set.....	A-56731-S
M325C (EXCAVATORS) CAT S/N: PAN1-UP		Hydraulic Oil Filter.....	HC-5801	Air Filter Secondary.....	A-56741
Air Filter Secondary.....	A-5559	M325D (EXCAVATORS) S/N: KGG1-UP		PF-290B (COMPACTORS) CAT 3054	
Air Filter Primary.....	A-5558	Air Filter Primary.....	A-5558	Air Filter Secondary.....	A-5540
Cabin Air Filter.....	CA-55850	Air Filter Secondary.....	A-5559	Hydraulic Oil Filter.....	HC-5504
Fuel Filter.....	FC-5517	Cabin Air Filter.....	CA-55850	PF-300B (COMPACTORS) CAT 7BJ1-UP , 2011	
Hydraulic Oil Filter.....	H-7942	Hydraulic Oil Filter.....	H-5522	Air Filter Secondary.....	A-56741
Hydraulic Oil Filter.....	HC-55170	Hydraulic Oil Filter.....	HC-5801	Air Filter Set.....	A-56731-S
Hydraulic Oil Filter.....	H-5522	M325D (EXCAVATORS) S/N: KGG212-UP		Air Filter Primary.....	A-56731
Hydraulic Oil Filter.....	H-7942	Air Filter Secondary.....	A-5559	PF-300B (COMPACTORS) CAT (S/N: 5HK24000-UP)	
Hydraulic Oil Filter.....	HC-5801	Air Filter Primary.....	A-5558	Oil Filter Full Flow.....	C-5102
Oil Filter Full Flow.....	C-5522	Cabin Air Filter.....	CA-55850	PF-300B (COMPACTORS) CAT (S/N: 7BJ1-UP)	
M325C (EXCAVATORS) CAT S/N: XJA1-UP		Hydraulic Oil Filter.....	H-5522	Air Filter Secondary.....	A-8670
Air Filter Secondary.....	A-5559	Hydraulic Oil Filter.....	HC-5801	Air Filter Primary.....	A-5673
Air Filter Primary.....	A-5558	M325B MH (MATERIAL HANDLERS) CAT 3056 (S/N: BGN1-UP)		Air Filter Set.....	A-5675-S
Cabin Air Filter.....	CA-55850	Air Filter Set.....	A-8604-S	Oil Filter Full Flow.....	C-5102
Fuel Filter.....	FC-5517	Air Filter Set.....	A-8508M-S	PF-300B (COMPACTORS) S/N: 6HM1-82-UP	
Hydraulic Oil Filter.....	HC-55170	Air Filter Primary.....	A-8508M	Air Filter Primary.....	A-76231
Hydraulic Oil Filter.....	H-5522	Air Filter Primary.....	A-8508	Air Filter Primary.....	A-5541M
Hydraulic Oil Filter.....	H-7942	Air Filter Secondary.....	A-8507	Air Filter Set.....	A-5541M-S
Hydraulic Oil Filter.....	HC-5801	Cabin Air Filter.....	CA-55850	Air Filter Secondary.....	A-5540
Oil Filter Full Flow.....	C-5522	Fuel Filter.....	FC-5516	PF-300B (COMPACTORS) S/N: 6HM196-412-UP	
M325C (EXCAVATORS) CAT 3126B ATAAC		Fuel Filter Secondary.....	FC-5515	Air Filter Set.....	A-5541M-S
Hydraulic Oil Filter.....	HC-9901	Fuel Filter Secondary.....	FC-55151	Air Filter Primary.....	A-76231
M325D (EXCAVATORS) CAT (S/N: C7C1-UP)		Fuel Filter.....	FC-5508	Air Filter Secondary.....	A-5540
Fuel Filter.....	FC-5517	Hydraulic Oil Filter.....	HC-5505	Air Filter Primary.....	A-5541M
Oil Filter Full Flow.....	C-5522	Hydraulic Oil Filter.....	H-7942	Air Filter Secondary.....	A-5540
M325D (EXCAVATORS) S/N: EDC1-UP		Hydraulic Oil Filter.....	HC-5801	PF-300B (COMPACTORS) S/N: 6HM1-82-UP	
Air Filter Primary.....	A-5558	Oil Filter Full Flow.....	C-5510	Air Filter Set.....	A-5541M-S
Air Filter Secondary.....	A-5559	M320F (EXCAVATORS) CAT C7.1		Air Filter Primary.....	A-76231
Cabin Air Filter.....	CA-55850	Fuel Filter.....	EF-55050	Air Filter Primary.....	A-5541
Hydraulic Oil Filter.....	HC-5801	M322F (EXCAVATORS) CAT C7.1		Air Filter Primary.....	A-5541M
Hydraulic Oil Filter.....	H-5522	Fuel Filter.....	EF-55050	Air Filter Set.....	A-5541M-S
M325D (EXCAVATORS) S/N: EDF1-UP		M330D (EXCAVATORS) CAT S/N: MBR1-UP		Air Filter Secondary.....	A-5540
Air Filter Secondary.....	A-5559	Cabin Air Filter.....	CA-55850	PF-300B (COMPACTORS) S/N: 6HM196-412-UP	
Air Filter Primary.....	A-5558	M330D (EXCAVATORS) CAT S/N: THY1-UP		Air Filter Set.....	A-5541M-S
Cabin Air Filter.....	CA-55850	Cabin Air Filter.....	CA-55850	Air Filter Primary.....	A-5541M
Hydraulic Oil Filter.....	HC-5801	M330D (EXCAVATORS) CAT S/N: THY1-UP		Air Filter Secondary.....	A-5540
Hydraulic Oil Filter.....	HC-5801	Cabin Air Filter.....	CA-55850	Air Filter Primary.....	A-5541M
				Air Filter Primary.....	A-5541

MODEL/APPLICATION	SAKURA NO	MODEL/APPLICATION	SAKURA NO	MODEL/APPLICATION	SAKURA NO
CATERPILLAR		CATERPILLAR		CATERPILLAR	
PF-300B (COMPACTORS) S/N: 6HM413-UP		Fuel Filter.....	FC-5510	Oil Filter Full Flow.....	C-5505
Air Filter Primary.....	A-5541	Hydraulic Oil Filter.....	H-55270	PR-1000C (COLD PLANERS) S/N: 03Z7212-UP	
Air Filter Primary.....	A-5541M	Hydraulic Oil Filter.....	HC-5504	Oil Filter Full Flow.....	C-5505
Air Filter Secondary.....	A-5540	PM-465 (COLD PLANERS) CAT S/N: 41Z4926-UP , 2004-UP		PR-1000C (COLD PLANERS) S/N: 38S13236-UP	
Air Filter Set.....	A-5541M-S	Air Filter Set.....	A-5565-S	Air Filter Set.....	A-5555-S
Air Filter Primary.....	A-76231	Air Filter Secondary.....	A-5563	Air Filter Primary.....	A-5555
PF-300B (COMPACTORS) S/N: 6HM83-195-UP		Air Filter Primary.....	A-5564	Air Filter Secondary.....	A-5556
Air Filter Secondary.....	A-5540	Fuel Filter.....	FC-5509	PR-1000C (COLD PLANERS) S/N: 5XC1-137-UP	
Air Filter Set.....	A-5541M-S	Hydraulic Oil Filter.....	HC-5512	Air Filter Primary.....	A-2210
Air Filter Primary.....	A-5541M	Hydraulic Oil Filter.....	HC-5504	Air Filter Set.....	A-7912-S
Air Filter Primary.....	A-5541	Hydraulic Oil Filter.....	HC-5503	Air Filter Secondary.....	A-7915
Air Filter Primary.....	A-76231	Hydraulic Oil Filter.....	HC-5506	Air Filter Primary.....	A-7912
Hydraulic Oil Filter.....	HC-5504	PM-465 (COLD PLANERS) CAT S/N: 5ZS146-UP , 2004-UP		PR-1000C (COLD PLANERS) S/N: 5XC138-138-UP	
PF-300 (COMPACTORS) S/N: 7WD1-UP		Air Filter Set.....	A-5565-S	Air Filter Primary.....	A-6113
Fuel Filter.....	FC-5704	Air Filter Secondary.....	A-5563	Air Filter Secondary.....	A-5408
Hydraulic Oil Filter.....	HC-7913	Air Filter Primary.....	A-5564	Air Filter Set.....	A-7912-S
PF-300C (COMPACTORS) CAT S/N: CRS2317-UP		Fuel Filter.....	FC-5509	Air Filter Secondary.....	A-7915
Air Filter Secondary.....	A-5540	Hydraulic Oil Filter.....	HC-5503	Air Filter Primary.....	A-7912
Air Filter Set.....	A-5541M-S	Hydraulic Oil Filter.....	HC-5512	Air Filter Secondary.....	A-7915
Air Filter Primary.....	A-5541	Hydraulic Oil Filter.....	HC-5504	Air Filter Primary.....	A-7912
Air Filter Primary.....	A-5541M	Hydraulic Oil Filter.....	HC-5506	PR-1000C (COLD PLANERS) S/N: 5XC139-142-UP	
Air Filter Primary.....	A-76231	PM-565 (COLD PLANERS) S/N: 3TK113-UP		Air Filter Set.....	A-7912-S
Oil Filter Full Flow.....	C-5102	Air Filter Set.....	A-5532-S	Air Filter Secondary.....	A-7915
PF-300C (COMPACTORS) CAT S/N: PFB1-UP		Air Filter Primary.....	A-5564	Air Filter Secondary.....	A-5408
Air Filter Set.....	A-5541M-S	Air Filter Set.....	A-5565-S	Air Filter Primary.....	A-7912
Air Filter Primary.....	A-76231	Air Filter Primary.....	A-5532	Air Filter Primary.....	A-6113
Air Filter Primary.....	A-5541	Air Filter Secondary.....	A-5563	PR-1000C (COLD PLANERS) S/N: 5XC143-143-UP	
Air Filter Primary.....	A-5541M	Fuel Filter.....	FC-5509	Air Filter Secondary.....	A-5408
Air Filter Secondary.....	A-5540	Oil Filter Full Flow.....	C-5516	Air Filter Secondary.....	A-7915
Oil Filter Full Flow.....	C-5102	PM-565B (COLD PLANERS) CAT 3408E HEUI		Air Filter Primary.....	A-6113
PF-300C (COMPACTORS) w/3054C Eng.		Air Filter Primary.....	A-5564	Air Filter Primary.....	A-7912
Fuel/Water Separator.....	SFC-43040	Air Filter Set.....	A-5565-S	Air Filter Set.....	A-7912-S
PM-200 (COLD PLANERS) CAT S/N: P1C1-UP		Air Filter Secondary.....	A-5563	PR-1000C (COLD PLANERS) S/N: 5XC144-147-UP	
Fuel Filter.....	FC-5517	Coolant Filter.....	WC-5707	Air Filter Secondary.....	A-7915
Fuel Filter.....	FC-5510	Fuel Filter.....	FC-5509	Air Filter Primary.....	A-7912
PM-200 (COLD PLANERS) CAT S/N: RHX1-UP		Hydraulic Oil Filter.....	H-55270	Air Filter Secondary.....	A-5408
Fuel Filter.....	FC-5517	Hydraulic Oil Filter.....	HC-5504	Air Filter Set.....	A-7912-S
Fuel Filter.....	FC-5510	Hydraulic Oil Filter.....	H-5504	Air Filter Primary.....	A-6113
PM-201 (COLD PLANERS) CAT S/N: PNM1-UP		Oil Filter Full Flow.....	C-5516	Air Filter Secondary.....	A-7912
Air Filter Secondary.....	A-5715	PM-800 (COLD PLANERS)		PR-1000C (COLD PLANERS) S/N: 5XC148-UP	
Fuel Filter.....	FC-5510	Fuel Filter.....	FC-5519	Air Filter Set.....	A-7912-S
Fuel Filter.....	FC-5517	Hydraulic Oil Filter.....	H-5517	Air Filter Secondary.....	A-7915
Hydraulic Oil Filter.....	HC-5504	Oil Filter Full Flow.....	C-5516	Air Filter Secondary.....	A-5408
Hydraulic Oil Filter.....	H-55270	PR-1000C (COLD PLANERS) CAT (S/N: 73W1-UP)		Air Filter Primary.....	A-6113
PM-201 (COLD PLANERS) CAT S/N: RHX1-UP		Fuel Filter.....	FC-5509	Air Filter Primary.....	A-7912
Air Filter Secondary.....	A-5715	PR-1000C (COLD PLANERS) CAT (S/N: 79V1-UP)		PR-100 (COLD PLANERS)	
Fuel Filter.....	FC-5517	Fuel Filter Secondary.....	FC-5507	Air Filter Set.....	AS-5656-S
Hydraulic Oil Filter.....	HC-5504	Oil Filter Full Flow.....	C-5505	Air Filter Primary.....	AS-7805
Hydraulic Oil Filter.....	H-55270	PR-1000C (COLD PLANERS) S/N: 03Z4000-7211-UP		Oil Filter Full Flow.....	C-5505
PM-201 (COLD PLANERS) CAT S/N: RHX1-UP		PR-1000C (COLD PLANERS) S/N: 03Z4000-7211-UP		PR-1000 (COLD PLANERS) S/N: 5XC1-137	
Air Filter Secondary.....	A-5715				
Fuel Filter.....	FC-5517				

Sakura Filter

ENGINE APPLICATION

MODEL/APPLICATION	SAKURA NO	MODEL/APPLICATION	SAKURA NO	MODEL/APPLICATION	SAKURA NO
CATERPILLAR		CATERPILLAR		CATERPILLAR	
PR-1000 (COLD PLANERS) S/N: 5XC1-137		Air Filter Primary.....	A-5541	Air Filter Primary.....	A-76231
Fuel Filter.....	FC-5519	Air Filter Primary.....	A-76231	Air Filter Set.....	A-5541M-S
Fuel Filter Secondary.....	FC-5507	Air Filter Set.....	A-5541M-S	Air Filter Secondary.....	A-5540
Oil Filter Full Flow.....	C-5516	Hydraulic Oil Filter.....	HC-5504	Air Filter Primary.....	A-5541
Oil Filter Full Flow.....	C-5505			Air Filter Primary.....	A-5541M
PR-100DC (COLD PLANERS)		PS-150C (COMPACTORS) CAT S/N: CRS1600-UP		PS-300B (COMPACTORS) CAT 3054T (S/N: 4NP81-UP)	
Air Filter Primary.....	AS-7805	Air Filter Primary.....	A-5541M	Air Filter Secondary.....	A-5540
Air Filter Set.....	AS-5656-S	Air Filter Primary.....	A-8504	Air Filter Primary.....	A-76231
Oil Filter Full Flow.....	C-5505	Air Filter Primary.....	A-5541	Air Filter Primary.....	A-5541
		Air Filter Secondary.....	A-5540	Air Filter Set.....	A-5541M-S
PR-105 (COLD PLANERS) S/N: 5NC1-UP		Air Filter Set.....	A-5541M-S	Air Filter Primary.....	A-5541M
Fuel Filter.....	FC-5503	Air Filter Primary.....	A-76231	Air Filter Primary.....	A-5541M
Hydraulic Oil Filter.....	H-79411	Hydraulic Oil Filter.....	HC-5504	Hydraulic Oil Filter.....	HC-5504
Hydraulic Oil Filter.....	H-51170	Oil Filter Full Flow.....	C-5102	Oil Filter Full Flow.....	C-5102
Oil Filter Full Flow.....	C-5504				
PR-275 (COLD PLANERS) S/N: 6RC1-UP		PS-150C (COMPACTORS) CAT S/N: FPS1-UP		PS-300B (COMPACTORS) CAT 3054T (S/N: 6HM1-UP)	
Air Filter.....	A-5505	Air Filter Primary.....	A-76231	Air Filter Primary.....	A-5541M
Oil Filter Full Flow.....	C-5510	Air Filter Primary.....	A-5541	Air Filter Primary.....	A-5541
		Air Filter Primary.....	A-8504	Air Filter Secondary.....	A-5540
PR-450 (COLD PLANERS) S/N: 7DC204-UP		Air Filter Secondary.....	A-5540	Air Filter Primary.....	A-76231
Fuel Filter.....	FC-5509	Air Filter Set.....	A-5541M-S	Air Filter Set.....	A-5541M-S
Fuel Filter.....	FC-5502	Air Filter Primary.....	A-5541M	Hydraulic Oil Filter.....	HC-5504
Oil Filter Full Flow.....	C-5516	Hydraulic Oil Filter.....	HC-5504	Oil Filter Full Flow.....	C-5102
		Oil Filter Full Flow.....	C-5102		
PR-450C (COLD PLANERS) CAT S/N: 48W34000-UP		PS-150C (COMPACTORS) w/3054T Eng.		PS-300C (COMPACTORS) CAT S/N: CRS2317-UP	
Fuel Filter.....	FC-5509	Fuel/Water Separator.....	SFC-43040	Air Filter Primary.....	A-5541M
Fuel Filter.....	FC-5502			Air Filter Secondary.....	A-5540
Oil Filter Full Flow.....	C-5516	PS110 (COMPACTORS) S/N: 7MD1-UP		Air Filter Primary.....	A-5541
		Fuel Filter.....	FC-5103	Air Filter Primary.....	A-76231
PR-450C (COLD PLANERS) CAT S/N: 67U14870-UP		PS-130 (COMPACTORS)		Air Filter Set.....	A-5541M-S
Fuel Filter.....	FC-5509	Fuel Filter.....	FC-5103	Oil Filter Full Flow.....	C-5102
Oil Filter Full Flow.....	C-5516				
PR-450C (COLD PLANERS) S/N: 7PJ1-55-UP		PS-180 (COMPACTORS)		PS-300C (COMPACTORS) CAT S/N: PFS1-UP	
Air Filter Secondary.....	A-6902	Fuel Filter.....	FC-5103	Air Filter Primary.....	A-5541M
Air Filter Set.....	A-6903-S			Air Filter Secondary.....	A-5540
Air Filter Primary.....	A-6903	PS-200B (COMPACTORS) CAT 7BJ1-UP , 2011		Air Filter Set.....	A-5541M-S
		Air Filter Secondary.....	A-56741	Air Filter Primary.....	A-5541
PR-450C (COLD PLANERS) S/N: 7PJ56-UP		Air Filter Set.....	A-56731-S	Air Filter Primary.....	A-76231
Air Filter Set.....	A-6903-S	Air Filter Primary.....	A-56731	Oil Filter Full Flow.....	C-5102
Air Filter Primary.....	A-6903				
Air Filter Secondary.....	A-6902	PS-200B (COMPACTORS) CAT 3054		PS-300C (COMPACTORS) w/3054C Eng.	
		Air Filter Primary.....	A-5541	Fuel/Water Separator.....	SFC-43040
PR-750B (COLD PLANERS) S/N: 8AC1-UP		Air Filter Set.....	A-5541M-S	PS-360B (COMPACTORS) CAT 7BJ1-UP , 2011	
Fuel Filter.....	FC-5509	Air Filter Secondary.....	A-5540	Air Filter Set.....	A-56731-S
Fuel Filter.....	FC-5519	Air Filter Primary.....	A-76231	Air Filter Secondary.....	A-56741
Oil Filter Full Flow.....	C-5516	Air Filter Primary.....	A-5541M	Air Filter Primary.....	A-56731
		Hydraulic Oil Filter.....	HC-5504		
PR-750C (COLD PLANERS) S/N: 7CK1-UP		Oil Filter Full Flow.....	C-5102	PS-360B (COMPACTORS) CAT 3054T	
Fuel Filter.....	FC-5509			Oil Filter Full Flow.....	C-5102
		PS-300B (COMPACTORS) CAT 7BJ1-UP , 2011		PS-360C (COMPACTORS) CAT CRS1-UP , 2011	
PS-150B (COMPACTORS) S/N: 3XR1-69		Air Filter Secondary.....	A-56741	Air Filter Primary.....	A-56731
Air Filter Primary.....	A-5541M	Air Filter Set.....	A-56731-S	Air Filter Secondary.....	A-56741
Air Filter Secondary.....	A-5540	Air Filter Primary.....	A-56731	Air Filter Set.....	A-56731-S

Sakura Filter

ENGINE APPLICATION

MODEL/APPLICATION	SAKURA NO	MODEL/APPLICATION	SAKURA NO	MODEL/APPLICATION	SAKURA NO
CATERPILLAR		CATERPILLAR		CATERPILLAR	
PS-360C (COMPACTORS) CAT CRS1-UP , 2011 Air Filter Secondary..... A-56741 Air Filter Primary..... A-56731 Air Filter Set..... A-56731-S		R40 (FORKLIFTS) PERKINS 4.236 Air Filter Set..... A-5579-S Air Filter Primary..... A-5577 Air Filter Secondary..... A-5576 Air Filter Set..... A-5578-S Fuel Filter..... FC-5103		R60 THRU R80 (FORKLIFTS) PERKINS 4.236 (S/N: 39A-UP) Air Filter Primary..... A-5577 Air Filter Set..... A-5579-S Air Filter Secondary..... A-5576 Air Filter Set..... A-5578-S Hydraulic Oil Filter..... H-5517 Hydraulic Oil Filter Transmission... HC-5501	
PS-360C (COMPACTORS) CAT G4D1-UP , 2011 Air Filter Primary..... A-56731 Air Filter Set..... A-56731-S Air Filter Secondary..... A-56741		R40 THRU RC60 (FORKLIFTS) PERKINS 4.236 (S/N: 16A-UP) Air Filter Set..... A-5578-S Air Filter Primary..... A-5577 Air Filter Secondary..... A-5576 Air Filter Set..... A-5579-S Hydraulic Oil Filter Transmission... HC-5501 Hydraulic Oil Filter..... H-5517		R60 THRU R80 (FORKLIFTS) PERKINS 4.236 DIESEL (S/N: 1KK-UP) Air Filter Set..... A-5579-S Air Filter Primary..... A-5577 Air Filter Secondary..... A-5576 Air Filter Set..... A-5578-S Fuel Filter..... FC-5103 Hydraulic Oil Filter..... H-5517 Hydraulic Oil Filter Transmission... HC-5501	
PS-360C (COMPACTORS) CAT S/N: CRS2700-UP Air Filter Primary..... A-5673 Air Filter Secondary..... A-8670 Air Filter Set..... A-5675-S Hydraulic Oil Filter..... HC-5504 Oil Filter Full Flow..... C-5102		R40 THRU RC60 (FORKLIFTS) PERKINS 4.236 (S/N: 26A-UP) Air Filter Secondary..... A-5576 Air Filter Primary..... A-5577 Air Filter Set..... A-5579-S Air Filter Set..... A-5578-S Hydraulic Oil Filter..... H-5517 Hydraulic Oil Filter Transmission... HC-5501		RH62 (HANDLER TELESCOPIC) PERKINS Hydraulic Oil Filter..... HC-5503 Hydraulic Oil Filter..... HC-5506 Oil Filter Full Flow..... C-5102	
PS-360C (COMPACTORS) CAT S/N: G4D1-UP Air Filter Secondary..... A-8670 Air Filter Set..... A-5675-S Air Filter Primary..... A-5673 Hydraulic Oil Filter..... HC-5504 Oil Filter Full Flow..... C-5102		R40 THRU RC60 (FORKLIFTS) PERKINS 4.236 DIESEL (S/N: 21A-UP) Air Filter Set..... A-5579-S Air Filter Primary..... A-5577 Air Filter Secondary..... A-5576 Air Filter Set..... A-5578-S Fuel Filter..... FC-5103 Hydraulic Oil Filter Transmission... HC-5501 Hydraulic Oil Filter..... H-5517		RH82 (HANDLER TELESCOPIC) PERKINS Hydraulic Oil Filter..... HC-5503 Hydraulic Oil Filter..... HC-5506 Oil Filter Full Flow..... C-5102	
PS-360C (COMPACTORS) CAT S/N: PJF1-UP Air Filter Set..... A-5675-S Air Filter Primary..... A-5673 Air Filter Secondary..... A-8670 Hydraulic Oil Filter..... HC-5504 Oil Filter Full Flow..... C-5102		R40 THRU RC60 (FORKLIFTS) PERKINS 4.236 DIESEL (S/N: 31A-UP) Air Filter Set..... A-5578-S Air Filter Primary..... A-5577 Air Filter Set..... A-5579-S Air Filter Secondary..... A-5576 Fuel Filter..... FC-5103 Hydraulic Oil Filter..... H-5517 Hydraulic Oil Filter Transmission... HC-5501		RM-300 (ROTARY MIXERS) CAT S/N: BWR1-UP Air Filter Primary..... A-5535 Air Filter Set..... A-5573-S Air Filter Secondary..... A-5534 Cabin Air Filter..... CA-55060 Fuel Filter..... FC-5517 Hydraulic Oil Filter..... H-5517 Hydraulic Oil Filter..... HC-5507 Hydraulic Oil Filter..... HC-55220	
PS-360C (COMPACTORS) w/3054C Eng. Fuel/Water Separator..... SFC-43040		R60 THRU R80 (FORKLIFTS) PERKINS 4.236 (S/N: 32A-UP) Air Filter Set..... A-5578-S Air Filter Primary..... A-5577 Air Filter Set..... A-5579-S Air Filter Secondary..... A-5576 Fuel Filter..... FC-5103 Hydraulic Oil Filter..... H-5517 Hydraulic Oil Filter Transmission... HC-5501		RM-300 (ROTARY MIXERS) CAT S/N: RSX1-UP Air Filter Secondary..... A-5534 Air Filter Set..... A-5573-S Air Filter Primary..... A-5535 Cabin Air Filter..... CA-55060 Fuel Filter..... FC-5517 Hydraulic Oil Filter..... HC-5507 Hydraulic Oil Filter..... HC-55220 Hydraulic Oil Filter..... H-5517	
PS-300 (COMPACTORS) DEUTZ F6L912 Fuel Filter..... FC-5704 Hydraulic Oil Filter..... HC-7913		R60 THRU R80 (FORKLIFTS) PERKINS 4.236 (S/N: 38A-38A) Air Filter Secondary..... A-5576 Air Filter Set..... A-5579-S Air Filter Primary..... A-5577 Air Filter Set..... A-5578-S Fuel Filter..... FC-5103 Hydraulic Oil Filter Transmission... HC-5501 Hydraulic Oil Filter..... H-5517		RM-300 (ROTARY MIXERS) w/C11 Eng. Air Filter Primary..... A-5535M Air Filter Set..... A-5573M-S	
PS-300 (COMPACTORS) S/N: 7TD1-UP Hydraulic Oil Filter..... HC-7913		R60 THRU R80 (FORKLIFTS) PERKINS 4.236 (S/N: 38A-38A) Air Filter Secondary..... A-5576 Air Filter Set..... A-5579-S Air Filter Primary..... A-5577 Air Filter Set..... A-5578-S Fuel Filter..... FC-5103 Hydraulic Oil Filter Transmission... HC-5501 Hydraulic Oil Filter..... H-5517		RM-350B (ROTARY MIXERS) CAT 3406C Air Filter Secondary..... A-5556 Air Filter Set..... A-5555-S Air Filter Primary..... A-5555 Fuel Filter..... FC-5509	
PS-300A (COMPACTORS) Fuel Filter..... F-5505 Oil Filter Full Flow..... C-5510		R60 THRU R80 (FORKLIFTS) PERKINS 4.236 (S/N: 38A-38A) Air Filter Secondary..... A-5576 Air Filter Set..... A-5579-S Air Filter Primary..... A-5577 Air Filter Set..... A-5578-S Fuel Filter..... FC-5103 Hydraulic Oil Filter Transmission... HC-5501 Hydraulic Oil Filter..... H-5517		RM-350B (ROTARY MIXERS) CAT 3406C Air Filter Secondary..... A-5556 Air Filter Set..... A-5555-S Air Filter Primary..... A-5555 Fuel Filter..... FC-5509	
PS-500 (COMPACTORS) S/N: 7XD1-UP Air Filter Secondary..... A-5550 Air Filter Primary..... A-5549 Air Filter Primary..... A-5509 Air Filter Set..... A-5522-S Air Filter Set..... A-5549M-S Air Filter Primary..... A-5549M Fuel Filter Secondary..... FC-5507 Oil Filter Full Flow..... C-5519		R60 THRU R80 (FORKLIFTS) PERKINS 4.236 (S/N: 38A-38A) Air Filter Secondary..... A-5576 Air Filter Set..... A-5579-S Air Filter Primary..... A-5577 Air Filter Set..... A-5578-S Fuel Filter..... FC-5103 Hydraulic Oil Filter Transmission... HC-5501 Hydraulic Oil Filter..... H-5517		RM-350B (ROTARY MIXERS) CAT 3406C Air Filter Secondary..... A-5556 Air Filter Set..... A-5555-S Air Filter Primary..... A-5555 Fuel Filter..... FC-5509	

MODEL/APPLICATION	SAKURA NO
CATERPILLAR	
RM-350B (ROTARY MIXERS) CAT 3406C	
Fuel Filter.....	F-5505
Hydraulic Oil Filter.....	HC-5516
Hydraulic Oil Filter.....	H-5517
Oil Filter Full Flow.....	C-5516
RM-350 (ROTARY MIXERS) CAT S/N: 11N7919-UP	
Air Filter Secondary.....	A-5529
Air Filter Primary.....	A-5555
Air Filter Set.....	A-5521-S
Air Filter Primary.....	A-5521
Air Filter Secondary.....	A-5556
Fuel Filter.....	FC-5509
Hydraulic Oil Filter.....	HC-5516
Hydraulic Oil Filter.....	H-5517
Hydraulic Oil Filter.....	HC-55220
Hydraulic Oil Filter.....	HC-5507
Hydraulic Oil Filter.....	HC-55300
Oil Filter Full Flow.....	C-5516
RM-350 (ROTARY MIXERS) CAT S/N: 41Z257-UP	
Air Filter Secondary.....	A-5529
Air Filter Primary.....	A-5555
Air Filter Set.....	A-5521-S
Air Filter Secondary.....	A-5556
Air Filter Set.....	A-5555-S
Air Filter Primary.....	A-5521
Fuel Filter.....	FC-5509
Hydraulic Oil Filter.....	HC-55220
Hydraulic Oil Filter.....	HC-5507
Hydraulic Oil Filter.....	H-5517
Hydraulic Oil Filter.....	HC-55300
Hydraulic Oil Filter.....	H-5506
Hydraulic Oil Filter.....	HC-5516
Oil Filter Full Flow.....	C-5516
RM-350 (ROTARY MIXERS) CAT S/N: 5FK104-UP	
Air Filter Primary.....	A-5555
Air Filter Secondary.....	A-5556
Air Filter Set.....	A-5555-S
Fuel Filter.....	FC-5509
Hydraulic Oil Filter.....	HC-5516
Hydraulic Oil Filter.....	H-5517
Hydraulic Oil Filter.....	HC-55220
Hydraulic Oil Filter.....	HC-5507
Hydraulic Oil Filter.....	HC-55300
Oil Filter Full Flow.....	C-5516
RM-350 (ROTARY MIXERS) CAT S/N: 5FK1-40-UP	
Air Filter Set.....	A-5521-S
Air Filter Primary.....	A-5521
Air Filter Secondary.....	A-5529
Fuel Filter.....	FC-5509
Hydraulic Oil Filter.....	HC-5507
Hydraulic Oil Filter.....	H-5517
Hydraulic Oil Filter.....	HC-55220
Oil Filter Full Flow.....	C-5516

MODEL/APPLICATION	SAKURA NO
CATERPILLAR	
RM-350 (ROTARY MIXERS) CAT S/N: 5FK41-103-UP	
Air Filter Primary.....	A-5555
Air Filter Set.....	A-5555-S
Air Filter Secondary.....	A-5556
Fuel Filter.....	FC-5509
Hydraulic Oil Filter.....	HC-5507
Hydraulic Oil Filter.....	H-5517
Hydraulic Oil Filter.....	HC-55220
Oil Filter Full Flow.....	C-5516
RM367 (COMPACTORS) CAT 3406 (S/N: 87X00752-87X01455)	
Air Filter Secondary.....	A-5502
Fuel Filter.....	F-5505
RM-500 (ROTARY MIXERS) CAT S/N: ASW1-109-UP , 2006-UP	
Air Filter Primary.....	A-5564
Air Filter Secondary.....	A-5563
Air Filter Set.....	A-5565-S
Fuel Filter.....	FC-5517
Hydraulic Oil Filter.....	H-5517
Hydraulic Oil Filter.....	HC-55220
Hydraulic Oil Filter.....	HC-5512
Hydraulic Oil Filter.....	HC-5506
Hydraulic Oil Filter.....	HC-5507
Hydraulic Oil Filter.....	HC-5503
RM-500 (ROTARY MIXERS) CAT S/N: LHX1-UP , 2006-UP	
Air Filter Primary.....	A-5564
Air Filter Secondary.....	A-5563
Air Filter Set.....	A-5565-S
Cabin Air Filter.....	CA-55060
Fuel Filter.....	FC-5517
Hydraulic Oil Filter.....	H-5517
Hydraulic Oil Filter.....	HC-55220
Hydraulic Oil Filter.....	HC-5507
Hydraulic Oil Filter.....	HC-5506
Hydraulic Oil Filter.....	HC-5503
Hydraulic Oil Filter.....	HC-5512
RR-250 (ROAD RECLAIMER) S/N: 6ED1-UP	
Air Filter Primary.....	AS-7805
Air Filter Secondary.....	A-5529
Air Filter Set.....	AS-5656-S
Fuel Filter.....	FC-5509
Fuel Filter.....	FC-5519
Oil Filter Full Flow.....	C-5516
RR-250B (ROAD RECLAIMER)	
Air Filter Secondary.....	A-5529
Coolant Filter.....	WC-6901

MODEL/APPLICATION	SAKURA NO
CATERPILLAR	
Fuel Filter.....	FC-5509
Hydraulic Oil Filter.....	H-5517
RT100 (HANDLER TELESCOPIC) S/N: 16J1-UP	
Air Filter Primary.....	A-5511
Air Filter Set.....	A-5511-S
Fuel Filter.....	FC-5523
Fuel Filter.....	FC-5501
Oil Filter Full Flow.....	C-5505
RT40 THRU RTC60 (FORKLIFTS) PERKINS 4.236 DIESEL (S/N: 4XG-UP)	
Air Filter Set.....	A-5579-S
Air Filter Primary.....	A-5577
Air Filter Secondary.....	A-5576
Air Filter Set.....	A-5578-S
Fuel Filter.....	FC-5103
Hydraulic Oil Filter.....	H-5517
Hydraulic Oil Filter Transmission...	HC-5501
RT50 (HANDLER TELESCOPIC) S/N: 4XG1-UP	
Air Filter Set.....	A-5578-S
Air Filter Secondary.....	A-5576
Air Filter Primary.....	A-5577
Air Filter Set.....	A-5579-S
Fuel Filter.....	FC-5103
Hydraulic Oil Filter Transmission...	HC-5501
RT50 (SA) (HANDLER TELESCOPIC)	
Air Filter Primary.....	A-5507
Air Filter Set.....	A-55071-S
Air Filter Set.....	A-5507-S
Air Filter Secondary.....	A-5508
Fuel Filter.....	FC-5103
Hydraulic Oil Filter Transmission...	HC-5501
RT505A (HANDLER TELESCOPIC)	
Air Filter Set.....	A-5578-S
Air Filter Primary.....	A-5577
Air Filter Secondary.....	A-5576
Air Filter Set.....	A-5579-S
Fuel Filter.....	FC-5103
Hydraulic Oil Filter Transmission...	HC-5501
RT60 (FORKLIFTS) PERKINS 4.236 DIESEL (S/N: 5DG-UP)	
Air Filter Set.....	A-5579-S
Air Filter Secondary.....	A-5576
Air Filter Set.....	A-5578-S
Air Filter Primary.....	A-5577
Fuel Filter.....	FC-5103
Hydraulic Oil Filter Transmission...	HC-5501
Hydraulic Oil Filter.....	H-5517
RT80 (HANDLER TELESCOPIC) S/N: 2YC1-UP	
Air Filter Secondary.....	A-5525
Air Filter Set.....	A-5542-S
Air Filter Primary.....	A-5542
Fuel Filter.....	FC-5503
Hydraulic Oil Filter.....	H-5504

MODEL/APPLICATION	SAKURA NO	MODEL/APPLICATION	SAKURA NO	MODEL/APPLICATION	SAKURA NO
CATERPILLAR		CATERPILLAR		CATERPILLAR	
RT80 (HANDLER TELESCOPIC) S/N: 2YC1-UP Oil Filter Full Flow..... C-5519		SF350 (SLIPFORM PAVER) S/N: 5RD1-UP Fuel Filter Secondary..... FC-5507 Oil Filter Full Flow..... C-5510		T100D-T150D (FORKLIFTS) PERKINS 4.236 GAS (S/N: 5MB-UP) Air Filter Set..... A-5578-S Air Filter Secondary..... A-5576 Air Filter Set..... A-5579-S Air Filter Primary..... A-5577 Hydraulic Oil Filter Transmission... HC-5501	
RT80 (HANDLER TELESCOPIC) S/N: 3JN1-UP Air Filter Secondary..... A-5540 Air Filter Set..... A-5541M-S Air Filter Primary..... A-5541 Air Filter Primary..... A-76231 Air Filter Primary..... A-5541M Hydraulic Oil Filter..... HC-5503 Oil Filter Full Flow..... C-5102		SF450 (SLIPFORM PAVER) S/N: 7GC1-UP Fuel Filter Secondary..... FC-5507 Oil Filter Full Flow..... C-5510		T100D-T150D (FORKLIFTS) PERKINS 4.2482 DIESEL (S/N: 5NB-UP) Air Filter Secondary..... A-5576 Air Filter Set..... A-5579-S Air Filter Primary..... A-5577 Air Filter Set..... A-5578-S Fuel Filter..... FC-5103 Hydraulic Oil Filter Transmission... HC-5501	
RT80 (HANDLER TELESCOPIC) S/N: 3NN1-UP Air Filter Primary..... A-76231 Air Filter Secondary..... A-5540 Air Filter Primary..... A-5541M Air Filter Set..... A-5541M-S Air Filter Primary..... A-5541 Hydraulic Oil Filter..... HC-5503 Oil Filter Full Flow..... C-5102		SF550 (SLIPFORM PAVER) S/N: 5PD1-UP Air Filter Secondary..... A-6902 Fuel Filter..... FC-5509 Fuel Filter..... FC-5519 Hydraulic Oil Filter..... H-51170 Oil Filter Full Flow..... C-5516		T120C (FORKLIFTS) CONTINENTAL F227 Air Filter Primary..... A-70270	
RT80 (HANDLER TELESCOPIC) S/N: 3RN1-UP Air Filter Secondary..... A-5540 Air Filter Primary..... A-76231 Air Filter Primary..... A-5541M Air Filter Set..... A-5541M-S Air Filter Primary..... A-5541 Hydraulic Oil Filter..... HC-5503 Oil Filter Full Flow..... C-5102		SM-350 (ROAD RECLAIMER) S/N: 1RM1-UP Air Filter Secondary..... A-5529 Fuel Filter..... FC-5509 Oil Filter Full Flow..... C-5516		T25D-TC40D (FORKLIFTS) PEUGEOT XN1P (S/N: 5GB-UP) Hydraulic Oil Filter Transmission... HC-5501 Oil Filter Full Flow..... C-1005	
RT80 (HANDLER TELESCOPIC) S/N: 5MM1-UP Air Filter Primary..... A-5541 Air Filter Secondary..... A-5540 Air Filter Primary..... A-5541M Air Filter Set..... A-5541M-S Air Filter Primary..... A-76231 Hydraulic Oil Filter..... HC-5503 Oil Filter Full Flow..... C-5102		SS-250 (STABILIZERS) S/N: 6DD1-UP Air Filter Secondary..... A-5529 Fuel Filter Secondary..... FC-5507 Oil Filter Full Flow..... C-5516		T25D-TC40D (FORKLIFTS) PEUGEOT XN1P GAS (S/N: 5GB-UP) Hydraulic Oil Filter Transmission... HC-5501 Oil Filter Full Flow..... C-1005	
RTC60 (FORKLIFTS) Hydraulic Oil Filter Transmission... HC-5501		SS-250B (STABILIZERS) CAT S/N: 11N13299-UP Air Filter Secondary..... A-5556 Air Filter Set..... A-5555-S Air Filter Primary..... A-5555 Fuel Filter..... FC-5509 Hydraulic Oil Filter..... HC-5507 Hydraulic Oil Filter..... H-5517 Hydraulic Oil Filter..... HC-55220 Oil Filter Full Flow..... C-5516		T25-TC30 (FORKLIFTS) CONTINEL F-163 (S/N: 11X-UP) Hydraulic Oil Filter..... H-79411	
SF175 (SLIPFORM PAVER) S/N: 52C1-UP Air Filter Primary..... A-2210 Fuel Filter Secondary..... FC-5507		SS-250B (STABILIZERS) CAT S/N: 41Z1-UP Air Filter Secondary..... A-5556 Air Filter Set..... A-5555-S Air Filter Primary..... A-5555 Fuel Filter..... FC-5509 Fuel Filter..... FC-5519 Hydraulic Oil Filter..... H-5517 Hydraulic Oil Filter..... HC-55220 Hydraulic Oil Filter..... HC-5507		T25-TC30 (FORKLIFTS) CONTINEL F-163 (S/N: 22Y-UP) Hydraulic Oil Filter Transmission... HC-5501	
SF175 (SLIPFORM PAVER) S/N: 52C1-UP Air Filter..... A-5553 Fuel Filter Secondary..... FC-5507 Oil Filter Full Flow..... C-5519		T25-TC30 (FORKLIFTS) CONTINEL F-163 (S/N: 61V-UP) Oil Filter Full Flow..... C-5504		T25-TC30 (FORKLIFTS) CONTINEL F-163 (S/N: 71V-UP) Hydraulic Oil Filter..... H-79411	
SF250 (SLIPFORM PAVER) S/N: 6XC1-UP Air Filter..... A-5553 Fuel Filter Secondary..... FC-5507 Hydraulic Oil Filter..... H-51170 Oil Filter Full Flow..... C-5519		T25-TC30 (FORKLIFTS) CONTINEL F-163 (S/N: 71V-UP) Hydraulic Oil Filter..... H-79411		T30 (FORKLIFTS) PERKINS 3.152 Air Filter Primary..... A-70280	
		T30B-T60B (FORKLIFTS) CAT 1404 (S/N: 13Y-UP) Air Filter Primary..... A-5577 Air Filter Secondary..... A-5576 Air Filter Set..... A-5578-S Air Filter Set..... A-5579-S Hydraulic Oil Filter..... H-79411 Oil Filter Full Flow..... C-5504			
		T30B-T60B (FORKLIFTS) CAT 1404 (S/N: 15Y-UP) Air Filter Secondary..... A-5576 Air Filter Set..... A-5578-S Air Filter Set..... A-5579-S Air Filter Primary..... A-5577 Oil Filter Full Flow..... C-5504			

MODEL/APPLICATION	SAKURA NO	MODEL/APPLICATION	SAKURA NO	MODEL/APPLICATION	SAKURA NO
CATERPILLAR		CATERPILLAR		CATERPILLAR	
T30B-T60B (FORKLIFTS) CAT 1404 (S/N: 16Y-UP) Air Filter Set..... A-5578-S Air Filter Secondary..... A-5576 Air Filter Set..... A-5579-S Air Filter Primary..... A-5577 Hydraulic Oil Filter..... H-79411 Oil Filter Full Flow..... C-5504		Oil Filter Full Flow..... C-5504 T30C-TC60C (FORKLIFTS) PERKINS 4.2032 (S/N: 66S-UP) Air Filter Set..... A-5578-S Air Filter Secondary..... A-5576 Air Filter Set..... A-5579-S Air Filter Primary..... A-5577 Fuel Filter..... FC-5103 Hydraulic Oil Filter Transmission... HC-5501		T40D-TC60D (FORKLIFTS) PEUGEOT XD3P DIESEL (S/N: 2YB-UP) Fuel Filter..... FC-5101 Hydraulic Oil Filter Transmission... HC-5501 Oil Filter Full Flow..... C-1005	
T30B-T60B (FORKLIFTS) CAT 1404 (S/N: 17Y-UP) Air Filter Set..... A-5578-S Air Filter Set..... A-5579-S Air Filter Primary..... A-5577 Air Filter Secondary..... A-5576 Oil Filter Full Flow..... C-5504		T30-T60 (FORKLIFTS) CONTINEL F-163 (S/N: 07N-UP) Hydraulic Oil Filter..... H-79411 T30-T60 (FORKLIFTS) PERKINS 3.152 DIESEL (S/N: 48G-UP) Fuel Filter..... FC-5103		T40D-TC60D (FORKLIFTS) PEUGEOT XN1P (S/N: 8EB-UP) Hydraulic Oil Filter Transmission... HC-5501 Oil Filter Full Flow..... C-1005	
T30B-T60B (FORKLIFTS) CONTINEL F-163 GAS (S/N: 40N-UP) Hydraulic Oil Filter..... H-79411		T30-T60 (FORKLIFTS) PERKINS 3.152 DIESEL (S/N: 95H-UP) Fuel Filter..... FC-5103 Hydraulic Oil Filter..... H-79411		T40D-TC60D SA (FORKLIFTS) CAT 1404 Air Filter Set..... A-5578-S Air Filter Set..... A-5579-S Air Filter Primary..... A-5577 Air Filter Secondary..... A-5576 Hydraulic Oil Filter Transmission... HC-5501 Oil Filter Full Flow..... C-5504	
T30B-T60B (FORKLIFTS) CONTINEL F-163 GAS (S/N: 42N-UP) Hydraulic Oil Filter..... H-79411		T30B (FORKLIFTS) 1404 Air Filter Primary..... A-70280		T40D-TC60D SA (FORKLIFTS) CAT 1404 (S/N: 2LC-UP) Air Filter Set..... A-5579-S Air Filter Secondary..... A-5576 Air Filter Set..... A-5578-S Air Filter Primary..... A-5577 Hydraulic Oil Filter Transmission... HC-5501 Oil Filter Full Flow..... C-5504	
T30B-T60B (FORKLIFTS) CONTINEL F-163 GAS (S/N: 62R-UP) Hydraulic Oil Filter..... H-79411		T30B (FORKLIFTS) CAT 1404 Air Filter Primary..... A-70270		T40D-TC60D SA (FORKLIFTS) CAT 1404 (S/N: 9PB-UP) Air Filter Primary..... A-5577 Air Filter Set..... A-5578-S Air Filter Secondary..... A-5576 Air Filter Set..... A-5579-S Hydraulic Oil Filter Transmission... HC-5501 Oil Filter Full Flow..... C-5504	
T30B-T60B (FORKLIFTS) CONTINEL F-163 GAS (S/N: 64P-UP) Hydraulic Oil Filter..... H-79411		T30B (FORKLIFTS) PERKINS 3.152 Air Filter Primary..... A-70280		T40D-TC60D SA (FORKLIFTS) CAT 1404 GAS (S/N: 2LC-UP) Air Filter Set..... A-5578-S Air Filter Secondary..... A-5576 Air Filter Set..... A-5579-S Air Filter Primary..... A-5577 Hydraulic Oil Filter Transmission... HC-5501 Oil Filter Full Flow..... C-5504	
T30B-T60B (FORKLIFTS) PERKINS 3.152 DIESEL (S/N: 47S-UP) Fuel Filter..... FC-5103		T30C (FORKLIFTS) 1404 Air Filter Primary..... A-70280		T40D-TC60D SA (FORKLIFTS) CAT 1404 GAS (S/N: 9PB-UP) Air Filter Set..... A-5579-S Air Filter Secondary..... A-5576 Air Filter Set..... A-5578-S Air Filter Primary..... A-5577 Hydraulic Oil Filter Transmission... HC-5501 Oil Filter Full Flow..... C-5504	
T30B-T60B (FORKLIFTS) PERKINS 3.152 DIESEL (S/N: 48S-UP) Fuel Filter..... FC-5103 Hydraulic Oil Filter..... H-79411		T30C (FORKLIFTS) CAT 1404 Air Filter Primary..... A-70270		T40D-TC60D SA (FORKLIFTS) CAT 1404 GAS (S/N: 9PB-UP) Air Filter Set..... A-5578-S Air Filter Secondary..... A-5576 Air Filter Set..... A-5579-S Air Filter Primary..... A-5577 Hydraulic Oil Filter Transmission... HC-5501 Oil Filter Full Flow..... C-5504	
T30C-TC60C (FORKLIFTS) CAT 1404 (S/N: 38Y-UP) Air Filter Set..... A-5578-S Air Filter Secondary..... A-5576 Air Filter Primary..... A-5577 Air Filter Set..... A-5579-S Hydraulic Oil Filter Transmission... HC-5501 Oil Filter Full Flow..... C-5504		T40B (FORKLIFTS) 1404 Air Filter Primary..... A-70280		T40D-TC60D SA (FORKLIFTS) CAT 1404 GAS (S/N: 9PB-UP) Air Filter Set..... A-5579-S Air Filter Secondary..... A-5576 Air Filter Set..... A-5578-S Air Filter Primary..... A-5577 Hydraulic Oil Filter Transmission... HC-5501 Oil Filter Full Flow..... C-5504	
T30C-TC60C (FORKLIFTS) CAT 1404 (S/N: 67W-UP) Air Filter Secondary..... A-5576 Air Filter Set..... A-5578-S Air Filter Set..... A-5579-S Air Filter Primary..... A-5577 Oil Filter Full Flow..... C-5504		T40B (FORKLIFTS) CAT 1404 Air Filter Set..... A-5579-S Air Filter Primary..... A-5577 Air Filter Secondary..... A-5576 Air Filter Set..... A-5578-S Oil Filter Full Flow..... C-5504		T40D-TC60D SA (FORKLIFTS) CAT 1404 GAS (S/N: 9PB-UP) Air Filter Set..... A-5579-S Air Filter Secondary..... A-5576 Air Filter Set..... A-5578-S Air Filter Primary..... A-5577 Hydraulic Oil Filter Transmission... HC-5501 Oil Filter Full Flow..... C-5504	
T30C-TC60C (FORKLIFTS) CAT 1404 (S/N: 93W-UP) Air Filter Set..... A-5579-S Air Filter Secondary..... A-5576 Air Filter Primary..... A-5577 Air Filter Set..... A-5578-S Hydraulic Oil Filter..... H-79411		T40C LIFT (FORKLIFTS) PERKINS 3.152 Air Filter Primary..... A-70280 Fuel Filter..... FC-5103		T40 (FORKLIFTS) PERKINS 3.152 Air Filter Primary..... A-70280	
		T40B (FORKLIFTS) PERKINS 3.152 Air Filter Primary..... A-70280		T45B (FORKLIFTS) PERKINS 3.152 Air Filter Primary..... A-70280	
		T40C (FORKLIFTS) PERKINS 3.152 Air Filter Primary..... A-70280		T50E (FORKLIFTS)	

MODEL/APPLICATION	SAKURA NO	MODEL/APPLICATION	SAKURA NO	MODEL/APPLICATION	SAKURA NO
CATERPILLAR		CATERPILLAR		CATERPILLAR	
T50E (<i>FORKLIFTS</i>)		Hydraulic Oil Filter.....	H-79411	Hydraulic Oil Filter Transmission....	HC-5501
Air Filter Primary.....	A-5537	T60C-T120C (<i>FORKLIFTS</i>)		T60D-TC120D (<i>FORKLIFTS</i>)	
Air Filter Set.....	A-5537-S	CONTINEL F-227 GAS (S/N: 33L-UP)		PERKINS 4.2482 DIESEL (S/N: 5PB-UP)	
T-50 (<i>FORKLIFTS</i>)		Hydraulic Oil Filter.....	H-79411	Air Filter Set.....	A-5579-S
PERKINS 3.152		T60C-T120C (<i>FORKLIFTS</i>)		Air Filter Secondary.....	A-5576
Air Filter Primary.....	A-70280	CONTINEL F-227 GAS (S/N: 35R-UP)		Air Filter Set.....	A-5578-S
T50B (<i>FORKLIFTS</i>)		Hydraulic Oil Filter.....	H-79411	Air Filter Primary.....	A-5577
PERKINS 3.152		T60C-T120C (<i>FORKLIFTS</i>)		Fuel Filter.....	FC-5103
Air Filter Primary.....	A-70280	CONTINEL F-227 GAS (S/N: 37R-UP)		Hydraulic Oil Filter.....	H-79411
T60 (<i>FORKLIFTS</i>)		Air Filter Primary.....	A-5577	T60B (<i>FORKLIFTS</i>)	
CONTINENTAL F163		Air Filter Secondary.....	A-5576	1404	
Air Filter Primary.....	A-70280	Air Filter Set.....	A-5578-S	Air Filter Primary.....	A-70280
T60 (<i>FORKLIFTS</i>)		Air Filter Set.....	A-5579-S	T60B (<i>FORKLIFTS</i>)	
PERKINS 3.152		T60C-T120C (<i>FORKLIFTS</i>)		PERKINS 3.152	
Air Filter Primary.....	A-70270	CONTINEL F-227 GAS (S/N: 53R-UP)		Air Filter Primary.....	A-70280
Air Filter Primary.....	A-70280	Hydraulic Oil Filter.....	H-79411	Air Filter Primary.....	A-70270
Fuel Filter.....	FC-5103	T60C-T120C (<i>FORKLIFTS</i>)		T60D (<i>FORKLIFTS</i>)	
T60C (<i>FORKLIFTS</i>)		CONTINEL F-227 GAS (S/N: 56Y-UP)		PERKINS 4.236	
1404		Air Filter Set.....	A-5578-S	Air Filter Primary.....	A-70280
Air Filter Primary.....	A-70280	Air Filter Secondary.....	A-5576	Air Filter Primary.....	A-70270
T60C (<i>FORKLIFTS</i>)		Air Filter Primary.....	A-5577	TC60C (<i>FORKLIFTS</i>)	
CAT 1404		Air Filter Set.....	A-5579-S	1404	
Air Filter Set.....	A-5578-S	T60D-TC120D (<i>FORKLIFTS</i>)		Air Filter Primary.....	A-70280
Air Filter Set.....	A-5579-S	PERKINS 4.236 (S/N: 5KB-UP)		TC60C (<i>FORKLIFTS</i>)	
Air Filter Primary.....	A-5577	Air Filter Primary.....	A-5577	CAT 1404	
Air Filter Secondary.....	A-5576	Air Filter Set.....	A-5579-S	Air Filter Primary.....	A-70270
Air Filter Secondary.....	A-5576	Air Filter Secondary.....	A-5576	TH103 (<i>HANDLER TELESCOPIC</i>)	
Hydraulic Oil Filter Transmission....	HC-5501	Air Filter Set.....	A-5578-S	CAT 3054 (S/N: 3PN2500-UP)	
Oil Filter Full Flow.....	C-5504	Hydraulic Oil Filter Transmission....	HC-5501	Air Filter Secondary.....	A-5540
T60C-T120C (<i>FORKLIFTS</i>)		T60D-TC120D (<i>FORKLIFTS</i>)		Hydraulic Oil Filter.....	HC-5512
CONTINEL F-227 (S/N: 18N-UP)		PERKINS 4.236 (S/N: 5RB-UP)		Oil Filter Full Flow.....	C-5102
Hydraulic Oil Filter.....	H-79411	Air Filter Primary.....	A-5577	TH103 (<i>HANDLER TELESCOPIC</i>)	
T60C-T120C (<i>FORKLIFTS</i>)		Air Filter Secondary.....	A-5576	CAT 7BJ1-UP	
CONTINEL F-227 (S/N: 33L-UP)		Air Filter Set.....	A-5578-S	Air Filter Primary.....	A-56731
Hydraulic Oil Filter.....	H-79411	Air Filter Set.....	A-5579-S	Air Filter Set.....	A-56731-S
T60C-T120C (<i>FORKLIFTS</i>)		Hydraulic Oil Filter.....	H-79411	Air Filter Secondary.....	A-56741
CONTINEL F-227 (S/N: 35R-UP)		T60D-TC120D (<i>FORKLIFTS</i>)		TH103 (<i>HANDLER TELESCOPIC</i>)	
Hydraulic Oil Filter.....	H-79411	PERKINS 4.236 GAS (S/N: 5KB-UP)		S/N: 3PN1-UP	
T60C-T120C (<i>FORKLIFTS</i>)		Air Filter Secondary.....	A-5576	Air Filter Set.....	A-5541M-S
CONTINEL F-227 (S/N: 37R-UP)		Air Filter Set.....	A-5578-S	Air Filter Primary.....	A-76231
Air Filter Set.....	A-5578-S	Air Filter Set.....	A-5579-S	Air Filter Primary.....	A-5541M
Air Filter Set.....	A-5579-S	Air Filter Primary.....	A-5577	Air Filter Primary.....	A-5541
Air Filter Primary.....	A-5577	Hydraulic Oil Filter Transmission....	HC-5501	Air Filter Secondary.....	A-5540
Air Filter Secondary.....	A-5576	T60D-TC120D (<i>FORKLIFTS</i>)		Oil Filter Full Flow.....	C-5102
T60C-T120C (<i>FORKLIFTS</i>)		PERKINS 4.236 GAS (S/N: 5RB-UP)		TH210 (<i>HANDLER TELESCOPIC</i>)	
CONTINEL F-227 (S/N: 53R-UP)		Air Filter Set.....	A-5578-S	CAT 3054 (S/N: CEC1-UP)	
Hydraulic Oil Filter.....	H-79411	Air Filter Primary.....	A-5577	Air Filter Secondary.....	A-5540
T60C-T120C (<i>FORKLIFTS</i>)		Air Filter Set.....	A-5579-S	TH210 (<i>HANDLER TELESCOPIC</i>)	
CONTINEL F-227 (S/N: 56Y-UP)		Air Filter Secondary.....	A-5576	w/3054C Eng.	
Air Filter Primary.....	A-5577	Hydraulic Oil Filter.....	H-79411	Fuel/Water Separator.....	SFC-43040
Air Filter Set.....	A-5579-S	T60D-TC120D (<i>FORKLIFTS</i>)		TH215 (<i>HANDLER TELESCOPIC</i>)	
Air Filter Secondary.....	A-5576	PERKINS 4.2482 DIESEL (S/N: 5LB-UP)		CAT 3054 (S/N: CEG1-09999-UP)	
Air Filter Set.....	A-5578-S	Air Filter Primary.....	A-5577	Air Filter Secondary.....	A-5540
T60C-T120C (<i>FORKLIFTS</i>)		Air Filter Set.....	A-5578-S	TH215 (<i>HANDLER TELESCOPIC</i>)	
CONTINEL F-227 GAS (S/N: 18N-UP)		Air Filter Secondary.....	A-5576	w/3054C Eng.	
Hydraulic Oil Filter.....	H-79411	Air Filter Set.....	A-5579-S	Fuel/Water Separator.....	SFC-43040
T60C-T120C (<i>FORKLIFTS</i>)		Fuel Filter.....	FC-5103		
CONTINEL F-227 GAS (S/N: 18N-UP)					

Sakura Filter

ENGINE APPLICATION

MODEL/APPLICATION	SAKURA NO	MODEL/APPLICATION	SAKURA NO	MODEL/APPLICATION	SAKURA NO
CATERPILLAR		CATERPILLAR		CATERPILLAR	
TH220B (HANDLER TELESCOPIC) CAT (S/N: CRX1-106)		Hydraulic Oil Filter.....	HC-5504	Air Filter Set.....	A-5675-S
Oil Filter Full Flow.....	C-5102	Oil Filter Full Flow.....	C-5102	Hydraulic Oil Filter.....	HC-5504
TH220B (HANDLER TELESCOPIC) CAT 3054 (S/N: SLA1-UP)		TH355B (HANDLER TELESCOPIC) CAT S/N: CRX1-647-UP		Oil Filter Full Flow.....	C-5102
Air Filter Primary.....	A-5673	Air Filter Secondary.....	A-8670	TH330B (HANDLER TELESCOPIC) w/3054E Eng.	
Air Filter Set.....	A-5675-S	Air Filter Set.....	A-5675-S	Fuel/Water Separator.....	SFC-43040
Air Filter Secondary.....	A-8670	Air Filter Primary.....	A-5673	TH336 (HANDLER TELESCOPIC) CAT C4.4 , 2008-UP	
Hydraulic Oil Filter.....	HC-5504	Hydraulic Oil Filter.....	HC-5504	Oil Filter Full Flow.....	C-5102
Oil Filter Full Flow.....	C-5102	TH355B (HANDLER TELESCOPIC) CAT S/N: JRK1-UP		TH337 (HANDLER TELESCOPIC) CAT C4.4 , 2008-UP	
TH220B (HANDLER TELESCOPIC) w/3054E Eng.		Air Filter Primary.....	A-5673	Oil Filter Full Flow.....	C-5102
Fuel/Water Separator.....	SFC-43040	Air Filter Set.....	A-5675-S	TH330B SLB1 (HANDLER TELESCOPIC) CAT 3054 , 2004	
TH255 (HANDLER TELESCOPIC) CAT C4.4 , 2008-UP		Air Filter Secondary.....	A-8670	Air Filter Set.....	A-56731-S
Oil Filter Full Flow.....	C-5102	Hydraulic Oil Filter.....	HC-5504	Air Filter Secondary.....	A-56741
TH220B SLA1 (HANDLER TELESCOPIC) CAT 3054		Oil Filter Full Flow.....	C-5102	Air Filter Primary.....	A-56731
Air Filter Primary.....	A-56731	TH355B (HANDLER TELESCOPIC) CAT CRX1-647		TH460B (HANDLER TELESCOPIC) CAT 3054E , 2012	
Air Filter Set.....	A-56731-S	Air Filter Secondary.....	A-56741	Air Filter Secondary.....	A-56741
Air Filter Secondary.....	A-56741	Air Filter Set.....	A-56731-S	Air Filter Primary.....	A-56731
TH340B (HANDLER TELESCOPIC) CAT 3054E , 2012		Air Filter Primary.....	A-56731	Air Filter Set.....	A-56731-S
Air Filter Primary.....	A-56731	Air Filter Secondary.....	A-56741	TH460B (HANDLER TELESCOPIC) CAT (S/N: CRX1-106)	
Air Filter Set.....	A-56731-S	TH355B (HANDLER TELESCOPIC) CAT CRX4387-UP		Oil Filter Full Flow.....	C-5102
Air Filter Secondary.....	A-56741	Air Filter Primary.....	A-56731	TH460B (HANDLER TELESCOPIC) CAT C4.4 (S/N: SLF1-00791-UP)	
TH340B (HANDLER TELESCOPIC) CAT 3054CRX648-UP , 2011		Air Filter Secondary.....	A-56741	Air Filter Primary.....	A-5673
Air Filter Set.....	A-56731-S	Air Filter Set.....	A-56731-S	Air Filter Set.....	A-5675-S
Air Filter Secondary.....	A-56741	TH355B (HANDLER TELESCOPIC) w/3054E Eng.		Air Filter Secondary.....	A-8670
Air Filter Primary.....	A-56731	Fuel/Water Separator.....	SFC-43040	Hydraulic Oil Filter.....	HC-5504
TH340B (HANDLER TELESCOPIC) CAT 3054 (S/N: SLC1-UP) , 2004-UP		TH360B (HANDLER TELESCOPIC) CAT 3054E , 2012		Oil Filter Full Flow.....	C-5102
Air Filter Set.....	A-5675-S	Air Filter Primary.....	A-56731	TH460B (HANDLER TELESCOPIC) w/3054E Eng.	
Air Filter Primary.....	A-5673	Air Filter Set.....	A-56731-S	Fuel/Water Separator.....	SFC-43040
Air Filter Secondary.....	A-8670	Air Filter Secondary.....	A-56741	TH406 (HANDLER TELESCOPIC) CAT C4.4 , 2008-UP	
Hydraulic Oil Filter.....	HC-5504	Air Filter Primary.....	A-56731	Oil Filter Full Flow.....	C-5102
Oil Filter Full Flow.....	C-5102	TH360B (HANDLER TELESCOPIC) CAT 7BJ1-UP , 2011		TH407 (HANDLER TELESCOPIC) CAT C4.4 , 2008-UP	
TH340B (HANDLER TELESCOPIC) w/3054E Eng.		Air Filter Set.....	A-56731-S	Oil Filter Full Flow.....	C-5102
Fuel/Water Separator.....	SFC-43040	Air Filter Secondary.....	A-56741	TH407C (HANDLER TELESCOPIC) CAT C3.4	
TH350B (HANDLER TELESCOPIC) S/N: SLD1-00531-UP		Air Filter Primary.....	A-56731	Fuel/Water Separator.....	SFC-55241
Air Filter Secondary.....	A-8670	Air Filter Set.....	A-5675-S	Fuel/Water Separator.....	SFC-55240
Air Filter Primary.....	A-5673	Hydraulic Oil Filter.....	HC-5504	TH560B (HANDLER TELESCOPIC) CAT 3054E , 2012	
Air Filter Set.....	A-5675-S	Oil Filter Full Flow.....	C-5102	Air Filter Primary.....	A-56731
Hydraulic Oil Filter.....	HC-5504	TH360B (HANDLER TELESCOPIC) S/N: SLE1-01250-UP		Air Filter Secondary.....	A-56741
Oil Filter Full Flow.....	C-5102	Air Filter Secondary.....	A-8670	Air Filter Set.....	A-56731-S
TH340B (HANDLER TELESCOPIC) w/3054E Eng.		Air Filter Primary.....	A-5673	TH560B (HANDLER TELESCOPIC) CAT 3056E (S/N: TRA1-UP)	
Fuel/Water Separator.....	SFC-43040	Air Filter Set.....	A-5675-S	Air Filter Primary.....	A-5549M
TH350B (HANDLER TELESCOPIC) CATERPILLAR		Hydraulic Oil Filter.....	HC-5504	Air Filter Secondary.....	A-5550
Air Filter Primary.....	A-5673	Oil Filter Full Flow.....	C-5102	Air Filter Primary.....	A-5549
Air Filter Set.....	A-5675-S	TH360B (HANDLER TELESCOPIC) S/N: SLE1-01250-UP		TH560B (HANDLER TELESCOPIC) CAT 3056E (S/N: TRA1-UP)	
Air Filter Secondary.....	A-8670	Air Filter Secondary.....	A-8670	Air Filter Primary.....	A-5549M
TH355B (HANDLER TELESCOPIC) CATERPILLAR		Air Filter Primary.....	A-5673	Air Filter Secondary.....	A-5550
Air Filter Primary.....	A-5673	Air Filter Set.....	A-56731-S	Air Filter Primary.....	A-5549
Air Filter Set.....	A-5675-S	Air Filter Secondary.....	A-56741	TH330B (HANDLER TELESCOPIC) CAT 3054 (S/N: SLB1-UP) , 2004-UP	
Air Filter Secondary.....	A-8670	TH330B (HANDLER TELESCOPIC) CAT 3054 (S/N: SLB1-UP) , 2004-UP		Air Filter Secondary.....	A-8670
TH355B (HANDLER TELESCOPIC) CATERPILLAR		Air Filter Primary.....	A-5673	Air Filter Primary.....	A-8670
Air Filter Primary.....	A-5673	Air Filter Set.....	A-56731-S	TH330B (HANDLER TELESCOPIC) CAT 3054 (S/N: SLB1-UP) , 2004-UP	
Air Filter Set.....	A-5675-S	Air Filter Secondary.....	A-56741	Air Filter Secondary.....	A-8670
Air Filter Secondary.....	A-8670	TH330B (HANDLER TELESCOPIC) CAT 3054 (S/N: SLB1-UP) , 2004-UP		Air Filter Primary.....	A-5673

MODEL/APPLICATION	SAKURA NO
CATERPILLAR	
TH560B (HANDLER TELESCOPIC) CAT 3056E (S/N: TR11-UP)	
Air Filter Set.....	A-5549M-S
Hydraulic Oil Filter.....	HC-5801
TH560B (HANDLER TELESCOPIC) CAT CRX107-UP	
Air Filter Set.....	A-56731-S
Air Filter Primary.....	A-56731
Air Filter Secondary.....	A-56741
TH560B (HANDLER TELESCOPIC) CAT CRX207-UP	
Air Filter Set.....	A-56731-S
Air Filter Secondary.....	A-56741
Air Filter Primary.....	A-56731
TH560B (HANDLER TELESCOPIC) S/N: SLG1-UP	
Air Filter Primary.....	A-5673
Air Filter Set.....	A-5675-S
Air Filter Secondary.....	A-8670
Hydraulic Oil Filter.....	HC-5504
Oil Filter Full Flow.....	C-5102
TH560B (HANDLER TELESCOPIC) w/3054E Eng.	
Fuel/Water Separator.....	SFC-43040
TH580B (HANDLER TELESCOPIC) CAT S/N: CRX107-647-UP , 2004-UP	
Air Filter Primary.....	A-5673
Air Filter Secondary.....	A-8670
Air Filter Set.....	A-5675-S
Hydraulic Oil Filter.....	HC-5504
Oil Filter Full Flow.....	C-5102
TH580B (HANDLER TELESCOPIC) CAT S/N: CRX1-106-UP , 2004-UP	
Air Filter Secondary.....	A-8670
Air Filter Primary.....	A-5673
Air Filter Set.....	A-5675-S
Hydraulic Oil Filter.....	HC-5504
Oil Filter Full Flow.....	C-5102
TH580B (HANDLER TELESCOPIC) CAT S/N: CRX1-206-UP , 2004-UP	
Air Filter Secondary.....	A-8670
Air Filter Set.....	A-5675-S
Hydraulic Oil Filter.....	HC-5504
Oil Filter Full Flow.....	C-5102
TH580B (HANDLER TELESCOPIC) CAT S/N: CRX207-647-UP , 2004-UP	
Air Filter Set.....	A-5675-S
Air Filter Primary.....	A-5673
Air Filter Secondary.....	A-8670
Hydraulic Oil Filter.....	HC-5504
Oil Filter Full Flow.....	C-5102
TH580B (HANDLER TELESCOPIC) CAT S/N: CRX648-UP , 2004-UP	
Air Filter Set.....	A-5675-S
Air Filter Secondary.....	A-8670
Air Filter Primary.....	A-5673
Hydraulic Oil Filter.....	HC-5504
Oil Filter Full Flow.....	C-5102

MODEL/APPLICATION	SAKURA NO
CATERPILLAR	
Hydraulic Oil Filter.....	HC-5504
Oil Filter Full Flow.....	C-5102
TH580B (HANDLER TELESCOPIC) CAT S/N: SLG1-UP , 2004-UP	
Air Filter Set.....	A-5675-S
Air Filter Primary.....	A-5673
Air Filter Secondary.....	A-8670
Hydraulic Oil Filter.....	HC-5504
Oil Filter Full Flow.....	C-5102
TH580B (HANDLER TELESCOPIC) CAT S/N: SLH1-UP , 2004-UP	
Air Filter Secondary.....	A-8670
Air Filter Set.....	A-5675-S
Air Filter Primary.....	A-5673
Hydraulic Oil Filter.....	HC-5504
Oil Filter Full Flow.....	C-5102
TH580B (HANDLER TELESCOPIC) CAT CRX648-UP , 2004	
Air Filter Secondary.....	A-56741
Air Filter Set.....	A-56731-S
Air Filter Primary.....	A-56731
TH580B (HANDLER TELESCOPIC) CAT CRX107-UP	
Air Filter Secondary.....	A-56741
Air Filter Primary.....	A-56731
Air Filter Set.....	A-56731-S
TH580B (HANDLER TELESCOPIC) CAT CRX1-106	
Air Filter Set.....	A-56731-S
Air Filter Secondary.....	A-56741
Air Filter Primary.....	A-56731
TH580B (HANDLER TELESCOPIC) CAT CRX1-206	
Air Filter Primary.....	A-56731
Air Filter Set.....	A-56731-S
Air Filter Secondary.....	A-56741
TH580B (HANDLER TELESCOPIC) CAT CRX207-UP	
Air Filter Set.....	A-56731-S
Air Filter Secondary.....	A-56741
Air Filter Primary.....	A-56731
TH580B (HANDLER TELESCOPIC) w/3054E Eng.	
Fuel/Water Separator.....	SFC-43040
TH62 (HANDLER TELESCOPIC) CAT 7B31-UP , 2011	
Air Filter Secondary.....	A-56741
Air Filter Set.....	A-56731-S
Air Filter Primary.....	A-56731
TH62 (HANDLER TELESCOPIC) S/N: 3LN1-UP	
Air Filter Secondary.....	A-5540
Air Filter Set.....	A-5541M-S
Air Filter Primary.....	A-5541
Air Filter Primary.....	A-76231
Air Filter Primary.....	A-5541M
Hydraulic Oil Filter.....	HC-5512

MODEL/APPLICATION	SAKURA NO
CATERPILLAR	
Hydraulic Oil Filter.....	HC-5506
Oil Filter Full Flow.....	C-5102
TH62 (HANDLER TELESCOPIC) S/N: 4TM1-UP	
Air Filter Primary.....	A-5541
Air Filter Primary.....	A-5541M
Air Filter Secondary.....	A-5540
Air Filter Set.....	A-5541M-S
Air Filter Primary.....	A-76231
Hydraulic Oil Filter.....	HC-5506
Hydraulic Oil Filter.....	HC-5512
Oil Filter Full Flow.....	C-5102
TH63 (HANDLER TELESCOPIC) CAT 7BJ1-UP	
Air Filter Primary.....	A-56731
Air Filter Set.....	A-56731-S
Air Filter Secondary.....	A-56741
TH63 (HANDLER TELESCOPIC) S/N: 5WM-06021-99999-UP	
Air Filter Secondary.....	A-5540
Hydraulic Oil Filter.....	HC-5512
Oil Filter Full Flow.....	C-5102
TH63 EN (HANDLER TELESCOPIC) S/N: 3KN1-UP	
Air Filter Secondary.....	A-5540
Oil Filter Full Flow.....	C-5102
TH63 EN (HANDLER TELESCOPIC) S/N: 3NN1-UP	
Air Filter Secondary.....	A-5540
Oil Filter Full Flow.....	C-5102
TH82 (HANDLER TELESCOPIC) CAT 7BJ1-UP	
Air Filter Primary.....	A-56731
Air Filter Set.....	A-56731-S
Air Filter Secondary.....	A-56741
TH82 (HANDLER TELESCOPIC) S/N: 3JN-01510-99999-UP	
Air Filter Secondary.....	A-5540
Hydraulic Oil Filter.....	HC-5512
Oil Filter Full Flow.....	C-5102
TH83 (HANDLER TELESCOPIC) CAT 7BJ1-UP	
Air Filter Set.....	A-56731-S
Air Filter Secondary.....	A-56741
Air Filter Primary.....	A-56731
TH82 EN (HANDLER TELESCOPIC) S/N: 3KN1-UP	
Air Filter Secondary.....	A-5540
Hydraulic Oil Filter.....	HC-5503
Hydraulic Oil Filter.....	HC-5506
Oil Filter Full Flow.....	C-5102
TH82 EN (HANDLER TELESCOPIC) S/N: 3NN1-UP	
Air Filter Secondary.....	A-5540
Hydraulic Oil Filter.....	HC-5503
Hydraulic Oil Filter.....	HC-5506
Oil Filter Full Flow.....	C-5102

MODEL/APPLICATION	SAKURA NO
CATERPILLAR	
TH83 EN (HANDLER TELESCOPIC) S/N: 3KN1-UP	
Air Filter Secondary.....	A-5540
Oil Filter Full Flow.....	C-5102
TH83 EN (HANDLER TELESCOPIC) S/N: 3NN1-UP	
Air Filter Secondary.....	A-5540
Oil Filter Full Flow.....	C-5102
TK1051 (FELLER BUNCHERS) CAT S/N: 3PD1-UP	
Air Filter Primary.....	A-8665M
Air Filter Secondary.....	A-8580
Fuel Filter.....	FC-5517
Fuel/Water Separator Secondary..	SFC-5504-10B
Fuel/Water Separator Secondary..	SFC-5504-10
Hydraulic Oil Filter.....	HC-55170
Hydraulic Oil Filter.....	HC-5801
Hydraulic Oil Filter.....	HC-5505
Oil Filter Full Flow.....	C-5516
TK1051 (FELLER BUNCHERS) CAT S/N: 9HZ1-UP	
Air Filter Primary.....	A-8665M
Air Filter Secondary.....	A-8580
Fuel Filter.....	FC-5517
Fuel/Water Separator Secondary..	SFC-5504-10
Fuel/Water Separator Secondary..	SFC-5504-10B
Hydraulic Oil Filter.....	HC-5801
Hydraulic Oil Filter.....	HC-55170
Hydraulic Oil Filter.....	HC-5505
Oil Filter Full Flow.....	C-5516
TK370 (FELLER BUNCHERS) CAT 3126 (S/N: WBD1-UP)	
Air Filter Primary.....	A-5558
Air Filter Secondary.....	A-5559
Fuel Filter Secondary.....	FC-55151
Fuel Filter.....	FC-5516
Fuel Filter.....	FC-5508
Fuel Filter Secondary.....	FC-5515
Hydraulic Oil Filter.....	HC-55300
Oil Filter Full Flow.....	C-5510
TK371 (FELLER BUNCHERS) CAT S/N: 55K12201-UP	
Air Filter Secondary.....	A-5559
Air Filter Primary.....	A-5558
Fuel Filter.....	FC-5508
Fuel Filter Secondary.....	FC-5515
Fuel Filter Secondary.....	FC-55151
Fuel Filter.....	FC-5516
Hydraulic Oil Filter.....	HC-5504
Hydraulic Oil Filter.....	HC-55300
Oil Filter Full Flow.....	C-5522
TK371 (FELLER BUNCHERS) CAT S/N: WBG1-UP	
Air Filter Primary.....	A-5558
Air Filter Secondary.....	A-5559
Fuel Filter Secondary.....	FC-5515
Fuel Filter Secondary.....	FC-55151
Fuel Filter.....	FC-5516

MODEL/APPLICATION	SAKURA NO
CATERPILLAR	
Fuel Filter.....	FC-5508
Hydraulic Oil Filter.....	HC-5504
Hydraulic Oil Filter.....	HC-55300
Oil Filter Full Flow.....	C-5522
TK381 (FELLER BUNCHERS) CAT S/N: 55K12115-UP	
Air Filter Secondary.....	A-5559
Air Filter Primary.....	A-5558
Fuel Filter Secondary.....	FC-5515
Fuel Filter.....	FC-5516
Fuel Filter Secondary.....	FC-55151
Fuel Filter.....	FC-5508
Hydraulic Oil Filter.....	HC-55300
Hydraulic Oil Filter.....	HC-5504
Oil Filter Full Flow.....	C-5522
TK381 (FELLER BUNCHERS) CAT S/N: WBH1-UP	
Air Filter Primary.....	A-5558
Air Filter Secondary.....	A-5559
Fuel Filter Secondary.....	FC-5515
Fuel Filter Secondary.....	FC-55151
Fuel Filter.....	FC-5516
Fuel Filter.....	FC-5508
Hydraulic Oil Filter.....	HC-5504
Hydraulic Oil Filter.....	HC-55300
Oil Filter Full Flow.....	C-5522
TK711 (FELLER BUNCHERS) CAT C9 (S/N: 101-1-UP)	
Air Filter Secondary.....	A-8651
Fuel Filter.....	FC-5517
Hydraulic Oil Filter.....	H-5509
Hydraulic Oil Filter.....	HC-5801
Hydraulic Oil Filter.....	HC-55170
Oil Filter Full Flow.....	C-5516
TK741 (FELLER BUNCHERS) CAT (S/N: THX1-UP)	
Fuel Filter.....	FC-5517
TK741 (FELLER BUNCHERS) S/N: 2021-224-UP	
Air Filter Secondary.....	A-8651
Hydraulic Oil Filter.....	HC-55170
Hydraulic Oil Filter.....	HC-5801
Hydraulic Oil Filter.....	H-5509
TK741 (FELLER BUNCHERS) S/N: 202225-UP	
Air Filter.....	A-5584
Air Filter Secondary.....	A-8651
Hydraulic Oil Filter.....	HC-5801
Hydraulic Oil Filter.....	H-5509
Hydraulic Oil Filter.....	HC-55170
TK751 (FELLER BUNCHERS) S/N: 3011-324-UP	
Air Filter Secondary.....	A-8651
Fuel Filter.....	FC-5517
Hydraulic Oil Filter.....	H-5509
Hydraulic Oil Filter.....	HC-5801
Hydraulic Oil Filter.....	HC-55170

MODEL/APPLICATION	SAKURA NO
CATERPILLAR	
TK751 (FELLER BUNCHERS) S/N: 301325-UP	
Air Filter Secondary.....	A-8651
Air Filter.....	A-5584
Fuel Filter.....	FC-5517
Hydraulic Oil Filter.....	HC-55170
Hydraulic Oil Filter.....	H-5509
Hydraulic Oil Filter.....	HC-5801
TK751 (FELLER BUNCHERS) S/N: 3021-424-UP	
Air Filter Secondary.....	A-8651
Fuel Filter.....	FC-5517
Hydraulic Oil Filter.....	H-5509
Hydraulic Oil Filter.....	HC-5801
Hydraulic Oil Filter.....	HC-55170
TK751 (FELLER BUNCHERS) S/N: 302425-UP	
Air Filter Secondary.....	A-8651
Air Filter.....	A-5584
Fuel Filter.....	FC-5517
Hydraulic Oil Filter.....	HC-5801
Hydraulic Oil Filter.....	HC-55170
Hydraulic Oil Filter.....	H-5509
TL1055C (HANDLER TELESCOPIC) CAT C4.4	
Fuel/Water Separator.....	SFC-55241
Fuel/Water Separator.....	SFC-55240
TL642C (HANDLER TELESCOPIC) CAT C3.4	
Fuel/Water Separator.....	SFC-55240
Fuel/Water Separator.....	SFC-55241
TR225B (ROAD RECLAIMER) S/N: 6WC1-UP	
Air Filter Primary.....	A-6113
Fuel Filter Secondary.....	FC-5507
Oil Filter Full Flow.....	C-5519
TR500 (ROAD RECLAIMER) S/N: 8CC1-UP	
Air Filter.....	A-85410
Air Filter.....	A-5553
Fuel Filter.....	FC-5502
Fuel Filter Secondary.....	FC-5507
Oil Filter Full Flow.....	C-5519
V100F-VC110F (FORKLIFTS) PERKINS 4.236 (S/N: 6LG-UP)	
Air Filter Secondary.....	A-5576
Air Filter Primary.....	A-5577
Air Filter Set.....	A-5578-S
Air Filter Set.....	A-5579-S
Hydraulic Oil Filter Transmission...	HC-5501
V100F-VC110F (FORKLIFTS) PERKINS 4.236 GAS (S/N: 6LG-UP)	
Air Filter Set.....	A-5578-S
Air Filter Set.....	A-5579-S
Air Filter Primary.....	A-5577
Air Filter Secondary.....	A-5576
Hydraulic Oil Filter Transmission...	HC-5501

MODEL/APPLICATION	SAKURA NO	MODEL/APPLICATION	SAKURA NO	MODEL/APPLICATION	SAKURA NO
CATERPILLAR		CATERPILLAR		CATERPILLAR	
V100F-VC110F (FORKLIFTS) PERKINS 4.2482 DIESEL (S/N: 1FK-UP) Air Filter Set..... A-5578-S Air Filter Secondary..... A-5576 Air Filter Set..... A-5579-S Air Filter Primary..... A-5577 Fuel Filter..... FC-5103 Hydraulic Oil Filter Transmission... HC-5501		V110B-V155B (FORKLIFTS) PERKINS 4.236 DIESEL (S/N: 3WG-UP) Air Filter Secondary..... A-5576 Air Filter Set..... A-5579-S Air Filter Primary..... A-5577 Air Filter Set..... A-5578-S Fuel Filter..... FC-5103 Hydraulic Oil Filter..... H-5517		Air Filter Primary..... A-6211 Fuel Filter..... FC-5103 V180B (FORKLIFTS) CAT 3208 Air Filter Secondary..... A-5510 Air Filter Set..... A-5522-S Air Filter Primary..... A-5509 Oil Filter Full Flow..... C-5505 Oil Filter Full Flow..... C-5519 Oil Filter Full Flow..... C-5504	
V100-V150 (FORKLIFTS) PERKINS 4.236 DIESEL (S/N: 55D-UP) Air Filter Primary..... A-5577 Air Filter Secondary..... A-5576 Air Filter Set..... A-5578-S Air Filter Set..... A-5579-S Fuel Filter..... FC-5103		V160B-V200B (FORKLIFTS) CAT 3208 (S/N: 67Y-UP) Air Filter Set..... A-5507-S Air Filter Set..... A-55071-S Air Filter..... A-5530 Air Filter Primary..... A-5507 Hydraulic Oil Filter..... H-5517 Oil Filter Full Flow..... C-5504 Oil Filter Full Flow..... C-5505 Oil Filter Full Flow..... C-5519		V180B (FORKLIFTS) CAT 3208 (S/N: 68Y00292-UP) Air Filter Secondary..... A-5510 Air Filter Set..... A-5522-S Air Filter Primary..... A-5509 Oil Filter Full Flow..... C-5505 Oil Filter Full Flow..... C-5504 Oil Filter Full Flow..... C-5519	
V100-V150 (FORKLIFTS) PERKINS 4.236 DIESEL (S/N: 60D-UP) Air Filter Primary..... A-5577 Air Filter Secondary..... A-5576 Air Filter Set..... A-5579-S Air Filter Set..... A-5578-S Fuel Filter..... FC-5103		V160B-V200B (FORKLIFTS) CAT 3208 (S/N: 84Y-UP) Air Filter Set..... A-55071-S Air Filter Primary..... A-5507 Air Filter Set..... A-5507-S Air Filter..... A-5530 Hydraulic Oil Filter..... H-5504 Oil Filter Full Flow..... C-5519 Oil Filter Full Flow..... C-5504 Oil Filter Full Flow..... C-5505		V200B-V225B (FORKLIFTS) CAT 3208 (S/N: 1DK-UP) Air Filter Set..... A-55071-S Air Filter Set..... A-5507-S Air Filter Primary..... A-5507 Air Filter..... A-5530 Fuel Filter..... FC-5103 Oil Filter Full Flow..... C-5504 Oil Filter Full Flow..... C-5505 Oil Filter Full Flow..... C-5519	
V100-V150 (FORKLIFTS) PERKINS 4.236 DIESEL (S/N: 8EF-UP) Air Filter Secondary..... A-5576 Air Filter Primary..... A-5577 Air Filter Set..... A-5578-S Air Filter Set..... A-5579-S Fuel Filter..... FC-5103 Hydraulic Oil Filter..... H-5517 Hydraulic Oil Filter Transmission... HC-5501		V160B-V200B (FORKLIFTS) CAT 3208 (S/N: 9AF-UP) Air Filter Primary..... A-5507 Air Filter Set..... A-55071-S Air Filter..... A-5530 Air Filter Set..... A-5507-S Hydraulic Oil Filter..... H-5504 Hydraulic Oil Filter..... H-5517 Oil Filter Full Flow..... C-5505 Oil Filter Full Flow..... C-5504 Oil Filter Full Flow..... C-5519		V200B-V225B (FORKLIFTS) CAT 3208 (S/N: 69Y-UP) Air Filter Set..... A-5507-S Air Filter..... A-5530 Air Filter Primary..... A-5507 Air Filter Set..... A-55071-S Hydraulic Oil Filter..... H-5517 Oil Filter Full Flow..... C-5504 Oil Filter Full Flow..... C-5505 Oil Filter Full Flow..... C-5519	
V100-V150 (FORKLIFTS) PERKINS 4.236 GAS (S/N: 59W-UP) Air Filter Set..... A-5579-S Air Filter Secondary..... A-5576 Air Filter Set..... A-5578-S Air Filter Primary..... A-5577 Hydraulic Oil Filter..... H-5517		V160B-V200B (FORKLIFTS) CAT 3208 (S/N: 9AF-UP) Air Filter Primary..... A-5507 Air Filter Set..... A-55071-S Air Filter..... A-5530 Air Filter Set..... A-5507-S Hydraulic Oil Filter..... H-5504 Hydraulic Oil Filter..... H-5517 Oil Filter Full Flow..... C-5505 Oil Filter Full Flow..... C-5504 Oil Filter Full Flow..... C-5519		V200B-V225B (FORKLIFTS) CAT 3208 (S/N: 85Y-UP) Air Filter Primary..... A-5507 Air Filter..... A-5530 Air Filter Set..... A-5507-S Air Filter Set..... A-55071-S Hydraulic Oil Filter..... H-5504 Oil Filter Full Flow..... C-5505 Oil Filter Full Flow..... C-5504 Oil Filter Full Flow..... C-5519	
V100-V150 (FORKLIFTS) PERKINS 4.236 GAS (S/N: 60W-UP) Air Filter Secondary..... A-5576 Air Filter Set..... A-5579-S Air Filter Set..... A-5578-S Air Filter Primary..... A-5577 Hydraulic Oil Filter Transmission... HC-5501 Hydraulic Oil Filter..... H-5517		V160-V180 (FORKLIFTS) CAT 3145 (S/N: 16V-UP) Oil Filter Full Flow..... C-5504		V200B-V225B (FORKLIFTS) CAT 3145 (S/N: 20V-UP) Oil Filter Full Flow..... C-5504	
V100-V150 (FORKLIFTS) PERKINS 4.236 GAS (S/N: 60W-UP) Air Filter Secondary..... A-5576 Air Filter Set..... A-5579-S Air Filter Set..... A-5578-S Air Filter Primary..... A-5577 Hydraulic Oil Filter Transmission... HC-5501 Hydraulic Oil Filter..... H-5517		V160-V180 (FORKLIFTS) CAT 3145 (S/N: 17V-UP) Oil Filter Full Flow..... C-5504		V200B-V225B (FORKLIFTS) CAT 3145 (S/N: 21V-UP) Oil Filter Full Flow..... C-5504	
V1100 CTH (FORKLIFTS) CAT 3208DSL (S/N: 6BF-UP) Air Filter..... A-5530 Air Filter Set..... A-5507-S Air Filter Primary..... A-5507 Air Filter Set..... A-55071-S Hydraulic Oil Filter..... H-5517 Hydraulic Oil Filter..... H-5504 Oil Filter Full Flow..... C-5504 Oil Filter Full Flow..... C-5519 Oil Filter Full Flow..... C-5505		V160-V180 (FORKLIFTS) CAT DIESEL (S/N: 16V-UP) Oil Filter Full Flow..... C-5504		V200-V225 (FORKLIFTS) CAT 3145 (S/N: 20V-UP) Oil Filter Full Flow..... C-5504	
V1100 CTH (FORKLIFTS) CAT 3208DSL (S/N: 6BF-UP) Air Filter..... A-5530 Air Filter Set..... A-5507-S Air Filter Primary..... A-5507 Air Filter Set..... A-55071-S Hydraulic Oil Filter..... H-5517 Hydraulic Oil Filter..... H-5504 Oil Filter Full Flow..... C-5504 Oil Filter Full Flow..... C-5519 Oil Filter Full Flow..... C-5505		V160-V180 (FORKLIFTS) PERKINS 6.354 (S/N: 18W-UP) Air Filter Primary..... A-6211 Fuel Filter..... FC-5103		V200-V225 (FORKLIFTS) CAT DIESEL (S/N: 20V-UP) Oil Filter Full Flow..... C-5504	
V1100 CTH (FORKLIFTS) CAT 3208DSL (S/N: 6BF-UP) Air Filter..... A-5530 Air Filter Set..... A-5507-S Air Filter Primary..... A-5507 Air Filter Set..... A-55071-S Hydraulic Oil Filter..... H-5517 Hydraulic Oil Filter..... H-5504 Oil Filter Full Flow..... C-5504 Oil Filter Full Flow..... C-5519 Oil Filter Full Flow..... C-5505		V160-V180 (FORKLIFTS) PERKINS 6.354 (S/N: 63D-UP)			

Sakura Filter

ENGINE APPLICATION

MODEL/APPLICATION	SAKURA NO	MODEL/APPLICATION	SAKURA NO	MODEL/APPLICATION	SAKURA NO
CATERPILLAR		CATERPILLAR		CATERPILLAR	
V200-V225 (<i>FORKLIFTS</i>) CAT DIESEL (S/N: 21V-UP)		Oil Filter Full Flow.....	C-1005	V30B-V60B (<i>FORKLIFTS</i>) CONTINEL F-163 GAS (S/N: TO-32N00445)	
Oil Filter Full Flow.....	C-5504	V25D-VC40D (<i>FORKLIFTS</i>) PEUGEOT XN1P (S/N: 5HB-UP)		Hydraulic Oil Filter.....	H-79411
V200-V225 (<i>FORKLIFTS</i>) PERKINS 6.354 (S/N: 62E-UP)		Hydraulic Oil Filter Transmission...	HC-5501	V30B-V60B (<i>FORKLIFTS</i>) CONTINEL F-163 GAS (S/N: TO-33N00531)	
Air Filter Primary.....	A-6211	Oil Filter Full Flow.....	C-1005	Hydraulic Oil Filter.....	H-79411
Fuel Filter.....	FC-5103	V25D-VC40D (<i>FORKLIFTS</i>) PEUGEOT XN1P GAS (S/N: 5HB-UP)		V30B-V60B (<i>FORKLIFTS</i>) CONTINEL F-163 GAS (S/N: TO-79M00948)	
V200-V225 (<i>FORKLIFTS</i>) PERKINS 6.354 DIESEL (S/N: 63E-UP)		Hydraulic Oil Filter Transmission...	HC-5501	Hydraulic Oil Filter.....	H-79411
Air Filter Primary.....	A-6211	Oil Filter Full Flow.....	C-1005	V30B-V60B (<i>FORKLIFTS</i>) CONTINEL F-227 (S/N: 37N00462-37N00563)	
Fuel Filter.....	FC-5103	V30B-V60B (<i>FORKLIFTS</i>) CONTINEL F-163 (S/N: 32N00446-UP)		Hydraulic Oil Filter.....	H-79411
V250B-V330B (<i>FORKLIFTS</i>) CAT 3208 (S/N: 71Y-UP)		Hydraulic Oil Filter.....	H-79411	V30B-V60B (<i>FORKLIFTS</i>) CONTINEL F-227 (S/N: 84M-84M)	
Air Filter.....	A-5530	V30B-V60B (<i>FORKLIFTS</i>) CONTINEL F-163 (S/N: 33N00532-UP)		Hydraulic Oil Filter.....	H-79411
Air Filter Set.....	A-5507-S	Hydraulic Oil Filter.....	H-79411	V30B-V60B (<i>FORKLIFTS</i>) CONTINEL F-227 (S/N: 89M00641-89M00942)	
Air Filter Set.....	A-55071-S	V30B-V60B (<i>FORKLIFTS</i>) CONTINEL F-163 (S/N: 79M00949-UP)		Hydraulic Oil Filter.....	H-79411
Air Filter Primary.....	A-5507	Hydraulic Oil Filter.....	H-79411	V30B-V60B (<i>FORKLIFTS</i>) CONTINEL F-227 (S/N: 89M00641-89M00942)	
Hydraulic Oil Filter.....	H-5517	V30B-V60B (<i>FORKLIFTS</i>) CONTINEL F-163 (S/N: 81M00788-81M01316)		Hydraulic Oil Filter.....	H-79411
Oil Filter Full Flow.....	C-5505	Hydraulic Oil Filter.....	H-79411	V30B-V60B (<i>FORKLIFTS</i>) CONTINEL F-227 (S/N: TO-36N00427)	
Oil Filter Full Flow.....	C-5504	V30B-V60B (<i>FORKLIFTS</i>) CONTINEL F-163 (S/N: 81M01317-81M02459)		Hydraulic Oil Filter.....	H-79411
Oil Filter Full Flow.....	C-5519	Hydraulic Oil Filter.....	H-79411	V30B-V60B (<i>FORKLIFTS</i>) CONTINEL F-227 (S/N: TO-87M00736)	
V250B-V330B (<i>FORKLIFTS</i>) CAT 3208 (S/N: 86Y-UP)		V30B-V60B (<i>FORKLIFTS</i>) CONTINEL F-163 (S/N: 81M01317-81M02459)		Hydraulic Oil Filter.....	H-79411
Air Filter Primary.....	A-5507	Hydraulic Oil Filter.....	H-79411	V30B-V60B (<i>FORKLIFTS</i>) CONTINEL F-227 (S/N: TO-87M00736)	
Air Filter Set.....	A-5507-S	V30B-V60B (<i>FORKLIFTS</i>) CONTINEL F-163 (S/N: TO-32N00445)		Hydraulic Oil Filter.....	H-79411
Air Filter.....	A-5530	Hydraulic Oil Filter.....	H-79411	V30B-V60B (<i>FORKLIFTS</i>) CONTINEL F-227 GAS (S/N: 35N00474-UP)	
Air Filter Set.....	A-55071-S	V30B-V60B (<i>FORKLIFTS</i>) CONTINEL F-163 (S/N: TO-33N00531)		Hydraulic Oil Filter.....	H-79411
Hydraulic Oil Filter.....	H-5517	Hydraulic Oil Filter.....	H-79411	V30B-V60B (<i>FORKLIFTS</i>) CONTINEL F-227 GAS (S/N: 36N00428-36N00473)	
Hydraulic Oil Filter.....	H-5504	V30B-V60B (<i>FORKLIFTS</i>) CONTINEL F-163 (S/N: TO-36N00427)		Hydraulic Oil Filter.....	H-79411
Oil Filter Full Flow.....	C-5504	Hydraulic Oil Filter.....	H-79411	V30B-V60B (<i>FORKLIFTS</i>) CONTINEL F-227 GAS (S/N: 37N00564-37N00662)	
Oil Filter Full Flow.....	C-5505	V30B-V60B (<i>FORKLIFTS</i>) CONTINEL F-163 (S/N: TO-79M00948)		Hydraulic Oil Filter.....	H-79411
Oil Filter Full Flow.....	C-5519	Hydraulic Oil Filter.....	H-79411	V30B-V60B (<i>FORKLIFTS</i>) CONTINEL F-227 GAS (S/N: 75P-75P)	
V250-V300 (<i>FORKLIFTS</i>) CAT 3145 (S/N: 24V-UP)		Hydraulic Oil Filter.....	H-79411	Hydraulic Oil Filter.....	H-79411
Oil Filter Full Flow.....	C-5504	V30B-V60B (<i>FORKLIFTS</i>) CONTINEL F-163 GAS (S/N: 32N00446-UP)		V30B-V60B (<i>FORKLIFTS</i>) CONTINEL F-227 GAS (S/N: 87M00764-UP)	
V250-V300 (<i>FORKLIFTS</i>) CAT 3145 (S/N: 25V-UP)		Hydraulic Oil Filter.....	H-79411	Hydraulic Oil Filter.....	H-79411
Oil Filter Full Flow.....	C-5504	V30B-V60B (<i>FORKLIFTS</i>) CONTINEL F-163 GAS (S/N: 32N00446-UP)		V30B-V60B (<i>FORKLIFTS</i>) CONTINEL F-227 GAS (S/N: 87M00764-UP)	
Oil Filter Full Flow.....	C-5504	Hydraulic Oil Filter.....	H-79411	Hydraulic Oil Filter.....	H-79411
V250-V300 (<i>FORKLIFTS</i>) CAT DIESEL (S/N: 24V-UP)		V30B-V60B (<i>FORKLIFTS</i>) CONTINEL F-163 GAS (S/N: 33N00532-UP)		V30B-V60B (<i>FORKLIFTS</i>) CONTINEL F-227 GAS (S/N: 89M00943-89M01751)	
Oil Filter Full Flow.....	C-5504	Hydraulic Oil Filter.....	H-79411	Hydraulic Oil Filter.....	H-79411
V250-V300 (<i>FORKLIFTS</i>) PERKINS 6.354 DIESEL (S/N: 10F-UP)		V30B-V60B (<i>FORKLIFTS</i>) CONTINEL F-163 GAS (S/N: 54R-54R)		V30B-V60B (<i>FORKLIFTS</i>) PERKINS 4.236 DIESEL (S/N: 52J00616-UP)	
Air Filter Primary.....	A-6211	Hydraulic Oil Filter.....	H-79411	Fuel Filter.....	FC-5103
Fuel Filter.....	FC-5103	V30B-V60B (<i>FORKLIFTS</i>) CONTINEL F-163 GAS (S/N: 79M00949-UP)		Hydraulic Oil Filter.....	H-79411
V250-V300 (<i>FORKLIFTS</i>) PERKINS 6.354 DIESEL (S/N: 98W-UP)		Hydraulic Oil Filter.....	H-79411	V30B-V60B (<i>FORKLIFTS</i>) PERKINS 4.236 DIESEL (S/N: 56R-56R)	
Air Filter Primary.....	A-6211	V30B-V60B (<i>FORKLIFTS</i>) CONTINEL F-163 GAS (S/N: 81M00788-81M01316)		Fuel Filter.....	FC-5103
Fuel Filter.....	FC-5103	Hydraulic Oil Filter.....	H-79411	V30B-V60B (<i>FORKLIFTS</i>) PERKINS 4.236 DIESEL (S/N: 77P-77P)	
V25D-VC40D (<i>FORKLIFTS</i>) PEUGEOT XD3P DIESEL (S/N: 5JB-UP)		V30B-V60B (<i>FORKLIFTS</i>) CONTINEL F-163 GAS (S/N: 81M01317-81M02459)		Fuel Filter.....	FC-5103
Fuel Filter.....	FC-5101	Hydraulic Oil Filter.....	H-79411	Hydraulic Oil Filter.....	H-79411
Hydraulic Oil Filter Transmission...	HC-5501				

MODEL/APPLICATION	SAKURA NO	MODEL/APPLICATION	SAKURA NO	MODEL/APPLICATION	SAKURA NO
CATERPILLAR		CATERPILLAR		CATERPILLAR	
V30B-V60B (FORKLIFTS) PERKINS 4.236 DIESEL (S/N: 83M00457-UP) Fuel Filter..... FC-5103 Hydraulic Oil Filter..... H-79411		V30C-VC60C (FORKLIFTS) CONTINEL F-227 GAS (S/N: 39U-UP) Air Filter Primary..... A-5577 Air Filter Set..... A-5579-S Air Filter Set..... A-5578-S Air Filter Secondary..... A-5576 Hydraulic Oil Filter Transmission... HC-5501		V30C-VC60C (FORKLIFTS) PERKINS 4.236 DIESEL (S/N: 43U-UP) Air Filter Set..... A-5579-S Air Filter Set..... A-5578-S Air Filter Primary..... A-5577 Air Filter Secondary..... A-5576 Fuel Filter..... FC-5103 Hydraulic Oil Filter..... H-79411	
V30B-V60B (FORKLIFTS) PERKINS 4.236 DIESEL (S/N: TO-52J00615) Fuel Filter..... FC-5103 Hydraulic Oil Filter..... H-79411		V30C-VC60C (FORKLIFTS) CONTINEL F-227 GAS (S/N: 45U-UP) Air Filter Primary..... A-5577 Air Filter Secondary..... A-5576 Air Filter Set..... A-5579-S Air Filter Set..... A-5578-S		V30C-VC60C (FORKLIFTS) PERKINS 4.236 DIESEL (S/N: 44Y-UP) Air Filter Primary..... A-5577 Air Filter Set..... A-5579-S Air Filter Secondary..... A-5576 Air Filter Set..... A-5578-S Fuel Filter..... FC-5103	
V30B-V60B (FORKLIFTS) PERKINS 4.236 DIESEL (S/N: TO-83M00456) Fuel Filter..... FC-5103 Hydraulic Oil Filter..... H-79411		V30C-VC60C (FORKLIFTS) CONTINEL F-227 GAS (S/N: 77U-UP) Air Filter Set..... A-5579-S Air Filter Secondary..... A-5576 Air Filter Primary..... A-5577 Air Filter Set..... A-5578-S Hydraulic Oil Filter..... H-79411		V30-V60 (FORKLIFTS) CONTINEL F-163 (S/N: 76M-UP) Hydraulic Oil Filter..... H-79411	
V30C-VC60C (FORKLIFTS) CAT 1404 GAS (S/N: 10U-UP) Air Filter Secondary..... A-5576 Air Filter Set..... A-5579-S Air Filter Primary..... A-5577 Air Filter Set..... A-5578-S Hydraulic Oil Filter Transmission... HC-5501 Oil Filter Full Flow..... C-5504		V30C-VC60C (FORKLIFTS) PERKINS 4.2032 DIESEL (S/N: 48Y-UP) Air Filter Secondary..... A-5576 Air Filter Set..... A-5578-S Air Filter Set..... A-5579-S Air Filter Primary..... A-5577 Air Filter Set..... A-5578-S Hydraulic Oil Filter..... H-79411		V30-V60 (FORKLIFTS) PERKINS 3.152 DIESEL (S/N: 57W-UP) Fuel Filter..... FC-5103 Hydraulic Oil Filter..... H-79411	
V30C-VC60C (FORKLIFTS) CAT 1404 GAS (S/N: 20R-UP) Air Filter Primary..... A-5577 Air Filter Set..... A-5579-S Air Filter Secondary..... A-5576 Air Filter Set..... A-5578-S Oil Filter Full Flow..... C-5504		V30C-VC60C (FORKLIFTS) PERKINS 4.2032 DIESEL (S/N: 58Y-UP) Air Filter Secondary..... A-5576 Air Filter Set..... A-5578-S Air Filter Set..... A-5579-S Air Filter Primary..... A-5577 Fuel Filter..... FC-5103 Hydraulic Oil Filter..... H-79411		V30-V60 (FORKLIFTS) PERKINS 3.152 DIESEL (S/N: 87Y-UP) Fuel Filter..... FC-5103	
V30C-VC60C (FORKLIFTS) CAT 1404 GAS (S/N: 45Y-UP) Air Filter Set..... A-5579-S Air Filter Set..... A-5578-S Air Filter Secondary..... A-5576 Air Filter Primary..... A-5577 Oil Filter Full Flow..... C-5504		V30C-VC60C (FORKLIFTS) PERKINS 4.2032 DIESEL (S/N: 59Y-UP) Air Filter Set..... A-5578-S Air Filter Secondary..... A-5576 Air Filter Primary..... A-5577 Air Filter Set..... A-5579-S Air Filter Set..... A-5579-S Fuel Filter..... FC-5103		V30 (FORKLIFTS) CONTINENTAL F163 Air Filter Primary..... A-70280	
V30C-VC60C (FORKLIFTS) CAT 1404 GAS (S/N: 75Y-UP) Air Filter Set..... A-5578-S Air Filter Secondary..... A-5576 Air Filter Primary..... A-5577 Air Filter Set..... A-5579-S Hydraulic Oil Filter..... H-79411 Oil Filter Full Flow..... C-5504		V30C-VC60C (FORKLIFTS) PERKINS 4.2032 DIESEL (S/N: 95W-UP) Air Filter Secondary..... A-5576 Air Filter Set..... A-5579-S Air Filter Set..... A-5578-S Air Filter Primary..... A-5577 Fuel Filter..... FC-5103 Hydraulic Oil Filter Transmission... HC-5501		V30 (FORKLIFTS) PERKINS 3.152 Air Filter Primary..... A-70270 Air Filter Primary..... A-70280	
V30C-VC60C (FORKLIFTS) CAT 1404 GAS (S/N: 96P-UP) Air Filter Primary..... A-5577 Air Filter Set..... A-5579-S Air Filter Secondary..... A-5576 Air Filter Set..... A-5578-S Hydraulic Oil Filter..... H-79411 Oil Filter Full Flow..... C-5504		V30C-VC60C (FORKLIFTS) PERKINS 4.236 DIESEL (S/N: 41U-UP) Air Filter Secondary..... A-5576 Air Filter Primary..... A-5577 Air Filter Set..... A-5578-S Air Filter Set..... A-5579-S Fuel Filter..... FC-5103 Hydraulic Oil Filter Transmission... HC-5501		V30B (FORKLIFTS) CONTINENTAL F163 Air Filter Primary..... A-70280 Air Filter Primary..... A-70270	
V30C-VC60C (FORKLIFTS) CONTINEL F-227 (S/N: 77U-UP) Air Filter Primary..... A-5577 Air Filter Set..... A-5578-S Air Filter Set..... A-5579-S Air Filter Secondary..... A-5576 Hydraulic Oil Filter..... H-79411 Oil Filter Full Flow..... C-5504		V30C-VC60C (FORKLIFTS) PERKINS 4.236 DIESEL (S/N: 95W-UP) Air Filter Secondary..... A-5576 Air Filter Primary..... A-5577 Air Filter Set..... A-5578-S Air Filter Set..... A-5579-S Fuel Filter..... FC-5103		V30B (FORKLIFTS) PERKINS 4.236 Air Filter Primary..... A-70280 Air Filter Primary..... A-70270	
				V30C (FORKLIFTS) PERKINS 4.236 Air Filter Primary..... A-70270 Air Filter Primary..... A-70280	
				V40D THRU VC60D SA (FORKLIFTS) CAT 1404 Air Filter Secondary..... A-5576 Air Filter Set..... A-5579-S Air Filter Primary..... A-5577 Air Filter Set..... A-5578-S Hydraulic Oil Filter Transmission... HC-5501 Oil Filter Full Flow..... C-5504	

MODEL/APPLICATION	SAKURA NO	MODEL/APPLICATION	SAKURA NO	MODEL/APPLICATION	SAKURA NO
CATERPILLAR		CATERPILLAR		CATERPILLAR	
V40D THRU VC60D SA (FORKLIFTS) PERKINS 4.2032		Air Filter Primary.....	A-5507	Air Filter Set.....	A-5578-S
Air Filter Secondary.....	A-5576	Hydraulic Oil Filter.....	H-5504	Air Filter Primary.....	A-5577
Air Filter Primary.....	A-5577	Hydraulic Oil Filter.....	H-5517	Air Filter Secondary.....	A-5576
Air Filter Set.....	A-5579-S	Oil Filter Full Flow.....	C-5519	Air Filter Set.....	A-5579-S
Air Filter Set.....	A-5578-S	Oil Filter Full Flow.....	C-5505	Fuel Filter.....	FC-5103
Fuel Filter.....	FC-5103	Oil Filter Full Flow.....	C-5504	V60E-V90E (FORKLIFTS) PERKINS 4.236 DIESEL (S/N: 88Y-UP)	
Hydraulic Oil Filter Transmission...	HC-5501	V550-V620 (FORKLIFTS) CAT 3208 (S/N: 95C-UP)		Air Filter Set.....	A-5578-S
Oil Filter Full Flow.....	C-5103	Air Filter.....	A-5530	Air Filter Primary.....	A-5577
V40D-VC60D (FORKLIFTS) CAT 1404 (S/N: 95B-UP)		Air Filter Set.....	A-55071-S	Air Filter Set.....	A-5579-S
Air Filter Secondary.....	A-5576	Air Filter Set.....	A-5507-S	Air Filter Secondary.....	A-5576
Air Filter Set.....	A-5578-S	Air Filter Primary.....	A-5507	Fuel Filter.....	FC-5103
Air Filter Primary.....	A-5577	Hydraulic Oil Filter.....	H-5504	V60E-V90E (FORKLIFTS) PERKINS 4.236 GAS (S/N: 74X-UP)	
Air Filter Set.....	A-5579-S	Hydraulic Oil Filter.....	H-5517	Air Filter Secondary.....	A-5576
Hydraulic Oil Filter Transmission...	HC-5501	Oil Filter Full Flow.....	C-5505	Air Filter Primary.....	A-5577
Oil Filter Full Flow.....	C-5504	Oil Filter Full Flow.....	C-5519	Air Filter Set.....	A-5579-S
V40D-VC60D (FORKLIFTS) CAT 1404 GAS (S/N: 95B-UP)		Oil Filter Full Flow.....	C-5504	Air Filter Set.....	A-5578-S
Air Filter Set.....	A-5578-S	V60 (FORKLIFTS) PERKINS 3.152		Air Filter Primary.....	A-5577
Air Filter Set.....	A-5579-S	Air Filter Primary.....	A-70280	Air Filter Set.....	A-5579-S
Air Filter Primary.....	A-5577	Air Filter Primary.....	A-70270	Air Filter Secondary.....	A-5576
Air Filter Secondary.....	A-5576	V60C-V80C (FORKLIFTS) PERKINS 4.236 DIESEL (S/N: 35X-UP)		Air Filter Set.....	A-5578-S
Hydraulic Oil Filter Transmission...	HC-5501	Fuel Filter.....	FC-5103	Air Filter Primary.....	A-5577
Oil Filter Full Flow.....	C-5504	V60D-V80D (FORKLIFTS) PERKINS 4.236 (S/N: 74X-UP)		V60E-V90E (FORKLIFTS) PERKINS 4.236 GAS (S/N: 7LB-UP)	
V40D-VC60D (FORKLIFTS) PERKINS 4.2032 DIESEL (S/N: 5BC-UP)		Air Filter Set.....	A-5579-S	Air Filter Set.....	A-5579-S
Air Filter Set.....	A-5578-S	Air Filter Secondary.....	A-5576	Air Filter Secondary.....	A-5576
Air Filter Primary.....	A-5577	Air Filter Primary.....	A-5577	Air Filter Set.....	A-5578-S
Air Filter Secondary.....	A-5576	Air Filter Set.....	A-5578-S	Air Filter Primary.....	A-5577
Air Filter Set.....	A-5579-S	V60D-V80D (FORKLIFTS) PERKINS 4.236 DIESEL (S/N: 75X-UP)		V60C (FORKLIFTS) PERKINS 4.236	
Fuel Filter.....	FC-5103	Air Filter Set.....	A-5579-S	Air Filter Primary.....	A-70280
Hydraulic Oil Filter Transmission...	HC-5501	Air Filter Secondary.....	A-5576	Air Filter Primary.....	A-70270
Oil Filter Full Flow.....	C-5103	Air Filter Primary.....	A-5577	V60D (FORKLIFTS) PERKINS 4.236	
V40D-VC60D (FORKLIFTS) PEUGEOT XD3P DIESEL (S/N: 9RB-UP)		Air Filter Set.....	A-5578-S	Air Filter Primary.....	A-70280
Fuel Filter.....	FC-5101	Air Filter Secondary.....	A-5576	Air Filter Primary.....	A-70270
Hydraulic Oil Filter Transmission...	HC-5501	Air Filter Primary.....	A-5577	V60B (FORKLIFTS) CONTINENTAL F163	
Oil Filter Full Flow.....	C-1005	Air Filter Set.....	A-5578-S	Air Filter Primary.....	A-70280
V40D-VC60D (FORKLIFTS) PEUGEOT XN1P (S/N: 3EC-UP)		Fuel Filter.....	FC-5103	V60B (FORKLIFTS) CONTINENTAL F227	
Hydraulic Oil Filter Transmission...	HC-5501	V60D-V80D (FORKLIFTS) PERKINS 4.236 GAS (S/N: 74X-UP)		Air Filter Primary.....	A-70280
Oil Filter Full Flow.....	C-1005	Air Filter Secondary.....	A-5576	Air Filter Primary.....	A-70270
V40D-VC60D (FORKLIFTS) PEUGEOT XN1P GAS (S/N: 3EC-UP)		Air Filter Set.....	A-5578-S	V60B (FORKLIFTS) PERKINS 4.236	
Hydraulic Oil Filter Transmission...	HC-5501	Air Filter Primary.....	A-5577	Air Filter Primary.....	A-70280
Oil Filter Full Flow.....	C-1005	Air Filter Set.....	A-5579-S	Air Filter Primary.....	A-70270
V40D-VC60D (FORKLIFTS) PERKINS 4.236		V60E-V90E (FORKLIFTS) PERKINS 4.236 (S/N: 74X-UP)		V60E (FORKLIFTS) PERKINS 4.236	
Air Filter Primary.....	A-5577	Air Filter Set.....	A-5579-S	Air Filter Primary.....	A-70270
Air Filter Secondary.....	A-5576	Air Filter Secondary.....	A-5576	Air Filter Primary.....	A-70280
Air Filter Set.....	A-5579-S	Air Filter Set.....	A-5578-S	Air Filter Primary.....	A-70270
Air Filter Set.....	A-5578-S	Air Filter Primary.....	A-5577	V700-V800 (FORKLIFTS) CAT 3208DSL (S/N: 5LC-UP)	
Fuel Filter.....	FC-5103	Air Filter Set.....	A-5579-S	Air Filter Primary.....	A-5507
Hydraulic Oil Filter Transmission...	HC-5501	Air Filter Secondary.....	A-5576	Air Filter Set.....	A-55071-S
Oil Filter Full Flow.....	C-5103	Air Filter Primary.....	A-5577	Air Filter Set.....	A-5507-S
V50E (FORKLIFTS)		Air Filter Set.....	A-5579-S	Air Filter.....	A-5530
Air Filter Secondary.....	A-5536	Air Filter Primary.....	A-5577	Hydraulic Oil Filter.....	H-5504
Air Filter Set.....	A-5537-S	V60E-V90E (FORKLIFTS) PERKINS 4.236 (S/N: 7LB-UP)		Hydraulic Oil Filter.....	H-5517
Air Filter Primary.....	A-5537	Air Filter Secondary.....	A-5576	Oil Filter Full Flow.....	C-5519
V550-V620 (FORKLIFTS) CAT 3208 (S/N: 2DD-UP)		Air Filter Set.....	A-5578-S	Oil Filter Full Flow.....	C-5504
Air Filter Set.....	A-55071-S	Air Filter Set.....	A-5579-S	V60E-V90E (FORKLIFTS) PERKINS 4.236 DIESEL (S/N: 58A-UP)	
Air Filter Set.....	A-5507-S	Air Filter Primary.....	A-5577		
Air Filter.....	A-5530				

Sakura Filter

ENGINE APPLICATION

MODEL/APPLICATION	SAKURA NO	MODEL/APPLICATION	SAKURA NO	MODEL/APPLICATION	SAKURA NO
CATERPILLAR		CATERPILLAR		CATERPILLAR	
V700-V800 (<i>FORKLIFTS</i>) CAT 3208DSL (S/N: 5LC-UP) Oil Filter Full Flow.....	C-5505	V925 LH (<i>FORKLIFTS</i>) CAT 3208DSL (S/N: 8NF-UP) Air Filter Set.....	A-55071-S	Air Filter Secondary.....	A-8580
V70F-V90F (<i>FORKLIFTS</i>) PERKINS 4.236 (S/N: 9NF-UP) Air Filter Secondary.....	A-5580	Air Filter.....	A-5530	Cabin Air Filter.....	CA-55850
Air Filter Set.....	A-5579-S	Air Filter Primary.....	A-5507	Fuel Filter.....	FC-5510
Air Filter Set.....	A-5578-S	Air Filter Set.....	A-5507-S	Hydraulic Oil Filter.....	HC-55170
Air Filter Primary.....	A-5577	Hydraulic Oil Filter.....	H-5517	Hydraulic Oil Filter.....	HC-5504
Hydraulic Oil Filter Transmission...	HC-5501	Hydraulic Oil Filter.....	H-5504	Hydraulic Oil Filter.....	HC-5801
V70F-V90F (<i>FORKLIFTS</i>) PERKINS 4.236 GAS (S/N: 9NF-UP) Air Filter Secondary.....	A-5580	Oil Filter Full Flow.....	C-5504	Hydraulic Oil Filter.....	H-7942
Air Filter Set.....	A-5579-S	Oil Filter Full Flow.....	C-5505	Hydraulic Oil Filter.....	H-5522
Air Filter Primary.....	A-5577	Oil Filter Full Flow.....	C-5519		
Air Filter Set.....	A-5578-S	VC60C (<i>FORKLIFTS</i>) Hydraulic Oil Filter Transmission...	HC-5501	W345C (<i>MATERIAL HANDLERS</i>) CAT S/N: MHX300-UP Air Filter Secondary.....	A-8580
Hydraulic Oil Filter Transmission...	HC-5501	VC60C (<i>FORKLIFTS</i>) PERKINS 4.236 Air Filter Primary.....	A-70280	Air Filter Primary.....	A-8665M
V70F-V90F (<i>FORKLIFTS</i>) PERKINS 4.2482 DIESEL (S/N: 2GJ-UP) Air Filter Primary.....	A-5577	Air Filter Primary.....	A-70270	Cabin Air Filter.....	CA-55850
Air Filter Set.....	A-5579-S	VC60D SA (<i>FORKLIFTS</i>) CAT 1404 Air Filter Set.....	A-5579-S	Fuel Filter.....	FC-5510
Air Filter Secondary.....	A-5580	Air Filter Set.....	A-5578-S	Hydraulic Oil Filter.....	HC-5801
Air Filter Set.....	A-5578-S	Air Filter Secondary.....	A-5576	Hydraulic Oil Filter.....	H-7942
Fuel Filter.....	FC-5103	Air Filter Primary.....	A-5577	Hydraulic Oil Filter.....	H-5522
Hydraulic Oil Filter Transmission...	HC-5501	Hydraulic Oil Filter Transmission...	HC-5501	Hydraulic Oil Filter.....	HC-5504
V80C (<i>FORKLIFTS</i>) PERKINS 4.236 Air Filter Primary.....	A-70270	Oil Filter Full Flow.....	C-5504	Hydraulic Oil Filter.....	HC-55170
V80D (<i>FORKLIFTS</i>) PERKINS 4.236 Air Filter Primary.....	A-70270	VC60D SA (<i>FORKLIFTS</i>) PERKINS 4.2032 Air Filter Set.....	A-5579-S	Hydraulic Oil Filter.....	HC-5801
V900 CH (<i>FORKLIFTS</i>) CAT 3208 Air Filter Set.....	A-44180-S	Air Filter Secondary.....	A-5576	Hydraulic Oil Filter.....	HC-5504
Air Filter Primary.....	A-44180	Air Filter Primary.....	A-5577	Hydraulic Oil Filter.....	H-7942
V900 CH (<i>FORKLIFTS</i>) CAT 3208DSL (S/N: 3WD-UP) Air Filter Set.....	A-55071-S	Air Filter Set.....	A-5578-S	Hydraulic Oil Filter.....	H-5522
Air Filter Set.....	A-5507-S	Fuel Filter.....	FC-5103		
Air Filter.....	A-5530	Hydraulic Oil Filter Transmission...	HC-5501	W345C (<i>MATERIAL HANDLERS</i>) CAT C13 ACERT Hydraulic Oil Filter.....	HC-9901
Air Filter Primary.....	A-5507	W330B (<i>EXCAVATORS</i>) CAT 3306 (S/N: AME1-UP) Air Filter Primary.....	A-5558	Fuel Filter.....	FC-5509
Hydraulic Oil Filter.....	H-5517	Air Filter Secondary.....	A-5559	Fuel Filter.....	FC-5517
Hydraulic Oil Filter.....	H-5504	Cabin Air Filter.....	CA-55850	Oil Filter Full Flow.....	C-5516
Oil Filter Full Flow.....	C-5504	Fuel Filter Secondary.....	FC-5507	W345B II (<i>MATERIAL HANDLERS</i>) CAT S/N: 7ZE4253-4280-UP Fuel Filter.....	FC-5509
Oil Filter Full Flow.....	C-5519	Hydraulic Oil Filter.....	HC-5801	Fuel Filter.....	FC-5509
Oil Filter Full Flow.....	C-5505	Hydraulic Oil Filter.....	HC-5505	W345B II (<i>MATERIAL HANDLERS</i>) CAT S/N: 7ZR1-4252-UP Fuel Filter.....	FC-5517
V925 (<i>FORKLIFTS</i>) CAT 3208DSL (S/N: 8FB-UP) Air Filter Primary.....	A-5507	Hydraulic Oil Filter.....	H-7942	Fuel Filter.....	FC-5509
Air Filter Set.....	A-5507-S	Hydraulic Oil Filter.....	HC-5801	W345B II (<i>MATERIAL HANDLERS</i>) CAT S/N: 7ZR5545-UP Fuel Filter.....	FC-5509
Air Filter Set.....	A-55071-S	Hydraulic Oil Filter.....	H-7942	Fuel Filter.....	FC-5517
Air Filter.....	A-5530	Oil Filter Full Flow.....	C-5510	Oil Filter Full Flow.....	C-5516
Hydraulic Oil Filter.....	H-5517	W330B MH (<i>MATERIAL HANDLERS</i>) CAT 3306 (S/N: AME1-UP) Air Filter Secondary.....	A-5559	W345B II (<i>MATERIAL HANDLERS</i>) S/N: ANJ1-UP Air Filter Secondary.....	A-5594
Hydraulic Oil Filter.....	H-5504	Air Filter Primary.....	A-5558	Air Filter Set.....	A-5595-S
Oil Filter Full Flow.....	C-5504	Fuel Filter.....	F-5505	Air Filter Primary.....	A-5593
Oil Filter Full Flow.....	C-5519	Fuel Filter Secondary.....	FC-5507	Cabin Air Filter.....	CA-55850
Oil Filter Full Flow.....	C-5505	Hydraulic Oil Filter.....	HC-5505	Fuel/Water Separator Secondary...	SFC-5504-10
		Hydraulic Oil Filter.....	HC-5801		
		Hydraulic Oil Filter.....	H-7942		
		Oil Filter Full Flow.....	C-5510		
		W345C (<i>MATERIAL HANDLERS</i>) CAT S/N: M3M1-UP Air Filter Primary.....	A-8665M		

MODEL/APPLICATION	SAKURA NO
CATERPILLAR	

W345B II

(MATERIAL HANDLERS)

S/N: ANJ1-UP

Fuel/Water Separator Secondary..	SFC-5504-10B
Hydraulic Oil Filter.....	HC-55170
Hydraulic Oil Filter.....	H-7942
Hydraulic Oil Filter.....	HC-5505
Hydraulic Oil Filter.....	HC-5801

W345B II

(MATERIAL HANDLERS)

S/N: CDY1-UP

Air Filter Set.....	A-5595-S
Air Filter Secondary.....	A-5594
Air Filter Primary.....	A-5593
Cabin Air Filter.....	CA-55850
Fuel/Water Separator Secondary..	SFC-5504-10
Fuel/Water Separator Secondary..	SFC-5504-10B
Hydraulic Oil Filter.....	HC-55170
Hydraulic Oil Filter.....	H-7942
Hydraulic Oil Filter.....	HC-5801
Hydraulic Oil Filter.....	HC-5505

W345B MH

(MATERIAL HANDLERS)

CAT 3176C (S/N: CDY1-UP)

Air Filter Secondary.....	A-5594
Air Filter Set.....	A-5595-S
Air Filter Primary.....	A-5593
Cabin Air Filter.....	CA-55850
Fuel Filter.....	FC-5517
Fuel/Water Separator Secondary..	SFC-5504-10B
Fuel/Water Separator Secondary..	SFC-5504-10
Hydraulic Oil Filter.....	H-7942
Hydraulic Oil Filter.....	HC-5505
Hydraulic Oil Filter.....	HC-5801
Oil Filter Full Flow.....	C-5516

W345BII MH

(MATERIAL HANDLERS)

CAT 3176C (S/N: ANJ1-UP)

Cabin Air Filter.....	CA-55850
Fuel Filter.....	FC-5517
Fuel/Water Separator Secondary..	SFC-5504-10
Fuel/Water Separator Secondary..	SFC-5504-10B
Hydraulic Oil Filter.....	HC-5505
Hydraulic Oil Filter.....	H-7942
Hydraulic Oil Filter.....	HC-5801
Oil Filter Full Flow.....	C-5516

WE851B

(ASPHALT PAVER)

S/N: 8BC1-UP

Air Filter Primary.....	AS-5523
-------------------------	---------

XE 323D L

(EXCAVATORS)

Cabin Air Filter.....	CAC-55170
Cabin Air Filter.....	CA-55170
Cabin Air Filter.....	CAV-55170

















Technical Specification

B

Sakura Filter

Technical Specification

<p>A-1096</p> <p>Air Filter Metal End Cap Element</p> <p>MITSUBISHI 91361-00900 MITSUBISHI 91361-00901</p>  <p>H 1 : 228.9 (mm) H 2 : 219 (mm) OD 1 : 153 (mm) OD 2 : 108 (mm) ID 1 : 59 (mm)</p> <p>CONT : 12 VOL : 0.113</p>	<p>A-28710</p> <p>Air Filter Primary Metal End Cap Element</p> <p>HYUNDAI 11N8-22140</p>  <p>Secondary Filter uses A-28720 Set Filter uses A-28730-S</p> <p>H 1 : 502.75 (mm) H 2 : 490 (mm) OD 1 : 276 (mm) OD 2 : 275 (mm) ID 1 : 165 (mm) ID 2 : 19 (mm)</p> <p>CONT : 1 VOL : 0.047</p>	<p>A-42420</p> <p>Air Filter Metal End Cap Element</p> <p>CATERPILLAR 4058797</p>  <p>H 1 : 343 (mm) H 2 : 330 (mm) OD 1 : 133.5 (mm) OD 2 : 134 (mm) ID 1 : 82 (mm) ID 2 : 17 (mm)</p> <p>CONT : 9 VOL : 0.084</p> <p>Note : for Caterpillar 6040 (Terex RH170) Hydraulic Excavator</p>
<p>A-2210</p> <p>Air Filter Primary Metal End Cap Element</p> <p>FIAT 0068473-3 ISUZU 1-14215-018-0 ISUZU 1-14215007-0 NISSAN 16546-96011</p>  <p>Secondary Filter uses A-6008 Set Filter uses A-6117-S</p> <p>H 1 : 342.7 (mm) H 2 : 330 (mm) OD 1 : 234 (mm) OD 2 : 234 (mm) ID 1 : 123 (mm) ID 2 : 17 (mm)</p> <p>CONT : 4 VOL : 0.093</p>	<p>A-28730-S</p> <p>Air Filter Set Metal End Cap Element</p> <p>HYUNDAI 11N8-22140+11N8-22150</p>  <p>Primary Filter uses A-28710 Secondary Filter uses A-28720</p> <p>H 1 : 502.75 (mm) H 2 : 490 (mm) OD 1 : 276 (mm) OD 2 : 275 (mm) ID 1 : 134 (mm) ID 2 : 19 (mm)</p> <p>CONT : 1 VOL : 0.047</p>	<p>A-4402</p> <p>Air Filter Secondary Soft PU end cap Element</p> <p>CATERPILLAR 180-5475</p>  <p>Primary Filter uses A-4401 Set Filter uses A-4401-S</p> <p>H 1 : 311 (mm) H 2 : 305 (mm) OD 1 : 92 (mm) OD 2 : 86.5 (mm) ID 1 : 72.5 (mm)</p> <p>CONT : 25 VOL : 0.096</p>
<p>A-25460</p> <p>Air Filter Metal End Cap Element</p> <p>CATERPILLAR 1569328 RENAULT 5000541976 MACK 57MD27</p>  <p>H 1 : 405.5 (mm) H 2 : 380 (mm) OD 1 : 220 (mm) OD 2 : 145 (mm) ID 1 : 132 (mm)</p> <p>CONT : 4 VOL : 0.099</p>	<p>A-4210</p> <p>Air Filter Primary Soft PU end cap Element</p> <p>KUBOTA 3P300-11220</p>  <p>Secondary Filter uses A-4211 Set Filter uses A-4212-S</p> <p>H 1 : 293.8 (mm) H 2 : 281 (mm) OD 1 : 207 (mm) OD 2 : 207 (mm) ID 1 : 106.5 (mm)</p> <p>CONT : 4 VOL : 0.068</p> <p>Note : Alternate parts A-76600</p>	<p>A-44150</p> <p>Air Filter Primary Rigid PU end cap Element</p> <p>CATERPILLAR 1P-7716 CATERPILLAR 7W-5495</p>  <p>Secondary Filter uses A-5502 Set Filter uses A-44150-S</p> <p>H 1 : 343 (mm) H 2 : 330 (mm) OD 1 : 290.5 (mm) OD 2 : 290.5 (mm) ID 1 : 203.5 (mm)</p> <p>CONT : 4 VOL : 0.140</p> <p>Note : is a rigid PU version of A-5501</p>
<p>A-2705</p> <p>Air Filter Secondary Soft PU end cap Element</p> <p>HITACHI 4287060 KOBELCO YN02P000013B</p>  <p>Primary Filter uses A-2706 Set Filter uses A-2707-S</p> <p>H 1 : 353 (mm) H 2 : 347 (mm) OD 1 : 124 (mm) OD 2 : 117 (mm) ID 1 : 104 (mm)</p> <p>CONT : 25 VOL : 0.178</p>	<p>A-4211</p> <p>Air Filter Secondary Soft PU end cap Element</p> <p>KUBOTA 3P300-11230</p>  <p>Primary Filter uses A-4210 Set Filter uses A-4212-S</p> <p>H 1 : 279.5 (mm) H 2 : 274.5 (mm) OD 1 : 107.5 (mm) OD 2 : 101.5 (mm) ID 1 : 89 (mm)</p> <p>CONT : 25 VOL : 0.113</p>	<p>A-44150-S</p> <p>Air Filter Set Metal End Cap Element</p> <p>CATERPILLAR 1P-7716+1P-7360</p>  <p>Primary Filter uses A-44150 Secondary Filter uses A-5502</p> <p>H 1 : 343 (mm) H 2 : 330 (mm) OD 1 : 290.5 (mm) OD 2 : 290.5 (mm) ID 1 : 203.5 (mm)</p> <p>CONT : 1 VOL : 0.035</p>
<p>A-2706</p> <p>Air Filter Primary Soft PU end cap Element</p> <p>HITACHI 4283861 KOBELCO YN02P000013A</p>  <p>Secondary Filter uses A-2705 Set Filter uses A-2707-S</p> <p>H 1 : 367.5 (mm) H 2 : 355.5 (mm) OD 1 : 207 (mm) OD 2 : 208 (mm) ID 1 : 123 (mm)</p> <p>CONT : 9 VOL : 0.175</p>	<p>A-4212-S</p> <p>Air Filter Set Soft PU end cap Element</p> <p>KUBOTA 3P300-11220+3P300-11230</p>  <p>Primary Filter uses A-4210 Secondary Filter uses A-4211</p> <p>H 1 : 293.8 (mm) H 2 : 281 (mm) OD 1 : 207 (mm) OD 2 : 207 (mm) ID 1 : 106.5 (mm)</p> <p>CONT : 4 VOL : 0.072</p>	<p>A-44180</p> <p>Air Filter Primary Rigid PU end cap Element</p> <p>CATERPILLAR 4M-8047</p>  <p>Secondary Filter uses A-5508 Set Filter uses A-44180-S</p> <p>H 1 : 318 (mm) H 2 : 306 (mm) OD 1 : 234 (mm) OD 2 : 234 (mm) ID 1 : 122.5 (mm)</p> <p>CONT : 4 VOL : 0.085</p> <p>Note : IS A RIGID PU VERSION OF A-5507,A-4406</p>

Sakura Filter

Technical Specification

A-44180-S Air Filter Set Metal End Cap Element

CATERPILLAR 4M-8047+2S-1285



Primary Filter uses A-44180
Secondary Filter uses A-5508
H 1 : 318 (mm)
H 2 : 306 (mm)
OD 1 : 234 (mm)
OD 2 : 234 (mm)
ID 1 : 122.5 (mm)

CONT : 4
VOL : 0.094

A-44330-S Air Filter Set Soft PU end cap Element

CATERPILLAR 380-8941+380-8942



Primary Filter uses A-44330
Secondary Filter uses A-44340
H 1 : 537 (mm)
H 2 : 530 (mm)
OD 1 : 281 (mm)
OD 2 : 151 (mm)
ID 1 : 109.6 (mm)

CONT : 1
VOL : 0.050

A-5105 Air Filter Primary Soft PU end cap Element

BOMAG 05821147
VOLVO 2908237
MASSEY-FERGUSON 3901477M1
J.C.BAMFORD 580-12020

Secondary Filter uses A-5106
Set Filter uses A-5107-S
H 1 : 400 (mm)
H 2 : 367 (mm)
OD 1 : 194 (mm)
OD 2 : 194 (mm)
ID 1 : 113.5 (mm)

CONT : 4
VOL : 0.078

A-44220 Air Filter Primary Soft PU end cap Element

CATERPILLAR 1236855



Secondary Filter uses A-44230
Set Filter uses A-44240-S
H 1 : 395 (mm)
H 2 : 382 (mm)
OD 1 : 362 (mm)
OD 2 : 362 (mm)
ID 1 : 229 (mm)

CONT : 1
VOL : 0.058

A-44340 Air Filter Secondary Soft PU end cap Element

CATERPILLAR 380-8942



Primary Filter uses A-44330
Set Filter uses A-44330-S
H 1 : 530 (mm)
OD 1 : 151 (mm)
OD 2 : 151 (mm)
ID 1 : 109.6 (mm)

CONT : 1
VOL : 0.015

A-5106 Air Filter Secondary Soft PU end cap Element

VOLVO 2908238
MASSEY-FERGUSON 3901478M1
J.C.BAMFORD 580-12021

Primary Filter uses A-5105
Set Filter uses A-5107-S
H 1 : 386 (mm)
H 2 : 380 (mm)
OD 1 : 104 (mm)
OD 2 : 107 (mm)
ID 1 : 93 (mm)

CONT : 25
VOL : 0.178

A-44230 Air Filter Secondary Soft PU end cap Element

CATERPILLAR 1236856



Primary Filter uses A-44220
Set Filter uses A-44240-S
H 1 : 386 (mm)
OD 1 : 229 (mm)
OD 2 : 220 (mm)
ID 1 : 175 (mm)

CONT : 4
VOL : 0.107

A-44370 Air Filter Secondary Soft PU+Plastic Element

CATERPILLAR 447-0761



Primary Filter uses A-44380
Set Filter uses A-44380-S
H 1 : 392 (mm)
H 2 : 352 (mm)
OD 1 : 114.5 (mm)
OD 2 : 114.5 (mm)
ID 1 : 94 (mm)

CONT : 9
VOL : 0.081

A-5408 Air Filter Secondary Metal End Cap Element

ISUZU 1-14215034-0
ISUZU 1-14215036-0
NISSAN 16546-96014



Primary Filter uses A-6113
Set Filter uses A-5653-S
H 1 : 406 (mm)
OD 1 : 192.3 (mm)
OD 2 : 162.5 (mm)
ID 1 : 134.2 (mm)
ID 2 : 17 (mm)

CONT : 9
VOL : 0.167

Note : Is a Secondary Air filter for A-6113,A-54490

A-44240-S Air Filter Set Soft PU end cap Element

CATERPILLAR 1236855+1236856



Primary Filter uses A-44220
Secondary Filter uses A-44230
H 1 : 395 (mm)
H 2 : 382 (mm)
OD 1 : 362 (mm)
OD 2 : 362 (mm)
ID 1 : 228 (mm)

CONT : 1
VOL : 0.060

A-44380 Air Filter Primary Soft PU end cap Element

CATERPILLAR 457-8206



Secondary Filter uses A-44370
Set Filter uses A-44380-S
H 1 : 416 (mm)
H 2 : 380 (mm)
OD 1 : 210 (mm)
OD 2 : 210 (mm)
ID 1 : 118 (mm)

CONT : 4
VOL : 0.110

A-5434 Air Filter Metal End Cap Element

KOMATSU 381-935694-1
INTERNATIONAL HARVESTER 935694 C1



H 1 : 419.2 (mm)
H 2 : 406.5 (mm)
OD 1 : 264.5 (mm)
OD 2 : 264.5 (mm)
ID 1 : 153 (mm)
ID 2 : 17 (mm)

CONT : 1
VOL : 0.033

A-44330 Air Filter Primary Soft PU end cap Element

CATERPILLAR 380-8941



Secondary Filter uses A-44340
Set Filter uses A-44330-S
H 1 : 537 (mm)
OD 1 : 281.6 (mm)
OD 2 : 281.6 (mm)
ID 1 : 148 (mm)

CONT : 1
VOL : 0.050

A-44380-S Air Filter Set Soft PU end cap Element

CATERPILLAR 457-8206+447-0761



Primary Filter uses A-44380
Secondary Filter uses A-44370
H 1 : 418 (mm)
H 2 : 380 (mm)
OD 1 : 210 (mm)
OD 2 : 210 (mm)
ID 1 : 94 (mm)

CONT : 4
VOL : 0.110

A-5501 Air Filter Primary Metal End Cap Element

CATERPILLAR 1P-7716
CATERPILLAR 7W-5495
CATERPILLAR 8N-5495



Secondary Filter uses A-5502
Set Filter uses A-5501-S
H 1 : 342.7 (mm)
H 2 : 330 (mm)
OD 1 : 292 (mm)
OD 2 : 292 (mm)
ID 1 : 205.5 (mm)

CONT : 1
VOL : 0.035

Note : IS A metal VERSION OF A-44150

A-5502 Air Filter Secondary Metal End Cap Element
 CATERPILLAR 1P-7360



Primary Filter uses A-5501
 Set Filter uses A-5501-S
 H 1 : 340 (mm)
 OD 1 : 259 (mm)
 OD 2 : 194.5 (mm)
 ID 1 : 150 (mm)

CONT : 1
 VOL : 0.027

31

A-5508 Air Filter Secondary Metal End Cap Element
 CATERPILLAR 2S-1285
 CATERPILLAR 4M-8048



Primary Filter uses A-5507
 Set Filter uses A-5507-S
 H 1 : 339.5 (mm)
 H 2 : 307 (mm)
 OD 1 : 189 (mm)
 OD 2 : 121.5 (mm)
 ID 1 : 91.5 (mm)

CONT : 9
 VOL : 0.142

36

A-5512 Air Filter Secondary Metal End Cap Element
 CATERPILLAR 2S-1284
 CATERPILLAR 4M-9379



Primary Filter uses A-5511
 Set Filter uses A-5511-S
 H 1 : 288 (mm)
 H 2 : 256 (mm)
 OD 1 : 170 (mm)
 OD 2 : 96 (mm)
 ID 1 : 65.5 (mm)

CONT : 12
 VOL : 0.135

41

A-5505 Air Filter Metal End Cap Element
 CATERPILLAR 4L-9852



H 1 : 311.4 (mm)
 H 2 : 305 (mm)
 OD 1 : 264.5 (mm)
 OD 2 : 264.5 (mm)
 ID 1 : 153 (mm)

CONT : 1
 VOL : 0.025

32

A-5509 Air Filter Primary Metal End Cap Element
 CATERPILLAR 2P-5080(P)
 CATERPILLAR 4M-9334
 CATERPILLAR 7W-5317



Secondary Filter uses A-5510
 Set Filter uses A-5509-S
 H 1 : 342.7 (mm)
 H 2 : 330 (mm)
 OD 1 : 281 (mm)
 OD 2 : 281 (mm)
 ID 1 : 171 (mm)

CONT : 1
 VOL : 0.031

Note : Metal version, PU version uses A-44130

37

A-5514 Air Filter Primary Metal End Cap Element
 CATERPILLAR 4S-8833



Secondary Filter uses A-5527
 Set Filter uses A-5514-S
 H 1 : 249.25 (mm)
 H 2 : 236.5 (mm)
 OD 1 : 324 (mm)
 OD 2 : 365 (mm)
 ID 1 : 212 (mm)
 ID 2 : 23.7 (mm)

CONT : 1
 VOL : 0.042

42

A-5507 Air Filter Primary Metal End Cap Element
 CATERPILLAR 4M-8047
 CATERPILLAR 7W-5389
 CATERPILLAR 8N-5389



Secondary Filter uses A-5508
 Set Filter uses A-5507-S
 H 1 : 317.7 (mm)
 H 2 : 305 (mm)
 OD 1 : 234 (mm)
 OD 2 : 234 (mm)
 ID 1 : 123 (mm)

CONT : 4
 VOL : 0.089

Note : Metal version, PU version uses A-44180

33

A-5510 Air Filter Secondary Metal End Cap Element
 CATERPILLAR 1S1286
 CATERPILLAR 2P-5080(S)
 CATERPILLAR 2S-1286



Primary Filter uses A-5509
 Set Filter uses A-5509-S
 H 1 : 364 (mm)
 H 2 : 332 (mm)
 OD 1 : 230 (mm)
 OD 2 : 159.5 (mm)
 ID 1 : 115.8 (mm)

CONT : 4
 VOL : 0.097

Note : Is a Secondary Air filter for A-5509,A-44130

38

A-5514-S Air Filter Set Metal End Cap Element
 CATERPILLAR 4S8833+4S8834



Primary Filter uses A-5514
 Secondary Filter uses A-5527
 H 1 : 249.25 (mm)
 H 2 : 236.5 (mm)
 OD 1 : 324 (mm)
 OD 2 : 365 (mm)
 ID 1 : 212 (mm)

CONT : 1
 VOL : 0.041

43

A-5507-S Air Filter Set Metal End Cap Element
 CATERPILLAR 4M-8047+4M-8048
 CATERPILLAR 7W-5389+2S-1285



Primary Filter uses A-5507
 Secondary Filter uses A-5508
 H 1 : 317.75 (mm)
 H 2 : 305 (mm)
 OD 1 : 234 (mm)
 OD 2 : 234 (mm)
 ID 1 : 123 (mm)

CONT : 4
 VOL : 0.093

34

A-5511 Air Filter Primary Metal End Cap Element
 CATERPILLAR 4M-9378



Secondary Filter uses A-5512
 Set Filter uses A-5511-S
 H 1 : 266.7 (mm)
 H 2 : 254 (mm)
 OD 1 : 212.5 (mm)
 OD 2 : 212.5 (mm)
 ID 1 : 102.5 (mm)

CONT : 4
 VOL : 0.061

39

A-5515 Air Filter Primary Metal End Cap Element
 CATERPILLAR 4S-8337



Secondary Filter uses A-5528
 Set Filter uses A-5515-S
 H 1 : 369.25 (mm)
 H 2 : 356.5 (mm)
 OD 1 : 324 (mm)
 OD 2 : 365 (mm)
 ID 1 : 212 (mm)
 ID 2 : 23.7 (mm)

CONT : 1
 VOL : 0.059

44

A-55071-S Air Filter Set Metal End Cap Element
 CATERPILLAR 7W-5389+8N-4901



Primary Filter uses A-5507
 Secondary Filter uses A-5530
 H 1 : 317.7 (mm)
 H 2 : 305 (mm)
 OD 1 : 234 (mm)
 OD 2 : 234 (mm)
 ID 1 : 123 (mm)

CONT : 4
 VOL : 0.089

35

A-5511-S Air Filter Set Metal End Cap Element
 CATERPILLAR 4M-9378+4M-9379



Primary Filter uses A-5511
 Secondary Filter uses A-5512
 H 1 : 266.7 (mm)
 H 2 : 254 (mm)
 OD 1 : 212.5 (mm)
 OD 2 : 212.5 (mm)
 ID 1 : 102.5 (mm)

CONT : 4
 VOL : 0.067

40

A-5515-S Air Filter Set Metal End Cap Element
 CATERPILLAR 4S-8337+4S-8340



Primary Filter uses A-5515
 Secondary Filter uses A-5528
 H 1 : 369.25 (mm)
 H 2 : 356.5 (mm)
 OD 1 : 324 (mm)
 OD 2 : 365 (mm)
 ID 1 : 212 (mm)
 ID 2 : 23.7 (mm)

CONT : 1
 VOL : 0.075

45

Sakura Filter

Technical Specification

A-5518 Air Filter Metal framed Element

CATERPILLAR 6L-4714



H 1 : 65 (mm)
Length 1 : 610 (mm)
Width 1 : 610 (mm)

CONT : 1
VOL : 0.033

46

A-5522-S Air Filter Set Metal End Cap Element

CATERPILLAR 4M-9334+9S-9972



Primary Filter uses A-5509
Secondary Filter uses A-5522
H 1 : 342.7 (mm)
H 2 : 330 (mm)
OD 1 : 282 (mm)
OD 2 : 282 (mm)
ID 1 : 171 (mm)

CONT : 1
VOL : 0.031

51

A-5529 Air Filter Secondary Metal End Cap Element with 10 Bolt Holes

CATERPILLAR 1P-8482
CATERPILLAR 7N-1308



Primary Filter uses A-5532
H 1 : 389.6 (mm)
H 2 : 388 (mm)
OD 1 : 289 (mm)
OD 2 : 219.5 (mm)
ID 1 : 178 (mm)

CONT : 1
VOL : 0.038

Note : Is a Secondary Air filter for A-5532,A-5521

56

A-5520 Air Filter Secondary Metal End Cap Element

CATERPILLAR 2S-1287
CATERPILLAR 7M-9046



Primary Filter uses A-5543
Set Filter uses A-5544
H 1 : 442 (mm)
H 2 : 410 (mm)
OD 1 : 230.5 (mm)
OD 2 : 159.5 (mm)
ID 1 : 115.8 (mm)

CONT : 1
VOL : 0.028

47

A-5523 Air Filter Primary Metal End Cap Element

KOBELCO 2446R277S5
FIAT-ALLIS 70266787
JOHN DEERE AZ20625
KOBELCO SK150LC



Secondary Filter uses A-7913
Set Filter uses A-61160-S
H 1 : 418.7 (mm)
H 2 : 406 (mm)
OD 1 : 174 (mm)
OD 2 : 174 (mm)
ID 1 : 107.5 (mm)
ID 2 : 17 (mm)

CONT : 9
VOL : 0.141

Note : with fins version,use AS-5523

52

A-55291 Air Filter Secondary Metal End Cap Element with 10 Bolt Holes

CATERPILLAR 7N-1308



Primary Filter uses A-55211
Set Filter uses A-55211-S
H 1 : 384 (mm)
H 2 : 383 (mm)
OD 1 : 289 (mm)
OD 2 : 219.5 (mm)
ID 1 : 178 (mm)

CONT : 1
VOL : 0.038

57

A-5521 Air Filter Primary Metal End Cap Element

CATERPILLAR 1P-8483
CATERPILLAR 7W-5313
CATERPILLAR 8N-5313



Secondary Filter uses A-5552
Set Filter uses A-5572-S
H 1 : 393.7 (mm)
H 2 : 381 (mm)
OD 1 : 317.5 (mm)
OD 2 : 317.5 (mm)
ID 1 : 232 (mm)

CONT : 1
VOL : 0.045

Note : Is a Primary Air Filter for A-5552,A-5529

48

A-5525 Air Filter Secondary Metal End Cap Element

CATERPILLAR 4N-0313



Primary Filter uses A-5542
Set Filter uses A-5542-S
H 1 : 266.7 (mm)
H 2 : 254 (mm)
OD 1 : 85.5 (mm)
OD 2 : 85.5 (mm)
ID 1 : 57.5 (mm)
ID 2 : 17 (mm)

CONT : 25
VOL : 0.078

53

A-5530 Air Filter Metal End Cap Element

CATERPILLAR 8N-4901



H 1 : 306.6 (mm)
H 2 : 305 (mm)
OD 1 : 189 (mm)
OD 2 : 121.5 (mm)
ID 1 : 91 (mm)

CONT : 9
VOL : 0.148

58

A-5521-S Air Filter Set Metal End Cap Element

CATERPILLAR 1P-8483+1P-8482
CATERPILLAR 7W-5313+1P-8482



Primary Filter uses A-5521
Secondary Filter uses A-5529
H 1 : 393.7 (mm)
H 2 : 381 (mm)
OD 1 : 317.5 (mm)
OD 2 : 317.5 (mm)
ID 1 : 178 (mm)

CONT : 1
VOL : 0.045

49

A-5526 Air Filter Secondary Metal End Cap Element

CATERPILLAR 3S-4745



Primary Filter uses A-5557
Set Filter uses A-5557-S
H 1 : 388 (mm)
H 2 : 388 (mm)
OD 1 : 305 (mm)
OD 2 : 221 (mm)
ID 1 : 175 (mm)

CONT : 1
VOL : 0.045

54

A-5532 Air Filter Primary Metal End Cap Element

CATERPILLAR 1W-2516
CATERPILLAR 7W-5216



Secondary Filter uses A-5529
H 1 : 482.75 (mm)
H 2 : 470 (mm)
OD 1 : 317.5 (mm)
OD 2 : 317.5 (mm)
ID 1 : 232 (mm)
ID 2 : 11.5 (mm)

CONT : 1
VOL : 0.060

59

A-5522 Air Filter Secondary Metal End Cap Element

CATERPILLAR 1W7365
CATERPILLAR 1W7919
CATERPILLAR 2P8863



Primary Filter uses A-5509
Set Filter uses A-5522-S
H 1 : 331.6 (mm)
H 2 : 330 (mm)
OD 1 : 230.5 (mm)
OD 2 : 159.5 (mm)
ID 1 : 117 (mm)

CONT : 1
VOL : 0.021

50

A-5528 Air Filter Secondary Metal End Cap Element

CATERPILLAR 4S-8340



Primary Filter uses A-5515
Set Filter uses A-5515-S
H 1 : 340 (mm)
H 2 : 340 (mm)
OD 1 : 259 (mm)
OD 2 : 194 (mm)
ID 1 : 150 (mm)

CONT : 1
VOL : 0.027

55

A-5532-S Air Filter Set Metal End Cap Element

CATERPILLAR 1W-2516+1P-8482



Primary Filter uses A-5532
Secondary Filter uses A-5529
H 1 : 482.75 (mm)
H 2 : 470 (mm)
OD 1 : 317.5 (mm)
OD 2 : 317.5 (mm)
ID 1 : 232 (mm)
ID 2 : 11.5 (mm)

CONT : 1
VOL : 0.060

60

Sakura Filter

Technical Specification

A-5534 Air Filter Secondary Soft PU end cap Element
CATERPILLAR 6I-0274



Primary Filter uses A-5535
Set Filter uses A-5573-S
H 1 : 334 (mm)
OD 1 : 185.6 (mm)
OD 2 : 175.7 (mm)
ID 1 : 131 (mm)

CONT : 9
VOL : 0.145

61

A-5537-S Air Filter Set Soft PU end cap Element
CATERPILLAR 6I-1450+6I-1451



Primary Filter uses A-5537
Secondary Filter uses A-5536
H 1 : 167 (mm)
H 2 : 155 (mm)
OD 1 : 207 (mm)
OD 2 : 207 (mm)
ID 1 : 105.5 (mm)

CONT : 4
VOL : 0.041

66

A-5542 Air Filter Primary Metal End Cap Element
CATERPILLAR 4N-0326



Secondary Filter uses A-5525
Set Filter uses A-5542-S
H 1 : 315.9 (mm)
H 2 : 305 (mm)
OD 1 : 174 (mm)
OD 2 : 174 (mm)
ID 1 : 89.4 (mm)
ID 2 : 17 (mm)

CONT : 12
VOL : 0.144

71

A-5535 Air Filter Primary Soft PU end cap Element
CATERPILLAR 6I-0273



Secondary Filter uses A-5534
Set Filter uses A-5573-S
H 1 : 342 (mm)
H 2 : 330 (mm)
OD 1 : 292 (mm)
OD 2 : 292 (mm)
ID 1 : 183 (mm)

CONT : 1
VOL : 0.035

Note : With Metal Reinforcement uses A-5535M

62

A-5540 Air Filter Secondary Soft PU end cap Element
YANMAR 119117-12570
CATERPILLAR 1318903
PERKINS 26510343
YANMAR Y119117-12570



Primary Filter uses A-5541
Set Filter uses A-5541-S
H 1 : 346 (mm)
H 2 : 340 (mm)
OD 1 : 92 (mm)
OD 2 : 86.5 (mm)
ID 1 : 72.5 (mm)

CONT : 25
VOL : 0.105

67

A-5542-S Air Filter Set Metal End Cap Element
CATERPILLAR 4N-0326+4N-0313



Primary Filter uses A-5542
Secondary Filter uses A-5525
H 1 : 305 (mm)
H 2 : 254 (mm)
OD 1 : 174 (mm)
OD 2 : 85 (mm)
ID 1 : 88 (mm)
ID 2 : 17 (mm)

CONT : 12
VOL : 0.144

72

A-5535M Air Filter Primary Soft PU+Metal Element
CATERPILLAR 6I-0273



Secondary Filter uses A-5534
Set Filter uses A-5573M-S
H 1 : 342 (mm)
H 2 : 330 (mm)
OD 1 : 292 (mm)
OD 2 : 292 (mm)
ID 1 : 183 (mm)

CONT : 1
VOL : 0.035

Note : Without metal reinforcement version uses A-5535

63

A-5541 Air Filter Primary Soft PU end cap Element
YANMAR 119117-12560
CATERPILLAR 131-8902
PERKINS 26510342
HITACHI 4486002



Secondary Filter uses A-5540
Set Filter uses A-5541-S
H 1 : 356 (mm)
H 2 : 347 (mm)
OD 1 : 163.5 (mm)
OD 2 : 163.5 (mm)
ID 1 : 91 (mm)

CONT : 9
VOL : 0.108

68

A-5543 Air Filter Primary Metal End Cap Element
CATERPILLAR 7M-9045
CATERPILLAR 7W-5316
CATERPILLAR 8N-5316



Secondary Filter uses A-5520
Set Filter uses A-5544
H 1 : 420.7 (mm)
H 2 : 408 (mm)
OD 1 : 282 (mm)
OD 2 : 282 (mm)
ID 1 : 171 (mm)

CONT : 1
VOL : 0.041

73

A-5536 Air Filter Secondary Soft PU end cap Element
CATERPILLAR 6I-1451



Primary Filter uses A-5537
Set Filter uses A-5537-S
H 1 : 148 (mm)
H 2 : 144 (mm)
OD 1 : 108 (mm)
OD 2 : 101 (mm)
ID 1 : 71 (mm)

CONT : 25
VOL : 0.064

64

A-5541M Air Filter Primary Soft PU+Metal Element
CATERPILLAR 131-8902



Secondary Filter uses A-5540
Set Filter uses A-5541M-S
H 1 : 356 (mm)
H 2 : 347 (mm)
OD 1 : 163.5 (mm)
OD 2 : 163.5 (mm)
ID 1 : 91 (mm)

CONT : 9
VOL : 0.108

69

A-5544-S Air Filter Set Metal End Cap Element
CATERPILLAR 7M-9045+9M-9046



Primary Filter uses A-5543
Secondary Filter uses A-5520
H 1 : 420.7 (mm)
H 2 : 408 (mm)
OD 1 : 282 (mm)
OD 2 : 282 (mm)
ID 1 : 171 (mm)

CONT : 1
VOL : 0.044

74

A-5537 Air Filter Primary Soft PU end cap Element
CATERPILLAR 6I-1450



Secondary Filter uses A-5536
Set Filter uses A-5537-S
H 1 : 167 (mm)
H 2 : 155 (mm)
OD 1 : 207 (mm)
OD 2 : 207 (mm)
ID 1 : 105.5 (mm)

CONT : 4
VOL : 0.040

65

A-5541M-S Air Filter Set Soft PU+Metal Element
CATERPILLAR 131-8902+131-8903



Primary Filter uses A-5541M
Secondary Filter uses A-5540
H 1 : 353 (mm)
H 2 : 344 (mm)
OD 1 : 163.5 (mm)
OD 2 : 163.5 (mm)
ID 1 : 91 (mm)

CONT : 9
VOL : 0.116

70

A-5547 Air Filter Metal End Cap Element
CATERPILLAR 7G-8116



H 1 : 190.5 (mm)
H 2 : 177.8 (mm)
OD 1 : 155 (mm)
OD 2 : 155 (mm)
ID 1 : 88 (mm)
ID 2 : 17 (mm)

CONT : 12
VOL : 0.078

75

Sakura Filter

Technical Specification

A-5549 Air Filter Primary Soft PU end cap Element

CATERPILLAR 128-2686
CATERPILLAR 6I-2501



Secondary Filter uses A-5550
Set Filter uses A-5549-S
H 1 : 339 (mm)
H 2 : 327 (mm)
OD 1 : 280 (mm)
OD 2 : 280 (mm)
ID 1 : 148 (mm)

CONT : 1
VOL : 0.031

76

A-5553 Air Filter Metal End Cap Element

CATERPILLAR 7N-1225



H 1 : 241.7 (mm)
H 2 : 229 (mm)
OD 1 : 264.5 (mm)
OD 2 : 264.5 (mm)
ID 1 : 153 (mm)

CONT : 1
VOL : 0.020

81

A-5557-S Air Filter Set Metal End Cap Element

CATERPILLAR 5S-4282+3S-4745



Primary Filter uses A-5557
Secondary Filter uses A-5526
H 1 : 410.7 (mm)
H 2 : 398 (mm)
OD 1 : 352 (mm)
OD 2 : 417 (mm)
ID 1 : 241 (mm)
ID 2 : 24 (mm)

CONT : 1
VOL : 0.085

86

A-5549M Air Filter Primary Soft PU+Metal Element

CATERPILLAR 128-2686
CATERPILLAR 6I-2501



Secondary Filter uses A-5550
Set Filter uses A-5549M-S
H 1 : 339 (mm)
H 2 : 327 (mm)
OD 1 : 282 (mm)
OD 2 : 280 (mm)
ID 1 : 148 (mm)

CONT : 1
VOL : 0.031

77

A-5555 Air Filter Primary Soft PU end cap Element

CATERPILLAR 6I-2505



Secondary Filter uses A-5556
Set Filter uses A-5555-S
H 1 : 393.5 (mm)
H 2 : 381.5 (mm)
OD 1 : 317.6 (mm)
OD 2 : 317.6 (mm)
ID 1 : 209 (mm)

CONT : 1
VOL : 0.045

82

A-5558 Air Filter Primary Soft PU end cap Element

KOMATSU 424-01-H0P03
KOMATSU 600-185-5100P
KOMATSU 600-185-5110



Secondary Filter uses A-5559
Set Filter uses A-5558-S
H 1 : 417 (mm)
H 2 : 405 (mm)
OD 1 : 280 (mm)
OD 2 : 280 (mm)
ID 1 : 148 (mm)

CONT : 1
VOL : 0.038

87

A-5549M-S Air Filter Set Soft PU+Metal Element

CATERPILLAR 6I-2501+6I-2502



Primary Filter uses A-5549M
Secondary Filter uses A-5550
H 1 : 339 (mm)
H 2 : 327 (mm)
OD 1 : 282 (mm)
OD 2 : 282 (mm)
ID 1 : 148 (mm)

CONT : 1
VOL : 0.031

78

A-5555-S Air Filter Set Soft PU end cap Element

CATERPILLAR 6I-2505+6I-2506



Primary Filter uses A-5555
Secondary Filter uses A-5556
H 1 : 393.5 (mm)
H 2 : 381.5 (mm)
OD 1 : 317.6 (mm)
OD 2 : 317.6 (mm)
ID 1 : 209 (mm)

CONT : 1
VOL : 0.050

83

A-5559 Air Filter Secondary Soft PU end cap Element

KOMATSU 424-01-H0P02
KOMATSU 600-185-5100S
KOMATSU 600-185-5120



Primary Filter uses A-5558
Set Filter uses A-5558-S
H 1 : 394 (mm)
OD 1 : 150 (mm)
OD 2 : 142.3 (mm)
ID 1 : 109 (mm)

CONT : 1
VOL : 0.011

88

A-5550 Air Filter Secondary Soft PU end cap Element

CATERPILLAR 6I-2502



Primary Filter uses A-5549
Set Filter uses A-5549-S
H 1 : 316 (mm)
OD 1 : 150 (mm)
OD 2 : 142 (mm)
ID 1 : 109 (mm)

CONT : 1
VOL : 0.009

Note : Set uses A-5549-S or A-5549M-S

79

A-5556 Air Filter Secondary Soft PU end cap Element

CATERPILLAR 6I-2506



Primary Filter uses A-5555
Set Filter uses A-5555-S
H 1 : 385.5 (mm)
OD 1 : 211 (mm)
OD 2 : 212 (mm)
ID 1 : 156.5 (mm)

CONT : 9
VOL : 0.203

84

A-5560 Air Filter Secondary Soft PU end cap Element

CATERPILLAR 6I-2508



Primary Filter uses A-5561
Set Filter uses A-5562-S
H 1 : 297.6 (mm)
H 2 : 297.6 (mm)
OD 1 : 211 (mm)
OD 2 : 200 (mm)
ID 1 : 156.5 (mm)

CONT : 1
VOL : 0.016

89

A-5552 Air Filter Secondary Metal End Cap Element

CATERPILLAR 6N-6444



Primary Filter uses A-5521
Set Filter uses A-5572-S
H 1 : 305.6 (mm)
H 2 : 304 (mm)
OD 1 : 289 (mm)
OD 2 : 219.5 (mm)
ID 1 : 178 (mm)

CONT : 1
VOL : 0.030

80

A-5557 Air Filter Primary Metal End Cap Element

CATERPILLAR 5S-4282



Secondary Filter uses A-5526
Set Filter uses A-5557-S
H 1 : 410.7 (mm)
H 2 : 398 (mm)
OD 1 : 352 (mm)
OD 2 : 417 (mm)
ID 1 : 241 (mm)
ID 2 : 24 (mm)

CONT : 1
VOL : 0.085

85

A-5561 Air Filter Primary Soft PU end cap Element

CATERPILLAR 6I-2507



Secondary Filter uses A-5560
Set Filter uses A-5562-S
H 1 : 393.5 (mm)
H 2 : 381.5 (mm)
OD 1 : 317.6 (mm)
OD 2 : 317.6 (mm)
ID 1 : 209 (mm)

CONT : 1
VOL : 0.045

90

Sakura Filter

Technical Specification

A-5562-S Air Filter Set Soft PU end cap Element
CATERPILLAR 6I-2507+6I-2508



Primary Filter uses A-5561
Secondary Filter uses A-5560
H 1 : 393.5 (mm)
H 2 : 381.5 (mm)
OD 1 : 317.6 (mm)
OD 2 : 317.6 (mm)
ID 1 : 209 (mm)

CONT : 1
VOL : 0.048

91

A-5567 Air Filter Secondary Soft PU end cap Element
CATERPILLAR 6I-2500



Primary Filter uses A-5566
Set Filter uses A-5568-S
H 1 : 294 (mm)
OD 1 : 120 (mm)
OD 2 : 114 (mm)
ID 1 : 82 (mm)

CONT : 20
VOL : 0.120

96

A-5576 Air Filter Secondary Metal End Cap Element
CATERPILLAR 4W-6691
CATERPILLAR 7N-9027



Primary Filter uses A-5577
Set Filter uses A-5578-S
H 1 : 162 (mm)
H 2 : 130 (mm)
OD 1 : 170 (mm)
OD 2 : 170 (mm)
ID 1 : 65.5 (mm)

CONT : 18
VOL : 0.118

101

A-5563 Air Filter Secondary Soft PU end cap Element
CATERPILLAR 6I-2510



Primary Filter uses A-5564
Set Filter uses A-5565-S
H 1 : 385.5 (mm)
OD 1 : 211 (mm)
OD 2 : 200 (mm)
ID 1 : 156.5 (mm)

CONT : 1
VOL : 0.022

92

A-5568-S Air Filter Set Soft PU end cap Element
CATERPILLAR 6I-2499+6I-2500



Primary Filter uses A-5566
Secondary Filter uses A-5567
H 1 : 315 (mm)
H 2 : 305 (mm)
OD 1 : 232 (mm)
OD 2 : 232 (mm)
ID 1 : 118 (mm)

CONT : 4
VOL : 0.091

97

A-5577 Air Filter Primary Metal End Cap Element
CATERPILLAR 7N-9028
CATERPILLAR 8N-5504



Secondary Filter uses A-5576
Set Filter uses A-5578-S
H 1 : 148.7 (mm)
H 2 : 136 (mm)
OD 1 : 213.5 (mm)
OD 2 : 213.5 (mm)
ID 1 : 102.5 (mm)

CONT : 12
VOL : 0.108

102

A-5564 Air Filter Primary Soft PU end cap Element
CATERPILLAR 6I-2509



Secondary Filter uses A-5563
Set Filter uses A-5565-S
H 1 : 482 (mm)
H 2 : 470 (mm)
OD 1 : 317.6 (mm)
OD 2 : 317.6 (mm)
ID 1 : 209 (mm)

CONT : 1
VOL : 0.054

93

A-5569 Air Filter Secondary Soft PU end cap Element
VOLVO 11801160
CATERPILLAR 1467473
JOHN DEERE M131803
KOMATSU YM12905112530



Primary Filter uses A-8513
Set Filter uses A-5570-S
H 1 : 265 (mm)
H 2 : 259 (mm)
OD 1 : 61 (mm)
OD 2 : 59 (mm)
ID 1 : 45 (mm)

CONT : 25
VOL : 0.048

98

A-5578-S Air Filter Set Metal End Cap Element
CATERPILLAR 8N5504+7N9027



Primary Filter uses A-5577
Secondary Filter uses A-5576
H 1 : 148.7 (mm)
H 2 : 136 (mm)
OD 1 : 212.5 (mm)
OD 2 : 213.5 (mm)
ID 1 : 102.5 (mm)

CONT : 6
VOL : 0.064

103

A-5565-S Air Filter Set Soft PU end cap Element
CATERPILLAR 6I-2509+6I-2510



Primary Filter uses A-5564
Secondary Filter uses A-5563
H 1 : 482 (mm)
H 2 : 470 (mm)
OD 1 : 317.6 (mm)
OD 2 : 317.6 (mm)
ID 1 : 209 (mm)

CONT : 1
VOL : 0.057

94

A-5573-S Air Filter Set Soft PU end cap Element
CATERPILLAR 6I-0273+6I-0274



Primary Filter uses A-5535
Secondary Filter uses A-5534
H 1 : 342 (mm)
H 2 : 330 (mm)
OD 1 : 292 (mm)
OD 2 : 292 (mm)
ID 1 : 183 (mm)

CONT : 1
VOL : 0.034

99

A-5579-S Air Filter Set Metal End Cap Element
CATERPILLAR 7N-9028+7W-6754



Primary Filter uses A-5577
Secondary Filter uses A-5580
H 1 : 148.7 (mm)
H 2 : 136 (mm)
OD 1 : 212.5 (mm)
OD 2 : 213.5 (mm)
ID 1 : 102.5 (mm)

CONT : 9
VOL : 0.085

104

A-5566 Air Filter Primary Soft PU end cap Element
CATERPILLAR 6I-2499



Secondary Filter uses A-5567
Set Filter uses A-5568-S
H 1 : 315 (mm)
H 2 : 305 (mm)
OD 1 : 232 (mm)
OD 2 : 232 (mm)
ID 1 : 118 (mm)

CONT : 4
VOL : 0.086

95

A-5573M-S Air Filter Set Soft PU+Metal Element
CATERPILLAR 6I-0273+6I-0274



Primary Filter uses A-5535M
Secondary Filter uses A-5534
H 1 : 342 (mm)
H 2 : 330 (mm)
OD 1 : 292 (mm)
OD 2 : 292 (mm)
ID 1 : 183 (mm)

CONT : 1
VOL : 0.034

100

Note : Set Filter [SOFT PU Only Uses A-5573-S]

A-5580 Air Filter Secondary Metal End Cap Element
CATERPILLAR 7W6754
CATERPILLAR 7W6754E



Primary Filter uses A-5577
Set Filter uses A-5579
H 1 : 131.5 (mm)
H 2 : 130 (mm)
OD 1 : 170 (mm)
OD 2 : 96 (mm)
ID 1 : 65 (mm)

CONT : 18
VOL : 0.096

105

Sakura Filter

Technical Specification

A-5581 Air Filter Primary Soft PU end cap Element
CATERPILLAR 102-9388



Secondary Filter uses A-5582
Set Filter uses A-5583-S
H 1 : 189.5 (mm)
H 2 : 177 (mm)
OD 1 : 207 (mm)
OD 2 : 207 (mm)
ID 1 : 105.5 (mm)

CONT : 9
VOL : 0.097

106

A-5593 Air Filter Primary Soft PU end cap Element
CATERPILLAR 1063969



Secondary Filter uses A-5594
Set Filter uses A-5595-S
H 1 : 460 (mm)
H 2 : 447 (mm)
OD 1 : 362 (mm)
OD 2 : 362 (mm)
ID 1 : 229 (mm)

CONT : 1
VOL : 0.068

111

A-5629 Air Filter Primary Metal End Cap Element
ISUZU 1-14125082-0
ISUZU 1-14215082-0
CATERPILLAR 3I-0202



Secondary Filter uses A-5630
Set Filter uses A-5629-S
H 1 : 622 (mm)
H 2 : 609.5 (mm)
OD 1 : 307 (mm)
OD 2 : 307 (mm)
ID 1 : 196 (mm)
ID 2 : 22.7 (mm)

CONT : 1
VOL : 0.071

116

A-5582 Air Filter Secondary Soft PU end cap Element
CATERPILLAR 102-9387



Set Filter uses A-5583-S
H 1 : 171 (mm)
H 2 : 165 (mm)
OD 1 : 108 (mm)
OD 2 : 101 (mm)
ID 1 : 68.5 (mm)

CONT : 25
VOL : 0.073

107

A-5594 Air Filter Secondary Soft PU end cap Element
CATERPILLAR 1063973



Primary Filter uses A-5593
Set Filter uses A-5595-S
H 1 : 451 (mm)
OD 1 : 229 (mm)
OD 2 : 219 (mm)
ID 1 : 175 (mm)

CONT : 1
VOL : 0.027

112

A-5629-S Air Filter Set Metal End Cap Element
HITACHI 4240294+4240295
KOMATSU
561-02-12330+561-02-12320



Primary Filter uses A-5629
Secondary Filter uses A-5630
H 1 : 622 (mm)
H 2 : 609.5 (mm)
OD 1 : 307 (mm)
OD 2 : 307 (mm)
ID 1 : 196 (mm)
ID 2 : 22.7 (mm)

CONT : 1
VOL : 0.071

117

A-5583-S Air Filter Set Soft PU end cap Element
CATERPILLAR 102-9388+102-9387



Primary Filter uses A-5581
Secondary Filter uses A-5582
H 1 : 189.5 (mm)
H 2 : 177 (mm)
OD 1 : 207 (mm)
OD 2 : 207 (mm)
ID 1 : 105.5 (mm)

CONT : 9
VOL : 0.097

108

A-5595-S Air Filter Set Soft PU end cap Element
CATERPILLAR 106-3969+106-3973



Primary Filter uses A-5593
Secondary Filter uses A-5594
H 1 : 460 (mm)
H 2 : 447 (mm)
OD 1 : 362 (mm)
OD 2 : 362 (mm)
ID 1 : 229 (mm)

CONT : 1
VOL : 0.070

113

A-5630 Air Filter Secondary Metal End Cap Element
ISUZU 1-14215081-0
CATERPILLAR 3I-0203
HITACHI 4240295



Primary Filter uses A-5629
Set Filter uses A-5629-S
H 1 : 596.7 (mm)
H 2 : 584 (mm)
OD 1 : 185 (mm)
OD 2 : 185 (mm)
ID 1 : 157.5 (mm)
ID 2 : 17 (mm)

CONT : 1
VOL : 0.025

118

A-5584 Air Filter Soft PU framed Element
CATERPILLAR 112-7448



H 1 : 48 (mm)
Length 1 : 287 (mm)
Width 1 : 226 (mm)

CONT : 20
VOL : 0.078

109

A-5596 Air Filter Soft PU end cap Element
CATERPILLAR 9L-2169



H 1 : 35 (mm)
H 2 : 32 (mm)
OD 1 : 77 (mm)
OD 2 : 77 (mm)
ID 1 : 39 (mm)
ID 2 : 39 (mm)

CONT : 100
VOL : 0.038

114

A-5663-S Air Filter Set Metal End Cap Element
KOMATSU 600-181-6050



Primary Filter uses A-5627
Secondary Filter uses A-6008
H 1 : 380 (mm)
H 2 : 330 (mm)
OD 1 : 235 (mm)
OD 2 : 187 (mm)
ID 1 : 120 (mm)
ID 2 : 17 (mm)

CONT : 1
VOL : 0.030

119

A-5590 Air Filter Secondary Metal End Cap Element
CATERPILLAR 101-1460
CATERPILLAR 4N-0313



Primary Filter uses AS-5591
Set Filter uses AS-5592-S
H 1 : 247.3 (mm)
H 2 : 241 (mm)
OD 1 : 85.5 (mm)
OD 2 : 85.5 (mm)
ID 1 : 57.5 (mm)
ID 2 : 17 (mm)

CONT : 25
VOL : 0.062

110

A-5627 Air Filter Primary Metal End Cap Element
KOBELCO 2451-U311-3
DAEWOO 2474-6006A
DAEWOO 2474-6006B



Secondary Filter uses A-6008
Set Filter uses A-5663-S
H 1 : 393.7 (mm)
H 2 : 381 (mm)
OD 1 : 235 (mm)
OD 2 : 187 (mm)
ID 1 : 120 (mm)
ID 2 : 17 (mm)

CONT : 1
VOL : 0.026

115

A-5673 Air Filter Primary Soft PU end cap Element
YANMAR 172660-13840
CATERPILLAR 206-5234
KOMATSU 600-185-2510



Secondary Filter uses A-5674
Set Filter uses A-5675-S
H 1 : 392 (mm)
H 2 : 384 (mm)
OD 1 : 186 (mm)
OD 2 : 186 (mm)
ID 1 : 106 (mm)

CONT : 9
VOL : 0.169

120

Sakura Filter

Technical Specification

A-56731 Air Filter Primary Soft PU end cap Element
MANITOU 775479



Secondary Filter uses A-56741
Set Filter uses A-56731-S
H 1 : 394.5 (mm)
H 2 : 385 (mm)
OD 1 : 186 (mm)
OD 2 : 184 (mm)
ID 1 : 105.5 (mm)

CONT : 1
VOL : 0.000

121

A-5715 Air Filter Secondary Metal End Cap Element
CATERPILLAR 1N-4864
CUMMINS 3013213
CATERPILLAR 3I-0215



Primary Filter uses A-5718
Set Filter uses A-5718-S
H 1 : 571.75 (mm)
H 2 : 559 (mm)
OD 1 : 260 (mm)
OD 2 : 260 (mm)
ID 1 : 231.5 (mm)
ID 2 : 23 (mm)

CONT : 1
VOL : 0.047

126

A-6113 Air Filter Primary Metal End Cap Element
FIAT 01901779
ISUZU 1-14215046-0
NISSAN 16546-96017



Secondary Filter uses A-5408
Set Filter uses A-5653-S
H 1 : 418.7 (mm)
H 2 : 406 (mm)
OD 1 : 282 (mm)
OD 2 : 282 (mm)
ID 1 : 171 (mm)
ID 2 : 17 (mm)

CONT : 1
VOL : 0.038

131

A-56731-S Air Filter Set Soft PU end cap Element
MANITOU 77549+775480



Primary Filter uses A-56731
Secondary Filter uses A-56741
H 1 : 395 (mm)
H 2 : 385 (mm)
OD 1 : 186 (mm)
OD 2 : 184 (mm)
ID 1 : 87 (mm)

CONT : 0
VOL : 0.000

122

A-6006 Air Filter Primary Metal End Cap Element
ISUZU 1-14214108-0
ISUZU 1-14214153-0
ISUZU 1-14215060-0
NISSAN 16546-Z9010
TOYOTA 17801-2560



Secondary Filter uses A-6007
Set Filter uses A-6118-S
H 1 : 342.7 (mm)
H 2 : 330 (mm)
OD 1 : 232 (mm)
OD 2 : 232 (mm)
ID 1 : 147 (mm)
ID 2 : 23 (mm)

CONT : 4
VOL : 0.093

Note : For Flame Retardant version use A-60400

127

A-6118-S Air Filter Set Metal End Cap Element
NISSAN 16546-Z9025
NISSAN 16546-Z9027
CATERPILLAR 7Y-0404+7Y-0403



Primary Filter uses A-6006
Secondary Filter uses A-6007
H 1 : 343 (mm)
H 2 : 330 (mm)
OD 1 : 232 (mm)
OD 2 : 232 (mm)
ID 1 : 147 (mm)
ID 2 : 23 (mm)

CONT : 4
VOL : 0.097

132

A-56741 Air Filter Secondary Soft PU end cap Element
MANITOU 775480



Primary Filter uses A-56731
Set Filter uses A-56731-S
H 1 : 382.5 (mm)
H 2 : 378 (mm)
OD 1 : 106 (mm)
OD 2 : 100 (mm)
ID 1 : 87 (mm)

CONT : 0
VOL : 0.000

123

A-6007 Air Filter Secondary Metal End Cap Element
ISUZU 1-14215061-0
ISUZU 1-14215078-0
ISUZU 1-14215078-1



Primary Filter uses A-6006
Set Filter uses A-6118-S
H 1 : 317.7 (mm)
H 2 : 305 (mm)
OD 1 : 145 (mm)
OD 2 : 145 (mm)
ID 1 : 116.5 (mm)
ID 2 : 23 (mm)

CONT : 9
VOL : 0.078

Note : ID=17 MM uses A-6031

128

A-6211 Air Filter Primary Metal End Cap Element
MERCEDES-BENZ 001 094 46 04
DEUTZ 2165044



Secondary Filter uses A-6212
Set Filter uses A-6211-S
H 1 : 352.7 (mm)
H 2 : 340 (mm)
OD 1 : 164 (mm)
OD 2 : 164 (mm)
ID 1 : 87 (mm)
ID 2 : 8.5 (mm)

CONT : 9
VOL : 0.108

133

A-5675-S Air Filter Set Soft PU end cap Element
KOMATSU 600-185-2500



Primary Filter uses A-5673
Secondary Filter uses A-5674
H 1 : 392 (mm)
H 2 : 384 (mm)
OD 1 : 186 (mm)
OD 2 : 186 (mm)
ID 1 : 106 (mm)

CONT : 1
VOL : 0.018

124

A-6008 Air Filter Secondary Metal End Cap Element
ISUZU 1-14215047-0
ISUZU 1-1425-046-1
NISSAN 16546-96010



Primary Filter uses A-5627
Set Filter uses A-5663-S
H 1 : 330 (mm)
OD 1 : 146 (mm)
OD 2 : 116.5 (mm)
ID 1 : 88 (mm)
ID 2 : 17 (mm)

CONT : 9
VOL : 0.083

129

A-6703 Air Filter Primary Soft PU end cap Element
MERCEDES-BENZ 004 094 04 04
MASSEY-FERGUSON 3901475M1
BOBCAT 6910725
LIEBHERR 761 1451



Secondary Filter uses A-6705
Set Filter uses A-6706-S
H 1 : 375 (mm)
H 2 : 342 (mm)
OD 1 : 159 (mm)
OD 2 : 159 (mm)
ID 1 : 94 (mm)

CONT : 9
VOL : 0.118

134

A-5708 Air Filter Metal End Cap Element
CUMMINS 158877



H 1 : 266.75 (mm)
H 2 : 254 (mm)
OD 1 : 234 (mm)
OD 2 : 234 (mm)
ID 1 : 123 (mm)
ID 2 : 14 (mm)

CONT : 4
VOL : 0.072

125

A-6009 Air Filter Secondary Metal End Cap Element
NISSAN 16546-96004
KOBELCO 2451U180-3B
KOBELCO 2451U206-3
KOMATSU 600-181-8360
ISUZU 9-14215017-0



Primary Filter uses AS-1024
Set Filter uses AS-1024-S
H 1 : 397 (mm)
H 2 : 397 (mm)
OD 1 : 146.2 (mm)
OD 2 : 166.5 (mm)
ID 1 : 88 (mm)
ID 2 : 17 (mm)

CONT : 9
VOL : 0.101

130

A-6902 Air Filter Secondary Metal End Cap Element
CUMMINS 3013211
INGERSOLL RAND 35123520
CATERPILLAR 3I-0095



Primary Filter uses A-6903
Set Filter uses A-6903-S
H 1 : 571.7 (mm)
H 2 : 559 (mm)
OD 1 : 209.5 (mm)
OD 2 : 209.5 (mm)
ID 1 : 180.5 (mm)
ID 2 : 23 (mm)

CONT : 9
VOL : 0.265

135

Sakura Filter

Technical Specification

A-6903 Air Filter Primary Metal End Cap Element



CUMMINS 3013210
INGERSOLL RAND 35123512
CATERPILLAR 3I-0802

Secondary Filter uses A-6902
Set Filter uses A-6903-S
H 1 : 622.7 (mm)
H 2 : 610 (mm)
OD 1 : 324 (mm)
OD 2 : 324 (mm)
ID 1 : 212 (mm)
ID 2 : 23 (mm)

CONT : 1
VOL : 0.076

136

A-70280 Air Filter Primary Metal End Cap Element



CASE 317702R91
CATERPILLAR 65-6140
JOHN DEERE AH19853

H 1 : 317 (mm)
H 2 : 311 (mm)
OD 1 : 113 (mm)
OD 2 : 113 (mm)
ID 1 : 55 (mm)

CONT : 0
VOL : 0.000

141

A-7902 Air Filter Secondary Metal End Cap Element



HITACHI 4331920
CATERPILLAR 9Y-7663

Primary Filter uses A-9217
Set Filter uses A-9217-S
H 1 : 563.35 (mm)
H 2 : 550.6 (mm)
OD 1 : 276 (mm)
OD 2 : 276 (mm)
ID 1 : 207.5 (mm)
ID 2 : 22.7 (mm)

CONT : 1
VOL : 0.048

146

A-6903-S Air Filter Set Metal End Cap Element



INGERSOLL RAND
3013211+3013210

Primary Filter uses A-6903
Secondary Filter uses A-6902
H 1 : 622.7 (mm)
H 2 : 610 (mm)
OD 1 : 324 (mm)
OD 2 : 324 (mm)
ID 1 : 212 (mm)
ID 2 : 23 (mm)

CONT : 1
VOL : 0.073

137

A-76231 Air Filter Primary Soft PU end cap Element flame retardant media



CLARK 1241080
TOYOTA 17741-U3330-71
KOMATSU 3EC02A541E

H 1 : 356 (mm)
H 2 : 347 (mm)
OD 1 : 163.5 (mm)
OD 2 : 163.5 (mm)
ID 1 : 91 (mm)

CONT : 9
VOL : 0.116

Note : Flame Retardant version of A-5541

142

A-7912 Air Filter Primary Metal End Cap Element



HITACHI 408065
CASE 45252
STEIGER 45252
INGERSOLL RAND 506163930

Secondary Filter uses A-7915
Set Filter uses A-7912-S
H 1 : 469.75 (mm)
H 2 : 457 (mm)
OD 1 : 352 (mm)
OD 2 : 352 (mm)
ID 1 : 241 (mm)
ID 2 : 23 (mm)

CONT : 1
VOL : 0.070

147

A-7003 Air Filter Primary Soft PU end cap Element



FIAT 1930587
PERKINS 26510337
FIAT 366-08109

Secondary Filter uses A-7004
Set Filter uses A-7003-S
H 1 : 327.8 (mm)
H 2 : 319 (mm)
OD 1 : 138 (mm)
OD 2 : 138 (mm)
ID 1 : 81 (mm)

CONT : 1
VOL : 0.008

138

A-7626 Air Filter Secondary Soft PU end cap Element



CATERPILLAR 246-5010
JOHN DEERE AH174196
JOHN DEERE AH174196A

Primary Filter uses A-8686
Set Filter uses A-7627-S
H 1 : 624 (mm)
OD 1 : 229 (mm)
OD 2 : 219 (mm)
ID 1 : 175 (mm)

CONT : 1
VOL : 0.038

143

A-7912-S Air Filter Set Metal End Cap Element



VOLVO 4881174 + 4881175
EUCLID 9035992+9035993

Primary Filter uses A-7912
Secondary Filter uses A-7915
H 1 : 469.75 (mm)
H 2 : 457 (mm)
OD 1 : 352 (mm)
OD 2 : 352 (mm)
ID 1 : 241 (mm)
ID 2 : 23 (mm)

CONT : 1
VOL : 0.070

148

A-7004 Air Filter Secondary Soft PU end cap Element



FIAT 1930588
PERKINS 26510338

Primary Filter uses A-7003
Set Filter uses A-7003-S
H 1 : 319 (mm)
H 2 : 312 (mm)
OD 1 : 84 (mm)
OD 2 : 79 (mm)
ID 1 : 63 (mm)

CONT : 25
VOL : 0.082

139

A-7627-S Air Filter Set Soft PU end cap Element



NEW HOLLAND (CNH) 84432503 +
84432504

Primary Filter uses A-8686
Secondary Filter uses A-7626
H 1 : 633 (mm)
H 2 : 620 (mm)
OD 1 : 362 (mm)
OD 2 : 362 (mm)
ID 1 : 229 (mm)

CONT : 1
VOL : 0.101

144

A-7913 Air Filter Secondary Metal End Cap Element



NISSAN 16546-95010
CATERPILLAR 5W-2716
INTERNATIONAL HARVESTER
681545 R1

Primary Filter uses AS-5523
Set Filter uses AS-6116-S
H 1 : 383 (mm)
H 2 : 381 (mm)
OD 1 : 123 (mm)
OD 2 : 106 (mm)
ID 1 : 93 (mm)
ID 2 : 17 (mm)

CONT : 9
VOL : 0.074

149

A-70270 Air Filter Primary Metal End Cap Element



MASSEY-FERGUSON 1026191M91
ALLIS CHALMERS 2373959
CASE 313964R91
FORD DONN9B618B

H 1 : 269 (mm)
H 2 : 262 (mm)
OD 1 : 113 (mm)
OD 2 : 113 (mm)
ID 1 : 55 (mm)
ID 2 : 55 (mm)

CONT : 25
VOL : 0.113

140

A-76600 Air Filter Primary Soft PU end cap Element



CATERPILLAR 108-0671
JOHN DEERE AT175344

H 1 : 296 (mm)
H 2 : 284 (mm)
OD 1 : 207 (mm)
OD 2 : 207 (mm)
ID 1 : 105 (mm)

CONT : 4
VOL : 0.070

Note : Alternate parts A-4210

145

A-7915 Air Filter Secondary Metal End Cap Element



CATERPILLAR 1N-8164
CATERPILLAR 4N-9164
INGERSOLL RAND 50616408

Primary Filter uses A-7912
Set Filter uses A-7912-S
H 1 : 432.7 (mm)
H 2 : 423 (mm)
OD 1 : 220 (mm)
OD 2 : 220 (mm)
ID 1 : 179 (mm)
ID 2 : 23 (mm)

CONT : 4
VOL : 0.104

150

Sakura Filter

Technical Specification

A-7964 Air Filter Secondary Metal End Cap Element

IVECO 08015449
MASSEY-FERGUSON 1093683M91
FIAT-ALLIS 1909964



Primary Filter uses AS-7988
Set Filter uses AS-7988-S
H 1 : 357 (mm)
H 2 : 355.5 (mm)
OD 1 : 105 (mm)
OD 2 : 85.5 (mm)
ID 1 : 73.5 (mm)
ID 2 : 17 (mm)

CONT : 25
VOL : 0.141

Note : Is a Secondary Air filter for
AS-7988,AS-7813,AS-7805,AS-4304

151

A-8506 Air Filter Primary Soft PU end cap Element

CASE 222425A1
ISUZU 8-97231900-0
JOHN DEERE KV16428



Secondary Filter uses A-8565

H 1 : 330.8 (mm)
H 2 : 322 (mm)
OD 1 : 138 (mm)
OD 2 : 138 (mm)
ID 1 : 81 (mm)

CONT : 12
VOL : 0.099

156

A-8508M-S Air Filter Set Soft PU+Metal Element

CATERPILLAR 1318822+1318821



Primary Filter uses A-8508M
Secondary Filter uses A-8507
H 1 : 343 (mm)
H 2 : 330 (mm)
OD 1 : 237 (mm)
OD 2 : 237 (mm)
ID 1 : 132 (mm)

CONT : 1
VOL : 0.024

161

A-7967 Air Filter Secondary Metal End Cap Element

ISUZU 1-14215089-0
NISSAN 16546-96065
KOBELCO 2446U250S-2



Primary Filter uses A-1828
Set Filter uses A-1840-S
H 1 : 495.7 (mm)
H 2 : 483 (mm)
OD 1 : 162.3 (mm)
OD 2 : 162.3 (mm)
ID 1 : 134 (mm)
ID 2 : 17 (mm)

CONT : 9
VOL : 0.152

152

A-8506-S Air Filter Set Soft PU end cap Element

CASE 222425A1+222429A1
JOHN DEERE KV16428+AP33331



Primary Filter uses A-8506
Secondary Filter uses A-8565
H 1 : 330.8 (mm)
H 2 : 322 (mm)
OD 1 : 138 (mm)
OD 2 : 138 (mm)
ID 1 : 81 (mm)

CONT : 12
VOL : 0.099

157

A-85134 Air Filter Primary Soft PU end cap Element

KOMATSU 3EB01A5391
TCM 53651-72061
CATERPILLAR 91B6100912



Secondary Filter uses A-5569
Set Filter uses A-85134-S
H 1 : 273.5 (mm)
H 2 : 265 (mm)
OD 1 : 104 (mm)
OD 2 : 104 (mm)
ID 1 : 61 (mm)

CONT : 25
VOL : 0.110

Note : Is a Flame Retardant Media Version From A-8513

162

A-8103 Air Filter Secondary Soft PU end cap Element

WIRTGEN 191525
CATERPILLAR 245-3819
ATLAS COPCO 2914-5018-00



Primary Filter uses A-8649
Set Filter uses A-8649-S
H 1 : 577 (mm)
H 2 : 572 (mm)
OD 1 : 196 (mm)
OD 2 : 194 (mm)
ID 1 : 179 (mm)

CONT : 9
VOL : 0.244

153

A-8507 Air Filter Secondary Soft PU end cap Element

CATERPILLAR 131-8821



Primary Filter uses A-8508
Set Filter uses A-8604-S
H 1 : 323 (mm)
H 2 : 317 (mm)
OD 1 : 134 (mm)
OD 2 : 125 (mm)
ID 1 : 95.5 (mm)

CONT : 25
VOL : 0.187

158

A-85400 Air Filter Hard PU end cap Element inside-out flow

FIAT-ALLIS 70185824
CLARK 945755
FARR P48



H 1 : 205 (mm)
Length 1 : 502 (mm)
Width 1 : 385 (mm)

CONT : 1
VOL : 0.051

Note : 48 Tubes--6 x 8

163

A-8504 Air Filter Primary Soft PU end cap Element

YANMAR 119655-12560
KOMATSU 11965512560
KUBOTA 1G659-11220



Secondary Filter uses A-7618
Set Filter uses A-7620-S
H 1 : 187 (mm)
H 2 : 179 (mm)
OD 1 : 88.5 (mm)
OD 2 : 88.5 (mm)
ID 1 : 46 (mm)

CONT : 25
VOL : 0.055

154

A-8508 Air Filter Primary Soft PU end cap Element

CATERPILLAR 131-8822



Secondary Filter uses A-8507
Set Filter uses A-8604-S
H 1 : 343 (mm)
H 2 : 330 (mm)
OD 1 : 237 (mm)
OD 2 : 237 (mm)
ID 1 : 132 (mm)

CONT : 1
VOL : 0.024

159

A-85410 Air Filter Hard PU end cap Element inside-out flow

CATERPILLAR 8T4566
CLARK 946595
FARR P64



H 1 : 206 (mm)
Length 1 : 500 (mm)
Width 1 : 500 (mm)

CONT : 1
VOL : 0.066

Note : 64 Tubes--8 x 8

164

A-8505 Air Filter Primary Soft PU end cap Element

OPEL 1#123 84 075
OPEL 1-12384075
SUNWARD 730403000155



Secondary Filter uses A-8599
Set Filter uses A-8602-S
H 1 : 312 (mm)
H 2 : 304 (mm)
OD 1 : 127.5 (mm)
OD 2 : 127.5 (mm)
ID 1 : 83 (mm)

CONT : 16
VOL : 0.109

Note : For Flame Retardant version, use A-76410

155

A-8508M Air Filter Primary Soft PU+Metal Element

CATERPILLAR 131-8822



Secondary Filter uses A-8507
Set Filter uses A-8508M-S
H 1 : 343 (mm)
H 2 : 330 (mm)
OD 1 : 237 (mm)
OD 2 : 237 (mm)
ID 1 : 132 (mm)

CONT : 1
VOL : 0.024

160

A-8553 Air Filter Primary Soft PU end cap Element

YANMAR 129948-12621
VOLVO (TRUCK/VCE/VME/PENTA) 14255046
KUBOTA 1G377-11210



Secondary Filter uses A-8554
Set Filter uses A-8553-S
H 1 : 362 (mm)
H 2 : 328 (mm)
OD 1 : 149 (mm)
OD 2 : 149 (mm)
ID 1 : 84 (mm)

CONT : 12
VOL : 0.120

165

Sakura Filter

Technical Specification

A-8554 Air Filter Soft PU end cap Element

KHD(KLOCKNER-HUMBOLT-DEUTZ) 118 0870
YANMAR 129948-12630
VOLVO (TRUCK/VCE/VME/PENTA) 14255061
MASSEY-FERGUSON 3901465M2

H 1 : 345 (mm)
H 2 : 342 (mm)
OD 1 : 75 (mm)
OD 2 : 77 (mm)
ID 1 : 62 (mm)

CONT : 25
VOL : 0.104

166

A-8610 Air Filter Secondary Soft PU end cap Element

NEW HOLLAND (CNH) 1930592



Primary Filter uses A-7002
Set Filter uses A-70020-S
H 1 : 287.5 (mm)
H 2 : 281 (mm)
OD 1 : 59 (mm)
OD 2 : 58.5 (mm)
ID 1 : 45 (mm)

CONT : 25
VOL : 0.055

171

A-8686 Air Filter Primary Soft PU end cap Element

CATERPILLAR 246-5009
CASE-IH CNH 87417040
JOHN DEERE AH170798



Secondary Filter uses A-7626
Set Filter uses A-7627-S
H 1 : 633 (mm)
H 2 : 620 (mm)
OD 1 : 362 (mm)
OD 2 : 362 (mm)
ID 1 : 229 (mm)

CONT : 1
VOL : 0.091

176

A-8578 Air Filter Secondary Soft PU end cap Element

J.C.BAMFORD 32/912902
KOMATSU 42X01H0P01
KOMATSU 600-185-3120



Primary Filter uses A-8577
Set Filter uses A-8577-S
H 1 : 407.5 (mm)
H 2 : 401 (mm)
OD 1 : 107 (mm)
OD 2 : 100 (mm)
ID 1 : 87 (mm)

CONT : 25
VOL : 0.193

167

A-8651 Air Filter Secondary Soft PU end cap Element

HITACHI 4459548
KOMATSU 600-185-4220
JOHN DEERE F434395
CASE IH275810A1



Primary Filter uses A-8650
Set Filter uses A-8652-S
H 1 : 502 (mm)
H 2 : 497 (mm)
OD 1 : 150 (mm)
OD 2 : 141.5 (mm)
ID 1 : 109 (mm)

CONT : 9
VOL : 0.134

Note : Is a long life version of A-5103

172

A-9205 Air Filter Secondary Metal End Cap Element

CATERPILLAR 3I-0105
KOMATSU 581-02-12130
EUCLID 9038349



Primary Filter uses A-9218
Set Filter uses A-9218-S
H 1 : 571.75 (mm)
H 2 : 559 (mm)
OD 1 : 301.5 (mm)
OD 2 : 301.5 (mm)
ID 1 : 260.5 (mm)
ID 2 : 23 (mm)

CONT : 1
VOL : 0.063

177

A-8580 Air Filter Secondary Soft PU end cap Element

CATERPILLAR 142-1403
ATLAS COPCO 3222-1881-92
HITACHI 4466268



Primary Filter uses A-8579
Set Filter uses A-8579-S
H 1 : 500 (mm)
H 2 : 494 (mm)
OD 1 : 179 (mm)
OD 2 : 174 (mm)
ID 1 : 148 (mm)

CONT : 1
VOL : 0.019

Note : Is a Secondary Air filter of A-8579M,A-8665M

168

A-8665M Air Filter Primary Soft PU+Metal Element

SCANIA 1387548



Secondary Filter uses A-83090
Set Filter uses A-86651M-S
H 1 : 544 (mm)
H 2 : 515 (mm)
OD 1 : 308 (mm)
OD 2 : 308 (mm)
ID 1 : 177.5 (mm)

CONT : 1
VOL : 0.060

Note : Is a Primary Air Filter of A-83090,A-8580

173

A-9226 Air Filter Primary Metal End Cap Element

MASSEY-FERGUSON 3074305 M1
CATERPILLAR 3I-0838



Secondary Filter uses A-6009
Set Filter uses A-9226-S
H 1 : 419.3 (mm)
H 2 : 406.5 (mm)
OD 1 : 234 (mm)
OD 2 : 234 (mm)
ID 1 : 123 (mm)
ID 2 : 17 (mm)

CONT : 4
VOL : 0.115

178

A-8599 Air Filter Secondary Soft PU end cap Element

KUBOTA 119005-12571
CASE 133721A1
HITACHI 4326841



Primary Filter uses A-8505
Set Filter uses A-8602-S
H 1 : 303.5 (mm)
H 2 : 298 (mm)
OD 1 : 83 (mm)
OD 2 : 79 (mm)
ID 1 : 64 (mm)

CONT : 25
VOL : 0.076

Note : Is a Secondary Air filter for A-5669,A-8505

169

A-8670 Air Filter Secondary Soft PU end cap Element

CASE 187472A1
CASE 187472A2
MASSEY-FERGUSON 4270036M1
NEW HOLLAND (CNH) 8602996



Primary Filter uses A-8671
Set Filter uses A-8672-S
H 1 : 385 (mm)
H 2 : 380 (mm)
OD 1 : 107.5 (mm)
OD 2 : 101.5 (mm)
ID 1 : 89 (mm)

CONT : 25
VOL : 0.152

174

AH-7001 Air Filter Rigid PU end cap Disposable Housing

FIAT 135637
DEUTZ 1356376
CATERPILLAR 3I-0008
FIAT 71356376
CATERPILLAR 8X-4575



H 1 : 179 (mm)
H 2 : 114 (mm)
Intake Connection Height : 35 (mm)
Outside Housing OD 1 : 116.5 (mm)
Outside Housing OD 2 : 116.5 (mm)
Intake Connection ID 1 : 47 (mm)

CONT : 18
VOL : 0.053

179

A-8604-S Air Filter Set Soft PU end cap Element

CATERPILLAR 1318822+1318821



Primary Filter uses A-8508
Secondary Filter uses A-8507
H 1 : 330 (mm)
H 2 : 317 (mm)
OD 1 : 237 (mm)
OD 2 : 237 (mm)
ID 1 : 130 (mm)

CONT : 1
VOL : 0.025

170

A-8678 Air Filter Soft PU end cap Element

CATERPILLAR 1G-7197
HATZ 409 529 00.0



H 1 : 92 (mm)
H 2 : 85 (mm)
OD 1 : 245 (mm)
OD 2 : 163 (mm)
ID 1 : 142 (mm)
ID 2 : 60 (mm)

CONT : 20
VOL : 0.106

175

AS-5523 Air Filter Primary Metal End Cap Element With Sleeve

NISSAN 16546-95009
KOBELCO 2446R277S5
FIAT 266787



Secondary Filter uses A-7913
Set Filter uses AS-6116-S
H 1 : 418.7 (mm)
H 2 : 406 (mm)
OD 1 : 225 (mm)
OD 2 : 174 (mm)
ID 1 : 107.5 (mm)
ID 2 : 17 (mm)

CONT : 4
VOL : 0.115

180

Sakura Filter

Technical Specification

AS-5656-S Air Filter Set Metal End Cap Element With Sleeve
KOMATSU 600-181-9500



Primary Filter uses AS-7805
Secondary Filter uses A-7806
H 1 : 392 (mm)
H 2 : 381 (mm)
OD 1 : 199.3 (mm)
OD 2 : 155 (mm)
ID 1 : 88 (mm)
ID 2 : 17 (mm)

CONT : 9
VOL : 0.169

181

AS-8577 Air Filter Primary Soft PU end cap Element With Sleeve



CATERPILLAR 1527217
J.C.BAMFORD 32/912901
NEW HOLLAND (CNH) 82034620
FENDT H51520090100

Secondary Filter uses A-8578
Set Filter uses AS-8577-S
H 1 : 423 (mm)
H 2 : 410 (mm)
OD 1 : 207 (mm)
OD 2 : 207 (mm)
ID 1 : 106.5 (mm)

CONT : 1
VOL : 0.022

Note : For Flame Retardant version use AS-85774

186

C-1906 Oil Filter Full Flow Spin-On



FORDFINISCODE 1564767
FORD 1565486
FORD E8NN 6714 AA

H 1 : 94 (mm)
OD 1 : 96 (mm)
Thread Size : 3/4-16 UNF-2B
Gasket Type : Square

CONT : 12
VOL : 0.018

191

AS-5708 Air Filter Metal End Cap Element With Sleeve



CUMMINS 158877
CUMMINS 299353

H 1 : 266.75 (mm)
H 2 : 254 (mm)
OD 1 : 296 (mm)
OD 2 : 234 (mm)
ID 1 : 123 (mm)
ID 2 : 14 (mm)

CONT : 1
VOL : 0.027

Note : Sleeve On E/C "B" Type Uses AS-5709

182

C-1005 Oil Filter Full Flow Spin-On



MITSUBISHI K466201
MITSUBISHI MD 013661

H 1 : 125 (mm)
OD 1 : 90 (mm)
Thread Size : M20X1.5-6H
BPV (kg/cm2) : 1.0
ADBV : YES
Gasket Type : Round

CONT : 25
VOL : 0.035

187

C-5102 Oil Filter Full Flow Spin-On



PERKINS 26540347
PERKINS 2654407

H 1 : 168 (mm)
OD 1 : 93 (mm)
Thread Size : 3/4-16 UNF-2B
BPV (kg/cm2) : 1.0
ADBV : YES
Gasket Type : Square

CONT : 25
VOL : 0.050

192

AS-7805 Air Filter Primary Metal End Cap Element With Sleeve



IVECO 08014390
MASSEY-FERGUSON 1093682M91
ISUZU 14215-166

Secondary Filter uses A-7806
Set Filter uses AS-5656-S
H 1 : 392 (mm)
H 2 : 381 (mm)
OD 1 : 199 (mm)
OD 2 : 155 (mm)
ID 1 : 88 (mm)
ID 2 : 17 (mm)
Gasket Type : Square

CONT : 9
VOL : 0.169

Note : Long Life Versions Uses AS-7813

183

C-1011 Oil Filter Full Flow Spin-On



NISSAN 15208-HC400
HINO 15607-1920
MAZDA JEYO-14-302

H 1 : 85 (mm)
OD 1 : 68 (mm)
Thread Size : M20X1.5-6H
BPV (kg/cm2) : 1.0
ADBV : YES
Gasket Type : Round

CONT : 50
VOL : 0.026

Note : Square version uses C-1030

188

C-5103 Oil Filter Full Flow Spin-On



MASSEY-FERGUSON 1447082-M1
MASSEY-FERGUSON 1447082-M91
PERKINS 2654408

H 1 : 140 (mm)
OD 1 : 76 (mm)
Thread Size : 3/4-16 UNF-2B
BPV (kg/cm2) : 1.0
Gasket Type : Square

CONT : 50
VOL : 0.053

193

AS-7989 Air Filter Primary Metal End Cap Element With Sleeve



KOBELCO 2446U264S2
CATERPILLAR 616434

Secondary Filter uses A-7611
Set Filter uses AS-7989-S
H 1 : 317.8 (mm)
H 2 : 305 (mm)
OD 1 : 200 (mm)
OD 2 : 216.5 (mm)
ID 1 : 88 (mm)
ID 2 : 17 (mm)

CONT : 4
VOL : 0.078

184

C-1123 Oil Filter Full Flow Spin-On



TOYOTA 00120-00009
TOYOTA 00120-00010
TOYOTA 00120-00014
CHRYSLER 04105409AC
CHRYSLER 04105409BB

H 1 : 85 (mm)
OD 1 : 76 (mm)
Thread Size : 3/4-16 UNF-2B
BPV (kg/cm2) : 1.0
ADBV : YES
Gasket Type : Square

CONT : 50
VOL : 0.031

189

C-51070 Oil Filter Full Flow Spin-On



PERKINS 2654A111

H 1 : 206 (mm)
OD 1 : 94 (mm)
Thread Size : M24X1.5-6H
Gasket Type : Square

CONT : 12
VOL : 0.030

194

AS-7989-S Air Filter Set Metal End Cap Element With Sleeve



CATERPILLAR 61-6434+31-0266

Primary Filter uses AS-7989
Secondary Filter uses A-7611
H 1 : 317.7 (mm)
H 2 : 305 (mm)
OD 1 : 200 (mm)
OD 2 : 216.5 (mm)
ID 1 : 88 (mm)
ID 2 : 17 (mm)

CONT : 4
VOL : 0.078

185

C-1720 Oil Filter Full Flow Spin-On



TCM 12163-82302
YANMAR 129150-35152

H 1 : 100 (mm)
OD 1 : 90 (mm)
Thread Size : M20X1.5-6H
BPV (kg/cm2) : 1.0
ADBV : YES
Gasket Type : Round

CONT : 36
VOL : 0.040

190

C-5504 Oil Filter Full Flow Spin-On



CATERPILLAR 1R-0734
CATERPILLAR 9L-9054
CATERPILLAR 9L-9200

H 1 : 143 (mm)
OD 1 : 93 (mm)
Thread Size : 1-12 UNF-2B
BPV (kg/cm2) : 1.0
Gasket Type : Square

CONT : 25
VOL : 0.041

195

Sakura Filter

Technical Specification

C-5505 Oil Filter Full Flow Spin-On

CATERPILLAR 1R-0714
HITACHI 4429728
FIAT 71455273
MITSUBISHI ME034878
MITSUBISHI ME088519



H 1 : 162 (mm)
OD 1 : 108 (mm)
Thread Size : 1 1/8-16 UNF-2B
Gasket Type : Square

CONT : 12
VOL : 0.034

196

C-5522 Oil Filter Full Flow Spin-On With Microfiber media

CATERPILLAR 3Y-0900x



H 1 : 265 (mm)
OD 1 : 108 (mm)
Thread Size : 1 1/8-16 UNF-2B
Gasket Type : Square

CONT : 6
VOL : 0.025

201

C-5811 Oil Filter Full Flow Spin-On

MITSUBISHI 32A40-00100
MITSUBISHI 32A40-00101
MITSUBISHI 32A40-00400



H 1 : 100 (mm)
OD 1 : 102 (mm)
Thread Size : 1-12 UNF-2B
BPV (kg/cm2) : 1.0
ADBV : YES
Gasket Type : Square

CONT : 12
VOL : 0.021

206

C-5506 Oil Filter Full Flow Spin-On

CATERPILLAR 1R-0739



H 1 : 255 (mm)
OD 1 : 108 (mm)
Thread Size : 1 1/8-16 UNF-2B

CONT : 6
VOL : 0.027

197

C-5703 Oil Filter Full Flow Spin-On

HYUNDAI 11E1-70110
GENERAL MOTORS 25011995
CUMMINS 3903224
KOMATSU 6732-51-5140
CASE J908616



H 1 : 135 (mm)
OD 1 : 93 (mm)
Thread Size : 1-16 UNF-2B
Gasket Type : Square

CONT : 12
VOL : 0.018

202

C-6202 Oil Filter Full Flow Spin-On

DEMAG 206 089 40
RENAULT 60 05 024 443



H 1 : 140 (mm)
OD 1 : 93 (mm)
Thread Size : 1-12 UNF-2B
BPV (kg/cm2) : 1.0
Gasket Type : Square

CONT : 25
VOL : 0.041

Note : Without Nut

207

C-5510 Oil Filter Full Flow Spin-On Cellulose media

CATERPILLAR 1R-0658
CATERPILLAR 1R-1807
CATERPILLAR 3Y-0900x
CATERPILLAR 3Y-900X



H 1 : 262 (mm)
OD 1 : 108 (mm)
Thread Size : 1 1/8-16 UNF-2B
Gasket Type : Square

CONT : 6
VOL : 0.023

Note : High performance grade uses C-5522 ,Aluminium Casting version uses C-5506

198

C-5704 Oil Filter Full Flow Spin-On Cellulose media

J.C.BAMFORD 02/910140
J.C.BAMFORD 02/910140A
CUMMINS 3903264



H 1 : 174 (mm)
OD 1 : 93 (mm)
Thread Size : 1-16 UNF-2B
Gasket Type : Square

CONT : 12
VOL : 0.023

Note : High Performance Grade Uses C-5730

203

C-6204 Oil Filter Full Flow Spin-On

MERCEDES-BENZ 001 184 96 01
DEUTZ 1173430
CATERPILLAR 5W-6017
ALLIS CHALMERS 61671600
EVOBUS 7.119.226.04



H 1 : 206 (mm)
OD 1 : 93 (mm)
Thread Size : 1-12 UNF-2B
BPV (kg/cm2) : 2.0 - 2.5
ADBV : YES
Gasket Type : Square

CONT : 25
VOL : 0.057

Note : With Grip

208

C-5516 Oil Filter Full Flow Spin-On

CATERPILLAR 1R-0716



H 1 : 286 (mm)
OD 1 : 118 (mm)
Thread Size : 1 1/2-16 UN-2B
Gasket Type : Square

CONT : 6
VOL : 0.036

199

C-5718 Oil Filter By Pass Spin-On

ISUZU 1-87310093-0
CATERPILLAR 1W-8845
J.C.BAMFORD 32/919502
HITACHI 4285964



H 1 : 246 (mm)
OD 1 : 115.5 (mm)
Thread Size : 1 3/8-16 UNF-2B

CONT : 6
VOL : 0.032

204

C-6218 Oil Filter Full Flow Spin-On

CATERPILLAR 1R-0734
FORD 5000 861
KUBOTA 60021-1623-0



H 1 : 140.5 (mm)
OD 1 : 93 (mm)
Thread Size : 1-12 UNF-2B
BPV (kg/cm2) : 1.0
Gasket Type : Square

CONT : 12
VOL : 0.022

209

C-5519 Oil Filter Full Flow Spin-On

CATERPILLAR 8N-9586
CATERPILLAR 9N-9586



H 1 : 135 (mm)
OD 1 : 93 (mm)
Thread Size : 1 1/8-16 UNF-2B
Gasket Type : Square

CONT : 24
VOL : 0.037

200

C-5808 Oil Filter Combination Spin-On

KOBELCO 2451U343-1
MITSUBISHI ME 088532



H 1 : 181 (mm)
OD 1 : 108 (mm)
Thread Size : M26X1.5-6H
BPV (kg/cm2) : 2.0

CONT : 12
VOL : 0.033

205

C-7005 Oil Filter Full Flow Spin-On

GENERAL MOTORS 25010971
CATERPILLAR 773899



H 1 : 260 (mm)
OD 1 : 122 (mm)
Thread Size : 1 1/2-12 UNF-2B
Gasket Type : Square

CONT : 6
VOL : 0.035

210

Sakura Filter

Technical Specification

C-7105 Oil Filter Full Flow Spin-On

VOLVO 478736
VOLVO 478736-2
RENAULT 5 001 846 642



H 1 : 259 (mm)
OD 1 : 108 (mm)
Thread Size : 1 1/8-16 UNF-2B
Gasket Type : Square

CONT : 6
VOL : 0.026

211

CA-5501 Cabin Air Filter Metal framed Element

CATERPILLAR 7T-7358

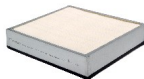

H 1 : 65.7 (mm)
Length 1 : 325 (mm)
Width 1 : 306 (mm)

CONT : 5
VOL : 0.053

216

CA-55120 Cabin Air Filter Metal framed Element

CATERPILLAR 9X-8216



H 1 : 60.5 (mm)
Length 1 : 684 (mm)
Width 1 : 153 (mm)

CONT : 10
VOL : 0.096

221

C-7911 Oil Filter Full Flow Spin-On

DEUTZ 1174420
FIAT 1174420
CROSLAND 2038



H 1 : 259 (mm)
OD 1 : 108 (mm)
Thread Size : 1 1/8-16 UNF-2B
Gasket Type : Square

CONT : 6
VOL : 0.029

212

CA-55060 Cabin Air Filter Metal framed Element

CATERPILLAR 119-3355
CATERPILLAR 268-6704



H 1 : 65.35 (mm)
Length 1 : 405 (mm)
Width 1 : 200 (mm)

CONT : 10
VOL : 0.079

217

CA-55130 Cabin Air Filter Metal framed Element

CATERPILLAR 180-7487



H 1 : 65.5 (mm)
H 2 : 55.5 (mm)
Length 1 : 427 (mm)
Width 1 : 298 (mm)

CONT : 10
VOL : 0.116

222

C-7916 Oil Filter Combination Spin-On

CATERPILLAR 5I-7950
CATERPILLAR 5I-7950X



H 1 : 220 (mm)
OD 1 : 108 (mm)
Thread Size : M32X1.5-6H
Gasket Type : Round

CONT : 6
VOL : 0.022

213

CA-55070 Cabin Air Filter Metal framed Element

CATERPILLAR 7X-6041



H 1 : 65.35 (mm)
H 2 : 55.6 (mm)
Length 1 : 311 (mm)
Width 1 : 243 (mm)

CONT : 5
VOL : 0.032

218

CA-55140 Cabin Air Filter Metal framed Element

CATERPILLAR 6T-0988



H 1 : 65.5 (mm)
H 2 : 55.5 (mm)
Length 1 : 539 (mm)
Width 1 : 150 (mm)

CONT : 10
VOL : 0.073

223

C-7955 Oil Filter Full Flow Spin-On

VALMET, VALTRA TRACTOR,
VALTRA-VL 20147133
STEYR-DAIMLER-PUCH
620.00.070.744



H 1 : 147 (mm)
OD 1 : 108 (mm)
Thread Size : M24X1.5-6H
Gasket Type : Square

CONT : 12
VOL : 0.031

214

CA-55100 Cabin Air Filter Foam Element

CATERPILLAR 186-8228



H 1 : 20 (mm)
Length 1 : 385 (mm)
Width 1 : 145 (mm)

CONT : 20
VOL : 0.046

219

CA-55150 Cabin Air Filter Metal framed Element

CATERPILLAR 232-1732



H 1 : 65.5 (mm)
Length 1 : 380 (mm)
Width 1 : 102 (mm)

CONT : 20
VOL : 0.073

Note : uses 2 filter per application

224

CA-44360 Cabin Air Filter Metal End Cap Element With Wing Nut

CATERPILLAR 211-2661



H 1 : 240.5 (mm)
H 2 : 227.8 (mm)
OD 1 : 155 (mm)
OD 2 : 155 (mm)
ID 1 : 88 (mm)
ID 2 : 17 (mm)

CONT : 12
VOL : 0.103

215

CA-55110 Cabin Air Filter Soft PU framed Element

CATERPILLAR 211-2660



H 1 : 37.5 (mm)
Length 1 : 404 (mm)
Width 1 : 168 (mm)

CONT : 20
VOL : 0.107

220

CA-55160 Cabin Air Filter Soft PU framed Element

CATERPILLAR 259-3222



H 1 : 59.7 (mm)
Length 1 : 366.9 (mm)
Length 2 : 355.8 (mm)
Width 1 : 153.3 (mm)
Width 2 : 142.9 (mm)

CONT : 20
VOL : 0.113

225

Sakura Filter

Technical Specification

CA-55170 Cabin Air Filter Plastic framed Element
CATERPILLAR 327-6618



H 1 : 47.5 (mm)
Length 1 : 254 (mm)
Length 2 : 224.5 (mm)
Width 1 : 189 (mm)
Width 2 : 173.5 (mm)

CONT : 20
VOL : 0.099

Note : For Carbon or Anti Virus type please check CAC or CAV number. 226

EF-55040 Fuel Filter Eco Element
CATERPILLAR 360-8960



H 1 : 155.5 (mm)
H 2 : 140.5 (mm)
OD 1 : 82 (mm)
OD 2 : 66.5 (mm)
ID 1 : 15.2 (mm)

CONT : 50
VOL : 0.065

231

EH-55060 Hydraulic Oil Filter Transmission Eco Element
CATERPILLAR 348-1861



H 1 : 222 (mm)
H 2 : 202 (mm)
OD 1 : 82 (mm)
OD 2 : 82 (mm)
ID 1 : 40 (mm)
ID 2 : 31 (mm)

CONT : 25
VOL : 0.046

236

CA-55850 Cabin Air Filter Metal framed Element
CATERPILLAR 4I-1278



H 1 : 24 (mm)
Length 1 : 600 (mm)
Width 1 : 123.5 (mm)

CONT : 10
VOL : 0.033

227

EF-55050 Fuel Filter Eco Element
CATERPILLAR 479-4131



H 1 : 227 (mm)
OD 1 : 81.8 (mm)
OD 2 : 70 (mm)
ID 1 : 32 (mm)
ID 2 : 15 (mm)
Thread Size : M14X4

CONT : 50
VOL : 0.095

232

EH-55070 Hydraulic Oil Filter Transmission Eco Element
CATERPILLAR 348-1862



H 1 : 120 (mm)
H 2 : 100 (mm)
OD 1 : 82 (mm)
OD 2 : 82 (mm)
ID 1 : 39.6 (mm)
ID 2 : 31 (mm)

CONT : 25
VOL : 0.027

237

CAC-55170 Cabin Air Filter Plastic framed Element with activated charcoal
CATERPILLAR 327-6618



H 1 : 47.5 (mm)
Length 1 : 254 (mm)
Length 2 : 224.5 (mm)
Width 1 : 189 (mm)
Width 2 : 173.5 (mm)

CONT : 20
VOL : 0.103

Note : For Standard or Anti Virus type please check CA or CAV number. 228

EH-55010 Hydraulic Oil Filter Transmission Eco Element with adhesive
CATERPILLAR 1R-1809
CATERPILLAR 328-3655
CATERPILLAR 338-3540



H 1 : 266 (mm)
OD 1 : 124 (mm)
OD 2 : 123 (mm)
ID 1 : 52 (mm)

CONT : 20
VOL : 0.103

Note : Hight efficiency 233

EO-55010 Oil Filter Full Flow Eco Element
CATERPILLAR 322-3155



H 1 : 221.5 (mm)
OD 1 : 102.8 (mm)
OD 2 : 78 (mm)
ID 1 : 26.5 (mm)

CONT : 25
VOL : 0.075

238

CAV-55170 Cabin Air Filter Plastic framed Element antiviral, antibacterial
CATERPILLAR 327-6618



H 1 : 47.5 (mm)
Length 1 : 254 (mm)
Length 2 : 224.5 (mm)
Width 1 : 189 (mm)
Width 2 : 173.5 (mm)

CONT : 20
VOL : 0.099

Note : For Standard or Carbon type please check CA or CAC number. 229

EH-55040 Hydraulic Oil Filter Return Eco Element
CATERPILLAR 362-1163



H 1 : 298 (mm)
H 2 : 274 (mm)
OD 1 : 107 (mm)
OD 2 : 107 (mm)
ID 1 : 38 (mm)

CONT : 25
VOL : 0.139

234

ES-55010 Fuel/Water Separator Eco Element
CATERPILLAR 479-4133



H 1 : 190.5 (mm)
H 2 : 152.5 (mm)
OD 1 : 81.8 (mm)
OD 2 : 67 (mm)
ID 1 : 34 (mm)

CONT : 50
VOL : 0.078

239

EF-55030 Fuel Filter Eco Element
CATERPILLAR 360-8959



H 1 : 234 (mm)
H 2 : 181 (mm)
OD 1 : 82 (mm)
OD 2 : 66.5 (mm)
ID 1 : 15.2 (mm)

CONT : 25
VOL : 0.055

230

EH-55050 Hydraulic Oil Filter Transmission Eco Element
CATERPILLAR 337-5270



H 1 : 272 (mm)
H 2 : 254 (mm)
OD 1 : 120.5 (mm)
OD 2 : 120.5 (mm)
ID 1 : 59 (mm)
ID 2 : 39 (mm)

CONT : 16
VOL : 0.077

235

F-5210 Fuel Filter Metal End Cap Element
YANMAR 129100-55650
KUBOTA 15521-43160
KUBOTA 607



H 1 : 89 (mm)
OD 1 : 50 (mm)
OD 2 : 50 (mm)
ID 1 : 20 (mm)

CONT : 50
VOL : 0.017

240

F-5501 Fuel Filter Metal End Cap Element

CATERPILLAR 4H-8792
CATERPILLAR 9H-4729



H 1 : 164 (mm)
H 2 : 160.5 (mm)
OD 1 : 88 (mm)
OD 2 : 88 (mm)
ID 1 : 25 (mm)
ID 2 : 25 (mm)

CONT : 25
VOL : 0.044

Note : Paper Protector

FC-1002 Fuel Filter Spin-On

MITSUBISHI ME 016823
MITSUBISHI ME 016872



H 1 : 100 (mm)
OD 1 : 90 (mm)
Thread Size : M20X1.5-6H
Gasket Type : Square

CONT : 50
VOL : 0.053

FC-5101 Fuel Filter Can-type Housing

MASSEY-FERGUSON 1896287M91
PEUGEOT 1906.12



H 1 : 113 (mm)
OD 1 : 84 (mm)
OD 2 : 87.3 (mm)
ID 1 : 19 (mm)
ID 2 : 19 (mm)

CONT : 50
VOL : 0.054

F-5503 Fuel Filter Metal End Cap Element

CATERPILLAR 5S-7645



H 1 : 69 (mm)
H 2 : 43.6 (mm)
OD 1 : 29 (mm)
OD 2 : 29 (mm)
Thread Stud Size : M4X0.7-6H

CONT : 100
VOL : 0.010

Note : Tread stud M4X0.7

FC-10022 Fuel Filter Spin-On

NISSAN AY500-MT002
MITSUBISHI ME 016823
MITSUBISHI ME229355



H 1 : 100 (mm)
OD 1 : 90 (mm)
Thread Size : M20X1.5-6H
Gasket Type : Round

CONT : 12
VOL : 0.014

Note : FC-1002(bottom plate difference)

FC-5103 Fuel Filter Can-type Housing

ALLIS CHALMERS 1919100
MANITOU 49660
CASE K915319



H 1 : 71 (mm)
OD 1 : 85 (mm)
OD 2 : 89 (mm)
ID 1 : 39 (mm)
ID 2 : 15 (mm)

CONT : 50
VOL : 0.036

F-5505 Fuel Filter Metal End Cap Element

CATERPILLAR 5M-7650
CATERPILLAR 5M-7663
CATERPILLAR 9M-2341



H 1 : 76 (mm)
OD 1 : 55.5 (mm)
OD 2 : 55.5 (mm)
ID 1 : 10 (mm)
ID 2 : 10 (mm)

CONT : 100
VOL : 0.034

Note : Paper Wire Mesh

FC-1007 Fuel Filter Spin-On

CATERPILLAR 103-2901
TOYOTA 233203391071



H 1 : 100 (mm)
H 2 : 100 (mm)
OD 1 : 80 (mm)
Thread Size : M20X1.5-6H
Gasket Type : Round

CONT : 50
VOL : 0.041

FC-51170 Fuel Filter Aluminium casting seat, Spin-On High Efficiency

PERKINS 2656F843
CATERPILLAR 299-8229
MANITOU 747351



H 1 : 144.8 (mm)
OD 1 : 86 (mm)
Thread Size : M12X1.5-6H
Gasket Type : Square

CONT : 12
VOL : 0.022

Note : with glass fiber media

F-6505 Fuel Filter Metal End Cap Element

EUCLID 5574961
GENERAL MOTORS 5574961



H 1 : 139 (mm)
H 2 : 134 (mm)
OD 1 : 74 (mm)
OD 2 : 74 (mm)
ID 1 : 26 (mm)
ID 2 : 26 (mm)

CONT : 50
VOL : 0.051

FC-1010 Fuel Filter Spin-On

MITSUBISHI ME035829



H 1 : 125 (mm)
OD 1 : 90 (mm)
Thread Size : M20X1.5-6H
Gasket Type : Square

CONT : 36
VOL : 0.048

Note : is a square version from FC-1003

FC-5501 Fuel Filter Spin-On

CATERPILLAR 1P-2299



H 1 : 174 (mm)
OD 1 : 93 (mm)
Thread Size : 1-14 UNS-2B
Gasket Type : Square

CONT : 25
VOL : 0.052

Note : High Performance Grade Uses FC-5523

FC-1001 Fuel Filter Spin-On

YANMAR 121857-55710
GENERAL MOTORS 13240032
MAZDA 1456-23-570A
DAIHATSU 23303-87308
DAIHATSU 23303-87308-000



H 1 : 140 (mm)
OD 1 : 95 (mm)
Thread Size : M20X1.5-6H
Thread Nut Size : M36X1.5-6H
Gasket Type : Round

CONT : 25
VOL : 0.042

Note : not for common rail engine

FC-1016 Fuel Filter Spin-On

MITSUBISHI ME 006066



H 1 : 80 (mm)
OD 1 : 90 (mm)
Thread Size : M20X1.5-6H
Gasket Type : Square

CONT : 36
VOL : 0.032

FC-5502 Fuel Filter Spin-On

CATERPILLAR 4N-5823



H 1 : 262 (mm)
OD 1 : 108 (mm)
Thread Size : 1-14 UNS-2B
Gasket Type : Square

CONT : 6
VOL : 0.023

Sakura Filter

Technical Specification

FC-5503 Fuel Filter Spin-On

CATERPILLAR 1R-0710
CATERPILLAR 9L-9100



H 1 : 144 (mm)
OD 1 : 93 (mm)
Thread Size : 15/16-16 UNF-2B
Gasket Type : Square

CONT : 12
VOL : 0.022

256

FC-5509 Fuel Filter Spin-On High Efficiency

INGERSOLL RAND 35362243



H 1 : 233 (mm)
OD 1 : 93 (mm)
Thread Size : 1-14 UNS-2B
Gasket Type : Square

CONT : 12
VOL : 0.036

Note : Is a short version of FC-5518

261

FC-5517 Fuel Filter Spin-On High Efficiency

CATERPILLAR 1R0762



H 1 : 266 (mm)
OD 1 : 93 (mm)
Thread Size : 1-14 UNS-2B
Gasket Type : Square

CONT : 12
VOL : 0.039

266

FC-5504 Fuel Filter Secondary Spin-On High Efficiency

CATERPILLAR 1R-0751
CATERPILLAR 1R-0759
CATERPILLAR 6I-4783



H 1 : 174 (mm)
OD 1 : 93 (mm)
Thread Size : 7/8-14 UNF-2B
Gasket Type : Square

CONT : 12
VOL : 0.025

Note : Aluminium casting & seamless version uses FC-5515

257

FC-5510 Fuel Filter Spin-On High Efficiency

CATERPILLAR 1R-0755



H 1 : 305 (mm)
OD 1 : 136 (mm)
Thread Size : 1 3/8-16 UNF-2B
Gasket Type : Square

CONT : 6
VOL : 0.049

Note : media 4 micron

262

FC-5519 Fuel Filter Spin-On High Efficiency

CATERPILLAR 1R-0712
YANMAR 424305-50060



H 1 : 240 (mm)
OD 1 : 93 (mm)
Thread Size : 1-14 UNS-2B
Gasket Type : Square

CONT : 12
VOL : 0.038

267

FC-5506 Fuel Filter Spin-On

CATERPILLAR 1R-0715
CATERPILLAR 8N-3080
CATERPILLAR 8N-3500



H 1 : 305 (mm)
OD 1 : 136 (mm)
Thread Size : 1 3/8-16 UNF-2B
Gasket Type : Square

CONT : 6
VOL : 0.046

258

FC-5515 Fuel Filter Secondary Aluminium casting seat, Spin-On High Efficiency

CATERPILLAR 1R-0751



H 1 : 180.4 (mm)
OD 1 : 86 (mm)
Thread Size : 7/8-14 UNF-2B

CONT : 12
VOL : 0.023

263

FC-5523 Fuel Filter Spin-On Synthetic Media

CATERPILLAR 1P-2299



H 1 : 174 (mm)
OD 1 : 93 (mm)
Thread Size : 1-14 UNS-2B
Gasket Type : Square

CONT : 12
VOL : 0.023

Note : Cellulose Media version uses FC-5501

268

FC-5507 Fuel Filter Secondary Spin-On High Efficiency

CATERPILLAR 1R-0740
CATERPILLAR 1R-0750
INGERSOLL RAND 35310549



H 1 : 174 (mm)
OD 1 : 93 (mm)
Thread Size : 1-14 UNS-2B
Gasket Type : Square

CONT : 12
VOL : 0.025

259

FC-55151 Fuel Filter Secondary Aluminium casting seat, Spin-On High Efficiency



H 1 : 180.4 (mm)
OD 1 : 86 (mm)
Thread Size : 7/8-14 UNF-2B

CONT : 12
VOL : 0.028

Note : FC-5515(Media difference)

264

FC-55300 Fuel Filter Primary Spin-On

CATERPILLAR 319-0844



H 1 : 174 (mm)
OD 1 : 93 (mm)
Thread Size : 1-14 UNS-2B

CONT : 12
VOL : 0.025

269

FC-5508 Fuel Filter Spin-On High Efficiency

CATERPILLAR 1R-0753



H 1 : 233 (mm)
OD 1 : 93 (mm)
Thread Size : 7/8-14 UNF-2B
Gasket Type : Square

CONT : 12
VOL : 0.036

260

FC-5516 Fuel Filter Spin-On High Efficiency

CATERPILLAR 1R-0751



H 1 : 176 (mm)
OD 1 : 80 (mm)
Thread Size : 7/8-14 UNF-2B
Gasket Type : Square

CONT : 12
VOL : 0.021

Note : Aluminium casting version uses FC-5515

265

FC-5704 Fuel Filter Spin-On

VOLVO 241672
VOLVO 243004
MASSEY-FERGUSON 2871513M1



H 1 : 123 (mm)
OD 1 : 76 (mm)
Thread Size : M16X1.5-6H
Gasket Type : Square

CONT : 50
VOL : 0.047

Note : With Center Tube

270

Sakura Filter

Technical Specification

FC-6205 Fuel Filter Spin-On

DEUTZ 1174424
CROSLAND 5003



H 1 : 79 (mm)
OD 1 : 76 (mm)
Thread Size : M16X1.5-6H
Gasket Type : Square

CONT : 50
VOL : 0.031

Note : With center tube

271

H-51170 Hydraulic Oil Filter Element

MASSEY-FERGUSON 516069-M94



H 1 : 181 (mm)
H 2 : 176 (mm)
OD 1 : 114 (mm)
OD 2 : 114 (mm)
ID 1 : 44.5 (mm)

CONT : 25
VOL : 0.071

276

H-5504 Hydraulic Oil Filter Metal End Cap Element

CATERPILLAR 1R-0719
CATERPILLAR 2M-3943
CATERPILLAR 9M-9740



H 1 : 234 (mm)
OD 1 : 101 (mm)
OD 2 : 101 (mm)
ID 1 : 59 (mm)
ID 2 : 59 (mm)

CONT : 20
VOL : 0.071

281

FC-6503 Fuel Filter Spin-On

GENERAL MOTORS 25010944
CATERPILLAR 3I-1220



H 1 : 141 (mm)
OD 1 : 93 (mm)
Thread Size : 1-12 UNF-2B
Gasket Type : Square

CONT : 25
VOL : 0.041

272

H-51250-05 Hydraulic Oil Filter Metal End Cap Element Synthetic Media

PALL HC9600FKP8H
PALL HC9600FKP8H OR Z
PALL HC9600FKP8Z



H 1 : 209 (mm)
H 2 : 205 (mm)
OD 1 : 78.5 (mm)
OD 2 : 78.5 (mm)
ID 1 : 41 (mm)

CONT : 0
VOL : 0.000

277

H-5505 Hydraulic Oil Filter Metal End Cap Element

CATERPILLAR 094-4412
HITACHI 4219713



H 1 : 455 (mm)
H 2 : 450 (mm)
OD 1 : 150 (mm)
OD 2 : 150 (mm)
ID 1 : 110 (mm)
ID 2 : 110 (mm)

CONT : 6
VOL : 0.081

Note : With outer packing 1 pc

282

FC-7903 Fuel Filter Secondary Spin-On High Efficiency

J.C.BAMFORD 02/910155
CUMMINS 3903640
CUMMINS 3931063



H 1 : 115 (mm)
OD 1 : 76 (mm)
Thread Size : M16X1.5-6H
Gasket Type : Square

CONT : 25
VOL : 0.023

273

H-5501 Hydraulic Oil Filter Metal End Cap Element

CATERPILLAR 1R-0730
CATERPILLAR 2P-5834



H 1 : 144 (mm)
OD 1 : 77 (mm)
OD 2 : 77 (mm)
ID 1 : 26 (mm)

CONT : 25
VOL : 0.033

278

H-5506 Hydraulic Oil Filter Metal End Cap Element with synthetic media

CATERPILLAR 1R-0722
CATERPILLAR 9J-0750
CATERPILLAR 9J-5461



H 1 : 278 (mm)
OD 1 : 130 (mm)
OD 2 : 130 (mm)
ID 1 : 84.4 (mm)
ID 2 : 84.4 (mm)

CONT : 15
VOL : 0.093

Note : metal version

283

FS-5701 Fuel Filter Metal body In-Line

CUMMINS 3826094
NEW HOLLAND (CNH) 86597473



H 1 : 96 (mm)
OD 1 : 44.5 (mm)
Inlet : 10 (mm)
Outlet : 10 (mm)

CONT : 12
VOL : 0.005

274

H-5502 Hydraulic Oil Filter Metal End Cap Element Cellulose media

CATERPILLAR 1R-0728
CATERPILLAR 4J-0816



H 1 : 228 (mm)
OD 1 : 79 (mm)
OD 2 : 79 (mm)
ID 1 : 47.5 (mm)
ID 2 : 47.5 (mm)

CONT : 25
VOL : 0.048

Note : Performance grade uses H-5508

279

H-5507 Hydraulic Oil Filter Wire Mesh supported Element

CATERPILLAR 3S-3865
CATERPILLAR 3S-3875
CATERPILLAR 3S-3875X



H 1 : 230 (mm)
OD 1 : 85.6 (mm)
OD 2 : 85.6 (mm)
ID 1 : 45.8 (mm)

CONT : 25
VOL : 0.066

284

H-5001 Hydraulic Oil Filter Metal End Cap Element With Microfiber media

TAMROCK 81893749
FORD E8NMF882BA
PALL HC9600FUS8H



H 1 : 208 (mm)
H 2 : 204 (mm)
OD 1 : 79 (mm)
OD 2 : 79 (mm)
ID 1 : 42 (mm)

CONT : 25
VOL : 0.040

275

H-5503 Hydraulic Oil Filter Metal End Cap Element

CATERPILLAR 1R-0720
CATERPILLAR 4J-6064



H 1 : 228 (mm)
OD 1 : 130 (mm)
OD 2 : 130 (mm)
ID 1 : 84.4 (mm)
ID 2 : 84.4 (mm)

CONT : 20
VOL : 0.105

Note : Performance grade uses H-5526

280

H-5509 Hydraulic Oil Filter Metal End Cap Element

CATERPILLAR 7J-0670
CATERPILLAR 7J-670



H 1 : 229 (mm)
OD 1 : 173 (mm)
OD 2 : 173 (mm)
ID 1 : 100 (mm)
ID 2 : 100 (mm)

CONT : 9
VOL : 0.083

285

Sakura Filter

Technical Specification

H-5510 Hydraulic Oil Filter Metal End Cap Element

CATERPILLAR 1R-0735
CATERPILLAR 4T-0522
CATERPILLAR 4T-0523



H 1 : 177.5 (mm)
OD 1 : 130 (mm)
OD 2 : 130 (mm)
ID 1 : 84.4 (mm)
ID 2 : 84.4 (mm)

CONT : 20
VOL : 0.083

Note : H-5510 lower efficiency than H-55101

H-5519 Hydraulic Oil Filter Metal End Cap Element

SUMITOMO KRJ 1599



H 1 : 291 (mm)
OD 1 : 112 (mm)
OD 2 : 112 (mm)
ID 1 : 70 (mm)
ID 2 : 70 (mm)

CONT : 9
VOL : 0.049

H-55320 Hydraulic Oil Filter Metal End Cap Element with synthetic media

CATERPILLAR 3I-0589



H 1 : 231.9 (mm)
OD 1 : 101 (mm)
OD 2 : 101 (mm)
ID 1 : 58 (mm)
ID 2 : 58 (mm)

CONT : 12
VOL : 0.044

H-55121 Hydraulic Oil Filter Suction Wire Mesh supported Element

CATERPILLAR 209-6000



H 1 : 136 (mm)
H 2 : 129 (mm)
OD 1 : 150 (mm)
OD 2 : 150 (mm)
ID 1 : 112.8 (mm)
Thread Size : M10X1.5-6H

CONT : 9
VOL : 0.045

Note : H-5512(Pleats media different)

H-5522 Hydraulic Oil Filter Element With Microfiber media

CATERPILLAR 179-9806



H 1 : 425 (mm)
H 2 : 416.6 (mm)
OD 1 : 142 (mm)
OD 2 : 142 (mm)
ID 1 : 97.2 (mm)
ID 2 : 97.2 (mm)

CONT : 4
VOL : 0.045

H-55440 Hydraulic Oil Filter Metal End Cap Element

CATERPILLAR 398-7171



H 1 : 406 (mm)
H 2 : 398 (mm)
OD 1 : 112 (mm)
OD 2 : 112 (mm)
ID 1 : 67 (mm)
ID 2 : 66 (mm)

CONT : 9
VOL : 0.073

Note : For CAT 312D2,315D,315D2

H-5513 Hydraulic Oil Filter Metal End Cap Element

HUPPENKOTHEN BAUMASCHINEN 1551200601T
CATERPILLAR 997352
CASE KHJ 1493



H 1 : 79 (mm)
H 2 : 75 (mm)
OD 1 : 51 (mm)
OD 2 : 53 (mm)
ID 1 : 23 (mm)

CONT : 50
VOL : 0.016

H-5526 Hydraulic Oil Filter Metal End Cap Element With Microfiber media

CATERPILLAR 4J-6064
CATERPILLAR 9W-6428



H 1 : 228 (mm)
OD 1 : 130 (mm)
OD 2 : 130 (mm)
ID 1 : 85 (mm)
ID 2 : 85 (mm)

CONT : 12
VOL : 0.062

H-57030 Hydraulic Oil Filter Metal End Cap Element

CASE-IH CNH 104929
CASE-IH CNH 105892
CATERPILLAR 3I0457
CATERPILLAR 3I0473
FIAT 4853388



H 1 : 408 (mm)
H 2 : 406 (mm)
OD 1 : 110 (mm)
OD 2 : 110 (mm)
ID 1 : 63 (mm)
ID 2 : 20 (mm)

CONT : 9
VOL : 0.069

H-5516 Hydraulic Oil Filter Suction Wire Mesh supported Element

CATERPILLAR 4S-8598



H 1 : 154 (mm)
OD 1 : 85.5 (mm)
OD 2 : 85.5 (mm)
ID 1 : 59 (mm)
ID 2 : 45.8 (mm)

CONT : 50
VOL : 0.074

H-55270 Hydraulic Oil Filter Metal End Cap Element with synthetic media

CATERPILLAR 4T-3131



H 1 : 231 (mm)
OD 1 : 101 (mm)
OD 2 : 101 (mm)
ID 1 : 59 (mm)
ID 2 : 59 (mm)

CONT : 12
VOL : 0.028

H-71190-08 Hydraulic Oil Filter Metal End Cap Element Synthetic Media

PALL HC9020FKN4H
PALL HC9020FKN4H OR Z
PALL HC9020FKN4Z



H 1 : 112 (mm)
H 2 : 108 (mm)
OD 1 : 45 (mm)
OD 2 : 45 (mm)
ID 1 : 24.7 (mm)

CONT : 0
VOL : 0.000

H-5517 Hydraulic Oil Filter Metal End Cap Element

MASSEY-FERGUSON 1495479M1



H 1 : 230 (mm)
OD 1 : 99 (mm)
OD 2 : 99 (mm)
ID 1 : 41 (mm)
ID 2 : 41 (mm)

CONT : 20
VOL : 0.073

H-55280 Hydraulic Oil Filter Metal End Cap Element with synthetic media

CATERPILLAR 132-8876
CATERPILLAR 4T-3132



H 1 : 228.2 (mm)
H 2 : 225 (mm)
OD 1 : 130 (mm)
OD 2 : 130 (mm)
ID 1 : 84.4 (mm)
ID 2 : 84.4 (mm)

CONT : 6
VOL : 0.031

H-71190-12 Hydraulic Oil Filter Metal End Cap Element Synthetic Media

VOLVO 11707525
MASSEY-FERGUSON 191855M4
PALL HC9020FKS4H
PALL HC9020FKS4Z



H 1 : 112 (mm)
H 2 : 108 (mm)
OD 1 : 45 (mm)
OD 2 : 45 (mm)
ID 1 : 24.7 (mm)

CONT : 0
VOL : 0.000

Sakura Filter

Technical Specification

H-7916 Hydraulic Oil Filter Metal End Cap Element With Microfiber media
PALL HC-9600FUP8H



H 1 : 207 (mm)
H 2 : 203 (mm)
OD 1 : 79 (mm)
OD 2 : 79 (mm)
ID 1 : 41.8 (mm)

CONT : 25
VOL : 0.054

301

HC-5503 Hydraulic Oil Filter Spin-On Synthetic Media
CATERPILLAR 1081153
INGERSOLL RAND 51302214
VOLVO BM 9658998



H 1 : 293 (mm)
OD 1 : 122 (mm)
Thread Size : 1 3/4-12 UNF-2B

CONT : 6
VOL : 0.032

Note : with Glass Fiber media

306

HC-5508 Hydraulic Oil Filter Spin-On Synthetic Media
KOMATSU 1281327H1
CASE 1346028C1
CATERPILLAR 9T5916



H 1 : 240 (mm)
OD 1 : 94.5 (mm)
Thread Size : 1 3/8-12 UNF-2B

CONT : 12
VOL : 0.036

Note : with Glass Fiber Media

311

H-79411 Hydraulic Oil Filter Metal End Cap Element
MASSEY-FERGUSON 1022883M1
CATERPILLAR 32-9868
MASSEY-FERGUSON 577492M91



H 1 : 176 (mm)
OD 1 : 113.8 (mm)
OD 2 : 113.8 (mm)
ID 1 : 44.7 (mm)
ID 2 : 44.7 (mm)

CONT : 10
VOL : 0.031

Note : with gaskets on end cap

302

HC-5504 Hydraulic Oil Filter Spin-On Synthetic Media
CASE 132575302
CATERPILLAR 1G-8878
NEW HOLLAND (CNH) 81863799



H 1 : 240 (mm)
OD 1 : 94.5 (mm)
Thread Size : 1 3/8-12 UNF-2B
Gasket Type : Square

CONT : 12
VOL : 0.035

Note : HC-7927 ==> cellulose media
HC-5504 ==> with glass fiber media

307

HC-5511 Hydraulic Oil Filter Spin-On
INTERNATIONAL HARVESTER
1976934C3
CATERPILLAR 4T-6788
CATERPILLAR 8J-1600



H 1 : 173 (mm)
OD 1 : 123 (mm)
Thread Size : 1 1/2-16 UN-2B
Gasket Type : Square

CONT : 6
VOL : 0.026

312

H-7942 Hydraulic Oil Filter Metal End Cap Element
CATERPILLAR 126-2081
CATERPILLAR 126-2081X



H 1 : 418 (mm)
H 2 : 415.5 (mm)
OD 1 : 142 (mm)
OD 2 : 142 (mm)
ID 1 : 97.4 (mm)
ID 2 : 97.4 (mm)

CONT : 6
VOL : 0.068

303

HC-5505 Hydraulic Oil Filter Spin-On Cellulose media
CATERPILLAR 184-3931
CATERPILLAR 4I3948



H 1 : 138 (mm)
OD 1 : 76 (mm)
Thread Size : 2-12 UNF-2B

CONT : 12
VOL : 0.016

Note : Glass Fiber media uses HC-55180

308

HC-55112 Hydraulic Oil Filter Spin-On
NEW HOLLAND (CNH) 86542664
CASE 87027972
CATERPILLAR 9T-5664
JOHN DEERE AT58368



H 1 : 173 (mm)
OD 1 : 123 (mm)
Top Thread Size : 1 1/2-16 UN-2B

CONT : 6
VOL : 0.025

313

H-86080-05 Hydraulic Oil Filter Metal End Cap Element Synthetic Media
HYDAC 0160D003BN3HC



H 1 : 115 (mm)
H 2 : 109.5 (mm)
OD 1 : 68.5 (mm)
OD 2 : 68.5 (mm)
ID 1 : 32.4 (mm)
ID 2 : 34 (mm)

CONT : 50
VOL : 0.039

304

HC-5506 Hydraulic Oil Filter Spin-On Synthetic Media
CATERPILLAR 3I0694
CASE A49386
JOHN DEERE AT112393



H 1 : 293 (mm)
OD 1 : 116 (mm)
Thread Size : 1 3/4-12 UNF-2B

CONT : 6
VOL : 0.034

Note : with glass fiber media

309

HC-5512 Hydraulic Oil Filter Spin-On Synthetic Media
CATERPILLAR 126-1817



H 1 : 293 (mm)
OD 1 : 116 (mm)
Thread Size : 1 3/4-12 UNF-2B

CONT : 6
VOL : 0.033

Note : Aluminium Casting

314

HC-5501 Hydraulic Oil Filter Transmission Spin-On
CATERPILLAR 4T-7948
DAEWOO D140182
DAEWOO D140182S



H 1 : 111 (mm)
OD 1 : 93 (mm)
Thread Size : 13/16-16 UNF-2B
Gasket Type : Square

CONT : 12
VOL : 0.018

305

HC-5507 Hydraulic Oil Filter Spin-On Synthetic Media
CATERPILLAR 144-6691
DEUTZ 4118911
CLARK 6661248
NEW HOLLAND (CNH) 920019190



H 1 : 152 (mm)
OD 1 : 94.5 (mm)
Thread Size : 1 3/8-12 UNF-2B

CONT : 12
VOL : 0.024

310

HC-5516 Hydraulic Oil Filter Aluminium casting seat, Spin-On Synthetic Media
CLARK 062827440
CATERPILLAR 1850337
CLARK 62827440
NEW HOLLAND (CNH) 86597482



H 1 : 240 (mm)
OD 1 : 76.5 (mm)
Thread Size : 2-12 UNF-2B

CONT : 12
VOL : 0.027

315

Sakura Filter

Technical Specification

HC-55170 Hydraulic Oil Filter Spin-On Synthetic Media

CATERPILLAR 1261813
CHARLES MACHINE 149939
CHARLES MACHINE 149939A
CATERPILLAR 311767
VERMEER 609135003



H 1 : 138 (mm)
OD 1 : 76 (mm)
Thread Size : 2-12 UNF-2B

CONT : 12
VOL : 0.015

Note : efficiency 10 micron absolute

316

HC-55300 Hydraulic Oil Filter Spin-On

CATERPILLAR 126-1814
VOLVO 208151
VERMEER 609136003



H 1 : 240 (mm)
OD 1 : 76.5 (mm)
Thread Size : 2-12 UNF-2B

CONT : 12
VOL : 0.038

321

HC-7913 Hydraulic Oil Filter Spin-On

CLARK 234099
CATERPILLAR 311980
J.C.BAMFORD 4110147
FIAT 906041007



H 1 : 140 (mm)
OD 1 : 93.5 (mm)
Thread Size : 2-16 UNF-2B
Gasket Type : Square

CONT : 12
VOL : 0.024

326

HC-55200 Hydraulic Oil Filter Spin-On

CATERPILLAR 4I-3950



H 1 : 240 (mm)
OD 1 : 76.5 (mm)
Thread Size : 2-12 UNF-2B

CONT : 12
VOL : 0.027

317

HC-55310 Hydraulic Oil Filter Spin-On With Microfiber media

CATERPILLAR 9T-6636



H 1 : 193 (mm)
OD 1 : 116 (mm)
Thread Size : 1 3/4-12 UNF-2B
Gasket Type : Round

CONT : 6
VOL : 0.032

322

HC-79331 Hydraulic Oil Filter Full Flow Spin-On

VOLVO 12754597



H 1 : 270 (mm)
OD 1 : 123 (mm)
Thread Size : 1 1/2-16 UN-2B
Gasket Type : Square

CONT : 6
VOL : 0.039

Note : HC-7933 (qty.outer packing difference)

327

HC-55220 Hydraulic Oil Filter Spin-On With Microfiber media

CATERPILLAR 1261815
CHARLES MACHINE 159074



H 1 : 152 (mm)
OD 1 : 94.5 (mm)
Thread Size : 1 3/8-12 UNF-2B

CONT : 12
VOL : 0.024

318

HC-5801 Hydraulic Oil Filter Spin-On

CATERPILLAR 093-7521
KUBOTA 172179-73720
CATERPILLAR 937520



H 1 : 172 (mm)
OD 1 : 93 (mm)
Thread Size : 1 1/8-16 UNF-2B
Gasket Type : Round

CONT : 12
VOL : 0.023

323

HC-7940 Hydraulic Oil Filter Spin-On

CASE 150794A1



H 1 : 136 (mm)
OD 1 : 93 (mm)
Thread Size : 1 1/8-16 UNF-2B
Gasket Type : Square

CONT : 12
VOL : 0.022

328

HC-55280 Hydraulic Oil Filter Aluminium casting seat, Spin-On Synthetic Media

CATERPILLAR 2254118



H 1 : 293 (mm)
OD 1 : 116 (mm)
Thread Size : 1 3/4-12 UNF-2B

CONT : 6
VOL : 0.033

319

HC-69031 Hydraulic Oil Filter Spin-On With Microfiber media

HYUNDAI 46321-22015
INGERSOLL RAND 575129311
CATERPILLAR 77-5795



H 1 : 147.5 (mm)
OD 1 : 94 (mm)
Thread Size : 1 1/2-16 UN-2B

CONT : 12
VOL : 0.023

Note : 5 micron

324

HC-9901 Hydraulic Oil Filter Spin-On

CATERPILLAR 5I-8670



H 1 : 155 (mm)
OD 1 : 82.5 (mm)
Thread Size : M45X2.0-6H
Gasket Type : Round

CONT : 12
VOL : 0.019

329

HC-55290 Hydraulic Oil Filter Spin-On Synthetic Media

CATERPILLAR 1440832
CATERPILLAR 2237809
CATERPILLAR 3I1914
INGERSOLL RAND 59888990
PALL HC7500SDN4H



H 1 : 173 (mm)
OD 1 : 123 (mm)
Thread Size : 1 1/2-16 UN-2B
Gasket Type : Square

CONT : 6
VOL : 0.023

320

HC-76080 Hydraulic Oil Filter Spin-On Synthetic Media

CASE 1266751H2
CASE 294721A1
J.C.BAMFORD 32905501
NEW HOLLAND (CNH) 9821387
JOHN DEERE AL77061



H 1 : 152 (mm)
OD 1 : 94.5 (mm)
Thread Size : 1 3/8-12 UNF-2B

CONT : 12
VOL : 0.024

Note : with Glass Fiber Media

325

O-1006 Oil Filter Combination Metal End Cap Element

KOBELCO 2451U1721A
HYUNDAI 26316-93000
MITSUBISHI ME 034605



H 1 : 192 (mm)
H 2 : 191 (mm)
OD 1 : 110 (mm)
OD 2 : 100 (mm)
ID 1 : 33 (mm)
ID 2 : 19.2 (mm)

CONT : 25
VOL : 0.075

Note : Paper Protector

330

Sakura Filter

Technical Specification

O-5501 Oil Filter Full Flow Metal End Cap Element

CATERPILLAR 5S-0484
CATERPILLAR 7M-3800



H 1 : 233 (mm)
OD 1 : 97 (mm)
OD 2 : 97 (mm)
ID 1 : 42 (mm)
ID 2 : 42 (mm)

CONT : 25
VOL : 0.066

Note : Paper Protector

331

SFC-5504-10 Fuel/Water Separator Secondary Spin-On 10 Micron

CATERPILLAR 133-5673
SANY 8976051180



H 1 : 217 (mm)
OD 1 : 108 (mm)
Thread Size : 1-14 UNS-2B
Gasket Type : Square

CONT : 10
VOL : 0.036

Note : bowl not included

336

SFC-55170 Fuel/Water Separator Spin-On High Efficiency

CATERPILLAR 1R-0770



H 1 : 195 (mm)
OD 1 : 108 (mm)
Thread Size : 1-14 UNS-2B

CONT : 12
VOL : 0.035

Note : bowl not included, media 12 micron

341

O-5502 Oil Filter Full Flow Metal End Cap Element

KOMATSU 145-29-22430
CATERPILLAR 1R-0659
CATERPILLAR 4W-4840



H 1 : 236 (mm)
H 2 : 230 (mm)
OD 1 : 101.6 (mm)
OD 2 : 101.6 (mm)
ID 1 : 44.3 (mm)
ID 2 : 44.3 (mm)

CONT : 20
VOL : 0.072

Note : Metal Protector

332

SFC-5504-10B Fuel/Water Separator Secondary Spin-On With Bowl 10 Micron

CATERPILLAR 133-5673
NISSAN 16403-NY00C
SANY 8976051180



Primary Filter uses SFC-5504-30B

H 1 : 308 (mm)
H 2 : 217 (mm)
OD 1 : 108 (mm)
Thread Size : 1-14 UNS-2B
Gasket Type : Square

CONT : 10
VOL : 0.049

337

SFC-55180 Fuel/Water Separator Spin-On

CATERPILLAR 1R-0769



H 1 : 191 (mm)
OD 1 : 108 (mm)
Thread Size : 1-14 UNS-2B
Gasket Type : Square

CONT : 12
VOL : 0.072

Note : bowl not included

342

O-5503 Oil Filter Full Flow Metal End Cap Element

CATERPILLAR 1R-0721
CATERPILLAR 5S-0485
CATERPILLAR 5S485



H 1 : 229 (mm)
H 2 : 227 (mm)
OD 1 : 130 (mm)
OD 2 : 130 (mm)
ID 1 : 84.4 (mm)
ID 2 : 84.4 (mm)

CONT : 20
VOL : 0.100

333

SFC-5504-30 Fuel/Water Separator Primary Spin-On 30 Micron

DAF 135 5891
NISSAN 16403-NY000
ISUZU 8-97605118-1



H 1 : 217 (mm)
OD 1 : 108 (mm)
Thread Size : 1-14 UNS-2B
Gasket Type : Square

CONT : 10
VOL : 0.036

Note : bowl not included

338

SFC-55240 Fuel/Water Separator Spin-On

PERKINS 2656F501
PERKINS 2656F853
CATERPILLAR 308-7298



H 1 : 170 (mm)
H 2 : 163 (mm)
OD 1 : 93.5 (mm)
Thread Size : M22X1.5-6H
Gasket Type : Square

CONT : 12
VOL : 0.026

Note : bowl not included

343

SF-5704 Fuel/Water Separator Metal End Cap Element

CUMMINS 256559
CATERPILLAR 2W-4234
CATERPILLAR 8N-0205



H 1 : 220 (mm)
H 2 : 205 (mm)
OD 1 : 148 (mm)
OD 2 : 148 (mm)
ID 1 : 25 (mm)
ID 2 : 25 (mm)

CONT : 6
VOL : 0.039

334

SFC-5504-30B Fuel/Water Separator Primary Spin-On With Bowl 30 Micron

DAF 1355891
NISSAN 16403-NY000



Secondary Filter uses SFC-5504-10B

H 1 : 308 (mm)
H 2 : 217 (mm)
OD 1 : 108 (mm)
Thread Size : 1-14 UNS-2B
Gasket Type : Square

CONT : 10
VOL : 0.050

339

SFC-55241 Fuel/Water Separator Spin-On

AGCO 4226708M1



H 1 : 170 (mm)
OD 1 : 94 (mm)
Thread Size : M22X1.5-6H

CONT : 12
VOL : 0.026

344

SFC-43040 Fuel/Water Separator Spin-On

GEHL 184223
J.C.BAMFORD 32/925423
MASSEY-FERGUSON 4224811M1



H 1 : 134 (mm)
OD 1 : 93 (mm)
Thread Size : M24X2-6H
Gasket Type : Square

CONT : 25
VOL : 0.049

Note : Conversion Adapter on first installation not included

335

SFC-5505 Fuel/Water Separator Spin-On

CATERPILLAR 175-2949



H 1 : 160 (mm)
OD 1 : 93 (mm)
Thread Size : 1-14 UNS-2B
Gasket Type : Square

CONT : 12
VOL : 0.029

340

SFC-55250 Fuel/Water Separator Spin-On High Efficiency

CATERPILLAR 326-1643



H 1 : 226 (mm)
OD 1 : 108 (mm)
Thread Size : 1-14 UNS-2B
Gasket Type : Round

CONT : 12
VOL : 0.046

Note : bowl not included, media 10 micron

345

SFC-55280 Fuel/Water Separator Spin-On High Efficiency
CATERPILLAR 438-5386



H 1 : 334 (mm)
H 2 : 305 (mm)
OD 1 : 136 (mm)
Thread Size : 1 1/4-12 UNF-2B

CONT : 6
VOL : 0.017

Note : SFC-55281 (Media difference)

346

WC-5707 Coolant Filter Spin-On

INGERSOLL RAND 35357276
KOMATSU 600-411-1180
KOMATSU 6134-61-8110
KOMATSU 6710-61-8110



H 1 : 135 (mm)
OD 1 : 93 (mm)
Thread Size : 11/16-16 UNF-2B
Gasket Type : Square

CONT : 12
VOL : 0.018

Note : Coolants = 8 units

351

SFC-55281 Fuel/Water Separator Spin-On High Efficiency
CATERPILLAR 438-5385



H 1 : 334 (mm)
H 2 : 305 (mm)
OD 1 : 136 (mm)
Thread Size : 1 1/4-12 UNF-2B

CONT : 6
VOL : 0.017

Note : SFC-55280 (Media difference)

347

WC-5708 Coolant Filter Spin-On

GENERAL MOTORS 23507189
FIAT 4393504
CASE 441365C1



H 1 : 136 (mm)
OD 1 : 93 (mm)
Thread Size : 11/16-16 UNF-2B
Gasket Type : Square

CONT : 12
VOL : 0.027

Note : Coolant = 15 units

352

SFC-5705 Fuel/Water Separator Spin-On

ISUZU 1-13240044-1
CUMMINS 3308638
CUMMINS 3315843
SUNWARD 750201011130



H 1 : 174 (mm)
OD 1 : 93 (mm)
Thread Size : 1-14 UNS-2B
Gasket Type : Square

CONT : 12
VOL : 0.026

348

WC-6901 Coolant Filter Spin-On

CUMMINS 3305371
INGERSOLL RAND 56985971



H 1 : 189 (mm)
OD 1 : 93 (mm)
Thread Size : 11/16-16 UNF-2B
Gasket Type : Square

CONT : 12
VOL : 0.036

Note : Coolants = 23 units

353

SFC-5706 Fuel/Water Separator Spin-On

J.C.BAMFORD 02/910150
J.C.BAMFORD 02/910150A
HYUNDAI 11E1-70210
CUMMINS 3935274
CASE J925274



H 1 : 163.7 (mm)
H 2 : 134 (mm)
OD 1 : 93 (mm)
OD 2 : 92.7 (mm)
Thread Size : 13/16-18 UNF-2B
Thread Nut Size : M14X2
Gasket Type : Square

CONT : 12
VOL : 0.021

349

WC-5705 Coolant Filter Spin-On

CUMMINS 299080
CUMMINS 3100304
CUMMINS 3305367



H 1 : 100 (mm)
OD 1 : 93 (mm)
Thread Size : 11/16-16 UNF-2B
Gasket Type : Square

CONT : 12
VOL : 0.018

Note : Coolants = 4 units

350