



# SAKURA

## HITACHI

### FILTER SUB-CATALOGUE





# Table of Contents

Engine Application .....

**A**

Technical Specification .....

**B**



# Engine Application

A

# Sakura Filter

# ENGINE APPLICATION

MODEL/APPLICATION	SAKURA NO	MODEL/APPLICATION	SAKURA NO	MODEL/APPLICATION	SAKURA NO
<b>HITACHI</b>		<b>HITACHI</b>		<b>HITACHI</b>	
<b>450</b> <b>(EXCAVATORS)</b> <b>ISUZU 6BG1</b> Fuel Filter..... FC-15031 Oil Filter Full Flow..... C-6001		<b>CX900</b> <b>(CRANES)</b> <b>MITSUBISHI 6D24T (S/N: 000101-UP) , 2006</b> Air Filter Primary..... A-6113 Air Filter Secondary..... A-5408 Hydraulic Oil Filter..... H-2719 Hydraulic Oil Filter..... HC-5602		<b>EH1100 423LD</b> <b>(DUMP TRUCKS)</b> Air Filter Secondary..... A-7902 Oil Filter Full Flow..... C-7303	
<b>CG100</b> <b>(CRAWLER DUMPERS)</b> <b>HINO , 2006</b> Fuel Filter..... F-1303 Oil Filter By Pass..... O-1310 Oil Filter Full Flow..... O-1301		<b>CX900GLS</b> <b>(CRANES)</b> <b>MITSUBISHI 6D24-TC (S/N: 25DP000123-UP)</b> Air Filter Primary..... A-6113 Air Filter Secondary..... A-5408 Hydraulic Oil Filter..... H-2719 Hydraulic Oil Filter..... HC-5602		<b>EH1100-3</b> <b>(DUMP TRUCKS)</b> <b>DETROIT DETROIT , 2008</b> Air Filter Secondary..... A-7902	
<b>CH40-2</b> <b>(CRAWLER DUMPERS)</b> <b>ISUZU C240</b> Fuel Filter..... FC-1501 Fuel Filter..... FC-1824		<b>CX1100</b> <b>(CRANES)</b> <b>ISUZU 6RB1T (S/N: 0503-UP)</b> Air Filter Primary..... A-6113 Air Filter Secondary..... A-5408 Fuel Filter..... FC-2703 Hydraulic Oil Filter..... H-2719 Hydraulic Oil Filter..... HC-5602 Oil Filter By Pass..... C-1327		<b>EH1100-3</b> <b>(DUMP TRUCKS)</b> <b>w/MTU 2000 Series Eng. (Tier 2)</b> Fuel Filter..... FC-6507	
<b>CX400</b> <b>(CRANES)</b> <b>HINO H07C-TD (S/N: 000101-UP)</b> Hydraulic Oil Filter..... H-2719 Hydraulic Oil Filter..... HC-5602 Hydraulic Oil Filter Suction..... H-2706 Oil Filter By Pass..... C-1327		<b>CX900HD</b> <b>(CRANES)</b> <b>MITSUBISHI 6D24-TC (S/N: HCME 000101-UP)</b> Air Filter Primary..... A-6113 Air Filter Secondary..... A-5408 Hydraulic Oil Filter..... H-2719 Hydraulic Oil Filter..... HC-5602		<b>EH1600</b> <b>(DUMP TRUCKS)</b> <b>CUMMINS QST30 SERIES</b> Air Filter Primary..... A-5718 Air Filter Secondary..... A-5715 Coolant Filter..... WC-5713 Fuel/Water Separator..... SFC-5601-02 Fuel/Water Separator..... SFC-5707	
<b>CX500</b> <b>(CRANES)</b> <b>HINO H07CT (S/N: 002003-UP)</b> Hydraulic Oil Filter..... H-2719 Hydraulic Oil Filter..... HC-5602 Hydraulic Oil Filter Suction..... H-2706 Oil Filter By Pass..... C-1327		<b>EG30</b> <b>(CRAWLER DUMPERS)</b> <b>ISUZU 3LD2 PA01 , 2006</b> Air Filter Primary..... A-8513 Fuel Filter..... F-5207		<b>EH1600</b> <b>(DUMP TRUCKS)</b> <b>CUMMINS QST30</b> Hydraulic Oil Filter Transmission... H-85970	
<b>CX550-C</b> <b>(CRANES)</b> <b>HINO H07CT (S/N: 002141-UP)</b> Hydraulic Oil Filter..... H-2719 Hydraulic Oil Filter..... HC-5602 Hydraulic Oil Filter Suction..... H-2706 Oil Filter By Pass..... C-1327		<b>EG70R</b> <b>(CRAWLER DUMPERS)</b> <b>ISUZU 6BG1T C-S (S/N: 010101-UP) , 2006</b> Air Filter Primary..... A-5539 Air Filter Primary..... A-5539M Air Filter Set..... A-2709-S Air Filter Set..... A-2709M-S Fuel Filter..... FC-1503		<b>EH1700</b> <b>(DUMP TRUCKS)</b> <b>CUMMINS QST30</b> Cabin Air Filter..... CA-27010 Hydraulic Oil Filter Transmission... H-85970	
<b>CX500S</b> <b>(CRANES)</b> <b>HINO H07CT (S/N: 002170-UP)</b> Hydraulic Oil Filter..... H-2719 Hydraulic Oil Filter..... HC-5602 Hydraulic Oil Filter Suction..... H-2706 Oil Filter By Pass..... C-1327		<b>EG70R</b> <b>(CARRIERS)</b> <b>ISUZU 6BG1T</b> Fuel Filter..... FC-15031		<b>EH4500</b> <b>(DUMP TRUCKS)</b> <b>w/Detroit Diesel 16V4000 Eng.</b> Fuel Filter..... FC-6507	
<b>CX700</b> <b>(CRANES)</b> <b>HINO H07CT (S/N: 000101-UP)</b> Hydraulic Oil Filter..... H-2719 Hydraulic Oil Filter..... HC-5602 Hydraulic Oil Filter Suction..... H-2706 Oil Filter By Pass..... C-1327		<b>EG70R</b> <b>(CRAWLER DUMPERS)</b> <b>ISUZU CC-6BG1T</b> Hydraulic Oil Filter..... H-2705		<b>EH4000</b> <b>(DUMP TRUCKS)</b> <b>w/Detroit Diesel 16V4000 Eng.</b> Fuel Filter..... FC-6507	
<b>CX700HD</b> <b>(CRANES)</b> <b>MITSUBISHI 6D24T (S/N: HCME 000101-UP)</b> Air Filter Primary..... A-6113 Air Filter Secondary..... A-5408 Hydraulic Oil Filter..... H-2719 Hydraulic Oil Filter..... HC-5602		<b>EG70R</b> <b>(CRAWLER DUMPERS)</b> Air Filter Primary..... A-5539 Air Filter Primary..... A-5539M Air Filter Set..... A-2709-S Air Filter Set..... A-2709M-S Fuel Filter..... FC-1503		<b>EH4500-2</b> <b>(DUMP TRUCKS)</b> <b>DETROIT DIESEL 16V4000</b> Hydraulic Oil Filter..... H-27410	
		<b>EH1000</b> <b>(DUMP TRUCKS)</b> <b>CUMMINS QSK19</b> Air Filter Primary..... A-5718 Air Filter Secondary..... A-5715 Coolant Filter..... WC-5712 Fuel/Water Separator..... SFC-5707 Fuel/Water Separator..... SFC-5709-10 Hydraulic Oil Filter..... H-85990 Oil Filter Combination..... C-5723		<b>EH5000</b> <b>(DUMP TRUCKS)</b> <b>w/Detroit Diesel 16V4000 Eng.</b> Fuel Filter..... FC-6507	
		<b>EH1100</b> <b>(DUMP TRUCKS)</b> Air Filter Secondary..... A-7902 Fuel Filter..... FC-6505 Fuel/Water Separator..... SFC-5707 Oil Filter Full Flow..... C-7303		<b>EH650 357TD</b> <b>(DUMP TRUCKS)</b> <b>VOLVO</b> Air Filter Primary..... A-7118 Air Filter Secondary..... A-7117 Air Filter Set..... A-7119-S Cabin Air Filter..... CA-2405 Fuel Filter..... FC-5723 Oil Filter By Pass..... C-5718 Oil Filter Full Flow..... C-7105	
				<b>EH700-2</b> <b>(DUMP TRUCKS)</b> <b>CUMMINS QSX15 , 2004</b> Air Filter Primary..... A-5718 Air Filter Secondary..... A-5715 Hydraulic Oil Filter..... H-85990	
				<b>EH700-3</b> <b>(DUMP TRUCKS)</b> <b>DETROIT 60 SERIES</b> Air Filter Secondary..... A-7902	
				<b>EH700-3</b> <b>(DUMP TRUCKS)</b> <b>DETROIT SERIES 60</b>	

MODEL/APPLICATION	SAKURA NO	MODEL/APPLICATION	SAKURA NO	MODEL/APPLICATION	SAKURA NO
<b>HITACHI</b>		<b>HITACHI</b>		<b>HITACHI</b>	
<b>EH700-3</b> (DUMP TRUCKS) DETROIT SERIES 60 Hydraulic Oil Filter Transmission... H-85970		<b>EX100-2</b> (EXCAVATORS) ISUZU 4BD1 Air Filter Primary..... A-2702 Air Filter Secondary..... A-2704 Air Filter Set..... A-2702-S Fuel Filter..... FC-15031 Fuel Filter..... FC-1801 Hydraulic Oil Filter..... H-2703 Hydraulic Oil Filter..... H-2704 Oil Filter Full Flow..... C-2702		Air Filter Primary..... A-2703 Air Filter Primary..... A-2708 Air Filter Secondary..... A-7956 Air Filter Set..... A-2703-S Air Filter Set..... A-2711-S Fuel Filter..... FC-2702 Hydraulic Oil Filter..... H-2703 Hydraulic Oil Filter..... H-2704 Hydraulic Oil Filter..... H-2714 Oil Filter Full Flow..... C-2702	
<b>EH700-3</b> (DUMP TRUCKS) w/Detroit Diesel Series 60 Eng. Fuel Filter..... FC-6507		<b>EX100-2</b> (EXCAVATORS) ISUZU 4BDL Air Filter Primary..... A-2702 Air Filter Secondary..... A-2704 Air Filter Set..... A-2702-S Fuel Filter..... FC-1801 Hydraulic Oil Filter..... H-2703 Hydraulic Oil Filter..... H-2704 Oil Filter Full Flow..... C-2702		<b>EX120</b> (EXCAVATORS) ISUZU 4BD1T Fuel Filter..... FC-15031	
<b>EH750-2</b> (DUMP TRUCKS) CUMMINS QSX15 , 2004 Air Filter Primary..... A-5718 Air Filter Secondary..... A-5715 Hydraulic Oil Filter..... H-85990		<b>EX100-3</b> (EXCAVATORS) ISUZU 4BD1 Fuel Filter..... FC-15031		<b>EX1200-5</b> (EXCAVATORS) MITSUBISHI S6R-Y1TAA1 Air Filter Primary..... A-5629 Air Filter Secondary..... A-5630 Air Filter Set..... A-5629-S Fuel Filter..... FC-1810 Fuel/Water Separator Primary..... SF-1912-30 Hydraulic Oil Filter..... H-2703 Hydraulic Oil Filter..... H-2709 Hydraulic Oil Filter..... HC-5602 Hydraulic Oil Filter Suction..... H-2706 Oil Filter By Pass..... C-5718	
<b>EH750-3</b> (DUMP TRUCKS) DETROIT SERIES 60 , 2007 Coolant Filter..... WC-5708 Coolant Filter..... WC-5712 Fuel/Water Separator..... SF-27010		<b>EX100-3</b> (EXCAVATORS) ISUZU 4BG1 Fuel Filter..... FC-1824		<b>EX1200-5</b> (EXCAVATORS) MITSUBISHI S6R-Y1T Cabin Air Filter..... CA-27040 Fuel Filter..... FC-58010	
<b>EX1100-3</b> (EXCAVATORS) CUMMINS QSK19 Air Filter Primary..... A-5718 Air Filter Secondary..... A-5715 Coolant Filter..... WC-5703 Coolant Filter..... WC-5713 Fuel/Water Separator..... SFC-5709-10 Hydraulic Oil Filter..... H-2703 Hydraulic Oil Filter..... HC-5602 Hydraulic Oil Filter Suction..... H-2706 Oil Filter Combination..... C-5723		<b>EX100-5</b> (EXCAVATORS) ISUZU 4BG1 Air Filter Primary..... A-2702 Air Filter Secondary..... A-2704 Air Filter Set..... A-2702-S Fuel Filter..... FC-1005 Fuel Filter..... FC-1801 Fuel Filter..... FC-1824 Hydraulic Oil Filter..... H-2703 Hydraulic Oil Filter..... H-2704 Oil Filter Full Flow..... C-2702		<b>EX1200-5</b> (EXCAVATORS) W/MITSUBISHI S6R-Y1T ENG. Cabin Air Filter..... CA-27050	
<b>EX1800-3</b> (EXCAVATORS) CUMMINS QSK19C Air Filter..... A-2715 Air Filter Primary..... A-5718 Air Filter Secondary..... A-5715 Coolant Filter..... WC-5703 Coolant Filter..... WC-5713 Fuel/Water Separator..... SFC-5709-10 Hydraulic Oil Filter..... H-5505 Oil Filter Combination..... C-5723		<b>EX100M-5</b> (EXCAVATORS) ISUZU 4BG1 Fuel Filter..... FC-1824		<b>EX1200-5C</b> (EXCAVATORS) MITSUBISHI S6R-Y1TAA1 Air Filter Primary..... A-5629 Air Filter Secondary..... A-5630 Air Filter Set..... A-5629-S Fuel Filter..... FC-1810 Hydraulic Oil Filter..... H-2703 Hydraulic Oil Filter..... H-2709 Hydraulic Oil Filter..... HC-5602 Hydraulic Oil Filter Suction..... H-2706 Oil Filter By Pass..... C-5201 Oil Filter By Pass..... C-5718	
<b>EX100</b> (EXCAVATORS) ISUZU 4BD1 , 1988 Air Filter Primary..... A-2703 Air Filter Secondary..... A-2704 Air Filter Set..... A-2703-S Fuel Filter..... FC-2702 Hydraulic Oil Filter..... H-2703 Hydraulic Oil Filter..... H-2704 Hydraulic Oil Filter..... H-2714 Oil Filter Full Flow..... C-2702		<b>EX1100</b> (EXCAVATORS) HITACHI KTTA19C Air Filter Primary..... A-5718 Air Filter Secondary..... A-5715 Coolant Filter..... WC-5713 Fuel Filter..... FC-5702 Hydraulic Oil Filter..... H-2703 Hydraulic Oil Filter Suction..... H-2706 Oil Filter By Pass..... C-5718 Oil Filter Full Flow..... C-5715		<b>EX1200-5C</b> (EXCAVATORS) MITSUBISHI S6R-Y1T Cabin Air Filter..... CA-27040 Fuel Filter..... FC-58010	
<b>EX1000</b> (EXCAVATORS) HITACHI 6RBIT , 1988 Air Filter Secondary..... A-5408 Fuel Filter..... FC-2703 Hydraulic Oil Filter..... H-2704 Oil Filter Full Flow..... C-1312		<b>EX12</b> (EXCAVATORS) ISUZU 3KC1 , 1990 Fuel Filter..... FC-1006 Hydraulic Oil Filter..... H-2712 Hydraulic Oil Filter..... HC-5807 Oil Filter Full Flow..... C-1011		<b>EX1200-5C</b> (EXCAVATORS) W/MITSUBISHI S6R-Y1T ENG. Cabin Air Filter..... CA-27050	
		<b>EX120</b> (EXCAVATORS) ISUZU 4BD1T , 1988		<b>EX120-2</b> (EXCAVATORS) ISUZU 4BD1T Air Filter Secondary..... A-7956 Fuel Filter..... FC-1005 Fuel Filter..... FC-15031 Fuel Filter..... FC-1801 Fuel Filter..... FC-1824	

MODEL/APPLICATION	SAKURA NO	MODEL/APPLICATION	SAKURA NO	MODEL/APPLICATION	SAKURA NO
<b>HITACHI</b>		<b>HITACHI</b>		<b>HITACHI</b>	
<b>EX120-2</b> (EXCAVATORS) ISUZU 48D1T Hydraulic Oil Filter..... H-2703 Hydraulic Oil Filter..... H-2704 Oil Filter By Pass..... C-15680 Oil Filter Full Flow..... C-2702 Oil Filter Full Flow..... C-6001		<b>EX17-2B</b> (EXCAVATORS) KUBOTA D1105-B Hydraulic Oil Filter..... H-2712 Hydraulic Oil Filter..... HC-5807		<b>EX100WD-3</b> (EXCAVATORS) ISUZU Air Filter Secondary..... A-7956 Fuel Filter..... FC-1503 Fuel Filter..... FC-1801 Hydraulic Oil Filter..... H-2703 Hydraulic Oil Filter..... H-2704 Oil Filter By Pass..... C-15680 Oil Filter Full Flow..... C-2702	
<b>EX120-5</b> (EXCAVATORS) ISUZU 48G1T Air Filter Secondary..... A-7956 Cabin Air Filter..... CA-27040 Fuel Filter..... FC-1005 Fuel Filter..... FC-1801 Fuel Filter..... FC-1824 Hydraulic Oil Filter..... H-2703 Hydraulic Oil Filter..... H-2704 Oil Filter By Pass..... C-15680 Oil Filter Full Flow..... C-2702 Oil Filter Full Flow..... C-6001		<b>EX1800</b> (EXCAVATORS) CUMMINS KTA-19C Air Filter..... A-2715 Air Filter Primary..... A-5718 Air Filter Secondary..... A-5715 Coolant Filter..... WC-5705 Coolant Filter..... WC-5713 Fuel Filter..... FC-5702 Hydraulic Oil Filter..... H-2730 Hydraulic Oil Filter..... H-5505 Oil Filter By Pass..... C-5718 Oil Filter Full Flow..... C-5715		<b>EX100WD-3</b> (EXCAVATORS) ISUZU 48D1T Fuel Filter..... FC-15031 Fuel Filter..... FC-1824 Oil Filter Full Flow..... C-6001	
<b>EX15</b> (EXCAVATORS) ISUZU 3KC1 , 1990 Fuel Filter..... F-5202 Hydraulic Oil Filter..... H-2712 Hydraulic Oil Filter..... HC-5807 Oil Filter Full Flow..... C-1011		<b>EX1900-5</b> (EXCAVATORS) MITSUBISHI S12A2-YTAA1 Air Filter..... A-2715 Air Filter Primary..... A-5718 Air Filter Secondary..... A-5715 Fuel Filter..... FC-1810 Fuel/Water Separator Primary..... SF-1912-30 Hydraulic Oil Filter..... H-2709 Hydraulic Oil Filter..... HC-27100 Oil Filter By Pass..... C-5718		<b>EX1200-5D</b> (EXCAVATORS) CUMMINS QSK23 (S/N: 003001-UP) Air Filter Primary..... A-5629 Air Filter Secondary..... A-5630 Air Filter Set..... A-5629-S Coolant Filter..... WC-5703 Fuel/Water Separator..... SFC-5601-02 Hydraulic Oil Filter..... H-2703 Hydraulic Oil Filter..... H-2709 Hydraulic Oil Filter..... HC-5602 Hydraulic Oil Filter Suction..... H-2706 Oil Filter Full Flow..... C-5715	
<b>EX150</b> (EXCAVATORS) HITACHI 48D1T , 1988 Air Filter Primary..... A-2708 Air Filter Secondary..... A-7956 Air Filter Set..... A-2711-S Fuel Filter..... FC-2702 Hydraulic Oil Filter..... H-2703 Hydraulic Oil Filter..... H-2704 Hydraulic Oil Filter..... H-2714 Oil Filter Full Flow..... C-2702		<b>EX100WD</b> (EXCAVATORS) ISUZU 68B1 Air Filter Primary..... A-2708 Air Filter Secondary..... A-7956 Air Filter Set..... A-2711-S Fuel Filter..... FC-1503 Fuel Filter..... FC-15031 Hydraulic Oil Filter..... H-2703 Hydraulic Oil Filter..... H-2704 Hydraulic Oil Filter..... H-2714 Oil Filter Full Flow..... C-2706 Oil Filter Full Flow..... C-6001		<b>EX1200BE</b> (EXCAVATORS) Air Filter Primary..... A-5629 Air Filter Secondary..... A-5630 Air Filter Set..... A-5629-S Fuel Filter..... FC-1810 Hydraulic Oil Filter..... H-2703 Hydraulic Oil Filter..... H-2709 Hydraulic Oil Filter..... HC-5602 Hydraulic Oil Filter Suction..... H-2706	
<b>EX150-5</b> (EXCAVATORS) ISUZU 48G1T Fuel Filter..... FC-1801 Hydraulic Oil Filter..... H-2703 Hydraulic Oil Filter..... H-2704 Oil Filter By Pass..... C-15680 Oil Filter Full Flow..... C-2702		<b>EX100WD</b> (EXCAVATORS) ISUZU 68BL Air Filter Primary..... A-2708 Air Filter Secondary..... A-7956 Air Filter Set..... A-2711-S Fuel Filter..... FC-1503 Hydraulic Oil Filter..... H-2703 Hydraulic Oil Filter..... H-2704 Hydraulic Oil Filter..... H-2714		<b>EX122</b> (EXCAVATORS) Air Filter Primary..... A-2210 Fuel Filter..... F-1504 Oil Filter Full Flow..... O-1506	
<b>EX15-2</b> (EXCAVATORS) KUBOTA D1105-B Hydraulic Oil Filter..... H-2712 Hydraulic Oil Filter..... HC-5807		<b>EX100WD-2</b> (EXCAVATORS) ISUZU 48D1T Air Filter Secondary..... A-7956 Fuel Filter..... FC-1801 Fuel Filter..... FC-1824 Hydraulic Oil Filter..... H-2703 Hydraulic Oil Filter..... H-2704 Hydraulic Oil Filter..... H-2714		<b>EX130</b> (EXCAVATORS) KUBOTA Hydraulic Oil Filter..... H-2719	
<b>EX16-2B</b> (EXCAVATORS) KUBOTA D1105-B Fuel Filter..... F-5207 Hydraulic Oil Filter..... H-2712 Hydraulic Oil Filter..... HC-5807		<b>EX100WD-3</b> (EXCAVATORS) ISUZU 48D1T Air Filter Secondary..... A-7956 Fuel Filter..... FC-1801 Fuel Filter..... FC-1824 Hydraulic Oil Filter..... H-2703 Hydraulic Oil Filter..... H-2704 Oil Filter By Pass..... C-15680 Oil Filter Full Flow..... C-2702 Oil Filter Full Flow..... C-6001		<b>EX130H-5</b> (EXCAVATORS) ISUZU 48G1T Cabin Air Filter..... CA-27040 Fuel Filter..... FC-1005 Fuel Filter..... FC-1801 Hydraulic Oil Filter..... H-2703 Hydraulic Oil Filter..... H-2704 Oil Filter By Pass..... C-15680 Oil Filter Full Flow..... C-2702	
<b>EX17-2</b> (EXCAVATORS) KUBOTA D1105-B Fuel Filter..... F-5207 Hydraulic Oil Filter..... H-2712 Hydraulic Oil Filter..... HC-5807				<b>EX135</b> (EXCAVATORS) Fuel Filter..... FC-5715 Hydraulic Oil Filter..... H-2703	



MODEL/APPLICATION	SAKURA NO	MODEL/APPLICATION	SAKURA NO	MODEL/APPLICATION	SAKURA NO
<b>HITACHI</b>		<b>HITACHI</b>		<b>HITACHI</b>	
<b>EX135</b> (EXCAVATORS)		<b>EX120-3</b> (EXCAVATORS) ISUZU 4BD1T		Fuel Filter.....	FC-15031
Hydraulic Oil Filter.....	H-2704	Fuel Filter.....	FC-15031	Oil Filter Full Flow.....	C-6001
<b>EX135UR</b> (EXCAVATORS) ISUZU 4BG1		<b>EX22</b> (EXCAVATORS) ISUZU 3KR1 , 1990		<b>EX200-5</b> (EXCAVATORS) ISUZU 6BG1	
Air Filter Primary.....	A-5541	Air Filter Primary.....	AS-5643	Air Filter Primary.....	A-5539
Air Filter Primary.....	A-5541M	Air Filter Set.....	AS-5643-S	Air Filter Primary.....	A-5539M
Air Filter Primary.....	A-76231	Fuel Filter.....	F-5207	Air Filter Secondary.....	A-5538
Air Filter Set.....	A-5541M-S	Fuel Filter.....	FC-1006	Air Filter Set.....	A-2709-S
Fuel Filter.....	FC-1801	Hydraulic Oil Filter.....	H-2719	Air Filter Set.....	A-2709M-S
Hydraulic Oil Filter.....	H-2703	Oil Filter Full Flow.....	C-1011	Cabin Air Filter.....	CA-27040
Hydraulic Oil Filter.....	H-2704	<b>EX200</b> (EXCAVATORS) HITACHI 6BD1T , 1988		Fuel Filter.....	FC-1005
Oil Filter By Pass.....	C-15680	Air Filter Primary.....	A-5627	Fuel Filter.....	FC-1503
Oil Filter Full Flow.....	C-2702	Air Filter Secondary.....	A-5408	Fuel Filter.....	FC-15031
<b>EX160WD</b> (EXCAVATORS) ISUZU 6BB1		Air Filter Secondary.....	A-6008	Hydraulic Oil Filter.....	H-2703
Air Filter Primary.....	A-2708	Air Filter Set.....	A-5663-S	Hydraulic Oil Filter Suction.....	H-2706
Air Filter Secondary.....	A-7956	Fuel Filter.....	FC-1503	Oil Filter By Pass.....	C-1327
Air Filter Set.....	A-2711-S	Hydraulic Oil Filter.....	H-2703	Oil Filter Full Flow.....	C-6001
Fuel Filter.....	FC-1503	Hydraulic Oil Filter Suction.....	H-2706	<b>EX200-5</b> (EXCAVATORS) ISUZU A-6BG1T	
Fuel Filter.....	FC-15031	Oil Filter By Pass.....	0-2701	Oil Filter Full Flow.....	C-2706
Hydraulic Oil Filter.....	H-2703	<b>EX200LC</b> (EXCAVATORS)		<b>EX200LC</b> (EXCAVATORS)	
Hydraulic Oil Filter Suction.....	H-2706	Air Filter Primary.....	A-2706	Air Filter Primary.....	A-2706
<b>EX165</b> (EXCAVATORS) ISUZU 4BG1		Air Filter Secondary.....	A-2705	Air Filter Secondary.....	A-2705
Air Filter Secondary.....	A-7956	<b>EX200LC-5</b> (EXCAVATORS) ISUZU 6BG1T		<b>EX200LC-5</b> (EXCAVATORS) ISUZU 6BG1	
Fuel Filter.....	FC-1801	Fuel Filter.....	FC-15031	Fuel Filter.....	FC-15031
Hydraulic Oil Filter.....	H-2703	<b>EX200LC-5</b> (EXCAVATORS) ISUZU 6BG1		<b>EX200LC-5</b> (EXCAVATORS) ISUZU 6BG1	
Hydraulic Oil Filter.....	H-2704	Cabin Air Filter.....	CA-27040	Cabin Air Filter.....	CA-27040
Hydraulic Oil Filter Suction.....	H-2706	Fuel Filter.....	FC-15031	Fuel Filter.....	FC-15031
Oil Filter Full Flow.....	C-2702	Oil Filter Full Flow.....	C-2706	Oil Filter Full Flow.....	C-2706
<b>EX165</b> (EXCAVATORS)		<b>EX200</b> (EXCAVATORS) ISUZU 4BD1		<b>EX200</b> (EXCAVATORS) HITACHI H06C-T	
Air Filter Secondary.....	A-7956	Fuel Filter.....	FC-15031	Air Filter Primary.....	A-6006
Fuel Filter.....	FC-1801	Oil Filter Full Flow.....	C-6001	Air Filter Secondary.....	A-6007
Hydraulic Oil Filter.....	H-2703	<b>EX200</b> (EXCAVATORS) ISUZU 6BD1		Air Filter Set.....	A-6118-S
Hydraulic Oil Filter.....	H-2704	Fuel Filter.....	FC-15031	Fuel Filter.....	FC-1503
Oil Filter By Pass.....	C-15680	Oil Filter Full Flow.....	C-6001	Hydraulic Oil Filter.....	H-2703
Oil Filter Full Flow.....	C-2702	<b>EX200-2</b> (EXCAVATORS) ISUZU 6BD1		Hydraulic Oil Filter Suction.....	H-2706
<b>EX165W</b> (EXCAVATORS) CUMMINS 6BT5.9		Air Filter Primary.....	A-2706	Oil Filter By Pass.....	0-2702
Cabin Air Filter.....	CA-27040	Air Filter Secondary.....	A-2705	<b>EX220-2</b> (EXCAVATORS) HINO H06C-T	
<b>EX165W</b> (EXCAVATORS) CUMMINS 6BT5.9-C		Fuel Filter.....	FC-1503	Hydraulic Oil Filter.....	H-2727
Air Filter Primary.....	A-7954	Fuel Filter.....	FC-15031	<b>EX220-2</b> (EXCAVATORS) HITACHI H06C-T	
Air Filter Secondary.....	A-7809	Hydraulic Oil Filter.....	H-2703	Air Filter Primary.....	A-5539
Fuel Filter Secondary.....	FC-7903	Hydraulic Oil Filter Suction.....	H-2706	Air Filter Primary.....	A-5539M
Fuel/Water Separator.....	SFC-5706	Oil Filter By Pass.....	C-1327	Air Filter Secondary.....	A-5538
Hydraulic Oil Filter.....	H-2704	<b>EX200-2</b> (EXCAVATORS) ISUZU 6BD1T		Air Filter Set.....	A-2709-S
Oil Filter Full Flow.....	C-5704	Fuel Filter.....	FC-15031	Air Filter Set.....	A-2709M-S
<b>EX150-1</b> (EXCAVATORS) ISUZU 4BG1T		Oil Filter Full Flow.....	C-6001	Hydraulic Oil Filter.....	H-2703
Fuel Filter.....	FC-1824	<b>EX200-3</b> (EXCAVATORS) ISUZU 6BD1		Hydraulic Oil Filter Suction.....	H-2706
<b>EX100W</b> (EXCAVATORS) ISUZU 6BB1		Fuel Filter.....	FC-15031	Oil Filter By Pass.....	C-1327
Fuel Filter.....	FC-15031	Oil Filter Full Flow.....	C-6001	Oil Filter Combination.....	C-1303
Oil Filter Full Flow.....	C-6001	<b>EX200-3</b> (EXCAVATORS) ISUZU 6BD1T		<b>EX220-5</b> (EXCAVATORS) HINO H07C-TD	
		Fuel Filter.....	FC-15031		
		Oil Filter Full Flow.....	C-6001		

# Sakura Filter

# ENGINE APPLICATION

MODEL/APPLICATION	SAKURA NO	MODEL/APPLICATION	SAKURA NO	MODEL/APPLICATION	SAKURA NO
<b>HITACHI</b>		<b>HITACHI</b>		<b>HITACHI</b>	
<b>EX220-5 (EXCAVATORS) HINO H07C-TD</b>		<b>EX255 (EXCAVATORS) ISUZU 6BG1T</b>		Hydraulic Oil Filter..... H-2703	
Air Filter Primary.....	A-5539	Air Filter Primary.....	A-5539	Hydraulic Oil Filter Suction.....	H-2706
Air Filter Primary.....	A-5539M	Air Filter Primary.....	A-5539M	Oil Filter By Pass.....	C-1327
Air Filter Secondary.....	A-5538	Air Filter Secondary.....	A-5538	<b>EX215 (EXCAVATORS) IVECO</b>	
Air Filter Set.....	A-2709-S	Air Filter Set.....	A-2709-S	Air Filter Primary.....	AS-2212
Air Filter Set.....	A-2709M-S	Air Filter Set.....	A-2709M-S	Air Filter Secondary.....	A-7809
Cabin Air Filter.....	CA-27040	Fuel Filter.....	FC-1503	Air Filter Set.....	AS-2212-S
Fuel Filter.....	FC-1005	Fuel Filter.....	FC-15031	Fuel Filter.....	FC-2202
Hydraulic Oil Filter.....	H-2703	Fuel Filter.....	FC-15031	Hydraulic Oil Filter.....	H-2703
Hydraulic Oil Filter Suction.....	H-2706	Hydraulic Oil Filter.....	H-2703	Hydraulic Oil Filter Suction.....	H-2706
Oil Filter By Pass.....	C-1327	Hydraulic Oil Filter Suction.....	H-2706	Oil Filter Combination.....	C-7937
Oil Filter Combination.....	C-1303	Oil Filter By Pass.....	C-1327	<b>EX225USR (EXCAVATORS) ISUZU 6BG1T</b>	
<b>EX220-5 (EXCAVATORS) HINO H07CT</b>		<b>EX255 (EXCAVATORS) ISUZU 6BG1</b>		Air Filter Primary..... A-5539	
Hydraulic Oil Filter.....	H-2727	Fuel Filter.....	FC-15031	Air Filter Primary.....	A-5539M
<b>EX22-2 (EXCAVATORS) KUBOTA D1105-B</b>		<b>EX270 (EXCAVATORS) CUMMINS</b>		Air Filter Secondary.....	A-5538
Air Filter Primary.....	AS-5643	Air Filter Primary.....	AS-7621	Air Filter Set.....	A-2709-S
Air Filter Set.....	AS-5643-S	Air Filter Secondary.....	A-7619	Air Filter Set.....	A-2709M-S
Fuel Filter.....	F-5207	Air Filter Set.....	AS-7622-S	Fuel Filter.....	FC-1503
Hydraulic Oil Filter.....	H-2712	Fuel Filter Secondary.....	FC-7903	Hydraulic Oil Filter.....	H-2703
<b>EX2500 (EXCAVATORS) CUMMINS KTA50</b>		Fuel/Water Separator.....	SFC-5706	Hydraulic Oil Filter Suction.....	H-2706
Hydraulic Oil Filter.....	HC-27100	Hydraulic Oil Filter.....	H-2703	Oil Filter By Pass.....	C-1327
<b>EX2500 (EXCAVATORS) CUMMINS KTA25C</b>		Oil Filter Combination.....	C-5723	<b>EX225USR (EXCAVATORS) ISUZU 6BG1</b>	
Air Filter.....	A-2715	<b>EX270 (EXCAVATORS) HINO H06C-T</b>		Fuel Filter.....	FC-15031
Air Filter Secondary.....	A-7902	Fuel Filter.....	FC-15031	<b>EX230LC-5 (EXCAVATORS) HINO H07C-TD</b>	
Coolant Filter.....	WC-5712	<b>EX270 (EXCAVATORS) HITACHI H06C-T</b>		Air Filter Primary.....	A-5539
Fuel/Water Separator.....	SFC-5707	Air Filter Primary.....	A-6006	Air Filter Primary.....	A-5539M
Hydraulic Oil Filter.....	H-2709	Air Filter Secondary.....	A-6007	Air Filter Secondary.....	A-5538
Hydraulic Oil Filter.....	H-2730	Air Filter Set.....	A-6118-S	Air Filter Set.....	A-2709-S
Oil Filter By Pass.....	C-5718	Hydraulic Oil Filter.....	H-2703	Air Filter Set.....	A-2709M-S
Oil Filter Full Flow.....	C-5715	Hydraulic Oil Filter Suction.....	H-2706	Fuel Filter.....	FC-1005
<b>EX25-2 (EXCAVATORS) KUBOTA D1105-B</b>		Oil Filter By Pass.....	0-2702	Hydraulic Oil Filter.....	H-2703
Air Filter Primary.....	AS-5643	<b>EX27U (EXCAVATORS) ISUZU 3LD1</b>		Hydraulic Oil Filter Suction.....	H-2706
Air Filter Set.....	AS-5643-S	Air Filter Primary.....	A-8513	Oil Filter By Pass.....	C-1327
Fuel Filter.....	F-5207	Hydraulic Oil Filter.....	H-2712	Oil Filter Combination.....	C-1303
Hydraulic Oil Filter.....	H-2712	<b>EX29UE (EXCAVATORS) ISUZU 3LD1</b>		<b>EX235 (EXCAVATORS)</b>	
<b>EX255 (EXCAVATORS) CUMMINS</b>		Air Filter Primary.....	A-8513	Air Filter Primary.....	AS-2212
Air Filter Primary.....	AS-7621	Hydraulic Oil Filter.....	H-2705	Air Filter Secondary.....	A-7809
Air Filter Secondary.....	A-7619	Hydraulic Oil Filter.....	H-2712	Air Filter Set.....	AS-2212-S
Air Filter Set.....	AS-7622-S	<b>EX2500-5 (EXCAVATORS) CUMMINS QSK45</b>		Fuel Filter.....	FC-2202
Coolant Filter.....	WC-5703	Hydraulic Oil Filter.....	HC-27100	Hydraulic Oil Filter.....	H-2703
Coolant Filter.....	WC-5713	<b>EX210H-5 (EXCAVATORS) ISUZU 6BG1</b>		Oil Filter Combination.....	C-7937
Fuel Filter.....	FS-5701	Air Filter Primary.....	A-5539	<b>EX285 (EXCAVATORS) CUMMINS</b>	
Fuel Filter Secondary.....	FC-7903	Air Filter Primary.....	A-5539M	Air Filter Primary.....	AS-7621
Fuel/Water Separator.....	SFC-5706	Air Filter Secondary.....	A-5538	Air Filter Secondary.....	A-7619
Hydraulic Oil Filter.....	H-2703	Air Filter Set.....	A-2709-S	Air Filter Set.....	AS-7622-S
Hydraulic Oil Filter Suction.....	H-2706	Air Filter Set.....	A-2709M-S	Coolant Filter.....	WC-5703
Oil Filter Combination.....	C-5707	Cabin Air Filter.....	CA-27040	Coolant Filter.....	WC-5713
<b>EX255 (EXCAVATORS) CUMMINS 6CT8.3</b>		Fuel Filter.....	FC-1503	Fuel Filter Secondary.....	FC-7903
Hydraulic Oil Filter.....	H-2727	Fuel Filter.....	FC-15031	Fuel/Water Separator.....	SFC-5706



MODEL/APPLICATION	SAKURA NO	MODEL/APPLICATION	SAKURA NO	MODEL/APPLICATION	SAKURA NO
<b>HITACHI</b>		<b>HITACHI</b>		<b>HITACHI</b>	
<b>EX285</b> (EXCAVATORS) CUMMINS 6CT8.3		Hydraulic Oil Filter.....	H-2719	<b>EX32UE</b> (EXCAVATORS) ISUZU 3LD1 , 2003	
Cabin Air Filter.....	CA-27040	Oil Filter Full Flow.....	C-1011	Air Filter Primary.....	A-8513
<b>EX285</b> (EXCAVATORS) ISUZU 6BG1T		<b>EX300-2</b> (EXCAVATORS) ISUZU 6SD1T		Fuel Filter.....	F-5207
Fuel Filter.....	FC-15031	Air Filter Primary.....	A-1013	Hydraulic Oil Filter.....	H-2712
<b>EX285</b> (EXCAVATORS) ISUZU 6BG1		Air Filter Primary.....	A-10134	<b>EX32UE</b> (EXCAVATORS) ISUZU 3LD1	
Fuel Filter.....	FC-15031	Air Filter Secondary.....	A-5631	Hydraulic Oil Filter.....	H-2705
Hydraulic Oil Filter.....	H-2727	Air Filter Set.....	A-1841-S	<b>EX35U</b> (EXCAVATORS) ISUZU 3LD1	
<b>EX285</b> (EXCAVATORS) ISUZU 6BG1-TRA06 (S/N: TIER 2-UP)		Fuel Filter.....	FC-1005	Air Filter Primary.....	A-8513
Air Filter Primary.....	A-5539	Fuel Filter.....	FC-1503	Fuel Filter.....	F-5207
Air Filter Primary.....	A-5539M	Hydraulic Oil Filter.....	H-2703	Hydraulic Oil Filter.....	H-2705
Air Filter Secondary.....	A-5538	Hydraulic Oil Filter Suction.....	H-2706	Hydraulic Oil Filter.....	H-2712
Air Filter Set.....	A-2709-S	Oil Filter By Pass.....	C-1327	<b>EX3600-5</b> (EXCAVATORS) ISUZU	
Air Filter Set.....	A-2709M-S	Oil Filter Full Flow.....	C-5505	Air Filter.....	A-2715
Fuel Filter.....	FC-1503	<b>EX300-3</b> (EXCAVATORS) ISUZU 6SD1T		Air Filter Primary.....	A-5718
Hydraulic Oil Filter.....	H-2703	Air Filter Primary.....	A-1013	Air Filter Secondary.....	A-5715
Hydraulic Oil Filter Suction.....	H-2706	Air Filter Primary.....	A-10134	Fuel Filter.....	FC-1501
Oil Filter By Pass.....	C-1327	Air Filter Secondary.....	A-5631	Hydraulic Oil Filter.....	H-2709
<b>EX29U</b> (EXCAVATORS)		Air Filter Set.....	A-1841-S	Hydraulic Oil Filter.....	H-2730
Air Filter Primary.....	A-8513	Fuel Filter.....	FC-1005	Hydraulic Oil Filter.....	HC-69031
Fuel Filter.....	F-5207	Fuel Filter.....	FC-2703	Oil Filter By Pass.....	C-5718
Hydraulic Oil Filter.....	H-2712	Hydraulic Oil Filter.....	H-2703	Oil Filter Full Flow.....	C-1511
<b>EX210LCH-5</b> (EXCAVATORS) ISUZU 6BG1		Hydraulic Oil Filter Suction.....	H-2706	Oil Filter Full Flow.....	C-1538
Cabin Air Filter.....	CA-27040	Oil Filter By Pass.....	C-1327	<b>EX36UE</b> (EXCAVATORS) ISUZU 3LD1	
Fuel Filter.....	FC-15031	Oil Filter Full Flow.....	C-5505	Air Filter Primary.....	A-8513
Oil Filter Full Flow.....	C-2706	<b>EX300-5</b> (EXCAVATORS)		Fuel Filter.....	F-5207
<b>EX200-1</b> (EXCAVATORS) ISUZU 6BD1T		Air Filter Primary.....	A-28710	Hydraulic Oil Filter.....	H-2705
Fuel Filter.....	FC-15031	Air Filter Secondary.....	A-7967	Hydraulic Oil Filter.....	H-2712
Oil Filter Full Flow.....	C-6001	Air Filter Set.....	A-28730-S	<b>EX300</b> (EXCAVATORS) HITACHI EP100T	
<b>EX210LC-5</b> (EXCAVATORS) ISUZU 6BG1		Fuel Filter.....	FC-1005	Air Filter Primary.....	A-1313
Fuel Filter.....	FC-15031	Fuel Filter.....	FC-2703	Air Filter Secondary.....	A-1307
<b>EX35</b> (EXCAVATORS) ISUZU 3KR2 , 1991		Hydraulic Oil Filter.....	H-2703	Air Filter Set.....	A-5662-S
Air Filter Primary.....	AS-5643	Oil Filter By Pass.....	C-1327	Hydraulic Oil Filter.....	H-2703
Air Filter Set.....	AS-5643-S	Oil Filter Full Flow.....	C-5505	Hydraulic Oil Filter Suction.....	H-2706
Fuel Filter.....	F-5207	<b>EX300-LC</b> (EXCAVATORS) 1993		Hydraulic Oil Filter.....	H-2706
Fuel Filter.....	FC-1006	Air Filter Primary.....	A-1313	Oil Filter By Pass.....	O-2702
Hydraulic Oil Filter.....	H-2719	Air Filter Secondary.....	A-1307	<b>EX300LC-5</b> (EXCAVATORS) ISUZU 6SD1 TQA01	
Oil Filter Full Flow.....	C-1011	Air Filter Set.....	A-5662-S	Air Filter Primary.....	A-28710
<b>EX355 - TIER 2</b> (EXCAVATORS) ISUZU 6HK1-XQA01		Fuel Filter.....	FC-5720	Air Filter Secondary.....	A-7967
Air Filter Primary.....	AS-5102	Hydraulic Oil Filter.....	H-2703	Air Filter Set.....	A-28730-S
Air Filter Set.....	AS-5102-S	Oil Filter By Pass.....	O-2702	Fuel Filter.....	FC-1005
<b>EX30</b> (EXCAVATORS) ISUZU 3KR2 (S/N: HA03-UP)		<b>EX30-2</b> (EXCAVATORS) KUBOTA V1505 , 1992		Fuel Filter.....	FC-2703
Air Filter Primary.....	AS-5643	Air Filter Primary.....	AS-5643	Hydraulic Oil Filter.....	H-2703
Air Filter Set.....	AS-5643-S	Air Filter Set.....	AS-5643-S	Hydraulic Oil Filter Suction.....	H-2706
Fuel Filter.....	F-5207	Fuel Filter.....	F-5207	Oil Filter By Pass.....	C-1327
Fuel Filter.....	FC-1006	Hydraulic Oil Filter.....	H-2712	Oil Filter Full Flow.....	C-5505
<b>EX300</b> (EXCAVATORS) ISUZU 3LD1		<b>EX30U</b> (EXCAVATORS) ISUZU 3LD1		<b>EX310H-3C</b> (EXCAVATORS) ISUZU 6SD1T	
Air Filter Primary.....	A-8513	Air Filter Primary.....	A-8513	Air Filter Primary.....	A-1013
Fuel Filter.....	F-5207	Fuel Filter.....	F-5207	Air Filter Primary.....	A-10134
Hydraulic Oil Filter.....	H-2705	Hydraulic Oil Filter.....	H-2705	Air Filter Secondary.....	A-5631
Hydraulic Oil Filter.....	H-2712	Hydraulic Oil Filter.....	H-2712	Air Filter Set.....	A-1841-S

MODEL/APPLICATION	SAKURA NO
<b>HITACHI</b>	
<b>EX310H-3C</b> (EXCAVATORS) ISUZU 6SD1T	
Fuel Filter.....	FC-1005
Fuel Filter.....	FC-2703
Hydraulic Oil Filter.....	H-2703
Hydraulic Oil Filter Suction.....	H-2706
Oil Filter By Pass.....	C-1327
Oil Filter Full Flow.....	C-5505
<b>EX3500</b> (EXCAVATORS) HITACHI KT38C	
Air Filter.....	A-2715
Air Filter Primary.....	A-5718
Air Filter Secondary.....	A-5715
Coolant Filter.....	WC-5711
Fuel/Water Separator.....	SFC-5707
Hydraulic Oil Filter.....	H-2730
Hydraulic Oil Filter.....	H-5505
Hydraulic Oil Filter.....	HC-5602
Oil Filter By Pass.....	C-5718
Oil Filter Full Flow.....	C-5715
<b>EX350H-5</b> (EXCAVATORS) ISUZU 6SD1 TQA01	
Air Filter Primary.....	A-28710
Air Filter Secondary.....	A-7967
Air Filter Set.....	A-28730-S
Fuel Filter.....	FC-1005
Fuel Filter.....	FC-2703
Hydraulic Oil Filter.....	H-2703
Hydraulic Oil Filter Suction.....	H-2706
Oil Filter By Pass.....	C-1327
Oil Filter Full Flow.....	C-5505
<b>EX355</b> (EXCAVATORS) ISUZU 6HK1-XQA01 (S/N: TIER 2-UP)	
Air Filter Primary.....	AS-5102
Air Filter Secondary.....	A-8651
Air Filter Set.....	AS-5102-S
Fuel Filter.....	FC-2703
Hydraulic Oil Filter.....	H-2703
Hydraulic Oil Filter Suction.....	H-2706
<b>EX355</b> (EXCAVATORS) ISUZU 6SD1-TQA03	
Air Filter Primary.....	A-28710
Air Filter Secondary.....	A-7967
Air Filter Set.....	A-28730-S
Fuel Filter.....	FC-2703
Hydraulic Oil Filter.....	H-2703
Hydraulic Oil Filter Suction.....	H-2706
Oil Filter By Pass.....	C-1327
Oil Filter Full Flow.....	C-5505
<b>EX370-5</b> (EXCAVATORS) ISUZU 6SD1 TQA01	
Air Filter Primary.....	A-28710
Air Filter Secondary.....	A-7967
Air Filter Set.....	A-28730-S
Fuel Filter.....	FC-1005
Fuel Filter.....	FC-2703
Hydraulic Oil Filter.....	H-2703
Hydraulic Oil Filter Suction.....	H-2706
Oil Filter By Pass.....	C-1327

MODEL/APPLICATION	SAKURA NO
<b>HITACHI</b>	
Oil Filter Full Flow.....	C-5505
<b>EX40</b> (EXCAVATORS) ISUZU 43C1 , 1991	
Air Filter Primary.....	AS-5643
Air Filter Set.....	AS-5643-S
Hydraulic Oil Filter.....	H-2719
<b>EX40</b> (EXCAVATORS) KUBOTA V1505TE	
Fuel Filter.....	FC-15031
<b>EX400</b> (EXCAVATORS) HITACHI 6RB1T , 1988	
Air Filter Secondary.....	A-5408
Fuel Filter.....	F-1504
Fuel Filter.....	FC-2703
Hydraulic Oil Filter.....	H-2703
Oil Filter Full Flow.....	C-1312
Oil Filter Full Flow.....	O-1506
<b>EX400-3</b> (EXCAVATORS) ISUZU 6RB1-TPQ	
Air Filter Secondary.....	A-5408
Fuel Filter.....	FC-1005
Fuel Filter.....	FC-2703
Hydraulic Oil Filter.....	H-2703
Hydraulic Oil Filter.....	H-2709
Oil Filter Full Flow.....	C-1312
<b>EX400-5</b> (EXCAVATORS) ISUZU 6RB1T	
Cabin Air Filter.....	CA-27040
<b>EX400-5</b> (EXCAVATORS)	
Air Filter Primary.....	A-6113
Air Filter Secondary.....	A-5408
Fuel Filter.....	FC-1005
Fuel Filter.....	FC-2703
Hydraulic Oil Filter.....	H-2703
Hydraulic Oil Filter.....	H-2709
Hydraulic Oil Filter.....	HC-7901
Oil Filter By Pass.....	C-1327
<b>EX40-2</b> (EXCAVATORS) KUBOTA V2203-B	
Air Filter Primary.....	AS-5643
Air Filter Set.....	AS-5643-S
Fuel Filter.....	F-5210
Hydraulic Oil Filter.....	H-2712
<b>EX40UR</b> (EXCAVATORS) ISUZU	
Air Filter Primary.....	AS-5643
Air Filter Set.....	AS-5643-S
Fuel Filter.....	F-5207
Hydraulic Oil Filter.....	H-2719
Oil Filter Full Flow.....	C-1011
<b>EX455-2</b> (EXCAVATORS)	
Air Filter Primary.....	A-6010
Air Filter Secondary.....	A-6011
Fuel Filter.....	FC-2703
Hydraulic Oil Filter.....	H-2703

MODEL/APPLICATION	SAKURA NO
<b>HITACHI</b>	
Hydraulic Oil Filter.....	HC-7901
<b>EX450-5</b> (EXCAVATORS) ISUZU 6RB1T	
Air Filter Primary.....	A-6113
Air Filter Secondary.....	A-5408
Fuel Filter.....	FC-1005
Fuel Filter.....	FC-2703
Hydraulic Oil Filter.....	H-2703
Hydraulic Oil Filter.....	H-2709
Oil Filter By Pass.....	C-1327
<b>EX450-5</b> (EXCAVATORS) w/Isuzu 6RB1T Eng.	
Air Filter Set.....	A-13092-S
<b>EX455</b> (EXCAVATORS) ISUZU 6RB1T	
Air Filter Primary.....	A-6010
Air Filter Secondary.....	A-6011
Fuel Filter.....	FC-1005
Fuel Filter.....	FC-2703
Hydraulic Oil Filter.....	H-2703
Hydraulic Oil Filter.....	H-2727
Oil Filter By Pass.....	C-1327
<b>EX455</b> (EXCAVATORS) w/Isuzu 6RB1T Eng.	
Air Filter Set.....	A-13092-S
<b>EX455-5</b> (EXCAVATORS) ISUZU 6RB1T	
Air Filter Primary.....	A-6113
Air Filter Secondary.....	A-5408
Fuel Filter.....	FC-1005
Fuel Filter.....	FC-2703
Hydraulic Oil Filter.....	H-2703
Hydraulic Oil Filter.....	H-2709
Oil Filter By Pass.....	C-1327
<b>EX456</b> (EXCAVATORS) ISUZU 6WG1 (S/N: TIER 2-UP)	
Air Filter Primary.....	A-6010
Air Filter Secondary.....	A-6011
Fuel Filter.....	FC-1005
Fuel Filter.....	FC-2703
Hydraulic Oil Filter.....	H-2703
<b>EX456</b> (EXCAVATORS) w/Isuzu 6WG1 Eng.	
Air Filter Set.....	A-13092-S
<b>EX50U</b> (EXCAVATORS) ISUZU 4LE1	
Air Filter.....	A-8568
Air Filter Primary.....	AS-5643
Air Filter Set.....	AS-5643-S
Fuel Filter.....	F-5207
Hydraulic Oil Filter.....	H-2712
<b>EX50UR</b> (EXCAVATORS) 3AB1	
Hydraulic Oil Filter.....	H-2705
<b>EX50UR</b> (EXCAVATORS) ISUZU 3AB1	
Fuel Filter.....	FC-1801

MODEL/APPLICATION	SAKURA NO	MODEL/APPLICATION	SAKURA NO	MODEL/APPLICATION	SAKURA NO
<b>HITACHI</b>		<b>HITACHI</b>		<b>HITACHI</b>	
<b>EX50UR</b> (EXCAVATORS) ISUZU 3AB1		<b>EX5500-5</b> (EXCAVATORS) CUMMINS QSK45-C		<b>EX60-2</b> (EXCAVATORS) NISSAN BD3004	
Fuel Filter.....	FC-1824	Hydraulic Oil Filter.....	HC-27100	Hydraulic Oil Filter.....	H-2705
Hydraulic Oil Filter.....	H-2703				
<b>EX550</b> (EXCAVATORS) CUMMINS N14		<b>EX55UR</b> (EXCAVATORS) NISSAN TD2340-10		<b>EX60-2</b> (EXCAVATORS) NISSAN BD3004-19	
Cabin Air Filter.....	CA-27040	Air Filter Primary.....	AS-5643	Fuel Filter.....	FC-1824
		Air Filter Set.....	AS-5643-S		
<b>EX550</b> (EXCAVATORS) CUMMINS NTA-855		Fuel Filter.....	FC-1801	<b>EX60-3</b> (EXCAVATORS) NISSAN BD3004	
Air Filter Primary.....	A-6010	Hydraulic Oil Filter.....	H-2719	Hydraulic Oil Filter.....	H-2705
Air Filter Secondary.....	A-6011				
Coolant Filter.....	WC-5712	<b>EX55UR-3</b> (EXCAVATORS) ISUZU 4LE1		<b>EX60-5</b> (EXCAVATORS) NISSAN BD3004	
Fuel/Water Separator.....	SFC-5705	Air Filter Primary.....	A-8513	Cabin Air Filter.....	CA-27040
Hydraulic Oil Filter.....	H-2703	Air Filter Secondary.....	A-5569	Hydraulic Oil Filter.....	H-2705
Hydraulic Oil Filter.....	H-2709	Fuel Filter.....	F-5207		
Oil Filter Combination.....	C-5723	Hydraulic Oil Filter.....	H-2712	<b>EX60-5</b> (EXCAVATORS) NISSAN BD3004-19	
				Air Filter Primary.....	A-8505
<b>EX550</b> (EXCAVATORS) CUMMINS N14-C400		<b>EX5500-6</b> (EXCAVATORS) CUMMINS QSK50		Air Filter Secondary.....	A-8599
Air Filter Primary.....	A-6010	Hydraulic Oil Filter.....	HC-27100	Fuel Filter.....	FC-1801
Air Filter Secondary.....	A-6011			Hydraulic Oil Filter.....	H-2703
Coolant Filter.....	WC-5712	<b>EX5600-6</b> (EXCAVATORS) CUMMINS QSK50-C			
Fuel/Water Separator.....	SFC-5705	Hydraulic Oil Filter.....	HC-27100	<b>EX60UR</b> (EXCAVATORS) ISUZU 4JB1 , 1990	
Hydraulic Oil Filter.....	H-2703			Air Filter Primary.....	AS-1014
Hydraulic Oil Filter.....	H-2709	<b>EX60</b> (EXCAVATORS) HITACHI FD3304 , 1988		Fuel Filter.....	FC-1801
Oil Filter Combination.....	C-5723	Air Filter Primary.....	AS-1014	Hydraulic Oil Filter.....	H-2703
		Fuel Filter.....	FC-1801		
<b>EX550</b> (EXCAVATORS) w/Cummins N14 Eng		Hydraulic Oil Filter.....	H-2703	<b>EX60UR</b> (EXCAVATORS) ISUZU 4JB1	
Air Filter Set.....	A-13092-S	Hydraulic Oil Filter.....	H-2714	Hydraulic Oil Filter.....	H-2705
<b>EX550-3</b> (EXCAVATORS) CUMMINS N14		<b>EX60</b> (EXCAVATORS) HITACHI FD3302		<b>EX60URG</b> (EXCAVATORS) ISUZU 4JB1	
Cabin Air Filter.....	CA-27040	Air Filter Primary.....	AS-1014	Hydraulic Oil Filter.....	H-2705
<b>EX550-3</b> (EXCAVATORS) w/Cummins N14 Eng		<b>EX60</b> (EXCAVATORS) NISSAN FD3304		<b>EX60WD</b> (EXCAVATORS) HITACHI FD3304 , 1990	
Air Filter Set.....	A-13092-S	Hydraulic Oil Filter.....	H-2705	Air Filter Primary.....	AS-1014
				Fuel Filter.....	FC-1801
<b>EX550-5</b> (EXCAVATORS) CUMMINS N14		<b>EX600-3</b> (EXCAVATORS) CUMMINS N14		Hydraulic Oil Filter.....	H-2703
Cabin Air Filter.....	CA-27040	Cabin Air Filter.....	CA-27040	Hydraulic Oil Filter.....	H-2714
<b>EX550-5</b> (EXCAVATORS) CUMMINS N14-C400		<b>EX600-3</b> (EXCAVATORS) CUMMINS N14-C400		<b>EX60WD</b> (EXCAVATORS) ISUZU 4BD1	
Air Filter Primary.....	A-6010	Air Filter Primary.....	A-6010	Hydraulic Oil Filter.....	H-2705
Air Filter Secondary.....	A-6011	Air Filter Secondary.....	A-6011		
Coolant Filter.....	WC-5712	Coolant Filter.....	WC-5712	<b>EX60WD</b> (EXCAVATORS) NISSAN FD3304	
Fuel/Water Separator.....	SFC-5705	Fuel/Water Separator.....	SFC-5705	Hydraulic Oil Filter.....	H-2705
Hydraulic Oil Filter.....	H-2703	Hydraulic Oil Filter.....	H-2703		
Hydraulic Oil Filter.....	H-2709	Hydraulic Oil Filter.....	H-2709	<b>EX60WD-2</b> (EXCAVATORS) HITACHI BD3004 , 1992	
Oil Filter Combination.....	C-5723	Oil Filter Combination.....	C-5723	Air Filter Primary.....	A-8505
				Fuel Filter.....	FC-1801
<b>EX550-5</b> (EXCAVATORS) w/Cummins N14 Eng		<b>EX600-3</b> (EXCAVATORS) w/Cummins N14 Eng		Hydraulic Oil Filter.....	H-2703
Air Filter Set.....	A-13092-S	Air Filter Set.....	A-13092-S	Hydraulic Oil Filter.....	H-2714
<b>EX5500-5</b> (EXCAVATORS) CUMMINS QSK45-C , 2005		<b>EX60-2</b> (EXCAVATORS) HITACHI BD3004 , 1992		<b>EX60WD-2</b> (EXCAVATORS) NISSAN BD3004	
Air Filter.....	A-2715	Air Filter Primary.....	A-8505	Hydraulic Oil Filter.....	H-2705
Air Filter Secondary.....	A-7902	Air Filter Secondary.....	A-8599		
Coolant Filter.....	WC-5703	Fuel Filter.....	FC-1801	<b>EX600</b> (EXCAVATORS)	
Fuel/Water Separator.....	SFC-5601-02	Hydraulic Oil Filter.....	H-2703	Air Filter Primary.....	A-6010
Hydraulic Oil Filter.....	H-2709			Air Filter Secondary.....	A-6011
Hydraulic Oil Filter.....	H-2730				

# Sakura Filter

# ENGINE APPLICATION

MODEL/APPLICATION	SAKURA NO	MODEL/APPLICATION	SAKURA NO	MODEL/APPLICATION	SAKURA NO
<b>HITACHI</b>		<b>HITACHI</b>		<b>HITACHI</b>	
<b>EX600 (EXCAVATORS)</b>		<b>EX600LC-5 (EXCAVATORS) CUMMINS N14</b>		<b>EX75UR (EXCAVATORS)</b>	
Coolant Filter.....	WC-5712	Cabin Air Filter.....	CA-27040	Air Filter Primary.....	A-8505
Fuel Filter.....	FC-2703	<b>EX600LC-5 (EXCAVATORS) w/Cummins N14 Eng</b>		Fuel Filter.....	FC-1801
Hydraulic Oil Filter.....	H-2703	Air Filter Set.....	A-13092-S	Hydraulic Oil Filter.....	H-2703
Hydraulic Oil Filter.....	H-2709	<b>EX600LCH-5 (EXCAVATORS) CUMMINS N14</b>		Hydraulic Oil Filter.....	H-2705
Oil Filter Combination.....	C-5707	Cabin Air Filter.....	CA-27040	<b>EX75UR-3 (EXCAVATORS) NISSAN BD3004</b>	
<b>EX600H-5 (EXCAVATORS) CUMMINS N14</b>		<b>EX600LCH-5 (EXCAVATORS) w/Cummins N14 Eng</b>		Hydraulic Oil Filter.....	H-2705
Cabin Air Filter.....	CA-27040	Air Filter Set.....	A-13092-S	<b>EX75UR-3 (EXCAVATORS) NISSAN BD3004-20</b>	
<b>EX600H-5 (EXCAVATORS) CUMMINS N14-C400</b>		<b>EX60-1 (EXCAVATORS) NISSAN FD3304</b>		Air Filter Primary.....	A-8505
Air Filter Primary.....	A-6010	Hydraulic Oil Filter.....	H-2705	Fuel Filter.....	FC-1801
Air Filter Secondary.....	A-6011	<b>EX60LC-5 (EXCAVATORS) NISSAN BD3004</b>		Hydraulic Oil Filter.....	H-2703
Coolant Filter.....	WC-5712	Cabin Air Filter.....	CA-27040	<b>EX75US-7 (EXCAVATORS) ISUZU 4J81</b>	
Fuel/Water Separator.....	SFC-5705	Hydraulic Oil Filter.....	H-2705	Hydraulic Oil Filter.....	H-2705
Hydraulic Oil Filter.....	H-2703	<b>EX60WD-1 (EXCAVATORS) NISSAN FD3304</b>		<b>EX75US-7 (EXCAVATORS) ISUZU 4JG1</b>	
Hydraulic Oil Filter.....	H-2709	Hydraulic Oil Filter.....	H-2705	Air Filter Primary.....	A-8505
Oil Filter Combination.....	C-5723	<b>EX700 (EXCAVATORS) CUMMINS NTA-855 , 1995</b>		Air Filter Secondary.....	A-8599
<b>EX600H-5 (EXCAVATORS) w/Cummins N14 Eng</b>		Air Filter Primary.....	A-5629	Fuel Filter.....	FC-1801
Air Filter Set.....	A-13092-S	Air Filter Secondary.....	A-5630	Hydraulic Oil Filter.....	H-2703
<b>EX60SR (EXCAVATORS) HITACHI FD3304</b>		Air Filter Set.....	A-5629-S	<b>EX800 (EXCAVATORS)</b>	
Air Filter Primary.....	AS-1014	Cabin Air Filter.....	CA-56041	Air Filter Primary.....	A-5629
Hydraulic Oil Filter.....	H-2703	Coolant Filter.....	WC-5713	Air Filter Secondary.....	A-5630
Hydraulic Oil Filter.....	H-2714	Fuel Filter.....	FC-5702	Air Filter Set.....	A-5629-S
<b>EX60SR (EXCAVATORS) NISSAN FD3304</b>		Hydraulic Oil Filter.....	H-2703	Coolant Filter.....	WC-5712
Hydraulic Oil Filter.....	H-2705	Oil Filter Combination.....	C-5723	Fuel Filter.....	FC-2703
<b>EX600H-3 (EXCAVATORS) CUMMINS N14</b>		<b>EX700 (EXCAVATORS) CUMMINS NTAB55B</b>		Hydraulic Oil Filter.....	H-2703
Cabin Air Filter.....	CA-27040	Hydraulic Oil Filter.....	HC-27100	Hydraulic Oil Filter.....	HC-7901
<b>EX600H-3 (EXCAVATORS) w/Cummins N14 Eng</b>		<b>EX750 (EXCAVATORS) CUMMINS N14 SERIES</b>		Oil Filter Combination.....	C-5707
Air Filter Set.....	A-13092-S	Air Filter Primary.....	A-6010	<b>EX800-5 (EXCAVATORS)</b>	
<b>EX600LC-3 (EXCAVATORS) CUMMINS N14</b>		Air Filter Secondary.....	A-6011	Air Filter Primary.....	A-5629
Cabin Air Filter.....	CA-27040	Coolant Filter.....	WC-5712	Air Filter Secondary.....	A-5630
<b>EX600LC-3 (EXCAVATORS) w/Cummins N14 Eng</b>		Fuel/Water Separator.....	SFC-5705	Air Filter Set.....	A-5629-S
Air Filter Set.....	A-13092-S	Hydraulic Oil Filter.....	H-2703	Coolant Filter.....	WC-5712
<b>EX600LCH-3 (EXCAVATORS) CUMMINS N14</b>		Hydraulic Oil Filter.....	H-2709	Fuel/Water Separator.....	SFC-5705
Cabin Air Filter.....	CA-27040	Oil Filter Combination.....	C-5723	Hydraulic Oil Filter.....	H-2703
<b>EX600LCH-3 (EXCAVATORS) w/Cummins N14 Eng</b>		<b>EX750-5 (EXCAVATORS) CUMMINS N14-C</b>		Hydraulic Oil Filter.....	HC-7901
Air Filter Set.....	A-13092-S	Air Filter Primary.....	A-5629	Oil Filter Combination.....	C-5723
<b>EX600-5 (EXCAVATORS) CUMMINS N14</b>		Air Filter Secondary.....	A-5630	<b>EX8000 (EXCAVATORS) HITACHI , 2005</b>	
Cabin Air Filter.....	CA-27040	Air Filter Set.....	A-5629-S	Air Filter Secondary.....	A-7902
<b>EX600-5 (EXCAVATORS) w/Cummins N14 Eng</b>		Cabin Air Filter.....	CA-27040	Coolant Filter.....	WC-5703
Air Filter Set.....	A-13092-S	Coolant Filter.....	WC-5712	Coolant Filter.....	WC-5713
<b>EX600H-5 (EXCAVATORS) w/Cummins N14 Eng</b>		Fuel/Water Separator.....	SFC-5705	Fuel Filter.....	FC-1501
Air Filter Set.....	A-13092-S	Hydraulic Oil Filter.....	H-2703	Fuel Filter.....	FC-57290
<b>EX600H-5 (EXCAVATORS) w/Cummins N14 Eng</b>		Hydraulic Oil Filter.....	H-2709	Hydraulic Oil Filter.....	H-2709
Air Filter Set.....	A-13092-S	Oil Filter Combination.....	C-5723	Hydraulic Oil Filter.....	H-2730
<b>EX600H-5 (EXCAVATORS) w/Cummins N14 Eng</b>		<b>EX750-5 (EXCAVATORS) CUMMINS N14-C</b>		<b>EX800 (EXCAVATORS) MITSUBISHI S16RY1TAA22EA</b>	
Air Filter Set.....	A-13092-S	Air Filter Primary.....	A-5629	Hydraulic Oil Filter.....	HC-27100
<b>EX600H-5 (EXCAVATORS) w/Cummins N14 Eng</b>		Air Filter Secondary.....	A-5630	<b>EX800H-5 (EXCAVATORS) CUMMINS N14-C</b>	
Air Filter Set.....	A-13092-S	Air Filter Set.....	A-5629-S		
<b>EX600H-5 (EXCAVATORS) w/Cummins N14 Eng</b>		Cabin Air Filter.....	CA-27040		
Air Filter Set.....	A-13092-S	Coolant Filter.....	WC-5712		
<b>EX600H-5 (EXCAVATORS) w/Cummins N14 Eng</b>		Fuel/Water Separator.....	SFC-5705		
Air Filter Set.....	A-13092-S	Hydraulic Oil Filter.....	H-2703		
<b>EX600H-5 (EXCAVATORS) w/Cummins N14 Eng</b>		Hydraulic Oil Filter.....	H-2709		
Air Filter Set.....	A-13092-S	Oil Filter Combination.....	C-5723		

MODEL/APPLICATION	SAKURA NO	MODEL/APPLICATION	SAKURA NO	MODEL/APPLICATION	SAKURA NO
<b>HITACHI</b>		<b>HITACHI</b>		<b>HITACHI</b>	
<b>EX800H-5</b> (EXCAVATORS) CUMMINS N14-C		Hydraulic Oil Filter Suction.....	H-2706	Oil Filter Combination.....	C-5705
Air Filter Primary.....	A-5629	<b>FH150W-3</b> (EXCAVATORS) CUMMINS		<b>FH300</b> (EXCAVATORS) HITACHI 8365.SI.11.ALL011	
Air Filter Secondary.....	A-5630	Air Filter Primary.....	A-7954	Air Filter Primary.....	AS-7621
Air Filter Set.....	A-5629-S	Air Filter Secondary.....	A-7809	Air Filter Secondary.....	A-7619
Cabin Air Filter.....	CA-27040	Fuel Filter Secondary.....	FC-7903	Air Filter Set.....	AS-7622-S
Coolant Filter.....	WC-5712	Fuel/Water Separator.....	SFC-5706	Coolant Filter.....	WC-5705
Fuel/Water Separator.....	SFC-5705	Hydraulic Oil Filter.....	H-2704	Fuel Filter.....	F-70020
Hydraulic Oil Filter.....	H-2703	Hydraulic Oil Filter Suction.....	H-2706	Fuel Filter.....	FC-9800
Hydraulic Oil Filter.....	HC-7901	Oil Filter Full Flow.....	C-5704	Hydraulic Oil Filter.....	H-2703
Oil Filter Combination.....	C-5723	<b>FH200</b> (EXCAVATORS) IVECO		Hydraulic Oil Filter Suction.....	H-2706
<b>EX80-5</b> (EXCAVATORS) NISSAN BD3004		Air Filter Primary.....	AS-2212	Oil Filter Combination.....	C-5705
Cabin Air Filter.....	CA-27040	Air Filter Secondary.....	A-7809	<b>FH330.3</b> (EXCAVATORS) ISUZU 6SD1T	
Hydraulic Oil Filter.....	H-2705	Air Filter Set.....	AS-2212-S	Air Filter Primary.....	A-1013
<b>EX80-5</b> (EXCAVATORS) NISSAN BD3004-19		Hydraulic Oil Filter.....	H-2703	Air Filter Primary.....	A-10134
Air Filter Primary.....	A-8505	Hydraulic Oil Filter Suction.....	H-2706	Air Filter Set.....	A-1841-S
Air Filter Secondary.....	A-8599	Oil Filter Combination.....	C-7937	Fuel Filter.....	FC-2703
Fuel Filter.....	FC-1801	<b>FH220</b> (EXCAVATORS) HITACHI 8365.SI.11.ALL.010		Fuel/Water Separator.....	SFC-5705
Hydraulic Oil Filter.....	H-2703	Air Filter Primary.....	AS-7621	Hydraulic Oil Filter.....	H-2703
<b>EX8-2B</b> (EXCAVATORS) KUBOTA Z482B		Air Filter Secondary.....	A-7619	Oil Filter By Pass.....	C-1327
Fuel Filter.....	F-5207	Air Filter Set.....	AS-7622-S	Oil Filter By Pass.....	C-5718
<b>EX80U</b> (EXCAVATORS) NISSAN BD30		Coolant Filter.....	WC-5705	Oil Filter Full Flow.....	C-5505
Hydraulic Oil Filter.....	H-2705	Fuel Filter.....	F-70020	<b>FH400</b> (EXCAVATORS) FIAT 8215.22.400	
<b>EX90</b> (EXCAVATORS) HITACHI 4BD1 , 1988		Fuel Filter.....	FC-9800	Air Filter Primary.....	A-6113
Air Filter Primary.....	AS-1014	Hydraulic Oil Filter.....	H-2703	Air Filter Secondary.....	A-5408
Fuel Filter.....	FC-2702	Hydraulic Oil Filter Suction.....	H-2706	Fuel Filter.....	F-70020
Hydraulic Oil Filter.....	H-2703	Oil Filter Combination.....	C-5705	Fuel Filter.....	FC-9800
Hydraulic Oil Filter.....	H-2704	<b>FH270.3</b> (EXCAVATORS) CUMMINS 6CT8.3		Hydraulic Oil Filter.....	H-2703
Hydraulic Oil Filter.....	H-2714	Air Filter Primary.....	AS-7621	Hydraulic Oil Filter Suction.....	H-2706
Oil Filter Full Flow.....	C-2702	Air Filter Secondary.....	A-7619	<b>FH450-3</b> (EXCAVATORS) ISUZU 6RB1	
<b>FH130-3</b> (EXCAVATORS) IVECO		Air Filter Set.....	AS-7622-S	Air Filter Primary.....	A-6113
Fuel Filter.....	FC-5715	Coolant Filter.....	WC-5705	Air Filter Secondary.....	A-5408
Hydraulic Oil Filter.....	H-2703	Coolant Filter.....	WC-5711	Fuel Filter.....	FC-2703
Hydraulic Oil Filter.....	H-2704	Fuel Filter Secondary.....	FC-7903	Hydraulic Oil Filter.....	H-2703
Hydraulic Oil Filter Suction.....	H-2706	Fuel/Water Separator.....	SFC-5706	Oil Filter By Pass.....	C-1327
Oil Filter Combination.....	C-7937	Hydraulic Oil Filter.....	H-2703	<b>FH65W</b> (EXCAVATORS) PERKINS	
<b>FH130W-3</b> (EXCAVATORS) CUMMINS		Hydraulic Oil Filter Suction.....	H-2706	Air Filter Secondary.....	A-7964
Air Filter Primary.....	A-7954	Oil Filter Combination.....	C-5723	Fuel Filter.....	FC-5715
Air Filter Secondary.....	A-7809	<b>FH240-3</b> (EXCAVATORS) IVECO (S/N: 244X0001-UP)		<b>FK600</b> (CRANES) ISUZU (S/N: K130220037-UP)	
Air Filter Secondary.....	A-7964	Air Filter Primary.....	AS-7621	Air Filter.....	AS-5707
Fuel Filter Secondary.....	FC-7903	Air Filter Secondary.....	A-7619	<b>FR100</b> (LOADERS) IVECO	
Fuel/Water Separator.....	SFC-5706	Air Filter Set.....	AS-7622-S	Air Filter Primary.....	AS-7805
Hydraulic Oil Filter.....	H-2704	Fuel Filter.....	FC-2202	Air Filter Secondary.....	A-7964
Hydraulic Oil Filter Suction.....	H-2706	Hydraulic Oil Filter.....	H-2703	Air Filter Set.....	AS-5656-S
Oil Filter Full Flow.....	C-5703	Hydraulic Oil Filter Suction.....	H-2706	Fuel Filter.....	FC-1702
<b>FH120</b> (EXCAVATORS) IVECO 8065T		Oil Filter Combination.....	C-5705	Hydraulic Oil Filter.....	HC-7913
Fuel Filter.....	FC-5715	<b>FH240-3</b> (EXCAVATORS) IVECO (S/N: T0-223X9999)		<b>FR130</b> (LOADERS) FIAT 8065T	
Hydraulic Oil Filter.....	H-2703	Air Filter Primary.....	AS-7621	Air Filter Primary.....	AS-1024
Hydraulic Oil Filter.....	H-2704	Air Filter Secondary.....	A-7619	Air Filter Secondary.....	A-7809
		Air Filter Set.....	AS-7622-S	Air Filter Set.....	AS-1024-S
		Fuel Filter.....	F-70020		
		Fuel Filter.....	FC-9800		
		Hydraulic Oil Filter.....	H-2703		
		Hydraulic Oil Filter Suction.....	H-2706		

MODEL/APPLICATION	SAKURA NO	MODEL/APPLICATION	SAKURA NO	MODEL/APPLICATION	SAKURA NO
<b>HITACHI</b>		<b>HITACHI</b>		<b>HITACHI</b>	
<b>FR130</b> (LOADERS) FIAT 8065T		Oil Filter Full Flow.....	0-2703	Hydraulic Oil Filter.....	H-7911
Fuel Filter.....	FC-5704	<b>KH125-3</b> (CRANES) HITACHI EM100		Oil Filter Full Flow.....	0-1301
Hydraulic Oil Filter Transmission...	HC-2701	Air Filter Primary.....	A-6006	<b>KH300</b> (CRANES) HITACHI 8MA1	
Oil Filter Combination.....	C-7937	Air Filter Set.....	A-6118-S	Air Filter.....	AS-5707
<b>FR160</b> (LOADERS) FIAT 8365T		Fuel Filter.....	F-1304	Fuel Filter.....	F-1303
Air Filter Secondary.....	A-7619	Hydraulic Oil Filter.....	H-2719	<b>KH300</b> (CRANES) ISUZU (S/N: 2100088-UP)	
Coolant Filter.....	WC-5705	Hydraulic Oil Filter.....	H-7911	Air Filter.....	AS-5707
Fuel Filter.....	F-70020	Oil Filter Full Flow.....	0-1301	Fuel Filter.....	F-1303
Hydraulic Oil Filter Transmission...	HC-2701	<b>KH150-2</b> (CRANES) NISSAN PD604		<b>KH300-2</b> (CRANES) ISUZU 8MA1	
Oil Filter Combination.....	C-5705	Fuel Filter.....	F-1803	Air Filter.....	AS-5707
<b>FR70</b> (LOADERS)		Hydraulic Oil Filter.....	H-7911	Fuel Filter.....	F-1303
Air Filter Primary.....	AS-7609	Oil Filter By Pass.....	0-1804	<b>KH300-3</b> (CRANES) ISUZU 6RB1	
Air Filter Secondary.....	A-7605	<b>KH150-3</b> (CRANES) HINO H06CT (S/N: 911-UP)		Air Filter.....	AS-5707
Fuel Filter.....	FC-5715	Air Filter Primary.....	A-6006	Air Filter Primary.....	A-6006
Hydraulic Oil Filter.....	HC-7913	Air Filter Set.....	A-6118-S	Air Filter Set.....	A-6118-S
Oil Filter Full Flow.....	C-7917	Hydraulic Oil Filter.....	H-2719	Fuel Filter.....	F-1504
<b>FR90</b> (LOADERS) IVECO		Oil Filter By Pass.....	0-2702	Fuel Filter.....	FC-2703
Air Filter Primary.....	AS-7805	<b>KH150-3</b> (CRANES) HITACHI BF10L513		Hydraulic Oil Filter.....	H-2719
Air Filter Secondary.....	A-7964	Air Filter Primary.....	A-5301	Oil Filter Full Flow.....	C-1312
Air Filter Set.....	AS-5656-S	Hydraulic Oil Filter.....	H-2719	Oil Filter Full Flow.....	0-1506
Fuel Filter.....	FC-5715	Oil Filter Full Flow.....	C-6204	<b>KH500</b> (CRANES) ISUZU 12PB1	
Hydraulic Oil Filter.....	HC-7913	<b>KH150-3</b> (CRANES) HITACHI EM100 (S/N: T0-910)		Air Filter.....	AS-5707
Oil Filter Combination.....	C-7937	Air Filter Primary.....	A-6006	Fuel Filter.....	F-1503
<b>EX5500</b> (EXCAVATORS) CUMMINS KTA50		Air Filter Set.....	A-6118-S	Hydraulic Oil Filter.....	H-5107
Hydraulic Oil Filter.....	HC-27100	Fuel Filter.....	F-1304	Oil Filter By Pass.....	0-1510
<b>HX140B</b> (FORKLIFTS) KUBOTA D1105-K , 2004		Hydraulic Oil Filter.....	H-2719	<b>KH500-3</b> (CRANES) ISUZU 6RB1T	
Fuel Filter.....	F-5202	Oil Filter Full Flow.....	0-1301	Air Filter Primary.....	A-6113
Hydraulic Oil Filter.....	H-2712	<b>KH180</b> (CRANES) HITACHI DH100		Air Filter Secondary.....	A-5408
<b>HX220B</b> (FORKLIFTS) ISUZU 4BG1 , 2008		Fuel Filter.....	F-1303	Fuel Filter.....	FC-2703
Air Filter Secondary.....	A-2704	Oil Filter Full Flow.....	0-1506	Hydraulic Oil Filter.....	H-2719
Fuel Filter.....	FC-1801	<b>KH230-3</b> (CRANES) HINO EM100 (S/N: 106-UP)		Oil Filter Full Flow.....	C-1312
Hydraulic Oil Filter.....	H-2703	Air Filter Primary.....	A-6006	<b>KH550</b> (CRANES) ISUZU 6BD1	
Hydraulic Oil Filter Suction.....	H-2706	Air Filter Set.....	A-6118-S	Fuel Filter.....	FC-15031
Oil Filter Full Flow.....	C-2702	Fuel Filter.....	F-1304	<b>KH70</b> (CRANES) HINO DS50A	
<b>HX99B</b> (FORKLIFTS) KUBOTA D1105-BH , 2004		Hydraulic Oil Filter.....	H-2719	Air Filter.....	AS-1010
Fuel Filter.....	F-5202	Oil Filter Full Flow.....	0-1301	Fuel Filter.....	F-1302
Hydraulic Oil Filter.....	H-2712	<b>KH230-3</b> (CRANES) HINO EM100 (S/N: 2450199-UP)		Oil Filter Full Flow.....	0-1301
<b>KH100</b> (CRANES) HINO DS50A		Air Filter Primary.....	A-6006	Oil Filter Full Flow.....	0-2703
Air Filter.....	AS-1010	Air Filter Set.....	A-6118-S	<b>KH700</b> (CRANES) ISUZU 12PB1 (S/N: 2530258-UP)	
<b>KH100-2</b> (CRANES) HITACHI EL100		Fuel Filter.....	F-1304	Air Filter.....	AS-5707
Air Filter.....	AS-1010	Hydraulic Oil Filter.....	H-2719	Fuel Filter.....	F-1503
Oil Filter Full Flow.....	0-1301	Hydraulic Oil Filter.....	H-7911	Hydraulic Oil Filter.....	H-2719
<b>KH125-2</b> (CRANES) HINO DS50 (S/N: T0-400)		Oil Filter Full Flow.....	0-1301	Oil Filter By Pass.....	0-1510
Air Filter.....	AS-1010	<b>KH230-3</b> (CRANES) HINO EM100 (S/N: 2450200-UP)		<b>KH700</b> (CRANES) ISUZU 8MA1	
Fuel Filter.....	F-1302	Air Filter Primary.....	A-6006	Air Filter.....	AS-5707
Oil Filter Full Flow.....	0-1301	Air Filter Set.....	A-6118-S	Fuel Filter.....	F-1303
		Fuel Filter.....	F-1304		
		Hydraulic Oil Filter.....	H-2719		



MODEL/APPLICATION	SAKURA NO	MODEL/APPLICATION	SAKURA NO	MODEL/APPLICATION	SAKURA NO
<b>HITACHI</b>		<b>HITACHI</b>		<b>HITACHI</b>	
<b>KH700-2</b> (CRANES) ISUZU 12PB1		Fuel Filter.....	FC-1503	Air Filter Set.....	AS-8579-S
Air Filter.....	AS-5707	<b>LX170E-2</b> (LOADERS) ISUZU BB 6BG1 TRF , 2006		Fuel Filter.....	FC-2703
Fuel Filter.....	F-1503	Air Filter Primary.....	AS-1024	Oil Filter By Pass.....	C-1327
Oil Filter By Pass.....	O-1510	Air Filter Set.....	AS-1024-S	Oil Filter Full Flow.....	C-5505
<b>KH850-3</b> (CRANES) ISUZU 6RB1T		Fuel Filter.....	FC-1503	<b>LX300-7A</b> (LOADERS) ISUZU 6WG1 XQC-01 (S/N: 01102-UP) , 2006	
Air Filter Primary.....	A-6113	Oil Filter Full Flow.....	C-5505	Air Filter Secondary.....	A-7915
Air Filter Secondary.....	A-5408	<b>LX170E-2</b> (LOADERS) ISUZU 6BG1		Fuel Filter.....	FC-2703
Fuel Filter.....	FC-2703	Fuel Filter.....	FC-15031	<b>LX360E</b> (LOADERS) ISUZU 6WG1 , 2006	
Hydraulic Oil Filter.....	H-2719	<b>LX150-2</b> (LOADERS) w/JD 6076 Eng.		Air Filter Secondary.....	A-7915
Oil Filter Full Flow.....	C-1312	Air Filter Primary.....	A-76670	Fuel Filter.....	FC-2703
<b>LX145E</b> (LOADERS) ISUZU BB 6BG1 TRF (S/N: T0-01499) , 2004		Air Filter Secondary.....	A-76660	<b>LX450-7</b> (LOADERS) MITSUBISHI S6A3-Y2TAA1 (S/N: 101-UP) , 2006	
Air Filter Primary.....	AS-1024	Air Filter Set.....	A-76670-S	Fuel Filter.....	FC-1810
Air Filter Set.....	AS-1024-S	<b>LX150-2</b> (LOADERS) w/JD 6081 Eng.		<b>LX450-7</b> (LOADERS) MITSUBISHI S6A3-Y2	
Fuel Filter.....	FC-1503	Air Filter Primary.....	A-76670	Fuel Filter.....	FC-58010
Oil Filter By Pass.....	C-1506	Air Filter Secondary.....	A-76660	<b>LX450-7</b> (LOADERS) MITSUBISHI S6A3-Y2TAA1	
Oil Filter Full Flow.....	C-5505	Air Filter Set.....	A-76670-S	Oil Filter By Pass.....	C-5201
<b>LX145E</b> (LOADERS) ISUZU 6BG1		<b>LX100</b> (LOADERS) ISUZU 6BD1T		<b>LX50-7</b> (LOADERS) KUBOTA V3300-DI-KA , 2006	
Fuel Filter.....	FC-15031	Fuel Filter.....	FC-15031	Air Filter Primary.....	A-8505
<b>LX145E</b> (LOADERS) S/N: 01500-UP		<b>LX100-1</b> (LOADERS) ISUZU 6BD1T		Air Filter Secondary.....	A-8599
Air Filter Primary.....	AS-1024	Fuel Filter.....	FC-15031	<b>LX70</b> (LOADERS) ISUZU 4BD1	
Air Filter Set.....	AS-1024-S	<b>LX100-2</b> (LOADERS) ISUZU W06DT		Air Filter.....	A-2715
Fuel Filter.....	FC-1503	Fuel Filter.....	FC-15031	Air Filter Primary.....	AS-7805
<b>LX145E-2</b> (LOADERS) ISUZU BB 6BG1 TRF (S/N: 01500-UP) , 2006		<b>LX100-2</b> (LOADERS) John Deere 6059		Air Filter Secondary.....	A-7806
Air Filter Primary.....	AS-1024	Fuel Filter.....	FC-15031	Air Filter Set.....	AS-5656-S
Air Filter Set.....	AS-1024-S	<b>LX210</b> (LOADERS) ISUZU , 2004		Hydraulic Oil Filter.....	H-2703
Fuel Filter.....	FC-1503	Air Filter Primary.....	A-2210	<b>LX70-2</b> (LOADERS) HINO W04CT	
Oil Filter Full Flow.....	C-5505	Air Filter Secondary.....	A-6008	Fuel Filter.....	FC-15031
<b>LX145E-2</b> (LOADERS) ISUZU 6BG1		Fuel Filter.....	FC-2703	<b>LX70-2C</b> (LOADERS) HINO W04CT	
Fuel Filter.....	FC-15031	<b>LX210E</b> (LOADERS) ISUZU 6HK1 TQF (S/N: T0-01499) , 2006		Fuel Filter.....	FC-15031
<b>LX170</b> (LOADERS) ISUZU , 2004		Air Filter Primary.....	A-2210	<b>LX80</b> (LOADERS) ISUZU 6BD1	
Air Filter Primary.....	AS-1024	Air Filter Secondary.....	A-6008	Fuel Filter.....	FC-15031
Air Filter Set.....	AS-1024-S	<b>LX290</b> (LOADERS) ISUZU , 2004		<b>LX80</b> (LOADERS) ISUZU 6BD1T	
Fuel/Water Separator.....	SFC-5705	Air Filter Primary.....	AS-8579	Fuel Filter.....	FC-15031
Oil Filter By Pass.....	C-1506	Air Filter Primary.....	AS-8579M	<b>LX80</b> (LOADERS) ISUZU W04DT	
<b>LX170E</b> (LOADERS) ISUZU BB 6BG1 TRF (S/N: T0-01499) , 2006		Air Filter Secondary.....	A-8580	Fuel Filter.....	FC-15031
Air Filter Primary.....	AS-1024	Fuel Filter.....	FC-2703	<b>LX80-1</b> (LOADERS) ISUZU 6BD1	
Air Filter Set.....	AS-1024-S	Oil Filter By Pass.....	C-1327	Fuel Filter.....	FC-15031
Fuel Filter.....	FC-1503	Oil Filter Full Flow.....	C-5505	<b>LX80-2</b> (LOADERS) HINO W04D-T	
Oil Filter By Pass.....	C-1506	<b>LX290E</b> (LOADERS) ISUZU 6SD1 XQF (S/N: T0-01499) , 2006		Fuel Filter.....	FC-15031
Oil Filter Full Flow.....	C-5505	Air Filter Primary.....	AS-8579	<b>LX80-2</b> (LOADERS) ISUZU W04D	
<b>LX170E</b> (LOADERS) ISUZU 6BG1		Air Filter Primary.....	AS-8579M	<b>LX80-2</b> (LOADERS) ISUZU W04D	
Fuel Filter.....	FC-15031	Air Filter Secondary.....	A-8580		
<b>LX170E</b> (LOADERS) S/N: 01500-UP					
Air Filter Primary.....	AS-1024				
Air Filter Set.....	AS-1024-S				

# Sakura Filter

# ENGINE APPLICATION

MODEL/APPLICATION	SAKURA NO	MODEL/APPLICATION	SAKURA NO	MODEL/APPLICATION	SAKURA NO
<b>HITACHI</b>		<b>HITACHI</b>		<b>HITACHI</b>	
LX80-2 (LOADERS) ISUZU W04D		Air Filter Secondary.....	A-6011	T113 (LOADERS)	
Fuel Filter.....	FC-15031	Hydraulic Oil Filter.....	HC-5602	Fuel Filter.....	F-2604
LX80-2C (LOADERS) HINO W04D-T		<b>SCX2800-2</b> (CRANES) w/Mitsubishi 6M70-TL Eng. (Tier 3)		<b>TL1100-3</b> (EXCAVATORS) ISUZU 6WG1X	
Fuel Filter.....	FC-15031	Air Filter Set.....	A-13092-S	Fuel Filter Main.....	EF-27050
<b>MA200</b> (EXCAVATORS) ISUZU 4HK1		<b>SCX400</b> (CRANES) ISUZU 6HK1		<b>TS015B</b> (LOADERS) HITACHI K60	
Fuel Filter Main.....	EF-27050	Hydraulic Oil Filter.....	H-2727	Air Filter.....	A-5708
<b>PD7</b> (PILE DRIVERS) HINO D550A		<b>SCX400</b> (CRANES) ISUZU BB-6HK1-TQA		Air Filter.....	AS-5708
Air Filter.....	AS-1010	Air Filter Primary.....	A-6006	Fuel Filter.....	F-2604
Fuel Filter.....	F-1302	Air Filter Set.....	A-6118-S	<b>U106</b> (CRANES)	
Oil Filter Full Flow.....	O-1301	Fuel Filter.....	FC-2703	Air Filter.....	AS-1010
Oil Filter Full Flow.....	O-2703	Hydraulic Oil Filter.....	H-2719	Fuel Filter.....	F-2603
<b>PD9</b> (PILE DRIVERS) NISSAN PD604		Hydraulic Oil Filter.....	HC-5602	Fuel Filter.....	F-2604
Hydraulic Oil Filter.....	H-7911	Hydraulic Oil Filter Suction.....	H-2706	<b>UE004</b> (EXCAVATORS) HITACHI MMC K3B	
Oil Filter By Pass.....	O-1804	<b>SCX900</b> (CRANES) MITSUBISHI 6D24T		Air Filter.....	AS-5412
<b>SCX550</b> (CRANES) ISUZU 4HK1		Air Filter Primary.....	A-6113	Oil Filter Full Flow.....	C-1011
Fuel Filter Main.....	EF-27050	Air Filter Secondary.....	A-5408	<b>UE005</b> (EXCAVATORS) HITACHI MMC K3E	
<b>SCX550</b> (CRANES) ISUZU BB-6HK1-TQA		Hydraulic Oil Filter.....	H-2719	Oil Filter Full Flow.....	C-1011
Air Filter Primary.....	A-6006	Hydraulic Oil Filter.....	HC-5602	<b>UE008</b> (EXCAVATORS) HITACHI MMC K4E	
Air Filter Set.....	A-6118-S	<b>SCX900-2</b> (CRANES) MITSUBISHI 6D24T (S/N: 000101-UP) , 2004		Oil Filter Full Flow.....	C-5205
Fuel Filter.....	FC-2703	Air Filter Primary.....	A-1013	<b>UE014</b> (EXCAVATORS) NISSAN	
Hydraulic Oil Filter.....	H-2719	Air Filter Primary.....	A-10134	Air Filter Primary.....	AS-1014
Hydraulic Oil Filter.....	HC-5602	Air Filter Set.....	A-1841-S	Oil Filter Full Flow.....	C-1806
Hydraulic Oil Filter Suction.....	H-2706	Hydraulic Oil Filter.....	HC-5602	<b>UE10</b> (EXCAVATORS) HITACHI MMC K3B	
<b>SCX550-3</b> (CRANES) ISUZU 4HK1		<b>SCX400C-3</b> (CRANES) ISUZU 4HK1		Air Filter.....	AS-5412
Air Filter Primary.....	A-5539	Fuel Filter Main.....	EF-27050	Oil Filter Full Flow.....	C-1011
Air Filter Primary.....	A-5539M	<b>SCX400TC-3</b> (CRANES) ISUZU 4HK1		Oil Filter Full Flow.....	C-8012
Air Filter Secondary.....	A-5538	Fuel Filter Main.....	EF-27050	<b>UE15</b> (EXCAVATORS) ISUZU 3KB1	
Air Filter Set.....	A-2709-S	<b>SCX500</b> (CRANES) ISUZU 4HK1		Air Filter.....	AS-5412
Air Filter Set.....	A-2709M-S	Fuel Filter Main.....	EF-27050	<b>UE20</b> (EXCAVATORS) HITACHI MMC K3E	
Fuel Filter Main.....	EF-27050	<b>SCX800-2</b> (CRANES) ISUZU 4HK1		Air Filter.....	AS-5412
Fuel Filter Primary.....	EF-2701	Fuel Filter Main.....	EF-27050	Oil Filter Full Flow.....	C-1011
Hydraulic Oil Filter.....	H-2719	<b>SCX800HD-2</b> (CRANES) ISUZU 4HK1		Oil Filter Full Flow.....	C-5205
Hydraulic Oil Filter.....	H-2727	Fuel Filter Main.....	EF-27050	Oil Filter Full Flow.....	C-8012
Hydraulic Oil Filter.....	HC-5602	<b>SCX900-2C3</b> (CRANES) ISUZU 4HK1		<b>UE30</b> (EXCAVATORS) HITACHI MMC KAE	
Hydraulic Oil Filter Suction.....	H-2706	Fuel Filter Main.....	EF-27050	Oil Filter Full Flow.....	C-5205
<b>SCX700</b> (CRANES) ISUZU BB-6HK1-TQA		<b>T012</b> (LOADERS) HITACHI B60B		<b>UE50</b> (EXCAVATORS) ISUZU 4JC1	
Air Filter Primary.....	A-6006	Air Filter.....	A-5708	Air Filter Primary.....	AS-1014
Air Filter Set.....	A-6118-S	Air Filter.....	AS-5708	Fuel Filter.....	FC-1501
Fuel Filter.....	FC-2703	Fuel Filter.....	F-2604	Oil Filter Full Flow.....	C-1511
Hydraulic Oil Filter.....	H-2719	<b>T09</b> (LOADERS) HITACHI B40B		Oil Filter Full Flow.....	C-1538
Hydraulic Oil Filter.....	HC-5602	Air Filter.....	AS-1010	<b>UE50</b> (EXCAVATORS) NISSAN	
Hydraulic Oil Filter Suction.....	H-2706	Fuel Filter.....	F-2604		
<b>SCX700C-3</b> (CRANES) ISUZU 4HK1					
Fuel Filter Primary.....	EF-2701				
<b>SCX2800-2</b> (CRANES) MITSUBISHI 6M70-TL (S/N: TIER 3-UP) , 2008					
Air Filter Primary.....	A-6010				

MODEL/APPLICATION	SAKURA NO	MODEL/APPLICATION	SAKURA NO	MODEL/APPLICATION	SAKURA NO
<b>HITACHI</b>		<b>HITACHI</b>		<b>HITACHI</b>	
<b>UE50</b> (EXCAVATORS) NISSAN Air Filter Primary..... AS-1014 Fuel Filter..... FC-1501 Oil Filter Full Flow..... C-1511 Oil Filter Full Flow..... C-1538 Oil Filter Full Flow..... C-1806		<b>UH03-3</b> (EXCAVATORS) ISUZU 4BB1 Air Filter Primary..... AS-1014 Fuel Filter..... FC-1824 Oil Filter Full Flow..... O-1503		<b>UH045-7</b> (EXCAVATORS) ISUZU 6BB1 Fuel Filter..... FC-15031	
<b>UH003</b> (EXCAVATORS) HITACHI Z600-K1 Fuel Filter..... F-7909		<b>UH03-3</b> (EXCAVATORS) NISSAN FD3304 Fuel Filter..... FC-1824		<b>UH045-7</b> (EXCAVATORS) ISUZU 6BD1 Fuel Filter..... FC-15031	
<b>UH004</b> (EXCAVATORS) HITACHI D850BH Fuel Filter..... FC-1206		<b>UH0357</b> (EXCAVATORS) HITACHI 4BBL Oil Filter Full Flow..... C-2702		<b>UH04-7</b> (EXCAVATORS) ISUZU 4BBL Air Filter Primary..... A-2703 Air Filter Set..... A-2703-S Hydraulic Oil Filter..... H-2704 Oil Filter Full Flow..... O-1503	
<b>UH005</b> (EXCAVATORS) HITACHI D950BH Air Filter Primary..... AS-2205 Fuel Filter..... F-7909		<b>UH03M-2</b> (EXCAVATORS) HINO EC100A Air Filter Primary..... A-5628 Air Filter Primary..... AS-5628 Air Filter Set..... A-5628-S Fuel Filter..... F-1303		<b>UH05</b> (EXCAVATORS) ISUZU 6BBL Fuel Filter..... F-1303	
<b>UH006</b> (EXCAVATORS) HITACHI D1302BH Air Filter Primary..... AS-2205 Fuel Filter..... FC-1206		<b>UH04</b> (EXCAVATORS) HINO EC100 Air Filter Primary..... A-5628 Air Filter Primary..... AS-5628 Air Filter Set..... A-5628-S Fuel Filter..... F-1303 Oil Filter Full Flow..... O-1301		<b>UH051</b> (EXCAVATORS) ISUZU 6BB1 Air Filter Primary..... A-5628 Air Filter Primary..... AS-5628 Air Filter Set..... A-5628-S Fuel Filter..... F-1303 Hydraulic Oil Filter..... H-2704 Oil Filter Full Flow..... O-1503	
<b>UH02</b> (EXCAVATORS) ISUZU C330 Air Filter Primary..... A-5628 Air Filter Primary..... AS-1014 Air Filter Primary..... AS-5628 Air Filter Set..... A-5628-S Oil Filter Full Flow..... O-1503		<b>UH04</b> (EXCAVATORS) ISUZU 6BBL Air Filter Primary..... A-5628 Air Filter Primary..... AS-5628 Air Filter Set..... A-5628-S Fuel Filter..... F-1303 Oil Filter Full Flow..... O-1301 Oil Filter Full Flow..... O-1503		<b>UH051D</b> (EXCAVATORS) Air Filter Primary..... A-5628 Air Filter Primary..... AS-5628 Air Filter Set..... A-5628-S Fuel Filter..... F-1303 Hydraulic Oil Filter..... H-2704 Oil Filter Full Flow..... O-1301	
<b>UH025</b> (EXCAVATORS) ISUZU 4BBL Air Filter Primary..... AS-1014 Oil Filter Full Flow..... O-1503		<b>UH041</b> (EXCAVATORS) ISUZU 4BB1 Air Filter Primary..... AS-1014 Hydraulic Oil Filter..... H-7912 Oil Filter Full Flow..... O-1503		<b>UH052</b> (EXCAVATORS) ISUZU 6BB1 Air Filter Primary..... A-5628 Air Filter Primary..... AS-5628 Air Filter Set..... A-5628-S Fuel Filter..... F-1303 Hydraulic Oil Filter..... H-2704 Oil Filter Full Flow..... O-1503	
<b>UH025-7</b> (EXCAVATORS) ISUZU FD3304 Air Filter Primary..... AS-1014 Oil Filter Full Flow..... C-6101		<b>UH043</b> (EXCAVATORS) ISUZU 4BB1 Air Filter Primary..... AS-1014 Fuel Filter..... FC-2702 Hydraulic Oil Filter..... H-2705 Hydraulic Oil Filter..... H-2714 Oil Filter Full Flow..... C-2702 Oil Filter Full Flow..... O-1503		<b>UH052</b> (EXCAVATORS) ISUZU 6BB1 Air Filter Primary..... A-5628 Air Filter Primary..... AS-5628 Air Filter Set..... A-5628-S Fuel Filter..... F-1303 Hydraulic Oil Filter..... H-2704 Oil Filter Full Flow..... O-1503	
<b>UH025-7</b> (EXCAVATORS) NISSAN FD3304 Fuel Filter..... FC-1824		<b>UH043</b> (EXCAVATORS) ISUZU 4BB1 Air Filter Primary..... AS-1014 Fuel Filter..... FC-2702 Hydraulic Oil Filter..... H-2705 Hydraulic Oil Filter..... H-2714 Oil Filter Full Flow..... C-2702 Oil Filter Full Flow..... O-1503		<b>UH053</b> (EXCAVATORS) ISUZU 4BD1 Fuel Filter..... F-1303 Fuel Filter..... FC-2702 Hydraulic Oil Filter..... H-2714 Oil Filter Full Flow..... C-2702 Oil Filter Full Flow..... O-1503	
<b>UH03</b> (EXCAVATORS) ISUZU DA220 Air Filter Primary..... AS-1014 Fuel Filter..... F-1303 Oil Filter Full Flow..... O-1505		<b>UH045-1</b> (EXCAVATORS) ISUZU 6BD1 Air Filter Primary..... A-5628 Air Filter Primary..... AS-5628 Air Filter Set..... A-5628-S Fuel Filter..... F-1303		<b>UH06</b> (EXCAVATORS) DAF Air Filter Primary..... A-5628 Air Filter Primary..... AS-5628 Air Filter Set..... A-5628-S Hydraulic Oil Filter..... H-7912	
<b>UH03</b> (EXCAVATORS) ISUZU 4BB1 Hydraulic Oil Filter..... H-7912		<b>UH045-7</b> (EXCAVATORS) HITACHI 6BBL Fuel Filter..... F-1303 Oil Filter Full Flow..... O-1301		<b>UH06</b> (EXCAVATORS) ISUZU DA640 Air Filter Primary..... A-5628 Air Filter Primary..... AS-5628 Air Filter Set..... A-5628-S	
<b>UH03-1</b> (EXCAVATORS) ISUZU 4BB1 Air Filter Primary..... AS-1014 Oil Filter Full Flow..... O-1503					
<b>UH03-3</b> (EXCAVATORS) HITACHI FD3304 (S/N: 5501-UP) Air Filter Primary..... AS-1014					

MODEL/APPLICATION	SAKURA NO	MODEL/APPLICATION	SAKURA NO	MODEL/APPLICATION	SAKURA NO
<b>HITACHI</b>		<b>HITACHI</b>		<b>HITACHI</b>	
<b>UH06</b> (EXCAVATORS) ISUZU DA640		Hydraulic Oil Filter..... H-2704 Oil Filter Full Flow..... 0-1301		<b>UH083LC</b> (EXCAVATORS) ISUZU 6BD1T Fuel Filter..... FC-15031	
Fuel Filter..... F-1303 Hydraulic Oil Filter..... H-2702 Hydraulic Oil Filter..... H-7912 Oil Filter Full Flow..... 0-1506		<b>UH07-7</b> (EXCAVATORS) ISUZU 6BD1T Air Filter Primary..... A-5627 Air Filter Set..... A-5663-S Fuel Filter..... FC-1503 Fuel Filter..... FC-15031 Hydraulic Oil Filter..... H-2702 Hydraulic Oil Filter..... H-2704		<b>UH083LC</b> (EXCAVATORS) ISUZU 6BD1T Air Filter Primary..... A-5627 Air Filter Set..... A-5663-S Fuel Filter..... FC-1503	
<b>UH061</b> (EXCAVATORS) ISUZU 6BD1		<b>UH07LC</b> (EXCAVATORS) HINO EL100 Hydraulic Oil Filter..... H-2702		<b>UH09</b> (EXCAVATORS) HINO DS50 Air Filter..... AS-1010 Air Filter Primary..... A-5628 Air Filter Primary..... AS-5628 Air Filter Set..... A-5628-S Fuel Filter..... F-1302 Hydraulic Oil Filter..... H-2702 Oil Filter By Pass..... 0-2701 Oil Filter Full Flow..... 0-1301 Oil Filter Full Flow..... 0-2703	
Air Filter Primary..... A-5628 Air Filter Primary..... A-6113 Air Filter Primary..... AS-5628 Air Filter Set..... A-5628-S Fuel Filter..... F-1303 Hydraulic Oil Filter..... H-2704 Oil Filter Full Flow..... 0-1301 Oil Filter Full Flow..... 0-1503		<b>UH07LC-5</b> (EXCAVATORS) HINO EL100 Air Filter Primary..... A-5627 Air Filter Set..... A-5663-S Fuel Filter..... F-1302 Hydraulic Oil Filter..... H-2702 Oil Filter Full Flow..... 0-1301 Oil Filter Full Flow..... 0-2703		<b>UH09-2</b> (EXCAVATORS) HINO EL100 Air Filter..... AS-1010 Fuel Filter..... F-1302 Hydraulic Oil Filter..... H-2702 Hydraulic Oil Filter..... H-2704 Oil Filter Full Flow..... 0-1301 Oil Filter Full Flow..... 0-2703	
<b>UH063</b> (EXCAVATORS) ISUZU 6BB1 Fuel Filter..... FC-15031		<b>UH07S</b> (EXCAVATORS) HINO EL100 Hydraulic Oil Filter..... H-2702		<b>UH09-7</b> (EXCAVATORS) HINO EM100 Air Filter Primary..... A-6006 Air Filter Set..... A-6118-S Hydraulic Oil Filter..... H-2702 Hydraulic Oil Filter..... H-2704	
<b>UH063</b> (EXCAVATORS) ISUZU 6BD1 Fuel Filter..... F-1303 Fuel Filter..... FC-1503 Hydraulic Oil Filter..... H-2714 Oil Filter Full Flow..... 0-1301		<b>UH07S-5</b> (EXCAVATORS) HINO EL100 Hydraulic Oil Filter..... H-2702		<b>UH04-5</b> (EXCAVATORS) ISUZU 6BBL Fuel Filter..... F-1303 Hydraulic Oil Filter..... H-2704 Oil Filter Full Flow..... 0-1503	
<b>UH06-5</b> (EXCAVATORS) ISUZU 6BD1 Air Filter Primary..... A-5628 Air Filter Primary..... AS-5628 Air Filter Set..... A-5628-S Fuel Filter..... F-1303 Hydraulic Oil Filter..... H-2702		<b>UH08</b> (EXCAVATORS) HINO EL100 Fuel Filter..... F-1302 Oil Filter Full Flow..... 0-1301 Oil Filter Full Flow..... 0-2703		<b>UH07-3</b> (EXCAVATORS) HINO DS50A Air Filter Primary..... A-5628 Air Filter Primary..... AS-5628 Air Filter Set..... A-5628-S Fuel Filter..... F-1302 Oil Filter Full Flow..... 0-1301 Oil Filter Full Flow..... 0-2703	
<b>UH06DT</b> (EXCAVATORS) PERKINS 6.354 Fuel Filter..... FC-5103 Oil Filter Full Flow..... C-5102		<b>UH081</b> (EXCAVATORS) HINO EL100 Air Filter..... AS-1010 Hydraulic Oil Filter..... H-2702 Hydraulic Oil Filter..... H-2704 Oil Filter Full Flow..... 0-1301		<b>UH033</b> (EXCAVATORS) ISUZU 4BB1 Hydraulic Oil Filter..... H-7912	
<b>UH07</b> (EXCAVATORS) ISUZU DA640 Hydraulic Oil Filter..... H-2702 Hydraulic Oil Filter..... H-7912		<b>UH082</b> (EXCAVATORS) Air Filter..... AS-1010 Oil Filter Full Flow..... 0-1301		<b>UH033</b> (EXCAVATORS) NISSAN FD3304 Hydraulic Oil Filter..... H-2705	
<b>UH071</b> (EXCAVATORS) ISUZU 6BD1 Hydraulic Oil Filter..... H-7912		<b>UH083</b> (EXCAVATORS) ISUZU 6BD1 Air Filter Primary..... A-5627 Air Filter Secondary..... A-6008 Air Filter Set..... A-5663-S Fuel Filter..... F-1303 Fuel Filter..... FC-1503 Fuel Filter..... FC-15031 Hydraulic Oil Filter..... H-2704 Hydraulic Oil Filter..... H-2714 Oil Filter By Pass..... 0-2701 Oil Filter Full Flow..... 0-1301		<b>UH031</b> (EXCAVATORS) ISUZU 4BB1 Hydraulic Oil Filter..... H-7912	
<b>UH073</b> (EXCAVATORS) HINO DS50 Hydraulic Oil Filter..... H-2702		<b>UH083</b> (EXCAVATORS) ISUZU 6DD1 Fuel Filter..... FC-15031			
<b>UH073</b> (EXCAVATORS) ISUZU 6BB1 Fuel Filter..... F-1303 Fuel Filter..... FC-1503 Fuel Filter..... FC-15031 Oil Filter Full Flow..... 0-1301					
<b>UH07-5</b> (EXCAVATORS) HINO EL100 Air Filter..... AS-1010 Hydraulic Oil Filter..... H-2702					

MODEL/APPLICATION	SAKURA NO	MODEL/APPLICATION	SAKURA NO	MODEL/APPLICATION	SAKURA NO
<b>HITACHI</b>		<b>HITACHI</b>		<b>HITACHI</b>	
<b>UH10</b> (EXCAVATORS) ISUZU 120		<b>UH123</b> (EXCAVATORS) HINO EM100		Hydraulic Oil Filter.....	H-2704
Air Filter Primary.....	A-2210	Air Filter Primary.....	A-6006	Oil Filter Full Flow.....	C-1312
Fuel Filter.....	F-1303	Air Filter Secondary.....	A-6007	Oil Filter Full Flow.....	O-1506
Hydraulic Oil Filter.....	H-2704	Air Filter Set.....	A-6118-S		
Oil Filter Full Flow.....	O-1506	Hydraulic Oil Filter.....	H-2704	<b>UH172</b> (EXCAVATORS)	
		Hydraulic Oil Filter.....	H-2714	Hydraulic Oil Filter.....	H-2704
<b>UH10</b> (EXCAVATORS) ISUZU E120		<b>UH14</b> (EXCAVATORS) DETROITD 6-71		<b>UH122LC</b> (EXCAVATORS) ISUZU E120	
Hydraulic Oil Filter.....	H-2702	Air Filter Primary.....	A-2210	Hydraulic Oil Filter.....	H-7912
<b>UH101</b> (EXCAVATORS) HINO EL100		Fuel Filter Primary.....	FC-6501		
Air Filter.....	AS-1010	Fuel Filter Secondary.....	FC-6502	<b>UH20</b> (EXCAVATORS) ISUZU E120	
Hydraulic Oil Filter.....	H-2702	Oil Filter Full Flow.....	O-6503	Hydraulic Oil Filter.....	H-2702
Hydraulic Oil Filter.....	H-7912			<b>UH20</b> (EXCAVATORS) ISUZU E120(2)	
Oil Filter Full Flow.....	O-1301	<b>UH14</b> (EXCAVATORS) ISUZU E120		Air Filter Primary.....	A-2210
<b>UH103</b> (EXCAVATORS) HINO EM100		Air Filter.....	AS-5707	Fuel Filter.....	F-1504
Air Filter Primary.....	A-6006	Air Filter Primary.....	A-2210	Hydraulic Oil Filter.....	H-2704
Air Filter Secondary.....	A-6007	Fuel Filter.....	F-1303	Oil Filter Full Flow.....	O-1506
Air Filter Set.....	A-6118-S	Fuel Filter.....	F-1504		
Fuel Filter.....	F-1304	Hydraulic Oil Filter.....	H-2702	<b>UH23</b> (EXCAVATORS) ISUZU 6RB1	
Hydraulic Oil Filter.....	H-2704	Hydraulic Oil Filter.....	H-2704	Hydraulic Oil Filter.....	H-2702
Oil Filter Full Flow.....	O-1301	Oil Filter Full Flow.....	O-1506		
<b>UH10-7</b> (EXCAVATORS) HINO EM100		<b>UH143</b> (EXCAVATORS) HITACHI EP100		<b>UH23</b> (EXCAVATORS) ISUZU E120 (QTY 2)	
Hydraulic Oil Filter.....	H-2702	Air Filter Primary.....	A-1313	Air Filter.....	AS-5707
<b>UH12</b> (EXCAVATORS) HITACHI B60		Air Filter Secondary.....	A-1307	Air Filter Primary.....	A-2210
Air Filter Primary.....	A-2210	Air Filter Set.....	A-5662-S	Fuel Filter.....	F-1504
Hydraulic Oil Filter.....	H-2702	Fuel Filter.....	F-1304	Hydraulic Oil Filter.....	H-2704
		Hydraulic Oil Filter.....	H-2704	Oil Filter Full Flow.....	O-1506
<b>UH12</b> (EXCAVATORS) HITACHI K60		Oil Filter By Pass.....	C-5718		
Air Filter Primary.....	A-2210	<b>UH143LC</b> (EXCAVATORS) HINO		<b>UH261</b> (EXCAVATORS) ISUZU E120	
<b>UH12</b> (EXCAVATORS) ISUZU E120		Air Filter Primary.....	A-1313	Air Filter Primary.....	A-2210
Fuel Filter.....	F-1504	Air Filter Secondary.....	A-1307	Air Filter Secondary.....	A-6008
Oil Filter Full Flow.....	O-1506	Air Filter Set.....	A-5662-S	Fuel Filter.....	F-1504
		Fuel Filter.....	FC-5720	Fuel Filter.....	FC-2703
<b>UH12</b> (EXCAVATORS) ISUZU EP100		Oil Filter By Pass.....	C-5718	Hydraulic Oil Filter.....	H-2704
Air Filter Primary.....	A-6006	<b>UH17</b> (EXCAVATORS) ISUZU E120		Oil Filter Full Flow.....	C-1312
Air Filter Set.....	A-6118-S	Fuel Filter.....	F-1504	Oil Filter Full Flow.....	O-1506
Fuel Filter.....	F-1304	Oil Filter Full Flow.....	O-1506		
Hydraulic Oil Filter.....	H-2704	<b>UH171</b> (EXCAVATORS) ISUZU E120		<b>UH30</b> (EXCAVATORS) ISUZU E120	
<b>UH121</b> (EXCAVATORS) ISUZU E120		Air Filter.....	AS-5707	Hydraulic Oil Filter.....	H-2702
Air Filter Primary.....	A-2210	Fuel Filter.....	F-1303		
Fuel Filter.....	F-1504	Fuel Filter.....	F-1504	<b>UH30</b> (EXCAVATORS)	
Hydraulic Oil Filter.....	H-2702	Hydraulic Oil Filter.....	H-2702	Air Filter.....	AS-5707
Hydraulic Oil Filter.....	H-7912	Hydraulic Oil Filter.....	H-2704	Fuel Filter.....	F-1504
Oil Filter Full Flow.....	O-1506	Oil Filter By Pass.....	C-5718	Hydraulic Oil Filter.....	H-2704
		Oil Filter Full Flow.....	O-1506	Oil Filter Full Flow.....	O-1506
<b>UH122</b> (EXCAVATORS)		<b>UH181</b> (EXCAVATORS) ISUZU 6RB1			
Air Filter Primary.....	A-2210	Air Filter Primary.....	A-6113	<b>UH43</b> (EXCAVATORS) HITACHI 4BB1	
Fuel Filter.....	F-1504	Air Filter Secondary.....	A-5408	Air Filter Primary.....	AS-1014
Oil Filter Full Flow.....	O-1506	Fuel Filter.....	F-1504	Fuel Filter.....	FC-2702
		Fuel Filter.....	FC-2703	Hydraulic Oil Filter.....	H-2714
		Hydraulic Oil Filter.....	H-2702	Oil Filter Full Flow.....	C-2702
				<b>UH53</b> (EXCAVATORS) HITACHI 4BD1	
				Fuel Filter.....	F-1303
				Fuel Filter.....	FC-2702
				Hydraulic Oil Filter.....	H-2714

# Sakura Filter

# ENGINE APPLICATION

MODEL/APPLICATION	SAKURA NO	MODEL/APPLICATION	SAKURA NO	MODEL/APPLICATION	SAKURA NO
<b>HITACHI</b>		<b>HITACHI</b>		<b>HITACHI</b>	
<b>UH53</b> (EXCAVATORS) HITACHI 48D1		<b>WH051</b> (EXCAVATORS) ISUZU 68BL		Hydraulic Oil Filter.....	H-27360
Oil Filter Full Flow.....	C-2702	Fuel Filter.....	F-1303	<b>ZW220</b> (LOADERS) ISUZU 6WG1	
		Oil Filter Full Flow.....	O-1301	Hydraulic Oil Filter.....	H-27360
<b>UH52</b> (EXCAVATORS) ISUZU 68BL , 1975		<b>WH051D</b> (EXCAVATORS) ISUZU 68B1		<b>ZW250</b> (LOADERS) ISUZU (S/N: 00101-UP) , 2006	
Fuel Filter.....	F-1303	Air Filter Primary.....	A-5628	Air Filter Primary.....	AS-5102
Oil Filter Full Flow.....	O-1301	Air Filter Primary.....	AS-5628	Air Filter Secondary.....	A-8651
		Air Filter Set.....	A-5628-S	Air Filter Set.....	AS-5102-S
<b>UH62</b> (EXCAVATORS) ISUZU 68D1		Fuel Filter.....	F-1303	Hydraulic Oil Filter Transmission..	HC-76130
Fuel Filter.....	F-1303	Hydraulic Oil Filter.....	H-2704	<b>ZW250</b> (LOADERS) ISUZU AH-6HK1X	
Oil Filter Full Flow.....	O-1301	Oil Filter Full Flow.....	O-1301	Cabin Air Filter.....	CA-55090
<b>UH80</b> (EXCAVATORS) CUMMINS KT-1150 (QTY 2)		<b>WH052</b> (EXCAVATORS) ISUZU 68B1		<b>ZW250</b> (LOADERS) ISUZU 6HK1	
Coolant Filter.....	WC-5705	Air Filter Primary.....	A-5628	Hydraulic Oil Filter.....	H-27360
Fuel Filter.....	FC-5702	Air Filter Primary.....	AS-5628	<b>ZW250</b> (LOADERS) ISUZU 6WG1	
Oil Filter By Pass.....	C-5718	Air Filter Set.....	A-5628-S	Hydraulic Oil Filter.....	H-27360
Oil Filter By Pass.....	O-5704	Fuel Filter.....	F-1303	<b>ZW250</b> (LOADERS) ISUZU 6WG1	
Oil Filter Full Flow.....	C-5715	Hydraulic Oil Filter.....	H-2704	Hydraulic Oil Filter.....	H-27360
		Oil Filter Full Flow.....	O-1503	<b>ZW310</b> (LOADERS) DAIMLERB OM460LA (S/N: 00101-UP) , 2006	
<b>UH801</b> (EXCAVATORS) CUMMINS KT-1150 (QTY 2)		<b>WH073D</b> (EXCAVATORS) ISUZU 68D1		Air Filter Primary.....	A-5614
Air Filter Primary.....	A-6113	Fuel Filter.....	F-1303	Air Filter Secondary.....	A-5610
Air Filter Secondary.....	A-5408	Hydraulic Oil Filter.....	H-2704	Fuel Filter.....	EF-2634
Coolant Filter.....	WC-5705	Oil Filter Full Flow.....	O-1301	Fuel/Water Separator.....	SFC-5301-10
Fuel Filter.....	FC-5702			Fuel/Water Separator.....	SFC-5301-10B
Hydraulic Oil Filter.....	H-2704	<b>WH801</b> (EXCAVATORS) CUMMINS KTA1150		<b>ZW310</b> (LOADERS) MERCEDES-BENZ OM 460 LA	
Oil Filter By Pass.....	C-5718	Air Filter Secondary.....	A-5408	Hydraulic Oil Filter.....	H-27360
Oil Filter By Pass.....	O-5704	Coolant Filter.....	WC-5713	<b>ZX110-3</b> (EXCAVATORS) ISUZU 4J-4JJ1X , 2008	
Oil Filter Full Flow.....	C-5715	Fuel Filter.....	FC-5720	Cabin Air Filter.....	CA-27020
		Oil Filter By Pass.....	O-5704	Cabin Air Filter.....	CA-27021
<b>UH81</b> (EXCAVATORS) HINO EL100		Oil Filter Full Flow.....	C-5715	<b>ZX110-3</b> (EXCAVATORS) ISUZU 4JJ1X	
Hydraulic Oil Filter.....	H-2704	<b>ZR260HC</b> (CRUSHER) ISUZU 6WG1X		Fuel Filter Main.....	EF-27050
Oil Filter Full Flow.....	O-1301	Fuel Filter Main.....	EF-27050	<b>ZX110-3</b> (EXCAVATORS) ISUZU AJ-4JJ1X	
		<b>ZR950JC</b> (CRUSHER) ISUZU 4HK1X		Cabin Air Filter.....	CA-27030
<b>UHM14</b> (EXCAVATORS) HITACHI D1301BH		Fuel Filter Main.....	EF-27050	Cabin Air Filter.....	CA-27040
Air Filter Primary.....	AS-2205	<b>ZW140</b> (LOADERS) CUMMINS QSB4.5		Oil Filter Combination.....	C-2704
Fuel Filter.....	FC-1206	Hydraulic Oil Filter.....	H-27400	<b>ZX110</b> (EXCAVATORS) ISUZU 4BG1 TRG	
		<b>ZW180</b> (LOADERS) CUMMINS QSB6.7 , 2007		Air Filter Primary.....	A-5541
<b>WH03</b> (EXCAVATORS) ISUZU DA220		Air Filter Secondary.....	A-8651	Air Filter Primary.....	A-5541M
Air Filter Primary.....	AS-1014	Fuel/Water Separator.....	SFC-5711	Air Filter Primary.....	A-76231
Fuel Filter.....	F-1303	Oil Filter Full Flow.....	C-5708	Air Filter Secondary.....	A-5540
Oil Filter Full Flow.....	O-1505	<b>ZW220 - 00101</b> (LOADERS) ISUZU ISUZU , 2006		Air Filter Secondary.....	A-7956
		Air Filter Primary.....	AS-5102	Air Filter Set.....	A-5541M-S
<b>WH04</b> (EXCAVATORS) ISUZU 68B1		Air Filter Set.....	AS-5102-S	Fuel Filter.....	FC-1005
Air Filter Primary.....	A-5628	<b>ZW250 - 00101</b> (LOADERS) ISUZU ISUZU , 2006		Fuel Filter.....	FC-1801
Air Filter Primary.....	AS-1014	Air Filter Primary.....	AS-5102	Hydraulic Oil Filter.....	H-2703
Air Filter Primary.....	AS-5628	Air Filter Set.....	AS-5102-S	<b>ZX110</b> (EXCAVATORS) ISUZU BB-4BG1T	
Air Filter Set.....	A-5628-S	<b>ZW220</b> (LOADERS) ISUZU 6HK1		Cabin Air Filter.....	CA-27040
Fuel Filter.....	F-1303				
Oil Filter Full Flow.....	O-1503				



# Sakura Filter

# ENGINE APPLICATION

MODEL/APPLICATION	SAKURA NO	MODEL/APPLICATION	SAKURA NO	MODEL/APPLICATION	SAKURA NO
<b>HITACHI</b>		<b>HITACHI</b>		<b>HITACHI</b>	
<b>ZX110</b> (EXCAVATORS) w/Isuzu BB-4BG1T Eng.		Hydraulic Oil Filter.....	H-2703	Air Filter Primary.....	A-5539
Cabin Air Filter.....	CA-27050	<b>ZX125US-E</b> (EXCAVATORS) ISUZU 4BG1T		Air Filter Primary.....	A-5539M
Oil Filter Combination.....	C-2704	Cabin Air Filter.....	CA-27040	Air Filter Secondary.....	A-5538
<b>ZX110-E</b> (EXCAVATORS) ISUZU 4BG1		Oil Filter Combination.....	C-2704	Air Filter Set.....	A-2709-S
Fuel Filter.....	FC-1824	<b>ZX125US-E</b> (EXCAVATORS) ISUZU 4BG1T (S/N: 001001-UP)		Air Filter Set.....	A-2709M-S
<b>ZX110-E</b> (EXCAVATORS) ISUZU 4BG1T		Air Filter Primary.....	A-5541	Cabin Air Filter.....	CA-27040
Cabin Air Filter.....	CA-27040	Air Filter Primary.....	A-5541M	Cabin Air Filter.....	CA-27050
Cabin Air Filter.....	CA-27050	Air Filter Primary.....	A-76231	Fuel Filter.....	FC-1005
Oil Filter Combination.....	C-2704	Air Filter Secondary.....	A-5540	Fuel Filter.....	FC-1801
<b>ZX110M</b> (EXCAVATORS) ISUZU 4BG1		Air Filter Secondary.....	A-7956	Oil Filter Combination.....	C-2704
Fuel Filter.....	FC-1824	Air Filter Set.....	A-5541M-S	<b>ZX135US</b> (EXCAVATORS) ISUZU 4BG1T	
<b>ZX110M</b> (EXCAVATORS) ISUZU 4BG1T		Fuel Filter.....	FC-1005	Cabin Air Filter.....	CA-27040
Cabin Air Filter.....	CA-27040	Hydraulic Oil Filter.....	H-2703	Oil Filter Combination.....	C-2704
Cabin Air Filter.....	CA-27050	<b>ZX130</b> (EXCAVATORS) ISUZU CC-4BG1TC		<b>ZX135US</b> (EXCAVATORS) ISUZU 4BG1 TCG (S/N: 060001-UP)	
Fuel Filter.....	FC-1824	Cabin Air Filter.....	CA-27040	Air Filter Primary.....	A-5541
Oil Filter Combination.....	C-2704	<b>ZX130</b> (EXCAVATORS) S/N: 60138-UP		Air Filter Primary.....	A-5541M
<b>ZX120</b> (EXCAVATORS) ISUZU 4BG1T		Air Filter Primary.....	A-5541	Air Filter Primary.....	A-76231
Air Filter Primary.....	A-5541	Air Filter Primary.....	A-5541M	Air Filter Secondary.....	A-5540
Air Filter Primary.....	A-5541M	Air Filter Primary.....	A-76231	Air Filter Secondary.....	A-7956
Air Filter Primary.....	A-76231	Air Filter Secondary.....	A-5540	Air Filter Set.....	A-5541M-S
Air Filter Secondary.....	A-5540	Air Filter Set.....	A-5541M-S	Fuel Filter.....	FC-1005
Air Filter Secondary.....	A-7956	Fuel Filter.....	FC-1005	Hydraulic Oil Filter.....	H-2703
Air Filter Set.....	A-5541M-S	Fuel Filter.....	FC-1801	<b>ZX135US</b> (EXCAVATORS) S/N: 62997-UP	
Cabin Air Filter.....	CA-27040	Hydraulic Oil Filter.....	H-2703	Air Filter Primary.....	A-5541
Cabin Air Filter.....	CA-27050	<b>ZX130</b> (EXCAVATORS) S/N: T0-60137		Air Filter Primary.....	A-5541M
Fuel Filter.....	FC-1005	Air Filter Primary.....	A-2708	Air Filter Primary.....	A-76231
Hydraulic Oil Filter.....	H-2703	Air Filter Secondary.....	A-7956	Air Filter Secondary.....	A-5540
Oil Filter Combination.....	C-2704	Air Filter Set.....	A-2711-S	Air Filter Set.....	A-5541M-S
<b>ZX120-3</b> (EXCAVATORS) ISUZU 4JJ1X		Fuel Filter.....	FC-1005	Fuel Filter.....	FC-1005
Cabin Air Filter.....	CA-27030	Fuel Filter.....	FC-1801	Fuel Filter.....	FC-1801
Fuel Filter Main.....	EF-27050	Hydraulic Oil Filter.....	H-2703	Hydraulic Oil Filter.....	H-2703
Fuel Filter Primary.....	EF-2701	<b>ZX130</b> (EXCAVATORS) W/ISUZU CC-4BG1TC ENG.		<b>ZX135US</b> (EXCAVATORS) S/N: T0-62996	
<b>ZX120-E</b> (EXCAVATORS) ISUZU 4BG1T		Cabin Air Filter.....	CA-27050	Air Filter Secondary.....	A-7956
Cabin Air Filter.....	CA-27040	Oil Filter Combination.....	C-2704	Fuel Filter.....	FC-1005
Cabin Air Filter.....	CA-27050	<b>ZX130H</b> (EXCAVATORS) ISUZU 4BG1T		Fuel Filter.....	FC-1801
Oil Filter Combination.....	C-2704	Cabin Air Filter.....	CA-27040	Hydraulic Oil Filter.....	H-2703
<b>ZX125</b> (EXCAVATORS) S/N: 10572-UP		Cabin Air Filter.....	CA-27050	<b>ZX16</b> (EXCAVATORS) ISUZU 3YB1	
Air Filter Primary.....	A-5541	Oil Filter Combination.....	C-2704	Fuel Filter.....	F-5207
Air Filter Primary.....	A-5541M	<b>ZX130K</b> (EXCAVATORS) ISUZU 4BG1T		Hydraulic Oil Filter.....	H-2712
Air Filter Primary.....	A-76231	Cabin Air Filter.....	CA-27050	Hydraulic Oil Filter.....	HC-5807
Air Filter Secondary.....	A-5540	Oil Filter Combination.....	C-2704	<b>ZX18</b> (EXCAVATORS) ISUZU 3YB1	
Air Filter Set.....	A-5541M-S	<b>ZX130LCN-3</b> (EXCAVATORS) ISUZU AJ-4JJ1X		Fuel Filter.....	F-5207
Fuel Filter.....	FC-1005	Cabin Air Filter.....	CA-27030	Hydraulic Oil Filter.....	H-2712
Fuel Filter.....	FC-1801	Cabin Air Filter.....	CA-27040	Hydraulic Oil Filter.....	HC-5807
Hydraulic Oil Filter.....	H-2703	Fuel Filter Primary.....	EF-2701	<b>ZX180</b> (EXCAVATORS)	
<b>ZX125</b> (EXCAVATORS) S/N: T0-10571		Oil Filter Combination.....	C-2704	Air Filter Primary.....	A-5541
Air Filter Secondary.....	A-7956	<b>ZX130W</b> (EXCAVATORS) ISUZU 4BG1T		Air Filter Primary.....	A-5541M
				Air Filter Primary.....	A-76231
				Air Filter Secondary.....	A-5540
				Air Filter Set.....	A-5541M-S
				Fuel Filter.....	FC-1005

MODEL/APPLICATION	SAKURA NO	MODEL/APPLICATION	SAKURA NO	MODEL/APPLICATION	SAKURA NO
<b>HITACHI</b>		<b>HITACHI</b>		<b>HITACHI</b>	
<b>ZX180</b> (EXCAVATORS)		<b>ZX135USK</b> (EXCAVATORS) ISUZU 4BG1 TCG (S/N: 060001-UP)		Air Filter Primary.....	A-5539M
Fuel Filter.....	FC-1801	Air Filter Primary.....	A-5541	Air Filter Secondary.....	A-5538
Hydraulic Oil Filter.....	H-2703	Air Filter Primary.....	A-5541M	Air Filter Set.....	A-2709-S
		Air Filter Primary.....	A-76231	Air Filter Set.....	A-2709M-S
<b>ZX180LC</b> (EXCAVATORS) ISUZU 4BG1T		Air Filter Secondary.....	A-5540		
Cabin Air Filter.....	CA-27040	Air Filter Secondary.....	A-7956		
		Air Filter Set.....	A-5541M-S		
<b>ZX180LC</b> (EXCAVATORS) ISUZU AA-4BG1TCS (S/N: 005001-UP)		Fuel Filter.....	FC-1005		
Air Filter Primary.....	A-5541	Hydraulic Oil Filter.....	H-2703		
Air Filter Primary.....	A-5541M			<b>ZX160W</b> (EXCAVATORS)	
Air Filter Primary.....	A-76231			Air Filter Primary.....	A-5539
Air Filter Secondary.....	A-5540			Air Filter Primary.....	A-5539M
Air Filter Set.....	A-5541M-S			Air Filter Secondary.....	A-5538
Fuel Filter.....	FC-1005			Air Filter Set.....	A-2709-S
Hydraulic Oil Filter.....	H-2703			Air Filter Set.....	A-2709M-S
				Fuel Filter.....	FC-1005
<b>ZX180LC-3</b> (EXCAVATORS) ISUZU AI-4JJ1X		<b>ZX160</b> (EXCAVATORS) ISUZU AA-4BG1TC		Fuel Filter.....	FC-1801
Cabin Air Filter.....	CA-27030	Cabin Air Filter.....	CA-27040		
				<b>ZX17U-2</b> (EXCAVATORS) YANMAR 3TNV70-VHB (S/N: 010001-UP) , 2007	
<b>ZX180LC-3</b> (EXCAVATORS) w/Isuzu AI-4JJ1X Eng.		<b>ZX160</b> (EXCAVATORS)		Hydraulic Oil Filter.....	H-2712
Fuel Filter Primary.....	EF-2701	Air Filter Primary.....	A-5541		
		Air Filter Primary.....	A-5541M		
<b>ZX180LCN</b> (EXCAVATORS) ISUZU 4BG1T		Air Filter Primary.....	A-76231		
Cabin Air Filter.....	CA-27040	Air Filter Secondary.....	A-5540		
		Air Filter Set.....	A-5541M-S		
<b>ZX180W</b> (EXCAVATORS) ISUZU 4BG1X		<b>ZX160</b> (EXCAVATORS) W/ISUZU AA-4BG1TC ENG.			
Cabin Air Filter.....	CA-27040	Cabin Air Filter.....	CA-27050		
Cabin Air Filter.....	CA-27050	Oil Filter Combination.....	C-2704		
Hydraulic Oil Filter Return.....	H-27380			<b>ZX160LCT</b> (EXCAVATORS) ISUZU CC-4BG1TC	
				Cabin Air Filter.....	CA-27040
<b>ZX180W</b> (EXCAVATORS) ISUZU AA-4BG1 (S/N: 001001-UP)		<b>ZX160LC</b> (EXCAVATORS) ISUZU 4BG1			
Air Filter Primary.....	A-5539	Fuel Filter.....	FC-1824		
Air Filter Primary.....	A-5539M			<b>ZX160LCT</b> (EXCAVATORS) W/ISUZU CC-4BG1TC ENG.	
Air Filter Secondary.....	A-5538			Cabin Air Filter.....	CA-27050
Air Filter Set.....	A-2709-S				
Air Filter Set.....	A-2709M-S			<b>ZX110M-3</b> (EXCAVATORS) ISUZU 4JJ1X	
Fuel Filter.....	FC-1005			Fuel Filter Main.....	EF-27050
Hydraulic Oil Filter Return.....	H-7981				
Hydraulic Oil Filter Suction.....	H-2706			<b>ZX110M-3</b> (EXCAVATORS) ISUZU AJ-4JJ1X	
				Cabin Air Filter.....	CA-27030
<b>ZX180W</b> (EXCAVATORS)		<b>ZX160LC</b> (EXCAVATORS) ISUZU AA-4BG1TC (S/N: 005001-UP)		Cabin Air Filter.....	CA-27040
Air Filter Primary.....	A-5539	Air Filter Primary.....	A-5541	Fuel Filter Primary.....	EF-2701
Air Filter Primary.....	A-5539M	Air Filter Primary.....	A-5541M	Oil Filter Combination.....	C-2704
Air Filter Secondary.....	A-5538	Air Filter Primary.....	A-76231		
Air Filter Set.....	A-2709-S	Air Filter Secondary.....	A-5540		
Air Filter Set.....	A-2709M-S	Air Filter Set.....	A-5541M-S		
Fuel Filter.....	FC-1005	Fuel Filter.....	FC-1005		
Hydraulic Oil Filter Return.....	H-7981	Fuel Filter.....	FC-1801		
Hydraulic Oil Filter Suction.....	H-2706	Hydraulic Oil Filter.....	H-2703		
				<b>ZX130-3</b> (EXCAVATORS) ISUZU 4JJ1X	
<b>ZX135USK</b> (EXCAVATORS) ISUZU 4BG1T		<b>ZX160LC</b> (EXCAVATORS) ISUZU AA-4BG1TC		Fuel Filter Main.....	EF-27050
Cabin Air Filter.....	CA-27040	Cabin Air Filter.....	CA-27040		
Oil Filter Combination.....	C-2704			<b>ZX130-3</b> (EXCAVATORS) ISUZU AJ-4JJ1X	
				Cabin Air Filter.....	CA-27030
				Cabin Air Filter.....	CA-27040
				Fuel Filter Primary.....	EF-2701
				Oil Filter Combination.....	C-2704
				<b>ZX130K-3</b> (EXCAVATORS) ISUZU 4JJ1X	
				Fuel Filter Main.....	EF-27050
				<b>ZX130K-3</b> (EXCAVATORS) ISUZU AJ-4JJ1X	
				Cabin Air Filter.....	CA-27030
				Cabin Air Filter.....	CA-27040
				Fuel Filter Primary.....	EF-2701
				Oil Filter Combination.....	C-2704
				<b>ZX135US-3</b> (EXCAVATORS) ISUZU 4JJ1X	
				Cabin Air Filter.....	CA-27040
				Fuel Filter Main.....	EF-27050
				Fuel Filter Primary.....	EF-2701
				<b>ZX140W-3</b> (EXCAVATORS) ISUZU 4JJ1X	

# Sakura Filter

# ENGINE APPLICATION

MODEL/APPLICATION	SAKURA NO	MODEL/APPLICATION	SAKURA NO	MODEL/APPLICATION	SAKURA NO
<b>HITACHI</b>		<b>HITACHI</b>		<b>HITACHI</b>	
ZX140W-3 (EXCAVATORS) ISUZU 4JJ1X Fuel Filter Main.....	EF-27050	ZX135US-E (EXCAVATORS) ISUZU 4BG1T Cabin Air Filter.....	CA-27040	ZX160LC-3-HCME (EXCAVATORS) ISUZU 4JJ1X Fuel Filter Main.....	EF-27050
ZX140W-3 (EXCAVATORS) ISUZU AI-4JJ1X Cabin Air Filter.....	CA-27030	Oil Filter Combination.....	C-2704	ZX170W-3-AMS (EXCAVATORS) ISUZU 4HK1 Fuel Filter Main.....	EF-27050
Cabin Air Filter.....	CA-27040	ZX1000K-3 (EXCAVATORS) ISUZU 6WG1X Fuel Filter Main.....	EF-27050	ZX170W-3DARUMA (EXCAVATORS) ISUZU 4HK1 Fuel Filter Main.....	EF-27050
Hydraulic Oil Filter.....	H-2720	ZX110-3AMS (EXCAVATORS) ISUZU 4JJ1X Fuel Filter Main.....	EF-27050	ZX170WM-3 (EXCAVATORS) ISUZU 4HK1 Fuel Filter Main.....	EF-27050
ZX140W-3 (EXCAVATORS) w/Isuzu AI-4JJ1X Eng. Fuel Filter Primary.....	EF-2701	ZX110-3-HCME (EXCAVATORS) ISUZU 4JJ1X Fuel Filter Main.....	EF-27050	ZX1800K-3 (EXCAVATORS) ISUZU 6WG1X Fuel Filter Main.....	EF-27050
Oil Filter Combination.....	C-2704	ZX110M-3-HCME (EXCAVATORS) ISUZU 4JJ1X Fuel Filter Main.....	EF-27050	ZX130-5 (EXCAVATORS) ISUZU 4JJ1 Fuel Filter.....	F-7930
ZX145W-3 (EXCAVATORS) ISUZU 4JJ1X Fuel Filter Main.....	EF-27050	ZX130-3-AMS (EXCAVATORS) ISUZU 4JJ1X Fuel Filter Main.....	EF-27050	ZX180LC-5 (EXCAVATORS) ISUZU 4JJ1 Fuel Filter.....	F-7930
ZX145W-3 (EXCAVATORS) ISUZU AI-4JJ1X Cabin Air Filter.....	CA-27030	ZX130-3-HCME (EXCAVATORS) ISUZU 4JJ1X Fuel Filter Main.....	EF-27050	ZX190W-5 (EXCAVATORS) ISUZU 4HK1 Fuel Filter.....	F-7930
Cabin Air Filter.....	CA-27040	ZX130L-3 (EXCAVATORS) ISUZU 4JJ1X Fuel Filter Main.....	EF-27050	ZX200-3 (EXCAVATORS) ISUZU AH-4HK1XYSYA-02 , 2008 Air Filter Primary.....	A-5539
ZX145W-3 (EXCAVATORS) w/Isuzu AI-4JJ1X Eng. Fuel Filter Primary.....	EF-2701	ZX130LCN-3F-AMS (EXCAVATORS) ISUZU 4JJ1X Fuel Filter Main.....	EF-27050	Air Filter Primary.....	A-5539M
Oil Filter Combination.....	C-2704	ZX130LCN-3F-HCME (EXCAVATORS) ISUZU 4JJ1X Fuel Filter Main.....	EF-27050	Air Filter Secondary.....	A-5538
ZX160LC-3 (EXCAVATORS) ISUZU 4JJ1X Fuel Filter Main.....	EF-27050	ZX135US-3F-HCME (EXCAVATORS) ISUZU 4JJ1X Fuel Filter Main.....	EF-27050	Air Filter Set.....	A-2709-S
ZX160LC-3 (EXCAVATORS) ISUZU AI-4JJ1X Cabin Air Filter.....	CA-27030	ZX135US-3-HCME (EXCAVATORS) ISUZU 4JJ1X Fuel Filter Main.....	EF-27050	Air Filter Set.....	A-2709M-S
ZX160LC-3 (EXCAVATORS) w/Isuzu AI-4JJ1X Eng. Fuel Filter Primary.....	EF-2701	ZX135US-3-HCME (EXCAVATORS) ISUZU 4JJ1X Fuel Filter Main.....	EF-27050	Cabin Air Filter.....	CA-27020
Oil Filter Combination.....	C-2704	ZX135US-3-HCME (EXCAVATORS) ISUZU 4JJ1X Fuel Filter Main.....	EF-27050	Cabin Air Filter.....	CA-27021
ZX170W-3 (EXCAVATORS) ISUZU 4HK1 Fuel Filter Main.....	EF-27050	ZX135US-3-HCME (EXCAVATORS) ISUZU 4JJ1X Fuel Filter Main.....	EF-27050	ZX200-3 (EXCAVATORS) ISUZU 4HK1 Fuel Filter.....	F-7914
ZX170W-3 (EXCAVATORS) ISUZU AI-4HK1X Cabin Air Filter.....	CA-27030	ZX135US-3-HCME (EXCAVATORS) ISUZU 4JJ1X Fuel Filter Main.....	EF-27050	ZX200-3 (EXCAVATORS) ISUZU 4HK1X Cabin Air Filter.....	CA-27030
Cabin Air Filter.....	CA-27040	ZX135US-3-HCME (EXCAVATORS) ISUZU 4JJ1X Fuel Filter Main.....	EF-27050	ZX200-3 (EXCAVATORS) w/Isuzu 4HK1X Eng. Fuel Filter Primary.....	EF-2701
Fuel Filter Primary.....	EF-2701	ZX135US-3-HCME (EXCAVATORS) ISUZU 4JJ1X Fuel Filter Main.....	EF-27050	ZX200LC-3 (EXCAVATORS) ISUZU AH-4HK1XYSYA-02 , 2008 Cabin Air Filter.....	CA-27020
ZX180LCN-3 (EXCAVATORS) ISUZU AI-4JJ1X Cabin Air Filter.....	CA-27030	ZX140W-3-AMS (EXCAVATORS) ISUZU 4JJ1X Fuel Filter Main.....	EF-27050	Cabin Air Filter.....	CA-27021
ZX180LCN-3 (EXCAVATORS) w/Isuzu AI-4JJ1X Eng. Fuel Filter Primary.....	EF-2701	ZX140W-3DARUMA (EXCAVATORS) ISUZU 4JJ1X Fuel Filter Main.....	EF-27050	ZX200LC-3 (EXCAVATORS) ISUZU 4HK1 Fuel Filter Primary.....	EF-27040
ZX190W-3 (EXCAVATORS) ISUZU AI-4HK1X Cabin Air Filter.....	CA-27030	ZX160LC-3-AMS (EXCAVATORS) ISUZU 4JJ1X Fuel Filter Main.....	EF-27050	Hydraulic Oil Filter.....	H-27360
Fuel Filter Primary.....	EF-2701	ZX125US (EXCAVATORS) ISUZU 4BG1T Cabin Air Filter.....	CA-27040	ZX200LC-3 (EXCAVATORS) ISUZU 4HK1X Cabin Air Filter.....	CA-27030
Oil Filter Combination.....	C-2704	Oil Filter Combination.....	C-2704		



# Sakura Filter

# ENGINE APPLICATION

MODEL/APPLICATION	SAKURA NO	MODEL/APPLICATION	SAKURA NO	MODEL/APPLICATION	SAKURA NO
<b>HITACHI</b>		<b>HITACHI</b>		<b>HITACHI</b>	
ZX250LCN-3 (EXCAVATORS) ISUZU AH 4HK1 XYS/20001 , 2006		Cabin Air Filter..... CA-27030		ZX210W (EXCAVATORS) ISUZU 6BG1T	
Cabin Air Filter..... CA-27020				Cabin Air Filter..... CA-27040	
Cabin Air Filter..... CA-27021				Fuel Filter..... FC-15031	
ZX250LCN-3 (EXCAVATORS) ISUZU AH4HK		ZX200LC (EXCAVATORS) ISUZU 6BG1TRA , 2002		ZX210W (EXCAVATORS) ISUZU AA-6BG1T	
Hydraulic Oil Filter..... H-27360		Air Filter Primary..... A-5539		Air Filter Primary..... A-5539	
ZX250LCN-3 (EXCAVATORS) ISUZU AH-4HK1X		Air Filter Primary..... A-5539M		Air Filter Primary..... A-5539M	
Cabin Air Filter..... CA-27030		Air Filter Secondary..... A-5538		Air Filter Secondary..... A-5538	
ZX270-3 (EXCAVATORS) ISUZU ISUZU/30001 , 2006		Air Filter Set..... A-2709-S		Air Filter Set..... A-2709-S	
Cabin Air Filter..... CA-27020		Air Filter Set..... A-2709M-S		Air Filter Set..... A-2709M-S	
Cabin Air Filter..... CA-27021		Fuel Filter..... FC-1005		Fuel Filter..... FC-1005	
ZX270-3 (EXCAVATORS) ISUZU (S/N: 030001-UP) , 2006		Fuel Filter..... FC-1503		Fuel Filter..... FC-1503	
Air Filter Primary..... A-5539		Hydraulic Oil Filter..... H-2703		Hydraulic Oil Filter Return..... H-7981	
Air Filter Primary..... A-5539M		Hydraulic Oil Filter Return..... H-7981		Hydraulic Oil Filter Suction..... H-2706	
Air Filter Secondary..... A-5538		ZX200LC (EXCAVATORS) ISUZU 6BG1		ZX210W-3 (EXCAVATORS) ISUZU AI-4HK1X	
Air Filter Set..... A-2709-S		Cabin Air Filter..... CA-27040		Cabin Air Filter..... CA-27030	
Air Filter Set..... A-2709M-S		Fuel Filter..... FC-15031		ZX230 (EXCAVATORS) ISUZU 6BG1T	
ZX270-3 (EXCAVATORS) ISUZU AH-4HK1X		ZX200LC-E (EXCAVATORS) ISUZU 6BG1		Cabin Air Filter..... CA-27040	
Cabin Air Filter..... CA-27030		Cabin Air Filter..... CA-27040		Fuel Filter..... FC-15031	
ZX270LC-3 (EXCAVATORS) ISUZU ISUZU/30001 , 2006		Fuel Filter..... FC-15031		ZX230 (EXCAVATORS) ISUZU CC6BG1TRA01	
Cabin Air Filter..... CA-27020		ZX210 (EXCAVATORS) ISUZU 6BG1T		Air Filter Primary..... A-5539	
Cabin Air Filter..... CA-27021		Cabin Air Filter..... CA-27040		Air Filter Primary..... A-5539M	
ZX270LC-3 (EXCAVATORS) ISUZU AH-4HK1X		Fuel Filter..... FC-15031		Air Filter Secondary..... A-5538	
Cabin Air Filter..... CA-27030		ZX210 (EXCAVATORS)		Air Filter Set..... A-2709-S	
ZX280LC-3 (EXCAVATORS) ISUZU ISUZU/30001 , 2006		Air Filter Primary..... A-5539		Air Filter Set..... A-2709M-S	
Cabin Air Filter..... CA-27020		Air Filter Primary..... A-5539M		Fuel Filter..... FC-1005	
Cabin Air Filter..... CA-27021		Air Filter Secondary..... A-5538		Fuel Filter..... FC-1503	
ZX280LC-3 (EXCAVATORS) ISUZU AH-4HK1X		Air Filter Set..... A-2709-S		Hydraulic Oil Filter..... H-2703	
Cabin Air Filter..... CA-27030		Air Filter Set..... A-2709M-S		Hydraulic Oil Filter Return..... H-7981	
ZX280LC-3 (EXCAVATORS) ISUZU ISUZU/30001 , 2006		Fuel Filter..... FC-1005		Hydraulic Oil Filter Suction..... H-2706	
Cabin Air Filter..... CA-27020		Fuel Filter..... FC-1503		ZX230LC (EXCAVATORS) ISUZU 6BG1	
Cabin Air Filter..... CA-27021		Hydraulic Oil Filter..... H-2703		Fuel Filter..... FC-15031	
ZX280LC-3 (EXCAVATORS) ISUZU (S/N: 030001-UP) , 2006		Hydraulic Oil Filter Return..... H-7981		ZX240 (EXCAVATORS) ISUZU 6BG1	
Air Filter Primary..... A-5539		Hydraulic Oil Filter Suction..... H-2706		Air Filter Primary..... A-5539	
Air Filter Primary..... A-5539M		ZX210-3 (EXCAVATORS)		Air Filter Primary..... A-5539M	
Air Filter Secondary..... A-5538		Air Filter Primary..... A-5539		Air Filter Secondary..... A-5538	
Air Filter Set..... A-2709-S		Air Filter Primary..... A-5539M		Air Filter Set..... A-2709-S	
Air Filter Set..... A-2709M-S		Air Filter Secondary..... A-5538		Air Filter Set..... A-2709M-S	
ZX280LCH-3 (EXCAVATORS) ISUZU ISUZU/30001 , 2006		Air Filter Set..... A-2709-S		Fuel Filter..... FC-1005	
Cabin Air Filter..... CA-27020		Air Filter Set..... A-2709M-S		Fuel Filter..... FC-1503	
Cabin Air Filter..... CA-27021		ZX210LCH (EXCAVATORS) ISUZU 6BG1T		Hydraulic Oil Filter..... H-2703	
ZX280LCH-3 (EXCAVATORS) ISUZU AH-4HK1X		Cabin Air Filter..... CA-27040		Hydraulic Oil Filter Return..... H-7981	
Cabin Air Filter..... CA-27030		ZX210LCH (EXCAVATORS) ISUZU 6BG1		Hydraulic Oil Filter Suction..... H-2706	
ZX280LCN-3 (EXCAVATORS) ISUZU ISUZU/30001 , 2006		Fuel Filter..... FC-15031		ZX240H (EXCAVATORS) ISUZU 6BG1T	
Cabin Air Filter..... CA-27020		ZX210LCK (EXCAVATORS) ISUZU 6BG1T		Fuel Filter..... FC-15031	
Cabin Air Filter..... CA-27021		Cabin Air Filter..... CA-27040		ZX240K (EXCAVATORS) ISUZU 6BG1T	
ZX280LCN-3 (EXCAVATORS) ISUZU AH-4HK1X		ZX210LCK (EXCAVATORS) ISUZU 6BG1		Cabin Air Filter..... CA-27040	
		Fuel Filter..... FC-15031			

# Sakura Filter

# ENGINE APPLICATION

MODEL/APPLICATION	SAKURA NO	MODEL/APPLICATION	SAKURA NO	MODEL/APPLICATION	SAKURA NO
<b>HITACHI</b>		<b>HITACHI</b>		<b>HITACHI</b>	
<b>ZX240K</b> (EXCAVATORS) ISUZU CC-6BG1T		Air Filter Secondary.....	A-5538	<b>ZX225US</b> (EXCAVATORS) ISUZU 6BG1TTRA03	
Fuel Filter.....	FC-27060	Air Filter Set.....	A-2709-S	Air Filter Primary.....	A-5539
<b>ZX240LCH</b> (EXCAVATORS) ISUZU 6BG1		Air Filter Set.....	A-2709M-S	Air Filter Primary.....	A-5539M
Fuel Filter.....	FC-15031	Fuel Filter.....	FC-1005	Air Filter Secondary.....	A-5538
<b>ZX240LCK</b> (EXCAVATORS) ISUZU 6BG1		Fuel Filter.....	FC-1503	Air Filter Set.....	A-2709-S
Fuel Filter.....	FC-15031	Hydraulic Oil Filter.....	H-2703	Air Filter Set.....	A-2709M-S
<b>ZX25</b> (EXCAVATORS) ISUZU 3YE1		Hydraulic Oil Filter.....	H-2709	Fuel Filter.....	FC-1005
Fuel Filter.....	F-5207	Hydraulic Oil Filter Return.....	H-7981	Fuel Filter.....	FC-1503
Hydraulic Oil Filter.....	H-2712	Hydraulic Oil Filter Suction.....	H-2706	Hydraulic Oil Filter.....	H-2703
Hydraulic Oil Filter.....	HC-5807	<b>ZX270LC</b> (EXCAVATORS) ISUZU 6BG1		Hydraulic Oil Filter Return.....	H-7981
<b>ZX250</b> (EXCAVATORS) ISUZU , 2005		Cabin Air Filter.....	CA-27040	Hydraulic Oil Filter Suction.....	H-2706
Air Filter Primary.....	A-5539	Fuel Filter.....	FC-15031	<b>ZX225US-3</b> (EXCAVATORS) ISUZU 4HK1-XYSA-02 , 2008	
Air Filter Primary.....	A-5539M	<b>ZX27U-2</b> (EXCAVATORS) YANMAR 3TNV88 (S/N: 010001-UP) , 2006		Air Filter Primary.....	A-5539
Air Filter Secondary.....	A-5538	Air Filter Primary.....	A-8513	Air Filter Primary.....	A-5539M
Air Filter Set.....	A-2709-S	Air Filter Secondary.....	A-5569	Air Filter Secondary.....	A-5538
Air Filter Set.....	A-2709M-S	Hydraulic Oil Filter.....	H-2712	Air Filter Set.....	A-2709-S
Fuel Filter.....	FC-1005	<b>ZX280-3</b> (EXCAVATORS) 2007		Air Filter Set.....	A-2709M-S
Fuel Filter.....	FC-1503	Air Filter Primary.....	A-5539	<b>ZX225US-E</b> (EXCAVATORS) ISUZU 6BG1TTRA03	
Hydraulic Oil Filter.....	H-2703	Air Filter Primary.....	A-5539M	Air Filter Primary.....	A-5539
Hydraulic Oil Filter Return.....	H-7981	Air Filter Secondary.....	A-5538	Air Filter Primary.....	A-5539M
Hydraulic Oil Filter Suction.....	H-2706	Air Filter Set.....	A-2709-S	Air Filter Secondary.....	A-5538
<b>ZX250LC</b> (EXCAVATORS) ISUZU CC-6BG1T		Air Filter Set.....	A-2709M-S	Air Filter Set.....	A-2709-S
Cabin Air Filter.....	CA-27040	<b>ZX280LC</b> (EXCAVATORS) ISUZU 6BG1TRA02 (S/N: 020001-UP) , 2006		Air Filter Set.....	A-2709M-S
<b>ZX250LCN</b> (EXCAVATORS) ISUZU CC 6BG1 (S/N: 010001-UP) , 2006		Air Filter Primary.....	A-5539	Fuel Filter.....	FC-1005
Air Filter Primary.....	A-5539	Air Filter Primary.....	A-5539M	Fuel Filter.....	FC-1503
Air Filter Primary.....	A-5539M	Air Filter Secondary.....	A-5538	Hydraulic Oil Filter.....	H-2703
Air Filter Secondary.....	A-5538	Air Filter Set.....	A-2709-S	Hydraulic Oil Filter Suction.....	H-2706
Air Filter Set.....	A-2709-S	Air Filter Set.....	A-2709M-S	<b>ZX225USR</b> (EXCAVATORS) ISUZU 6BG1T , 2002	
Air Filter Set.....	A-2709M-S	Air Filter Set.....	A-2709M-S	Air Filter Primary.....	A-5539
Fuel Filter.....	FC-1005	Air Filter Set.....	A-2709M-S	Air Filter Primary.....	A-5539M
Fuel Filter.....	FC-1503	Air Filter Set.....	A-2709M-S	Air Filter Secondary.....	A-5538
Hydraulic Oil Filter.....	H-2703	Fuel Filter.....	FC-1005	Air Filter Set.....	A-2709-S
Hydraulic Oil Filter Return.....	H-7981	Fuel Filter.....	FC-1503	Air Filter Set.....	A-2709M-S
Hydraulic Oil Filter Suction.....	H-2706	Hydraulic Oil Filter.....	H-2703	Fuel Filter.....	FC-1503
<b>ZX250LCN</b> (EXCAVATORS) ISUZU 6BG1		Hydraulic Oil Filter Return.....	H-7981	Hydraulic Oil Filter.....	H-2703
Fuel Filter.....	FC-15031	Hydraulic Oil Filter Suction.....	H-2706	Hydraulic Oil Filter Return.....	H-7981
<b>ZX250LCN</b> (EXCAVATORS) ISUZU CC-6BG1T		<b>ZX280LC</b> (EXCAVATORS) ISUZU 6BG1T		Hydraulic Oil Filter Suction.....	H-2706
Cabin Air Filter.....	CA-27040	Cabin Air Filter.....	CA-27040	<b>ZX225USR-3</b> (EXCAVATORS) ISUZU 4HK1-XYSA-02 , 2008	
<b>ZX270</b> (EXCAVATORS) ISUZU 6BG1T		Fuel Filter.....	FC-15031	Air Filter Primary.....	A-5539
Fuel Filter.....	FC-15031	<b>ZX280LCN</b> (EXCAVATORS) ISUZU 6BG1		Air Filter Primary.....	A-5539M
<b>ZX270</b> (EXCAVATORS) ISUZU 6BG1		Fuel Filter.....	FC-15031	Air Filter Secondary.....	A-5538
Cabin Air Filter.....	CA-27040	<b>ZX210LC III</b> (EXCAVATORS) 2007		Air Filter Set.....	A-2709-S
<b>ZX270</b> (EXCAVATORS) ISUZU 6BG1TRA02		Air Filter Primary.....	A-5539	Air Filter Set.....	A-2709M-S
Air Filter Primary.....	A-5539	Air Filter Primary.....	A-5539M	<b>ZX225USRK-3</b> (EXCAVATORS) ISUZU 4HK1-XYSA-02	
Air Filter Primary.....	A-5539M	Air Filter Secondary.....	A-5538	Air Filter Primary.....	A-5539
<b>ZX270</b> (EXCAVATORS) ISUZU 6BG1		Air Filter Set.....	A-2709-S	<b>ZX225USR</b> (EXCAVATORS) ISUZU 6BG1	
Cabin Air Filter.....	CA-27040	Air Filter Set.....	A-2709M-S	Fuel Filter.....	FC-15031
<b>ZX270</b> (EXCAVATORS) ISUZU 6BG1TRA02		<b>ZX225US</b> (EXCAVATORS) ISUZU 6BG1		<b>ZX225USR</b> (EXCAVATORS) ISUZU 6BG1	
Air Filter Primary.....	A-5539	Cabin Air Filter.....	CA-27040	Cabin Air Filter.....	CA-27040
Air Filter Primary.....	A-5539M				



# Sakura Filter

# ENGINE APPLICATION

MODEL/APPLICATION	SAKURA NO	MODEL/APPLICATION	SAKURA NO	MODEL/APPLICATION	SAKURA NO
<b>HITACHI</b>		<b>HITACHI</b>		<b>HITACHI</b>	
ZX225USRK-3 (EXCAVATORS) ISUZU 4HK1-XYSA-02		ZX225USRKLC-3 (EXCAVATORS) ISUZU 4HK1		ZX350H-3 (EXCAVATORS) ISUZU AH 6HK1 XYSA/50001 , 2006	
Air Filter Primary.....	A-5539M	Hydraulic Oil Filter.....	H-27360	Air Filter Primary.....	AS-5102
Air Filter Secondary.....	A-5538			Air Filter Set.....	AS-5102-S
Air Filter Set.....	A-2709-S	ZX210-5 (EXCAVATORS) ISUZU CC-6BG1		Cabin Air Filter.....	CA-27020
Air Filter Set.....	A-2709M-S	Fuel Filter.....	F-7930	Cabin Air Filter.....	CA-27021
ZX225USRK-3 (EXCAVATORS) ISUZU 4HK1X		ZX250LC-5 (EXCAVATORS) ISUZU 4HK1ZXSA-01		ZX350H-3 (EXCAVATORS) ISUZU AH 6HK1 XYSA (S/N: 050001-UP) , 2006	
Cabin Air Filter.....	CA-27040	Fuel Filter.....	F-7930	Air Filter Primary.....	AS-5102
ZX200-5G (EXCAVATORS) ISUZU CC-6BG1T		Fuel Filter.....	FC-27050	Air Filter Secondary.....	A-8651
Cabin Air Filter.....	CA-27060	ZX290LC-5 (EXCAVATORS) ISUZU AH-4K1X		Air Filter Set.....	AS-5102-S
ZX210LCH-5G (EXCAVATORS) ISUZU AH-4HK1XYSA-01		Fuel Filter.....	F-7930	ZX350H-3 (EXCAVATORS) ISUZU AH-6HK1X	
Cabin Air Filter.....	CA-27060	ZX225USLC-E (EXCAVATORS) ISUZU 6BG1T		Cabin Air Filter.....	CA-27030
ZX200 (EXCAVATORS) ISUZU 6BG1T		Fuel Filter.....	FC-15031	ZX350LC (EXCAVATORS) W/ISUZU AA-6HK1 ENG.	
Fuel Filter.....	FC-15031	ZX225USLC-E (EXCAVATORS) ISUZU 6BG1		Cabin Air Filter.....	CA-27050
ZX200 (EXCAVATORS) ISUZU 6BG1		Fuel Filter.....	FC-15031	ZX330LC-3 (EXCAVATORS) ISUZU AH 6HK1 XYSA/50001 , 2006	
Cabin Air Filter.....	CA-27040	ZX330-3 (EXCAVATORS) 2008		Air Filter Primary.....	AS-5102
ZX210H (EXCAVATORS) ISUZU 6BG1T		Air Filter Primary.....	A-8650	Air Filter Set.....	AS-5102-S
Cabin Air Filter.....	CA-27040	Air Filter Secondary.....	A-8651	Cabin Air Filter.....	CA-27020
ZX210K (EXCAVATORS) ISUZU 6BG1T		Air Filter Set.....	A-8652-S	Cabin Air Filter.....	CA-27021
Cabin Air Filter.....	CA-27040	Fuel Filter Main.....	EF-1801	ZX330LC-3 (EXCAVATORS) ISUZU AH-6HK1X	
ZX210LC (EXCAVATORS) ISUZU 6BG1T		Fuel Filter Main.....	EF-27060	Cabin Air Filter.....	CA-27030
Cabin Air Filter.....	CA-27040	Hydraulic Oil Filter.....	H-2724	ZX330LC-3 (EXCAVATORS) ISUZU 6HK1	
ZX225USLC (EXCAVATORS) ISUZU 6BG1T		Hydraulic Oil Filter.....	HC-2709	Cabin Air Filter.....	CA-27030
Fuel Filter.....	FC-15031	Oil Filter Combination.....	C-2708	ZX330LC-3 (EXCAVATORS) ISUZU 6WG1	
ZX225USLC (EXCAVATORS) ISUZU 6BG1		ZX330-3 (EXCAVATORS) ISUZU AH 6HK1 XYSA/50001 , 2006		Cabin Air Filter.....	CA-27030
Fuel Filter.....	FC-15031	Air Filter Primary.....	AS-5102	Hydraulic Oil Filter.....	H-27360
ZX225USLC-3 (EXCAVATORS) ISUZU 4HK1		Air Filter Set.....	AS-5102-S	ZX350-3 (EXCAVATORS) ISUZU AH-6HK1XYSA-01 , 2008	
Hydraulic Oil Filter.....	H-27360	Cabin Air Filter.....	CA-27020	Air Filter Primary.....	AS-5102
ZX225USRK (EXCAVATORS) ISUZU 6BG1		Cabin Air Filter.....	CA-27021	Air Filter Secondary.....	A-8651
Cabin Air Filter.....	CA-27040	ZX330-3 (EXCAVATORS) ISUZU AH 6HK1 XYSA (S/N: 050001-UP) , 2006		Air Filter Set.....	AS-5102-S
ZX225USRLC (EXCAVATORS) ISUZU 6BG1T		Air Filter Primary.....	AS-5102	Cabin Air Filter.....	CA-27020
Fuel Filter.....	FC-15031	Air Filter Secondary.....	A-8651	Cabin Air Filter.....	CA-27021
ZX225USRLC-3 (EXCAVATORS) ISUZU 4HK1		Air Filter Set.....	AS-5102-S	ZX350K-3 (EXCAVATORS) ISUZU AH 6HK1 XYSA (S/N: 050001-UP) , 2006	
Hydraulic Oil Filter.....	H-27360	ZX330-3 (EXCAVATORS) ISUZU AH-6HK1X		Air Filter Primary.....	AS-5102
ZX225USRLC-E (EXCAVATORS) ISUZU 6BG1T		Cabin Air Filter.....	CA-27030	Air Filter Set.....	AS-5102-S
Fuel Filter.....	FC-15031	ZX330-3 (EXCAVATORS)		Cabin Air Filter.....	CA-27020
ZX225USRLC-3 (EXCAVATORS) ISUZU 4HK1		Fuel Filter Main.....	EF-27022	Cabin Air Filter.....	CA-27021
Hydraulic Oil Filter.....	H-27360	ZX350H-3 (EXCAVATORS) 2008		ZX350K-3 (EXCAVATORS) ISUZU AH 6HK1 XYSA (S/N: 050001-UP) , 2006	
ZX225USRLC-E (EXCAVATORS) ISUZU 6BG1T		Air Filter Primary.....	A-8650	Air Filter Primary.....	AS-5102
Fuel Filter.....	FC-15031	Air Filter Secondary.....	A-8651	Air Filter Secondary.....	A-8651
ZX225USRLC (EXCAVATORS) ISUZU 6BG1T		Air Filter Set.....	A-8652-S	Air Filter Set.....	AS-5102-S
Fuel Filter.....	FC-15031	Fuel Filter Main.....	EF-1801	ZX350K-3 (EXCAVATORS) ISUZU AH-6HK1X	
ZX225USRLC (EXCAVATORS) ISUZU 6BG1T		Fuel Filter Main.....	EF-27060	Cabin Air Filter.....	CA-27030
Fuel Filter.....	FC-15031	Hydraulic Oil Filter.....	H-2724	ZX350K-3 (EXCAVATORS) ISUZU AH-6HK1X	
ZX225USRLC (EXCAVATORS) ISUZU 6BG1T		Hydraulic Oil Filter.....	HC-2709	Cabin Air Filter.....	CA-27030
Fuel Filter.....	FC-15031	Oil Filter Combination.....	C-2708		

MODEL/APPLICATION	SAKURA NO	MODEL/APPLICATION	SAKURA NO	MODEL/APPLICATION	SAKURA NO
<b>HITACHI</b>		<b>HITACHI</b>		<b>HITACHI</b>	
ZX350LCH-3 (EXCAVATORS) ISUZU AH 6HK1 XYS/A/50001 , 2006		Air Filter Set..... AS-5102-S		Cabin Air Filter..... CA-27030	
Air Filter Primary..... AS-5102		Fuel Filter..... FC-1005			
Air Filter Set..... AS-5102-S		Fuel Filter..... FC-2703		<b>ZX350LCH</b> (EXCAVATORS) ISUZU AA-6HK1XQA , 2002	
Cabin Air Filter..... CA-27020		Hydraulic Oil Filter..... H-2703		Air Filter Primary..... AS-5102	
Cabin Air Filter..... CA-27021		Hydraulic Oil Filter Return..... H-7981		Air Filter Set..... AS-5102-S	
		Hydraulic Oil Filter Suction..... H-2706			
ZX350LCH-3 (EXCAVATORS) ISUZU AH-6HK1X		<b>ZX330</b> (EXCAVATORS) ISUZU 6HK1		<b>ZX350LCH</b> (EXCAVATORS) ISUZU AA-6HK1	
Cabin Air Filter..... CA-27030		Cabin Air Filter..... CA-27040		Cabin Air Filter..... CA-27040	
ZX350LCH-3 (EXCAVATORS) ISUZU 6HK1		<b>ZX330LC</b> (EXCAVATORS) ISUZU AA-6HK1XQA , 2002		<b>ZX350LCH</b> (EXCAVATORS) W/ISUZU AA-6HK1 ENG.	
Hydraulic Oil Filter..... H-27360		Air Filter Primary..... AS-5102		Cabin Air Filter..... CA-27050	
		Air Filter Set..... AS-5102-S		<b>ZX350LCK</b> (EXCAVATORS) ISUZU AA-6HK1XQA , 2002	
ZX350LCK-3 (EXCAVATORS) ISUZU AH 6HK1 XYS/A/50001 , 2006		<b>ZX330LC</b> (EXCAVATORS) ISUZU 6HK1		Air Filter Primary..... AS-5102	
Air Filter Primary..... AS-5102		Cabin Air Filter..... CA-27040		Air Filter Set..... AS-5102-S	
Air Filter Set..... AS-5102-S		<b>ZX350</b> (EXCAVATORS) ISUZU ISUZU , 2005		<b>ZX350LCK</b> (EXCAVATORS) ISUZU AA-6HK1	
Cabin Air Filter..... CA-27020		Air Filter Primary..... AS-5102		Cabin Air Filter..... CA-27040	
Cabin Air Filter..... CA-27021		Air Filter Set..... AS-5102-S		<b>ZX350LCK</b> (EXCAVATORS) W/ISUZU AA-6HK1 ENG.	
		<b>ZX350</b> (EXCAVATORS) ISUZU , 2005		Cabin Air Filter..... CA-27050	
ZX350LCK-3 (EXCAVATORS) ISUZU AH-6HK1X		Air Filter Primary..... AS-5102		<b>ZX370</b> (EXCAVATORS) ISUZU AA-6HK1XQA , 2002	
Cabin Air Filter..... CA-27030		Air Filter Secondary..... A-8651		Air Filter Primary..... AS-5102	
ZX350LCK-3 (EXCAVATORS) ISUZU 6HK1		Air Filter Set..... AS-5102-S		Air Filter Set..... AS-5102-S	
Hydraulic Oil Filter..... H-27360		Fuel Filter..... FC-1005		<b>ZX370</b> (EXCAVATORS) ISUZU 6HK1X	
		Fuel Filter..... FC-2703		Cabin Air Filter..... CA-27040	
ZX350LCN-3 (EXCAVATORS) ISUZU AH 6HK1 XYS/A/50001 , 2006		Hydraulic Oil Filter..... H-2703		<b>ZX370</b> (EXCAVATORS) ISUZU AA-6HK1X	
Air Filter Primary..... AS-5102		Hydraulic Oil Filter Return..... H-7981		Cabin Air Filter..... CA-27040	
Air Filter Set..... AS-5102-S		Hydraulic Oil Filter Suction..... H-2706		<b>ZX370</b> (EXCAVATORS) W/ISUZU AA-6HK1X ENG.	
Cabin Air Filter..... CA-27020		<b>ZX350H</b> (EXCAVATORS) ISUZU AA-6HK1XQA , 2002		Cabin Air Filter..... CA-27040	
Cabin Air Filter..... CA-27021		Air Filter Primary..... AS-5102		<b>ZX370</b> (EXCAVATORS) ISUZU AA-6HK1XQA , 2002	
		Air Filter Set..... AS-5102-S		Air Filter Primary..... AS-5102	
ZX350LCN-3 (EXCAVATORS) ISUZU 6HK1		<b>ZX350H</b> (EXCAVATORS) ISUZU AA-6HK1		Air Filter Set..... AS-5102-S	
Hydraulic Oil Filter..... H-27360		Cabin Air Filter..... CA-27040		<b>ZX370MTH</b> (EXCAVATORS) ISUZU AA-6HK1XQA , 2002	
ZX350LCN-3 (EXCAVATORS) ISUZU 6WG1		<b>ZX350H</b> (EXCAVATORS) W/ISUZU AA-6HK1 ENG.		Air Filter Primary..... AS-5102	
Cabin Air Filter..... CA-27030		Cabin Air Filter..... CA-27050		Air Filter Set..... AS-5102-S	
Hydraulic Oil Filter..... H-27360		<b>ZX350K</b> (EXCAVATORS) ISUZU AA-6HK1XQA , 2002		<b>ZX370MTH</b> (EXCAVATORS) ISUZU 6HK1X	
ZX350N-3 (EXCAVATORS) ISUZU AH 6HK1 XYS/A/50001 , 2006		Air Filter Primary..... AS-5102		Cabin Air Filter..... CA-27040	
Air Filter Primary..... AS-5102		Air Filter Set..... AS-5102-S		<b>ZX370MTH</b> (EXCAVATORS) ISUZU AA-6HK1X	
Air Filter Set..... AS-5102-S		<b>ZX350K</b> (EXCAVATORS) ISUZU AA-6HK1		Cabin Air Filter..... CA-27040	
Cabin Air Filter..... CA-27020		Cabin Air Filter..... CA-27040		<b>ZX370MTH</b> (EXCAVATORS) W/ISUZU AA-6HK1X ENG.	
Cabin Air Filter..... CA-27021		<b>ZX350K</b> (EXCAVATORS) W/ISUZU AA-6HK1 ENG.		Cabin Air Filter..... CA-27050	
		Cabin Air Filter..... CA-27050		<b>ZX30</b> (EXCAVATORS) KUBOTA V1505	
ZX350N-3 (EXCAVATORS) ISUZU AH 6HK1 XYS/A (S/N: 050001-UP) , 2006		<b>ZX350LC-3</b> (EXCAVATORS) ISUZU ISUZU TIER 3 , 2007		Air Filter Primary..... A-8513	
Air Filter Primary..... AS-5102		Air Filter Primary..... AS-5102		Fuel Filter..... F-5207	
Air Filter Secondary..... A-8651		Air Filter Set..... AS-5102-S		Hydraulic Oil Filter..... H-2712	
Air Filter Set..... AS-5102-S		<b>ZX350LC-3</b> (EXCAVATORS) ISUZU AH-6HK1X		<b>ZX30U</b> (EXCAVATORS) ISUZU 3LD2 (S/N: 05001-UP)	

MODEL/APPLICATION	SAKURA NO	MODEL/APPLICATION	SAKURA NO	MODEL/APPLICATION	SAKURA NO
<b>HITACHI</b>		<b>HITACHI</b>		<b>HITACHI</b>	
<b>ZX30U</b> (EXCAVATORS) ISUZU 3LD2 (S/N: 05001-UP)		<b>ZX470H-3</b> (EXCAVATORS) ISUZU AH-6WG1X		Air Filter Primary.....	A-5629
Air Filter Primary.....	A-8513	Cabin Air Filter.....	CA-27030	Air Filter Secondary.....	A-5630
Air Filter Secondary.....	A-5569	Fuel Filter Primary.....	EF-2701	Air Filter Set.....	A-5629-S
Fuel Filter.....	F-5207			Hydraulic Oil Filter.....	HC-7901
Hydraulic Oil Filter.....	H-2712	<b>ZX470LCH-3</b> (EXCAVATORS) ISUZU AH 6WG1 XYS A-01/20001 , 2008		<b>ZX480MT</b> (EXCAVATORS) ISUZU 6WG1T	
<b>ZX30U-2</b> (EXCAVATORS) YANMAR 3TNV88 (S/N: 010001-UP) , 2006		Cabin Air Filter.....	CA-27020	Cabin Air Filter.....	CA-27050
Air Filter Primary.....	A-8513	Cabin Air Filter.....	CA-27021	<b>ZX480MTH</b> (EXCAVATORS) ISUZU 6WG1T	
Air Filter Secondary.....	A-5569			Cabin Air Filter.....	CA-27050
Hydraulic Oil Filter.....	H-2712	<b>ZX470LCH-3</b> (EXCAVATORS) ISUZU AH 6WG1 XYS A-01 (S/N: 020001-UP) , 2008		<b>ZX500LC-3</b> (EXCAVATORS) ISUZU AH 6WG1 XYS A-01/20001 , 2006	
<b>ZX35</b> (EXCAVATORS) KUBOTA V1505		Air Filter Primary.....	A-5629	Cabin Air Filter.....	CA-27020
Air Filter Primary.....	A-8513	Air Filter Secondary.....	A-5630	Cabin Air Filter.....	CA-27021
Fuel Filter.....	F-5207	Air Filter Set.....	A-5629-S	<b>ZX500LC-3</b> (EXCAVATORS) ISUZU AH 6WG1 XYS A-01 (S/N: 020001-UP) , 2006	
Hydraulic Oil Filter.....	H-2712	Hydraulic Oil Filter.....	HC-7901	Air Filter Primary.....	A-5629
<b>ZX35U-2</b> (EXCAVATORS) YANMAR 3TNV88 (S/N: 010001-UP)		<b>ZX470LCH-3</b> (EXCAVATORS) ISUZU AH-6WG1X		Air Filter Secondary.....	A-5630
Air Filter Primary.....	A-8513	Cabin Air Filter.....	CA-27030	Air Filter Set.....	A-5629-S
Air Filter Secondary.....	A-5569	Fuel Filter Primary.....	EF-2701	Hydraulic Oil Filter.....	HC-7901
Hydraulic Oil Filter.....	H-2712	<b>ZX40</b> (EXCAVATORS) KUBOTA V2203		<b>ZX500LC-3</b> (EXCAVATORS) ISUZU AH-6WG1X	
<b>ZX350L</b> (EXCAVATORS) ISUZU 6HK1		Air Filter Primary.....	A-8513	Cabin Air Filter.....	CA-27030
Cabin Air Filter.....	CA-27050	Fuel Filter.....	F-5210	Fuel Filter Primary.....	EF-2701
<b>ZX350LCN</b> (EXCAVATORS) ISUZU 6HK1		Hydraulic Oil Filter.....	H-2712	<b>ZX520LCH-3</b> (EXCAVATORS) ISUZU AH 6WG1 XYS A-01/20001 , 2006	
Hydraulic Oil Filter Return.....	H-27390	<b>ZX40U</b> (EXCAVATORS) ISUZU 4LE2 (S/N: 1LD-005001-UP)		Cabin Air Filter.....	CA-27020
<b>ZX350LCN</b> (EXCAVATORS) W/ISUZU AA-6HK1 ENG.		Air Filter Primary.....	A-8513	Cabin Air Filter.....	CA-27021
Cabin Air Filter.....	CA-27050	Air Filter Secondary.....	A-5569	<b>ZX520LCH-3</b> (EXCAVATORS) ISUZU AH 6WG1 XYS A-01 (S/N: 020001-UP) , 2006	
<b>ZX450-3</b> (EXCAVATORS) ISUZU AH 6WG1 XYS A-01/20001 , 2006		Fuel Filter.....	F-5207	Air Filter Primary.....	A-5629
Cabin Air Filter.....	CA-27020	Hydraulic Oil Filter.....	H-2712	Air Filter Secondary.....	A-5630
Cabin Air Filter.....	CA-27021	<b>ZX40U-2</b> (EXCAVATORS) YANMAR 4TNV88 (S/N: 010001-UP) , 2006		Air Filter Set.....	A-5629-S
<b>ZX450-3</b> (EXCAVATORS) ISUZU AH 6WG1 XYS A-01 (S/N: 020001-UP) , 2006		Air Filter Primary.....	A-8513	Hydraulic Oil Filter.....	HC-7901
Air Filter Primary.....	A-5629	Air Filter Secondary.....	A-5569	<b>ZX50</b> (EXCAVATORS) KUBOTA V2203	
Air Filter Secondary.....	A-5630	Hydraulic Oil Filter.....	H-2712	Air Filter Primary.....	A-8513
Air Filter Set.....	A-5629-S	<b>ZX450</b> (EXCAVATORS) ISUZU 6WG1TQA		Fuel Filter.....	F-5210
Hydraulic Oil Filter.....	HC-7901	Air Filter Primary.....	AS-8579	Hydraulic Oil Filter.....	H-2712
<b>ZX450-3</b> (EXCAVATORS) ISUZU AH-6WG1X		Air Filter Primary.....	AS-8579M	<b>ZX500</b> (EXCAVATORS)	
Cabin Air Filter.....	CA-27030	Air Filter Secondary.....	A-8580	Air Filter Primary.....	AS-8579
<b>ZX450LC-3</b> (EXCAVATORS) ISUZU AH 6WG1 XYS A-01/20001 , 2006		Air Filter Set.....	AS-8579-S	Air Filter Primary.....	AS-8579M
Cabin Air Filter.....	CA-27020	Fuel Filter.....	FC-1005	Air Filter Secondary.....	A-8580
Cabin Air Filter.....	CA-27021	Fuel Filter.....	FC-2703	Air Filter Set.....	AS-8579-S
<b>ZX450LC-3</b> (EXCAVATORS) ISUZU AH-6WG1X		Hydraulic Oil Filter.....	H-2703	Fuel Filter.....	FC-1005
Cabin Air Filter.....	CA-27030	Hydraulic Oil Filter.....	H-2709	Fuel Filter.....	FC-2703
<b>ZX470H-3</b> (EXCAVATORS) ISUZU AH 6WG1 XYS A-01/20001 , 2008		Hydraulic Oil Filter.....	HC-7901	Hydraulic Oil Filter.....	H-2703
Cabin Air Filter.....	CA-27020	<b>ZX450</b> (EXCAVATORS) ISUZU 6WG1T		Hydraulic Oil Filter.....	H-2709
Cabin Air Filter.....	CA-27021	Cabin Air Filter.....	CA-27040	Hydraulic Oil Filter.....	HC-7901
<b>ZX460LCH</b> (EXCAVATORS) ISUZU 6WG1T		<b>ZX450LC</b> (EXCAVATORS) ISUZU 6WG1T		<b>ZX50U</b> (EXCAVATORS) ISUZU 4LE2 (S/N: 1LE-005001-UP)	
Cabin Air Filter.....	CA-27050	Cabin Air Filter.....	CA-27040	Air Filter Primary.....	A-8513
<b>ZX470-3</b> (EXCAVATORS)		<b>ZX460LCH</b> (EXCAVATORS) ISUZU 6WG1T		Air Filter Secondary.....	A-5569
Cabin Air Filter.....	CA-27021	Cabin Air Filter.....	CA-27050	Fuel Filter.....	F-5207
		<b>ZX470-3</b> (EXCAVATORS)		Hydraulic Oil Filter.....	H-2712

MODEL/APPLICATION	SAKURA NO	MODEL/APPLICATION	SAKURA NO	MODEL/APPLICATION	SAKURA NO
<b>HITACHI</b>		<b>HITACHI</b>		<b>HITACHI</b>	
<b>ZX50U-2</b> (EXCAVATORS) YANMAR 4TNV88 (S/N: 010001-UP) , 2006		Hydraulic Oil Filter.....	HC-7901	Oil Filter Full Flow.....	C-1511
Air Filter Primary.....	A-8513	<b>ZX650</b> (EXCAVATORS)		Oil Filter Full Flow.....	C-1538
Air Filter Secondary.....	A-5569	Air Filter Primary.....	AS-8579	<b>ZX70LC</b> (EXCAVATORS) ISUZU AA-4JG1	
Hydraulic Oil Filter.....	H-2712	Air Filter Primary.....	AS-8579M	Air Filter Primary.....	A-8505
<b>ZX520-3</b> (EXCAVATORS)		Air Filter Secondary.....	A-8580	Air Filter Secondary.....	A-8599
Air Filter Primary.....	A-5629	Air Filter Set.....	AS-8579-S	Cabin Air Filter.....	CA-27040
Air Filter Secondary.....	A-5630	Fuel Filter.....	FC-1005	Fuel Filter.....	FC-1005
Air Filter Set.....	A-5629-S	Fuel Filter.....	FC-2703	Fuel Filter.....	FC-1801
Hydraulic Oil Filter.....	HC-7901	Hydraulic Oil Filter.....	H-2703	Hydraulic Oil Filter.....	H-2703
<b>ZX520LC-3</b> (EXCAVATORS) ISUZU AH-6WG1X		Hydraulic Oil Filter.....	H-2709	Oil Filter Full Flow.....	C-1511
Cabin Air Filter.....	CA-27030	Hydraulic Oil Filter.....	HC-7901	Oil Filter Full Flow.....	C-1538
Fuel Filter Primary.....	EF-2701	<b>ZX650-3</b> (EXCAVATORS) ISUZU 6WG1X		<b>ZX75UR</b> (EXCAVATORS) ISUZU 4JG1	
<b>ZX500LC</b> (EXCAVATORS) ISUZU 6WG1T		Cabin Air Filter.....	CA-27030	Fuel Filter.....	FC-1824
Cabin Air Filter.....	CA-27040	Fuel Filter Primary.....	EF-2701	<b>ZX75UR</b> (EXCAVATORS) ISUZU CC-4JG1 (S/N: 040001-UP)	
<b>ZX650LC-3</b> (EXCAVATORS) ISUZU AH 6WG1 XYS A-02/20001 , 2006		<b>ZX650H</b> (EXCAVATORS) ISUZU 6WG1 XQA01		Air Filter Primary.....	A-8505
Cabin Air Filter.....	CA-27020	Air Filter Primary.....	AS-8579	Air Filter Secondary.....	A-8599
Cabin Air Filter.....	CA-27021	Air Filter Primary.....	AS-8579M	Fuel Filter.....	FC-1801
<b>ZX650LC-3</b> (EXCAVATORS) ISUZU AH 6WG1 XYS A-02 (S/N: 020001-UP) , 2006		Air Filter Secondary.....	A-8580	Hydraulic Oil Filter.....	H-2703
Air Filter Primary.....	A-5629	Air Filter Set.....	AS-8579-S	Oil Filter Full Flow.....	C-1511
Air Filter Secondary.....	A-5630	Fuel Filter.....	FC-2703	Oil Filter Full Flow.....	C-1538
Air Filter Set.....	A-5629-S	Hydraulic Oil Filter.....	H-2703	<b>ZX75US</b> (EXCAVATORS) 2008	
Hydraulic Oil Filter.....	HC-7901	Hydraulic Oil Filter.....	H-2709	Air Filter Primary.....	A-8505
<b>ZX650LC-3</b> (EXCAVATORS) ISUZU 6WG1X		Hydraulic Oil Filter.....	HC-7901	Air Filter Secondary.....	A-8599
Cabin Air Filter.....	CA-27030	<b>ZX650LCH</b> (EXCAVATORS) ISUZU BB6WG , 2001		Fuel Filter.....	FC-1005
Fuel Filter Primary.....	EF-2701	Air Filter Primary.....	AS-8579	Fuel Filter.....	FC-1801
<b>ZX670LCH-3</b> (EXCAVATORS) ISUZU AH 6WG1 XYS A-02/20001 , 2006		Air Filter Primary.....	AS-8579M	Hydraulic Oil Filter.....	H-2703
Cabin Air Filter.....	CA-27020	Air Filter Secondary.....	A-8580	Oil Filter Full Flow.....	C-1511
Cabin Air Filter.....	CA-27021	Air Filter Set.....	AS-8579-S	Oil Filter Full Flow.....	C-1538
<b>ZX670LCH-3</b> (EXCAVATORS) ISUZU AH 6WG1 XYS A-02 (S/N: 020001-UP) , 2006		Fuel Filter.....	FC-2703	<b>ZX75US</b> (EXCAVATORS) ISUZU 4JG1	
Air Filter Primary.....	A-5629	Hydraulic Oil Filter.....	H-2703	Air Filter Primary.....	A-8505
Air Filter Secondary.....	A-5630	Hydraulic Oil Filter.....	H-2709	Air Filter Secondary.....	A-8599
Air Filter Set.....	A-5629-S	<b>ZX670-3</b> (EXCAVATORS)		Cabin Air Filter.....	CA-27040
Hydraulic Oil Filter.....	HC-7901	Hydraulic Oil Filter.....	H-2703	Fuel Filter.....	FC-1801
<b>ZX670LCH-3</b> (EXCAVATORS) ISUZU 6WG1X		Hydraulic Oil Filter.....	H-2709	Hydraulic Oil Filter.....	H-2703
Cabin Air Filter.....	CA-27030	<b>ZX60-5G</b> (EXCAVATORS) 4TNV98-07559		Oil Filter Full Flow.....	C-1511
Fuel Filter Primary.....	EF-2701	Air Filter Primary.....	AS-27170	Oil Filter Full Flow.....	C-1538
<b>ZX600</b> (EXCAVATORS) ISUZU 6WG1		Air Filter Set.....	AS-27170-S	<b>ZX850LC-3</b> (EXCAVATORS) ISUZU AH 6WG1 XYS A-03/20001 , 2006	
Air Filter Primary.....	AS-8579	Hydraulic Oil Filter.....	HC-7901	Air Filter Primary.....	AS-5102
Air Filter Primary.....	AS-8579M	<b>ZX65USB-5A</b> (EXCAVATORS) 4TNV94L-ZWHB , 3000, 2015		Air Filter Set.....	AS-5102-S
Air Filter Secondary.....	A-8580	Air Filter Secondary.....	A-27180	Cabin Air Filter.....	CA-27020
Air Filter Set.....	AS-8579-S	<b>ZX70</b> (EXCAVATORS) ISUZU AA-4JG1		Cabin Air Filter.....	CA-27021
Fuel Filter.....	FC-1005	Cabin Air Filter.....	CA-27040	<b>ZX850LC-3</b> (EXCAVATORS) ISUZU AH 6WG1 XYS A-03 (S/N: 020001-UP) , 2006	
Fuel Filter.....	FC-2703	<b>ZX70</b> (EXCAVATORS)		Air Filter Primary.....	AS-5102
Hydraulic Oil Filter.....	H-2703	Air Filter Primary.....	A-8505	Air Filter Secondary.....	A-8651
Hydraulic Oil Filter.....	H-2709	Air Filter Secondary.....	A-8599	Air Filter Set.....	AS-5102-S
<b>ZX670LCH-3</b> (EXCAVATORS) ISUZU 6WG1X		Fuel Filter.....	FC-1801	Hydraulic Oil Filter.....	HC-7901
Cabin Air Filter.....	CA-27030	Hydraulic Oil Filter.....	H-2703	<b>ZX850LC-3</b> (EXCAVATORS) ISUZU 6WG1	
Fuel Filter Primary.....	EF-2701	<b>ZX750LC-3</b> (EXCAVATORS) ISUZU 6WG1		Fuel Filter Primary.....	EF-27040

MODEL/APPLICATION	SAKURA NO	MODEL/APPLICATION	SAKURA NO
<b>HITACHI</b>		<b>HITACHI</b>	
<b>ZX850LC-3</b> (EXCAVATORS) ISUZU 6WG1X Cabin Air Filter..... CA-27030		<b>ZX85US</b> (EXCAVATORS) ISUZU 4JG1 Air Filter Primary..... A-8505 Air Filter Secondary..... A-8599 Cabin Air Filter..... CA-27040 Fuel Filter..... FC-1005 Fuel Filter..... FC-1801 Hydraulic Oil Filter..... H-2703 Oil Filter Full Flow..... C-1511 Oil Filter Full Flow..... C-1538	
<b>ZX870LCH-3</b> (EXCAVATORS) ISUZU AH 6WG1 XYS-A-03/20001 , 2006 Air Filter Primary..... AS-5102 Air Filter Set..... AS-5102-S Cabin Air Filter..... CA-27020 Cabin Air Filter..... CA-27021		<b>ZX870-3</b> (EXCAVATORS) 2006 Air Filter Primary..... AS-5102 Air Filter Secondary..... A-8651 Air Filter Set..... AS-5102-S Hydraulic Oil Filter..... HC-7901	
<b>ZX870LCH-3</b> (EXCAVATORS) ISUZU AH 6WG1 XYS-A-03 (S/N: 020001-UP) , 2006 Air Filter Primary..... AS-5102 Air Filter Secondary..... A-8651 Air Filter Set..... AS-5102-S Hydraulic Oil Filter..... HC-7901		<b>ZX870H-3</b> (EXCAVATORS) ISUZU 6WG1X Cabin Air Filter..... CA-27030 Fuel Filter Primary..... EF-2701	
<b>ZX870LCH-3</b> (EXCAVATORS) ISUZU 6WG1X Cabin Air Filter..... CA-27030 Fuel Filter Primary..... EF-2701		<b>ZX85USB-5A</b> (EXCAVATORS) 4TNV94L , 3000, 2015 Air Filter Secondary..... A-27180	
<b>ZX80</b> (EXCAVATORS) ISUZU AA-4JG1 Air Filter Primary..... A-8505 Air Filter Secondary..... A-8599 Fuel Filter..... FC-1005 Fuel Filter..... FC-1801 Hydraulic Oil Filter..... H-2703 Oil Filter Full Flow..... C-1511 Oil Filter Full Flow..... C-1538		<b>ZX850-3</b> (EXCAVATORS) ISUZU 6WG1X Cabin Air Filter..... CA-27030	
<b>ZX80</b> (EXCAVATORS) ISUZU CC-4JG1 Cabin Air Filter..... CA-27040		<b>ZZ270LC</b> (EXCAVATORS) ISUZU 6BG1 Fuel Filter..... FC-15031	
<b>ZX805B</b> (EXCAVATORS) ISUZU AA-4JG1 Air Filter Primary..... A-8505 Air Filter Secondary..... A-8599 Fuel Filter..... FC-1005 Fuel Filter..... FC-1801 Hydraulic Oil Filter..... H-2703 Oil Filter Full Flow..... C-1511 Oil Filter Full Flow..... C-1538			
<b>ZX8-2</b> (EXCAVATORS) YANMAR 3TNV70 , 2008 Hydraulic Oil Filter..... H-2712			
<b>ZX850</b> (EXCAVATORS) ISUZU 6WG1 Air Filter Primary..... A-5629 Air Filter Secondary..... A-5630 Air Filter Set..... A-5629-S Cabin Air Filter..... CA-27040 Fuel Filter..... FC-1005 Fuel Filter..... FC-2703 Hydraulic Oil Filter..... H-2703 Hydraulic Oil Filter..... HC-7901			
<b>ZX850H</b> (EXCAVATORS) Air Filter Secondary..... A-5630 Fuel Filter..... FC-2703			



# Technical Specification

**B**



# Sakura Filter

# Technical Specification

**A-1013** Air Filter Primary Metal End Cap Element



ISUZU 1-14214126-0  
ISUZU 1-14215-181-0  
ISUZU 1-86750-309-0  
NISSAN 16546-96071  
NISSAN 16546-99218

Secondary Filter uses A-5631  
Set Filter uses A-1841-S  
H 1 : 394.7 (mm)  
H 2 : 382 (mm)  
OD 1 : 276 (mm)  
OD 2 : 275 (mm)  
ID 1 : 165 (mm)  
ID 2 : 23 (mm)

CONT : 4  
VOL : 0.154

Note : Is a Primary Air Filter for A-5631,A-7607

**A-1841-S** Air Filter Set Metal End Cap Element



NISSAN 16546-96070  
HITACHI 4288963+4288964  
KOMATSU 600-181-1600

Primary Filter uses A-1013  
Secondary Filter uses A-5631  
H 1 : 395 (mm)  
H 2 : 382 (mm)  
OD 1 : 276 (mm)  
OD 2 : 276 (mm)  
ID 1 : 165 (mm)  
ID 2 : 23 (mm)

CONT : 4  
VOL : 0.163

**A-2703-S** Air Filter Set Metal End Cap Element



HITACHI 4206099+4247975

Primary Filter uses A-2703  
Secondary Filter uses A-2704  
H 1 : 317.7 (mm)  
H 2 : 305 (mm)  
OD 1 : 155 (mm)  
OD 2 : 155 (mm)  
ID 1 : 104 (mm)  
ID 2 : 17 (mm)

CONT : 12  
VOL : 0.144

**A-10134** Air Filter Primary Metal End Cap Element



MITSUBISHI ME 063130

H 1 : 394.7 (mm)  
H 2 : 382 (mm)  
OD 1 : 276 (mm)  
OD 2 : 275 (mm)  
ID 1 : 165 (mm)  
ID 2 : 23 (mm)

CONT : 1  
VOL : 0.035

Note : Flame retardant version from A-1013

**A-2210** Air Filter Primary Metal End Cap Element



FIAT 0068473-3  
ISUZU 1-14215-018-0  
ISUZU 1-14215007-0  
NISSAN 16546-96011

Secondary Filter uses A-6008  
Set Filter uses A-6117-S  
H 1 : 342.7 (mm)  
H 2 : 330 (mm)  
OD 1 : 234 (mm)  
OD 2 : 234 (mm)  
ID 1 : 123 (mm)  
ID 2 : 17 (mm)

CONT : 4  
VOL : 0.093

**A-2704** Air Filter Secondary Metal End Cap Element



HITACHI 4247975

Primary Filter uses A-2702  
H 1 : 294.7 (mm)  
H 2 : 285 (mm)  
OD 1 : 100.5 (mm)  
OD 2 : 100.5 (mm)  
ID 1 : 81 (mm)  
ID 2 : 17 (mm)

CONT : 25  
VOL : 0.099

Note : Is a Secondary Air filter for A-2704,A-2702

**A-1307** Air Filter Secondary Metal End Cap Element



ISUZU 1-14215085-0  
HINO 17801-2460  
CATERPILLAR 3I-0179

Primary Filter uses A-1313  
Set Filter uses A-5662-S  
H 1 : 444.7 (mm)  
H 2 : 432 (mm)  
OD 1 : 145 (mm)  
OD 2 : 145 (mm)  
ID 1 : 116.5 (mm)  
ID 2 : 23 (mm)

CONT : 9  
VOL : 0.106

**A-2702** Air Filter Primary Metal End Cap Element



HITACHI 4285623

Secondary Filter uses A-2704  
Set Filter uses A-2702-S  
H 1 : 327.2 (mm)  
H 2 : 317.7 (mm)  
OD 1 : 200 (mm)  
OD 2 : 155 (mm)  
ID 1 : 104 (mm)  
ID 2 : 17 (mm)

CONT : 9  
VOL : 0.159

**A-2705** Air Filter Secondary Soft PU end cap Element



HITACHI 4287060  
KOBELCO YN02P000013B

Primary Filter uses A-2706  
Set Filter uses A-2707-S  
H 1 : 353 (mm)  
H 2 : 347 (mm)  
OD 1 : 124 (mm)  
OD 2 : 117 (mm)  
ID 1 : 104 (mm)

CONT : 25  
VOL : 0.178

**A-13092-S** Air Filter Set Metal End Cap Element



HINO 17801-2490+17801-3050

Primary Filter uses A-1309  
Secondary Filter uses A-13550  
H 1 : 493 (mm)  
H 2 : 480 (mm)  
OD 1 : 307 (mm)  
OD 2 : 307 (mm)  
ID 1 : 196 (mm)  
ID 2 : 23 (mm)

CONT : 1  
VOL : 0.054

**A-2702-S** Air Filter Set Metal End Cap Element



HITACHI 4285623+4247975

Primary Filter uses A-2702  
Secondary Filter uses A-2704  
H 1 : 327.2 (mm)  
H 2 : 317.5 (mm)  
OD 1 : 200 (mm)  
OD 2 : 155 (mm)  
ID 1 : 104 (mm)  
ID 2 : 17 (mm)

CONT : 9  
VOL : 0.159

**A-2706** Air Filter Primary Soft PU end cap Element



HITACHI 4283861  
KOBELCO YN02P000013A

Secondary Filter uses A-2705  
Set Filter uses A-2707-S  
H 1 : 367.5 (mm)  
H 2 : 355.5 (mm)  
OD 1 : 207 (mm)  
OD 2 : 208 (mm)  
ID 1 : 123 (mm)

CONT : 9  
VOL : 0.175

**A-1313** Air Filter Primary Metal End Cap Element



CATERPILLAR 099-5801  
ISUZU 1-14215084-0  
HINO 17720-3640  
HINO 17801-2530

Secondary Filter uses A-1307  
Set Filter uses A-5662-S  
H 1 : 469.75 (mm)  
H 2 : 457 (mm)  
OD 1 : 232 (mm)  
OD 2 : 232 (mm)  
ID 1 : 147 (mm)  
ID 2 : 23 (mm)

CONT : 4  
VOL : 0.123

**A-2703** Air Filter Primary Metal End Cap Element



HITACHI 4206099

Secondary Filter uses A-2704  
Set Filter uses A-2703-S  
H 1 : 317.7 (mm)  
H 2 : 305 (mm)  
OD 1 : 155 (mm)  
OD 2 : 155 (mm)  
ID 1 : 104 (mm)  
ID 2 : 17 (mm)

CONT : 12  
VOL : 0.144

**A-2708** Air Filter Primary Metal End Cap Element



HITACHI 4206098  
HITACHI 4285619  
HITACHI 4484532

Secondary Filter uses A-7956  
Set Filter uses A-2711-S  
H 1 : 275.7 (mm)  
H 2 : 263 (mm)  
OD 1 : 201.5 (mm)  
OD 2 : 252 (mm)  
ID 1 : 135.5 (mm)  
ID 2 : 22 (mm)

CONT : 1  
VOL : 0.022

# Sakura Filter

# Technical Specification

**A-2709-S** Air Filter Set Soft PU end cap Element  
HITACHI 4286128+4286130

Primary Filter uses A-5539  
Secondary Filter uses A-5538  
H 1 : 370 (mm)  
H 2 : 357 (mm)  
OD 1 : 237 (mm)  
OD 2 : 237 (mm)  
ID 1 : 132 (mm)

CONT : 4  
VOL : 0.107

Note : with metal reinforcement version A-2709M-S

**A-28710** Air Filter Primary Metal End Cap Element  
HYUNDAI 11N8-22140



Secondary Filter uses A-28720  
Set Filter uses A-28730-S  
H 1 : 502.75 (mm)  
H 2 : 490 (mm)  
OD 1 : 276 (mm)  
OD 2 : 275 (mm)  
ID 1 : 165 (mm)  
ID 2 : 19 (mm)

CONT : 1  
VOL : 0.047

**A-5539** Air Filter Primary Soft PU end cap Element  
HITACHI 4286128  
ISUZU 8-98071421-0



Secondary Filter uses A-5538  
Set Filter uses A-2709-S  
H 1 : 370 (mm)  
H 2 : 357 (mm)  
OD 1 : 237 (mm)  
OD 2 : 237 (mm)  
ID 1 : 132 (mm)

CONT : 1  
VOL : 0.024

Note : A-5539M (Reinforcement Difference)

**A-2709M-S** Air Filter Set Soft PU+Metal Element  
HITACHI 4286128+4286130



Primary Filter uses A-5539M  
Secondary Filter uses A-5538  
H 1 : 370 (mm)  
H 2 : 357 (mm)  
OD 1 : 237 (mm)  
OD 2 : 237 (mm)  
ID 1 : 130 (mm)

CONT : 4  
VOL : 0.107

Note : Soft Pu only uses A-2709-S

**A-28730-S** Air Filter Set Metal End Cap Element  
HYUNDAI 11N8-22140+11N8-22150



Primary Filter uses A-28710  
Secondary Filter uses A-28720  
H 1 : 502.75 (mm)  
H 2 : 490 (mm)  
OD 1 : 276 (mm)  
OD 2 : 275 (mm)  
ID 1 : 134 (mm)  
ID 2 : 19 (mm)

CONT : 1  
VOL : 0.047

**A-5539M** Air Filter Primary Soft PU+Metal Element with metal reinforcement  
HITACHI 4286128  
ISUZU 8-98071421-0



Secondary Filter uses A-5538  
Set Filter uses A-2709M-S  
H 1 : 370 (mm)  
H 2 : 357 (mm)  
OD 1 : 237 (mm)  
OD 2 : 237 (mm)  
ID 1 : 132 (mm)

CONT : 1  
VOL : 0.024

**A-2711-S** Air Filter Set Metal End Cap Element  
HITACHI 4206098+4247974



Primary Filter uses A-2708  
Secondary Filter uses A-7956  
H 1 : 275.7 (mm)  
H 2 : 263 (mm)  
OD 1 : 201.5 (mm)  
OD 2 : 252 (mm)  
ID 1 : 135.5 (mm)  
ID 2 : 22 (mm)

CONT : 1  
VOL : 0.021

**A-5301** Air Filter Primary Metal End Cap Element  
ATLAS COPCO 1619-27-98-00  
DEUTZ 2165041  
DEUTZ 2165054



Secondary Filter uses A-6210  
Set Filter uses A-5301-S  
H 1 : 383.7 (mm)  
H 2 : 371 (mm)  
OD 1 : 228 (mm)  
OD 2 : 228 (mm)  
ID 1 : 117 (mm)  
ID 2 : 11 (mm)

CONT : 1  
VOL : 0.023

**A-5540** Air Filter Secondary Soft PU end cap Element  
YANMAR 119117-12570  
CATERPILLAR 1318903  
PERKINS 26510343  
YANMAR Y119117-12570



Primary Filter uses A-5541  
Set Filter uses A-5541-S  
H 1 : 346 (mm)  
H 2 : 340 (mm)  
OD 1 : 92 (mm)  
OD 2 : 86.5 (mm)  
ID 1 : 72.5 (mm)

CONT : 25  
VOL : 0.105

**A-2715** Air Filter Metal framed Element  
HITACHI 4206637  
HITACHI 4S01130  
JOHN DEERE AT116077



H 1 : 55.6 (mm)  
Length 1 : 435 (mm)  
Width 1 : 215 (mm)

CONT : 1  
VOL : 0.009

**A-5408** Air Filter Secondary Metal End Cap Element  
ISUZU 1-14215034-0  
ISUZU 1-14215036-0  
NISSAN 16546-96014



Primary Filter uses A-6113  
Set Filter uses A-5653-S  
H 1 : 406 (mm)  
OD 1 : 192.3 (mm)  
OD 2 : 162.5 (mm)  
ID 1 : 134.2 (mm)  
ID 2 : 17 (mm)

CONT : 9  
VOL : 0.167

Note : Is a Secondary Air filter for A-6113,A-54490

**A-5541** Air Filter Primary Soft PU end cap Element  
YANMAR 119117-12560  
CATERPILLAR 131-8902  
PERKINS 26510342  
HITACHI 4486002



Secondary Filter uses A-5540  
Set Filter uses A-5541-S  
H 1 : 356 (mm)  
H 2 : 347 (mm)  
OD 1 : 163.5 (mm)  
OD 2 : 163.5 (mm)  
ID 1 : 91 (mm)

CONT : 9  
VOL : 0.108

**A-27180** Air Filter Secondary Plastic Element  
IHI 074526509  
YANMAR 172B06-11520



Primary Filter uses AS-27170  
Set Filter uses AS-27170-S  
H 1 : 272 (mm)  
OD 1 : 72.4 (mm)  
OD 2 : 71 (mm)  
ID 1 : 63 (mm)

CONT : 25  
VOL : 0.044

**A-5538** Air Filter Secondary Soft PU end cap Element  
HITACHI 4286130



Primary Filter uses A-5539  
Set Filter uses A-2709-S  
H 1 : 353 (mm)  
H 2 : 347 (mm)  
OD 1 : 133 (mm)  
OD 2 : 125 (mm)  
ID 1 : 110 (mm)

CONT : 9  
VOL : 0.075

Note : Is a Secondary Air filter for A-5539,A-5539M

**A-5541M** Air Filter Primary Soft PU+Metal Element  
CATERPILLAR 131-8902

















Secondary Filter uses A-5540  
Set Filter uses A-5541M-S  
H 1 : 356 (mm)  
H 2 : 347 (mm)  
OD 1 : 163.5 (mm)  
OD 2 : 163.5 (mm)  
ID 1 : 91 (mm)

CONT : 9  
VOL : 0.108

# Sakura Filter

# Technical Specification

<p><b>A-5541M-S</b> Air Filter Set Soft PU+Metal Element</p> <p>CATERPILLAR 131-8902+131-8903</p>  <p>Primary Filter uses A-5541M Secondary Filter uses A-5540 H 1 : 353 (mm) H 2 : 344 (mm) OD 1 : 163.5 (mm) OD 2 : 163.5 (mm) ID 1 : 91 (mm)</p> <p>CONT : 9 VOL : 0.116</p>	<p><b>A-5628</b> Air Filter Primary Metal End Cap Element</p> <p>CHRYSLER 3614353 KOMATSU 600-181-8240</p>  <p>Secondary Filter uses A-7611 Set Filter uses A-5628-S H 1 : 311 (mm) H 2 : 305 (mm) OD 1 : 155 (mm) OD 2 : 155 (mm) ID 1 : 88 (mm) ID 2 : 17 (mm)</p> <p>CONT : 12 VOL : 0.120</p>	<p><b>A-5631</b> Air Filter Secondary Metal End Cap Element</p> <p>ISUZU 1-14215087-0 NISSAN 16546-96072 HITACHI 4288964</p>  <p>Primary Filter uses A-1013 Set Filter uses A-1841-S H 1 : 361.75 (mm) H 2 : 349 (mm) OD 1 : 162.5 (mm) OD 2 : 163 (mm) ID 1 : 134 (mm) ID 2 : 17 (mm)</p> <p>CONT : 9 VOL : 0.110</p>
<p><b>A-5569</b> Air Filter Secondary Soft PU end cap Element</p> <p>VOLVO 11801160 CATERPILLAR 1467473 JOHN DEERE M131803 KOMATSU YM12905112530</p>  <p>Primary Filter uses A-8513 Set Filter uses A-5570-S H 1 : 265 (mm) H 2 : 259 (mm) OD 1 : 61 (mm) OD 2 : 59 (mm) ID 1 : 45 (mm)</p> <p>CONT : 25 VOL : 0.048</p>	<p><b>A-5628-S</b> Air Filter Set Metal End Cap Element</p> <p>CLAAS 3200010+3200020 BLOUNT 537986+537987 BOBCAT 6681474+6681475 JOHN DEERE AT44377+AT44378</p>  <p>Primary Filter uses A-5628 Secondary Filter uses A-7611 H 1 : 311 (mm) H 2 : 305 (mm) OD 1 : 155 (mm) OD 2 : 155 (mm) ID 1 : 88 (mm) ID 2 : 17 (mm)</p> <p>CONT : 12 VOL : 0.194</p>	<p><b>A-5662-S</b> Air Filter Set Metal End Cap Element</p> <p>KOMATSU 600-181-8600 KOMATSU 600-182-2700 KOMATSU 600-182-3200</p>  <p>Primary Filter uses A-1313 Secondary Filter uses A-1307 H 1 : 457 (mm) H 2 : 432 (mm) OD 1 : 232 (mm) OD 2 : 145 (mm) ID 1 : 147 (mm) ID 2 : 23 (mm)</p> <p>CONT : 4 VOL : 0.123</p>
<p><b>A-5610</b> Air Filter Secondary Metal End Cap Element</p> <p>NISSAN 16546-97005 CATERPILLAR 3I-0125 HITACHI 4177212</p>  <p>Primary Filter uses A-5614 Set Filter uses A-5613-S H 1 : 449 (mm) OD 1 : 214.8 (mm) OD 2 : 185 (mm) ID 1 : 157.5 (mm) ID 2 : 17 (mm)</p> <p>CONT : 4 VOL : 0.099</p> <p>Note : Is a Secondary Air filter for A-5614,A-5618</p>	<p><b>A-5629</b> Air Filter Primary Metal End Cap Element</p> <p>ISUZU 1-14125082-0 ISUZU 1-14215082-0 CATERPILLAR 3I-0202</p>  <p>Secondary Filter uses A-5630 Set Filter uses A-5629-S H 1 : 622 (mm) H 2 : 609.5 (mm) OD 1 : 307 (mm) OD 2 : 307 (mm) ID 1 : 196 (mm) ID 2 : 22.7 (mm)</p> <p>CONT : 1 VOL : 0.071</p>	<p><b>A-5663-S</b> Air Filter Set Metal End Cap Element</p> <p>KOMATSU 600-181-6050</p>  <p>Primary Filter uses A-5627 Secondary Filter uses A-6008 H 1 : 380 (mm) H 2 : 330 (mm) OD 1 : 235 (mm) OD 2 : 187 (mm) ID 1 : 120 (mm) ID 2 : 17 (mm)</p> <p>CONT : 1 VOL : 0.030</p>
<p><b>A-5614</b> Air Filter Primary Metal End Cap Element</p> <p>CATERPILLAR 3I-0374 KOMATSU 600-181-4400 KOMATSU 600-181-4400P</p>  <p>Secondary Filter uses A-5610 Set Filter uses A-5613-S H 1 : 469.75 (mm) H 2 : 457 (mm) OD 1 : 307 (mm) OD 2 : 377 (mm) ID 1 : 196 (mm) ID 2 : 24 (mm)</p> <p>CONT : 1 VOL : 0.073</p>	<p><b>A-5629-S</b> Air Filter Set Metal End Cap Element</p> <p>HITACHI 4240294+4240295 KOMATSU 561-02-12330+561-02-12320</p>  <p>Primary Filter uses A-5629 Secondary Filter uses A-5630 H 1 : 622 (mm) H 2 : 609.5 (mm) OD 1 : 307 (mm) OD 2 : 307 (mm) ID 1 : 196 (mm) ID 2 : 22.7 (mm)</p> <p>CONT : 1 VOL : 0.071</p>	<p><b>A-5708</b> Air Filter Metal End Cap Element</p> <p>CUMMINS 158877</p>  <p>H 1 : 266.75 (mm) H 2 : 254 (mm) OD 1 : 234 (mm) OD 2 : 234 (mm) ID 1 : 123 (mm) ID 2 : 14 (mm)</p> <p>CONT : 4 VOL : 0.072</p>
<p><b>A-5627</b> Air Filter Primary Metal End Cap Element</p> <p>KOBELCO 2451-U311-3 DAEWOO 2474-6006A DAEWOO 2474-6006B</p>  <p>Secondary Filter uses A-6008 Set Filter uses A-5663-S H 1 : 393.7 (mm) H 2 : 381 (mm) OD 1 : 235 (mm) OD 2 : 187 (mm) ID 1 : 120 (mm) ID 2 : 17 (mm)</p> <p>CONT : 1 VOL : 0.026</p>	<p><b>A-5630</b> Air Filter Secondary Metal End Cap Element</p> <p>ISUZU 1-14215081-0 CATERPILLAR 3I-0203 HITACHI 4240295</p>  <p>Primary Filter uses A-5629 Set Filter uses A-5629-S H 1 : 596.7 (mm) H 2 : 584 (mm) OD 1 : 185 (mm) OD 2 : 185 (mm) ID 1 : 157.5 (mm) ID 2 : 17 (mm)</p> <p>CONT : 1 VOL : 0.025</p>	<p><b>A-5715</b> Air Filter Secondary Metal End Cap Element</p> <p>CATERPILLAR 1N-4864 CUMMINS 3013213 CATERPILLAR 3I-0215</p>  <p>Primary Filter uses A-5718 Set Filter uses A-5718-S H 1 : 571.75 (mm) H 2 : 559 (mm) OD 1 : 260 (mm) OD 2 : 260 (mm) ID 1 : 231.5 (mm) ID 2 : 23 (mm)</p> <p>CONT : 1 VOL : 0.047</p>

# Sakura Filter

# Technical Specification

**A-5718** Air Filter Primary Metal End Cap Element



CUMMINS 3013212  
CATERPILLAR 3I-0795  
HITACHI 4206272

Secondary Filter uses A-5715  
Set Filter uses A-5718-S  
H 1 : 622.7 (mm)  
H 2 : 610 (mm)  
OD 1 : 373 (mm)  
OD 2 : 373 (mm)  
ID 1 : 262.5 (mm)  
ID 2 : 23 (mm)

CONT : 1  
VOL : 0.102

**A-6011** Air Filter Secondary Metal End Cap Element



ISUZU 1-14215118-0  
ISUZU 1-14215127-0  
ISUZU 14215-127

Primary Filter uses A-6010  
Set Filter uses A-6010-S  
H 1 : 469.7 (mm)  
H 2 : 457 (mm)  
OD 1 : 185 (mm)  
OD 2 : 185 (mm)  
ID 1 : 157.5 (mm)  
ID 2 : 17 (mm)

CONT : 9  
VOL : 0.190

**A-7119-S** Air Filter Set Soft PU end cap Element



VOLVO 11033998+11033999  
VOLVO 110339983+110033991  
TEREX 15272252+15272253

Primary Filter uses A-7118  
Secondary Filter uses A-7117  
H 1 : 580 (mm)  
H 2 : 569 (mm)  
OD 1 : 313 (mm)  
OD 2 : 313 (mm)  
ID 1 : 178 (mm)

CONT : 1  
VOL : 0.064

**A-6006** Air Filter Primary Metal End Cap Element



ISUZU 1-14214108-0  
ISUZU 1-14214153-0  
ISUZU 1-14215060-0  
NISSAN 16546-Z9010  
TOYOTA 17801-2560

Secondary Filter uses A-6007  
Set Filter uses A-6118-S  
H 1 : 342.7 (mm)  
H 2 : 330 (mm)  
OD 1 : 232 (mm)  
OD 2 : 232 (mm)  
ID 1 : 147 (mm)  
ID 2 : 23 (mm)

CONT : 4  
VOL : 0.093

Note : For Flame Retardant version use A-60400

**A-6113** Air Filter Primary Metal End Cap Element



FIAT 01901779  
ISUZU 1-14215046-0  
NISSAN 16546-96017

Secondary Filter uses A-5408  
Set Filter uses A-5653-S  
H 1 : 418.7 (mm)  
H 2 : 406 (mm)  
OD 1 : 282 (mm)  
OD 2 : 282 (mm)  
ID 1 : 171 (mm)  
ID 2 : 17 (mm)

CONT : 1  
VOL : 0.038

**A-7605** Air Filter Secondary Metal End Cap Element



CASE 537335R1  
FIAT 79022026  
JOHN DEERE AL27159

Primary Filter uses AS-7609  
Set Filter uses AS-7609-S  
H 1 : 280.7 (mm)  
H 2 : 279.4 (mm)  
OD 1 : 92.5 (mm)  
OD 2 : 75 (mm)  
ID 1 : 61 (mm)  
ID 2 : 17 (mm)

CONT : 25  
VOL : 0.089

**A-6007** Air Filter Secondary Metal End Cap Element



ISUZU 1-14215061-0  
ISUZU 1-14215078-0  
ISUZU 1-14215078-1

Primary Filter uses A-6006  
Set Filter uses A-6118-S  
H 1 : 317.7 (mm)  
H 2 : 305 (mm)  
OD 1 : 145 (mm)  
OD 2 : 145 (mm)  
ID 1 : 116.5 (mm)  
ID 2 : 23 (mm)

CONT : 9  
VOL : 0.078

Note : ID=17 MM uses A-6031

**A-6118-S** Air Filter Set Metal End Cap Element



NISSAN 16546-Z9025  
NISSAN 16546-Z9027  
CATERPILLAR 7Y-0404+7Y-0403

Primary Filter uses A-6006  
Secondary Filter uses A-6007  
H 1 : 343 (mm)  
H 2 : 330 (mm)  
OD 1 : 232 (mm)  
OD 2 : 232 (mm)  
ID 1 : 147 (mm)  
ID 2 : 23 (mm)

CONT : 4  
VOL : 0.097

**A-7619** Air Filter Secondary Metal End Cap Element



MASSEY-FERGUSON 3580724M1  
LIEBHERR 7403951  
JOHN DEERE RE42762

Primary Filter uses AS-7621  
Set Filter uses AS-7622-S  
H 1 : 393.7 (mm)  
H 2 : 381 (mm)  
OD 1 : 151 (mm)  
OD 2 : 151 (mm)  
ID 1 : 123 (mm)  
ID 2 : 17 (mm)

CONT : 9  
VOL : 0.120

**A-6008** Air Filter Secondary Metal End Cap Element



ISUZU 1-14215047-0  
ISUZU 1-1425-046-1  
NISSAN 16546-96010

Primary Filter uses A-5627  
Set Filter uses A-5663-S  
H 1 : 330 (mm)  
OD 1 : 146 (mm)  
OD 2 : 116.5 (mm)  
ID 1 : 88 (mm)  
ID 2 : 17 (mm)

CONT : 9  
VOL : 0.083

**A-7117** Air Filter Secondary Soft PU end cap Element



VOLVO CONSTRUCTION EQUIPMENT 11033999  
VOLVO CONSTRUCTION EQUIPMENT 11033999-1

Primary Filter uses A-7118  
Set Filter uses A-7119-S  
H 1 : 563 (mm)  
H 2 : 557 (mm)  
OD 1 : 179 (mm)  
OD 2 : 179 (mm)  
ID 1 : 148 (mm)

CONT : 6  
VOL : 0.133

**A-76231** Air Filter Primary Soft PU end cap Element flame retardant media



CLARK 1241080  
TOYOTA 17741-U3330-71  
KOMATSU 3EC02A541E

H 1 : 356 (mm)  
H 2 : 347 (mm)  
OD 1 : 163.5 (mm)  
OD 2 : 163.5 (mm)  
ID 1 : 91 (mm)

CONT : 9  
VOL : 0.116

Note : Flame Retardant version of A-5541

**A-6010** Air Filter Primary Metal End Cap Element



ISUZU 1-14215116-0  
ISUZU 1-14215117-0  
ISUZU 1-14215128-0

Secondary Filter uses A-6011  
Set Filter uses A-6010-S  
H 1 : 495.7 (mm)  
H 2 : 483 (mm)  
OD 1 : 307 (mm)  
OD 2 : 307 (mm)  
ID 1 : 196 (mm)  
ID 2 : 23 (mm)

CONT : 1  
VOL : 0.060

**A-7118** Air Filter Primary Soft PU end cap Element



VOLVO CONSTRUCTION EQUIPMENT 11033998  
VOLVO CONSTRUCTION EQUIPMENT 11033998-3

Secondary Filter uses A-7117  
Set Filter uses A-7119-S  
H 1 : 580 (mm)  
H 2 : 569 (mm)  
OD 1 : 313 (mm)  
OD 2 : 313 (mm)  
ID 1 : 178 (mm)

CONT : 1  
VOL : 0.068

**A-76660** Air Filter Secondary Metal End Cap Element



HITACHI AR80653  
JOHN DEERE AR80653  
JOHN DEERE SR80653

Primary Filter uses A-76670  
Set Filter uses A-76670-S  
H 1 : 411 (mm)  
H 2 : 398 (mm)  
OD 1 : 131 (mm)  
OD 2 : 131 (mm)  
ID 1 : 102 (mm)  
ID 2 : 16.5 (mm)

CONT : 9  
VOL : 0.091

# Sakura Filter

# Technical Specification

**A-76670** Air Filter Primary Metal End Cap Element

JOHN DEERE AR76766  
HITACHI AR80652  
JOHN DEERE AR80652



Secondary Filter uses A-76660  
Set Filter uses A-76670-S  
H 1 : 503 (mm)  
H 2 : 493 (mm)  
OD 1 : 231 (mm)  
OD 2 : 231 (mm)  
ID 1 : 133 (mm)  
ID 2 : 10 (mm)

CONT : 4  
VOL : 0.135

61

**A-7915** Air Filter Secondary Metal End Cap Element

CATERPILLAR 1N-8164  
CATERPILLAR 4N-9164  
INGERSOLL RAND 50616408



Primary Filter uses A-7912  
Set Filter uses A-7912-S  
H 1 : 432.7 (mm)  
H 2 : 423 (mm)  
OD 1 : 220 (mm)  
OD 2 : 220 (mm)  
ID 1 : 179 (mm)  
ID 2 : 23 (mm)

CONT : 4  
VOL : 0.104

66

**A-8505** Air Filter Primary Soft PU end cap Element

OPEL 1#123 84 075  
OPEL 1-12384075  
SUNWARD 730403000155



Secondary Filter uses A-8599  
Set Filter uses A-8602-S  
H 1 : 312 (mm)  
H 2 : 304 (mm)  
OD 1 : 127.5 (mm)  
OD 2 : 127.5 (mm)  
ID 1 : 83 (mm)

CONT : 16  
VOL : 0.109

Note : For Flame Retardant version, use A-76410

71

**A-76670-S** Air Filter Set Metal End Cap Element

JOHN DEERE AR80652+AR80653



Primary Filter uses A-76670  
Secondary Filter uses A-76660  
H 1 : 503 (mm)  
H 2 : 493 (mm)  
OD 1 : 231 (mm)  
OD 2 : 231 (mm)  
ID 1 : 102 (mm)  
ID 2 : 10 (mm)

CONT : 4  
VOL : 0.135

62

**A-7954** Air Filter Primary Metal End Cap Element

ATLAS COPCO 3216-7082-01



Secondary Filter uses A-7809  
Set Filter uses A-7954-S  
H 1 : 419.7 (mm)  
H 2 : 407 (mm)  
OD 1 : 234 (mm)  
OD 2 : 276 (mm)  
ID 1 : 122.5 (mm)  
ID 2 : 15 (mm)

CONT : 1  
VOL : 0.037

67

**A-8513** Air Filter Primary Soft PU end cap Element

YANMAR 119808-12520  
NISSAN 16546-FJ100  
KOMATSU 3EB-02-38730  
SUNWARD 730403000157



Secondary Filter uses A-5569  
Set Filter uses A-5570-S  
H 1 : 273.5 (mm)  
H 2 : 265 (mm)  
OD 1 : 104 (mm)  
OD 2 : 104 (mm)  
ID 1 : 61 (mm)

CONT : 25  
VOL : 0.110

Note : A-8513(with Flame Retardant Media)

72

**A-7806** Air Filter Secondary Metal End Cap Element

YANMAR 119131-12520  
ISUZU 14215-167  
DAEWOO 2474-9014



Primary Filter uses AS-7805  
Set Filter uses AS-5656-S  
H 1 : 337 (mm)  
H 2 : 330 (mm)  
OD 1 : 85.5 (mm)  
OD 2 : 85.5 (mm)  
ID 1 : 57.5 (mm)  
ID 2 : 17 (mm)

CONT : 12  
VOL : 0.050

Note : Is a secondary Air Filter for AS-7805,AS-7813,A-7805

63

**A-7956** Air Filter Secondary Metal End Cap Element

HITACHI 4209588  
HITACHI 4247974



Primary Filter uses A-2708  
Set Filter uses A-2711-S  
H 1 : 249.7 (mm)  
H 2 : 237 (mm)  
OD 1 : 133.5 (mm)  
OD 2 : 133.5 (mm)  
ID 1 : 105 (mm)  
ID 2 : 17 (mm)

CONT : 10  
VOL : 0.060

68

**A-8568** Air Filter Metal End Cap Element

KUBOTA 121422-12570  
YANMAR 121422-12570  
KUBOTA 15287-11490  
CASE 167817A1  
HITACHI 4311871



H 1 : 232 (mm)  
H 2 : 228.5 (mm)  
OD 1 : 62.5 (mm)  
OD 2 : 62.5 (mm)  
ID 1 : 49 (mm)  
ID 2 : 17 (mm)

CONT : 25  
VOL : 0.038

73

**A-7809** Air Filter Secondary Metal End Cap Element

NISSAN 16546-Z5003  
ATLAS COPCO 3216-708202  
CATERPILLAR 3I-0069  
JOHN DEERE T46317



Primary Filter uses A-7954  
Set Filter uses A-7954-S  
H 1 : 387.4 (mm)  
H 2 : 381 (mm)  
OD 1 : 116.5 (mm)  
OD 2 : 116.5 (mm)  
ID 1 : 88 (mm)  
ID 2 : 17 (mm)

CONT : 25  
VOL : 0.178

64

**A-7964** Air Filter Secondary Metal End Cap Element

IVECO 08015449  
MASSEY-FERGUSON 1093683M91  
FIAT-ALLIS 1909964



Primary Filter uses AS-7988  
Set Filter uses AS-7988-S  
H 1 : 357 (mm)  
H 2 : 355.5 (mm)  
OD 1 : 105 (mm)  
OD 2 : 85.5 (mm)  
ID 1 : 73.5 (mm)  
ID 2 : 17 (mm)

CONT : 25  
VOL : 0.141

Note : Is a Secondary Air filter for AS-7988,AS-7813,AS-7805,AS-4304

69

**A-8580** Air Filter Secondary Soft PU end cap Element

CATERPILLAR 142-1403  
ATLAS COPCO 3222-1881-92  
HITACHI 4466268



Primary Filter uses A-8579  
Set Filter uses A-8579-S  
H 1 : 500 (mm)  
H 2 : 494 (mm)  
OD 1 : 179 (mm)  
OD 2 : 174 (mm)  
ID 1 : 148 (mm)

CONT : 1  
VOL : 0.019

Note : Is a Secondary Air filter of A-8579M,A-8665M

74

**A-7902** Air Filter Secondary Metal End Cap Element

HITACHI 4331920  
CATERPILLAR 9Y-7663



Primary Filter uses A-9217  
Set Filter uses A-9217-S  
H 1 : 563.35 (mm)  
H 2 : 550.6 (mm)  
OD 1 : 276 (mm)  
OD 2 : 276 (mm)  
ID 1 : 207.5 (mm)  
ID 2 : 22.7 (mm)

CONT : 1  
VOL : 0.048

65

**A-7967** Air Filter Secondary Metal End Cap Element

ISUZU 1-14215089-0  
NISSAN 16546-96065  
KOBELCO 2446U250S-2



Primary Filter uses A-1828  
Set Filter uses A-1840-S  
H 1 : 495.7 (mm)  
H 2 : 483 (mm)  
OD 1 : 162.3 (mm)  
OD 2 : 162.3 (mm)  
ID 1 : 134 (mm)  
ID 2 : 17 (mm)

CONT : 9  
VOL : 0.152

70

**A-8599** Air Filter Secondary Soft PU end cap Element

KUBOTA 119005-12571  
CASE 133721A1  
HITACHI 4326841



Primary Filter uses A-8505  
Set Filter uses A-8602-S  
H 1 : 303.5 (mm)  
H 2 : 298 (mm)  
OD 1 : 83 (mm)  
OD 2 : 79 (mm)  
ID 1 : 64 (mm)

CONT : 25  
VOL : 0.076

Note : Is a Secondary Air filter for A-5669,A-8505

75



# Sakura Filter

# Technical Specification

**A-8650** Air Filter Primary Soft PU end cap Element

JOHN DEERE F434394  
CASE IH275809A1



Secondary Filter uses A-8651  
Set Filter uses A-8652-S  
H 1 : 524 (mm)  
H 2 : 512 (mm)  
OD 1 : 280 (mm)  
OD 2 : 280 (mm)  
ID 1 : 148 (mm)

CONT : 1  
VOL : 0.047

Note : Is a long life version of A-5102

**AS-1024** Air Filter Primary Metal End Cap Element With Sleeve

NISSAN 16546-96003  
NISSAN 16546-96015  
NISSAN 16546-96026



Secondary Filter uses A-6009  
Set Filter uses AS-1024-S  
H 1 : 418.7 (mm)  
H 2 : 406 (mm)  
OD 1 : 254 (mm)  
OD 2 : 201.5 (mm)  
ID 1 : 135.5 (mm)  
ID 2 : 17 (mm)

CONT : 1  
VOL : 0.031

**AS-27170** Air Filter Primary Soft PU end cap Element

KATO 119-727001000  
YANMAR 172B06-11510  
HITACHI YD00001541



Secondary Filter uses A-27180  
Set Filter uses AS-27170-S  
H 1 : 301.5 (mm)  
H 2 : 294 (mm)  
OD 1 : 140 (mm)  
OD 2 : 140 (mm)  
ID 1 : 72 (mm)

CONT : 4  
VOL : 0.036

**A-8651** Air Filter Secondary Soft PU end cap Element

HITACHI 4459548  
KOMATSU 600-185-4220  
JOHN DEERE F434395  
CASE IH275810A1



Primary Filter uses A-8650  
Set Filter uses A-8652-S  
H 1 : 502 (mm)  
H 2 : 497 (mm)  
OD 1 : 150 (mm)  
OD 2 : 141.5 (mm)  
ID 1 : 109 (mm)

CONT : 9  
VOL : 0.134

Note : Is a long life version of A-5103

**AS-1024-S** Air Filter Set Metal End Cap Element With Sleeve

FIAT 1930751+1930790  
KOMATSU 6131-82-7011  
FIAT 70684732+1930790  
JOHN DEERE T46316+T46317



Primary Filter uses AS-1024  
Secondary Filter uses A-6009  
H 1 : 418.7 (mm)  
H 2 : 406 (mm)  
OD 1 : 254 (mm)  
OD 2 : 201.5 (mm)  
ID 1 : 135.5 (mm)  
ID 2 : 17 (mm)

CONT : 1  
VOL : 0.031

**AS-27170-S** Air Filter Set Soft PU end cap Element

IHI 074526508+074526509



Primary Filter uses AS-27170  
Secondary Filter uses A-27180  
H 1 : 301.5 (mm)  
H 2 : 294 (mm)  
OD 1 : 140 (mm)  
OD 2 : 140 (mm)  
ID 1 : 62 (mm)

CONT : 4  
VOL : 0.036

**A-8652-S** Air Filter Set Soft PU end cap Element

JOHN DEERE F434394 + F434395



Primary Filter uses A-8650  
Secondary Filter uses A-8651  
H 1 : 524 (mm)  
H 2 : 512 (mm)  
OD 1 : 280 (mm)  
OD 2 : 280 (mm)  
ID 1 : 148 (mm)

CONT : 1  
VOL : 0.047

Note : Is a long life version of A-5102-S

**AS-2205** Air Filter Primary Metal End Cap Element With Sleeve

ISUZU 1-14215014-0  
YANMAR 121120-12901  
KUBOTA 121420-12511



Secondary Filter uses A-8568  
Set Filter uses AS-2206-S  
H 1 : 264 (mm)  
H 2 : 254 (mm)  
OD 1 : 132 (mm)  
OD 2 : 104 (mm)  
ID 1 : 63 (mm)  
ID 2 : 17 (mm)

CONT : 12  
VOL : 0.073

**AS-5102** Air Filter Primary Soft PU end cap Element With Sleeve

VOLVO 11110022  
HITACHI 4459549



Secondary Filter uses A-5103  
Set Filter uses AS-5102-S  
H 1 : 522 (mm)  
H 2 : 510 (mm)  
OD 1 : 280 (mm)  
OD 2 : 280 (mm)  
ID 1 : 148 (mm)

CONT : 1  
VOL : 0.047

**AS-1010** Air Filter Metal End Cap Element With Sleeve

ISUZU 14215-132  
CUMMINS 158876  
NISSAN 16546-Z5001



H 1 : 266.7 (mm)  
H 2 : 254 (mm)  
OD 1 : 257 (mm)  
OD 2 : 201.5 (mm)  
ID 1 : 90.5 (mm)  
ID 2 : 14 (mm)

CONT : 1  
VOL : 0.021

Note : INN.DIAM=91/17MM Version Uses AS-1025,  
INN.DIAM 116/13.5MM Version Uses AS-1037

**AS-2212** Air Filter Primary Metal End Cap Element With Sleeve

FIAT 1930603  
FIAT 71415282



Secondary Filter uses A-7809  
Set Filter uses AS-2212-S  
H 1 : 420 (mm)  
H 2 : 407.5 (mm)  
OD 1 : 254 (mm)  
OD 2 : 278.5 (mm)  
ID 1 : 135.5 (mm)  
ID 2 : 15 (mm)

CONT : 1  
VOL : 0.037

**AS-5102-S** Air Filter Set Soft PU end cap Element With Sleeve

VOLVO 11110022+11110023



Primary Filter uses AS-5102  
Secondary Filter uses A-5103  
H 1 : 522 (mm)  
H 2 : 510 (mm)  
OD 1 : 280 (mm)  
OD 2 : 280 (mm)  
ID 1 : 148 (mm)

CONT : 1  
VOL : 0.050

**AS-1014** Air Filter Primary Metal End Cap Element With Sleeve

ISUZU 1-14215135-0  
TOYOTA 1001905  
YANMAR 171064-12540



Secondary Filter uses A-7919  
Set Filter uses AS-1014-S  
H 1 : 288 (mm)  
H 2 : 279 (mm)  
OD 1 : 160 (mm)  
OD 2 : 134 (mm)  
ID 1 : 66.5 (mm)  
ID 2 : 17 (mm)

CONT : 9  
VOL : 0.090

**AS-2212-S** Air Filter Set Metal End Cap Element With Sleeve

FIAT 1930603+1930790



Primary Filter uses AS-2212  
Secondary Filter uses A-7809  
H 1 : 420 (mm)  
H 2 : 407.5 (mm)  
OD 1 : 254 (mm)  
OD 2 : 278.5 (mm)  
ID 1 : 135.5 (mm)  
ID 2 : 15 (mm)

CONT : 1  
VOL : 0.037

**AS-5412** Air Filter Metal End Cap Element With Sleeve

YANMAR 124066-12510  
ISEKI 1427-101-2840-0  
KUBOTA 15221-11223



H 1 : 184.4 (mm)  
H 2 : 178 (mm)  
OD 1 : 109.4 (mm)  
OD 2 : 83 (mm)  
ID 1 : 45 (mm)  
ID 2 : 15.3 (mm)

CONT : 25  
VOL : 0.079



# Sakura Filter

# Technical Specification

**AS-5628** Air Filter Primary Metal End Cap Element With Sleeve

MAZDA 0727-23-603  
ISUZU 1-14215028-0  
ISUZU 1-14215032-0



Secondary Filter uses A-7611  
Set Filter uses AS-5628-S  
H 1 : 311 (mm)  
H 2 : 305 (mm)  
OD 1 : 199.3 (mm)  
OD 2 : 155 (mm)  
ID 1 : 88 (mm)  
ID 2 : 17 (mm)

CONT : 12  
VOL : 0.194

91

**AS-5708** Air Filter Metal End Cap Element With Sleeve

CUMMINS 158877  
CUMMINS 299353



H 1 : 266.75 (mm)  
H 2 : 254 (mm)  
OD 1 : 296 (mm)  
OD 2 : 234 (mm)  
ID 1 : 123 (mm)  
ID 2 : 14 (mm)

CONT : 1  
VOL : 0.027

Note : Sleeve On E/C "B" Type Uses AS-5709

96

**AS-8579** Air Filter Primary Soft PU end cap Element With Sleeve

VOLVO 11033996  
VOLVO BM 110339967  
CATERPILLAR 142-1340



Secondary Filter uses A-8580  
Set Filter uses AS-8579-S  
H 1 : 521 (mm)  
H 2 : 510 (mm)  
OD 1 : 313 (mm)  
OD 2 : 313 (mm)  
ID 1 : 178 (mm)

CONT : 1  
VOL : 0.057

101

**AS-5643** Air Filter Primary Metal End Cap Element With Sleeve

KOMATSU 37Z-02-AF934A  
KOMATSU 3EA-01-18130  
HITACHI 4294846



Secondary Filter uses A-8568  
Set Filter uses AS-5643-S  
H 1 : 263.7 (mm)  
H 2 : 251 (mm)  
OD 1 : 131.5 (mm)  
OD 2 : 148 (mm)  
ID 1 : 63 (mm)  
ID 2 : 17 (mm)

CONT : 16  
VOL : 0.121

92

**AS-7609** Air Filter Primary Metal End Cap Element With Sleeve

CATERPILLAR 3I-0228  
FIAT 79022025



Secondary Filter uses A-7605  
Set Filter uses AS-7609-S  
H 1 : 315.9 (mm)  
H 2 : 305 (mm)  
OD 1 : 160 (mm)  
OD 2 : 133.5 (mm)  
ID 1 : 82 (mm)  
ID 2 : 17 (mm)

CONT : 9  
VOL : 0.110

97

**AS-8579-S** Air Filter Set Soft PU end cap Element With Sleeve

TEREX 15270188 + 15270189  
HITACHI 76612497+4466268



Primary Filter uses AS-8579  
Secondary Filter uses A-8580  
H 1 : 521 (mm)  
H 2 : 510 (mm)  
OD 1 : 313 (mm)  
OD 2 : 313 (mm)  
ID 1 : 178 (mm)

CONT : 1  
VOL : 0.057

102

**AS-5643-S** Air Filter Set Metal End Cap Element With Sleeve

CASE 167815A1+167817A1  
KOMATSU  
3EA-01-18130+3EB-02-19840  
HITACHI 4294846+4311871  
J.C.BAMFORD KAP0482+KAP0727



Primary Filter uses AS-5643  
Secondary Filter uses A-8568  
H 1 : 263.7 (mm)  
H 2 : 251 (mm)  
OD 1 : 131.5 (mm)  
OD 2 : 148 (mm)  
ID 1 : 63 (mm)  
ID 2 : 17 (mm)

CONT : 16  
VOL : 0.121

93

**AS-7621** Air Filter Primary Metal End Cap Element With Sleeve

FIAT 1930602  
DAEWOO 2471-9023  
FIAT 70005585



Secondary Filter uses A-7619  
Set Filter uses AS-7622-S  
H 1 : 419.75 (mm)  
H 2 : 407 (mm)  
OD 1 : 296 (mm)  
OD 2 : 317 (mm)  
ID 1 : 153 (mm)  
ID 2 : 15 (mm)

CONT : 1  
VOL : 0.052

98

**AS-8579M** Air Filter Primary Soft PU+Metal Element With Sleeve

HITACHI 76612497



Secondary Filter uses A-8580  
Set Filter uses AS-8579M-S  
H 1 : 521 (mm)  
H 2 : 510 (mm)  
OD 1 : 313 (mm)  
OD 2 : 313 (mm)  
ID 1 : 178 (mm)

CONT : 1  
VOL : 0.060

Note : with metal reinforcement

103

**AS-5656-S** Air Filter Set Metal End Cap Element With Sleeve

KOMATSU 600-181-9500



Primary Filter uses AS-7805  
Secondary Filter uses A-7806  
H 1 : 392 (mm)  
H 2 : 381 (mm)  
OD 1 : 199.3 (mm)  
OD 2 : 155 (mm)  
ID 1 : 88 (mm)  
ID 2 : 17 (mm)

CONT : 9  
VOL : 0.169

94

**AS-7622-S** Air Filter Set Metal End Cap Element With Sleeve

HITACHI 71420350 + 1930792



Primary Filter uses AS-7621  
Secondary Filter uses A-7619  
H 1 : 419.75 (mm)  
H 2 : 407 (mm)  
OD 1 : 296 (mm)  
OD 2 : 317 (mm)  
ID 1 : 153 (mm)  
ID 2 : 15 (mm)

CONT : 1  
VOL : 0.052

99

**C-1011** Oil Filter Full Flow Spin-On

NISSAN 15208-HC400  
HINO 15607-1920  
MAZDA JEYO-14-302



H 1 : 85 (mm)  
OD 1 : 68 (mm)  
Thread Size : M20X1.5-6H  
BPV (kg/cm<sup>2</sup>) : 1.0  
ADBV : YES  
Gasket Type : Round

CONT : 50  
VOL : 0.026

Note : Square version uses C-1030

104

**AS-5707** Air Filter Metal End Cap Element With Sleeve

CUMMINS 158871  
CUMMINS 158878  
NISSAN 16546-M0800



H 1 : 317.7 (mm)  
H 2 : 305 (mm)  
OD 1 : 352 (mm)  
OD 2 : 282 (mm)  
ID 1 : 171 (mm)  
ID 2 : 13.5 (mm)

CONT : 1  
VOL : 0.046

95

**AS-7805** Air Filter Primary Metal End Cap Element With Sleeve

IVECO 08014390  
MASSEY-FERGUSON 1093682M91  
ISUZU 14215-166



Secondary Filter uses A-7806  
Set Filter uses AS-5656-S  
H 1 : 392 (mm)  
H 2 : 381 (mm)  
OD 1 : 199 (mm)  
OD 2 : 155 (mm)  
ID 1 : 88 (mm)  
ID 2 : 17 (mm)  
Gasket Type : Square

CONT : 9  
VOL : 0.169

Note : Long Life Versions Uses AS-7813

100

**C-1303** Oil Filter Combination Spin-On

HINO 15607-1600  
HINO 15607-1830



H 1 : 199 (mm)  
OD 1 : 110 (mm)  
Thread Size : 1 1/2-16 UN-2B

CONT : 6  
VOL : 0.018

Note : single element version uses C-1325

105

# Sakura Filter

# Technical Specification

**C-1312** Oil Filter Full Flow Spin-On



ISUZU 1-13200768-1  
ISUZU 1-13240105-0  
HINO 15607-1420

H 1 : 248 (mm)  
OD 1 : 121 (mm)  
Thread Size : 1 3/8-16 UNF-2B  
Gasket Type : Square

CONT : 6  
VOL : 0.032

Note : With Drain Nut

**C-15680** Oil Filter By Pass Spin-On



J.C.BAMFORD 2800359  
HITACHI 4429725  
FIAT-HITACHI 71422692  
NEW HOLLAND (CNH) 71422692  
ISUZU 8-97026134-2

H 1 : 200 (mm)  
OD 1 : 110 (mm)  
Thread Size : M20X1.5-6H  
Gasket Type : Square

CONT : 12  
VOL : 0.042

**C-2708** Oil Filter Combination Spin-On



HITACHI 4448336  
HITACHI 4484495  
HITACHI 4661256

H 1 : 210 (mm)  
OD 1 : 120 (mm)  
Thread Size : 1 1/2-12 UNF-2B  
BPV (kg/cm2) : 1.0  
Gasket Type : Square

CONT : 6  
VOL : 0.026

Note : C-2705(bottom plate difference)

**C-1327** Oil Filter By Pass Spin-On



ISUZU 1-13240163-0  
ISUZU 1-13240163-1  
ISUZU 1-13240163-2  
HITACHI 4371313

H 1 : 248.8 (mm)  
OD 1 : 120 (mm)  
Thread Size : 1 3/8-16 UNF-2B  
Gasket Type : Square

CONT : 6  
VOL : 0.029

**C-1806** Oil Filter Full Flow Spin-On



ISUZU 132400930  
NISSAN 15209-J1800  
NISSAN 15209-Y7500

H 1 : 164 (mm)  
OD 1 : 80 (mm)  
Thread Size : 3/4-16 UNF-2B  
Gasket Type : Round

CONT : 36  
VOL : 0.050

**C-5102** Oil Filter Full Flow Spin-On



PERKINS 26540347  
PERKINS 2654407

H 1 : 168 (mm)  
OD 1 : 93 (mm)  
Thread Size : 3/4-16 UNF-2B  
BPV (kg/cm2) : 1.0  
ADBV : YES  
Gasket Type : Square

CONT : 25  
VOL : 0.050

**C-1506** Oil Filter By Pass Spin-On



ISUZU 1-13240048-1  
ISUZU 1-13240048-2  
ISUZU 1-13240059-0

H 1 : 162 (mm)  
OD 1 : 110 (mm)  
Thread Size : M20X1.5-6H  
Gasket Type : Square

CONT : 12  
VOL : 0.030

**C-2702** Oil Filter Full Flow Spin-On



KOBELCO 2451U309-1  
HITACHI 4183853  
HITACHI 4439863

H 1 : 150 (mm)  
OD 1 : 102 (mm)  
Thread Size : 1-12 UNF-2B  
BPV (kg/cm2) : 2.0 - 2.5  
ADBV : YES  
Gasket Type : Square

CONT : 12  
VOL : 0.027

**C-5201** Oil Filter By Pass Spin-On



mitsubishi 37540-02100

H 1 : 250 (mm)  
OD 1 : 125 (mm)  
Thread Size : 1 3/8-16 UNF-2B  
Gasket Type : Square

CONT : 6  
VOL : 0.034

Note : Is a long version of C-5809

**C-1511** Oil Filter Full Flow Spin-On



ISUZU 8-94217272-0  
ISUZU 8-94360426-0  
ISUZU 8-94430983-0

H 1 : 100 (mm)  
OD 1 : 90 (mm)  
Thread Size : M20X1.5-6H  
BPV (kg/cm2) : 1.0  
ADBV : YES  
Gasket Type : Round

CONT : 25  
VOL : 0.029

**C-2704** Oil Filter Combination Spin-On



HITACHI 4448336

H 1 : 252 (mm)  
OD 1 : 120 (mm)  
Thread Size : 1 1/2-12 UNF-2B  
Gasket Type : Square

CONT : 6  
VOL : 0.028

**C-5205** Oil Filter Full Flow Spin-On



YANMAR 119305-35151

H 1 : 65 (mm)  
OD 1 : 65 (mm)  
Thread Size : M20X1.5-6H  
BPV (kg/cm2) : 1.0  
ADBV : YES  
Gasket Type : Round

CONT : 50  
VOL : 0.021

**C-1538** Oil Filter Full Flow Spin-On



HOLDEN 8-9421-7272-2

H 1 : 95 (mm)  
OD 1 : 93 (mm)  
Thread Size : M20X1.5-6H  
BPV (kg/cm2) : 1.0  
ADBV : YES  
Gasket Type : Square

CONT : 25  
VOL : 0.037

Note : C-1503,C-1511 (bottom plate difference)

**C-2706** Oil Filter Full Flow Spin-On



HITACHI 4429726

H 1 : 206 (mm)  
OD 1 : 108 (mm)  
Thread Size : 1 1/2-12 UNF-2B  
Gasket Type : Square

CONT : 6  
VOL : 0.020

Note : Drain Nut

**C-5505** Oil Filter Full Flow Spin-On



CATERPILLAR 1R-0714  
HITACHI 4429728  
FIAT 71455273  
MITSUBISHI ME034878  
MITSUBISHI ME088519

H 1 : 162 (mm)  
OD 1 : 108 (mm)  
Thread Size : 1 1/8-16 UNF-2B  
Gasket Type : Square

CONT : 12  
VOL : 0.034

# Sakura Filter

# Technical Specification

**C-5703** Oil Filter Full Flow Spin-On



HYUNDAI 11E1-70110  
GENERAL MOTORS 25011995  
CUMMINS 3903224  
KOMATSU 6732-51-5140  
CASE J908616

H 1 : 135 (mm)  
OD 1 : 93 (mm)  
Thread Size : 1-16 UNF-2B  
Gasket Type : Square

CONT : 12  
VOL : 0.018

121

**C-5715** Oil Filter Full Flow Spin-On



MTU 0031843001  
CUMMINS 3313279  
MITSUBISHI 37540-01101  
CUMMINS 3889310  
KOMATSU CULF-670

H 1 : 246 (mm)  
OD 1 : 118 (mm)  
Thread Size : 1 1/2-12 UNF-2B

CONT : 6  
VOL : 0.029

Note : Height 286 MM Uses C-5701

126

**C-6204** Oil Filter Full Flow Spin-On



MERCEDES-BENZ 001 184 96 01  
DEUTZ 1173430  
CATERPILLAR 5W-6017  
ALLIS CHALMERS 61671600  
EVOBUS 7.119.226.04

H 1 : 206 (mm)  
OD 1 : 93 (mm)  
Thread Size : 1-12 UNF-2B  
BPV (kg/cm<sup>2</sup>) : 2.0 - 2.5  
ADBV : YES  
Gasket Type : Square

CONT : 25  
VOL : 0.057

Note : With Grip

131

**C-5704** Oil Filter Full Flow Spin-On Cellulose media



J.C.BAMFORD 02/910140  
J.C.BAMFORD 02/910140A  
CUMMINS 3903264

H 1 : 174 (mm)  
OD 1 : 93 (mm)  
Thread Size : 1-16 UNF-2B  
Gasket Type : Square

CONT : 12  
VOL : 0.023

Note : High Performance Grade Uses C-5730

122

**C-5718** Oil Filter By Pass Spin-On



ISUZU 1-87310093-0  
CATERPILLAR 1W-8845  
J.C.BAMFORD 32/919502  
HITACHI 4285964

H 1 : 246 (mm)  
OD 1 : 115.5 (mm)  
Thread Size : 1 3/8-16 UNF-2B

CONT : 6  
VOL : 0.032

127

**C-7105** Oil Filter Full Flow Spin-On



VOLVO 478736  
VOLVO 478736-2  
RENAULT 5 001 846 642

H 1 : 259 (mm)  
OD 1 : 108 (mm)  
Thread Size : 1 1/8-16 UNF-2B  
Gasket Type : Square

CONT : 6  
VOL : 0.026

132

**C-5705** Oil Filter Combination Spin-On



FIAT 1902102  
IVECO 1903629  
IVECO 1903715  
IVECO 1907584

H 1 : 211 (mm)  
OD 1 : 108 (mm)  
Thread Size : M30X2-6H  
Gasket Type : Square

CONT : 6  
VOL : 0.022

123

**C-5723** Oil Filter Combination Spin-On



KOMATSU 6742-01-4120

H 1 : 280 (mm)  
OD 1 : 121 (mm)  
Thread Size : 2 1/4-12 UNF-2B  
Gasket Type : Square

CONT : 6  
VOL : 0.038

128

**C-7303** Oil Filter Full Flow Spin-On



TEREX 15273756  
DETROIT DIESEL 23526919  
HITACHI E1297440

H 1 : 305 (mm)  
OD 1 : 136 (mm)  
Thread Size : 1 1/2-16 UN-2B  
Gasket Type : Square

CONT : 6  
VOL : 0.046

133

**C-5707** Oil Filter Combination Spin-On Seamless



J.C.BAMFORD 02/910965  
CUMMINS 3401544  
KOMATSU 6742-01-4540

H 1 : 294 (mm)  
OD 1 : 118 (mm)  
Thread Size : 2 1/4-12 UNF-2B

CONT : 6  
VOL : 0.029

Note : Multilayer

124

**C-6001** Oil Filter Full Flow Spin-On



ISUZU 1-13240062-2  
ISUZU 1-87811638-0

H 1 : 203 (mm)  
OD 1 : 118 (mm)  
Thread Size : 1 1/2-12 UNF-2B

CONT : 6  
VOL : 0.025

129

**C-7917** Oil Filter Full Flow Spin-On



IVECO 01901603  
IVECO 1901603  
IVECO 1907566

H 1 : 184 (mm)  
OD 1 : 108 (mm)  
Thread Size : 3/4-16 UNF-2B  
ADBV : YES  
Gasket Type : Square

CONT : 6  
VOL : 0.020

134

**C-5708** Oil Filter Full Flow Spin-On



J.C.BAMFORD 32/925413  
CUMMINS 3937736

H 1 : 174 (mm)  
OD 1 : 93 (mm)  
Thread Size : 1 1/8-16 UNF-2B  
Gasket Type : Square

CONT : 12  
VOL : 0.027

Note : Glass Fiber media uses C-5733

125

**C-6101** Oil Filter Full Flow Spin-On



NISSAN 15209-0T000  
NISSAN 15209-T9000  
NISSAN 15209-T9001

H 1 : 200 (mm)  
OD 1 : 93 (mm)  
Thread Size : 1-12 UNF-2B  
ADBV : YES  
Gasket Type : Round

CONT : 25  
VOL : 0.056

130

**C-7937** Oil Filter Combination Spin-On



IVECO 01902047  
IVECO 01902076  
FIAT 1902047  
IVECO 1902076

H 1 : 143 (mm)  
OD 1 : 108.5 (mm)  
Thread Size : 3/4-16 UNF-2B  
BPV (kg/cm<sup>2</sup>) : 2.0

CONT : 6  
VOL : 0.015

135

# Sakura Filter

# Technical Specification

**C-8012** Oil Filter Full Flow Spin-On



MAHINDRA 14501673990  
HITACHI 26300-21010  
HYUNDAI 26300-21010  
CHRYSLER 4186267  
MITSUBISHI 4253037

H 1 : 78 (mm)  
OD 1 : 86 (mm)  
Thread Size : M20X1.5-6H  
BPV (kg/cm2) : 1.0  
ADBV : YES  
Gasket Type : Square

CONT : 50  
VOL : 0.046

136

**CA-27030** Cabin Air Filter Plastic framed Element



HITACHI 4643580  
HITACHI 4S00685

H 1 : 55 (mm)  
H 2 : 45 (mm)  
Length 1 : 281 (mm)  
Width 1 : 161 (mm)

CONT : 20  
VOL : 0.064

Note : For Inside application

141

**CA-56041** Cabin Air Filter Plastic framed Element



KOMATSU 14X-911-7750  
KOMATSU 17M-911-3530  
HITACHI 4234793  
KOMATSU 569-076-1190  
FIAT 71498266

H 1 : 51 (mm)  
Length 1 : 220 (mm)  
Width 1 : 163 (mm)

CONT : 20  
VOL : 0.049

146

**CA-2405** Cabin Air Filter Soft PU framed Element



VOLVO 11007388  
VOLVO 110073889  
VOLVO 1584575  
VOLVO 1584575-3

H 1 : 45 (mm)  
Length 1 : 268 (mm)  
Width 1 : 188 (mm)

CONT : 20  
VOL : 0.059

137

**CA-27040** Cabin Air Filter Plastic framed Element



HITACHI 4350249  
HITACHI 4S00640

H 1 : 71 (mm)  
Length 1 : 346 (mm)  
Width 1 : 254 (mm)

CONT : 10  
VOL : 0.081

142

**EF-1801** Fuel Filter Main Eco Element High Efficiency

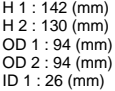

NISSAN 16444-NY025  
HITACHI 4642641

H 1 : 142 (mm)  
H 2 : 130 (mm)  
OD 1 : 94 (mm)  
OD 2 : 94 (mm)  
ID 1 : 26 (mm)

CONT : 50  
VOL : 0.078

Note : micron rating:nominal 4 micron,absolute 5.89

147

**CA-27010** Cabin Air Filter Element



VOLVO 12583881  
HITACHI 12630763  
DEUTZ 70257109  
FIAT 70257109  
EUCLID E12583881

H 1 : 55.6 (mm)  
Length 1 : 406 (mm)  
Width 1 : 305 (mm)

CONT : 2  
VOL : 0.017

138

**CA-27050** Cabin Air Filter Plastic framed Element



HITACHI 4441139  
HITACHI 4S00684

H 1 : 10 (mm)  
Length 1 : 283.5 (mm)  
Width 1 : 177.5 (mm)  
Width 2 : 179 (mm)

CONT : 20  
VOL : 0.021

143

**EF-2634** Fuel Filter Eco Element High Efficiency

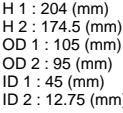

MERCEDES-BENZ 541 090 00 51  
MERCEDES-BENZ 541 090 01 51  
MERCEDES-BENZ 541 092 03 05

H 1 : 204 (mm)  
H 2 : 174.5 (mm)  
OD 1 : 105 (mm)  
OD 2 : 95 (mm)  
ID 1 : 45 (mm)  
ID 2 : 12.75 (mm)

CONT : 25  
VOL : 0.073

148

**CA-27020** Cabin Air Filter Plastic framed Element



HITACHI 4632689  
HITACHI 4S00686

H 1 : 75 (mm)  
Length 1 : 320 (mm)  
Width 1 : 216 (mm)

CONT : 20  
VOL : 0.152

Note : For Outside application

139

**CA-27060** Cabin Air Filter Plastic framed Element



HITACHI YA00001490

H 1 : 43 (mm)  
Length 1 : 260 (mm)  
Length 2 : 232 (mm)  
Width 1 : 243 (mm)

CONT : 10  
VOL : 0.050

144

**EF-2701** Fuel Filter Primary Eco Element 14 micron

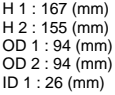

HITACHI 4649267  
SUMITOMO KHH10590  
KOBELCO YN21P01036R100

H 1 : 167 (mm)  
H 2 : 155 (mm)  
OD 1 : 94 (mm)  
OD 2 : 94 (mm)  
ID 1 : 26 (mm)

CONT : 25  
VOL : 0.049

Note : EF-2701 media 14 micron,to upgrade use EF-27040(media 7 micron)

149

**CA-27021** Cabin Air Filter Paper framed Element



HITACHI YA00032683

H 1 : 77 (mm)  
Length 1 : 320 (mm)  
Width 1 : 216 (mm)

CONT : 20  
VOL : 0.170

Note : with foam

140

**CA-55090** Cabin Air Filter Plastic Element



CATERPILLAR 245-8237  
TCM 263G6-73191

H 1 : 23 (mm)  
Length 1 : 245 (mm)  
Width 1 : 203 (mm)

CONT : 20  
VOL : 0.063

145

**EF-27022** Fuel Filter Main Eco Element High Efficiency

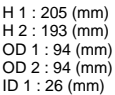

J.C.BAMFORD 332/G0652  
HITACHI 4679981

H 1 : 205 (mm)  
H 2 : 193 (mm)  
OD 1 : 94 (mm)  
OD 2 : 94 (mm)  
ID 1 : 26 (mm)

CONT : 50  
VOL : 0.117

Note : 4 micron

150

**EF-27040** Fuel Filter Primary Eco Element High Efficiency

HITACHI 4649267  
HITACHI 4676385  
SUMITOMO KHH12030  
KOBELCO YN21P01036R100

H 1 : 167 (mm)  
H 2 : 155 (mm)  
OD 1 : 94 (mm)  
OD 2 : 94 (mm)  
ID 1 : 26 (mm)

CONT : 25  
VOL : 0.049

Note : 7 micron

151

**F-1304** Fuel Filter Metal End Cap Element

HINO 23401-1020  
HINO 23401-1021  
HINO 23401-1080



H 1 : 109 (mm)  
H 2 : 104 (mm)  
OD 1 : 103 (mm)  
OD 2 : 104 (mm)  
ID 1 : 49 (mm)  
ID 2 : 15 (mm)

CONT : 50  
VOL : 0.080

156

**F-2604** Fuel Filter Metal End Cap Element

MERCEDES-BENZ 000 477 40 15  
MERCEDES-BENZ 000 477 45 15  
MERCEDES-BENZ 355 470 01 92



H 1 : 145 (mm)  
H 2 : 138 (mm)  
OD 1 : 83 (mm)  
OD 2 : 83 (mm)  
ID 1 : 14 (mm)  
ID 2 : 14 (mm)

CONT : 50  
VOL : 0.062

161

**EF-27050** Fuel Filter Main Eco Element High Efficiency

HITACHI 4719921  
ISUZU 8981527380

H 1 : 142 (mm)  
H 2 : 130 (mm)  
OD 1 : 94 (mm)  
OD 2 : 94 (mm)  
ID 1 : 26 (mm)

CONT : 50  
VOL : 0.081

Note : dual element/media

152

**F-1503** Fuel Filter Metal End Cap Element

ISUZU 1-87810207-0  
ISUZU 1-87810207-1  
ISUZU 1-87810207-2



H 1 : 166 (mm)  
H 2 : 160 (mm)  
OD 1 : 101 (mm)  
OD 2 : 101 (mm)  
ID 1 : 14.5 (mm)  
ID 2 : 14.5 (mm)

CONT : 50  
VOL : 0.105

157

**F-5202** Fuel Filter Metal End Cap Element

YANMAR 104500-55710  
HITACHI 4294842  
ISUZU 5-87810269-0  
JOHN DEERE CH15553  
FORD SBA130366040



H 1 : 69 (mm)  
H 2 : 66.5 (mm)  
OD 1 : 35 (mm)  
OD 2 : 35 (mm)  
ID 1 : 11 (mm)

CONT : 100  
VOL : 0.015

Note :

162

**EF-27060** Fuel Filter Main Eco Element High Efficiency

HITACHI 4719920  
SUNWARD 750201011065  
ISUZU 8981527370

H 1 : 205 (mm)  
H 2 : 193 (mm)  
OD 1 : 94 (mm)  
OD 2 : 94 (mm)  
ID 1 : 26 (mm)

CONT : 12  
VOL : 0.037

Note : For Sunward SWE150LC Excavator Tracked Engine:  
Isuzu AA4BG1TCG04

153

**F-1504** Fuel Filter Metal End Cap Element

ISUZU 1-13240008-0  
ISUZU 1-87810027-0  
ISUZU 1-87810027-1



H 1 : 138.5 (mm)  
H 2 : 137.5 (mm)  
OD 1 : 92 (mm)  
OD 2 : 92 (mm)  
ID 1 : 14.5 (mm)  
ID 2 : 14.5 (mm)

CONT : 24  
VOL : 0.037

158

**F-5207** Fuel Filter Metal End Cap Element

YANMAR 119810-55650  
YANMAR 124550-55700  
KUBOTA 16271-43560



H 1 : 87.5 (mm)  
H 2 : 85 (mm)  
OD 1 : 35 (mm)  
OD 2 : 35 (mm)  
ID 1 : 11.5 (mm)

CONT : 50  
VOL : 0.009

163

**F-1302** Fuel Filter Metal End Cap Element

HINO 23401-1040  
HINO 23401-1050  
HINO 6052-2008-00



H 1 : 102 (mm)  
H 2 : 100 (mm)  
OD 1 : 71 (mm)  
OD 2 : 71 (mm)  
ID 1 : 15 (mm)  
ID 2 : 15 (mm)

CONT : 50  
VOL : 0.035

154

**F-1803** Fuel Filter Metal End Cap Element

NISSAN 16444-90027  
NISSAN 16444-99127  
NISSAN 16444-99128



H 1 : 141 (mm)  
H 2 : 134 (mm)  
OD 1 : 91.5 (mm)  
OD 2 : 91.5 (mm)  
ID 1 : 14.5 (mm)  
ID 2 : 14.5 (mm)

CONT : 50  
VOL : 0.073

159

**F-5210** Fuel Filter Metal End Cap Element

YANMAR 129100-55650  
KUBOTA 15521-43160  
KUBOTA 607



H 1 : 89 (mm)  
OD 1 : 50 (mm)  
OD 2 : 50 (mm)  
ID 1 : 20 (mm)

CONT : 50  
VOL : 0.017

164

**F-1303** Fuel Filter Metal End Cap Element

ISUZU 13240-029  
NISSAN 16403-90026  
NISSAN 16444-90000  
HINO 23401-1030



H 1 : 105 (mm)  
OD 1 : 74 (mm)  
OD 2 : 74 (mm)  
ID 1 : 16 (mm)  
ID 2 : 16 (mm)

CONT : 50  
VOL : 0.040

155

**F-2603** Fuel Filter Metal End Cap Element

MERCEDES-BENZ 000 477 31 15  
DAIMLER BENZ 4220900051  
STEYR-DAIMLER-PUCH 614080740



H 1 : 145 (mm)  
H 2 : 130 (mm)  
OD 1 : 84.5 (mm)  
OD 2 : 84.5 (mm)  
ID 1 : 13 (mm)  
ID 2 : 13 (mm)

CONT : 50  
VOL : 0.062

160

**F-70020** Fuel Filter Metal End Cap Element

FIAT 1902096  
IVECO 1902096  
IVECO 1902096022  
FIAT 1909107  
NEW HOLLAND (CNH) 1909107



H 1 : 187 (mm)  
H 2 : 177 (mm)  
OD 1 : 91 (mm)  
OD 2 : 91 (mm)  
ID 1 : 26.3 (mm)  
ID 2 : 12.8 (mm)

CONT : 25  
VOL : 0.054

165



**F-7909** Fuel Filter Metal End Cap Element



KUBOTA 15231-4356-0  
KUBOTA 15231-4356-3  
MITSUBISHI MM 404889

H 1 : 85 (mm)  
OD 1 : 29 (mm)  
OD 2 : 29 (mm)  
ID 1 : 13 (mm)  
ID 2 : 13 (mm)

CONT : 100  
VOL : 0.011

166

**FC-1206** Fuel Filter Spin-On



KUBOTA 15221-43080  
KUBOTA 15221-43081  
KUBOTA 15221-43170

H 1 : 75 (mm)  
OD 1 : 80 (mm)  
Thread Size : M20X1.5-6H  
Gasket Type : Round

CONT : 50  
VOL : 0.034

171

**FC-1801** Fuel Filter Spin-On



NISSAN 16403-09W00  
NISSAN 16403-27000

H 1 : 80 (mm)  
OD 1 : 80 (mm)  
Thread Size : 3/4-16 UNF-2B  
Gasket Type : Round

CONT : 50  
VOL : 0.037

176

**F-7914** Fuel Filter Metal End Cap Element



POWERPUMP 8-94337-0220

H 1 : 35.6 (mm)  
H 2 : 33 (mm)  
OD 1 : 41 (mm)  
OD 2 : 41 (mm)  
ID 1 : 24.5 (mm)  
ID 2 : 24.5 (mm)

CONT : 100  
VOL : 0.010

167

**FC-1501** Fuel Filter Spin-On



NISSAN 16403-89TA1  
NISSAN 16403-J5500  
HITACHI 4285643

H 1 : 87 (mm)  
OD 1 : 80 (mm)  
Thread Size : 3/4-16 UNF-2B  
Gasket Type : Round

CONT : 50  
VOL : 0.039

172

**FC-1810** Fuel Filter Spin-On with head body



NISSAN 16403-99013  
NISSAN 16403-NY001

H 1 : 145 (mm)  
OD 1 : 93 (mm)  
Thread Size : 1-14 UNS-2B  
Gasket Type : Square

CONT : 12  
VOL : 0.024

177

**F-7930** Fuel Filter Metal End Cap Element



KOBELCO LS02P01012R100  
KOBELCO LS02P01012S002  
HITACHI YA00002973

H 1 : 144.5 (mm)  
H 2 : 106.5 (mm)  
OD 1 : 60 (mm)  
OD 2 : 60 (mm)  
ID 1 : 16 (mm)

CONT : 50  
VOL : 0.034

168

**FC-1503** Fuel Filter Spin-On High Efficiency



ISUZU 1-13240009-0  
ISUZU 1-13240041-0

H 1 : 125 (mm)  
OD 1 : 90 (mm)  
Thread Size : 3/4-16 UNF-2B  
Gasket Type : Round

CONT : 25  
VOL : 0.035

173

**FC-1824** Fuel Filter Spin-On



HITACHI 4S00203

H 1 : 89 (mm)  
OD 1 : 76 (mm)  
Thread Size : 3/4-16 UNF-2B  
Gasket Type : Square

CONT : 50  
VOL : 0.041

178

**FC-1005** Fuel Filter Spin-On



HITACHI 4326739  
NISSAN AY500-MT502  
CASE-IH CNH KHH10030  
SUMITOMO KHH10030

H 1 : 172 (mm)  
OD 1 : 93.2 (mm)  
Thread Size : M24X1.5-6H  
Gasket Type : Square

CONT : 25  
VOL : 0.052

Note : For high efficiency version, use FC-10270

169

**FC-15031** Fuel Filter Spin-On



ISUZU 1-13200688-0  
ISUZU 1-13240074-0  
ISUZU 1-13240079-1  
HITACHI 4206080  
GENERAL MOTORS 94392474

H 1 : 125 (mm)  
OD 1 : 90 (mm)  
Thread Size : 3/4-16 UNF-2B  
Gasket Type : Square

CONT : 12  
VOL : 0.020

Note : FC-1503(Bottom plate difference)

174

**FC-2202** Fuel Filter Spin-On



IVECO 190 4640  
IVECO 190 7640  
IVECO 193 0953

H 1 : 147 (mm)  
OD 1 : 76 (mm)  
Thread Size : M16X1.5-6H  
Gasket Type : Square

CONT : 25  
VOL : 0.028

179

**FC-1006** Fuel Filter Spin-On



SUZUKI 15410-78E00  
SUZUKI 15411-78E00

H 1 : 120 (mm)  
OD 1 : 80 (mm)  
Thread Size : M20X1.5-6H  
Thread Nut Size : M22X1.5-6H  
Gasket Type : Round

CONT : 50  
VOL : 0.053

170

**FC-1702** Fuel Filter Can-type Housing



VW GROUP 061 198 552  
NISSAN 16403-76200  
VOLVO 236628  
VOLVO 236628/4

H 1 : 71 (mm)  
OD 1 : 84 (mm)  
OD 2 : 86.5 (mm)  
ID 1 : 19.5 (mm)  
ID 2 : 19.5 (mm)

CONT : 50  
VOL : 0.036

Note : rolled paper version

175

**FC-2702** Fuel Filter Spin-On



HITACHI 4206130  
ISUZU 8-94453738-1  
ISUZU 8-94453738-2

H 1 : 80 (mm)  
OD 1 : 90 (mm)  
Thread Size : 3/4-16 UNF-2B  
Gasket Type : Round

CONT : 36  
VOL : 0.033

Note : Different Height With FC-2701

180



**FC-2703** Fuel Filter Spin-On With Nut  
HITACHI 4192631



H 1 : 182.7 (mm)  
H 2 : 175 (mm)  
OD 1 : 93 (mm)  
Thread Size : 1-14 UNS-2B  
Gasket Type : Square

CONT : 12  
VOL : 0.028

181

**FC-5704** Fuel Filter Spin-On  
VOLVO 241672  
VOLVO 243004  
MASSEY-FERGUSON 2871513M1



H 1 : 123 (mm)  
OD 1 : 76 (mm)  
Thread Size : M16X1.5-6H  
Gasket Type : Square

CONT : 50  
VOL : 0.047

Note : With Center Tube

186

**FC-58010** Fuel Filter Spin-On High Efficiency  
MITSUBISHI 32562-60300



H 1 : 145 (mm)  
OD 1 : 93.4 (mm)  
Thread Size : 1-14 UNS-2B  
Gasket Type : Square

CONT : 12  
VOL : 0.022

191

**FC-27050** Fuel Filter Spin-On  
HITACHI YA00029016



H 1 : 172 (mm)  
OD 1 : 93 (mm)  
Thread Size : 1 1/8-16 UNF-2B  
Gasket Type : Round

CONT : 20  
VOL : 0.055

182

**FC-5715** Fuel Filter Spin-On With Drain Plug  
KHD(KLOCKNER-HUMBOLT-DEUTZ ) 1174482  
J.C.BAMFORD 32/912001



H 1 : 163 (mm)  
OD 1 : 81.5 (mm)  
Thread Size : M16X1.5-6H  
Thread Nut Size : M8X1.25  
Gasket Type : Square

CONT : 25  
VOL : 0.037

187

**FC-6501** Fuel Filter Primary Spin-On  
GENERAL MOTORS 25014274  
GENERAL MOTORS 6438839



Secondary Filter uses FC-6502

H 1 : 203 (mm)  
OD 1 : 93 (mm)  
Thread Size : 1-12 UNF-2B  
Gasket Type : Square

CONT : 12  
VOL : 0.028

192

**FC-27060** Fuel Filter Spin-On With Nut  
ISUZU 8-98312918-0  
ISUZU 8982394641  
SUMITOMO MMH80990  
HITACHI YA00033486



H 1 : 199 (mm)  
OD 1 : 108 (mm)  
Thread Size : M82X1.5-6H

CONT : 12  
VOL : 0.042

183

**FC-5720** Fuel Filter Spin-On  
CUMMINS 154709  
CUMMINS 3315844



H 1 : 135 (mm)  
OD 1 : 93 (mm)  
Thread Size : 1-14 UNS-2B  
Gasket Type : Square

CONT : 12  
VOL : 0.021

Note : Is a short version of FC-57270

188

**FC-6502** Fuel Filter Secondary Spin-On  
GENERAL MOTORS 25010778  
GENERAL MOTORS 6438840



Primary Filter uses FC-6501

H 1 : 175 (mm)  
OD 1 : 93 (mm)  
Thread Size : 13/16-12 UNF-2B  
Gasket Type : Square

CONT : 12  
VOL : 0.025

193

**FC-5103** Fuel Filter Can-type Housing  
ALLIS CHALMERS 1919100  
MANITOU 49660  
CASE K915319



H 1 : 71 (mm)  
OD 1 : 85 (mm)  
OD 2 : 89 (mm)  
ID 1 : 39 (mm)  
ID 2 : 15 (mm)

CONT : 50  
VOL : 0.036

184

**FC-5723** Fuel Filter Spin-On  
LOMBARDINI 276-2175-046  
VOLVO 7243004-4



H 1 : 122 (mm)  
OD 1 : 76 (mm)  
Thread Size : M16X1.5-6H  
Gasket Type : Square

CONT : 50  
VOL : 0.047

Note : High Performance versions uses FC-25060

189

**FC-6505** Fuel Filter Spin-On  
GENERAL MOTORS 23518528  
GENERAL MOTORS 25011024



H 1 : 228 (mm)  
OD 1 : 118 (mm)  
Thread Size : 1 1/4-12 UNF-2B  
Gasket Type : Square

CONT : 6  
VOL : 0.027

194

**FC-5702** Fuel Filter Spin-On  
MITSUBISHI 32540-20300  
MITSUBISHI 32562-20300  
HITACHI 4085912



H 1 : 175 (mm)  
OD 1 : 93 (mm)  
Thread Size : 1-14 UNS-2B  
Gasket Type : Square

CONT : 12  
VOL : 0.030

Note : Drain nut

185

**FC-57290** Fuel Filter Spin-On High Efficiency  
CUMMINS 4964234



H 1 : 262 (mm)  
OD 1 : 118 (mm)  
Thread Size : 2 1/4-12 UNF-2B

CONT : 6  
VOL : 0.032

190

**FC-6507** Fuel Filter Spin-On With Microfiber media  
DETROIT DIESEL 23518529  
HITACHI E12980183-1



H 1 : 228 (mm)  
OD 1 : 118 (mm)  
Thread Size : 1 1/6-16 UNG-2B  
Gasket Type : Square

CONT : 6  
VOL : 0.028

195

# Sakura Filter

# Technical Specification

**FC-7903** Fuel Filter Secondary Spin-On High Efficiency

J.C.BAMFORD 02/910155  
CUMMINS 3903640  
CUMMINS 3931063



H 1 : 115 (mm)  
OD 1 : 76 (mm)  
Thread Size : M16X1.5-6H  
Gasket Type : Square

CONT : 25  
VOL : 0.023

196

**H-2704** Hydraulic Oil Filter Metal End Cap Element

DAEWOO 2474-9003B  
DAEWOO 2474-9008  
HITACHI 4227353



H 1 : 456 (mm)  
H 2 : 438 (mm)  
OD 1 : 112 (mm)  
OD 2 : 112 (mm)  
ID 1 : 66.1 (mm)  
ID 2 : 66.1 (mm)

CONT : 10  
VOL : 0.079

201

**H-2714** Hydraulic Oil Filter Wire Mesh supported Element

HITACHI 4190987



H 1 : 128 (mm)  
H 2 : 89 (mm)  
OD 1 : 150 (mm)  
OD 2 : 150 (mm)  
ID 1 : 73.4 (mm)

CONT : 9  
VOL : 0.044

206

**FC-9800** Fuel Filter Spin-On

FIAT 01909103  
IVECO 1901605  
FIAT 1909119



H 1 : 185 (mm)  
OD 1 : 108 (mm)  
Thread Size : 3/4-16 UNF-2B  
Gasket Type : Square

CONT : 6  
VOL : 0.019

197

**H-2705** Hydraulic Oil Filter Metal End Cap Element

HITACHI 4225846  
KOBELCO H 403



H 1 : 358 (mm)  
H 2 : 344 (mm)  
OD 1 : 90 (mm)  
OD 2 : 90 (mm)  
ID 1 : 47 (mm)  
ID 2 : 47 (mm)

CONT : 20  
VOL : 0.088

202

**H-2719** Hydraulic Oil Filter Metal End Cap Element Cellulose media

HYUNDAI 31E3-0018  
HITACHI 4294135  
YAMASHIN DT-04-10-10



H 1 : 87 (mm)  
H 2 : 83.5 (mm)  
OD 1 : 42.5 (mm)  
OD 2 : 42.5 (mm)  
ID 1 : 21.5 (mm)

CONT : 50  
VOL : 0.011

Note : Wiremesh type uses H-5211

207

**FS-5701** Fuel Filter Metal body In-Line

CUMMINS 3826094  
NEW HOLLAND (CNH) 86597473



H 1 : 96 (mm)  
OD 1 : 44.5 (mm)  
Inlet : 10 (mm)  
Outlet : 10 (mm)

CONT : 12  
VOL : 0.005

198

**H-2706** Hydraulic Oil Filter Suction Wire Mesh supported Element

YANMAR 172162-73700  
HITACHI 4210224



H 1 : 134.8 (mm)  
H 2 : 128 (mm)  
OD 1 : 150 (mm)  
OD 2 : 150 (mm)  
ID 1 : 87 (mm)  
Thread Size : M10X1.5-6H

CONT : 6  
VOL : 0.028

203

**H-2720** Hydraulic Oil Filter Metal End Cap Element

HITACHI 4488239



H 1 : 111.5 (mm)  
H 2 : 108.5 (mm)  
OD 1 : 42.5 (mm)  
OD 2 : 42.5 (mm)  
ID 1 : 21.5 (mm)

CONT : 50  
VOL : 0.014

208

**H-2702** Hydraulic Oil Filter Metal End Cap Element

DAEWOO 2474-1001  
HITACHI 4159320  
KOBELCO H 409



H 1 : 123.6 (mm)  
H 2 : 113 (mm)  
OD 1 : 73 (mm)  
OD 2 : 73 (mm)  
ID 1 : 34 (mm)  
ID 2 : 34 (mm)

CONT : 50  
VOL : 0.030

199

**H-2709** Hydraulic Oil Filter Metal End Cap Element

KOMATSU 07063-01383  
KOMATSU 208-60-61150  
HITACHI 4287634  
HITACHI 76580323



H 1 : 450 (mm)  
OD 1 : 180 (mm)  
OD 2 : 180 (mm)  
ID 1 : 110 (mm)  
ID 2 : 110 (mm)

CONT : 9  
VOL : 0.173

204

**H-2724** Hydraulic Oil Filter Metal End Cap Element

HITACHI 4656605  
HITACHI 4656608



H 1 : 450 (mm)  
H 2 : 437 (mm)  
OD 1 : 154 (mm)  
OD 2 : 150 (mm)  
ID 1 : 95 (mm)  
ID 2 : 98 (mm)

CONT : 6  
VOL : 0.079

Note : High performance grade uses H-27241

209

**H-2703** Hydraulic Oil Filter Metal End Cap Element

HITACHI 4207841  
HITACHI 4207841A  
HITACHI 4370435



H 1 : 152 (mm)  
H 2 : 146.5 (mm)  
OD 1 : 51 (mm)  
OD 2 : 51 (mm)  
ID 1 : 23.5 (mm)

CONT : 25  
VOL : 0.015

200

**H-2712** Hydraulic Oil Filter Metal End Cap Element

MANITOU 15512-00703  
HITACHI 4294130



H 1 : 52 (mm)  
H 2 : 48.5 (mm)  
OD 1 : 42.5 (mm)  
OD 2 : 42.5 (mm)  
ID 1 : 21.5 (mm)

CONT : 50  
VOL : 0.007

205

**H-2727** Hydraulic Oil Filter Element Cellulose media

HITACHI 4206705  
HITACHI 4287061  
KOMATSU F25701500  
SUMITOMO KRJ 3836



H 1 : 455 (mm)  
H 2 : 450 (mm)  
OD 1 : 150 (mm)  
OD 2 : 150 (mm)  
ID 1 : 110 (mm)  
ID 2 : 110 (mm)

CONT : 6  
VOL : 0.085

210

# Sakura Filter

# Technical Specification

**H-2730** Hydraulic Oil Filter Metal End Cap Element  
HITACHI 4185299



H 1 : 304 (mm)  
H 2 : 254 (mm)  
OD 1 : 140 (mm)  
OD 2 : 140 (mm)  
ID 1 : 20 (mm)  
ID 2 : 20 (mm)

CONT : 4  
VOL : 0.034

211

**H-27410** Hydraulic Oil Filter Plastic Element  
HITACHI E12596702



H 1 : 421 (mm)  
H 2 : 406 (mm)  
OD 1 : 80 (mm)  
OD 2 : 80 (mm)  
ID 1 : 49 (mm)

CONT : 12  
VOL : 0.048

216

**H-7981** Hydraulic Oil Filter Return Metal End Cap Element  
HITACHI 4443773  
HITACHI 4448402  
SUNWARD 730401000068  
SANY B222100000233  
XGMA EF-058



H 1 : 464.5 (mm)  
H 2 : 431 (mm)  
OD 1 : 156 (mm)  
OD 2 : 150 (mm)  
ID 1 : 98 (mm)

CONT : 6  
VOL : 0.078

Note : BPV=1.5 kgf/cm2

221

**H-27360** Hydraulic Oil Filter Wire Mesh supported Element  
HITACHI 4648651



H 1 : 135.5 (mm)  
H 2 : 127 (mm)  
OD 1 : 125 (mm)  
OD 2 : 125 (mm)  
ID 1 : 87 (mm)  
Thread Size : M10X1.5-6H

CONT : 25  
VOL : 0.076

212

**H-5107** Hydraulic Oil Filter Element With Microfiber media  
VOLVO 11707544  
J.C.BAMFORD 32/917701  
J.C.BAMFORD 6900/0084



H 1 : 112 (mm)  
H 2 : 108 (mm)  
OD 1 : 51 (mm)  
OD 2 : 51 (mm)  
ID 1 : 23 (mm)

CONT : 50  
VOL : 0.026

217

**H-85970** Hydraulic Oil Filter Transmission Metal End Cap Element  
ALLISON 23018853  
GENERAL MOTORS 23018853  
ALLISON 23049374  
GENERAL MOTORS 23049374



H 1 : 426.5 (mm)  
H 2 : 424 (mm)  
OD 1 : 95 (mm)  
OD 2 : 95 (mm)  
ID 1 : 55 (mm)

CONT : 12  
VOL : 0.057

222

**H-27380** Hydraulic Oil Filter Return Metal End Cap Element  
HITACHI YA00033065



H 1 : 461.5 (mm)  
H 2 : 431 (mm)  
OD 1 : 154 (mm)  
OD 2 : 150 (mm)  
ID 1 : 98 (mm)

CONT : 6  
VOL : 0.080

Note : BPV=1.5 kgf/cm2

213

**H-5505** Hydraulic Oil Filter Metal End Cap Element  
CATERPILLAR 094-4412  
HITACHI 4219713



H 1 : 455 (mm)  
H 2 : 450 (mm)  
OD 1 : 150 (mm)  
OD 2 : 150 (mm)  
ID 1 : 110 (mm)  
ID 2 : 110 (mm)

CONT : 6  
VOL : 0.081

Note : With outer packing 1 pc

218

**H-85990** Hydraulic Oil Filter Metal End Cap Element With Microfiber media  
PALL HC8904FKS16H



H 1 : 413 (mm)  
H 2 : 400 (mm)  
OD 1 : 104 (mm)  
OD 2 : 97 (mm)  
ID 1 : 62 (mm)

CONT : 12  
VOL : 0.039

223

**H-27390** Hydraulic Oil Filter Return Metal End Cap Element  
HITACHI YA00033064



H 1 : 461.5 (mm)  
H 2 : 431 (mm)  
OD 1 : 150 (mm)  
OD 2 : 154 (mm)  
ID 1 : 98 (mm)

CONT : 6  
VOL : 0.081

214

**H-7911** Hydraulic Oil Filter Metal End Cap Element  
KOMATSU 07063-01210  
KOMATSU 205-60-51430



H 1 : 450 (mm)  
OD 1 : 150 (mm)  
OD 2 : 150 (mm)  
ID 1 : 110 (mm)  
ID 2 : 110 (mm)

CONT : 6  
VOL : 0.080

Note : Without gasket

219

**HC-2701** Hydraulic Oil Filter Transmission Spin-On  
HITACHI 4230376  
HITACHI 4286837  
KOMATSU BW252116



H 1 : 232 (mm)  
H 2 : 213.5 (mm)  
OD 1 : 93 (mm)  
Thread Size : 1-12 UNF-2B  
Thread Nut Size : M24X1.5  
BPV (kg/cm2) : 2.5  
Gasket Type : Square

CONT : 12  
VOL : 0.036

224

**H-27400** Hydraulic Oil Filter Metal End Cap Element  
HITACHI 263E7-52011



H 1 : 183 (mm)  
OD 1 : 150 (mm)  
OD 2 : 150 (mm)  
ID 1 : 110 (mm)  
ID 2 : 110 (mm)

CONT : 0  
VOL : 0.000

215

**H-7912** Hydraulic Oil Filter Metal End Cap Element  
HITACHI 3502410-N  
KOBELCO H 401



H 1 : 291 (mm)  
H 2 : 277 (mm)  
OD 1 : 90 (mm)  
OD 2 : 90 (mm)  
ID 1 : 46.6 (mm)  
ID 2 : 46.6 (mm)

CONT : 20  
VOL : 0.077

220

**HC-2709** Hydraulic Oil Filter Spin-On Cellulose media  
HITACHI 4630525



H 1 : 168 (mm)  
OD 1 : 82.5 (mm)  
Thread Size : M68X2-6H

CONT : 12  
VOL : 0.020

225

# Sakura Filter

# Technical Specification

**HC-27100** Hydraulic Oil Filter Spin-On

HITACHI 4252563  
HITACHI 71497010



H 1 : 147.5 (mm)  
H 2 : 136 (mm)  
OD 1 : 93 (mm)  
Thread Size : 1 1/8-16 UNF-2B

CONT : 12  
VOL : 0.025

226

**HC-7901** Hydraulic Oil Filter Spin-On

INTERNATIONAL HARVESTER  
075912103  
KOBELCO 2446U141S2



H 1 : 130 (mm)  
OD 1 : 93 (mm)  
Thread Size : 1 1/8-16 UNF-2B  
Gasket Type : Round

CONT : 12  
VOL : 0.020

Note : Seat assy zinc coating

231

**O-1505** Oil Filter Full Flow Metal End Cap Element

ISUZU 9-13240098-0  
ISUZU 9-13240106-0  
ISUZU 9-13240106-1



H 1 : 177 (mm)  
H 2 : 161 (mm)  
OD 1 : 104.5 (mm)  
OD 2 : 104 (mm)  
ID 1 : 49 (mm)  
ID 2 : 15 (mm)

CONT : 50  
VOL : 0.111

236

**HC-5602** Hydraulic Oil Filter Spin-On

KOMATSU 113-60-43320  
KOMATSU 113-60-43321  
KOMATSU 209-607-6210  
HITACHI 4205684  
KUBOTA 68773-62230



H 1 : 171 (mm)  
OD 1 : 125 (mm)  
Thread Size : M48X2-6H

CONT : 6  
VOL : 0.026

227

**HC-7913** Hydraulic Oil Filter Spin-On

CLARK 234099  
CATERPILLAR 311980  
J.C.BAMFORD 4110147  
FIAT 906041007



H 1 : 140 (mm)  
OD 1 : 93.5 (mm)  
Thread Size : 2-16 UNF-2B  
Gasket Type : Square

CONT : 12  
VOL : 0.024

232

**O-1506** Oil Filter Full Flow Metal End Cap Element

ISUZU 1-87810059-0  
ISUZU 1-87810059-1  
ISUZU 1-87810065-0



H 1 : 248.5 (mm)  
H 2 : 232 (mm)  
OD 1 : 104.5 (mm)  
OD 2 : 104 (mm)  
ID 1 : 49 (mm)  
ID 2 : 15 (mm)

CONT : 25  
VOL : 0.085

237

**HC-5807** Hydraulic Oil Filter Spin-On

mitsubishi 91004-10021  
YSK IHI-075511900  
mitsubishi LPF 010



H 1 : 141 (mm)  
OD 1 : 93 (mm)  
Thread Size : 1 1/8-16 UNF-2B  
Gasket Type : Round

CONT : 25  
VOL : 0.046

228

**O-1301** Oil Filter Full Flow Metal End Cap Element

ISUZU 1-13240109-1  
NISSAN 15208-61501  
NISSAN 15208-61525  
NISSAN 15208-Z5000  
NISSAN 15208-Z9025



H 1 : 165 (mm)  
H 2 : 160 (mm)  
OD 1 : 104 (mm)  
OD 2 : 104 (mm)  
ID 1 : 15 (mm)  
ID 2 : 49 (mm)

CONT : 50  
VOL : 0.104

233

**O-1510** Oil Filter By Pass Can-type Depth

ISUZU 1-87810050-0  
ISUZU 1-87810050-1  
ISUZU 1-87810050-2



H 1 : 330 (mm)  
H 2 : 297 (mm)  
OD 1 : 164 (mm)  
OD 2 : 164 (mm)  
Thread Size : M16X1.0-6H

CONT : 6  
VOL : 0.072

238

**HC-69031** Hydraulic Oil Filter Spin-On With Microfiber media

HYUNDAI 46321-22015  
INGERSOLL RAND 575129311  
CATERPILLAR 77-5795



H 1 : 147.5 (mm)  
OD 1 : 94 (mm)  
Thread Size : 1 1/2-16 UN-2B

CONT : 12  
VOL : 0.023

Note : 5 micron

229

**O-1310** Oil Filter By Pass Metal End Cap Element

HINO 15607-1350  
HINO 15607-1351  
HINO 15607-1530



H 1 : 218 (mm)  
OD 1 : 122 (mm)  
OD 2 : 122 (mm)  
ID 1 : 17.5 (mm)  
ID 2 : 17.5 (mm)

CONT : 16  
VOL : 0.074

234

**O-1804** Oil Filter By Pass Can-type Depth

NISSAN 15274-90127  
NISSAN 15274-90129  
NISSAN 15274-99428



H 1 : 145 (mm)  
OD 1 : 97 (mm)  
OD 2 : 97 (mm)  
ID 1 : 15 (mm)  
ID 2 : 15 (mm)

CONT : 50  
VOL : 0.099

239

**HC-76130** Hydraulic Oil Filter Transmission Spin-On With Microfiber media

ZF 0501323154  
J.C.BAMFORD 32925905  
CASE 8603535  
CASE 87519452  
JOHN DEERE AT336140



H 1 : 199 (mm)  
OD 1 : 94.5 (mm)  
Thread Size : 1 3/8-12 UNF-2B  
Thread Stud Size : M24X1.5

CONT : 12  
VOL : 0.024

230

**O-1503** Oil Filter Full Flow Metal End Cap Element

ISUZU 13240-085/1  
ISUZU 5-87310336-0  
ISUZU 5-87810239-0



H 1 : 146 (mm)  
H 2 : 143 (mm)  
OD 1 : 83 (mm)  
OD 2 : 83 (mm)  
ID 1 : 17 (mm)  
ID 2 : 17 (mm)

CONT : 50  
VOL : 0.062

235

**O-2701** Oil Filter By Pass Metal End Cap Element

HITACHI 4231195



H 1 : 168 (mm)  
H 2 : 131 (mm)  
OD 1 : 165 (mm)  
OD 2 : 165 (mm)  
Thread Size : M16X2-6H

CONT : 16  
VOL : 0.105

Note : Multi layer version uses O-2709

240

# Sakura Filter

# Technical Specification

**O-2702** Oil Filter By Pass Metal End Cap Element

HINO 15607-1660  
HITACHI 4208241  
HITACHI 4208241-1



H 1 : 192.5 (mm)  
H 2 : 155.5 (mm)  
OD 1 : 165 (mm)  
OD 2 : 165 (mm)  
Thread Size : M16X1.0-6H

CONT : 16  
VOL : 0.116

241

**SF-27010** Fuel/Water Separator Metal End Cap Element

DETROIT DIESEL 23533816  
MACK 301-SD-19B  
ALLIANCE ABP/N10G-FS19624  
HITACHI E12981308



H 1 : 181.5 (mm)  
H 2 : 173.5 (mm)  
OD 1 : 101 (mm)  
OD 2 : 99.5 (mm)  
ID 1 : 16.8 (mm)

CONT : 25  
VOL : 0.064

Note : 7 micron

246

**SFC-5706** Fuel/Water Separator Spin-On

J.C.BAMFORD 02/910150  
J.C.BAMFORD 02/910150A  
HYUNDAI 11E1-70210  
CUMMINS 3935274  
CASE J925274



H 1 : 163.7 (mm)  
H 2 : 134 (mm)  
OD 1 : 93 (mm)  
OD 2 : 92.7 (mm)  
Thread Size : 13/16-18 UNF-2B  
Thread Nut Size : M14X2  
Gasket Type : Square

CONT : 12  
VOL : 0.021

251

**O-2703** Oil Filter Full Flow Metal End Cap Element

HITACHI 4507886



H 1 : 152.6 (mm)  
H 2 : 146 (mm)  
OD 1 : 104 (mm)  
OD 2 : 104 (mm)  
ID 1 : 15 (mm)  
ID 2 : 15 (mm)

CONT : 25  
VOL : 0.063

242

**SFC-5301-10** Fuel/Water Separator Spin-On 10 Micron

MERCEDES-BENZ 000 470 04 69  
MERCEDES-BENZ A 000 470 04 69  
MERCEDES-BENZ A 000 477 13 02  
MERCEDES-BENZ R90-MER-01



H 1 : 217 (mm)  
OD 1 : 108 (mm)  
Thread Size : 1-14 UNS-2B

CONT : 6  
VOL : 0.022

Note : bowl not included

247

**SFC-5707** Fuel/Water Separator Spin-On With Drain Plug

MTU 0010925601  
CUMMINS 3309437  
CUMMINS 3313304  
HITACHI 4202934



H 1 : 311.4 (mm)  
H 2 : 286 (mm)  
OD 1 : 115.5 (mm)  
Thread Size : 1 1/4-12 UNF-2B  
Gasket Type : Square

CONT : 6  
VOL : 0.036

252

**O-5704** Oil Filter By Pass Can-type Depth

CUMMINS 101855  
SUMITOMO 136750  
CUMMINS 256838



H 1 : 382 (mm)  
H 2 : 376 (mm)  
OD 1 : 197 (mm)  
OD 2 : 197 (mm)  
ID 1 : 22 (mm)  
ID 2 : 22 (mm)

CONT : 6  
VOL : 0.111

243

**SFC-5301-10B** Fuel/Water Separator Spin-On With Bowl 10 Micron

MERCEDES-BENZ 000 470 04 69  
MERCEDES-BENZ A 000 470 04 69  
MERCEDES-BENZ R90-MER-01



H 1 : 308 (mm)  
H 2 : 217 (mm)  
OD 1 : 108 (mm)  
Thread Size : 1-14 UNS-2B

CONT : 6  
VOL : 0.029

Note : SFC-5301-10 and FB-1813

248

**SFC-5709-10** Fuel/Water Separator Spin-On 10 Micron

CATERPILLAR 256-8753  
CUMMINS 3329289  
HITACHI 4377880



H 1 : 245 (mm)  
OD 1 : 93 (mm)  
Thread Size : 1-14 UNS-2B  
Gasket Type : Square

CONT : 6  
VOL : 0.019

253

**O-6503** Oil Filter Full Flow Metal End Cap Element

GENERAL MOTORS 357304  
GENERAL MOTORS 5573014  
GENERAL MOTORS 5573102



H 1 : 231 (mm)  
H 2 : 227 (mm)  
OD 1 : 109.5 (mm)  
OD 2 : 109.5 (mm)  
ID 1 : 37 (mm)  
ID 2 : 37 (mm)

CONT : 12  
VOL : 0.043

Note : Metal Protector

244

**SFC-5601-02** Fuel/Water Separator Spin-On High Efficiency

CUMMINS 3089916  
KOMATSU 600-311-3110  
KOMATSU 600-311-3111  
KOMATSU 600-319-3111A



H 1 : 311.4 (mm)  
H 2 : 286 (mm)  
OD 1 : 118 (mm)  
Thread Size : 1 1/4-12 UNF-2B

CONT : 6  
VOL : 0.039

Note : High efficiency filter for high pressure fuel injection systems

249

**SFC-5711** Fuel/Water Separator Spin-On

CUMMINS 3973233  
CASE 87356193  
NEW HOLLAND (CNH) 87356194



H 1 : 164 (mm)  
OD 1 : 93 (mm)  
Thread Size : 1-14 UNS-2B  
Gasket Type : Square

CONT : 12  
VOL : 0.032

254

**SF-1912-30** Fuel/Water Separator Primary Plastic Element 30 Micron

HITACHI 4448737



H 1 : 244 (mm)  
OD 1 : 111 (mm)  
OD 2 : 128 (mm)  
ID 1 : 16.5 (mm)  
ID 2 : 21.15 (mm)

CONT : 25  
VOL : 0.116

245

**SFC-5705** Fuel/Water Separator Spin-On

ISUZU 1-13240044-1  
CUMMINS 3308638  
CUMMINS 3315843  
SUNWARD 75020101130



H 1 : 174 (mm)  
OD 1 : 93 (mm)  
Thread Size : 1-14 UNS-2B  
Gasket Type : Square

CONT : 12  
VOL : 0.026

250

**WC-5703** Coolant Filter Spin-On

CUMMINS 3318319  
HITACHI 4266063  
KOMATSU 6742-01-3490



H 1 : 136 (mm)  
OD 1 : 93 (mm)  
Thread Size : 11/16-16 UNF-2B  
Gasket Type : Square

CONT : 12  
VOL : 0.018

Note : Coolants = 23 units

255

**WC-5705**

Coolant Filter Spin-On

CUMMINS 299080  
 CUMMINS 3100304  
 CUMMINS 3305367



H 1 : 100 (mm)  
 OD 1 : 93 (mm)  
 Thread Size : 11/16-16 UNF-2B  
 Gasket Type : Square

CONT : 12  
 VOL : 0.018

Note : Coolants = 4 units

256

**WC-5708**

Coolant Filter Spin-On

GENERAL MOTORS 23507189  
 FIAT 4393504  
 CASE 441365C1



H 1 : 136 (mm)  
 OD 1 : 93 (mm)  
 Thread Size : 11/16-16 UNF-2B  
 Gasket Type : Square

CONT : 12  
 VOL : 0.027

Note : Coolant = 15 units

257

**WC-5711**

Coolant Filter Spin-On

CUMMINS 3315115  
 CUMMINS 3316462  
 CUMMINS 4058964



H 1 : 100 (mm)  
 OD 1 : 93 (mm)  
 Thread Size : 11/16-16 UNF-2B  
 Gasket Type : Square

CONT : 12  
 VOL : 0.014

Note : Coolants = 8 units

258

**WC-5712**

Coolant Filter Spin-On

CUMMINS 3100307  
 CUMMINS 3315114  
 CUMMINS 3316053



H 1 : 135 (mm)  
 OD 1 : 93 (mm)  
 Thread Size : 11/16-16 UNF-2B  
 Gasket Type : Square

CONT : 12  
 VOL : 0.020

Note : Coolants = 12 units

259

**WC-5713**

Coolant Filter Spin-On

HITACHI 4228689  
 INGERSOLL RAND 57165805



H 1 : 136 (mm)  
 OD 1 : 93 (mm)  
 Thread Size : 11/16-16 UNF-2B  
 Gasket Type : Square

CONT : 12  
 VOL : 0.022

Note : Coolants = 15 units

260