



SAKURA

KOBELCO

FILTER SUB-CATALOGUE





Table of Contents

Engine Application

A

Technical Specification

B



Engine Application

A

MODEL/APPLICATION	SAKURA NO	MODEL/APPLICATION	SAKURA NO	MODEL/APPLICATION	SAKURA NO
KOBELCO		KOBELCO		KOBELCO	
45SR-2 (EXCAVATORS) w/Yanmar 2.2L (133 CID) Eng , 2200		K903C (EXCAVATORS) ISUZU 4JB1 (S/N: LE5701-6600)		Hydraulic Oil Filter.....	H-5211
Hydraulic Oil Filter.....	H-5519	Air Filter Primary.....	AS-5620	K904LC II (EXCAVATORS) ISUZU 4BD1	
50SR (EXCAVATORS) YANMAR 4TNV88-BXYB		Fuel Filter.....	FC-1801	Hydraulic Oil Filter.....	H-7919
Air Filter Breather.....	A-41050	Hydraulic Oil Filter.....	H-5211	K904LC II (EXCAVATORS) ISUZU 4BD1 (S/N: LX1501-UP)	
Air Filter.....	A-8581	K903 II (EXCAVATORS) ISUZU 4JB1		Air Filter Primary.....	AS-7805
Air Filter Secondary.....	A-41060	Hydraulic Oil Filter.....	H-7919	Air Filter Secondary.....	A-6008
Air Filter Set.....	A-41070-S	K903 II (EXCAVATORS) ISUZU 4JB1 (S/N: LE6601-7871)		Air Filter Set.....	AS-5656-S
Fuel Filter.....	FC-52050	Air Filter Primary.....	AS-5620	Hydraulic Oil Filter.....	H-5211
7065 (CRANES) MITSUBISHI 6D22		Fuel Filter.....	FC-1801	K905 (EXCAVATORS) ISUZU 6BB1	
Air Filter Secondary.....	A-6008	Hydraulic Oil Filter.....	H-5211	Hydraulic Oil Filter.....	H-7919
Fuel Filter.....	FC-1005	K903 II (EXCAVATORS) ISUZU 4JB1 (S/N: LE7872-11000)		K905 (EXCAVATORS) ISUZU 6BB1 (S/N: LP0004-0554)	
Hydraulic Oil Filter.....	H-5211	Air Filter Secondary.....	A-7919	Air Filter Primary.....	A-5628
Hydraulic Oil Filter.....	HC-7901	Fuel Filter.....	FC-1801	Air Filter Primary.....	AS-5628
Oil Filter Full Flow.....	O-1010	Hydraulic Oil Filter.....	H-5211	Air Filter Set.....	A-5628-S
70SR (EXCAVATORS) ISUZU A-4JB1		K904C (EXCAVATORS) MITSUBISHI 6D14C (S/N: K13609-13609)		Hydraulic Oil Filter.....	H-5211
Fuel Filter.....	FC-5616	Air Filter Secondary.....	A-6009	Oil Filter Full Flow.....	O-1301
CKE1350-1F (CRANES) HINO EA-P11C-UN-UN 10595 , 2006		Hydraulic Oil Filter.....	H-5609	K905 (EXCAVATORS) ISUZU 6BB1 (S/N: LP0601-1600)	
Oil Filter By Pass.....	EO-13040	Oil Filter Combination.....	O-1006	Air Filter Primary.....	A-5628
E80 (EXCAVATORS) ISUZU A-4JB1 , 2004-UP		K904C (EXCAVATORS) MITSUBISHI 6D14C (S/N: LW5269-5800)		Air Filter Primary.....	AS-5628
Air Filter Primary.....	A-8505	Air Filter Secondary.....	A-6009	Air Filter Set.....	A-5628-S
Air Filter Secondary.....	A-8599	Hydraulic Oil Filter.....	H-5609	Hydraulic Oil Filter.....	H-5211
Fuel Filter.....	FC-1801	Oil Filter Combination.....	O-1006	Oil Filter Full Flow.....	O-1301
E80MSR (EXCAVATORS) ISUZU , 2005-UP		K904D (EXCAVATORS) ISUZU 4BD1		K905A,ALC (EXCAVATORS) ISUZU 4BD1	
Air Filter Primary.....	A-8505	Hydraulic Oil Filter.....	H-7919	Hydraulic Oil Filter.....	H-7919
Air Filter Secondary.....	A-8599	K904D (EXCAVATORS) ISUZU 4BD1 (S/N: LW5801-7800)		K905A,ALC (EXCAVATORS) ISUZU 4BD1 (S/N: LP1601-UP)	
Fuel Filter.....	FC-1801	Air Filter Primary.....	A-5628	Air Filter Secondary.....	A-6009
Oil Filter Full Flow.....	C-1511	Air Filter Primary.....	AS-5628	Hydraulic Oil Filter.....	H-5211
Oil Filter Full Flow.....	C-1538	Air Filter Set.....	A-5628-S	Oil Filter Full Flow.....	O-1301
ED180 (BLADE) CUMMINS 4BTA3.9 S/N: YLU00001-UP , 2004-UP		Hydraulic Oil Filter.....	H-5211	K905A,ALC (EXCAVATORS) ISUZU 4BD1 (S/N: YP0301-UP)	
Fuel Filter Secondary.....	FC-7903	Oil Filter Full Flow.....	O-1301	Air Filter Secondary.....	A-6009
Fuel/Water Separator.....	SFC-5706	K904E (EXCAVATORS) ISUZU 4BD1		Hydraulic Oil Filter.....	H-5211
Fuel/Water Separator Secondary..	SFC-1905-10	Hydraulic Oil Filter.....	H-7919	Oil Filter Full Flow.....	O-1301
K903B (EXCAVATORS) ISUZU C240		K904E (EXCAVATORS) ISUZU 4BD1 (S/N: LW7801-UP)		K905A,LC (EXCAVATORS) ISUZU 4BD1 (S/N: KP1601-UP)	
Hydraulic Oil Filter.....	H-7919	Air Filter Primary.....	A-5628	Air Filter Secondary.....	A-6009
Oil Filter Full Flow.....	C-1507	Air Filter Primary.....	AS-5628	Hydraulic Oil Filter.....	H-5211
K903B (EXCAVATORS) ISUZU C240 (S/N: LE3401-5700)		Air Filter Set.....	A-5628-S	Oil Filter Full Flow.....	O-1301
Air Filter Primary.....	AS-2205	Hydraulic Oil Filter.....	H-5211	K905A,LC (EXCAVATORS) ISUZU 4BD1 (S/N: YP0301-UP)	
Fuel Filter.....	FC-1801	Oil Filter Full Flow.....	O-1301	Air Filter Secondary.....	A-6009
Hydraulic Oil Filter.....	H-5211	K904 II (EXCAVATORS) ISUZU 4BD1		Hydraulic Oil Filter.....	H-5211
K903B (EXCAVATORS) ISUZU C240		Hydraulic Oil Filter.....	H-7919	Oil Filter Full Flow.....	O-1301
Hydraulic Oil Filter.....	H-5208	K904 II (EXCAVATORS) ISUZU 4BD1 (S/N: YW0101-2800)		K905A,LC (EXCAVATORS) ISUZU 6BB1 (S/N: LP0601-UP)	
K903C (EXCAVATORS) ISUZU 4JB1		Air Filter Primary.....	AS-7805	Air Filter Primary.....	A-5628
Hydraulic Oil Filter.....	H-7919	Air Filter Secondary.....	A-6008	Air Filter Set.....	A-5628-S
		Air Filter Set.....	AS-5656-S	Hydraulic Oil Filter.....	H-5211
				Oil Filter Full Flow.....	O-1301

MODEL/APPLICATION	SAKURA NO	MODEL/APPLICATION	SAKURA NO	MODEL/APPLICATION	SAKURA NO
KOBELCO		KOBELCO		KOBELCO	
K912A (EXCAVATORS) MITSUBISHI 6D22T (S/N: LC2003-2016) Air Filter Primary..... A-10134 Air Filter Secondary..... A-5631 Air Filter Set..... A-1841-S Fuel Filter..... FC-1005 Hydraulic Oil Filter..... H-5211 Hydraulic Oil Filter..... HC-7901		K914 (EXCAVATORS) MITSUBISHI 8DC6 (S/N: LR0117-LR0142) Air Filter Primary..... A-2210 K914 (EXCAVATORS) MITSUBISHI 8DC8 (S/N: LR0146-LR0185) Air Filter Secondary..... A-6008 Fuel Filter..... F-2604 Hydraulic Oil Filter..... H-5211		K935 (EXCAVATORS) MITSUBISHI 6D22C (S/N: LU0146-UP) Air Filter Secondary..... A-6008 Fuel Filter..... FC-1005 Hydraulic Oil Filter..... H-5211 Hydraulic Oil Filter..... H-5609 KW904 (EXCAVATORS) ISUZU 6BB1 Hydraulic Oil Filter..... H-7919 KW904 (EXCAVATORS) ISUZU 6BB1 (S/N: YD01012-UP) Air Filter Primary..... A-5628 Air Filter Primary..... AS-5628 Air Filter Set..... A-5628-S Hydraulic Oil Filter..... H-5211 Oil Filter Full Flow..... O-1301	
K912A,ALC (EXCAVATORS) MITSUBISHI 6D22CT (S/N: LC2017-2300) Air Filter Secondary..... A-6008 Fuel Filter..... FC-1005 Hydraulic Oil Filter..... H-5211 Hydraulic Oil Filter..... HC-7901		K914 (EXCAVATORS) MITSUBISHI 8DC8 (S/N: LR0186-UP) Air Filter Secondary..... A-6008 Fuel Filter..... FC-1005 Hydraulic Oil Filter..... H-5211		KW904 (EXCAVATORS) ISUZU 6BB1 (S/N: YD01012-UP) Air Filter Primary..... A-5628 Air Filter Primary..... AS-5628 Air Filter Set..... A-5628-S Hydraulic Oil Filter..... H-5211 Oil Filter Full Flow..... O-1301	
K912A,ALC (EXCAVATORS) MITSUBISHI 6D22CT (S/N: YC0103-0300) Air Filter Secondary..... A-6008 Fuel Filter..... FC-1005 Hydraulic Oil Filter..... H-5211 Hydraulic Oil Filter..... HC-7901		K916LC (EXCAVATORS) MITSUBISHI 6D22CT (S/N: YS0119-YS0200) Air Filter Primary..... A-1013 Air Filter Primary..... A-10134 Air Filter Secondary..... A-5631 Air Filter Set..... A-1841-S Fuel Filter..... FC-1005 Hydraulic Oil Filter..... HC-7901		LF600 (EXCAVATORS) NISSAN UD PD604 Air Filter Primary..... AS-1024 Air Filter Set..... AS-1024-S Fuel Filter..... F-1803 Oil Filter By Pass..... O-18051 Oil Filter Combination..... O-1809	
K912LCII (EXCAVATORS) MITSUBISHI 6D22T (S/N: YC0301-YC0737) Air Filter Primary..... A-1013 Air Filter Primary..... A-10134 Air Filter Secondary..... A-5631 Air Filter Set..... A-1841-S Fuel Filter..... FC-1005 Hydraulic Oil Filter..... H-5211 Hydraulic Oil Filter..... HC-7901		K916LC (EXCAVATORS) MITSUBISHI 6D22CT (S/N: LS0007-UP) Air Filter Primary..... A-1013 Air Filter Primary..... A-10134 Air Filter Secondary..... A-5631 Air Filter Set..... A-1841-S Fuel Filter..... FC-1005 Hydraulic Oil Filter..... HC-7901		LK300A (LOADERS) MITSUBISHI 6DR5C Air Filter Primary..... AS-7805 Air Filter Secondary..... A-7806 Air Filter Set..... AS-5656-S Fuel Filter..... FC-1002 Fuel Filter..... FC-10022	
K912LCII (EXCAVATORS) MITSUBISHI 6D22CT (S/N: LC2301-UP) Air Filter Primary..... A-1013 Air Filter Primary..... A-10134 Air Filter Secondary..... A-5631 Air Filter Set..... A-1841-S Hydraulic Oil Filter..... H-5211 Hydraulic Oil Filter..... HC-7901		K916LCII (EXCAVATORS) MITSUBISHI 6D22CT (S/N: YS0201-UP) Air Filter Primary..... A-28710 Air Filter Secondary..... A-7967 Air Filter Set..... A-28730-S Fuel Filter..... FC-1005 Hydraulic Oil Filter..... H-5211		LK350-II (LOADERS) Air Filter Primary..... AS-7805 Air Filter Secondary..... A-6008 Air Filter Set..... AS-5656-S	
K912LCII (EXCAVATORS) MITSUBISHI 6D22CT (S/N: YC0301-UP) Air Filter Primary..... A-1013 Air Filter Primary..... A-10134 Air Filter Secondary..... A-5631 Air Filter Set..... A-1841-S Hydraulic Oil Filter..... H-5211 Hydraulic Oil Filter..... HC-7901		K935 (EXCAVATORS) GMC 6-71N (S/N: L70129-LU0085) Air Filter Primary..... A-6113 Air Filter Secondary..... A-5408 Fuel Filter..... F-6503 Fuel Filter..... F-7302 Hydraulic Oil Filter..... H-5211 Hydraulic Oil Filter..... H-5609 Oil Filter Full Flow..... O-6503		LK500 (LOADERS) NISSAN FD6T04 Air Filter Primary..... AS-1024 Air Filter Secondary..... A-6009 Air Filter Set..... AS-1024-S Oil Filter Full Flow..... O-1301	
K914 (EXCAVATORS) GMC 8V-71 (S/N: LR0143-LR0145) Air Filter Primary..... A-5618 Air Filter Secondary..... A-5610 Fuel Filter Primary..... FC-6501 Fuel Filter Secondary..... FC-6502 Hydraulic Oil Filter..... H-5211 Oil Filter Full Flow..... C-7005		K935 (EXCAVATORS) MITSUBISHI 6D22C (S/N: L70106-L70124) Air Filter Secondary..... A-6008 Fuel Filter..... F-1008 Hydraulic Oil Filter..... H-5211 Hydraulic Oil Filter..... H-5609		LK600 (LOADERS) DETROIT DIESEL Fuel Filter Primary..... FC-6501 Fuel Filter Secondary..... FC-6502 Oil Filter Full Flow..... C-7005	
K914 (EXCAVATORS) MITSUBISHI 8DC6 (S/N: L60103-L60216) Air Filter Primary..... A-2210		K935 (EXCAVATORS) MITSUBISHI 6D22C (S/N: LU0086-LU0145) Air Filter Secondary..... A-6008 Fuel Filter..... FC-1005 Hydraulic Oil Filter..... H-5211 Hydraulic Oil Filter..... H-5609		LK700 (LOADERS) GMC 6-71 Air Filter Primary..... A-5618 Air Filter Secondary..... A-5610 Fuel Filter..... F-6503 Fuel Filter..... F-7302	
				MD120 (EXCAVATORS) KOBELCO Air Filter..... AS-1010 Fuel Filter..... FC-1002 Fuel Filter..... FC-10022	

MODEL/APPLICATION	SAKURA NO	MODEL/APPLICATION	SAKURA NO	MODEL/APPLICATION	SAKURA NO
KOBELCO		KOBELCO		KOBELCO	
MD120 (EXCAVATORS) KOBELCO		Air Filter Primary.....	A-2210	SK025SR (EXCAVATORS) YANMAR 3TNE78A-YBB (S/N: PV10001-UP)	
Oil Filter By Pass.....	C-1006	Air Filter Secondary.....	A-6008	Air Filter.....	AS-1824
MD140 (EXCAVATORS) KOBELCO		Oil Filter Full Flow.....	O-1010	Fuel Filter.....	F-5207
Air Filter Primary.....	A-6113	MD320 (EXCAVATORS) KOBELCO		Fuel Filter.....	F-5214
Air Filter Secondary.....	A-6009	Air Filter Primary.....	A-1013	Oil Filter Full Flow.....	C-8012
MD140BLC (EXCAVATORS) MITSUBISHI 4D31T (S/N: YP1001-YPU0300)		Air Filter Primary.....	A-10134	SK027 (EXCAVATORS) YANMAR 3TN84TL-RTBA/B (S/N: PW00003-PW01634)	
Air Filter Primary.....	AS-1024	Air Filter Secondary.....	A-5631	Air Filter Primary.....	AS-2205
Air Filter Secondary.....	A-6009	Air Filter Set.....	A-1841-S	Fuel Filter.....	F-5210
Air Filter Set.....	AS-1024-S	MD400 (EXCAVATORS) KOBELCO		Oil Filter Full Flow.....	C-8012
Fuel Filter.....	FC-1703	Air Filter Primary.....	A-1013	SK030 (EXCAVATORS) YANMAR 3TN84L-RTBB/C (S/N: PW03001-PW04400)	
Hydraulic Oil Filter.....	H-5211	Air Filter Primary.....	A-10134	Air Filter Primary.....	AS-2205
MD140CLC (EXCAVATORS) ISUZU 4BD1T (S/N: YPU0301-1000)		Air Filter Secondary.....	A-5631	Fuel Filter.....	F-5210
Air Filter Primary.....	A-5627	Air Filter Set.....	A-1841-S	Fuel Filter.....	F-5214
Air Filter Secondary.....	A-6008	MD450 (EXCAVATORS) KOBELCO		Oil Filter Full Flow.....	C-8012
Air Filter Set.....	A-5663-S	Air Filter Primary.....	A-28710	SK030-2 (EXCAVATORS) YANMAR 3TNE84	
MD180 (EXCAVATORS) KOBELCO		Air Filter Secondary.....	A-7967	Hydraulic Oil Filter.....	H-5634
Air Filter Primary.....	A-6113	Air Filter Set.....	A-28730-S	SK030-2 (EXCAVATORS) YANMAR 3TNE84-YBB/C (S/N: PW04401-UP)	
Fuel Filter.....	FC-1010	SH60 (EXCAVATORS) ISUZU 41B1		Air Filter Primary.....	AS-2205
Oil Filter Combination.....	O-1006	Oil Filter Full Flow.....	C-1511	Fuel Filter.....	F-5210
MD180LC (EXCAVATORS) MITSUBISHI 6D14T (S/N: YG00647-UP)		Oil Filter Full Flow.....	C-1538	Fuel Filter.....	F-5214
Air Filter Primary.....	AS-1024	SK007 (EXCAVATORS) YANMAR 2TN66L-UTBA (S/N: PT00003-PT01020)		Oil Filter Full Flow.....	C-8012
Air Filter Set.....	AS-1024-S	Fuel Filter.....	F-5207	SK035 (EXCAVATORS) YANMAR 3TN84L-RTBB/C (S/N: PX01201-PX02100)	
Hydraulic Oil Filter.....	H-5211	Oil Filter Full Flow.....	C-5205	Air Filter Primary.....	AS-2205
Oil Filter Combination.....	O-1006	SK007-2 (EXCAVATORS) YANMAR 2TN66L-UTBA (S/N: PT01100-UP)		Fuel Filter.....	F-5207
MD120LC (EXCAVATORS) MITSUBISHI 4D31T (S/N: YP0417-UP)		Fuel Filter.....	F-5207	Fuel Filter.....	F-5214
Fuel Filter.....	FC-1703	Oil Filter Full Flow.....	C-5205	Oil Filter Full Flow.....	C-8012
Hydraulic Oil Filter.....	H-5211	SK015 (EXCAVATORS) YANMAR 3TNA72L-UTBB (S/N: PU02001-UP)		SK035-2 (EXCAVATORS) YANMAR 3TNE84-YBB/C (S/N: PX02101-UP)	
MD200 (EXCAVATORS) KOBELCO		Fuel Filter.....	F-5207	Air Filter Primary.....	AS-2205
Air Filter Primary.....	A-5627	Oil Filter Full Flow.....	C-5205	Fuel Filter.....	F-5210
Air Filter Set.....	A-5663-S	SK015SR (EXCAVATORS) YANMAR 3TNE72L-UYBB (S/N: PU06001-UP)		Fuel Filter.....	F-5214
Fuel Filter.....	FC-1010	Fuel Filter.....	F-5207	Oil Filter Full Flow.....	C-8012
Oil Filter Full Flow.....	C-1009	Oil Filter Full Flow.....	C-5205	SK035SR (EXCAVATORS) YANMAR 3TNE84-YBD (S/N: PX05001-PX05600)	
MD200CLC (EXCAVATORS) MITSUBISHI 6D31T (S/N: YQU0401-0700)		SK024 (EXCAVATORS) YANMAR 3TN84L-RTBA (S/N: PV00003-PV02536)		Air Filter Primary.....	A-8513
Air Filter Primary.....	A-5627	Air Filter Primary.....	AS-2205	Oil Filter Full Flow.....	C-8012
Air Filter Secondary.....	A-6008	Fuel Filter.....	F-5210	SK035SR (EXCAVATORS) YANMAR 3TNE82A-YBB (S/N: PX05600-UP)	
Air Filter Set.....	A-5663-S	SK025 (EXCAVATORS) YANMAR 3TNC78L-RTBA (S/N: PV04301-PV06200)		Air Filter.....	AS-1824
Hydraulic Oil Filter.....	H-5211	Air Filter.....	AS-1824	Fuel Filter.....	F-5210
Oil Filter Full Flow.....	C-5505	Fuel Filter.....	F-5207	Fuel Filter.....	F-5214
MD240 (EXCAVATORS) KOBELCO		Fuel Filter.....	F-5214	Oil Filter Full Flow.....	C-8012
Air Filter Primary.....	A-2210	Oil Filter Full Flow.....	C-8012	SK045SR (EXCAVATORS) YANMAR 4TNE88-YBB	
Air Filter Primary.....	A-5639	SK025-2 (EXCAVATORS) YANMAR 3TNE78A-YB (S/N: PV06201-UP)		Air Filter Primary.....	A-8513
Air Filter Secondary.....	A-5635	Air Filter.....	AS-1824	Fuel Filter.....	F-5210
Air Filter Set.....	A-5654-S	Fuel Filter.....	F-5207	Fuel Filter.....	F-5214
Hydraulic Oil Filter.....	HC-7901	Fuel Filter.....	F-5214	Oil Filter Full Flow.....	C-8012
MD300 (EXCAVATORS) KOBELCO		Oil Filter Full Flow.....	C-8012	SK04-2 (EXCAVATORS) ISUZU 4BD1	

MODEL/APPLICATION	SAKURA NO	MODEL/APPLICATION	SAKURA NO	MODEL/APPLICATION	SAKURA NO
KOBELCO		KOBELCO		KOBELCO	
SK04-2 (EXCAVATORS) ISUZU 4BD1 Hydraulic Oil Filter.....	H-7919	Air Filter Primary.....	A-5627	Fuel/Water Separator.....	SFC-5706
SK04L-2 (EXCAVATORS) ISUZU 4BD1 Hydraulic Oil Filter.....	H-7919	Air Filter Secondary.....	A-6008	Fuel/Water Separator Secondary...	SFC-1905-10
SK100 (EXCAVATORS) CUMMINS 4BT3.9 Hydraulic Oil Filter.....	H-7919	Air Filter Set.....	A-5663-S	Oil Filter Full Flow.....	C-5703
SK100 (EXCAVATORS) ISUZU 4BD1 Hydraulic Oil Filter.....	H-7919	SK120LC (EXCAVATORS) ISUZU 4BD1T (S/N: YPU0570-UP) Air Filter Primary.....	AS-5523	SK130UR (EXCAVATORS) S/N: YX02-01001-UP Fuel Filter.....	FC-1801
SK100 (EXCAVATORS) ISUZU 4BD1 (S/N: YW2801-YW4600) Air Filter Primary.....	A-5627	SK120LC III (EXCAVATORS) ISUZU 4BD1T (S/N: YPU0301-0569) Air Filter Primary.....	A-5627	Oil Filter By Pass.....	C-15680
Air Filter Secondary.....	A-6008	Air Filter Secondary.....	A-6008	Oil Filter Full Flow.....	C-2702
Air Filter Set.....	A-5663-S	Air Filter Set.....	A-5663-S	SK135SRLC (EXCAVATORS) ISUZU 4BG1T , 2004-UP Air Filter Primary.....	A-5541
Hydraulic Oil Filter.....	H-5211	Hydraulic Oil Filter.....	H-5211	Air Filter Primary.....	A-5541M
SK100 (EXCAVATORS) ISUZU 4BD1 (S/N: YW4601-UP) Air Filter Primary.....	A-5627	SK120LC III (EXCAVATORS) ISUZU 4BD1T (S/N: YP01994-UP) Air Filter Primary.....	A-5627	Air Filter Primary.....	A-76231
Air Filter Secondary.....	A-6008	Air Filter Secondary.....	A-6008	Air Filter Secondary.....	A-5540
Air Filter Set.....	A-5663-S	Air Filter Set.....	A-5663-S	Air Filter Set.....	A-5541M-S
Hydraulic Oil Filter.....	H-5211	SK120LC III (EXCAVATORS) ISUZU 4BD1T (S/N: YPU0570-1000) Air Filter Primary.....	AS-5523	Fuel Filter.....	FC-1801
SK100 (EXCAVATORS) ISUZU 4BD1 (S/N: YW4601-UP) Air Filter Primary.....	A-5627	SK120LC IV (EXCAVATORS) CUMMINS 4BT3.9L Hydraulic Oil Filter.....	H-7919	Oil Filter By Pass.....	C-15680
Air Filter Secondary.....	A-6008	SK120LC IV (EXCAVATORS) CUMMINS 4BT3.9 (S/N: YPU1001-1600) Air Filter Primary.....	AS-5523	Oil Filter Full Flow.....	C-2702
Air Filter Set.....	A-5663-S	Fuel Filter Secondary.....	FC-7903	SK150 (EXCAVATORS) Air Filter Primary.....	A-5627
SK100 ACERA (EXCAVATORS) ISUZU 4BD1 (S/N: LX10101-10160) Air Filter Secondary.....	A-7004	Fuel/Water Separator Secondary...	SFC-1905-10	Air Filter Secondary.....	A-6008
SK100 ACERA (EXCAVATORS) ISUZU 4BD1 (S/N: YW06501-07744) Air Filter Secondary.....	A-7004	Oil Filter Full Flow.....	C-5703	Air Filter Set.....	A-5663-S
SK100IV (EXCAVATORS) CUMMINS 4BT3.9 (S/N: YWU1001-1155) Air Filter Primary.....	AS-5523	SK120LC IV (M,C) (EXCAVATORS) CUMMINS 4BT3.9 (S/N: LPU1001-UP) Air Filter Primary.....	AS-5523	SK150LC III (EXCAVATORS) ISUZU 4BD1T (S/N: YM000099-UP) Air Filter Primary.....	A-5627
Fuel Filter Secondary.....	FC-7903	Fuel Filter Secondary.....	FC-7903	Air Filter Secondary.....	A-6008
Fuel/Water Separator.....	SFC-5706	Fuel/Water Separator Secondary...	SFC-1905-10	Air Filter Set.....	A-5663-S
Oil Filter Full Flow.....	C-5703	Oil Filter Full Flow.....	C-5703	SK150LC IV (EXCAVATORS) CUMMINS 4BTA3.9 (S/N: YMU1001-1500) Air Filter Primary.....	AS-5523
SK115DZLC (EXCAVATORS) CUMMINS 4BT3.9 Hydraulic Oil Filter.....	H-7919	SK120LC IV (M,C) (EXCAVATORS) CUMMINS 4BT3.9 (S/N: LPU1001-UP) Air Filter Primary.....	AS-5523	Fuel Filter Secondary.....	FC-7903
SK115DZLC (EXCAVATORS) CUMMINS 4BT3.9 (S/N: LPU5001-UP) Air Filter Primary.....	AS-5523	Fuel Filter Secondary.....	FC-7903	Fuel/Water Separator.....	SFC-5706
Fuel Filter Secondary.....	FC-7903	Fuel/Water Separator Secondary...	SFC-1905-10	Oil Filter Full Flow.....	C-5703
Fuel/Water Separator Secondary...	SFC-1905-10	Oil Filter Full Flow.....	C-5703	SK150LC IV (M,C) (EXCAVATORS) CUMMINS 4BTA3.9 (S/N: YMU1501-UP) Air Filter Primary.....	AS-5523
Oil Filter Full Flow.....	C-5703	SK120LC IV (M,C) (EXCAVATORS) CUMMINS 4BT3.9 (S/N: YPU1601-UP) Air Filter Primary.....	AS-5523	Fuel Filter Secondary.....	FC-7903
SK120LC (EXCAVATORS) ISUZU 4BD1T Hydraulic Oil Filter.....	H-7919	Fuel Filter Secondary.....	FC-7903	Fuel/Water Separator Secondary...	SFC-1905-10
SK120LC (EXCAVATORS) ISUZU 4BD1T (S/N: YPU0301-YPU0359) Air Filter Primary.....	A-5627	Fuel/Water Separator Secondary...	SFC-1905-10	Oil Filter Full Flow.....	C-5703
Air Filter Secondary.....	A-6008	Oil Filter Full Flow.....	C-5703	SK115SR (EXCAVATORS) ISUZU 4BG1 Oil Filter By Pass.....	C-15680
Air Filter Set.....	A-5663-S	SK120LC IV (M,C) (EXCAVATORS) CUMMINS 4BT3.9 (S/N: YPU1601-UP) Air Filter Primary.....	AS-5523	SK135SR (EXCAVATORS) S/N: YX02-01001-UP Oil Filter By Pass.....	C-15680
Hydraulic Oil Filter.....	H-5211	Fuel Filter Secondary.....	FC-7903	SK130-8 (EXCAVATORS) MITSUBISHI D04FR-KDP2TAAC Fuel Filter.....	FC-18052
SK120LC (EXCAVATORS) ISUZU 4BD1T (S/N: YPU0360-YPU0569) Air Filter Primary.....	AS-5523	Fuel/Water Separator Secondary...	SFC-1905-10	Fuel Filter.....	FC-1826
Air Filter Secondary.....	A-7913	Oil Filter Full Flow.....	C-5703	Fuel Filter Primary.....	EF-27014
Fuel Filter Secondary.....	FC-7903	SK130LC IV (EXCAVATORS) CUMMINS 4BT3.9 (S/N: YPU1808-UP) Air Filter Primary.....	AS-5523	SK10SR (EXCAVATORS) YANMAR 3TNV70-WBV Fuel Filter.....	EF-41020

MODEL/APPLICATION	SAKURA NO	MODEL/APPLICATION	SAKURA NO	MODEL/APPLICATION	SAKURA NO
KOBELCO		KOBELCO		KOBELCO	
SK140LC-8 (EXCAVATORS) MITSUBISHI D04FR-74kW		Oil Filter By Pass.....	C-1006	Oil Filter Combination.....	C-5808
Fuel Filter.....	FC-18052	Oil Filter Full Flow.....	C-5505	SK210LC-8 (EXCAVATORS) HINO J05E	
Fuel Filter.....	FC-1826	SK200LC (EXCAVATORS) MITSUBISHI 6D31T (S/N: YQU0501-YQU0700)		Fuel Filter Primary.....	EF-27014
SK200 (EXCAVATORS)		Air Filter Primary.....	A-5627	SK210LC-8 (EXCAVATORS) HINO J005E	
MITSUBISHI 6D34-TE1		Air Filter Secondary.....	A-6008	Fuel Filter Primary.....	EF-27030
Fuel Filter.....	FC-1010	Air Filter Set.....	A-5663-S	SK220LC (EXCAVATORS) MITSUBISHI 6D15T (S/N: LLU0301-LLU0383)	
Oil Filter Combination.....	C-5808	Oil Filter By Pass.....	C-1006	Air Filter Primary.....	A-5639
SK200 (EXCAVATORS)		Oil Filter Full Flow.....	C-5505	Air Filter Secondary.....	A-5635
Cabin Air Filter.....	CA-41030	SK200LC (EXCAVATORS) MITSUBISHI 6D31T (S/N: YQU0701-YQU0834)		Air Filter Set.....	A-5654-S
SK200-2 ACERA (EXCAVATORS) MITSUBISHI 6D31T (S/N: YN18001-22848)		Air Filter Primary.....	A-5627	Hydraulic Oil Filter.....	H-5211
Air Filter Primary.....	A-2706	Air Filter Secondary.....	A-6008	Hydraulic Oil Filter.....	HC-7901
Air Filter Secondary.....	A-2705	Air Filter Set.....	A-5663-S	Oil Filter Combination.....	C-1007
Hydraulic Oil Filter.....	H-7911	SK200LC-III (EXCAVATORS) MITSUBISHI 6D31T (S/N: YQU0701-0834)		SK220LC (EXCAVATORS) MITSUBISHI 6D15T (S/N: LLU0384-LLU0634)	
SK200-2 ACERA (EXCAVATORS) MITSUBISHI 6D31T (S/N: YQ02301-02654)		Air Filter Primary.....	A-5627	Air Filter Primary.....	A-5639
Air Filter Primary.....	A-2706	Air Filter Secondary.....	A-6008	Air Filter Secondary.....	A-5635
Air Filter Secondary.....	A-2705	Air Filter Set.....	A-5663-S	Air Filter Set.....	A-5654-S
Hydraulic Oil Filter.....	H-7911	Hydraulic Oil Filter.....	H-5211	Hydraulic Oil Filter.....	HC-7901
SK200-3 ACERA (EXCAVATORS) MITSUBISHI 6D34T (S/N: YN23301-UP)		Oil Filter Full Flow.....	C-5505	Oil Filter Combination.....	C-1007
Air Filter Primary.....	A-2706	SK200LC-IV (EXCAVATORS) CUMMINS 6BT5.9 (S/N: YNU0201-0395)		SK220LC (EXCAVATORS) MITSUBISHI 6D15T (S/N: LLU0638-UP)	
Air Filter Secondary.....	A-2705	Fuel Filter Secondary.....	FC-7903	Hydraulic Oil Filter.....	HC-7901
Hydraulic Oil Filter.....	H-7911	Fuel/Water Separator.....	SFC-5706	Oil Filter Combination.....	C-1007
SK200-3 ACERA (EXCAVATORS) MITSUBISHI 6D34T (S/N: YNT0001-UP)		Oil Filter Full Flow.....	C-5704	SK220LC-III (EXCAVATORS) MITSUBISHI 6D15T	
Air Filter Primary.....	A-2706	SK200LC-IV (EXCAVATORS) CUMMINS 6BT5.9 (S/N: YQU2001-2962)		Hydraulic Oil Filter.....	H-7969
Air Filter Secondary.....	A-2705	Fuel Filter Secondary.....	FC-7903	SK220LC-III (EXCAVATORS) MITSUBISHI 6D15T (S/N: LLU0301-0383)	
Hydraulic Oil Filter.....	H-7911	Fuel/Water Separator.....	SFC-5706	Air Filter Primary.....	A-5639
SK200-3 ACERA (EXCAVATORS) MITSUBISHI 6D34T (S/N: YQ02801-UP)		Oil Filter Full Flow.....	C-5704	Air Filter Secondary.....	A-5635
Air Filter Primary.....	A-2706	SK200LC-IV (M,C) (EXCAVATORS) CUMMINS 6BTAS.9 (S/N: YNU0501-UP)		Air Filter Set.....	A-5654-S
Air Filter Secondary.....	A-2705	Fuel Filter Secondary.....	FC-7903	Hydraulic Oil Filter.....	H-5211
Hydraulic Oil Filter.....	H-7911	Fuel/Water Separator Secondary... SFC-1905-10		Hydraulic Oil Filter.....	HC-7901
SK200-3 ACERA (EXCAVATORS) MITSUBISHI 6D34T (S/N: YQT0001-UP)		Oil Filter Full Flow.....	C-5704	SK220LC-III (EXCAVATORS) MITSUBISHI 6D15T (S/N: LLU0384-0634)	
Air Filter Primary.....	A-2706	SK200LC-IV (M,C) (EXCAVATORS) CUMMINS 6BTAS.9 (S/N: YQU3101-UP)		Air Filter Primary.....	A-5639
Air Filter Secondary.....	A-2705	Fuel Filter Secondary.....	FC-7903	Air Filter Secondary.....	A-5635
Hydraulic Oil Filter.....	H-7911	Fuel/Water Separator Secondary... SFC-1905-10		Air Filter Set.....	A-5654-S
SK200-8 (EXCAVATORS) HINO J05E		Oil Filter Full Flow.....	C-5704	Hydraulic Oil Filter.....	HC-7901
Cabin Air Filter.....	CA-41010	SK210 (EXCAVATORS) MITSUBISHI		SK220LC-IV (EXCAVATORS) CUMMINS 6BTAS.9 (S/N: LLU1201-1800)	
Cabin Air Filter.....	CA-45050	Fuel Filter.....	FC-1010	Fuel Filter Secondary.....	FC-7903
Cabin Air Filter Set.....	CA-41020-S	Hydraulic Oil Filter.....	H-7911	Fuel/Water Separator.....	SFC-5706
Fuel Filter.....	FC-55241	Oil Filter Combination.....	C-5808	Oil Filter Full Flow.....	C-5704
Fuel Filter Primary.....	EF-27014	SK210LC (EXCAVATORS) CUMMINS (S/N: Y0002001/YNU00201-UP)		SK220LC-IV (EXCAVATORS) CUMMINS 6BTAS.9 (S/N: LQU0101-UP)	
Hydraulic Oil Filter Set.....	H-4101-S	Fuel Filter Secondary.....	FC-7903	Fuel Filter Secondary.....	FC-7903
Hydraulic Oil Filter Set.....	H-41013-S	Fuel/Water Separator.....	SFC-5706	Fuel/Water Separator.....	SFC-5706
SK200LC (EXCAVATORS) MITSUBISHI 6D31T (S/N: YQU0401-YQU0500)		Oil Filter Full Flow.....	C-5704	Oil Filter Full Flow.....	C-5704
Air Filter Primary.....	A-5627	SK210LC (EXCAVATORS) MITSUBISHI (S/N: Y0J00101/YNJ00501-UP)		SK220LC-IV (EXCAVATORS) CUMMINS 6BTAS.9 (S/N: LQU0101-UP)	
Air Filter Secondary.....	A-6008	Air Filter Primary.....	A-5627	Fuel Filter Secondary.....	FC-7903
Air Filter Set.....	A-5663-S	Air Filter Set.....	A-5663-S	Fuel/Water Separator.....	SFC-5706
Hydraulic Oil Filter.....	H-5211	Fuel Filter.....	FC-1010	Oil Filter Full Flow.....	C-5704
		Hydraulic Oil Filter.....	H-7911		

MODEL/APPLICATION	SAKURA NO	MODEL/APPLICATION	SAKURA NO	MODEL/APPLICATION	SAKURA NO
KOBELCO		KOBELCO		KOBELCO	
SK220LC-IV (M,C) (EXCAVATORS) CUMMINS 6BTA5.9 (S/N: LLU1801-UP)		SK260-8 (EXCAVATORS) HINO J05E		SK300LCIV (EXCAVATORS) MITSUBISHI 6D22T (S/N: LCU0001-UP)	
Fuel Filter Secondary.....	FC-7903	Fuel Filter Primary.....	EF-27014	Air Filter Primary.....	A-1013
Fuel/Water Separator Secondary..	SFC-1905-10			Air Filter Primary.....	A-10134
Oil Filter Full Flow.....	C-5704	SK260-8 (EXCAVATORS) HINO J05ETC		Air Filter Secondary.....	A-5631
		Fuel Filter Primary.....	EF-27014	Air Filter Set.....	A-1841-S
SK220LC-IV (M,C) (EXCAVATORS) CUMMINS 6BTA5.9 (S/N: LQU0101-UP)		SK200-10 (EXCAVATORS) HINO J05ETG-KSSG		SK300LCIV (M,C) (EXCAVATORS) CUMMINS 6CTA	
Fuel Filter Secondary.....	FC-7903	Hydraulic Oil Filter.....	H-41100	Fuel Filter Secondary.....	FC-7903
Fuel/Water Separator Secondary..	SFC-1905-10			Fuel/Water Separator Secondary..	SFC-1905-10
Oil Filter Full Flow.....	C-5704	SK200-6 (EXCAVATORS) MITSUBISHI 6D34-TE1		Oil Filter Combination.....	C-5723
		Hydraulic Oil Filter.....	H-5803	SK300LCIV (M,C) (EXCAVATORS) CUMMINS 6CTA8.3 (S/N: LCU0001-UP)	
SK235SR (EXCAVATORS) MITSUBISHI		SK220-3 (EXCAVATORS) MITSUBISHI 6D15T		Fuel Filter Secondary.....	FC-7903
Fuel Filter.....	FC-1010	Hydraulic Oil Filter.....	H-5803	Fuel/Water Separator Secondary..	SFC-1905-10
Oil Filter Combination.....	C-5808	SK250LC-IV (EXCAVATORS) CUMMINS 6BT5.9		Oil Filter Combination.....	C-5723
SK235SR (EXCAVATORS) MITSUBISHI 6D34TEA (S/N: YF00101-UP)		Hydraulic Oil Filter.....	H-7969	SK300LCIV (M,C) (EXCAVATORS) CUMMINS 6CTA8.3 (S/N: YCU0611-UP)	
Air Filter Secondary.....	A-2705	SK27SR-3 (EXCAVATORS) YANMAR 3TNN82A		Fuel Filter Secondary.....	FC-7903
SK250 (EXCAVATORS) 6D34-TLEG		Hydraulic Oil Filter.....	H-41060	Fuel/Water Separator Secondary..	SFC-1905-10
Hydraulic Oil Filter.....	H-8523	SK200SRLC-15 (EXCAVATORS) ISUZU 4BG1TC		Oil Filter Combination.....	C-5723
SK250 (EXCAVATORS)		Fuel Filter.....	F-7930	SK305R-3 (EXCAVATORS) 2009-UP	
Air Filter Primary.....	A-1313	SK300III (EXCAVATORS) MITSUBISHI 6D22CT (S/N: YCU0001-UP)		Air Filter Primary.....	A-8807
Air Filter Set.....	A-5662-S	Air Filter Secondary.....	A-5631	Air Filter Set.....	A-8807-S
SK250LC (EXCAVATORS) MITSUBISHI 6D34		Fuel Filter.....	FC-1005	SK330-8 (EXCAVATORS) HINO , 2009-UP	
Air Filter Primary.....	A-2706	SK300LCIV (EXCAVATORS) CUMMINS 6CTA		Air Filter Primary.....	A-5558
Air Filter Secondary.....	A-2705	Fuel Filter Secondary.....	FC-7903	Air Filter Secondary.....	A-5559
Fuel Filter.....	FC-1010	Fuel/Water Separator.....	SFC-5706	Fuel/Water Separator Primary....	SFC-7912-30
Hydraulic Oil Filter.....	H-7911	Oil Filter Combination.....	C-5723	SK330-10 (EXCAVATORS) J08ETM-KSDL	
Oil Filter Combination.....	C-5808	SK300LCIV (EXCAVATORS) CUMMINS 6CTA8.3 (S/N: YCU0501-0610)		Hydraulic Oil Filter.....	H-41110
SK270LC-IV (EXCAVATORS) CUMMINS 6BTA5.9 (S/N: LBU0001-0200)		Fuel Filter Secondary.....	FC-7903	SK400III (EXCAVATORS) MITSUBISHI 6D22CT (S/N: YSU0001-UP)	
Fuel Filter Secondary.....	FC-7903	Fuel/Water Separator.....	SFC-5706	Air Filter Primary.....	A-28710
Fuel/Water Separator.....	SFC-5706	Oil Filter Combination.....	C-5723	Air Filter Secondary.....	A-7967
Oil Filter Full Flow.....	C-5704	SK300LCIV (EXCAVATORS) CUMMINS 6CTA8.3 (S/N: LCU0001-UP)		Air Filter Set.....	A-28730-S
SK270LC-IV (EXCAVATORS) CUMMINS B5.9C		Fuel Filter Secondary.....	FC-7903	Fuel Filter.....	FC-1005
Hydraulic Oil Filter.....	H-7969	Fuel/Water Separator Secondary..	SFC-1905-10	SK400LCIII (EXCAVATORS) MITSUBISHI 6D22CT (S/N: YSU0001-YSU0200)	
SK270LC-IV (M,C) (EXCAVATORS) CUMMINS 6BTA5.9 (S/N: LBU0201-UP)		Oil Filter Combination.....	C-5723	Air Filter Primary.....	A-28710
Fuel Filter Secondary.....	FC-7903	SK300LCIV (EXCAVATORS) CUMMINS 6CTA8.3 (Excluding S/N: 603, 607)		Air Filter Secondary.....	A-7967
Fuel/Water Separator Secondary..	SFC-1905-10	Fuel Filter Secondary.....	FC-7903	Air Filter Set.....	A-28730-S
Oil Filter Full Flow.....	C-5704	Fuel/Water Separator Secondary..	SFC-1905-10	Fuel Filter.....	FC-1005
SK250-8 (EXCAVATORS) HINO J05E		Oil Filter Combination.....	C-5723	SK400LCIII (EXCAVATORS) MITSUBISHI 6D22CT (S/N: YS0547-UP)	
Cabin Air Filter.....	CA-41010	SK300LCIV (EXCAVATORS) CUMMINS 6CTA8.3 (S/N: LCU0001-UP)		Air Filter Primary.....	A-28710
Cabin Air Filter Set.....	CA-41020-S	Fuel Filter Secondary.....	FC-7903	Air Filter Secondary.....	A-7967
Fuel Filter Primary.....	EF-27014	Fuel/Water Separator Secondary..	SFC-1905-10	Air Filter Set.....	A-28730-S
SK200-8S (EXCAVATORS) HINO J05E		Oil Filter Combination.....	C-5723	SK400LCIV (EXCAVATORS) CUMMINS M11 (S/N: YSU0201-YSU0241)	
Fuel Filter Primary.....	EF-27014	SK300LCIV (EXCAVATORS) MITSUBISHI 6D22T (S/N: YCU0301-0500)		Fuel/Water Separator.....	SFC-5705
SK210-8S (EXCAVATORS) HINO J05E		Air Filter Primary.....	A-1013	Oil Filter Combination.....	C-5723
Fuel Filter Primary.....	EF-27014	Air Filter Primary.....	A-10134	SK400LCIV (EXCAVATORS) CUMMINS MTA11 (S/N: YSU0242-UP)	
		Air Filter Secondary.....	A-5631	Fuel/Water Separator.....	SFC-5705
		Air Filter Set.....	A-1841-S		

MODEL/APPLICATION	SAKURA NO	MODEL/APPLICATION	SAKURA NO
KOBELCO		KOBELCO	
SK400LCIV (EXCAVATORS) CUMMINS MTA11 (S/N: YSU0242-UP) Oil Filter Combination.....	C-5723	SK75-8 (EXCAVATORS) Fuel Filter Primary.....	EF-41010
SK40SR (EXCAVATORS) w/Yanmar 4TNE84 Eng Hydraulic Oil Filter.....	H-5519	SK75SR (EXCAVATORS) Air Filter Primary.....	A-41080
SK40SR (EXCAVATORS) YANMAR 4YNE88 Fuel Filter..... Oil Filter Full Flow.....	F-5210 C-8012		
SK45SR (EXCAVATORS) w/Yanmar 2.2L (133 CID) Eng , 2200 Hydraulic Oil Filter.....	H-5519		
SK45SR-2 (EXCAVATORS) w/Yanmar 2.2L (133 CID) Eng , 2200 Hydraulic Oil Filter.....	H-5519		
SK460-8 (EXCAVATORS) HINO J05E Fuel Filter Primary.....	EF-27014		
SK460-8S (EXCAVATORS) HINO P11C Fuel Filter Primary.....	EF-27014		
SK480-8 (EXCAVATORS) HINO J05E Fuel Filter Primary.....	EF-27014		
SK480-8S (EXCAVATORS) HINO P11C Fuel Filter Primary.....	EF-27014		
SK50SR-3 (EXCAVATORS) YANMAR 4TNV88-XYB , 2200 Air Filter Secondary.....	A-41060		
SK60 (EXCAVATORS) ISUZU 4JB1 (S/N: LE11001-17595) Air Filter Primary..... Air Filter Secondary..... Air Filter Set..... Fuel Filter..... Hydraulic Oil Filter.....	AS-5644 A-7919 AS-5644-S FC-1801 H-5211		
SK60-2 (EXCAVATORS) ISUZU 4JB1 Fuel Filter..... Oil Filter Full Flow..... Oil Filter Full Flow.....	FC-1801 C-1511 C-1538		
SK60IV (EXCAVATORS) ISUZU 4JB1 (S/N: LE17596-17700) Air Filter Primary..... Air Filter Secondary..... Air Filter Set..... Fuel Filter..... Hydraulic Oil Filter.....	AS-5644 A-7919 AS-5644-S FC-1801 H-5211		
SK70SR (EXCAVATORS) ISUZU 4JB1 (S/N: YT00101-UP) Oil Filter Full Flow..... Oil Filter Full Flow.....	C-1511 C-1538		



Technical Specification

B

Sakura Filter

Technical Specification

A-1013 Air Filter Primary Metal End Cap Element



ISUZU 1-14214126-0
ISUZU 1-14215-181-0
ISUZU 1-86750-309-0
NISSAN 16546-96071
NISSAN 16546-99218
Secondary Filter uses A-5631
Set Filter uses A-1841-S
H 1 : 394.7 (mm)
H 2 : 382 (mm)
OD 1 : 276 (mm)
OD 2 : 275 (mm)
ID 1 : 165 (mm)
ID 2 : 23 (mm)

CONT : 4
VOL : 0.154

Note : Is a Primary Air Filter for A-5631,A-7607

A-2705 Air Filter Secondary Soft PU end cap Element



HITACHI 4287060
KOBELCO YN02P000013B

Primary Filter uses A-2706
Set Filter uses A-2707-S
H 1 : 353 (mm)
H 2 : 347 (mm)
OD 1 : 124 (mm)
OD 2 : 117 (mm)
ID 1 : 104 (mm)

CONT : 25
VOL : 0.178

A-41060 Air Filter Secondary Plastic Element



KOBELCO PH11P01039P1

Primary Filter uses A-8581
Set Filter uses A-41070-S
H 1 : 248.5 (mm)
H 2 : 245.5 (mm)
OD 1 : 68 (mm)
OD 2 : 68 (mm)
ID 1 : 56 (mm)

CONT : 25
VOL : 0.052

A-10134 Air Filter Primary Metal End Cap Element



MITSUBISHI ME 063130

H 1 : 394.7 (mm)
H 2 : 382 (mm)
OD 1 : 276 (mm)
OD 2 : 275 (mm)
ID 1 : 165 (mm)
ID 2 : 23 (mm)

CONT : 1
VOL : 0.035

Note : Flame retardant version from A-1013

A-2706 Air Filter Primary Soft PU end cap Element



HITACHI 4283861
KOBELCO YN02P000013A

Secondary Filter uses A-2705
Set Filter uses A-2707-S
H 1 : 367.5 (mm)
H 2 : 355.5 (mm)
OD 1 : 207 (mm)
OD 2 : 208 (mm)
ID 1 : 123 (mm)

CONT : 9
VOL : 0.175

A-41070-S Air Filter Set Metal+Plastic End Cap Element



KOBELCO
PH11P00011S005+PH11P01039P1

Primary Filter uses A-8581
Secondary Filter uses A-41060
H 1 : 262 (mm)
H 2 : 248 (mm)
OD 1 : 128 (mm)
OD 2 : 173 (mm)
ID 1 : 70 (mm)

CONT : 9
VOL : 0.094

A-1313 Air Filter Primary Metal End Cap Element



CATERPILLAR 099-5801
ISUZU 1-14215084-0
HINO 17720-3640
HINO 17801-2530

Secondary Filter uses A-1307
Set Filter uses A-5662-S
H 1 : 469.75 (mm)
H 2 : 457 (mm)
OD 1 : 232 (mm)
OD 2 : 232 (mm)
ID 1 : 147 (mm)
ID 2 : 23 (mm)

CONT : 4
VOL : 0.123

A-28710 Air Filter Primary Metal End Cap Element



HYUNDAI 11N8-22140

Secondary Filter uses A-28720
Set Filter uses A-28730-S
H 1 : 502.75 (mm)
H 2 : 490 (mm)
OD 1 : 276 (mm)
OD 2 : 275 (mm)
ID 1 : 165 (mm)
ID 2 : 19 (mm)

CONT : 1
VOL : 0.047

A-41080 Air Filter Primary Soft PU end cap Element



H 1 : 362.5 (mm)
H 2 : 356 (mm)
OD 1 : 184 (mm)
OD 2 : 184 (mm)
ID 1 : 94 (mm)

CONT : 0
VOL : 0.000

A-1841-S Air Filter Set Metal End Cap Element



NISSAN 16546-96070
HITACHI 4288963+4288964
KOMATSU 600-181-1600

Primary Filter uses A-1013
Secondary Filter uses A-5631
H 1 : 395 (mm)
H 2 : 382 (mm)
OD 1 : 276 (mm)
OD 2 : 276 (mm)
ID 1 : 165 (mm)
ID 2 : 23 (mm)

CONT : 4
VOL : 0.163

A-28730-S Air Filter Set Metal End Cap Element



HYUNDAI 11N8-22140+11N8-22150

Primary Filter uses A-28710
Secondary Filter uses A-28720
H 1 : 502.75 (mm)
H 2 : 490 (mm)
OD 1 : 276 (mm)
OD 2 : 275 (mm)
ID 1 : 134 (mm)
ID 2 : 19 (mm)

CONT : 1
VOL : 0.047

A-5408 Air Filter Secondary Metal End Cap Element



ISUZU 1-14215034-0
ISUZU 1-14215036-0
NISSAN 16546-96014

Primary Filter uses A-6113
Set Filter uses A-5653-S
H 1 : 406 (mm)
OD 1 : 192.3 (mm)
OD 2 : 162.5 (mm)
ID 1 : 134.2 (mm)
ID 2 : 17 (mm)

CONT : 9
VOL : 0.167

Note : Is a Secondary Air filter for A-6113,A-54490

A-2210 Air Filter Primary Metal End Cap Element



FIAT 0068473-3
ISUZU 1-14215-018-0
ISUZU 1-14215007-0
NISSAN 16546-96011

Secondary Filter uses A-6008
Set Filter uses A-6117-S
H 1 : 342.7 (mm)
H 2 : 330 (mm)
OD 1 : 234 (mm)
OD 2 : 234 (mm)
ID 1 : 123 (mm)
ID 2 : 17 (mm)

CONT : 4
VOL : 0.093

A-41050 Air Filter Breather Metal End Cap Element



NEW HOLLAND (CNH) 47640920
KOBELCO YN57V00002S010
KOBELCO YN57V00004S002

H 1 : 39.5 (mm)
H 2 : 35 (mm)
OD 1 : 54.5 (mm)
OD 2 : 51 (mm)
ID 1 : 31 (mm)
ID 2 : 31 (mm)

CONT : 50
VOL : 0.009

A-5540 Air Filter Secondary Soft PU end cap Element



YANMAR 119117-12570
CATERPILLAR 1318903
PERKINS 26510343
YANMAR Y119117-12570

Primary Filter uses A-5541
Set Filter uses A-5541-S
H 1 : 346 (mm)
H 2 : 340 (mm)
OD 1 : 92 (mm)
OD 2 : 86.5 (mm)
ID 1 : 72.5 (mm)

CONT : 25
VOL : 0.105

Sakura Filter

Technical Specification

A-5541 Air Filter Primary Soft PU end cap Element



YANMAR 119117-12560
CATERPILLAR 131-8902
PERKINS 26510342
HITACHI 4486002

Secondary Filter uses A-5540
Set Filter uses A-5541-S
H 1 : 356 (mm)
H 2 : 347 (mm)
OD 1 : 163.5 (mm)
OD 2 : 163.5 (mm)
ID 1 : 91 (mm)

CONT : 9
VOL : 0.108

A-5610 Air Filter Secondary Metal End Cap Element



NISSAN 16546-97005
CATERPILLAR 3I-0125
HITACHI 4177212

Primary Filter uses A-5614
Set Filter uses A-5613-S
H 1 : 449 (mm)
OD 1 : 214.8 (mm)
OD 2 : 185 (mm)
ID 1 : 157.5 (mm)
ID 2 : 17 (mm)

CONT : 4
VOL : 0.099

Note : Is a Secondary Air filter for A-5614,A-5618

A-5631 Air Filter Secondary Metal End Cap Element



ISUZU 1-14215087-0
NISSAN 16546-96072
HITACHI 4288964

Primary Filter uses A-1013
Set Filter uses A-1841-S
H 1 : 361.75 (mm)
H 2 : 349 (mm)
OD 1 : 162.5 (mm)
OD 2 : 163 (mm)
ID 1 : 134 (mm)
ID 2 : 17 (mm)

CONT : 9
VOL : 0.110

A-5541M Air Filter Primary Soft PU+Metal Element



CATERPILLAR 131-8902

Secondary Filter uses A-5540
Set Filter uses A-5541M-S
H 1 : 356 (mm)
H 2 : 347 (mm)
OD 1 : 163.5 (mm)
OD 2 : 163.5 (mm)
ID 1 : 91 (mm)

CONT : 9
VOL : 0.108

A-5618 Air Filter Primary Metal End Cap Element



NISSAN 16546-97004
HINO 17801-2550
HITACHI 4177213

Secondary Filter uses A-5610
Set Filter uses A-5658-S
H 1 : 469.7 (mm)
H 2 : 457 (mm)
OD 1 : 307 (mm)
OD 2 : 307 (mm)
ID 1 : 196 (mm)
ID 2 : 17 (mm)

CONT : 1
VOL : 0.054

A-5635 Air Filter Secondary Metal End Cap Element



DAEWOO 2474-9054
KOMATSU 600-181-6730
MITSUBISHI ME033839

Primary Filter uses A-5639
Set Filter uses A-5654-S
H 1 : 414.75 (mm)
H 2 : 402 (mm)
OD 1 : 133.5 (mm)
OD 2 : 133.5 (mm)
ID 1 : 105 (mm)
ID 2 : 17 (mm)

CONT : 9
VOL : 0.086

A-5541M-S Air Filter Set Soft PU+Metal Element



CATERPILLAR 131-8902+131-8903

Primary Filter uses A-5541M
Secondary Filter uses A-5540
H 1 : 353 (mm)
H 2 : 344 (mm)
OD 1 : 163.5 (mm)
OD 2 : 163.5 (mm)
ID 1 : 91 (mm)

CONT : 9
VOL : 0.116

A-5627 Air Filter Primary Metal End Cap Element



KOBELCO 2451-U311-3
DAEWOO 2474-6006A
DAEWOO 2474-6006B

Secondary Filter uses A-6008
Set Filter uses A-5663-S
H 1 : 393.7 (mm)
H 2 : 381 (mm)
OD 1 : 235 (mm)
OD 2 : 187 (mm)
ID 1 : 120 (mm)
ID 2 : 17 (mm)

CONT : 1
VOL : 0.026

A-5639 Air Filter Primary Metal End Cap Element



KOBELCO 2451-U324-3
MITSUBISHI 3433000400

Secondary Filter uses A-5635
Set Filter uses A-5654-S
H 1 : 454.7 (mm)
H 2 : 442 (mm)
OD 1 : 263.5 (mm)
OD 2 : 221 (mm)
ID 1 : 136 (mm)
ID 2 : 23 (mm)

CONT : 1
VOL : 0.036

A-5558 Air Filter Primary Soft PU end cap Element



KOMATSU 424-01-H0P03
KOMATSU 600-185-5100P
KOMATSU 600-185-5110

Secondary Filter uses A-5559
Set Filter uses A-5558-S
H 1 : 417 (mm)
H 2 : 405 (mm)
OD 1 : 280 (mm)
OD 2 : 280 (mm)
ID 1 : 148 (mm)

CONT : 1
VOL : 0.038

A-5628 Air Filter Primary Metal End Cap Element



CHRYSLER 3614353
KOMATSU 600-181-8240

Secondary Filter uses A-7611
Set Filter uses A-5628-S
H 1 : 311 (mm)
H 2 : 305 (mm)
OD 1 : 155 (mm)
OD 2 : 155 (mm)
ID 1 : 88 (mm)
ID 2 : 17 (mm)

CONT : 12
VOL : 0.120

A-5654-S Air Filter Set Metal End Cap Element



KOMATSU 600-181-6740

Primary Filter uses A-5639
Secondary Filter uses A-5635
H 1 : 454.7 (mm)
H 2 : 442 (mm)
OD 1 : 263.5 (mm)
OD 2 : 221 (mm)
ID 1 : 135 (mm)
ID 2 : 23 (mm)

CONT : 1
VOL : 0.036

A-5559 Air Filter Secondary Soft PU end cap Element



KOMATSU 424-01-H0P02
KOMATSU 600-185-5100S
KOMATSU 600-185-5120

Primary Filter uses A-5558
Set Filter uses A-5558-S
H 1 : 394 (mm)
OD 1 : 150 (mm)
OD 2 : 142.3 (mm)
ID 1 : 109 (mm)

CONT : 1
VOL : 0.011

A-5628-S Air Filter Set Metal End Cap Element



CLAAS 3200010+3200020
BLOUNT 537986+537987
BOBCAT 6681474+6681475
JOHN DEERE AT44377+AT44378

Primary Filter uses A-5628
Secondary Filter uses A-7611
H 1 : 311 (mm)
H 2 : 305 (mm)
OD 1 : 155 (mm)
OD 2 : 155 (mm)
ID 1 : 88 (mm)
ID 2 : 17 (mm)

CONT : 12
VOL : 0.194

A-5662-S Air Filter Set Metal End Cap Element



KOMATSU 600-181-8600
KOMATSU 600-182-2700
KOMATSU 600-182-3200

Primary Filter uses A-1313
Secondary Filter uses A-1307
H 1 : 457 (mm)
H 2 : 432 (mm)
OD 1 : 232 (mm)
OD 2 : 145 (mm)
ID 1 : 147 (mm)
ID 2 : 23 (mm)

CONT : 4
VOL : 0.123

Sakura Filter

Technical Specification

A-5663-S Air Filter Set Metal End Cap Element

KOMATSU 600-181-6050



Primary Filter uses A-5627
Secondary Filter uses A-6008
H 1 : 380 (mm)
H 2 : 330 (mm)
OD 1 : 235 (mm)
OD 2 : 187 (mm)
ID 1 : 120 (mm)
ID 2 : 17 (mm)

CONT : 1
VOL : 0.030

31

A-76231 Air Filter Primary Soft PU end cap Element flame retardant media

CLARK 1241080
TOYOTA 17741-U3330-71
KOMATSU 3EC02A541E



H 1 : 356 (mm)
H 2 : 347 (mm)
OD 1 : 163.5 (mm)
OD 2 : 163.5 (mm)
ID 1 : 91 (mm)

CONT : 9
VOL : 0.116

Note : Flame Retardant version of A-5541

36

A-8505 Air Filter Primary Soft PU end cap Element

OPEL 1#123 84 075
OPEL 1-12384075
SUNWARD 730403000155



Secondary Filter uses A-8599
Set Filter uses A-8602-S
H 1 : 312 (mm)
H 2 : 304 (mm)
OD 1 : 127.5 (mm)
OD 2 : 127.5 (mm)
ID 1 : 83 (mm)

CONT : 16
VOL : 0.109

Note : For Flame Retardant version, use A-76410

41

A-6008 Air Filter Secondary Metal End Cap Element

ISUZU 1-14215047-0
ISUZU 1-1425-046-1
NISSAN 16546-96010



Primary Filter uses A-5627
Set Filter uses A-5663-S
H 1 : 330 (mm)
OD 1 : 146 (mm)
OD 2 : 116.5 (mm)
ID 1 : 88 (mm)
ID 2 : 17 (mm)

CONT : 9
VOL : 0.083

32

A-7806 Air Filter Secondary Metal End Cap Element

YANMAR 119131-12520
ISUZU 14215-167
DAEWOO 2474-9014



Primary Filter uses AS-7805
Set Filter uses AS-5656-S
H 1 : 337 (mm)
H 2 : 330 (mm)
OD 1 : 85.5 (mm)
OD 2 : 85.5 (mm)
ID 1 : 57.5 (mm)
ID 2 : 17 (mm)

CONT : 12
VOL : 0.050

Note : Is a secondary Air Filter for AS-7805,AS-7813,A-7805

37

A-8513 Air Filter Primary Soft PU end cap Element

YANMAR 119808-12520
NISSAN 16546-FJ100
KOMATSU 3EB-02-38730
SUNWARD 730403000157



Secondary Filter uses A-5569
Set Filter uses A-5570-S
H 1 : 273.5 (mm)
H 2 : 265 (mm)
OD 1 : 104 (mm)
OD 2 : 104 (mm)
ID 1 : 61 (mm)

CONT : 25
VOL : 0.110

Note : A-8513(with Flame Retardant Media)

42

A-6009 Air Filter Secondary Metal End Cap Element

NISSAN 16546-96004
KOBELCO 2451U180-3B
KOBELCO 2451U206-3
KOMATSU 600-181-8360
ISUZU 9-14215017-0



Primary Filter uses AS-1024
Set Filter uses AS-1024-S
H 1 : 397 (mm)
H 2 : 397 (mm)
OD 1 : 146.2 (mm)
OD 2 : 166.5 (mm)
ID 1 : 88 (mm)
ID 2 : 17 (mm)

CONT : 9
VOL : 0.101

33

A-7913 Air Filter Secondary Metal End Cap Element

NISSAN 16546-95010
CATERPILLAR 5W-2716
INTERNATIONAL HARVESTER 681545 R1



Primary Filter uses AS-5523
Set Filter uses AS-6116-S
H 1 : 383 (mm)
H 2 : 381 (mm)
OD 1 : 123 (mm)
OD 2 : 106 (mm)
ID 1 : 93 (mm)
ID 2 : 17 (mm)

CONT : 9
VOL : 0.074

38

A-8581 Air Filter Metal End Cap Element

KATO 119-69204001
KOBELCO PH11P00011S005



H 1 : 261.8 (mm)
H 2 : 248 (mm)
OD 1 : 128 (mm)
OD 2 : 173.5 (mm)
ID 1 : 70 (mm)

CONT : 9
VOL : 0.094

43

A-6113 Air Filter Primary Metal End Cap Element

FIAT 01901779
ISUZU 1-14215046-0
NISSAN 16546-96017



Secondary Filter uses A-5408
Set Filter uses A-5653-S
H 1 : 418.7 (mm)
H 2 : 406 (mm)
OD 1 : 282 (mm)
OD 2 : 282 (mm)
ID 1 : 171 (mm)
ID 2 : 17 (mm)

CONT : 1
VOL : 0.038

34

A-7919 Air Filter Secondary Metal End Cap Element

INTERNATIONAL HARVESTER 1043327M91
YANMAR 171064-12520
YANMAR 171064-12550



Primary Filter uses AS-5644
Set Filter uses AS-5644-S
H 1 : 253.5 (mm)
H 2 : 253 (mm)
OD 1 : 81 (mm)
OD 2 : 64.5 (mm)
ID 1 : 55 (mm)
ID 2 : 17 (mm)

CONT : 12
VOL : 0.025

39

A-8599 Air Filter Secondary Soft PU end cap Element

KUBOTA 119005-12571
CASE 133721A1
HITACHI 4326841



Primary Filter uses A-8505
Set Filter uses A-8602-S
H 1 : 303.5 (mm)
H 2 : 298 (mm)
OD 1 : 83 (mm)
OD 2 : 79 (mm)
ID 1 : 64 (mm)

CONT : 25
VOL : 0.076

Note : Is a Secondary Air filter for A-5669,A-8505

44

A-7004 Air Filter Secondary Soft PU end cap Element

FIAT 1930588
PERKINS 26510338



Primary Filter uses A-7003
Set Filter uses A-7003-S
H 1 : 319 (mm)
H 2 : 312 (mm)
OD 1 : 84 (mm)
OD 2 : 79 (mm)
ID 1 : 63 (mm)

CONT : 25
VOL : 0.082

35

A-7967 Air Filter Secondary Metal End Cap Element

ISUZU 1-14215089-0
NISSAN 16546-96065
KOBELCO 2446U250S-2



Primary Filter uses A-1828
Set Filter uses A-1840-S
H 1 : 495.7 (mm)
H 2 : 483 (mm)
OD 1 : 162.3 (mm)
OD 2 : 162.3 (mm)
ID 1 : 134 (mm)
ID 2 : 17 (mm)

CONT : 9
VOL : 0.152

40

A-8807 Air Filter Primary Soft PU end cap Element

FIAT KOBELCO 72285432
KUBOTA T0270-16320
KUBOTA T0270-16321
KUBOTA TC020-16320
KUBOTA T0270-1632-0



Secondary Filter uses A-8809
Set Filter uses A-8807-S
H 1 : 250.5 (mm)
H 2 : 237 (mm)
OD 1 : 109 (mm)
OD 2 : 109 (mm)
ID 1 : 55.5 (mm)

CONT : 25
VOL : 0.085

45

Sakura Filter

Technical Specification

A-8807-S Air Filter Set Soft PU end cap Element

KUBOTA
TC020-16320+TO270-93220



Primary Filter uses A-8807
Secondary Filter uses A-8809
H 1 : 250 (mm)
H 2 : 237 (mm)
OD 1 : 109 (mm)
OD 2 : 109 (mm)
ID 1 : 55 (mm)

CONT : 25
VOL : 0.096

46

AS-2205 Air Filter Primary Metal End Cap Element With Sleeve

ISUZU 1-14215014-0
YANMAR 121120-12901
KUBOTA 121420-12511



Secondary Filter uses A-8568
Set Filter uses AS-2206-S
H 1 : 264 (mm)
H 2 : 254 (mm)
OD 1 : 132 (mm)
OD 2 : 104 (mm)
ID 1 : 63 (mm)
ID 2 : 17 (mm)

CONT : 12
VOL : 0.073

51

AS-5644-S Air Filter Set Metal End Cap Element With Sleeve

KOMATSU 3EC-01-11630(SET)



Primary Filter uses AS-5644
Secondary Filter uses A-7919
H 1 : 288 (mm)
H 2 : 279 (mm)
OD 1 : 160 (mm)
OD 2 : 181.5 (mm)
ID 1 : 66.5 (mm)
ID 2 : 17 (mm)

CONT : 12
VOL : 0.163

56

AS-1010 Air Filter Metal End Cap Element With Sleeve

ISUZU 14215-132
CUMMINS 158876
NISSAN 16546-Z5001



H 1 : 266.7 (mm)
H 2 : 254 (mm)
OD 1 : 257 (mm)
OD 2 : 201.5 (mm)
ID 1 : 90.5 (mm)
ID 2 : 14 (mm)

CONT : 1
VOL : 0.021

Note : INN.DIAM=91/17MM Version Uses AS-1025,
INN.DIAM 116/13.5MM Version Uses AS-1037

47

AS-5523 Air Filter Primary Metal End Cap Element With Sleeve

NISSAN 16546-95009
KOBELCO 2446R277S5
FIAT 266787



Secondary Filter uses A-7913
Set Filter uses AS-6116-S
H 1 : 418.7 (mm)
H 2 : 406 (mm)
OD 1 : 225 (mm)
OD 2 : 174 (mm)
ID 1 : 107.5 (mm)
ID 2 : 17 (mm)

CONT : 4
VOL : 0.115

52

AS-5656-S Air Filter Set Metal End Cap Element With Sleeve

KOMATSU 600-181-9500



Primary Filter uses AS-7805
Secondary Filter uses A-7806
H 1 : 392 (mm)
H 2 : 381 (mm)
OD 1 : 199.3 (mm)
OD 2 : 155 (mm)
ID 1 : 88 (mm)
ID 2 : 17 (mm)

CONT : 9
VOL : 0.169

57

AS-1024 Air Filter Primary Metal End Cap Element With Sleeve

NISSAN 16546-96003
NISSAN 16546-96015
NISSAN 16546-96026



Secondary Filter uses A-6009
Set Filter uses AS-1024-S
H 1 : 418.7 (mm)
H 2 : 406 (mm)
OD 1 : 254 (mm)
OD 2 : 201.5 (mm)
ID 1 : 135.5 (mm)
ID 2 : 17 (mm)

CONT : 1
VOL : 0.031

48

AS-5620 Air Filter Primary Metal End Cap Element With Sleeve

KOMATSU 600-181-7300



Secondary Filter uses A-5621
Set Filter uses AS-5620-S
H 1 : 290 (mm)
H 2 : 280.5 (mm)
OD 1 : 160 (mm)
OD 2 : 134 (mm)
ID 1 : 87 (mm)
ID 2 : 17 (mm)

CONT : 9
VOL : 0.090

53

AS-7805 Air Filter Primary Metal End Cap Element With Sleeve

IVECO 08014390
MASSEY-FERGUSON 1093682M91
ISUZU 14215-166



Secondary Filter uses A-7806
Set Filter uses AS-5656-S
H 1 : 392 (mm)
H 2 : 381 (mm)
OD 1 : 199 (mm)
OD 2 : 155 (mm)
ID 1 : 88 (mm)
ID 2 : 17 (mm)
Gasket Type : Square

CONT : 9
VOL : 0.169

Note : Long Life Versions Uses AS-7813

58

AS-1024-S Air Filter Set Metal End Cap Element With Sleeve

FIAT 1930751+1930790
KOMATSU 6131-82-7011
FIAT 70684732+1930790
JOHN DEERE T46316+T46317



Primary Filter uses AS-1024
Secondary Filter uses A-6009
H 1 : 418.7 (mm)
H 2 : 406 (mm)
OD 1 : 254 (mm)
OD 2 : 201.5 (mm)
ID 1 : 135.5 (mm)
ID 2 : 17 (mm)

CONT : 1
VOL : 0.031

49

AS-5628 Air Filter Primary Metal End Cap Element With Sleeve

MAZDA 0727-23-603
ISUZU 1-14215028-0
ISUZU 1-14215032-0



Secondary Filter uses A-7611
Set Filter uses AS-5628-S
H 1 : 311 (mm)
H 2 : 305 (mm)
OD 1 : 199.3 (mm)
OD 2 : 155 (mm)
ID 1 : 88 (mm)
ID 2 : 17 (mm)

CONT : 12
VOL : 0.194

54

C-1006 Oil Filter By Pass Spin-On

KOBELCO 24514311-1A
HYUNDAI 26320-41402



H 1 : 100 (mm)
OD 1 : 90 (mm)
Thread Size : M18X1.5-6H
Gasket Type : Round

CONT : 50
VOL : 0.055

59

AS-1824 Air Filter Metal End Cap Element With Sleeve

YANMAR 129350-12900
ISEKI 1480-104-2070-0
NISSAN 16546-00H10



H 1 : 200 (mm)
H 2 : 190 (mm)
OD 1 : 131.5 (mm)
OD 2 : 104 (mm)
ID 1 : 63 (mm)
ID 2 : 17 (mm)

CONT : 16
VOL : 0.079

50

AS-5644 Air Filter Primary Metal End Cap Element With Sleeve

YANMAR 119005-12510
KOBELCO 2446U271S2
MITSUBISHI 32A3005300



Secondary Filter uses A-7919
Set Filter uses AS-5644-S
H 1 : 288 (mm)
H 2 : 279 (mm)
OD 1 : 160 (mm)
OD 2 : 181.5 (mm)
ID 1 : 66.5 (mm)
ID 2 : 17 (mm)

CONT : 12
VOL : 0.154

55

C-1007 Oil Filter Combination Spin-On

NISSAN 15201-EP025
NISSAN 15201-Z9009
NISSAN 15201-Z9012
NISSAN 15201-Z9013
NISSAN 15201-Z9014



H 1 : 220 (mm)
OD 1 : 121 (mm)
Thread Size : M36X1.5-6H
Gasket Type : Round

CONT : 6
VOL : 0.028

Note : With Drain nut version uses C-6110

60

Sakura Filter

Technical Specification

C-1009 Oil Filter Full Flow Spin-On

MITSUBISHI ME 084530
MITSUBISHI ME 088519



H 1 : 161 (mm)
OD 1 : 108 (mm)
Thread Size : 1 1/8-16 UNF-2B
Gasket Type : Round

CONT : 12
VOL : 0.031

Note : Without Nut

61

C-2702 Oil Filter Full Flow Spin-On

KOBELCO 2451U309-1
HITACHI 4183853
HITACHI 4439863



H 1 : 150 (mm)
OD 1 : 102 (mm)
Thread Size : 1-12 UNF-2B
BPV (kg/cm2) : 2.0 - 2.5
ADBV : YES
Gasket Type : Square

CONT : 12
VOL : 0.027

66

C-5723 Oil Filter Combination Spin-On

KOMATSU 6742-01-4120



H 1 : 280 (mm)
OD 1 : 121 (mm)
Thread Size : 2 1/4-12 UNF-2B
Gasket Type : Square

CONT : 6
VOL : 0.038

71

C-1507 Oil Filter Full Flow Spin-On

HYUNDAI 20801-01191
ISUZU 5-13211024-0
ISUZU 5-13211024-1



H 1 : 150 (mm)
OD 1 : 102 (mm)
Thread Size : M20X1.5-6H
BPV (kg/cm2) : 1.0
ADBV : YES
Gasket Type : Square

CONT : 25
VOL : 0.056

62

C-5205 Oil Filter Full Flow Spin-On

YANMAR 119305-35151



H 1 : 65 (mm)
OD 1 : 65 (mm)
Thread Size : M20X1.5-6H
BPV (kg/cm2) : 1.0
ADBV : YES
Gasket Type : Round

CONT : 50
VOL : 0.021

67

C-5808 Oil Filter Combination Spin-On

KOBELCO 2451U343-1
MITSUBISHI ME 088532



H 1 : 181 (mm)
OD 1 : 108 (mm)
Thread Size : M26X1.5-6H
BPV (kg/cm2) : 2.0

CONT : 12
VOL : 0.033

72

C-1511 Oil Filter Full Flow Spin-On

ISUZU 8-94217272-0
ISUZU 8-94360426-0
ISUZU 8-94430983-0



H 1 : 100 (mm)
OD 1 : 90 (mm)
Thread Size : M20X1.5-6H
BPV (kg/cm2) : 1.0
ADBV : YES
Gasket Type : Round

CONT : 25
VOL : 0.029

63

C-5505 Oil Filter Full Flow Spin-On

CATERPILLAR 1R-0714
HITACHI 4429728
FIAT 71455273
MITSUBISHI ME034878
MITSUBISHI ME088519



H 1 : 162 (mm)
OD 1 : 108 (mm)
Thread Size : 1 1/8-16 UNF-2B
Gasket Type : Square

CONT : 12
VOL : 0.034

68

C-7005 Oil Filter Full Flow Spin-On

GENERAL MOTORS 25010971
CATERPILLAR 773899



H 1 : 260 (mm)
OD 1 : 122 (mm)
Thread Size : 1 1/2-12 UNF-2B
Gasket Type : Square

CONT : 6
VOL : 0.035

73

C-1538 Oil Filter Full Flow Spin-On

HOLDEN 8-9421-7272-2



H 1 : 95 (mm)
OD 1 : 93 (mm)
Thread Size : M20X1.5-6H
BPV (kg/cm2) : 1.0
ADBV : YES
Gasket Type : Square

CONT : 25
VOL : 0.037

Note : C-1503,C-1511 (bottom plate difference)

64

C-5703 Oil Filter Full Flow Spin-On

HYUNDAI 11E1-70110
GENERAL MOTORS 25011995
CUMMINS 3903224
KOMATSU 6732-51-5140
CASE J908616



H 1 : 135 (mm)
OD 1 : 93 (mm)
Thread Size : 1-16 UNF-2B
Gasket Type : Square

CONT : 12
VOL : 0.018

69

C-8012 Oil Filter Full Flow Spin-On

MAHINDRA 14501673990
HITACHI 26300-21010
HYUNDAI 26300-21010
CHRYSLER 4186267
MITSUBISHI 4253037



H 1 : 78 (mm)
OD 1 : 86 (mm)
Thread Size : M20X1.5-6H
BPV (kg/cm2) : 1.0
ADBV : YES
Gasket Type : Square

CONT : 50
VOL : 0.046

74

C-15680 Oil Filter By Pass Spin-On

J.C.BAMFORD 2800359
HITACHI 4429725
FIAT-HITACHI 71422692
NEW HOLLAND (CNH) 71422692
ISUZU 8-97026134-2



H 1 : 200 (mm)
OD 1 : 110 (mm)
Thread Size : M20X1.5-6H
Gasket Type : Square

CONT : 12
VOL : 0.042

65

C-5704 Oil Filter Full Flow Spin-On Cellulose media

J.C.BAMFORD 02/910140
J.C.BAMFORD 02/910140A
CUMMINS 3903264



H 1 : 174 (mm)
OD 1 : 93 (mm)
Thread Size : 1-16 UNF-2B
Gasket Type : Square

CONT : 12
VOL : 0.023

Note : High Performance Grade Uses C-5730

70

CA-41010 Cabin Air Filter Plastic framed Element

KOBELCO 51186-41990
KOBELCO YN50V01015P3



H 1 : 17 (mm)
Length 1 : 200 (mm)
Length 2 : 210 (mm)
Width 1 : 189.5 (mm)
Width 2 : 222.5 (mm)

CONT : 20
VOL : 0.039

75

Sakura Filter

Technical Specification

CA-41020-S Cabin Air Filter Set Plastic framed Element

KOBELCO 51186-41970
NEW HOLLAND (CNH) VN50W01014P1
KOBELCO YN50V01014P1



H 1 : 15 (mm)
Length 1 : 490 (mm)
Width 1 : 123 (mm)

CONT : 20
VOL : 0.053

Note : 1 set= 2 pcs filter

EF-41010 Fuel Filter Primary Eco Element High Efficiency

KOBELCO YT21P01006R100

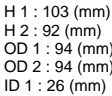

H 1 : 103 (mm)
H 2 : 92 (mm)
OD 1 : 94 (mm)
OD 2 : 94 (mm)
ID 1 : 26 (mm)

CONT : 50
VOL : 0.060

F-2604 Fuel Filter Metal End Cap Element

MERCEDES-BENZ 000 477 40 15
MERCEDES-BENZ 000 477 45 15
MERCEDES-BENZ 355 470 01 92



H 1 : 145 (mm)
H 2 : 138 (mm)
OD 1 : 83 (mm)
OD 2 : 83 (mm)
ID 1 : 14 (mm)
ID 2 : 14 (mm)

CONT : 50
VOL : 0.062

CA-41030 Cabin Air Filter Plastic framed Element

KOBELCO 56186-40350
KOBELCO YN50V0101014D1



H 1 : 28 (mm)
H 2 : 10.5 (mm)
Length 1 : 208.5 (mm)
Width 1 : 185 (mm)

CONT : 20
VOL : 0.051

Note : for Kobelco Excavator SK 200

EF-41020 Fuel Filter Eco Element

KOBELCO YN21P01157R100

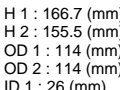

H 1 : 166.7 (mm)
H 2 : 155.5 (mm)
OD 1 : 114 (mm)
OD 2 : 114 (mm)
ID 1 : 26 (mm)

CONT : 12
VOL : 0.036

F-5207 Fuel Filter Metal End Cap Element

YANMAR 119810-55650
YANMAR 124550-55700
KUBOTA 16271-43560



H 1 : 87.5 (mm)
H 2 : 85 (mm)
OD 1 : 35 (mm)
OD 2 : 35 (mm)
ID 1 : 11.5 (mm)

CONT : 50
VOL : 0.009

CA-45050 Cabin Air Filter Plastic framed Element with pull tabs

NEW HOLLAND (CNH) LQ50V01008P1



H 1 : 47.5 (mm)
Length 1 : 240 (mm)
Width 1 : 193.5 (mm)

CONT : 20
VOL : 0.082

Note :

EO-13040 Oil Filter By Pass Eco Element

HINO 15601-E0070
HINO S1560-72360



H 1 : 225.5 (mm)
H 2 : 197.5 (mm)
OD 1 : 139.5 (mm)
OD 2 : 139.5 (mm)
ID 1 : 16.8 (mm)
ID 2 : 16.8 (mm)

CONT : 16
VOL : 0.092

F-5210 Fuel Filter Metal End Cap Element

YANMAR 129100-55650
KUBOTA 15521-43160
KUBOTA 607



H 1 : 89 (mm)
OD 1 : 50 (mm)
OD 2 : 50 (mm)
ID 1 : 20 (mm)

CONT : 50
VOL : 0.017

EF-27014 Fuel Filter Primary Eco Element High Efficiency

KOBELCO YN21P01088R100



H 1 : 167 (mm)
H 2 : 155 (mm)
OD 1 : 94 (mm)
OD 2 : 94 (mm)
ID 1 : 26 (mm)

CONT : 25
VOL : 0.049

F-1008 Fuel Filter Metal End Cap Element

KOBELCO 2451U180-2
MITSUBISHI ME 971550
MITSUBISHI ME 971552



H 1 : 143 (mm)
H 2 : 140 (mm)
OD 1 : 91 (mm)
OD 2 : 91 (mm)
ID 1 : 14.5 (mm)
ID 2 : 14.5 (mm)
Gasket Type : Square

CONT : 50
VOL : 0.073

F-5214 Fuel Filter Metal End Cap Element

YANMAR 171081-55910
CASE 282211A1
ISUZU 5-87810874-0



H 1 : 49.5 (mm)
H 2 : 47 (mm)
OD 1 : 35 (mm)
OD 2 : 35 (mm)
ID 1 : 11.5 (mm)

CONT : 100
VOL : 0.010

Note : Paper Wire Mesh

EF-27030 Fuel Filter Primary Eco Element 17 micron

KOBELCO YN21P01036R100T



H 1 : 167 (mm)
H 2 : 155 (mm)
OD 1 : 94 (mm)
OD 2 : 94 (mm)
ID 1 : 26 (mm)

CONT : 12
VOL : 0.024

Note : EF-2701 (end cap,media difference)

F-1803 Fuel Filter Metal End Cap Element

NISSAN 16444-90027
NISSAN 16444-99127
NISSAN 16444-99128



H 1 : 141 (mm)
H 2 : 134 (mm)
OD 1 : 91.5 (mm)
OD 2 : 91.5 (mm)
ID 1 : 14.5 (mm)
ID 2 : 14.5 (mm)

CONT : 50
VOL : 0.073

F-6503 Fuel Filter Metal End Cap Element

CUMMINS 104790
GENERAL MOTORS 5574508



H 1 : 199 (mm)
H 2 : 189 (mm)
OD 1 : 75.5 (mm)
OD 2 : 75.5 (mm)
ID 1 : 24.5 (mm)
ID 2 : 24.5 (mm)

CONT : 50
VOL : 0.073

F-7302 Fuel Filter Sock Element

CASE 434871R91
GENERAL MOTORS 5575032



H 1 : 213 (mm)
H 2 : 213 (mm)
OD 1 : 75 (mm)
OD 2 : 75 (mm)
ID 1 : 31.5 (mm)
ID 2 : 31.5 (mm)

CONT : 25
VOL : 0.040

91

FC-1010 Fuel Filter Spin-On

mitsubishi ME035829



H 1 : 125 (mm)
OD 1 : 90 (mm)
Thread Size : M20X1.5-6H
Gasket Type : Square

CONT : 36
VOL : 0.048

Note : is a square version from FC-1003

96

FC-52050 Fuel Filter Spin-On

YANMAR 119000-55601
YANMAR 119802-55801
YANMAR 119802-55831



H 1 : 80 (mm)
OD 1 : 90 (mm)
Thread Size : M20X1.5-6H
Gasket Type : Round

CONT : 36
VOL : 0.033

101

F-7930 Fuel Filter Metal End Cap Element

KOBELCO LS02P01012R100
KOBELCO LS02P01012S002
HITACHI YA00002973



H 1 : 144.5 (mm)
H 2 : 106.5 (mm)
OD 1 : 60 (mm)
OD 2 : 60 (mm)
ID 1 : 16 (mm)

CONT : 50
VOL : 0.034

92

FC-1703 Fuel Filter Spin-On

MAZDA R207-23-570
MAZDA RF03-23-570
MAZDA S213-23-570



H 1 : 120 (mm)
OD 1 : 95 (mm)
Thread Size : M20X1.5-6H
Gasket Type : Round

CONT : 12
VOL : 0.018

97

FC-55241 Fuel Filter Spin-On

HINO 23390-E0050
KOBELCO VH23390E0050



H 1 : 210 (mm)
OD 1 : 108 (mm)
Thread Size : 1-14 UNS-2B

CONT : 12
VOL : 0.042

102

FC-1002 Fuel Filter Spin-On

MITSUBISHI ME 016823
MITSUBISHI ME 016872



H 1 : 100 (mm)
OD 1 : 90 (mm)
Thread Size : M20X1.5-6H
Gasket Type : Square

CONT : 50
VOL : 0.053

93

FC-1801 Fuel Filter Spin-On

NISSAN 16403-09W00
NISSAN 16403-27000



H 1 : 80 (mm)
OD 1 : 80 (mm)
Thread Size : 3/4-16 UNF-2B
Gasket Type : Round

CONT : 50
VOL : 0.037

98

FC-5616 Fuel Filter Spin-On

HITACHI 448371
KOBELCO YB02P00001-2



H 1 : 75 (mm)
OD 1 : 80 (mm)
Thread Size : 3/4-16 UNF-2B
Gasket Type : Round

CONT : 50
VOL : 0.034

103

FC-10022 Fuel Filter Spin-On

NISSAN AY500-MT002
MITSUBISHI ME 016823
MITSUBISHI ME229355



H 1 : 100 (mm)
OD 1 : 90 (mm)
Thread Size : M20X1.5-6H
Gasket Type : Round

CONT : 12
VOL : 0.014

Note : FC-1002(bottom plate difference)

94

FC-18052 Fuel Filter Spin-On High Efficiency

MITSUBISHI 34362-04100
KOBELCO VA3436204100



H 1 : 174 (mm)
OD 1 : 93 (mm)
Thread Size : 1-14 UNS-2B
Gasket Type : Square

CONT : 25
VOL : 0.050

Note : for Kobelco Excavator SKBO-8,SK140-8

99

FC-6501 Fuel Filter Primary Spin-On

GENERAL MOTORS 25014274
GENERAL MOTORS 6438839



Secondary Filter uses FC-6502

H 1 : 203 (mm)
OD 1 : 93 (mm)
Thread Size : 1-12 UNF-2B
Gasket Type : Square

CONT : 12
VOL : 0.028

104

FC-1005 Fuel Filter Spin-On

HITACHI 4326739
NISSAN AY500-MT502
CASE-IH CNH KHH10030
SUMITOMO KHH10030



H 1 : 172 (mm)
OD 1 : 93.2 (mm)
Thread Size : M24X1.5-6H
Gasket Type : Square

CONT : 25
VOL : 0.052

Note : For high efficiency version, use FC-10270

95

FC-1826 Fuel Filter Spin-On

NISSAN 16444-99428



H 1 : 172 (mm)
OD 1 : 93 (mm)
Thread Size : 1-14 UNS-2B
Gasket Type : Square

CONT : 12
VOL : 0.025

100

FC-6502 Fuel Filter Secondary Spin-On

GENERAL MOTORS 25010778
GENERAL MOTORS 6438840



Primary Filter uses FC-6501

H 1 : 175 (mm)
OD 1 : 93 (mm)
Thread Size : 13/16-12 UNF-2B
Gasket Type : Square

CONT : 12
VOL : 0.025

105

Sakura Filter

Technical Specification

FC-6503 Fuel Filter Spin-On

GENERAL MOTORS 25010944
CATERPILLAR 3I-1220



H 1 : 141 (mm)
OD 1 : 93 (mm)
Thread Size : 1-12 UNF-2B
Gasket Type : Square

CONT : 25
VOL : 0.041

106

H-41100 Hydraulic Oil Filter Element

KOBELCO YN52V01025R100



H 1 : 259 (mm)
H 2 : 254 (mm)
OD 1 : 148 (mm)
OD 2 : 154 (mm)
ID 1 : 91.5 (mm)
ID 2 : 84 (mm)

CONT : 4
VOL : 0.039

111

H-5609 Hydraulic Oil Filter Metal End Cap Element Cellulose media

KOMATSU 07063-01142
KOMATSU 07063-01412
KOMATSU 195-60-16320



H 1 : 300.5 (mm)
OD 1 : 150 (mm)
OD 2 : 150 (mm)
ID 1 : 110 (mm)
ID 2 : 110 (mm)

CONT : 6
VOL : 0.059

116

FC-7903 Fuel Filter Secondary Spin-On High Efficiency

J.C.BAMFORD 02/910155
CUMMINS 3903640
CUMMINS 3931063



H 1 : 115 (mm)
OD 1 : 76 (mm)
Thread Size : M16X1.5-6H
Gasket Type : Square

CONT : 25
VOL : 0.023

107

H-41110 Hydraulic Oil Filter Element

KOBELCO LC52V01006P1



H 1 : 378 (mm)
H 2 : 374 (mm)
OD 1 : 148 (mm)
OD 2 : 154 (mm)
ID 1 : 92 (mm)
ID 2 : 84.5 (mm)

CONT : 4
VOL : 0.052

112

H-5622 Hydraulic Oil Filter Metal End Cap Element

KOMATSU 198-49-11440



H 1 : 291.5 (mm)
OD 1 : 112 (mm)
OD 2 : 112 (mm)
ID 1 : 70 (mm)
ID 2 : 70 (mm)

CONT : 10
VOL : 0.051

117

H-4101-S Hydraulic Oil Filter Set Plastic Element With Microfiber media

KOBELCO YN52V01011P1
KOBELCO YN52V01016R100



H 1 : 249 (mm)
H 2 : 231 (mm)
OD 1 : 144 (mm)
OD 2 : 142.5 (mm)
ID 1 : 96.5 (mm)
ID 2 : 96.5 (mm)
Thread Size : 4 7/16-11G

CONT : 12
VOL : 0.082

Note : 1 set= 2 pcs filter

108

H-5208 Hydraulic Oil Filter Wire Mesh supported Element

HITACHI 24464119
KOBELCO 2446R116E1



H 1 : 198 (mm)
H 2 : 190 (mm)
OD 1 : 150 (mm)
OD 2 : 150 (mm)
ID 1 : 96.6 (mm)
Thread Size : M10X1.5-6H

CONT : 9
VOL : 0.060

113

H-5634 Hydraulic Oil Filter Metal End Cap Element

YANMAR 172175-73710
KOBELCO PR50V00002P1
CASE STEYR PR50V00002P1P



H 1 : 231 (mm)
OD 1 : 89 (mm)
OD 2 : 89 (mm)
ID 1 : 60 (mm)
ID 2 : 60 (mm)

CONT : 25
VOL : 0.072

118

H-41013-S Hydraulic Oil Filter Set Plastic Element with synthetic media

KOBELCO YN52V01011P1
KOBELCO YN52V01016R100
KOBELCO YN52V01016R600



H 1 : 252 (mm)
H 2 : 234 (mm)
OD 1 : 144 (mm)
OD 2 : 142.5 (mm)
ID 1 : 97 (mm)
ID 2 : 97 (mm)
Thread Size : 4 7/16-11 G

CONT : 12
VOL : 0.082

109

H-5211 Hydraulic Oil Filter Wire Mesh supported Element

HYUNDAI 31E9-0018
KOBELCO R36P0019



H 1 : 87 (mm)
H 2 : 83.5 (mm)
OD 1 : 42.5 (mm)
OD 2 : 42.5 (mm)
ID 1 : 21.5 (mm)

CONT : 50
VOL : 0.017

114

H-5803 Hydraulic Oil Filter Wire Mesh supported Element

KOBELCO 2446R307S1
HITACHI 673340
KOBELCO K907



H 1 : 96 (mm)
H 2 : 89 (mm)
OD 1 : 150 (mm)
OD 2 : 150 (mm)
ID 1 : 96.6 (mm)
Thread Size : M10X1.5-6H

CONT : 9
VOL : 0.031

119

H-41060 Hydraulic Oil Filter Element With Microfiber media

KOBELCO PW52V01001R100
KOBELCO PW52V01002P1



H 1 : 110.5 (mm)
H 2 : 109.5 (mm)
OD 1 : 82 (mm)
OD 2 : 82 (mm)
ID 1 : 41 (mm)
ID 2 : 41 (mm)

CONT : 50
VOL : 0.048

Note : for KOBELCO SK 75 Excavator part # YR5

110

H-5519 Hydraulic Oil Filter Metal End Cap Element

SUMITOMO KRJ 1599



H 1 : 291 (mm)
OD 1 : 112 (mm)
OD 2 : 112 (mm)
ID 1 : 70 (mm)
ID 2 : 70 (mm)

CONT : 9
VOL : 0.049

115

H-7911 Hydraulic Oil Filter Metal End Cap Element

KOMATSU 07063-01210
KOMATSU 205-60-51430



H 1 : 450 (mm)
OD 1 : 150 (mm)
OD 2 : 150 (mm)
ID 1 : 110 (mm)
ID 2 : 110 (mm)

CONT : 6
VOL : 0.080

Note : Without gasket

120

Sakura Filter

Technical Specification

H-7919 Hydraulic Oil Filter Metal End Cap Element
KOBELCO 24046Z15



H 1 : 449 (mm)
OD 1 : 112 (mm)
OD 2 : 112 (mm)
ID 1 : 70 (mm)
ID 2 : 70 (mm)

CONT : 10
VOL : 0.076

121

O-1010 Oil Filter Full Flow Metal End Cap Element
MITSUBISHI 31240-53053
MITSUBISHI 31240-53054



H 1 : 148.4 (mm)
H 2 : 142 (mm)
OD 1 : 128 (mm)
OD 2 : 128 (mm)
ID 1 : 58 (mm)
ID 2 : 58 (mm)

CONT : 16
VOL : 0.049

126

SFC-1905-10 Fuel/Water Separator Secondary Spin-On 10 Micron
MASSEY-FERGUSON 108615W1
BOMAG 31701062
LIEBHERR 7364111
KOBELCO YN02PU1010P1



H 1 : 169 (mm)
H 2 : 156 (mm)
OD 1 : 93 (mm)
Thread Size : 1-14 UNS-2B
Thread Nut Size : 1 1/4"X10 UNS-2B
Gasket Type : Square

CONT : 12
VOL : 0.026

Note : bowl not included

131

H-7969 Hydraulic Oil Filter Metal End Cap Element
KOBELCO 2446R330F1
VOLVO VOE1141-00010



H 1 : 95 (mm)
H 2 : 89 (mm)
OD 1 : 200 (mm)
OD 2 : 200 (mm)
ID 1 : 96.6 (mm)
Thread Size : M10X1.5-6H

CONT : 8
VOL : 0.042

122

O-1301 Oil Filter Full Flow Metal End Cap Element
ISUZU 1-13240109-1
NISSAN 15208-61501
NISSAN 15208-61525
NISSAN 15208-Z5000
NISSAN 15208-Z9025



H 1 : 165 (mm)
H 2 : 160 (mm)
OD 1 : 104 (mm)
OD 2 : 104 (mm)
ID 1 : 15 (mm)
ID 2 : 49 (mm)

CONT : 50
VOL : 0.104

127

SFC-5705 Fuel/Water Separator Spin-On
ISUZU 1-13240044-1
CUMMINS 3308638
CUMMINS 3315843
SUNWARD 750201011130



H 1 : 174 (mm)
OD 1 : 93 (mm)
Thread Size : 1-14 UNS-2B
Gasket Type : Square

CONT : 12
VOL : 0.026

132

H-8523 Hydraulic Oil Filter Plastic Element Synthetic Media
KOBELCO FZ1F180K001A
KOBELCO YN52V01011P2
KOBELCO YN52V01013P1



H 1 : 130.5 (mm)
H 2 : 112.5 (mm)
OD 1 : 144 (mm)
OD 2 : 142.5 (mm)
ID 1 : 97 (mm)
ID 2 : 97 (mm)
Top Thread Size : 4 7/16-11 G
Bottom Thread Size : 4 7/16-11 G

CONT : 18
VOL : 0.066

Note : Element Kit version uses H-4101-s

123

O-18051 Oil Filter By Pass Metal End Cap Element
NISSAN 15274-90226
NISSAN 15274-90227
NISSAN 15274-99126
NISSAN 15274-99227



H 1 : 245 (mm)
H 2 : 235 (mm)
OD 1 : 130 (mm)
OD 2 : 130 (mm)
ID 1 : 15.5 (mm)
ID 2 : 15.5 (mm)

CONT : 25
VOL : 0.119

Note : Paper Protector

128

SFC-5706 Fuel/Water Separator Spin-On
J.C.BAMFORD 02/910150
J.C.BAMFORD 02/910150A
HYUNDAI 11E1-70210
CUMMINS 3935274
CASE J925274



H 1 : 163.7 (mm)
H 2 : 134 (mm)
OD 1 : 93 (mm)
OD 2 : 92.7 (mm)
Thread Size : 13/16-18 UNF-2B
Thread Nut Size : M14X2
Gasket Type : Square

CONT : 12
VOL : 0.021

133

HC-7901 Hydraulic Oil Filter Spin-On
INTERNATIONAL HARVESTER 075912103
KOBELCO 2446U141S2



H 1 : 130 (mm)
OD 1 : 93 (mm)
Thread Size : 1 1/8-16 UNF-2B
Gasket Type : Round

CONT : 12
VOL : 0.020

Note : Seat assy zinc coating

124

O-1809 Oil Filter Combination Metal End Cap Element
NISSAN 15274-90225
NISSAN 15274-90228
NISSAN 15274-90229



H 1 : 192 (mm)
H 2 : 182 (mm)
OD 1 : 100 (mm)
OD 2 : 100 (mm)
ID 1 : 40 (mm)
ID 2 : 16.5 (mm)

CONT : 25
VOL : 0.061

129

SFC-7912-30 Fuel/Water Separator Primary Spin-On 30 Micron
HYUNDAI 11LB-20310
SAAB-SCANIA 1393640
ATLAS COPCO 2914807000
VOLVO 8159975



Secondary Filter uses SFC-7912-10
Final Filter uses SFC-7912-02
H 1 : 155.3 (mm)
H 2 : 143.5 (mm)
OD 1 : 108 (mm)
Thread Size : 1-14 UNS-2B
Gasket Type : Square

CONT : 12
VOL : 0.033

Note : for 300RC series,400 series,600 series,700 series

134

O-1006 Oil Filter Combination Metal End Cap Element
KOBELCO 2451U1721A
HYUNDAI 26316-93000
MITSUBISHI ME 034605



H 1 : 192 (mm)
H 2 : 191 (mm)
OD 1 : 110 (mm)
OD 2 : 100 (mm)
ID 1 : 33 (mm)
ID 2 : 19.2 (mm)

CONT : 25
VOL : 0.075

Note : Paper Protector

125

O-6503 Oil Filter Full Flow Metal End Cap Element
GENERAL MOTORS 357304
GENERAL MOTORS 5573014
GENERAL MOTORS 5573102



H 1 : 231 (mm)
H 2 : 227 (mm)
OD 1 : 109.5 (mm)
OD 2 : 109.5 (mm)
ID 1 : 37 (mm)
ID 2 : 37 (mm)

CONT : 12
VOL : 0.043

Note : Metal Protector

130