



SAKURA

KOMATSU

FILTER SUB-CATALOGUE





Table of Contents

Engine Application

A

Technical Specification

B



Engine Application

A

MODEL/APPLICATION	SAKURA NO	MODEL/APPLICATION	SAKURA NO	MODEL/APPLICATION	SAKURA NO
KOMATSU		KOMATSU		KOMATSU	
100-2 (EXCAVATORS) S4D105-5		Fuel Filter.....	FC-5403	Hydraulic Oil Filter Transmission...	H-65030
Air Filter Primary.....	AS-1024	101G (MOTOR GRADERS) V-504		Oil Filter Full Flow.....	0-6503
Air Filter Set.....	AS-1024-S	Fuel Filter.....	FC-1303	118 SERIES B (MOTOR GRADERS) 4-71	
Air Filter Secondary.....	A-6009	Fuel Filter.....	FC-5720	Fuel Filter Secondary.....	F-6502
Fuel Filter.....	FC-5604	Fuel/Water Separator.....	SFC-5705	Fuel Filter.....	F-6505
Hydraulic Oil Filter.....	H-5610	Oil Filter Full Flow.....	0-5702	Hydraulic Oil Filter Transmission...	H-65030
Hydraulic Oil Filter.....	H-56600	104 (MOTOR GRADERS) DETROIT DIESEL		Oil Filter By Pass.....	0-5704
Oil Filter Full Flow.....	C-5614	Fuel Filter Secondary.....	F-6502	Oil Filter Full Flow.....	0-6503
100L-1 (EXCAVATORS) S4D105-5		Fuel Filter.....	F-6505	118 SERIES B (MOTOR GRADERS) H-135CL/7601	
Air Filter Primary.....	AS-1024	Oil Filter Full Flow.....	0-6503	Hydraulic Oil Filter Transmission...	H-65030
Air Filter Set.....	AS-1024-S	1046 (TRACTORS)		Oil Filter Full Flow.....	0-5702
Air Filter Secondary.....	A-6009	Air Filter Secondary.....	A-5309	118 SERIES B (MOTOR GRADERS) NHC4/7601	
Fuel Filter.....	FC-5604	Air Filter Primary.....	A-6201	Hydraulic Oil Filter Transmission...	H-65030
Hydraulic Oil Filter.....	H-56600	Fuel Filter.....	FC-5715	Oil Filter Full Flow.....	0-5702
Hydraulic Oil Filter.....	H-5610	1046A (TRACTORS)		120-1 (EXCAVATORS) S4D105-5	
Oil Filter Full Flow.....	C-5614	Air Filter Secondary.....	A-5309	Air Filter Primary.....	AS-1024
100L-2 (EXCAVATORS) S4D105-5		Air Filter Primary.....	A-6201	Air Filter Secondary.....	A-6009
Air Filter Primary.....	AS-1024	Fuel Filter.....	FC-5715	Air Filter Set.....	AS-1024-S
Air Filter Secondary.....	A-6009	10HQ-2 (EXCAVATORS) 4D92		Fuel Filter.....	FC-5604
Air Filter Set.....	AS-1024-S	Air Filter Primary.....	AS-1014	Hydraulic Oil Filter.....	H-5610
Fuel Filter.....	FC-5604	Fuel Filter.....	FC-5604	Hydraulic Oil Filter.....	H-56600
Hydraulic Oil Filter.....	H-56600	Hydraulic Oil Filter.....	H-5607	Oil Filter Full Flow.....	C-5614
Hydraulic Oil Filter.....	H-5610	Oil Filter Full Flow.....	C-5606	125 (CRANES)	
Oil Filter Full Flow.....	C-5614	10HT (EXCAVATORS) 4D130-1		Fuel Filter.....	FC-5403
100N1 (EXCAVATORS) S4D105-5		Fuel Filter.....	F-1501	125C (LOADERS) D239	
Air Filter Primary.....	AS-1024	Hydraulic Oil Filter.....	H-5611	Fuel Filter.....	FC-5103
Air Filter Secondary.....	A-6009	10HT (EXCAVATORS) 4D92		Fuel Filter.....	FC-5403
Air Filter Set.....	AS-1024-S	Air Filter Primary.....	AS-1014	125B SERIES II (LOADERS) D239	
Fuel Filter.....	FC-5604	Fuel Filter.....	FC-5604	Air Filter Secondary.....	A-76560
Hydraulic Oil Filter.....	H-56600	Hydraulic Oil Filter.....	H-5607	125E (LOADERS) DT239	
Hydraulic Oil Filter.....	H-5610	Oil Filter Full Flow.....	C-5606	Fuel Filter.....	FC-5103
Oil Filter Full Flow.....	C-5614	10HW-2 (EXCAVATORS) 4D92		Fuel Filter.....	FC-5403
100U-2 (EXCAVATORS) S4D105-5		Air Filter Primary.....	AS-1014	12HD-2 (EXCAVATORS) S4S105	
Air Filter Set.....	AS-1024-S	Fuel Filter.....	FC-5604	Air Filter Primary.....	AS-1024
Air Filter Secondary.....	A-6009	Hydraulic Oil Filter.....	H-5607	Air Filter Set.....	AS-1024-S
Air Filter Primary.....	AS-1024	Oil Filter Full Flow.....	C-5606	Air Filter Secondary.....	A-6009
Fuel Filter.....	FC-5604	10HQ (EXCAVATORS) 4D130-1		Fuel Filter.....	FC-5605
Hydraulic Oil Filter.....	H-5610	Fuel Filter.....	F-1501	Oil Filter Full Flow.....	C-5606
Hydraulic Oil Filter.....	H-56600	Hydraulic Oil Filter.....	H-5611	12HL (EXCAVATORS) S4S105	
Oil Filter Full Flow.....	C-5614	10HW-1 (EXCAVATORS) 4D130-1		Air Filter Set.....	AS-1024-S
100C (LOADERS) D206		Fuel Filter.....	F-1501	Air Filter Secondary.....	A-6009
Fuel Filter.....	FC-5103	Hydraulic Oil Filter.....	H-5611	Air Filter Primary.....	AS-1024
Fuel Filter.....	FC-5403	10HW-1 (EXCAVATORS) 4D130-1		Fuel Filter.....	FC-5605
100A (LOADERS) D264		Fuel Filter.....	F-1501	Oil Filter Full Flow.....	C-5606
Air Filter Secondary.....	A-5624	Hydraulic Oil Filter.....	H-5611	12HT (EXCAVATORS) S4S105	
100B SERIES II (LOADERS) D206		111A (MOTOR GRADERS) 4-71N		Air Filter Set.....	AS-1024-S
Air Filter Secondary.....	A-76560	Fuel Filter.....	F-6505	Air Filter Secondary.....	A-6009
100E (LOADERS) D239		Fuel Filter Secondary.....	F-6502	Air Filter Primary.....	AS-1024
Fuel Filter.....	FC-5103	Fuel Filter.....	F-6503	Fuel Filter.....	FC-5605
Fuel Filter.....	FC-5403			Oil Filter Full Flow.....	C-5606

MODEL/APPLICATION	SAKURA NO	MODEL/APPLICATION	SAKURA NO	MODEL/APPLICATION	SAKURA NO
KOMATSU		KOMATSU		KOMATSU	
12HT (EXCAVATORS) S4S105		160 SERIES B (MOTOR GRADERS) CUMMINS		Air Filter Set.....	A-5660-S
Air Filter Primary.....	AS-1024	Fuel Filter.....	FC-5720	Fuel Filter.....	FC-1810
Air Filter Set.....	AS-1024-S	Fuel Filter.....	FC-1303	Fuel Filter.....	FC-7933
Air Filter Secondary.....	A-6009	Fuel/Water Separator.....	SFC-5705	Fuel/Water Separator.....	SFC-5705
Fuel Filter.....	FC-5605	Oil Filter Full Flow.....	O-5702	Hydraulic Oil Filter.....	H-5406
Oil Filter Full Flow.....	C-5606				
140M (DUMP TRUCKS) KTA-19C		160 SERIES C (MOTOR GRADERS) 6-71		175C (LOADERS) DT466B	
Air Filter Secondary.....	A-5715	Fuel Filter.....	F-6505	Air Filter Primary.....	A-5413
Air Filter Primary.....	A-5718	Fuel Filter.....	F-6503	Air Filter Secondary.....	A-5414
Fuel Filter.....	FC-5702	Hydraulic Oil Filter Transmission...	H-65030	Air Filter Set.....	A-5660-S
Fuel/Water Separator.....	SFC-5709-10	Oil Filter Full Flow.....	O-6503	Fuel Filter.....	FC-1810
Fuel/Water Separator.....	SFC-5705			Fuel Filter.....	FC-7933
Oil Filter By Pass.....	C-5718	160 SERIES C (MOTOR GRADERS) CUMMINS		Fuel/Water Separator.....	SFC-5705
Oil Filter Full Flow.....	C-5715	Fuel Filter.....	FC-1303	Hydraulic Oil Filter.....	H-5406
		Fuel Filter.....	FC-5720		
150 SERIES A (MOTOR GRADERS) 4-53		Fuel/Water Separator.....	SFC-5705	180 (MOTOR GRADERS) 12V-71	
Fuel Filter.....	F-6505	Oil Filter Full Flow.....	O-5702	Fuel Filter.....	F-6504
Fuel Filter Secondary.....	F-6502			Oil Filter Full Flow.....	O-6503
		160 SERIES L (MOTOR GRADERS) 6-71			
150A (CRANES)		Fuel Filter.....	F-6503	201 (TRACTORS)	
Fuel Filter.....	F-5701	Fuel Filter.....	F-6505	Oil Filter Full Flow.....	O-7901
Oil Filter By Pass.....	O-5705	Hydraulic Oil Filter Transmission...	H-65030	Oil Filter Full Flow.....	O-1803
		Oil Filter Full Flow.....	O-6503		
150CT (DUMP TRUCKS) C221		160 SERIES L (MOTOR GRADERS) CUMMINS		210LC (EXCAVATORS)	
Fuel Filter.....	F-5501	Fuel Filter.....	FC-5720	Air Filter Secondary.....	A-5671
		Fuel Filter.....	FC-1303	Air Filter Set.....	AS-5672-S
150FA (CRANES)		Fuel/Water Separator.....	SFC-5705	Air Filter Primary.....	AS-5670
Fuel Filter.....	F-5701	Oil Filter Full Flow.....	O-5702	Fuel Filter Secondary.....	FC-7903
Oil Filter By Pass.....	O-5705			Fuel/Water Separator.....	SFC-5708
		165 (LOADERS) D310		Fuel/Water Separator.....	SFC-5706
160 (MOTOR GRADERS) 6-71		Fuel Filter.....	FC-5103	Fuel/Water Separator.....	SFC-5706
Fuel Filter.....	F-6505	Hydraulic Oil Filter Transmission...	H-65030	Hydraulic Oil Filter.....	H-7911
Fuel Filter.....	F-6503			Hydraulic Oil Filter.....	H-85680
Hydraulic Oil Filter Transmission...	H-65030	175B (LOADERS) D361		210M (DUMP TRUCKS) KTTA-19C	
Oil Filter Full Flow.....	O-6503	Air Filter Primary.....	AS-5628	Fuel Filter.....	FC-5702
		Air Filter.....	A-85370	Fuel/Water Separator.....	SFC-5709-10
160 (MOTOR GRADERS) CUMMINS		Air Filter Primary.....	A-5628	Fuel/Water Separator.....	SFC-5705
Fuel Filter.....	FC-5720	Air Filter Set.....	A-5628-S	Oil Filter By Pass.....	C-5718
Fuel Filter.....	FC-1303			Oil Filter Full Flow.....	C-5715
Fuel/Water Separator.....	SFC-5705	175B (LOADERS) DT407		220-2 (EXCAVATORS) S6D105-1	
Oil Filter Full Flow.....	O-5702	Air Filter.....	A-85370	Air Filter Primary.....	A-6113
		Fuel Filter.....	FC-1810	Air Filter Secondary.....	A-5408
160 Series A (MOTOR GRADERS) 6-71		Fuel/Water Separator.....	SFC-5705	Hydraulic Oil Filter.....	H-5609
Fuel Filter.....	F-6505			Hydraulic Oil Filter.....	H-85680
Fuel Filter.....	F-6503	175B (LOADERS) UD-407		Hydraulic Oil Filter.....	H-7911
Hydraulic Oil Filter Transmission...	H-65030	Air Filter Primary.....	AS-5628	Hydraulic Oil Filter.....	H-7911
Oil Filter Full Flow.....	O-6503	Air Filter.....	A-85370	Oil Filter Full Flow.....	C-5614
		Air Filter Primary.....	A-5628	220LC-3 (EXCAVATORS) S6D105-1	
160 Series A (MOTOR GRADERS) CUMMINS		Air Filter Set.....	A-5628-S	Air Filter Secondary.....	A-5408
Fuel Filter.....	FC-1303	Fuel Filter.....	FC-1810	Air Filter Primary.....	A-6113
Fuel Filter.....	FC-5720	Fuel/Water Separator.....	SFC-5705	Hydraulic Oil Filter.....	H-85680
Fuel/Water Separator.....	SFC-5705			Hydraulic Oil Filter.....	H-7911
Oil Filter Full Flow.....	O-5702	175C (LOADERS) DT466		Hydraulic Oil Filter.....	H-5609
		Air Filter Primary.....	A-5413	Oil Filter Full Flow.....	C-5614
		Air Filter Secondary.....	A-5414	222G (MOTOR GRADERS) 8V-71T	

Sakura Filter

ENGINE APPLICATION

MODEL/APPLICATION	SAKURA NO	MODEL/APPLICATION	SAKURA NO	MODEL/APPLICATION	SAKURA NO
KOMATSU		KOMATSU		KOMATSU	
222G (MOTOR GRADERS) 8V-71T		Fuel Filter Secondary.....	FC-54050	Air Filter.....	A-8545
Air Filter Secondary.....	A-7915	Fuel/Water Separator.....	SFC-5705	Hydraulic Oil Filter Transmission....	H-65030
Air Filter Primary.....	A-7912	Oil Filter Full Flow.....	C-5402	295 SERIES B (MOTOR GRADERS)	
Air Filter Set.....	A-7912-S	250E (LOADERS) LTA10		Fuel Filter.....	FC-1810
Fuel Filter.....	F-6505	Air Filter Primary.....	A-5420	Fuel/Water Separator.....	SFC-5705
Fuel Filter Primary.....	FC-6501	Air Filter Set.....	A-5420-S	Hydraulic Oil Filter Transmission....	H-65030
Fuel Filter.....	F-6503	Fuel Filter.....	FC-5720	2FD25S-5 (FORKLIFTS)	
Fuel Filter Secondary.....	FC-6502	Fuel/Water Separator.....	SFC-5705	Air Filter Primary.....	AS-2205
Fuel Filter.....	F-7302	Oil Filter Full Flow.....	C-5715	Fuel Filter.....	FC-1802
Fuel/Water Separator.....	SFC-7301	Oil Filter By Pass.....	C-5718	300-2 (EXCAVATORS) NT-855	
Hydraulic Oil Filter Transmission....	H-65030	2514B (LOADERS)		Air Filter Primary.....	A-6113
Oil Filter Full Flow.....	O-6503	Oil Filter Full Flow.....	C-5814	Air Filter Secondary.....	A-5408
229G (MOTOR GRADERS) 8V-71T		Oil Filter Full Flow.....	C-5405	Fuel Filter.....	FC-5602
Air Filter Secondary.....	A-7915	252FT (MOTOR GRADERS) FRONT ENGINE		Hydraulic Oil Filter.....	H-85680
Air Filter Primary.....	A-7912	Air Filter Secondary.....	A-7915	Hydraulic Oil Filter.....	H-7911
Air Filter Set.....	A-7912-S	Air Filter Primary.....	A-7912	Oil Filter Full Flow.....	C-5715
Fuel Filter Primary.....	FC-6501	Air Filter Set.....	A-7912-S	Oil Filter Full Flow.....	C-5701
Fuel Filter.....	F-6503	Fuel Filter Secondary.....	FC-6502	Oil Filter By Pass.....	O-5704
Fuel Filter Secondary.....	FC-6502	Fuel Filter.....	F-7302	Oil Filter Full Flow.....	C-5605
Fuel Filter.....	F-6505	Fuel Filter.....	F-6503	300LC-1 (EXCAVATORS) NT-855	
Fuel Filter.....	F-7302	Fuel Filter Primary.....	FC-6501	Air Filter Primary.....	A-6113
Fuel/Water Separator.....	SFC-7301	Fuel/Water Separator.....	SFC-7301	Air Filter Secondary.....	A-5408
Hydraulic Oil Filter Transmission....	H-65030	Oil Filter Full Flow.....	O-6503	Fuel Filter.....	FC-5602
Oil Filter Full Flow.....	O-6503	252FT (MOTOR GRADERS) REAR ENGINE		Hydraulic Oil Filter.....	H-85680
2400A (LOADERS)		Air Filter Secondary.....	A-5417	Hydraulic Oil Filter.....	H-7911
Fuel Filter.....	FC-5103	Air Filter Primary.....	A-5425	Oil Filter Full Flow.....	C-5715
Fuel Filter.....	FC-5403	Fuel Filter Secondary.....	FC-6502	Oil Filter By Pass.....	O-5704
Oil Filter Full Flow.....	C-5405	Fuel Filter.....	F-7302	Oil Filter Full Flow.....	C-5605
Oil Filter Full Flow.....	C-5814	Fuel Filter.....	F-6503	Oil Filter Full Flow.....	C-5701
240A (LOADERS)		Fuel Filter Primary.....	FC-6501	321 (LOADERS)	
Fuel Filter.....	FC-5715	Fuel/Water Separator.....	SFC-7301	Fuel Filter.....	F-2601
Fuel Filter.....	FC-5103	Hydraulic Oil Filter Transmission....	H-65030	Fuel Filter.....	FC-5103
Oil Filter Full Flow.....	C-5405	Oil Filter Full Flow.....	O-6503	Oil Filter Full Flow.....	C-1122
Oil Filter Full Flow.....	C-5814	260A (LOADERS)		323 (LOADERS)	
2412B (LOADERS)		Fuel Filter.....	FC-5103	Fuel Filter.....	F-2601
Fuel Filter.....	FC-5103	Oil Filter Full Flow.....	C-5405	Fuel Filter.....	FC-5103
Fuel Filter.....	FC-5403	Oil Filter Full Flow.....	C-5814	Oil Filter Full Flow.....	C-1122
Oil Filter Full Flow.....	C-5814	270 (MOTOR GRADERS) DVT-573		330 (DUMP TRUCKS) CUMMINS	
Oil Filter Full Flow.....	C-5405	Air Filter.....	A-5410	Fuel Filter.....	FC-5720
2500A (LOADERS)		Fuel Filter.....	FC-1810	Fuel Filter.....	FC-1303
Oil Filter Full Flow.....	C-5814	Fuel/Water Separator.....	SFC-5705	Fuel Filter.....	F-5701
Oil Filter Full Flow.....	C-5405	Hydraulic Oil Filter Transmission....	H-65030	Fuel/Water Separator.....	SFC-5705
250A (LOADERS)		270A (LOADERS)		Hydraulic Oil Filter Transmission....	H-65030
Hydraulic Oil Filter.....	H-5406	Fuel Filter.....	FC-5403	Oil Filter Full Flow.....	O-6503
Oil Filter Full Flow.....	C-5814	Hydraulic Oil Filter.....	H-5406	Oil Filter Full Flow.....	C-8031
Oil Filter Full Flow.....	C-5405	270 D (MOTOR GRADERS)		Oil Filter Full Flow.....	O-5702
250C (LOADERS) DVT-573B		Fuel Filter.....	FC-5103	330 (DUMP TRUCKS) DETROIT DIESEL	
Air Filter Secondary.....	A-5406	295 (MOTOR GRADERS) DT817		Fuel Filter.....	F-6503
Air Filter Set.....	A-5405-S			Fuel Filter.....	F-6505
Air Filter Primary.....	A-5405			Fuel Filter Secondary.....	F-6502

Sakura Filter

ENGINE APPLICATION

MODEL/APPLICATION	SAKURA NO	MODEL/APPLICATION	SAKURA NO	MODEL/APPLICATION	SAKURA NO
KOMATSU		KOMATSU		KOMATSU	
330 (DUMP TRUCKS) DETROIT DIESEL		Fuel/Water Separator.....	SFC-5705	Oil Filter Full Flow.....	0-1803
Oil Filter Full Flow.....	0-6503	Hydraulic Oil Filter Transmission...	H-65030	4125 (LOADERS) B48 GAS	
330 (DUMP TRUCKS) KTA38		Oil Filter Full Flow.....	0-5702	Oil Filter Full Flow.....	C-6210
Fuel Filter.....	FC-5703	Oil Filter Full Flow.....	C-8031	4135 (LOADERS) NHC GAS	
Fuel/Water Separator.....	SFC-5707	353 (LOADERS)		Oil Filter Full Flow.....	C-6210
Fuel/Water Separator.....	SFC-5601-02	Fuel Filter.....	F-2603	4130 (LOADERS) NHCV	
Oil Filter By Pass.....	0-5704	Oil Filter Full Flow.....	C-1122	Air Filter.....	AS-5412
330H (MOTOR GRADERS) CUMMINS		35C (DUMP TRUCKS) DETROIT DIESEL		Oil Filter Full Flow.....	C-1828
Fuel Filter.....	FC-5720	Fuel Filter.....	F-6504	4130 (LOADERS) S6D170-1(QTY 2) GAS	
Fuel Filter.....	FC-1303	Hydraulic Oil Filter Transmission...	H-65030	Oil Filter Full Flow.....	C-1828
Fuel Filter.....	F-5701	Oil Filter Full Flow.....	0-6503	Oil Filter Full Flow.....	C-6210
Fuel/Water Separator.....	SFC-5705	3600A (LOADERS)		4140 (LOADERS) 3AB1	
Hydraulic Oil Filter Transmission...	H-65030	Oil Filter Full Flow.....	C-5814	Air Filter Primary.....	AS-2205
Oil Filter Full Flow.....	0-5702	385 (DUMP TRUCKS) KTA38		Oil Filter Full Flow.....	C-6210
Oil Filter Full Flow.....	C-8031	Fuel Filter.....	FC-5703	4140 (LOADERS) H105 GAS	
Oil Filter Full Flow.....	0-6503	Fuel/Water Separator.....	SFC-5707	Air Filter Primary.....	AS-2205
330H (MOTOR GRADERS) DETROIT DIESEL		Fuel/Water Separator.....	SFC-5601-02	Oil Filter Full Flow.....	C-1828
Fuel Filter Secondary.....	F-6502	Oil Filter By Pass.....	0-5704	Oil Filter Full Flow.....	C-6210
Fuel Filter.....	F-6503	3960 (EXCAVATORS)		4150 (LOADERS) DF172	
Fuel Filter.....	F-6505	Air Filter Primary.....	AS-5628	Air Filter Primary.....	AS-1014
Oil Filter Full Flow.....	0-6503	Air Filter Primary.....	A-5628	Oil Filter Full Flow.....	C-1914
330M (DUMP TRUCKS) KTA-38C		Air Filter Set.....	A-5628-S	Oil Filter Full Flow.....	C-7602
Fuel/Water Separator.....	SFC-5601-02	3964 (EXCAVATORS)		4150 (LOADERS) GF172	
Fuel/Water Separator.....	SFC-5707	Air Filter Primary.....	AS-5628	Air Filter Primary.....	AS-1014
Oil Filter Full Flow.....	C-5715	Air Filter Primary.....	A-5628	Oil Filter Full Flow.....	C-1914
Oil Filter By Pass.....	C-5718	Air Filter Set.....	A-5628-S	Oil Filter Full Flow.....	C-7602
333CSF (MOTOR GRADERS) 12V-71T		Fuel Filter.....	FC-5403	4150 (LOADERS) M4-121G	
Fuel Filter.....	F-6504	3964B (EXCAVATORS) D358		Oil Filter Full Flow.....	C-6210
Fuel Filter.....	F-7302	Fuel Filter.....	FC-5715	423 (LOADERS)	
Oil Filter Full Flow.....	0-6503	Hydraulic Oil Filter.....	H-5406	Fuel Filter.....	F-2603
333F (MOTOR GRADERS) 12V-71T		3964B-LGP (EXCAVATORS) D358		Oil Filter Full Flow.....	C-1122
Fuel Filter.....	F-6504	Fuel Filter.....	FC-5715	431 (MOTOR GRADERS)	
Fuel Filter.....	F-7302	Hydraulic Oil Filter.....	H-5406	Fuel Filter Secondary.....	FC-54050
Oil Filter Full Flow.....	0-6503	3965B (EXCAVATORS) D358		Fuel/Water Separator.....	SFC-5705
333FT (MOTOR GRADERS) 12V-71 FRONT & REAR		Fuel Filter.....	FC-5715	Hydraulic Oil Filter.....	H-5406
Air Filter Secondary.....	A-5610	Hydraulic Oil Filter.....	H-5406	Oil Filter Full Flow.....	C-5402
Air Filter Primary.....	A-5618	3984 (EXCAVATORS) D358		433 (MOTOR GRADERS)	
Fuel Filter.....	F-6504	Fuel Filter.....	FC-5715	Air Filter Secondary.....	A-5114
Fuel Filter.....	F-7302	Hydraulic Oil Filter.....	H-5406	Air Filter Primary.....	A-6808
Oil Filter Full Flow.....	0-6503	3984B (EXCAVATORS) D358		Fuel Filter Secondary.....	FC-54050
35 (DUMP TRUCKS) DETROIT DIESEL		Fuel Filter.....	FC-5715	Fuel Filter.....	FC-1810
Fuel Filter.....	F-6504	Hydraulic Oil Filter.....	H-5406	Fuel Filter.....	FC-7933
Hydraulic Oil Filter Transmission...	H-65030	400 (DOZERS)		Fuel Filter.....	FC-5103
Oil Filter Full Flow.....	0-6503	Oil Filter Full Flow.....	C-1914	Fuel/Water Separator.....	SFC-5705
35 (DUMP TRUCKS) NT-380					
Fuel Filter.....	FC-5720				
Fuel Filter.....	FC-1303				

MODEL/APPLICATION	SAKURA NO	MODEL/APPLICATION	SAKURA NO	MODEL/APPLICATION	SAKURA NO
KOMATSU		KOMATSU		KOMATSU	
433 (MOTOR GRADERS)		Fuel Filter Secondary.....	F-6502	Oil Filter Full Flow.....	C-8031
Oil Filter Full Flow.....	C-1122	Fuel Filter.....	F-6503	500C (DOZERS)	
Oil Filter Full Flow.....	C-5402	Oil Filter Full Flow.....	0-6503	Fuel Filter.....	FC-5103
434 (LOADERS) 1961		444 (MOTOR GRADERS) N-855C		Fuel Filter.....	FC-5715
Fuel Filter.....	FC-5103	Coolant Filter.....	WC-5705	Oil Filter Full Flow.....	C-1914
Oil Filter Full Flow.....	0-1803	Fuel Filter.....	FC-5702	Oil Filter Full Flow.....	C-5814
434 (LOADERS)		Oil Filter By Pass.....	0-5704	505 (LOADERS) 4D92	
Fuel Filter.....	FC-5103	Oil Filter Full Flow.....	C-5715	Fuel Filter.....	FC-5604
Oil Filter Full Flow.....	0-1803	Oil Filter Full Flow.....	0-5702	Hydraulic Oil Filter.....	H-5618
435 (TRACTORS)		444 (MOTOR GRADERS)		Oil Filter Full Flow.....	C-5606
Oil Filter Full Flow.....	0-1803	Fuel Filter.....	FC-1810	510 (LOADERS) 4D92	
Oil Filter Full Flow.....	0-7901	Fuel Filter.....	FC-7933	Air Filter Secondary.....	A-5617
440 (MOTOR GRADERS) CUMMINS		Fuel Filter Secondary.....	FC-54050	Air Filter Primary.....	A-5616
Fuel Filter.....	FC-5720	Fuel/Water Separator.....	SFC-5705	Air Filter Set.....	A-5655-S
Fuel Filter.....	FC-1303	Oil Filter Full Flow.....	C-5402	Fuel Filter.....	FC-5605
Fuel Filter.....	F-5701	445E (DUMP TRUCKS) KTA38		Hydraulic Oil Filter.....	H-5618
Fuel/Water Separator.....	SFC-5705	Fuel Filter.....	FC-5703	Oil Filter Full Flow.....	C-5606
Hydraulic Oil Filter Transmission...	H-65030	Fuel/Water Separator.....	SFC-5601-02	Oil Filter Full Flow.....	C-6203
Oil Filter Full Flow.....	0-5702	Fuel/Water Separator.....	SFC-5707	510 (LOADERS) KTA38	
Oil Filter Full Flow.....	C-8031	Oil Filter By Pass.....	0-5704	Fuel Filter.....	FC-5703
Oil Filter Full Flow.....	0-6503	495 (MOTOR GRADERS) DT817		Fuel/Water Separator.....	SFC-5601-02
440 (MOTOR GRADERS) DETROIT DIESEL		Air Filter.....	A-8545	Fuel/Water Separator.....	SFC-5707
Fuel Filter.....	F-6503	Hydraulic Oil Filter Transmission...	H-65030	Oil Filter Full Flow.....	C-5715
Fuel Filter.....	F-6505	500 (DOZERS) D155		Oil Filter Full Flow.....	C-5701
Fuel Filter Secondary.....	F-6502	Air Filter Primary.....	AS-1014	Oil Filter Full Flow.....	C-5605
Oil Filter Full Flow.....	0-6503	500 (DOZERS) D348		510 (LOADERS)	
440H (MOTOR GRADERS) CUMMINS		Air Filter Primary.....	AS-1014	Air Filter Primary.....	A-6207
Fuel Filter.....	F-5701	500 (DOZERS) DIESEL		Air Filter Primary.....	AS-5628
Fuel Filter.....	FC-1303	Fuel Filter.....	FC-5103	Air Filter Primary.....	AS-7805
Fuel Filter.....	FC-5720	Oil Filter Full Flow.....	C-1914	Air Filter Primary.....	A-5628
Fuel/Water Separator.....	SFC-5705	500E (LOADERS) D155		Air Filter Set.....	A-5628-S
Hydraulic Oil Filter Transmission...	H-65030	Fuel Filter.....	FC-5103	Air Filter Secondary.....	A-6302
Oil Filter Full Flow.....	0-6503	Oil Filter Full Flow.....	C-1914	510B (LOADERS) D240T	
Oil Filter Full Flow.....	0-5702	Oil Filter Full Flow.....	C-5814	Air Filter Secondary.....	A-7806
Oil Filter Full Flow.....	C-8031	50 (DUMP TRUCKS) 12V-71		Air Filter Primary.....	AS-7805
440H (MOTOR GRADERS) DETROIT DIESEL		Air Filter.....	A-85400	Fuel Filter Secondary.....	FC-7903
Fuel Filter.....	F-6503	Fuel Filter.....	F-6504	Fuel/Water Separator.....	SFC-5706
Fuel Filter.....	F-6505	Oil Filter Full Flow.....	0-6503	Fuel/Water Separator.....	SFC-5708
Fuel Filter Secondary.....	F-6502	50 (DUMP TRUCKS) 14BD264		Oil Filter Full Flow.....	C-5730
Oil Filter Full Flow.....	0-6503	Air Filter.....	A-85400	Oil Filter Full Flow.....	C-5703
442 (MOTOR GRADERS)		Fuel Filter.....	F-6504	510C (LOADERS) D240T	
Fuel Filter Secondary.....	FC-54050	Oil Filter Full Flow.....	0-6503	Air Filter Primary.....	AS-7805
Fuel/Water Separator.....	SFC-5705	50 (DUMP TRUCKS) VT-1710		Air Filter Secondary.....	A-7806
Hydraulic Oil Filter.....	H-5406	Air Filter.....	A-85400	Fuel Filter Secondary.....	FC-7903
Oil Filter Full Flow.....	C-5402	Fuel Filter.....	F-6504	Fuel/Water Separator.....	SFC-5708
444 (MOTOR GRADERS) 4-71N		Oil Filter Full Flow.....	0-6503	Fuel/Water Separator.....	SFC-5706
Fuel Filter.....	F-6505	50 (DUMP TRUCKS) VT-1710		Oil Filter Full Flow.....	C-5703
		Air Filter.....	A-85400	Oil Filter Full Flow.....	C-5730
		Fuel Filter.....	F-5701	510E (DUMP TRUCKS) 12V-149T1B	
		Oil Filter Full Flow.....	0-5702		

Sakura Filter

ENGINE APPLICATION

MODEL/APPLICATION	SAKURA NO	MODEL/APPLICATION	SAKURA NO	MODEL/APPLICATION	SAKURA NO
KOMATSU		KOMATSU		KOMATSU	
510E (DUMP TRUCKS) 12V-149T1B		Oil Filter Full Flow.....	C-5730	540 (LOADERS) SA6D110-1	
Fuel Filter.....	FC-6506	520EH (LOADERS) S6D102E-1/46082941		Air Filter Secondary.....	A-5406
Fuel Filter.....	FC-6505	Air Filter Secondary.....	A-5667	Air Filter.....	A-5434
Oil Filter Full Flow.....	C-5731	Air Filter Primary.....	A-5666	Fuel Filter.....	FC-5602
Oil Filter Full Flow.....	C-7005	523 (LOADERS)		Hydraulic Oil Filter.....	H-5618
510E (DUMP TRUCKS) KTTA-38C		Fuel Filter.....	F-2603	Oil Filter Full Flow.....	C-5614
Oil Filter Full Flow.....	C-5715	Oil Filter Full Flow.....	C-1122	550 (MOTOR GRADERS) CUMMINS	
Oil Filter By Pass.....	C-5718	523A (LOADERS)		Fuel Filter.....	FC-1303
515 (LOADERS) DA220		Fuel Filter.....	F-2603	Fuel Filter.....	FC-5720
Fuel Filter.....	F-1303	Oil Filter Full Flow.....	C-1122	Fuel Filter.....	F-5701
515 (LOADERS)		530 (LOADERS)		Fuel/Water Separator.....	SFC-5705
Fuel Filter.....	FC-7933	Air Filter Primary.....	A-5413	Hydraulic Oil Filter Transmission....	H-65030
Fuel/Water Separator.....	SFC-5705	Air Filter Secondary.....	A-5414	Oil Filter Full Flow.....	O-6503
515B (LOADERS)		Air Filter Set.....	A-5660-S	Oil Filter Full Flow.....	O-5702
Fuel Filter.....	FC-5403	Air Filter Primary.....	A-6207	Oil Filter Full Flow.....	C-8031
Hydraulic Oil Filter.....	H-5406	Air Filter Secondary.....	A-6302	550 (MOTOR GRADERS) DETROIT DIESEL	
515C (LOADERS) D358		Fuel Filter.....	FC-7933	Fuel Filter.....	F-6503
Air Filter Secondary.....	A-7964	Fuel/Water Separator.....	SFC-5705	Fuel Filter Secondary.....	F-6502
Fuel Filter.....	F-2604	530A (LOADERS)		Fuel Filter.....	F-6505
Fuel Filter.....	FC-5103	Air Filter Primary.....	A-6207	Oil Filter Full Flow.....	O-6503
Hydraulic Oil Filter.....	HC-5402	Air Filter Secondary.....	A-5414	550 (MOTOR GRADERS)	
520 (LOADERS)		Coolant Filter.....	WC-5707	Air Filter Set.....	A-5420-S
Air Filter Primary.....	A-6207	Hydraulic Oil Filter.....	H-5618	Air Filter Primary.....	A-5420
Air Filter Secondary.....	A-6302	Oil Filter Full Flow.....	C-5614	Coolant Filter.....	WC-5705
520B (LOADERS) D359T		530A (LOADERS)		Fuel Filter Secondary.....	FC-54050
Air Filter Primary.....	A-1313	Air Filter Primary.....	A-6207	Fuel/Water Separator.....	SFC-5705
Air Filter Secondary.....	A-1307	Air Filter Secondary.....	A-6302	Oil Filter Full Flow.....	C-5402
Air Filter Set.....	A-5662-S	Fuel Filter.....	FC-5403	55 (MOTOR GRADERS) HR-6	
Fuel Filter Secondary.....	FC-7903	530E (DUMP TRUCKS) KTA50		Fuel Filter.....	FC-1303
Fuel/Water Separator.....	SFC-5706	Fuel Filter.....	FC-5703	Fuel Filter.....	FC-5720
Fuel/Water Separator.....	SFC-5708	Fuel/Water Separator.....	SFC-5707	Fuel/Water Separator.....	SFC-5705
Oil Filter Full Flow.....	C-5730	Fuel/Water Separator.....	SFC-5601-02	555 (MOTOR GRADERS) 6-71N	
520C (LOADERS) D359T		Oil Filter Full Flow.....	C-5605	Fuel Filter.....	F-6505
Air Filter Primary.....	A-1313	Oil Filter Full Flow.....	C-5701	Fuel Filter.....	F-6503
Air Filter Secondary.....	A-1307	Oil Filter Full Flow.....	C-5715	Oil Filter Full Flow.....	O-6503
Air Filter Set.....	A-5662-S	Oil Filter By Pass.....	O-5704	555 (MOTOR GRADERS) N-855C	
Fuel Filter Secondary.....	FC-7903	530M (DUMP TRUCKS) KTA50		Coolant Filter.....	WC-5705
Fuel/Water Separator.....	SFC-5706	Fuel Filter.....	FC-5703	Fuel Filter.....	FC-5702
Fuel/Water Separator.....	SFC-5708	Fuel/Water Separator.....	SFC-5707	Oil Filter By Pass.....	O-5704
Oil Filter Full Flow.....	C-5730	Fuel/Water Separator.....	SFC-5601-02	Oil Filter Full Flow.....	O-5702
520CH (LOADERS) D359T		Oil Filter By Pass.....	O-5704	Oil Filter Full Flow.....	C-5715
Air Filter Primary.....	A-1313	Oil Filter Full Flow.....	C-5605	560 (LOADERS) KT-1150	
Air Filter Secondary.....	A-1307	Oil Filter Full Flow.....	C-5715	Coolant Filter.....	WC-5705
Air Filter Set.....	A-5662-S	Oil Filter Full Flow.....	C-5701	Fuel Filter.....	FC-5702
Fuel Filter Secondary.....	FC-7903	540 (LOADERS) 3D94-2		Oil Filter Full Flow.....	C-5715
Fuel/Water Separator.....	SFC-5706	Fuel/Water Separator.....	SFC-5705	Oil Filter By Pass.....	C-5718
Fuel/Water Separator.....	SFC-5708	560 (LOADERS)		560 (LOADERS)	
Oil Filter Full Flow.....	C-5730	Fuel Filter.....	FC-5403	Fuel Filter.....	FC-5403

Sakura Filter

ENGINE APPLICATION

MODEL/APPLICATION	SAKURA NO	MODEL/APPLICATION	SAKURA NO	MODEL/APPLICATION	SAKURA NO
KOMATSU		KOMATSU		KOMATSU	
560 (LOADERS)		60N-1 (EXCAVATORS) 4D94-2		Fuel Filter.....	FC-1303
Fuel Filter Secondary.....	FC-54050	Fuel Filter.....	FC-5604	Fuel Filter.....	FC-5720
Fuel/Water Separator.....	SFC-5705	Hydraulic Oil Filter.....	H-5607	Fuel/Water Separator.....	SFC-5705
Oil Filter Full Flow.....	C-5402	Oil Filter Full Flow.....	C-5606		
560B (LOADERS) KT-1150		60U-1 (EXCAVATORS) 4D94-2D		75B (LOADERS) 16V-71T	
Coolant Filter.....	WC-5705	Air Filter Primary.....	AS-1014	Fuel Filter.....	F-6504
Fuel Filter.....	FC-5702	Fuel Filter.....	FC-5604	Oil Filter Full Flow.....	O-6503
Oil Filter Full Flow.....	C-5715	Hydraulic Oil Filter.....	H-5607		
Oil Filter By Pass.....	C-5718	Oil Filter Full Flow.....	C-5606	75B (LOADERS) VTA-1710	
60 (DUMP TRUCKS) 12V-71		60U-2 (EXCAVATORS) 4D94-2D		Coolant Filter.....	WC-5705
Air Filter.....	A-85400	Air Filter Primary.....	AS-1014	Fuel Filter.....	FC-5703
Fuel Filter.....	F-6504	Fuel Filter.....	FC-5604	Fuel/Water Separator.....	SFC-5707
Oil Filter Full Flow.....	O-6503	Hydraulic Oil Filter.....	H-5607	Oil Filter Full Flow.....	C-5715
60 (DUMP TRUCKS) 14BD264		650R-3 (MOTOR GRADERS) S/N: 24001		Oil Filter By Pass.....	O-5704
Air Filter.....	A-85400	Air Filter Secondary.....	A-5606		
Fuel Filter.....	F-6504	Air Filter Primary.....	A-5605	777 (MOTOR GRADERS) CUMMINS	
Oil Filter Full Flow.....	O-6503	Air Filter Set.....	A-5604-S	Fuel Filter.....	FC-1303
60 (DUMP TRUCKS) VT-1710		Fuel Filter.....	FC-5602	Fuel Filter.....	F-5701
Air Filter.....	A-85400	Hydraulic Oil Filter.....	H-5620	Fuel Filter.....	FC-5720
Fuel Filter.....	F-5701	Oil Filter Full Flow.....	C-5614	Fuel/Water Separator.....	SFC-5705
Oil Filter Full Flow.....	O-5702	655-3 (MOTOR GRADERS) 34001		Hydraulic Oil Filter Transmission...	H-65030
Oil Filter Full Flow.....	C-8031	Air Filter Set.....	A-5604-S	Oil Filter Full Flow.....	C-8031
600SD1-C (DOZERS)		Air Filter Secondary.....	A-5606	Oil Filter Full Flow.....	O-5702
Fuel Filter.....	F-7302	Air Filter Primary.....	A-5605	Oil Filter Full Flow.....	O-6503
Fuel Filter.....	F-6503	Fuel Filter.....	FC-5602		
Oil Filter Full Flow.....	O-6503	Hydraulic Oil Filter.....	H-5620	777 (MOTOR GRADERS) DETROIT DIESEL	
60-1 (EXCAVATORS) 4D94-2D		Oil Filter Full Flow.....	C-5614	Fuel Filter.....	F-6503
Air Filter Primary.....	AS-1014	666 (MOTOR GRADERS) CUMMINS		Fuel Filter.....	F-6505
Fuel Filter.....	FC-5604	Fuel Filter.....	FC-1303	Fuel Filter Secondary.....	F-6502
Hydraulic Oil Filter.....	H-5607	Fuel Filter.....	F-5701	Oil Filter Full Flow.....	O-6503
Oil Filter Full Flow.....	C-5606	Fuel Filter.....	FC-5720		
60L (EXCAVATORS) 4D94-2D		Fuel/Water Separator.....	SFC-5705	830C (MOTOR GRADERS) 6BT5.9	
Air Filter Primary.....	AS-1014	Hydraulic Oil Filter Transmission...	H-65030	Fuel Filter Secondary.....	FC-7903
Fuel Filter.....	FC-5604	Oil Filter Full Flow.....	O-5702	Fuel/Water Separator.....	SFC-5706
Hydraulic Oil Filter.....	H-5607	Oil Filter Full Flow.....	O-6503	Fuel/Water Separator.....	SFC-5708
Oil Filter Full Flow.....	C-5606	Oil Filter Full Flow.....	C-8031	Oil Filter Full Flow.....	C-5730
60L-1 (EXCAVATORS) 4D94-2D		666 (MOTOR GRADERS) DETROIT DIESEL		830C (MOTOR GRADERS) D359T	
Air Filter Primary.....	AS-1014	Fuel Filter Secondary.....	F-6502	Air Filter Secondary.....	A-7614
Fuel Filter.....	FC-5604	Fuel Filter.....	F-6503	Air Filter Primary.....	A-7615
Hydraulic Oil Filter.....	H-5607	Fuel Filter.....	F-6505	Air Filter Set.....	A-7615-S
Oil Filter Full Flow.....	C-5606	Oil Filter Full Flow.....	O-6503	Fuel Filter Secondary.....	FC-7903
60L-2 (EXCAVATORS) 4D94-2D		730E (DUMP TRUCKS) SSA16V159		Fuel/Water Separator.....	SFC-5708
Air Filter Primary.....	AS-1014	Air Filter Secondary.....	A-7902	Fuel/Water Separator.....	SFC-5706
Fuel Filter.....	FC-5604	Fuel/Water Separator.....	SFC-5601-02	Hydraulic Oil Filter.....	HC-76080
Hydraulic Oil Filter.....	H-5607	Oil Filter Full Flow.....	C-5701	Oil Filter Full Flow.....	C-5730
Oil Filter Full Flow.....	C-5606	Oil Filter Full Flow.....	C-5605		
75 (MOTOR GRADERS) NT-6				830B (MOTOR GRADERS) D359T	
				Fuel Filter Secondary.....	FC-7903
				Fuel/Water Separator.....	SFC-5706
				Fuel/Water Separator.....	SFC-5708
				Oil Filter Full Flow.....	C-5730
				830B (MOTOR GRADERS) D359T	
				Air Filter Set.....	A-7615-S
				Air Filter Secondary.....	A-7614
				Air Filter Primary.....	A-7615
				Fuel Filter Secondary.....	FC-7903

Sakura Filter

ENGINE APPLICATION

MODEL/APPLICATION	SAKURA NO	MODEL/APPLICATION	SAKURA NO	MODEL/APPLICATION	SAKURA NO
KOMATSU		KOMATSU		KOMATSU	
830B (MOTOR GRADERS) D359T		Fuel Filter Secondary.....	FC-7903	870B (MOTOR GRADERS) D505T	
Fuel/Water Separator.....	SFC-5708	Fuel/Water Separator.....	SFC-5706	Air Filter Set.....	A-7615-S
Fuel/Water Separator.....	SFC-5706	Fuel/Water Separator.....	SFC-5708	Air Filter Primary.....	A-7615
Hydraulic Oil Filter.....	HC-76080	Oil Filter Combination.....	C-5723	Air Filter Secondary.....	A-7614
Oil Filter Full Flow.....	C-5730	Oil Filter Combination.....	C-5707	Fuel Filter Secondary.....	FC-7903
830E (DUMP TRUCKS) 16V-149		850B (MOTOR GRADERS) D505T		Fuel/Water Separator.....	SFC-5706
Air Filter Secondary.....	A-9205	Air Filter Primary.....	A-7615	Fuel/Water Separator.....	SFC-5708
Fuel Filter.....	FC-6506	Air Filter Set.....	A-7615-S	Hydraulic Oil Filter.....	HC-76080
Fuel Filter.....	FC-6505	Air Filter Secondary.....	A-7614	Oil Filter Combination.....	C-57390
Fuel/Water Separator.....	SFC-5601-02	Fuel Filter Secondary.....	FC-7903	Oil Filter Full Flow.....	C-1305
Oil Filter Full Flow.....	C-7005	Fuel/Water Separator.....	SFC-5708	Oil Filter Combination.....	C-7927
Oil Filter Full Flow.....	C-5731	Fuel/Water Separator.....	SFC-5706	870C (MOTOR GRADERS) 6CT8.3	
830E (DUMP TRUCKS) CUMMINS QSK60/HPI		Hydraulic Oil Filter.....	HC-76080	Fuel Filter Secondary.....	FC-7903
Cabin Air Filter Recirculation.....	CA-56140	Oil Filter Combination.....	C-7927	Fuel/Water Separator.....	SFC-5706
830E (DUMP TRUCKS) DETROITD 16V-149		Oil Filter Combination.....	C-57390	Fuel/Water Separator.....	SFC-5708
Cabin Air Filter Recirculation.....	CA-56140	Oil Filter Full Flow.....	C-1305	Oil Filter Combination.....	C-5707
830E (DUMP TRUCKS) DETROITD 16V4000		850C (MOTOR GRADERS) 6CT8.3		Oil Filter Combination.....	C-5723
Cabin Air Filter Recirculation.....	CA-56140	Fuel Filter Secondary.....	FC-7903	870C (MOTOR GRADERS) D505T	
830E-AC (DUMP TRUCKS)		Fuel/Water Separator.....	SFC-5706	Air Filter Secondary.....	A-7614
Cabin Air Filter Recirculation.....	CA-56140	Fuel/Water Separator.....	SFC-5708	Air Filter Primary.....	A-7615
830E-AC (DUMP TRUCKS) SDA16V160		Oil Filter Combination.....	C-5707	Air Filter Set.....	A-7615-S
Air Filter Secondary.....	A-9205	Oil Filter Combination.....	C-5723	Fuel Filter Secondary.....	FC-7903
830E-15 (DUMP TRUCKS) DETROITD 16V-149		850C (MOTOR GRADERS) D505T		Fuel/Water Separator.....	SFC-5706
Cabin Air Filter Recirculation.....	CA-56140	Air Filter Set.....	A-7615-S	Fuel/Water Separator.....	SFC-5708
830E-15 (DUMP TRUCKS) DETROITD 16V4000		Air Filter Secondary.....	A-7614	Hydraulic Oil Filter.....	HC-76080
Cabin Air Filter Recirculation.....	CA-56140	Air Filter Primary.....	A-7615	Oil Filter Combination.....	C-7927
830E-1AC (DUMP TRUCKS)		Fuel Filter Secondary.....	FC-7903	Oil Filter Combination.....	C-57390
Cabin Air Filter Recirculation.....	CA-56140	Fuel/Water Separator.....	SFC-5708	Oil Filter Full Flow.....	C-1305
844 (TRACTORS) 310		Fuel/Water Separator.....	SFC-5706	888 (MOTOR GRADERS) 8V-71	
Fuel Filter.....	FC-5103	Hydraulic Oil Filter.....	HC-76080	Fuel Filter.....	F-7302
844 (TRACTORS)		Oil Filter Combination.....	C-57390	Fuel Filter.....	F-6503
Air Filter Secondary.....	A-5309	Oil Filter Full Flow.....	C-1305	Fuel Filter.....	F-6504
Air Filter Primary.....	A-6201	Oil Filter Combination.....	C-7927	Fuel Filter.....	F-6505
Fuel Filter.....	F-2603	850RL (MOTOR GRADERS) CUMMINS		Oil Filter Full Flow.....	O-6503
Fuel Filter.....	FC-5103	Coolant Filter.....	WC-5705	862 (LOADERS) 1965	
844SB (TRACTORS)		Fuel Filter Secondary.....	FC-7903	Fuel Filter.....	FC-5103
Air Filter Primary.....	A-6808	Fuel/Water Separator.....	SFC-5706	930E - 2 (DUMP TRUCKS) QSK60	
Air Filter Secondary.....	A-5114	Fuel/Water Separator.....	SFC-5708	Fuel/Water Separator.....	SFC-5601-02
Fuel Filter.....	FC-5103	Oil Filter Combination.....	C-5707	930E-4SE (DUMP TRUCKS) QSK78 , 2011	
Oil Filter Full Flow.....	C-6204	Oil Filter Combination.....	C-5723	Fuel/Water Separator.....	SFC-5601-02
850B (MOTOR GRADERS) 6CT8.3		860E (DUMP TRUCKS)		B100 (LOADERS)	
Fuel Filter Secondary.....	FC-7903	Air Filter Set.....	A-44310-S	Fuel Filter.....	FC-5103
Fuel/Water Separator.....	SFC-5706	870B (MOTOR GRADERS) 6CT8.3		Hydraulic Oil Filter.....	H-55270
Fuel/Water Separator.....	SFC-5708	Fuel Filter Secondary.....	FC-7903	Hydraulic Oil Filter.....	H-5504
Oil Filter Combination.....	C-5723	Fuel/Water Separator.....	SFC-5706	B125 (LOADERS)	
Oil Filter Combination.....	C-5707	Oil Filter Combination.....	C-5723	Air Filter Primary.....	AS-5628
		Oil Filter Combination.....	C-5707	Air Filter Set.....	A-5628-S
				Air Filter Primary.....	A-5628

Sakura Filter

ENGINE APPLICATION

MODEL/APPLICATION	SAKURA NO	MODEL/APPLICATION	SAKURA NO	MODEL/APPLICATION	SAKURA NO
KOMATSU		KOMATSU		KOMATSU	
B125 (LOADERS)		BR200J-1 (CRUSHER) S6D95L		BR380JG-1EO (CRUSHER) SAA6D107E-1	
Fuel Filter.....	FC-5103	Air Filter Set.....	A-5663-S	Fuel Filter.....	FC-5613
Oil Filter Full Flow.....	0-6503	Air Filter Primary.....	A-5627		
B250 LITTLE GIANT (LOADERS)		Air Filter Secondary.....	A-6008	BR380JG-1 (CRUSHER) SAA6D107E-1	
Fuel Filter.....	FC-5103	Hydraulic Oil Filter.....	H-85680	Fuel Filter.....	FC-5613
Oil Filter Full Flow.....	0-1803	Hydraulic Oil Filter.....	H-7911		
B275 (LOADERS)		Oil Filter Full Flow.....	C-5606	BR500JG-1 (CRUSHER) SA6D125E-2	
Fuel Filter.....	FC-5103	BR200R-1 (CRUSHER) S6D95L		Air Filter Secondary.....	A-5408
Oil Filter Full Flow.....	0-1803	Air Filter Set.....	A-5663-S	Air Filter Primary.....	A-6113
B414 (LOADERS)		Air Filter Secondary.....	A-6008	Fuel Filter.....	FC-5602
Fuel Filter.....	FC-5103	Air Filter Primary.....	A-5627	Hydraulic Oil Filter.....	H-2709
Oil Filter Full Flow.....	0-1803	Hydraulic Oil Filter.....	H-85680	Oil Filter Full Flow.....	C-5605
B500 (LOADERS)		Hydraulic Oil Filter.....	H-7911	Oil Filter Full Flow.....	C-5701
Fuel Filter.....	FC-5103	Oil Filter Full Flow.....	C-5606	Oil Filter Full Flow.....	C-5715
Oil Filter Full Flow.....	0-1803	BR200S-1 (CRUSHER) S6D95L		Oil Filter By Pass.....	C-5718
B8K3 (LOADERS) 1965		Air Filter Primary.....	A-5627	BR500JG-1A (CRUSHER) SA6D125E-2	
Fuel Filter.....	FC-5103	Air Filter Set.....	A-5663-S	Air Filter Primary.....	A-6113
BD414 (LOADERS) 1961		Air Filter Secondary.....	A-6008	Fuel Filter.....	FC-5602
Fuel Filter.....	FC-5103	Hydraulic Oil Filter.....	H-85680	Hydraulic Oil Filter.....	H-2709
Oil Filter Full Flow.....	0-1803	Hydraulic Oil Filter.....	H-7911	Oil Filter Full Flow.....	C-5715
BD5 (LOADERS)		Oil Filter Full Flow.....	C-5606	Oil Filter Full Flow.....	C-5605
Oil Filter Full Flow.....	0-1803	BR300J-1 (CRUSHER) S/N: 1001		Oil Filter Full Flow.....	C-5701
BF480RG-1 (CRUSHER) KOMATSU SAA6D125E-2		Air Filter Set.....	A-5663-S	BR580JG-1 (CRUSHER) SAA6D125E-5 , 2011	
Fuel Filter.....	FC-5610	Air Filter Primary.....	A-5627	Fuel/Water Separator Secondary..	SFC-5611-10B
BF480RG-1 (CRUSHER) SAA6D125E-2		Fuel Filter.....	FC-5621	Fuel/Water Separator Secondary...	SFC-5611-10
Fuel Filter.....	FC-5602	Hydraulic Oil Filter.....	H-7911	BR550JG-1 (CRUSHER) KOMATSU SAA6D125E-2	
Hydraulic Oil Filter.....	H-2709	Hydraulic Oil Filter.....	H-85680	Fuel Filter.....	FC-5610
Oil Filter Full Flow.....	C-5715	Hydraulic Oil Filter.....	H-7911	BR550JG-1 (CRUSHER) SAA6D125E-2	
Oil Filter Full Flow.....	C-5605	Oil Filter Full Flow.....	C-5606	Air Filter Secondary.....	A-5408
Oil Filter Full Flow.....	C-5701	BR310JG-1 (CRUSHER) SA6D95L		Fuel Filter.....	FC-5602
BH25 (LOADERS)		Air Filter Secondary.....	A-6008	Hydraulic Oil Filter.....	H-2709
Fuel Filter.....	FC-5103	Air Filter Primary.....	A-5627	Oil Filter Full Flow.....	C-5605
Oil Filter Full Flow.....	0-1803	Air Filter Set.....	A-5663-S	Oil Filter Full Flow.....	C-5701
BH25B (LOADERS)		Hydraulic Oil Filter.....	H-85680	Oil Filter Full Flow.....	C-5715
Oil Filter Full Flow.....	0-2619	Hydraulic Oil Filter.....	H-7911	BTD125 (LOADERS)	
BM2009C (CRUSHER) 4D84E-3		Oil Filter Full Flow.....	C-5730	Air Filter Primary.....	AS-5628
Fuel Filter.....	F-5210	BR350JG-1 (CRUSHER) S/N: 1005		Air Filter Primary.....	A-5628
Oil Filter Full Flow.....	C-8012	Air Filter Secondary.....	A-5635	Air Filter Set.....	A-5628-S
Oil Filter Full Flow.....	C-1720	Air Filter Primary.....	A-5639	Fuel Filter.....	FC-5103
BP500 (PILE DRIVERS) S6D105		Fuel Filter Secondary.....	FC-7903	Oil Filter Full Flow.....	0-6503
Oil Filter Full Flow.....	C-5614	Fuel/Water Separator.....	SFC-5708	BTD20 (LOADERS) 1965	
		Hydraulic Oil Filter.....	H-85680	Fuel Filter.....	FC-5103
		Oil Filter Full Flow.....	C-5730	BTD8 (LOADERS) 1965	
		BR380JG-1EO (CRUSHER) SAA6D107E-1 , 2011		Fuel Filter.....	FC-5103
		Air Filter Primary.....	A-5558M	CC2000 (CRANES) BF12L413F	
		Air Filter Secondary.....	A-5559	Oil Filter Full Flow.....	C-6204
		Air Filter Set.....	A-5558M-S		
		Hydraulic Oil Filter.....	H-5646		
		Hydraulic Oil Filter.....	H-5629		
		Oil Filter Full Flow.....	C-5611		

Sakura Filter

ENGINE APPLICATION

MODEL/APPLICATION	SAKURA NO	MODEL/APPLICATION	SAKURA NO	MODEL/APPLICATION	SAKURA NO
KOMATSU		KOMATSU		KOMATSU	
CC280 (CRANES) F6/8L413		D100 (DOZERS) IHC		D120 SERIES B (DOZERS) 8V-71	
Fuel Filter.....	F-2603	Fuel Filter Secondary.....	FC-54050	Fuel Filter.....	F-6503
Fuel Filter.....	FC-5704	Fuel/Water Separator.....	SFC-5705	Fuel Filter.....	F-7302
Oil Filter Full Flow.....	C-6203	Hydraulic Oil Filter Transmission...	H-65030	Oil Filter Full Flow.....	O-6503
Oil Filter Full Flow.....	C-6204	Oil Filter Full Flow.....	C-5402		
CC300 (CRANES) F8L413F		D100 (DOZERS) NH220		D120 SERIES B (DOZERS) DT817	
Fuel Filter.....	FC-5704	Fuel Filter.....	F-5701	Hydraulic Oil Filter Transmission...	H-65030
Oil Filter Full Flow.....	C-6203	Hydraulic Oil Filter Transmission...	H-65030		
Oil Filter Full Flow.....	C-6204	Oil Filter Full Flow.....	O-5702	D120 SERIES C (DOZERS) 8V-71	
CC4000 (CRANES) VT-903		D100 (DOZERS) NT-855		Fuel Filter.....	F-6503
Coolant Filter.....	WC-5705	Air Filter.....	AS-5706	Fuel Filter.....	F-7302
Fuel Filter.....	FC-5702	Fuel Filter.....	F-5701	Oil Filter Full Flow.....	O-6503
Oil Filter By Pass.....	C-5718	Fuel Filter.....	FC-5720		
Oil Filter Full Flow.....	C-5715	Fuel Filter.....	FC-1303	D120 SERIES C (DOZERS) DT817	
CC600 (CRANES) F8L413F		Fuel/Water Separator.....	SFC-5705	Hydraulic Oil Filter Transmission...	H-65030
Fuel Filter.....	FC-5704	Hydraulic Oil Filter Transmission...	H-65030		
Oil Filter Full Flow.....	C-6203	Oil Filter Full Flow.....	O-5702	D120A-18 (DOZERS) NRTO-6C1	
Oil Filter Full Flow.....	C-6204			Fuel Filter.....	F-5601
CD110R-2 (CARRIERS) KOMATSU SAA6D114E-2		D100 SERIES B (DOZERS) IHC		Oil Filter Full Flow.....	O-5603
Fuel Filter.....	FC-5610	Fuel Filter Secondary.....	FC-54050	Oil Filter By Pass.....	O-5704
		Fuel/Water Separator.....	SFC-5705		
CD110R-2 (CARRIERS) SAA6D114E-2		Hydraulic Oil Filter Transmission...	H-65030	D125 (DOZERS) CUMMINS	
Air Filter Primary.....	A-5558M	Oil Filter Full Flow.....	C-5402	Coolant Filter.....	WC-5711
Air Filter Secondary.....	A-5559			Fuel Filter.....	F-5601
Air Filter Set.....	A-5558M-S	D10S-2 (LOADERS) 2D92		Oil Filter Full Flow.....	C-2302
Hydraulic Oil Filter.....	H-5618	Oil Filter Full Flow.....	C-5606	Oil Filter By Pass.....	O-5704
Oil Filter Combination.....	C-5707				
CK20-1 (LOADERS) S4D98E		D-1100 (MOTOR GRADERS) CUMMINS		D125A (DOZERS) CUMMINS	
Air Filter Set.....	A-8506-S	Fuel Filter.....	F-5701	Coolant Filter.....	WC-5711
Air Filter Primary.....	A-8506	Hydraulic Oil Filter Transmission...	H-65030	Fuel Filter.....	F-5601
Air Filter Secondary.....	A-7004	Oil Filter Full Flow.....	O-5702	Oil Filter By Pass.....	O-5704
Fuel Filter.....	FC-5201			Oil Filter Full Flow.....	C-2302
CK30-1 (LOADERS) S4D98E		D12 (DOZERS) CUMMINS		D125A-18 (DOZERS) NRTO-6C1	
Air Filter Secondary.....	A-7004	Air Filter Primary.....	A-5636	Fuel Filter.....	F-5601
Air Filter Primary.....	A-8506	Fuel Filter.....	F-5601	Oil Filter Full Flow.....	O-5603
Air Filter Set.....	A-8506-S	Hydraulic Oil Filter.....	H-55270	Oil Filter By Pass.....	O-5704
Fuel Filter.....	FC-5201	Hydraulic Oil Filter.....	H-5610		
CK35-1 (LOADERS) S4D98E		Hydraulic Oil Filter.....	H-5504	D135A-1 (DOZERS) SA6D125	
Air Filter Secondary.....	A-7004	Hydraulic Oil Filter.....	H-56600	Fuel Filter.....	FC-5606
Air Filter Primary.....	A-8506	Oil Filter Full Flow.....	O-5603		
Air Filter Set.....	A-8506-S	Oil Filter By Pass.....	O-5704	D135A-1 (DOZERS) SA6D125-1/10001	
Fuel Filter.....	FC-5201			Air Filter Secondary.....	A-5408
D100 (DOZERS) 6V-71		D100 (DOZERS) 8V-71		Fuel Filter.....	FC-5602
Fuel Filter.....	F-7302	Fuel Filter.....	F-6503	Hydraulic Oil Filter.....	H-5610
Fuel Filter.....	F-6503	Fuel Filter.....	F-7302	Hydraulic Oil Filter.....	H-56600
Fuel Filter.....	F-6504	Oil Filter Full Flow.....	O-6503	Hydraulic Oil Filter.....	H-5606
Fuel Filter.....	F-6505			Oil Filter Full Flow.....	C-5715
Oil Filter Full Flow.....	O-6503	D100 (DOZERS) DT817		Oil Filter Full Flow.....	C-5701
		Hydraulic Oil Filter Transmission...	H-65030	Oil Filter Full Flow.....	C-5605
D100 (DOZERS) DT817B		D100 (DOZERS) S6D140		D135A-2 (DOZERS) KOMATSU S6D140	
Fuel Filter.....	F-7302	Fuel Filter Secondary.....	FC-54050	Hydraulic Oil Filter Transmission...	H-56570
Fuel Filter.....	F-6503	Fuel/Water Separator.....	SFC-5705		
Fuel Filter.....	F-6504	Hydraulic Oil Filter Transmission...	H-65030	D135A-2 (DOZERS) S6D140-1/10301	
Fuel Filter.....	F-6505				
Oil Filter Full Flow.....	O-6503				

MODEL/APPLICATION	SAKURA NO
KOMATSU	
D135A-2 (DOZERS) S6D140-1/10301	
Air Filter Secondary.....	A-5610
Air Filter Primary.....	A-5614
Fuel Filter.....	FC-5602
Hydraulic Oil Filter.....	H-5610
Hydraulic Oil Filter.....	H-5606
Hydraulic Oil Filter.....	H-56600
Oil Filter Full Flow.....	C-5605
Oil Filter Full Flow.....	C-5715
Oil Filter Full Flow.....	C-5701
D135A-2 (DOZERS) S6D140	
Fuel Filter.....	FC-5606
D150A-1 (DOZERS) S6D155	
Air Filter Secondary.....	A-5610
Air Filter Primary.....	A-5614
Fuel Filter.....	FC-5606
Fuel Filter.....	FC-5602
Fuel Filter.....	F-2626
Hydraulic Oil Filter.....	H-5610
Hydraulic Oil Filter.....	H-5606
Hydraulic Oil Filter.....	H-56600
Oil Filter Full Flow.....	C-5715
Oil Filter By Pass.....	O-5704
Oil Filter Full Flow.....	C-5605
Oil Filter Full Flow.....	C-5701
D150A-1 (DOZERS) S6D155-4/24805	
Air Filter Secondary.....	A-5610
Air Filter Primary.....	A-5614
Fuel Filter.....	FC-5602
Fuel Filter.....	F-2626
Hydraulic Oil Filter.....	H-56600
Hydraulic Oil Filter.....	H-5610
Hydraulic Oil Filter.....	H-5606
Oil Filter Full Flow.....	C-5701
Oil Filter By Pass.....	O-5704
Oil Filter Full Flow.....	C-5715
Oil Filter Full Flow.....	C-5605
D155 (DOZERS) S6D155	
Fuel Filter.....	FC-5602
Oil Filter By Pass.....	O-5704
Oil Filter Full Flow.....	C-5605
Oil Filter Full Flow.....	C-5701
Oil Filter Full Flow.....	C-5715
D155A-1 (DOZERS) KOMATSU S6D155-4	
Hydraulic Oil Filter Transmission...	H-56570
D155A-1 (DOZERS) S6D155	
Fuel Filter.....	FC-5606
D155A-1 (DOZERS) S6D155-4	
Air Filter Primary.....	A-5618
Fuel Filter.....	F-2626

MODEL/APPLICATION	SAKURA NO
KOMATSU	
Fuel Filter.....	FC-5602
Fuel Filter.....	F-2604
Oil Filter Full Flow.....	C-5715
Oil Filter Full Flow.....	C-5605
Oil Filter Full Flow.....	C-5701
Oil Filter By Pass.....	O-5704
Oil Filter Full Flow.....	O-5601
Oil Filter Full Flow.....	O-5501
D155A-2 (DOZERS) S6D155-4/50001	
Air Filter Secondary.....	A-5610
Air Filter Primary.....	A-5614
Fuel Filter.....	FC-5602
Hydraulic Oil Filter.....	H-5610
Hydraulic Oil Filter.....	H-5606
Hydraulic Oil Filter.....	H-56600
Oil Filter Full Flow.....	C-5715
Oil Filter Full Flow.....	C-5701
Oil Filter Full Flow.....	C-5605
D155A-2 (DOZERS) S6D155-4S	
Fuel Filter.....	FC-5606
D155A-5 (DOZERS)	
Air Filter Secondary.....	A-5610
Air Filter Primary.....	A-5614
Air Filter Primary.....	A-8665M
Air Filter Secondary.....	A-8580
Fuel Filter.....	FC-5703
Fuel/Water Separator.....	SFC-5707
Hydraulic Oil Filter.....	H-5610
Hydraulic Oil Filter.....	H-56600
Hydraulic Breather.....	H-56610
Oil Filter Full Flow.....	C-5715
Oil Filter Full Flow.....	C-5701
Oil Filter Full Flow.....	C-5605
D155AX-5 (DOZERS) KOMATSU SAA6D140E-3C-7	
Fuel/Water Separator.....	SFC-56020
Fuel/Water Separator.....	SFC-56020B
D155AX-5 (DOZERS) KOMATSU SAA6D140E-3J-7	
Fuel/Water Separator.....	SFC-56020
Fuel/Water Separator.....	SFC-56020B
D155AX-5 (DOZERS) SAA6D140E	
Air Filter Secondary.....	A-8580
Air Filter Primary.....	A-8665M
Air Filter Secondary.....	A-5610
Air Filter Primary.....	A-5614
Fuel Filter.....	FC-5703
Fuel/Water Separator.....	SFC-5707
Oil Filter Full Flow.....	C-5715
Oil Filter Full Flow.....	C-5701
Oil Filter Full Flow.....	C-5605
D155AX-5 (DOZERS) S/N: 70001	
Air Filter Secondary.....	A-5610

MODEL/APPLICATION	SAKURA NO
KOMATSU	
Air Filter Primary.....	A-5614
Fuel Filter.....	FC-5703
Fuel/Water Separator.....	SFC-5707
Hydraulic Oil Filter.....	H-56600
Oil Filter Full Flow.....	C-5715
Oil Filter Full Flow.....	C-5701
Oil Filter Full Flow.....	C-5605
D155AX-5B (DOZERS) SAA6D140E	
Air Filter Secondary.....	A-5610
Air Filter Primary.....	A-5614
Air Filter Primary.....	A-8665M
Air Filter Secondary.....	A-8580
Cabin Air Filter.....	CA-5602
Fuel Filter.....	FC-5703
Fuel/Water Separator.....	SFC-5707
Oil Filter Full Flow.....	C-5605
Oil Filter Full Flow.....	C-5701
Oil Filter Full Flow.....	C-5715
D155AX-5SL (DOZERS) SAA6D140E	
Air Filter Primary.....	A-5614
Air Filter Primary.....	A-8665M
Air Filter Secondary.....	A-8580
Air Filter Secondary.....	A-5610
Cabin Air Filter.....	CA-5602
Fuel Filter.....	FC-5703
Fuel/Water Separator.....	SFC-5707
Oil Filter Full Flow.....	C-5605
Oil Filter Full Flow.....	C-5701
Oil Filter Full Flow.....	C-5715
D155AX-6 (DOZERS) KOMATSU SAA6D140E-5G-02	
Fuel/Water Separator.....	SFC-56020B
Fuel/Water Separator.....	SFC-56020
Hydraulic Oil Filter additional part..	H-7105
D155AX-6 (DOZERS)	
Air Filter Secondary.....	A-8580
Air Filter Primary.....	A-8665M
Cabin Air Filter.....	CA-56041
Cabin Air Filter.....	CA-5602
Fuel/Water Separator Secondary..	SFC-5611-10B
Fuel/Water Separator Secondary..	SFC-5611-10
Hydraulic Oil Filter.....	H-5646
Hydraulic Oil Filter.....	H-56600
Hydraulic Oil Filter.....	H-5629
D155AX-6 (DOZERS) SAA6D140E-5	
Air Filter Secondary.....	A-8580
Air Filter Primary.....	A-8665M
Cabin Air Filter.....	CA-56041
Cabin Air Filter.....	CA-5602
Fuel/Water Separator Secondary..	SFC-5611-10B
Fuel/Water Separator Secondary..	SFC-5611-10
Hydraulic Oil Filter.....	H-5629
Hydraulic Oil Filter.....	H-56600
Hydraulic Oil Filter.....	H-5646

MODEL/APPLICATION	SAKURA NO	MODEL/APPLICATION	SAKURA NO	MODEL/APPLICATION	SAKURA NO
KOMATSU		KOMATSU		KOMATSU	
D155AX-6SL (DOZERS) SAA6D140E-5		Oil Filter Full Flow.....	C-5715	D20-7 (DOZERS) 4D955	
Air Filter Primary.....	A-8665M	Oil Filter Full Flow.....	C-5701	Air Filter Secondary.....	A-5621
Air Filter Secondary.....	A-8580	Oil Filter By Pass.....	O-5704	Air Filter Primary.....	AS-5620
Cabin Air Filter.....	CA-5602	D155AX-3 (DOZERS) S6D140-1/60001		Fuel Filter.....	FC-1801
Cabin Air Filter.....	CA-56041	Air Filter Secondary.....	A-5610	Hydraulic Oil Filter.....	HC-5602
Fuel/Water Separator Secondary..	SFC-5611-10B	Air Filter Primary.....	A-5614	Oil Filter Full Flow.....	C-5604
Fuel/Water Separator Secondary..	SFC-5611-10	Fuel Filter.....	FC-5703	D20A-2 (DOZERS) C221	
Hydraulic Oil Filter.....	H-56600	Fuel/Water Separator.....	SFC-5707	Fuel Filter.....	F-1501
D155C-1 (DOZERS) S6D155		Hydraulic Oil Filter.....	H-5610	Hydraulic Oil Filter.....	H-5611
Fuel Filter.....	FC-5606	Hydraulic Oil Filter.....	H-56600	Oil Filter Full Flow.....	O-1803
D155C-1 (DOZERS) S6D155-4/15686		Oil Filter Full Flow.....	C-5605	D20A-3 (DOZERS) 4D130-1	
Air Filter Secondary.....	A-5610	Oil Filter Full Flow.....	C-5701	Air Filter Set.....	A-5608-S
Air Filter Primary.....	A-5614	Oil Filter Full Flow.....	C-5715	Air Filter Primary.....	A-5608
Fuel Filter.....	FC-5602	D155EX (DOZERS)		Fuel Filter.....	F-1501
Hydraulic Oil Filter.....	H-5608	Fuel/Water Separator Secondary..	SFC-5611-10B	Hydraulic Oil Filter.....	H-5611
Hydraulic Oil Filter.....	H-5606	Fuel/Water Separator Secondary..	SFC-5611-10	Oil Filter Full Flow.....	C-5606
Hydraulic Oil Filter.....	H-5601	Hydraulic Oil Filter.....	H-56600	D20A-5 (DOZERS)	
Oil Filter By Pass.....	O-5704	D155A-6 (DOZERS) KOMATSU SAA6D140E-5		Air Filter Primary.....	AS-5620
Oil Filter Full Flow.....	C-5715	Fuel/Water Separator.....	SFC-56020	Fuel Filter.....	FC-5604
Oil Filter Full Flow.....	C-5605	Fuel/Water Separator.....	SFC-56020B	Oil Filter Full Flow.....	C-5606
Oil Filter Full Flow.....	C-5701	D155A-6 (DOZERS) KOMATSU SAA6D140E-5GR-W		D20A-7 (DOZERS)	
D155S-1 (DOZERS) S6D155		Hydraulic Oil Filter additional part..	H-7105	Air Filter Primary.....	AS-5620
Air Filter Secondary.....	A-5610	D155A-2A (DOZERS) SA6D140E		Air Filter Secondary.....	A-5621
Air Filter Primary.....	A-5614	Fuel Filter.....	FC-5606	Air Filter Secondary.....	A-8599
Coolant Filter.....	WC-5712	D155A-6R (DOZERS) KOMATSU SAA6D140E-5		Air Filter Primary.....	A-8505
Fuel Filter.....	FC-5602	Fuel/Water Separator.....	SFC-56020	Fuel Filter.....	FC-1801
Fuel Filter.....	FC-5606	Fuel/Water Separator.....	SFC-56020B	Fuel Filter.....	FC-1016
Fuel Filter.....	F-2604	D155AX-6A (DOZERS) KOMATSU SAA6D140E-5G-02		Oil Filter Full Flow.....	C-5604
Hydraulic Oil Filter.....	H-5606	Fuel/Water Separator.....	SFC-56020	D20P (DOZERS) 4D130-1	
Oil Filter Full Flow.....	C-5605	Fuel/Water Separator.....	SFC-56020B	Air Filter Set.....	A-5608-S
Oil Filter Full Flow.....	C-5701	D20 (DOZERS) 4D92		Air Filter Primary.....	A-5608
Oil Filter Full Flow.....	C-5715	Air Filter Primary.....	AS-5620	Air Filter Secondary.....	A-5621
Oil Filter By Pass.....	O-5704	Fuel Filter.....	FC-5604	Air Filter Secondary.....	A-8599
Oil Filter Full Flow.....	O-5601	Oil Filter Full Flow.....	C-5606	Air Filter Primary.....	A-8505
D155S-1 (DOZERS) S6D155/1001		D20 (DOZERS) 4D94/45001		Fuel Filter.....	FC-1801
Air Filter Secondary.....	A-5610	Air Filter Secondary.....	A-5621	Fuel Filter.....	FC-1016
Air Filter Primary.....	A-5614	Air Filter Primary.....	AS-1014	Oil Filter Full Flow.....	C-5606
Fuel Filter.....	F-2604	Air Filter Primary.....	AS-5620	D20P (DOZERS) 4D92	
Fuel Filter.....	FC-5602	Fuel Filter.....	FC-5604	Air Filter Primary.....	AS-5620
Hydraulic Oil Filter.....	H-5606	Hydraulic Oil Filter.....	HC-5602	Fuel Filter.....	FC-5604
Oil Filter Full Flow.....	C-5605	Oil Filter Full Flow.....	C-5606	Oil Filter Full Flow.....	C-5606
Oil Filter By Pass.....	O-5704	D20P-2 (DOZERS) C221		D20P (DOZERS) 4D92	
Oil Filter Full Flow.....	C-5715	Fuel Filter.....	F-1501	Air Filter Primary.....	AS-5620
Oil Filter Full Flow.....	C-5701	Hydraulic Oil Filter.....	H-5611	Fuel Filter.....	FC-5604
Oil Filter Full Flow.....	O-5601	Oil Filter Full Flow.....	O-1803	Oil Filter Full Flow.....	C-5606
D155S-1 (DOZERS) S6D155-4/25200		D20P-3 (DOZERS) 4D130-1		D20P-2 (DOZERS) C221	
Air Filter Secondary.....	A-5610	Air Filter Primary.....	A-5608	Fuel Filter.....	F-1501
Air Filter Primary.....	A-5614	Air Filter Set.....	A-5608-S	Hydraulic Oil Filter.....	H-5611
Fuel Filter.....	FC-5602	Air Filter Primary.....	A-5608	Oil Filter Full Flow.....	O-1803
Fuel Filter.....	F-2626	Fuel Filter.....	F-1501	D20P-3 (DOZERS) 4D130-1	
Hydraulic Oil Filter.....	H-5606	Hydraulic Oil Filter.....	H-5611	Air Filter Primary.....	A-5608
Oil Filter Full Flow.....	C-5605	Oil Filter Full Flow.....	C-5606	Air Filter Set.....	A-5608-S
				Fuel Filter.....	F-1501
				Hydraulic Oil Filter.....	H-5611
				Oil Filter Full Flow.....	C-5606

Sakura Filter

ENGINE APPLICATION

MODEL/APPLICATION	SAKURA NO	MODEL/APPLICATION	SAKURA NO	MODEL/APPLICATION	SAKURA NO
KOMATSU		KOMATSU		KOMATSU	
D20P-5 (DOZERS)		Fuel Filter.....	F-1501	Oil Filter Full Flow.....	C-5606
Air Filter Primary.....	AS-5620	Hydraulic Oil Filter.....	H-5611		
Fuel Filter.....	FC-5604	Oil Filter Full Flow.....	C-5606	D21A-6 (DOZERS) 4D95S-W/60001	
Oil Filter Full Flow.....	C-5606			Air Filter Primary.....	AS-5620
D20P-7 (DOZERS)		D20S-5 (LOADERS)		Air Filter Secondary.....	A-5621
Air Filter Primary.....	A-8505	Air Filter Primary.....	AS-5620	Fuel Filter.....	FC-5604
Air Filter Secondary.....	A-5621	Fuel Filter.....	FC-5604	Hydraulic Oil Filter.....	HC-5602
Air Filter Primary.....	AS-5620	Oil Filter Full Flow.....	C-5606	D21A-8 (DOZERS) 4D94LE-2	
Air Filter Secondary.....	A-8599			Air Filter Primary.....	A-8505
Fuel Filter.....	FC-1016	D20P-6A (DOZERS) 4D95S-W-1F-AP		Air Filter Secondary.....	A-8599
Fuel Filter.....	FC-1801	Oil Filter Full Flow.....	C-5615	D21E-6 (DOZERS) 4D95S-W/60001	
Oil Filter Full Flow.....	C-5604	Oil Filter Full Flow.....	C-5616	Air Filter Primary.....	AS-5620
D20PL-5 (DOZERS) 4D92		D20P-7A (DOZERS) 4D95S-1H		Air Filter Secondary.....	A-5621
Air Filter Primary.....	AS-5620	Oil Filter Full Flow.....	C-5615	Fuel Filter.....	FC-5604
Fuel Filter.....	FC-5604	Oil Filter Full Flow.....	C-5616	Hydraulic Oil Filter.....	HC-5602
Oil Filter Full Flow.....	C-5606	D20P-7A-M (DOZERS) 4D94E-1A		D21P (DOZERS) 4D130-1	
D20Q (LOADERS) 4D92		Oil Filter Full Flow.....	C-5615	Air Filter Set.....	A-5608-S
Air Filter Primary.....	AS-5620	D21 (DOZERS) FH-37		Air Filter Primary.....	A-5608
Fuel Filter.....	FC-5604	Hydraulic Oil Filter.....	H-5608	Fuel Filter.....	F-1501
Oil Filter Full Flow.....	C-5606	Hydraulic Oil Filter.....	H-5611	Hydraulic Oil Filter.....	H-5611
D20Q-3 (LOADERS) 4D130-1		D21-7 (DOZERS) 4D95S/75001		Oil Filter Full Flow.....	C-5606
Air Filter Set.....	A-5608-S	Air Filter Secondary.....	A-5621	D21P (DOZERS) 4D92	
Air Filter Primary.....	A-5608	Air Filter Primary.....	AS-5620	Air Filter Primary.....	AS-5620
Fuel Filter.....	F-1501	Fuel Filter.....	FC-1801	Fuel Filter.....	FC-5604
Hydraulic Oil Filter.....	H-5611	Hydraulic Oil Filter.....	HC-5602	Oil Filter Full Flow.....	C-5606
Oil Filter Full Flow.....	C-5606	Oil Filter Full Flow.....	C-5604	D21P-3 (DOZERS) 4D130-1	
D20Q-5 (LOADERS)		D21A (DOZERS) 4D130-1		Air Filter Set.....	A-5608-S
Air Filter Primary.....	AS-5620	Air Filter Primary.....	A-5608	Air Filter Primary.....	A-5608
Fuel Filter.....	FC-5604	Air Filter Set.....	A-5608-S	Fuel Filter.....	F-1501
Oil Filter Full Flow.....	C-5606	Fuel Filter.....	F-1501	Hydraulic Oil Filter.....	H-5611
D20S (LOADERS) 4D130-1		Hydraulic Oil Filter.....	H-5611	Oil Filter Full Flow.....	C-5606
Air Filter Set.....	A-5608-S	Oil Filter Full Flow.....	C-5606	D21P-5 (DOZERS) 4D94/45001	
Air Filter Primary.....	A-5608	D21A (DOZERS) 4D92		Air Filter Primary.....	AS-1014
Fuel Filter.....	F-1501	Air Filter Primary.....	AS-5620	Air Filter Secondary.....	A-5621
Hydraulic Oil Filter.....	H-5611	Fuel Filter.....	FC-5604	Air Filter Primary.....	AS-5620
Oil Filter Full Flow.....	C-5606	Oil Filter Full Flow.....	C-5606	Fuel Filter.....	FC-5604
D20S (LOADERS) 4D92		D21A-3 (DOZERS) 4D130-1		Hydraulic Oil Filter.....	HC-5602
Air Filter Primary.....	AS-5620	Air Filter Set.....	A-5608-S	Oil Filter Full Flow.....	C-5606
Fuel Filter.....	FC-5604	Air Filter Primary.....	A-5608	D21P-6 (DOZERS) 4D95S-W/60001	
Oil Filter Full Flow.....	C-5606	Fuel Filter.....	F-1501	Air Filter Secondary.....	A-5621
D20S-2 (LOADERS) C221		Hydraulic Oil Filter.....	H-5611	Air Filter Primary.....	AS-5620
Fuel Filter.....	F-1501	Oil Filter Full Flow.....	C-5606	Fuel Filter.....	FC-5604
Hydraulic Oil Filter.....	H-5611	D21A-5 (DOZERS) 4D94/45001		Hydraulic Oil Filter.....	HC-5602
Oil Filter Full Flow.....	O-1803	Air Filter Primary.....	AS-1014	D21P-6B (DOZERS) 4D95S-W	
D20S-3 (LOADERS) 4D130-1		Air Filter Secondary.....	A-5621	Air Filter Secondary.....	A-5621
Air Filter Set.....	A-5608-S	Air Filter Primary.....	AS-5620	Air Filter Primary.....	AS-5620
Air Filter Primary.....	A-5608	Fuel Filter.....	FC-5604	Fuel Filter.....	FC-5604
		Hydraulic Oil Filter.....	HC-5602	Hydraulic Oil Filter.....	HC-5602

MODEL/APPLICATION	SAKURA NO	MODEL/APPLICATION	SAKURA NO	MODEL/APPLICATION	SAKURA NO
KOMATSU		KOMATSU		KOMATSU	
D21P-8 (DOZERS) 4D94LE-2		D21Q-6 (LOADERS) 4D95S-W/60001		Air Filter Primary.....	AS-1014
Air Filter Primary.....	A-8505	Air Filter Secondary.....	A-5621	Air Filter Primary.....	AS-5620
Air Filter Secondary.....	A-8599	Air Filter Primary.....	AS-5620	Air Filter Primary.....	A-8505
D21PL-5 (DOZERS) 4D92		Fuel Filter.....	FC-5604	Fuel Filter.....	FC-1016
Air Filter Primary.....	AS-5620	Hydraulic Oil Filter.....	HC-5602	Fuel Filter.....	FC-1801
Fuel Filter.....	FC-5604	D21S (LOADERS) 4D130-1		Oil Filter Full Flow.....	C-5604
Oil Filter Full Flow.....	C-5606	Air Filter Primary.....	A-5608	D275A-2 (DOZERS) S6D170	
D21PL-5 (DOZERS) 4D94/45001		Air Filter Set.....	A-5608-S	Fuel Filter.....	FC-5606
Air Filter Primary.....	AS-5620	Fuel Filter.....	F-1501	D275A-2 (DOZERS) S6D170-1/10001	
Air Filter Secondary.....	A-5621	Hydraulic Oil Filter.....	H-5611	Air Filter Secondary.....	A-5610
Air Filter Primary.....	AS-1014	Oil Filter Full Flow.....	C-5606	Air Filter Primary.....	A-5614
Fuel Filter.....	FC-5604	D21S (LOADERS) 4D92		Coolant Filter.....	WC-56010
Hydraulic Oil Filter.....	HC-5602	Air Filter Primary.....	AS-5620	Fuel Filter.....	FC-5602
Oil Filter Full Flow.....	C-5606	Fuel Filter.....	FC-5604	Hydraulic Oil Filter.....	H-5610
D21PL-6 (DOZERS) 4D95S-W/60001		Oil Filter Full Flow.....	C-5606	Hydraulic Oil Filter.....	H-56600
Air Filter Secondary.....	A-5621	D21S-3 (LOADERS) 4D130-1		Oil Filter Full Flow.....	C-5715
Air Filter Primary.....	AS-5620	Air Filter Primary.....	A-5608	Oil Filter Full Flow.....	C-5701
Fuel Filter.....	FC-5604	Air Filter Set.....	A-5608-S	Oil Filter Full Flow.....	C-5605
Hydraulic Oil Filter.....	HC-5602	Fuel Filter.....	F-1501	D275A-2D (DOZERS) S6D170	
D21PLL-5 (DOZERS) 4D94/45001		Hydraulic Oil Filter.....	H-5611	Fuel Filter.....	FC-5606
Air Filter Secondary.....	A-5621	Oil Filter Full Flow.....	C-5606	D275A-2D (DOZERS) S6D170-1	
Air Filter Primary.....	AS-5620	D21S-5 (LOADERS) 4D94/45001		Air Filter Secondary.....	A-5610
Air Filter Primary.....	AS-1014	Air Filter Primary.....	AS-5620	Air Filter Primary.....	A-5614
Fuel Filter.....	FC-5604	Air Filter Secondary.....	A-5621	Coolant Filter.....	WC-56010
Hydraulic Oil Filter.....	HC-5602	Air Filter Primary.....	AS-1014	Fuel Filter.....	FC-5602
Oil Filter Full Flow.....	C-5606	Fuel Filter.....	FC-5604	Hydraulic Oil Filter.....	H-5610
D21PLL-6 (DOZERS) 4D95S-W/60001		Hydraulic Oil Filter.....	HC-5602	Hydraulic Oil Filter.....	H-56600
Air Filter Secondary.....	A-5621	Oil Filter Full Flow.....	C-5606	Oil Filter Full Flow.....	C-5605
Air Filter Primary.....	AS-5620	D21S-5 (LOADERS) FH-35		Oil Filter Full Flow.....	C-5701
Fuel Filter.....	FC-5604	Hydraulic Oil Filter.....	H-5608	Oil Filter Full Flow.....	C-5715
Hydraulic Oil Filter.....	HC-5602	Hydraulic Oil Filter.....	H-5611	D275AX-5 (DOZERS) SDA6D140E	
D21Q (LOADERS) 4D92		D21S-6 (LOADERS) 4D95S-W/60001		Air Filter Secondary.....	A-8580
Air Filter Primary.....	AS-5620	Air Filter Secondary.....	A-5621	Air Filter Primary.....	A-8665M
Fuel Filter.....	FC-5604	Air Filter Primary.....	AS-5620	Cabin Air Filter Set.....	CA-5601-S
Oil Filter Full Flow.....	C-5606	Fuel Filter.....	FC-5604	Cabin Air Filter.....	CA-56041
D21Q-3 (LOADERS) 4D130-1		Hydraulic Oil Filter.....	HC-5602	Fuel/Water Separator.....	SFC-5601-02
Air Filter Primary.....	A-5608	D21A-7 (DOZERS) 4D94E		Fuel/Water Separator Secondary..	SFC-5611-10B
Air Filter Set.....	A-5608-S	Air Filter Secondary.....	A-5621	Fuel/Water Separator Secondary..	SFC-5611-10
Fuel Filter.....	F-1501	Air Filter Secondary.....	A-8599	D275AX-5EO (DOZERS) KOMATSU SAA6D140E-5H	
Hydraulic Oil Filter.....	H-5611	Air Filter Primary.....	A-8505	Fuel/Water Separator.....	SFC-56020B
Oil Filter Full Flow.....	C-5606	Air Filter Primary.....	AS-5620	Fuel/Water Separator.....	SFC-56020
D21Q-5 (LOADERS) 4D94/45001		Air Filter Primary.....	AS-1014	D275AX-5EO (DOZERS) SAA6D140E-5	
Air Filter Primary.....	AS-5620	Fuel Filter.....	FC-1016	Air Filter Primary.....	A-8665M
Air Filter Primary.....	AS-1014	Fuel Filter.....	FC-1801	Air Filter Secondary.....	A-8580
Air Filter Secondary.....	A-5621	Oil Filter Full Flow.....	C-5604	Cabin Air Filter Set.....	CA-5601-S
Fuel Filter.....	FC-5604	D21P-7 (DOZERS) 4D94E		Cabin Air Filter.....	CA-56041
Hydraulic Oil Filter.....	HC-5602	Air Filter Secondary.....	A-8599	Fuel/Water Separator Secondary..	SFC-5611-10B
Oil Filter Full Flow.....	C-5606	Air Filter Secondary.....	A-5621	Fuel/Water Separator Secondary..	SFC-5611-10
				Hydraulic Oil Filter.....	H-5646
				Hydraulic Oil Filter.....	H-5629
				Hydraulic Oil Filter.....	H-56600

MODEL/APPLICATION	SAKURA NO	MODEL/APPLICATION	SAKURA NO	MODEL/APPLICATION	SAKURA NO
KOMATSU		KOMATSU		KOMATSU	
D275AX-5SL (DOZERS) SDA6D140E		D30Q-15 (LOADERS) 4D105		D31-20 (DOZERS) 54D102E-1/42723	
Air Filter Secondary.....	A-8580	Air Filter Set.....	A-5608-S	Air Filter Primary.....	A-5627
Air Filter Primary.....	A-8665M	Air Filter Primary.....	A-5608	Air Filter Secondary.....	A-6008
Cabin Air Filter Set.....	CA-5601-S	Hydraulic Oil Filter.....	H-5608	Air Filter Set.....	A-5663-S
Cabin Air Filter.....	CA-56041	D30Q-15 (LOADERS) 4D92		Fuel Filter Secondary.....	FC-7903
Fuel/Water Separator.....	SFC-5601-02	Air Filter Primary.....	A-5608	Fuel/Water Separator.....	SFC-5708
Fuel/Water Separator Secondary..	SFC-5611-10B	Air Filter Set.....	A-5608-S	Hydraulic Oil Filter.....	HC-5602
Fuel/Water Separator Secondary...	SFC-5611-10	Hydraulic Oil Filter.....	H-5608	Oil Filter Full Flow.....	C-5703
D275A (DOZERS)		Oil Filter Full Flow.....		D31A (DOZERS) 4D105	
Fuel/Water Separator Secondary..	SFC-5611-10B	D30S (LOADERS) 4D105		Air Filter Set.....	A-5655-S
Fuel/Water Separator Secondary..	SFC-5611-10	Air Filter Primary.....	A-5608	Air Filter Primary.....	A-5616
Hydraulic Oil Filter.....	H-5629	Air Filter Set.....	A-5608-S	Air Filter Secondary.....	A-5617
Hydraulic Oil Filter.....	H-5646	Hydraulic Oil Filter.....	H-5608	Hydraulic Oil Filter.....	H-5608
D275A-5R (DOZERS) KOMATSU SAA6D140E-5		D30S-12 (LOADERS) DA220		D31A (DOZERS) 4D105-1	
Fuel Filter.....	FC-5614	Fuel Filter.....	F-1303	Air Filter Secondary.....	A-5617
Fuel Filter.....	FC-56230	D30S-15 (LOADERS) 4D92		Air Filter Set.....	A-5655-S
D275A-5R (DOZERS) KOMATSU SAA6D140E-5AH		Air Filter Set.....	A-5608-S	Air Filter Primary.....	A-5616
Fuel/Water Separator.....	SFC-56020	Air Filter Primary.....	A-5608	Fuel Filter.....	FC-5605
Fuel/Water Separator.....	SFC-56020B	Hydraulic Oil Filter.....	H-5608	Hydraulic Oil Filter.....	HC-5601
D275A-5R (DOZERS) KOMATSU SAA6D140E-5HR		Oil Filter Full Flow.....	C-5606	Oil Filter Full Flow.....	C-6202
Fuel/Water Separator.....	SFC-56020	D31 (DOZERS) FH-63		D31A (DOZERS) 4D92	
Fuel/Water Separator.....	SFC-56020B	Fuel Filter.....	FC-5605	Air Filter Secondary.....	A-5617
D30A (DOZERS) 4D105		Hydraulic Oil Filter.....	H-5611	Air Filter Set.....	A-5655-S
Air Filter Primary.....	A-5608	Oil Filter Full Flow.....	C-5606	Air Filter Primary.....	A-5616
Air Filter Set.....	A-5608-S	D31-17 (DOZERS) S/N: 32001		Air Filter Secondary.....	A-5617
Hydraulic Oil Filter.....	H-5608	Air Filter Primary.....	AS-7805	Hydraulic Oil Filter.....	H-5608
D30A-12 (DOZERS) DA220		Air Filter Secondary.....	A-7806	Oil Filter Full Flow.....	C-6202
Fuel Filter.....	F-1303	Hydraulic Oil Filter.....	HC-5601	D31A-15 (DOZERS) 4D92	
D30A-15 (DOZERS) 4D92		Oil Filter Full Flow.....	C-5606	Air Filter Set.....	A-5655-S
Air Filter Primary.....	A-5608	D31-18 (DOZERS) S/N: 40001		Air Filter Primary.....	A-5616
Air Filter Set.....	A-5608-S	Air Filter Secondary.....	A-7806	Air Filter Secondary.....	A-5617
Hydraulic Oil Filter.....	H-5608	Air Filter Primary.....	AS-7805	Hydraulic Oil Filter.....	H-5608
Oil Filter Full Flow.....	C-5606	Fuel Filter.....	FC-5604	Oil Filter Full Flow.....	C-5606
D30P (DOZERS) 4D105		Hydraulic Oil Filter.....	HC-5602	D31A-16 (DOZERS) 4D105-1	
Air Filter Set.....	A-5608-S	Oil Filter Full Flow.....	C-5604	Air Filter Set.....	A-5655-S
Air Filter Primary.....	A-5608	D31-20 (DOZERS) 6D95L-1/42001 - 42722/96999		Air Filter Primary.....	A-5616
Hydraulic Oil Filter.....	H-5608	Air Filter Primary.....	AS-7805	Air Filter Secondary.....	A-5617
D30P-12 (DOZERS) DA220		Air Filter Secondary.....	A-7806	Fuel Filter.....	FC-5605
Fuel Filter.....	F-1303	Fuel Filter.....	FC-1801	Hydraulic Oil Filter.....	HC-5601
D30P-15 (DOZERS) 4D92		Oil Filter Full Flow.....	C-5604	Oil Filter Full Flow.....	C-6202
Air Filter Set.....	A-5608-S	D31-20 (DOZERS) 6D95L-1/42001/42722/100413		D31A-16 (DOZERS) 4D92	
Air Filter Primary.....	A-5608	Air Filter Primary.....	AS-7805	Air Filter Set.....	A-5655-S
Hydraulic Oil Filter.....	H-5608	Air Filter Secondary.....	A-7806	Air Filter Primary.....	A-5616
Oil Filter Full Flow.....	C-5606	Fuel Filter.....	FC-1801	Air Filter Secondary.....	A-5617
D30P-15 (DOZERS) 4D92		Oil Filter Full Flow.....	C-5604	Fuel Filter.....	FC-5605
Air Filter Set.....	A-5608-S	D31-20 (DOZERS) 6D95L-1/42001/42722/100413		Hydraulic Oil Filter.....	HC-5601
Air Filter Primary.....	A-5608	Air Filter Primary.....	AS-7805	Oil Filter Full Flow.....	C-6202
Hydraulic Oil Filter.....	H-5608	Air Filter Secondary.....	A-7806	D31A-17 (DOZERS) 4D105/32001	
Oil Filter Full Flow.....	C-5606	Fuel Filter.....	FC-1801	Air Filter Primary.....	AS-7805
		Oil Filter Full Flow.....	C-5604		

MODEL/APPLICATION	SAKURA NO	MODEL/APPLICATION	SAKURA NO	MODEL/APPLICATION	SAKURA NO
KOMATSU		KOMATSU		KOMATSU	
D31A-17 (DOZERS) 4D105/32001		Air Filter Secondary.....	A-5617	D31P-20 (DOZERS) 54D102E	
Air Filter Secondary.....	A-7806	Air Filter Set.....	A-5655-S	Air Filter Primary.....	A-5627
Fuel Filter.....	FC-5604	Air Filter Primary.....	A-5616	Air Filter Set.....	A-5663-S
Hydraulic Oil Filter.....	HC-5602	Fuel Filter.....	FC-5605		
Oil Filter Full Flow.....	C-5614	Hydraulic Oil Filter.....	HC-5601	D31P-20A (DOZERS)	
		Oil Filter Full Flow.....	C-6202	Air Filter Primary.....	AS-7805
D31E-17 (DOZERS) 6D105-5T		D31P-15 (DOZERS) 4D92		Air Filter Secondary.....	A-7806
Air Filter Primary.....	AS-7805	Air Filter Set.....	A-5655-S	Fuel Filter.....	FC-1801
Air Filter Secondary.....	A-7806	Air Filter Primary.....	A-5616	Hydraulic Oil Filter.....	HC-5602
Fuel Filter.....	FC-5604	Air Filter Secondary.....	A-5617	Oil Filter Full Flow.....	C-5604
Oil Filter Full Flow.....	C-5614	Hydraulic Oil Filter.....	H-5608		
		Oil Filter Full Flow.....	C-5606	D31PL-17 (DOZERS) 4D105/32001	
D31E-18 (DOZERS) 6D95L-1/40001		D31P-16 (DOZERS) 4D105-1		Air Filter Primary.....	AS-7805
Air Filter Primary.....	AS-7805	Air Filter Secondary.....	A-5617	Air Filter Secondary.....	A-7806
Air Filter Secondary.....	A-7806	Air Filter Set.....	A-5655-S	Fuel Filter.....	FC-5604
Fuel Filter.....	FC-5604	Air Filter Primary.....	A-5616	Hydraulic Oil Filter.....	HC-5602
Hydraulic Oil Filter.....	HC-5602	Fuel Filter.....	FC-5605	Oil Filter Full Flow.....	C-5614
Oil Filter Full Flow.....	C-5604	Hydraulic Oil Filter.....	HC-5601		
		Oil Filter Full Flow.....	C-6202	D31PL-18 (DOZERS) 6D95L-1/40001	
D31E-20 (DOZERS) 6D95L		D31P-16 (DOZERS) 4D92		Air Filter Primary.....	AS-7805
Air Filter Set.....	A-5663-S	Air Filter Secondary.....	A-5617	Air Filter Secondary.....	A-7806
Air Filter Primary.....	A-5627	Air Filter Set.....	A-5655-S	Fuel Filter.....	FC-5604
Air Filter Primary.....	AS-7805	Air Filter Primary.....	A-5616	Hydraulic Oil Filter.....	HC-5602
Fuel Filter.....	FC-1801	Fuel Filter.....	FC-5605	Oil Filter Full Flow.....	C-5604
Oil Filter Full Flow.....	C-5405	Hydraulic Oil Filter.....	HC-5601		
		Oil Filter Full Flow.....	C-6202	D31PLL-17 (DOZERS) 4D105/32001	
D31E-20 (DOZERS) 54D102E		D31P-16A (DOZERS) 4D105-3		Air Filter Secondary.....	A-7806
Air Filter Primary.....	A-5627	Fuel Filter.....	FC-5605	Air Filter Primary.....	AS-7805
Air Filter Set.....	A-5663-S	Oil Filter Full Flow.....	C-5606	Fuel Filter.....	FC-5604
				Hydraulic Oil Filter.....	HC-5602
D31EX (DOZERS) 54D102E		D31P-17 (DOZERS) 4D105/32001		Oil Filter Full Flow.....	C-5614
Air Filter Primary.....	A-5627	Air Filter Primary.....	AS-7805		
Air Filter Set.....	A-5663-S	Air Filter Secondary.....	A-7806	D31PX-21 (DOZERS) SAA4D102E	
		Fuel Filter.....	FC-5604	Air Filter Secondary.....	A-8670
D31EX-21 (DOZERS) SAA4D102E		Hydraulic Oil Filter.....	HC-5602	Air Filter Set.....	A-5675-S
Air Filter Set.....	A-5675-S	Oil Filter Full Flow.....	C-5614	Air Filter Secondary.....	A-5674
Air Filter Secondary.....	A-5674			Air Filter Primary.....	A-5673
Air Filter Primary.....	A-5673	D31P-17A (DOZERS) 6D105-5T		Air Filter Secondary.....	A-8670
Air Filter Secondary.....	A-8670	Air Filter Secondary.....	A-7806	Cabin Air Filter.....	CA-56070
Cabin Air Filter.....	CA-56070	Fuel Filter.....	FC-5604		
		Oil Filter Full Flow.....	C-5614	D31Q-15 (DOZERS) 4D105	
D31P (DOZERS) 4D105		D31P-17B (DOZERS) 6D105-5T		Air Filter Primary.....	A-5616
Air Filter Set.....	A-5655-S	Air Filter Secondary.....	A-7806	Air Filter Secondary.....	A-5617
Air Filter Primary.....	A-5616	Fuel Filter.....	FC-5604	Air Filter Set.....	A-5655-S
Air Filter Secondary.....	A-5617	Oil Filter Full Flow.....	C-5614	Hydraulic Oil Filter.....	H-5608
Hydraulic Oil Filter.....	H-5608				
		D31P-18 (DOZERS) 6D95L-1/40001		D31Q-15 (DOZERS) 4D92	
D31P (DOZERS) 4D105-1		Air Filter Primary.....	AS-7805	Air Filter Secondary.....	A-5617
Air Filter Set.....	A-5655-S	Air Filter Secondary.....	A-7806	Air Filter Set.....	A-5655-S
Air Filter Primary.....	A-5616	Fuel Filter.....	FC-5604	Air Filter Primary.....	A-5616
Air Filter Secondary.....	A-5617	Hydraulic Oil Filter.....	HC-5602	Hydraulic Oil Filter.....	H-5608
Fuel Filter.....	FC-5605	Oil Filter Full Flow.....	C-5614	Oil Filter Full Flow.....	C-5606
Hydraulic Oil Filter.....	HC-5601				
Oil Filter Full Flow.....	C-6202	D31Q-16 (DOZERS) 4D105-1		D31Q-16 (DOZERS) 4D105-1	
		Air Filter Primary.....	AS-7805	Air Filter Set.....	A-5655-S
D31P (DOZERS) 4D92		Air Filter Secondary.....	A-7806		
		Fuel Filter.....	FC-5604		
		Hydraulic Oil Filter.....	HC-5602		
		Oil Filter Full Flow.....	C-5604		

MODEL/APPLICATION	SAKURA NO	MODEL/APPLICATION	SAKURA NO	MODEL/APPLICATION	SAKURA NO
KOMATSU		KOMATSU		KOMATSU	
D31Q-16 <i>(DOZERS)</i> 4D105-1 Air Filter Secondary..... A-5617 Air Filter Primary..... A-5616 Fuel Filter..... FC-5605 Hydraulic Oil Filter..... HC-5601 Oil Filter Full Flow..... C-6202		D31S-16 <i>(DOZERS)</i> 4D105-1 Air Filter Primary..... A-5616 Air Filter Secondary..... A-5617 Air Filter Set..... A-5655-S Fuel Filter..... FC-5605 Hydraulic Oil Filter..... HC-5601 Oil Filter Full Flow..... C-6202		D354 <i>(DOZERS)</i> Air Filter Set..... A-9219-S Air Filter Primary..... A-9219 Fuel Filter..... FC-5103 Oil Filter Full Flow..... O-1803	
D31Q-16 <i>(DOZERS)</i> 4D92 Air Filter Set..... A-5655-S Air Filter Primary..... A-5616 Air Filter Secondary..... A-5617 Fuel Filter..... FC-5605 Hydraulic Oil Filter..... HC-5601 Oil Filter Full Flow..... C-6202		D31S-16 <i>(DOZERS)</i> 4D92 Air Filter Set..... A-5655-S Air Filter Primary..... A-5616 Air Filter Secondary..... A-5617 Fuel Filter..... FC-5605 Hydraulic Oil Filter..... HC-5601 Oil Filter Full Flow..... C-6202		D355 <i>(DOZERS)</i> Air Filter Primary..... A-5614 Air Filter Secondary..... A-5610 Fuel Filter..... FC-5602 Hydraulic Oil Filter..... H-5606 Oil Filter Full Flow..... C-5715 Oil Filter Full Flow..... C-5605 Oil Filter Full Flow..... C-5701 Oil Filter By Pass..... O-5704	
D31Q-17 <i>(DOZERS)</i> 4D105/32001 Air Filter Primary..... AS-7805 Air Filter Secondary..... A-7806 Fuel Filter..... FC-5604 Hydraulic Oil Filter..... HC-5602 Oil Filter Full Flow..... C-5614		D31S-17 <i>(DOZERS)</i> 4D105/32001 Air Filter Primary..... AS-7805 Air Filter Secondary..... A-7806 Fuel Filter..... FC-5604 Hydraulic Oil Filter..... HC-5602 Oil Filter Full Flow..... C-5614		D355A <i>(DOZERS)</i> S6D155-4 Air Filter Primary..... A-5618 Air Filter Secondary..... A-5610 Fuel Filter..... F-2604 Fuel Filter..... FC-5602 Fuel Filter..... F-2626 Oil Filter Full Flow..... C-5701 Oil Filter Full Flow..... C-5715 Oil Filter Full Flow..... O-5601 Oil Filter Full Flow..... C-5605 Oil Filter Full Flow..... O-5501 Oil Filter By Pass..... O-5704	
D31Q-18 <i>(DOZERS)</i> 6D95L-1/40001 Air Filter Primary..... AS-7805 Air Filter Secondary..... A-7806 Fuel Filter..... FC-5604 Hydraulic Oil Filter..... HC-5602 Oil Filter Full Flow..... C-5604		D31PX-22 <i>(DOZERS)</i> KOMATSU SAA4D95LE-5 , 2011 Air Filter Secondary..... A-56741 Air Filter Primary..... A-56731 Air Filter Set..... A-56731-S		D355A-1 <i>(DOZERS)</i> S6D155 Air Filter Secondary..... A-5610 Air Filter Primary..... A-5614 Air Filter Primary..... A-5618 Fuel Filter..... F-2626 Hydraulic Oil Filter..... H-5609 Hydraulic Oil Filter..... H-5606 Oil Filter By Pass..... O-5704 Oil Filter Full Flow..... O-5601	
D31S <i>(DOZERS)</i> 4D105 Air Filter Secondary..... A-5617 Air Filter Set..... A-5655-S Air Filter Primary..... A-5616 Hydraulic Oil Filter..... H-5608		D31PX-22 <i>(DOZERS)</i> SAA4D95LE-5 , 2011 Air Filter Secondary..... A-8670 Air Filter Set..... A-5675-S Air Filter Primary..... A-5673 Oil Filter Full Flow..... C-56191 Oil Filter Full Flow..... C-56190		D355A-1 <i>(DOZERS)</i> S6D155 Air Filter Secondary..... A-5610 Air Filter Primary..... A-5614 Air Filter Primary..... A-5618 Fuel Filter..... F-2626 Hydraulic Oil Filter..... H-5609 Hydraulic Oil Filter..... H-5606 Oil Filter By Pass..... O-5704 Oil Filter Full Flow..... O-5601	
D31S <i>(DOZERS)</i> 4D105-1 Air Filter Primary..... A-5616 Air Filter Secondary..... A-5617 Air Filter Set..... A-5655-S Fuel Filter..... FC-5605 Hydraulic Oil Filter..... HC-5601 Oil Filter Full Flow..... C-6202		D31PX-22 <i>(DOZERS)</i> SAA4D95LE-5 Air Filter Breather..... A-82010 Air Filter Secondary..... A-5674		D355A-3 <i>(DOZERS)</i> D355A-3 Fuel Filter..... FC-5610	
D31S <i>(DOZERS)</i> 4D92 Air Filter Set..... A-5655-S Air Filter Primary..... A-5616 Air Filter Secondary..... A-5617 Fuel Filter..... FC-5605 Hydraulic Oil Filter..... HC-5601 Oil Filter Full Flow..... C-6202		D31EX-22 <i>(DOZERS)</i> KOMATSU SAA4D95LE-5 , 2011 Air Filter Secondary..... A-56741 Air Filter Primary..... A-56731 Air Filter Set..... A-56731-S		D355A-3 <i>(DOZERS)</i> Air Filter Secondary..... A-5408 Air Filter Primary..... A-6113 Fuel/Water Separator Secondary.. SFC-5611-10 Fuel/Water Separator Secondary.. SFC-5611-10B Hydraulic Oil Filter..... H-5606 Hydraulic Oil Filter..... H-5609 Oil Filter Full Flow..... C-5715 Oil Filter Full Flow..... C-5701 Oil Filter Full Flow..... C-5605	
D31S-15 <i>(DOZERS)</i> 4D92 Air Filter Set..... A-5655-S Air Filter Primary..... A-5616 Air Filter Secondary..... A-5617 Hydraulic Oil Filter..... H-5608 Oil Filter Full Flow..... C-5606		D31EX-22 <i>(DOZERS)</i> SAA4D95LE-5 Air Filter Secondary..... A-5674 Air Filter Breather..... A-82010		D355A-3 <i>(DOZERS)</i> SA6D155/1632 Air Filter Secondary..... A-5610 Air Filter Primary..... A-5614 Fuel Filter..... F-2604	
		D32E-1 <i>(DOZERS)</i> 4D102E Fuel/Water Separator..... SFC-5708 Hydraulic Oil Filter..... HC-76080			
		D32P-1 <i>(DOZERS)</i> 4D102E Fuel/Water Separator..... SFC-5708 Hydraulic Oil Filter..... HC-76080			

MODEL/APPLICATION	SAKURA NO	MODEL/APPLICATION	SAKURA NO	MODEL/APPLICATION	SAKURA NO
KOMATSU		KOMATSU		KOMATSU	
D355A-3 (DOZERS) SA6D155/1632		D37-5 (DOZERS) 6D95L-1/3001/3730/100413		Coolant Filter.....	WC-6901
Fuel Filter.....	FC-5602	Air Filter Primary.....	AS-7805	Fuel Filter.....	FC-5602
Hydraulic Oil Filter.....	H-5606	Air Filter Secondary.....	A-7806	Hydraulic Oil Filter.....	H-5609
Hydraulic Oil Filter.....	H-5609	Fuel Filter.....	FC-1801	Oil Filter Full Flow.....	C-5715
Oil Filter Full Flow.....	C-5605	Oil Filter Full Flow.....	C-5604	Oil Filter Full Flow.....	C-5605
Oil Filter Full Flow.....	C-5715			Oil Filter Full Flow.....	C-5701
Oil Filter By Pass.....	O-5704	D37-5 (DOZERS) S4D102E-1/3731		D375A-3 (DOZERS) SA6D170	
Oil Filter Full Flow.....	C-5701	Air Filter Primary.....	A-5627	Fuel Filter.....	FC-5606
D355A-3 (DOZERS) SA6D155		Air Filter Secondary.....	A-6008	D375A-3 (DOZERS) SA6D170-1/17001	
Fuel Filter.....	FC-5606	Air Filter Set.....	A-5663-S	Air Filter Primary.....	A-5614
D355A-5 (DOZERS) 12622		Fuel Filter Secondary.....	FC-7903	Air Filter Secondary.....	A-5610
Air Filter Secondary.....	A-5610	Fuel/Water Separator.....	SFC-5708	Coolant Filter.....	WC-6901
Air Filter Primary.....	A-5614	Hydraulic Oil Filter.....	HC-5602	Coolant Filter.....	WC-56010
Fuel Filter.....	FC-5602	Oil Filter Full Flow.....	C-5703	Fuel Filter.....	FC-5602
Hydraulic Oil Filter.....	H-5609	D375A (DOZERS) SA6D170E-2A/17001/17353		Hydraulic Oil Filter.....	H-5609
Hydraulic Oil Filter.....	H-5606	Air Filter Secondary.....	A-5610	Oil Filter Full Flow.....	C-5701
Oil Filter Full Flow.....	C-5715	Air Filter Primary.....	A-5614	Oil Filter Full Flow.....	C-5715
Oil Filter Full Flow.....	C-5605	Coolant Filter.....	WC-56010	Oil Filter Full Flow.....	C-5605
Oil Filter Full Flow.....	C-5701	Hydraulic Oil Filter.....	H-5609	D375A-3 (DOZERS) SA6D170E-2/17001	
D355A-5 (DOZERS) SA6D155		Oil Filter Full Flow.....	C-5715	Air Filter Primary.....	A-5614
Fuel Filter.....	FC-5606	Oil Filter Full Flow.....	C-5605	Air Filter Secondary.....	A-5610
D355C-3 (DOZERS) S6D155		Oil Filter Full Flow.....	C-5701	Coolant Filter.....	WC-56010
Fuel Filter.....	FC-5606	D375A-1 (DOZERS) SA6D170		Coolant Filter.....	WC-6901
D355C-3 (DOZERS) S6D155-4/3259		Fuel Filter.....	FC-5606	Fuel Filter.....	FC-5602
Oil Filter Full Flow.....	C-5605	D375A-1 (DOZERS) SA6D170E-2/15001		Hydraulic Oil Filter.....	H-5609
D355C-3 (PIPE LAYERS) KOMATSU S6D155-4 3259		Air Filter Secondary.....	A-5610	Oil Filter Full Flow.....	C-5605
Fuel Filter.....	FC-5610	Air Filter Primary.....	A-5614	Oil Filter Full Flow.....	C-5701
D355C-3 (PIPE LAYERS) S6D155-4/3259		Coolant Filter.....	WC-56010	Oil Filter Full Flow.....	C-5715
Air Filter Secondary.....	A-5610	Coolant Filter.....	WC-6901	D375A-5 (DOZERS) KOMATSU SA6D170E-5DR	
Air Filter Primary.....	A-5614	Fuel Filter.....	FC-5602	Fuel/Water Separator.....	SFC-56020B
Fuel Filter.....	FC-5602	Hydraulic Oil Filter.....	H-5609	Fuel/Water Separator.....	SFC-56020B
Hydraulic Oil Filter.....	H-5601	Oil Filter Full Flow.....	C-5701	D375A-5 (DOZERS) SA6D170E	
Hydraulic Oil Filter.....	H-5608	Oil Filter Full Flow.....	C-5715	Air Filter Primary.....	A-8665M
Hydraulic Oil Filter.....	H-5606	Oil Filter Full Flow.....	C-5605	Air Filter Secondary.....	A-8580
Oil Filter Full Flow.....	C-5715	D375A-2 (DOZERS) SA6D170		Hydraulic Oil Filter.....	H-5609
Oil Filter Full Flow.....	C-5701	Fuel Filter.....	FC-5606	Oil Filter Full Flow.....	C-5715
D37-2 (DOZERS) S/N: 1501		D375A-2 (DOZERS) SA6D170-1/16001		Oil Filter Full Flow.....	C-5701
Air Filter Primary.....	AS-7805	Air Filter Secondary.....	A-5610	Oil Filter Full Flow.....	C-5605
Air Filter Secondary.....	A-7806	Air Filter Primary.....	A-5614	D375A-5 (DOZERS) SA6D170E-3	
Fuel Filter.....	FC-5604	Coolant Filter.....	WC-56010	Air Filter Secondary.....	A-8580
Hydraulic Oil Filter.....	HC-5602	Coolant Filter.....	WC-6901	Air Filter Primary.....	A-8665M
Oil Filter Full Flow.....	C-5604	Fuel Filter.....	FC-5602	Hydraulic Oil Filter.....	H-5609
D375 (DOZERS) 2006		Hydraulic Oil Filter.....	H-5609	Oil Filter Full Flow.....	C-5715
Cabin Air Filter Set.....	CA-5601-S	Oil Filter Full Flow.....	C-5715	Oil Filter Full Flow.....	C-5701
Cabin Air Filter.....	CA-56041	Oil Filter Full Flow.....	C-5701	Oil Filter Full Flow.....	C-5605
		Oil Filter Full Flow.....	C-5605	D375A-5E0 (DOZERS) SA6D170E-5 , 2005	
		D375A-2 (DOZERS) SA6D170E-2/16001		Air Filter Secondary.....	A-8580
		Air Filter Secondary.....	A-5610	Air Filter Primary.....	A-8665M
		Air Filter Primary.....	A-5614	Cabin Air Filter Set.....	CA-5601-S
		Coolant Filter.....	WC-56010	Cabin Air Filter.....	CA-56041
				Coolant Filter.....	WC-56010

MODEL/APPLICATION	SAKURA NO	MODEL/APPLICATION	SAKURA NO	MODEL/APPLICATION	SAKURA NO
KOMATSU		KOMATSU		KOMATSU	
D375A-5E0 (DOZERS) SAA6D170E-5 , 2005 Fuel/Water Separator Secondary.. SFC-5611-10B Fuel/Water Separator Secondary... SFC-5611-10		D37P-1 (DOZERS) 4D105/10001 Air Filter Primary..... AS-7805 Air Filter Secondary..... A-7806 Fuel Filter..... FC-5604 Hydraulic Oil Filter..... HC-5602 Oil Filter Full Flow..... C-5614		Air Filter Primary..... A-5627 Air Filter Primary..... AS-7805 Air Filter Secondary..... A-6008 Air Filter Set..... A-5663-S Air Filter Secondary..... A-7806 Fuel Filter..... FC-1801 Fuel Filter Secondary..... FC-7903 Fuel/Water Separator..... SFC-5708 Hydraulic Oil Filter..... HC-5602 Oil Filter Full Flow..... C-5405	
D375A-5E0 (DOZERS) KOMATSU SAA6D170E-5 Fuel/Water Separator..... SFC-56020 Fuel/Water Separator..... SFC-56020B		D37P-2 (DOZERS) 6D95L-1/1501 Air Filter Secondary..... A-7806 Air Filter Primary..... AS-7805 Fuel Filter..... FC-5604 Hydraulic Oil Filter..... HC-5602 Oil Filter Full Flow..... C-5604		D37EX-21A (DOZERS) SAA4D102E-2C Air Filter Secondary..... A-5674 Cabin Air Filter..... CA-56070	
D375A-5SL (DOZERS) SAA6D170E Air Filter Primary..... A-8665M Air Filter Secondary..... A-8580 Hydraulic Oil Filter..... H-5609 Oil Filter Full Flow..... C-5605 Oil Filter Full Flow..... C-5715 Oil Filter Full Flow..... C-5701		D37PX-22 (DOZERS) KOMATSU SAA4D95LE-5 Air Filter Primary..... A-56731 Air Filter Set..... A-56731-S Air Filter Secondary..... A-56741		D37PX-21A (DOZERS) SAA4D102E-2C Air Filter Secondary..... A-5674 Cabin Air Filter..... CA-56070	
D37-E (DOZERS) Air Filter Primary..... AS-7805 Air Filter Secondary..... A-7806 Fuel Filter..... FC-1801 Oil Filter Full Flow..... C-5604		D37PX-22 (DOZERS) SAA4D95LE-5 Air Filter Secondary..... A-5674 Air Filter Secondary..... A-8670 Air Filter Breather..... A-82010 Air Filter Primary..... A-5673 Air Filter Set..... A-5675-S Oil Filter Full Flow..... C-56191 Oil Filter Full Flow..... C-56190		D375A-6 (DOZERS) KOMATSU SAA6D170E-5 Fuel Filter..... FC-5614 Fuel Filter..... FC-56300 Fuel Filter..... FC-56230	
D37E-1 (DOZERS) 4D105/10001 Air Filter Primary..... AS-7805 Air Filter Secondary..... A-7806 Fuel Filter..... FC-5604 Hydraulic Oil Filter..... HC-5602 Oil Filter Full Flow..... C-5614		D37EX-21 (DOZERS) SAA4D102E Air Filter Secondary..... A-8670 Air Filter Primary..... A-5673 Air Filter Set..... A-5675-S Cabin Air Filter..... CA-56041 Fuel Filter..... F-5218		D38E-1 (DOZERS) S4D102E Air Filter Secondary..... A-7964 Air Filter Primary..... AS-7805 Fuel/Water Separator..... SFC-5708 Hydraulic Oil Filter..... HC-76080	
D37E-2 (DOZERS) 6D95L-1/1501 Air Filter Primary..... AS-7805 Air Filter Secondary..... A-7806 Fuel Filter..... FC-5604 Hydraulic Oil Filter..... HC-5602 Oil Filter Full Flow..... C-5604		D37EX-21 (DOZERS) SAA4D102E-2C Air Filter Secondary..... A-5674 Cabin Air Filter..... CA-56070		D38E-1A (DOZERS) S4D102E Air Filter Primary..... AS-7805 Air Filter Secondary..... A-7964 Fuel/Water Separator..... SFC-5708 Hydraulic Oil Filter..... HC-76080	
D37E-5 (DOZERS) 6D95L-1 Air Filter Primary..... AS-7805 Air Filter Secondary..... A-7806 Fuel Filter..... FC-1801 Oil Filter Full Flow..... C-5405		D37PX-21 (DOZERS) KOMATSU SAA4D102E Air Filter Secondary..... A-56741 Air Filter Primary..... A-56731 Air Filter Set..... A-56731-S		D38P-1A (DOZERS) S4D102E Air Filter Primary..... AS-7805 Air Filter Secondary..... A-7964 Fuel/Water Separator..... SFC-5708 Hydraulic Oil Filter..... HC-76080	
D37EX-22 (DOZERS) KOMATSU SAA4D95LE-5 Air Filter Secondary..... A-56741 Air Filter Primary..... A-56731 Air Filter Set..... A-56731-S		D37PX-21 (DOZERS) SAA4D102E Air Filter Set..... A-5675-S Air Filter Primary..... A-5673 Air Filter Secondary..... A-8670 Cabin Air Filter..... CA-56041 Fuel Filter..... F-5218		D39E-1 (DOZERS) S4D102E Air Filter Primary..... AS-7805 Air Filter Secondary..... A-7964 Fuel/Water Separator..... SFC-5708 Hydraulic Oil Filter..... HC-76080	
D37EX-22 (DOZERS) SAA4D95LE-5 Air Filter Primary..... A-5673 Air Filter Breather..... A-82010 Air Filter Secondary..... A-8670 Air Filter Set..... A-5675-S Air Filter Secondary..... A-5674 Oil Filter Full Flow..... C-56191 Oil Filter Full Flow..... C-56190		D37PX-21 (DOZERS) SAA4D102E-2C Air Filter Secondary..... A-5674 Cabin Air Filter..... CA-56070		D39E-1A (DOZERS) S4D102E Air Filter Secondary..... A-7964 Air Filter Primary..... AS-7805 Fuel/Water Separator..... SFC-5708 Hydraulic Oil Filter..... HC-76080	
		D37A-5 (DOZERS) 6D95L-1AD , 2012		D39EX-21 (DOZERS) SAA4D102E Air Filter Set..... A-5675-S Air Filter Secondary..... A-5674	

MODEL/APPLICATION	SAKURA NO	MODEL/APPLICATION	SAKURA NO	MODEL/APPLICATION	SAKURA NO
KOMATSU		KOMATSU		KOMATSU	
D39EX-21 (DOZERS) SAA4D102E		D39PX-21A (DOZERS) SAA4D102E		Oil Filter Full Flow.....	C-5614
Air Filter Primary.....	A-5673	Air Filter Secondary.....	A-5674	D40PL-1 (DOZERS) S4D105/1501	
Air Filter Secondary.....	A-8670	Air Filter Primary.....	A-5673	Hydraulic Oil Filter.....	H-5608
Cabin Air Filter.....	CA-56070	Air Filter Secondary.....	A-8670	Hydraulic Oil Filter.....	H-5611
Fuel Filter Secondary.....	FC-7903	Air Filter Set.....	A-5675-S	Oil Filter Full Flow.....	C-5606
Fuel/Water Separator.....	SFC-5708	Cabin Air Filter.....	CA-56070	D40PL-1 (DOZERS) S4D105-3	
Hydraulic Oil Filter.....	HC-5602	Cabin Air Filter.....	CA-56041	Fuel Filter.....	FC-5605
D39EX-21A (DOZERS) SAA4D102E		Fuel Filter.....	F-5218	Hydraulic Oil Filter.....	H-5608
Air Filter Primary.....	A-5673	D40-3 (DOZERS) 6001		Hydraulic Oil Filter.....	H-5611
Air Filter Secondary.....	A-5674	Air Filter Primary.....	AS-1024	Oil Filter Full Flow.....	C-6202
Air Filter Secondary.....	A-8670	Air Filter Set.....	AS-1024-S	Oil Filter Full Flow.....	C-5606
Air Filter Set.....	A-5675-S	Air Filter Secondary.....	A-6009	D40PL-3 (DOZERS) 6D105	
Cabin Air Filter.....	CA-56041	Hydraulic Oil Filter.....	H-5607	Air Filter Set.....	AS-1024-S
Cabin Air Filter.....	CA-56070	Oil Filter Full Flow.....	C-5614	Air Filter Primary.....	AS-1024
Fuel Filter.....	F-5218	D40A (DOZERS) S4D105-3		Coolant Filter.....	WC-5707
D39EX-22 (DOZERS) SAA4D107E-1		Fuel Filter.....	FC-5605	Fuel Filter.....	FC-5621
Air Filter Secondary.....	A-8578	Hydraulic Oil Filter.....	H-5608	Hydraulic Oil Filter.....	H-5607
Air Filter Primary.....	A-8577	Hydraulic Oil Filter.....	H-5611	Oil Filter Full Flow.....	C-5614
Air Filter Breather.....	A-82010	Oil Filter Full Flow.....	C-6202	D40PLL-1 (DOZERS) S4D105/1501	
Fuel Filter.....	FC-5613	Oil Filter Full Flow.....	C-5606	Hydraulic Oil Filter.....	H-5611
Oil Filter Full Flow.....	C-5611	D40A-3 (DOZERS) 6D105		Hydraulic Oil Filter.....	H-5608
D39P-1 (DOZERS) S4D102E		Air Filter Primary.....	AS-1024	Oil Filter Full Flow.....	C-5606
Air Filter Primary.....	AS-7805	Air Filter Set.....	AS-1024-S	D40PLL-3 (DOZERS) 6D105	
Air Filter Secondary.....	A-7964	Coolant Filter.....	WC-5707	Air Filter Primary.....	AS-1024
Fuel/Water Separator.....	SFC-5708	Fuel Filter.....	FC-5621	Air Filter Set.....	AS-1024-S
Hydraulic Oil Filter.....	HC-76080	Hydraulic Oil Filter.....	H-5607	Coolant Filter.....	WC-5707
D39P-1A (DOZERS) S4D102E		Oil Filter Full Flow.....	C-5614	Fuel Filter.....	FC-5621
Air Filter Primary.....	AS-7805	D40P (DOZERS) S4D105-3		Hydraulic Oil Filter.....	H-5607
Air Filter Secondary.....	A-7964	Fuel Filter.....	FC-5605	Oil Filter Full Flow.....	C-5614
Fuel/Water Separator.....	SFC-5708	Hydraulic Oil Filter.....	H-5608	D41-3 (DOZERS) S/N: 6001	
Hydraulic Oil Filter.....	HC-76080	Hydraulic Oil Filter.....	H-5611	Air Filter Secondary.....	A-6009
D39P-1A (DOZERS) S4D102E		Oil Filter Full Flow.....	C-6202	Air Filter Primary.....	AS-1024
Air Filter Primary.....	AS-7805	Oil Filter Full Flow.....	C-5606	Air Filter Set.....	AS-1024-S
Air Filter Secondary.....	A-7964	D40P-1 (DOZERS) S4D105/1501		Hydraulic Oil Filter.....	H-5607
Fuel/Water Separator.....	SFC-5708	Hydraulic Oil Filter.....	H-5611	Oil Filter Full Flow.....	C-5614
Hydraulic Oil Filter.....	HC-76080	Hydraulic Oil Filter.....	H-5608	D41A-3 (DOZERS) 6D105-1	
D39PX-21 (DOZERS) KOMATSU SAA4D102E		Oil Filter Full Flow.....	C-6202	Air Filter Primary.....	AS-1024
Air Filter Secondary.....	A-56741	Oil Filter Full Flow.....	C-5606	Air Filter Set.....	AS-1024-S
Air Filter Primary.....	A-56731	D40P-1 (DOZERS) S4D105-3		Coolant Filter.....	WC-5707
Air Filter Set.....	A-56731-S	Fuel Filter.....	FC-5605	Fuel Filter.....	FC-5621
D39PX-21 (DOZERS) SAA4D102E		Hydraulic Oil Filter.....	H-5608	Hydraulic Oil Filter.....	H-5607
Air Filter Secondary.....	A-5674	Hydraulic Oil Filter.....	H-5611	Oil Filter Full Flow.....	C-5614
Cabin Air Filter.....	CA-56070	Oil Filter Full Flow.....	C-5606	D41-A6 (DOZERS) 6D102-1/B20001	
D39PX-22 (DOZERS) SAA4D107E-1		D40P-1 (DOZERS) S4D105-3		Air Filter Primary.....	A-5627
Air Filter Secondary.....	A-8578	Fuel Filter.....	FC-5605	Air Filter Set.....	A-5663-S
Air Filter Primary.....	A-8577	Hydraulic Oil Filter.....	H-5611	Air Filter Secondary.....	A-6008
Air Filter Breather.....	A-82010	Hydraulic Oil Filter.....	H-5608	Fuel Filter Secondary.....	FC-7903
Fuel Filter.....	FC-5613	Oil Filter Full Flow.....	C-6202	Fuel/Water Separator.....	SFC-5708
Oil Filter Full Flow.....	C-5611	Oil Filter Full Flow.....	C-5606	Hydraulic Oil Filter.....	HC-5602
D39PX-21A (DOZERS) KOMATSU SAA4D102E		D40P-3 (DOZERS) 6D105		Oil Filter Full Flow.....	C-5730
Air Filter Secondary.....	A-56741	Air Filter Primary.....	AS-1024		
Air Filter Primary.....	A-56731	Air Filter Set.....	AS-1024-S		
Air Filter Set.....	A-56731-S	Coolant Filter.....	WC-5707		
		Fuel Filter.....	FC-5621		
		Hydraulic Oil Filter.....	H-5607		

Sakura Filter

ENGINE APPLICATION

MODEL/APPLICATION	SAKURA NO	MODEL/APPLICATION	SAKURA NO	MODEL/APPLICATION	SAKURA NO
KOMATSU		KOMATSU		KOMATSU	
D41E-6 (DOZERS) S6D102E-1/B20001		D445A-1 (DOZERS) VTA-1710		Hydraulic Oil Filter.....	H-5608
Air Filter Primary.....	A-5627	Air Filter Secondary.....	A-5610	Hydraulic Oil Filter.....	H-5611
Air Filter Set.....	A-5663-S	Air Filter Primary.....	A-5614	Oil Filter Full Flow.....	C-5606
Air Filter Secondary.....	A-6008	Fuel Filter.....	F-5601	D45P-1 (DOZERS) S4D105/1501	
Fuel Filter Secondary.....	FC-7903	Fuel Filter.....	FC-5703	Hydraulic Oil Filter.....	H-5608
Fuel/Water Separator.....	SFC-5708	Fuel/Water Separator.....	SFC-5707	Hydraulic Oil Filter.....	H-5611
Hydraulic Oil Filter.....	HC-5602	Hydraulic Oil Filter.....	H-5609	Oil Filter Full Flow.....	C-5606
Oil Filter Full Flow.....	C-5730	Hydraulic Oil Filter.....	H-5622	D45P-1 (DOZERS) S4D105-3	
D41-P (DOZERS)		Hydraulic Oil Filter.....	H-5607	Fuel Filter.....	FC-5605
Air Filter Primary.....	AS-1024	Oil Filter By Pass.....	O-5704	Hydraulic Oil Filter.....	H-5608
Air Filter Set.....	AS-1024-S	Oil Filter Full Flow.....	O-5702	Hydraulic Oil Filter.....	H-5611
Air Filter Secondary.....	A-6009	D445A-1 (DOZERS) w/Cummins VTA1710-1B Eng		Oil Filter Full Flow.....	C-6202
Coolant Filter.....	WC-5705	Hydraulic Oil Filter.....	H-5519	Oil Filter Full Flow.....	C-5606
Fuel Filter.....	FC-5605	D455A (DOZERS) CUMMINS		D45S-1 (DOZERS) S4D105/1501	
Hydraulic Oil Filter.....	H-5607	Air Filter Primary.....	A-5614	Hydraulic Oil Filter.....	H-5607
Oil Filter Full Flow.....	C-5614	Air Filter Primary.....	A-5618	Hydraulic Oil Filter.....	H-5611
D41P-3 (DOZERS) 6D105-1		Air Filter Secondary.....	A-5610	Oil Filter Full Flow.....	C-5606
Air Filter Primary.....	AS-1024	Fuel Filter.....	F-5601	D45S-1 (DOZERS) S4D105-3	
Air Filter Set.....	AS-1024-S	Fuel Filter.....	FC-5703	Fuel Filter.....	FC-5605
Coolant Filter.....	WC-5707	Fuel/Water Separator.....	SFC-5707	Hydraulic Oil Filter.....	H-5611
Fuel Filter.....	FC-5621	Oil Filter By Pass.....	O-5704	Hydraulic Oil Filter.....	H-5607
Hydraulic Oil Filter.....	H-5607	Oil Filter Full Flow.....	O-5702	Oil Filter Full Flow.....	C-6202
Oil Filter Full Flow.....	C-5614	D455A (DOZERS) w/Cummins VTA1710-1B Eng		Oil Filter Full Flow.....	C-5606
D41P-6 (DOZERS) 6D102-1/B20001		Hydraulic Oil Filter.....	H-5519	D455 (DOZERS) w/Cummins VTA1710-1B Eng	
Air Filter Primary.....	A-5627	D455A-1 (DOZERS) VTA-1710/1001		Hydraulic Oil Filter.....	H-5519
Air Filter Set.....	A-5663-S	Air Filter Secondary.....	A-5610	D455-1 (DOZERS) w/Cummins VTA1710-1B Eng	
Air Filter Secondary.....	A-6008	Air Filter Primary.....	A-5614	Hydraulic Oil Filter.....	H-5519
Fuel Filter Secondary.....	FC-7903	Fuel Filter.....	F-5601	D475 (DOZERS) SA12V140	
Fuel/Water Separator.....	SFC-5708	Fuel Filter.....	FC-5703	Air Filter Secondary.....	A-5610
Hydraulic Oil Filter.....	HC-5602	Fuel/Water Separator.....	SFC-5707	Air Filter Primary.....	A-5614
Oil Filter Full Flow.....	C-5730	Hydraulic Oil Filter.....	H-5607	Coolant Filter.....	WC-6901
D41Q-3 (LOADERS) 6D105-1		Hydraulic Oil Filter.....	H-5622	Fuel Filter.....	FC-5703
Air Filter Primary.....	AS-1024	Hydraulic Oil Filter.....	H-5609	Fuel/Water Separator.....	SFC-5707
Air Filter Set.....	AS-1024-S	Oil Filter By Pass.....	O-5704	Oil Filter Full Flow.....	C-5605
Coolant Filter.....	WC-5707	Oil Filter Full Flow.....	O-5702	Oil Filter Full Flow.....	C-5701
Fuel Filter.....	FC-5621	D455A-1 (DOZERS) w/Cummins VTA1710-1B Eng		Oil Filter Full Flow.....	C-5715
Hydraulic Oil Filter.....	H-5607	Hydraulic Oil Filter.....	H-5519	D475 (DOZERS) SA8V170	
Oil Filter Full Flow.....	C-5614	D45A (DOZERS) S4D105-3		Air Filter Secondary.....	A-5610
D41S-3 (LOADERS) 6D105-1		Fuel Filter.....	FC-5605	Air Filter Primary.....	A-5614
Air Filter Primary.....	AS-1024	Hydraulic Oil Filter.....	H-5611	Coolant Filter.....	WC-5708
Air Filter Set.....	AS-1024-S	Hydraulic Oil Filter.....	H-5608	Fuel Filter.....	FC-5703
Coolant Filter.....	WC-5707	Oil Filter Full Flow.....	C-5606	Fuel/Water Separator.....	SFC-5707
Fuel Filter.....	FC-5621	Oil Filter Full Flow.....	C-6202	Hydraulic Oil Filter.....	H-7911
Hydraulic Oil Filter.....	H-5607	D45A-1 (DOZERS) S4D105/1501		Hydraulic Oil Filter.....	H-85680
Oil Filter Full Flow.....	C-5614	Hydraulic Oil Filter.....	H-5608	Oil Filter Full Flow.....	C-5605
D444 (LOADERS)		Hydraulic Oil Filter.....	H-5611	Oil Filter Full Flow.....	C-5701
Air Filter Primary.....	A-9219	Oil Filter Full Flow.....	C-5606	Oil Filter Full Flow.....	C-5715
Air Filter Set.....	A-9219-S	D45E-1 (DOZERS) S4D105/1501		D475A-1 (DOZERS) SA8V170-1/10001	
Fuel Filter.....	FC-5103				
Oil Filter Full Flow.....	O-1803				

MODEL/APPLICATION	SAKURA NO	MODEL/APPLICATION	SAKURA NO	MODEL/APPLICATION	SAKURA NO
KOMATSU		KOMATSU		KOMATSU	
D475A-1 (DOZERS) SA8V170-1/10001 Fuel Filter..... FC-5703 Fuel/Water Separator..... SFC-5707 Hydraulic Oil Filter..... H-7911 Hydraulic Oil Filter..... H-85680 Oil Filter Full Flow..... C-5605 Oil Filter Full Flow..... C-5701 Oil Filter Full Flow..... C-5715		D475A-3 (DOZERS) KOMATSU SDA12V140 , 1999-2004 Oil Filter By Pass..... C-5718 D500 (DOZERS) 16V-71 Air Filter..... A-8545 Fuel Filter..... F-6504 Hydraulic Oil Filter Transmission... H-65030 Oil Filter Full Flow..... O-6503		D50A-15 (DOZERS) 4D120 Air Filter Set..... A-5657-S Air Filter Primary..... A-5649 Fuel Filter..... F-2626 Hydraulic Oil Filter..... H-5608 Hydraulic Oil Filter..... H-5526 Hydraulic Oil Filter..... H-55280 Hydraulic Oil Filter..... H-5503 Oil Filter Full Flow..... O-5601	
D475A-2 (DOZERS) SA12V140-1/10201 Air Filter Secondary..... A-5610 Air Filter Primary..... A-5614 Coolant Filter..... WC-56010 Fuel Filter..... FC-5703 Fuel/Water Separator..... SFC-5707 Hydraulic Oil Filter..... H-7911 Hydraulic Oil Filter..... H-85680 Oil Filter Full Flow..... C-5701 Oil Filter By Pass..... C-5718 Oil Filter Full Flow..... C-5715 Oil Filter Full Flow..... C-5605		D500 (DOZERS) VTA28-C Fuel Filter..... FC-5720 Fuel Filter..... FC-1303 Fuel Filter..... F-5701 Fuel/Water Separator..... SFC-5705 Hydraulic Oil Filter Transmission... H-65030 Oil Filter Full Flow..... O-5702 Oil Filter Full Flow..... C-8031		D50A-16 (DOZERS) 4D130 Fuel Filter..... FC-5606 D50A-16 (DOZERS) 4D130/65001 Air Filter Secondary..... A-5603 Air Filter Primary..... A-5602 Air Filter Set..... A-5601-S Fuel Filter..... F-2626 Fuel Filter..... FC-5602 Hydraulic Oil Filter..... H-5608 Oil Filter Full Flow..... O-5601 Oil Filter Full Flow..... C-5614	
D475A-5 (DOZERS) 2007 Cabin Air Filter..... CA-5602 Cabin Air Filter..... CA-56041 Fuel/Water Separator Secondary... SFC-5611-10 Fuel/Water Separator Secondary.. SFC-5611-10B Hydraulic Oil Filter..... H-5639		D50-17 (DOZERS) 6D125/80001 Air Filter Secondary..... A-5603 Air Filter Set..... A-5601-S Air Filter Primary..... A-5602 Fuel Filter..... FC-5602 Hydraulic Oil Filter..... H-5608 Hydraulic Oil Filter..... H-5611 Oil Filter Full Flow..... C-5614		D50A-17 (DOZERS) 6D125 Fuel Filter..... FC-5606 D50A-17 (DOZERS) 6D125/80001 Air Filter Secondary..... A-5603 Air Filter Primary..... A-5602 Air Filter Set..... A-5601-S Fuel Filter..... FC-5602 Hydraulic Oil Filter..... H-5611 Hydraulic Oil Filter..... H-5608 Oil Filter Full Flow..... C-5614	
D475A-5 (DOZERS) SDA12V140E Air Filter Secondary..... A-8580 Air Filter Primary..... A-8665M Cabin Air Filter..... CA-5602 Cabin Air Filter..... CA-56041 Fuel Filter..... FC-5703 Fuel/Water Separator..... SFC-5707 Hydraulic Oil Filter..... H-5609 Hydraulic Breather..... H-56610		D50A (DOZERS) 4D105-5 Air Filter Set..... A-5657-S Air Filter Primary..... A-5649 Fuel Filter..... F-2626 Hydraulic Oil Filter..... H-5608 Hydraulic Oil Filter..... H-5503 Hydraulic Oil Filter..... H-55280 Hydraulic Oil Filter..... H-5526 Oil Filter Full Flow..... O-5601		D50A-17 (DOZERS) 6D125/80001 Air Filter Secondary..... A-5603 Air Filter Primary..... A-5602 Air Filter Set..... A-5601-S Fuel Filter..... FC-5602 Hydraulic Oil Filter..... H-5611 Hydraulic Oil Filter..... H-5608 Oil Filter Full Flow..... C-5614	
D475A-5E0 (DOZERS) SAA12V140E-3 Air Filter Primary..... A-8665M Air Filter Secondary..... A-8580 Cabin Air Filter..... CA-56041 Cabin Air Filter..... CA-5602 Coolant Filter..... WC-56010 Fuel/Water Separator Secondary... SFC-5611-10 Fuel/Water Separator Secondary.. SFC-5611-10B Hydraulic Oil Filter..... H-5609		D50A (DOZERS) 4D105-5 Air Filter Set..... A-5657-S Air Filter Primary..... A-5649 Fuel Filter..... F-2626 Fuel Filter..... FC-5602 Oil Filter Full Flow..... C-5614 Oil Filter Full Flow..... O-5601		D50A-17 (DOZERS) 6D125/80001 Air Filter Secondary..... A-5603 Air Filter Primary..... A-5602 Air Filter Set..... A-5601-S Fuel Filter..... FC-5602 Hydraulic Oil Filter..... H-5611 Hydraulic Oil Filter..... H-5608 Oil Filter Full Flow..... C-5614	
D475ASD-5E0 (DOZERS) SAA12V140E-3 Air Filter Secondary..... A-8580 Air Filter Primary..... A-8665M Cabin Air Filter..... CA-56041 Cabin Air Filter..... CA-5602 Coolant Filter..... WC-56010 Fuel/Water Separator Secondary.. SFC-5611-10B Fuel/Water Separator Secondary.. SFC-5611-10 Hydraulic Oil Filter..... H-5609		D50A (DOZERS) 4D105-5 Air Filter Set..... A-5657-S Air Filter Primary..... A-5649 Fuel Filter..... F-2626 Hydraulic Oil Filter..... H-5526 Hydraulic Oil Filter..... H-5608 Hydraulic Oil Filter..... H-55280 Hydraulic Oil Filter..... H-5503 Oil Filter Full Flow..... O-5601		D50P-15 (DOZERS) 4D105-5 Air Filter Set..... A-5657-S Air Filter Primary..... A-5649 Fuel Filter..... F-2626 Hydraulic Oil Filter..... H-55280 Hydraulic Oil Filter..... H-5608 Hydraulic Oil Filter..... H-5526 Oil Filter Full Flow..... O-5601	
		D50A-15 (DOZERS) 4D105-5 Air Filter Primary..... A-5649 Air Filter Set..... A-5657-S Fuel Filter..... F-2626 Hydraulic Oil Filter..... H-5526 Hydraulic Oil Filter..... H-5608 Hydraulic Oil Filter..... H-55280 Hydraulic Oil Filter..... H-5503 Oil Filter Full Flow..... O-5601		D50P-15 (DOZERS) 4D120 Air Filter Set..... A-5657-S Air Filter Primary..... A-5649 Fuel Filter..... F-2626 Hydraulic Oil Filter..... H-55280 Hydraulic Oil Filter..... H-5608 Hydraulic Oil Filter..... H-5526 Hydraulic Oil Filter..... H-5503 Oil Filter Full Flow..... O-5601	
				D50P-16 (DOZERS) 4D130	

MODEL/APPLICATION	SAKURA NO	MODEL/APPLICATION	SAKURA NO	MODEL/APPLICATION	SAKURA NO
KOMATSU		KOMATSU		KOMATSU	
D50P-16 (DOZERS) 4D130		Hydraulic Oil Filter.....	H-5526	Air Filter Set.....	A-5601-S
Fuel Filter.....	FC-5606	Hydraulic Oil Filter.....	H-55280	Air Filter Secondary.....	A-5603
D50P-16 (DOZERS) 4D130/65001		Hydraulic Oil Filter.....	H-5608	Air Filter Primary.....	A-5602
Air Filter Set.....	A-5601-S	Oil Filter Full Flow.....	O-5601	Coolant Filter.....	WC-5707
Air Filter Secondary.....	A-5603	D50S-15 (DOZERS) 4D120-11		Fuel Filter.....	F-2626
Air Filter Primary.....	A-5602	Air Filter Primary.....	A-5649	Hydraulic Oil Filter.....	H-5620
Fuel Filter.....	F-2626	Air Filter Set.....	A-5657-S	Hydraulic Oil Filter.....	H-5608
Fuel Filter.....	FC-5602	Fuel Filter.....	F-5601	Hydraulic Oil Filter.....	H-5611
Hydraulic Oil Filter.....	H-5608	Fuel Filter.....	F-2626	Oil Filter Full Flow.....	O-5601
Oil Filter Full Flow.....	O-5601	Hydraulic Oil Filter.....	H-5503	D53A (DOZERS) 6D125	
Oil Filter Full Flow.....	C-5614	Hydraulic Oil Filter.....	H-5526	Air Filter Primary.....	A-5602
D50P-17 (DOZERS) 6D125		Hydraulic Oil Filter.....	H-55280	Air Filter Secondary.....	A-5603
Fuel Filter.....	FC-5606	Hydraulic Oil Filter.....	H-5608	Fuel Filter.....	FC-5602
D50P-17 (DOZERS) 6D125/80001		Oil Filter Full Flow.....	O-5601	Hydraulic Oil Filter.....	H-5608
Air Filter Primary.....	A-5602	D50S-16 (DOZERS) 4D130		Hydraulic Oil Filter.....	H-5620
Air Filter Secondary.....	A-5603	Fuel Filter.....	FC-5606	Hydraulic Oil Filter.....	H-5611
Air Filter Set.....	A-5601-S	D50S-16 (DOZERS) 4D130/65001		Oil Filter Full Flow.....	C-5614
Fuel Filter.....	FC-5602	Air Filter Secondary.....	A-5603	D53A-15 (DOZERS) 54D120	
Hydraulic Oil Filter.....	H-5608	Air Filter Primary.....	A-5602	Air Filter Set.....	A-5604-S
Hydraulic Oil Filter.....	H-5611	Air Filter Set.....	A-5601-S	Air Filter Primary.....	A-5605
Oil Filter Full Flow.....	C-5614	Fuel Filter.....	F-2626	Air Filter Secondary.....	A-5606
D50PL-16 (DOZERS) 4D130		Fuel Filter.....	FC-5602	Fuel Filter.....	F-2626
Fuel Filter.....	FC-5606	Hydraulic Oil Filter.....	H-5611	Hydraulic Oil Filter.....	H-5620
D50PL-16 (DOZERS) 4D130/65001		Oil Filter Full Flow.....	O-5601	Hydraulic Oil Filter.....	H-5608
Air Filter Primary.....	A-5602	Oil Filter Full Flow.....	C-5614	Oil Filter Full Flow.....	O-5601
Air Filter Secondary.....	A-5603	D51EX-22 (DOZERS) SAA6D107E-1 , 2008		D53A-16 (DOZERS) 4D120	
Air Filter Set.....	A-5601-S	Air Filter Primary.....	A-71360	Air Filter Primary.....	A-5602
Fuel Filter.....	FC-5602	Hydraulic Oil Filter.....	HC-5602	Air Filter Secondary.....	A-5603
Hydraulic Oil Filter.....	H-5608	Oil Filter Full Flow.....	C-5611	Air Filter Set.....	A-5601-S
Hydraulic Oil Filter.....	H-5611	D51EX-22 (DOZERS) SAA6D107E-1		Coolant Filter.....	WC-5707
Oil Filter Full Flow.....	C-5614	Fuel Filter.....	FC-5613	Fuel Filter.....	F-2626
D50PL-17 (DOZERS) 6D125		D51PX-22 (DOZERS) SAA6D107E-1 , 2008		Hydraulic Oil Filter.....	H-5620
Fuel Filter.....	FC-5606	Air Filter Primary.....	A-71360	Hydraulic Oil Filter.....	H-5608
D50PL-17 (DOZERS) 6D125/80001		Hydraulic Oil Filter.....	HC-5602	Hydraulic Oil Filter.....	H-5611
Air Filter Secondary.....	A-5603	Oil Filter Full Flow.....	C-5611	Oil Filter Full Flow.....	O-5601
Air Filter Primary.....	A-5602	D51PX-22 (DOZERS) SAA6D107E-1		D53A-16 (DOZERS) 4D130/65001	
Air Filter Set.....	A-5601-S	Fuel Filter.....	FC-5613	Air Filter Set.....	A-5601-S
Fuel Filter.....	FC-5602	D53A (DOZERS) 4D120		Air Filter Primary.....	A-5602
Hydraulic Oil Filter.....	H-5608	Air Filter Secondary.....	A-5603	Air Filter Secondary.....	A-5603
Hydraulic Oil Filter.....	H-5611	Air Filter Set.....	A-5601-S	Fuel Filter.....	F-2626
Oil Filter Full Flow.....	C-5614	Air Filter Primary.....	A-5602	Fuel Filter.....	FC-5606
D50S-15 (DOZERS) 4D120		Coolant Filter.....	WC-5707	Hydraulic Oil Filter.....	H-5611
Air Filter Primary.....	A-5649	Fuel Filter.....	F-2626	Hydraulic Oil Filter.....	H-5608
Air Filter Set.....	A-5657-S	Hydraulic Oil Filter.....	H-5620	Hydraulic Oil Filter.....	H-5620
Fuel Filter.....	F-5601	Hydraulic Oil Filter.....	H-5608	Oil Filter Full Flow.....	O-5601
Fuel Filter.....	F-2626	Hydraulic Oil Filter.....	H-5611	D53A-16 (DOZERS) 4D130/65001	
Hydraulic Oil Filter.....	H-5503	Oil Filter Full Flow.....	O-5601	Air Filter Primary.....	A-5602
D53A (DOZERS) 4D130		D53A (DOZERS) 4D130		Air Filter Secondary.....	A-5603
Air Filter Primary.....	A-5602	Air Filter Secondary.....	A-5603	Fuel Filter.....	FC-5602
Air Filter Secondary.....	A-5603	Air Filter Set.....	A-5601-S	Hydraulic Oil Filter.....	H-5620
Fuel Filter.....	FC-5602	Air Filter Primary.....	A-5602	Hydraulic Oil Filter.....	H-5608
Hydraulic Oil Filter.....	H-5611	Coolant Filter.....	WC-5707	Hydraulic Oil Filter.....	H-5620
Hydraulic Oil Filter.....	H-5620	Fuel Filter.....	F-2626	Oil Filter Full Flow.....	O-5601
Oil Filter Full Flow.....	C-5614	Hydraulic Oil Filter.....	H-5620	Oil Filter Full Flow.....	C-5614
		Hydraulic Oil Filter.....	H-5608		
		Hydraulic Oil Filter.....	H-5611		
		Oil Filter Full Flow.....	O-5601		
		D53A (DOZERS) 4D130			
		Air Filter Primary.....	A-5602		
		Air Filter Secondary.....	A-5603		
		Fuel Filter.....	FC-5602		
		Hydraulic Oil Filter.....	H-5620		
		Hydraulic Oil Filter.....	H-5608		
		Oil Filter Full Flow.....	O-5601		
		Oil Filter Full Flow.....	C-5614		

Sakura Filter

ENGINE APPLICATION

MODEL/APPLICATION	SAKURA NO	MODEL/APPLICATION	SAKURA NO	MODEL/APPLICATION	SAKURA NO
KOMATSU		KOMATSU		KOMATSU	
D53A-17 (DOZERS) 6D125		D53S-15 (DOZERS) S4D120		Air Filter Secondary.....	A-5606
Fuel Filter.....	FC-5606	Air Filter Secondary.....	A-5606	Air Filter Set.....	A-5604-S
D53A-17 (DOZERS) 6D125/80001		Air Filter Primary.....	A-5605	Air Filter Primary.....	A-5605
Air Filter Secondary.....	A-5603	Air Filter Set.....	A-5604-S	Fuel Filter.....	F-5601
Air Filter Primary.....	A-5602	Fuel Filter.....	F-2626	Hydraulic Oil Filter.....	H-5526
Fuel Filter.....	FC-5602	Hydraulic Oil Filter.....	H-5620	Hydraulic Oil Filter.....	H-55280
Hydraulic Oil Filter.....	H-5620	Hydraulic Oil Filter.....	H-5608	Hydraulic Oil Filter.....	H-5503
Hydraulic Oil Filter.....	H-5608	Oil Filter Full Flow.....	O-5601	Oil Filter Full Flow.....	O-5601
Hydraulic Oil Filter.....	H-5611	D53S-16 (DOZERS) 4D120		Oil Filter By Pass.....	O-5705
Oil Filter Full Flow.....	C-5614	Air Filter Set.....	A-5601-S	Oil Filter Full Flow.....	O-5603
D53P-16 (DOZERS) 4D120		Air Filter Secondary.....	A-5603	D55S-2 (DOZERS)	
Air Filter Primary.....	A-5602	Air Filter Primary.....	A-5602	Hydraulic Oil Filter.....	H-5526
Air Filter Set.....	A-5601-S	Fuel Filter.....	F-2626	Hydraulic Oil Filter.....	H-5610
Coolant Filter.....	WC-5707	Hydraulic Oil Filter.....	H-5611	Hydraulic Oil Filter.....	H-5503
Fuel Filter.....	F-2626	Hydraulic Oil Filter.....	H-5620	Hydraulic Oil Filter.....	H-55280
Hydraulic Oil Filter.....	H-5608	Hydraulic Oil Filter.....	H-56600	Hydraulic Oil Filter.....	H-5620
Hydraulic Oil Filter.....	H-5611	Hydraulic Oil Filter.....	H-5610	D55S-3 (DOZERS) CUMMINS	
Hydraulic Oil Filter.....	H-5620	Oil Filter Full Flow.....	O-5601	Air Filter Primary.....	A-5605
Oil Filter Full Flow.....	O-5601	D53S-16 (DOZERS) 4D130		Air Filter Secondary.....	A-5606
D53P-16 (DOZERS) 4D130		Air Filter Secondary.....	A-5603	Air Filter Set.....	A-5604-S
Air Filter Set.....	A-5601-S	Air Filter Set.....	A-5601-S	Fuel Filter.....	F-5601
Air Filter Secondary.....	A-5603	Air Filter Primary.....	A-5602	Hydraulic Oil Filter.....	H-55280
Air Filter Primary.....	A-5602	Fuel Filter.....	FC-5606	Hydraulic Oil Filter.....	H-56600
Coolant Filter.....	WC-5707	Fuel Filter.....	F-2626	Hydraulic Oil Filter.....	H-5526
Fuel Filter.....	FC-5606	Hydraulic Oil Filter.....	H-5611	Hydraulic Oil Filter.....	H-5610
Fuel Filter.....	F-2626	Hydraulic Oil Filter.....	H-5610	Hydraulic Oil Filter.....	H-5503
Hydraulic Oil Filter.....	H-5620	Hydraulic Oil Filter.....	H-5620	Oil Filter Full Flow.....	O-5601
Hydraulic Oil Filter.....	H-5608	Hydraulic Oil Filter.....	H-56600	Oil Filter By Pass.....	O-5705
Hydraulic Oil Filter.....	H-5611	Hydraulic Oil Filter.....	H-56600	Oil Filter Full Flow.....	O-5603
Oil Filter Full Flow.....	O-5601	Oil Filter Full Flow.....	O-5601	D55S-3 (DOZERS) S4D120	
D53P-16 (DOZERS) 4D130/65001		D53S-16 (DOZERS) 4D130/65001		Air Filter Set.....	A-5604-S
Air Filter Secondary.....	A-5603	Air Filter Primary.....	A-5602	Air Filter Primary.....	A-5605
Air Filter Primary.....	A-5602	Air Filter Secondary.....	A-5603	Air Filter Secondary.....	A-5606
Fuel Filter.....	FC-5602	Fuel Filter.....	FC-5602	Fuel Filter.....	F-2626
Fuel Filter.....	F-2626	Fuel Filter.....	F-2626	Hydraulic Oil Filter.....	H-5610
Hydraulic Oil Filter.....	H-5620	Hydraulic Oil Filter.....	H-5610	Hydraulic Oil Filter.....	H-56600
Hydraulic Oil Filter.....	H-5608	Hydraulic Oil Filter.....	H-5620	Hydraulic Oil Filter.....	H-5620
Hydraulic Oil Filter.....	H-5611	Hydraulic Oil Filter.....	H-56600	Oil Filter Full Flow.....	O-5601
Hydraulic Oil Filter.....	H-5620	Oil Filter Full Flow.....	O-5601	D570 (EXCAVATORS) SA12V170	
Oil Filter Full Flow.....	C-5614	Oil Filter Full Flow.....	C-5614	Fuel Filter.....	FC-5703
Oil Filter Full Flow.....	O-5601	D53S-17 (DOZERS) 4D130/80001		Fuel/Water Separator.....	SFC-5707
D53P-17 (DOZERS) 6D125		Air Filter Primary.....	A-5602	Oil Filter Full Flow.....	C-5605
Fuel Filter.....	FC-5606	Air Filter Secondary.....	A-5603	Oil Filter Full Flow.....	C-5715
D53P-17 (DOZERS) 6D125/80001		Fuel Filter.....	FC-5602	Oil Filter Full Flow.....	C-5701
Air Filter Primary.....	A-5602	Fuel Filter.....	F-2626	Oil Filter By Pass.....	C-5718
Air Filter Secondary.....	A-5603	Hydraulic Oil Filter.....	H-56600	D57-1 (DOZERS)	
Fuel Filter.....	FC-5602	Hydraulic Oil Filter.....	H-5611	Fuel Filter.....	F-2626
Hydraulic Oil Filter.....	H-5608	Hydraulic Oil Filter.....	H-5610	Oil Filter Full Flow.....	O-5601
Hydraulic Oil Filter.....	H-5611	Hydraulic Oil Filter.....	H-5620	D575A-2 (DOZERS) SA12V170-1/10001	
Hydraulic Oil Filter.....	H-5620	Oil Filter Full Flow.....	C-5614	Air Filter Secondary.....	A-5610
Oil Filter Full Flow.....	C-5614	D53S-17 (DOZERS) 4D130-1F		Air Filter Primary.....	A-5614
D53P-17 (DOZERS) 6D125		Fuel Filter.....	FC-5606	Coolant Filter.....	WC-56010
Fuel Filter.....	FC-5606	D55S (DOZERS) CUMMINS		Fuel Filter.....	FC-5703
D53P-17 (DOZERS) 6D125/80001					
Air Filter Primary.....	A-5602				
Air Filter Secondary.....	A-5603				
Fuel Filter.....	FC-5602				
Hydraulic Oil Filter.....	H-5608				
Hydraulic Oil Filter.....	H-5611				
Hydraulic Oil Filter.....	H-5620				
Oil Filter Full Flow.....	C-5614				

MODEL/APPLICATION	SAKURA NO	MODEL/APPLICATION	SAKURA NO	MODEL/APPLICATION	SAKURA NO
KOMATSU		KOMATSU		KOMATSU	
D575A-2 (DOZERS) SA12V170-1/10001		Hydraulic Oil Filter.....	H-5610	Air Filter Primary.....	A-5605
Fuel/Water Separator.....	SFC-5707	Hydraulic Oil Filter.....	H-56600	Fuel Filter.....	FC-5602
Hydraulic Oil Filter.....	H-7911	Hydraulic Oil Filter.....	H-5611	Hydraulic Oil Filter.....	H-5610
Hydraulic Oil Filter.....	H-85680	Oil Filter Full Flow.....	C-5608	Hydraulic Oil Filter.....	H-5620
Oil Filter Full Flow.....	C-5701			Hydraulic Oil Filter.....	H-56600
Oil Filter By Pass.....	C-5718	D575A (DOZERS) KOMATSU SA12V170E-2 , 1991		Oil Filter Full Flow.....	C-5614
Oil Filter Full Flow.....	C-5715	Fuel/Water Separator.....	SFC-5601-02		
Oil Filter Full Flow.....	C-5605	Oil Filter By Pass.....	C-5718	D60 (DOZERS) NH220	
D575A-3 (DOZERS) SA12V170E-2		D58-1 (DOZERS) 6D125E		Air Filter Set.....	A-5604-S
Coolant Filter.....	WC-56010	Fuel Filter.....	FC-5606	Air Filter Secondary.....	A-5606
Fuel Filter.....	FC-5703			Air Filter Primary.....	A-5605
Fuel/Water Separator.....	SFC-5707	D58-1 (DOZERS) 80588		Fuel Filter.....	F-5601
Hydraulic Oil Filter.....	H-5611	Air Filter Primary.....	A-5602	Hydraulic Oil Filter.....	H-5610
Hydraulic Oil Filter.....	H-7911	Air Filter Secondary.....	A-5603	Hydraulic Oil Filter.....	H-5620
Hydraulic Oil Filter.....	H-85680	Fuel Filter.....	FC-5602	Hydraulic Oil Filter.....	H-56600
Oil Filter By Pass.....	C-5718	Hydraulic Oil Filter.....	H-5608	Oil Filter Full Flow.....	O-5603
		Hydraulic Oil Filter.....	H-5611	Oil Filter By Pass.....	O-5704
D57S-1 (DOZERS) S4D130/6501 - 19999		Hydraulic Oil Filter.....	H-5620		
Air Filter Primary.....	A-5605	Hydraulic Oil Filter.....	H-5614	D60A (DOZERS)	
Air Filter Secondary.....	A-5606	Oil Filter Full Flow.....	O-5601	Air Filter Set.....	A-5604-S
Air Filter Set.....	A-5604-S	Oil Filter Full Flow.....	O-5704	Air Filter Secondary.....	A-5606
Fuel Filter.....	FC-5602			Air Filter Primary.....	A-5605
Fuel Filter.....	F-2626	D58-E (DOZERS)		Fuel Filter.....	FC-5602
Hydraulic Oil Filter.....	H-56600	Air Filter Primary.....	A-5602	Hydraulic Oil Filter.....	H-5620
Hydraulic Oil Filter.....	H-5610	Air Filter Set.....	A-5601-S	Hydraulic Oil Filter.....	H-5601
Hydraulic Oil Filter.....	H-5620	Fuel Filter.....	FC-5602	Oil Filter Full Flow.....	C-5614
Oil Filter Full Flow.....	C-5614	Hydraulic Oil Filter.....	H-5620		
Oil Filter Full Flow.....	O-5601	Hydraulic Oil Filter.....	H-5608	D60A-6 (DOZERS) NH220-C1	
Oil Filter By Pass.....	O-5704	Hydraulic Oil Filter.....	H-5611	Air Filter Set.....	A-5604-S
		Oil Filter Full Flow.....	C-5614	Air Filter Primary.....	A-5605
D57S-1 (DOZERS) S4D130/29635		D58E-1 (DOZERS) 6D125/80588		Air Filter Secondary.....	A-5606
Air Filter Primary.....	A-5605	Air Filter Secondary.....	A-5603	Coolant Filter.....	WC-5707
Air Filter Secondary.....	A-5606	Air Filter Primary.....	A-5602	Fuel Filter.....	F-5601
Air Filter Set.....	A-5604-S	Fuel Filter.....	FC-5602	Hydraulic Oil Filter.....	H-5601
Fuel Filter.....	FC-5602	Hydraulic Oil Filter.....	H-5608	Hydraulic Oil Filter.....	H-5620
Hydraulic Oil Filter.....	H-5611	Hydraulic Oil Filter.....	H-5611	Oil Filter Full Flow.....	O-5603
Hydraulic Oil Filter.....	H-5610	Hydraulic Oil Filter.....	H-5620	Oil Filter By Pass.....	O-5704
Hydraulic Oil Filter.....	H-5620	Oil Filter Full Flow.....	C-5614		
Oil Filter Full Flow.....	C-5614	D58E-1 (DOZERS) 6D125E		D60A-7 (DOZERS) NH220C1	
Oil Filter By Pass.....	O-5704	Fuel Filter.....	FC-5606	Air Filter Primary.....	A-5605
		D58P-1 (DOZERS) 6D125/80588		Air Filter Secondary.....	A-5606
D57S-1 (DOZERS) S6D108/20001		Air Filter Primary.....	A-5602	Air Filter Set.....	A-5604-S
Air Filter Primary.....	A-5605	Air Filter Secondary.....	A-5603	Fuel Filter.....	FC-5602
Air Filter Secondary.....	A-5606	Fuel Filter.....	FC-5602	Fuel Filter.....	FC-5606
Air Filter Set.....	A-5604-S	Hydraulic Oil Filter.....	H-5608	Hydraulic Oil Filter.....	H-5620
Hydraulic Oil Filter.....	H-5610	Hydraulic Oil Filter.....	H-5611	Hydraulic Oil Filter.....	H-5601
Hydraulic Oil Filter.....	H-5611	Hydraulic Oil Filter.....	H-5620	Oil Filter By Pass.....	O-5704
Hydraulic Oil Filter.....	H-56600	Oil Filter Full Flow.....	C-5614	Oil Filter Full Flow.....	C-5605
Hydraulic Oil Filter.....	H-5620			Oil Filter Full Flow.....	C-5701
Oil Filter Full Flow.....	C-5608	D58P-1 (DOZERS) 6D125E		Oil Filter Full Flow.....	C-5715
		Fuel Filter.....	FC-5606		
D57S-1B (DOZERS) S6D108		D60 (DOZERS) 6D125/45001		D60A-8 (DOZERS) 6D125	
Air Filter Set.....	A-5604-S	Air Filter Set.....	A-5604-S	Air Filter Set.....	A-5604-S
Air Filter Primary.....	A-5605	Air Filter Secondary.....	A-5606	Air Filter Primary.....	A-5605
Air Filter Secondary.....	A-5606			Air Filter Secondary.....	A-5606
Hydraulic Oil Filter.....	H-5620			Fuel Filter.....	FC-5606
				Fuel Filter.....	FC-5602
				Hydraulic Oil Filter.....	H-5601
				Hydraulic Oil Filter.....	H-5620

MODEL/APPLICATION	SAKURA NO	MODEL/APPLICATION	SAKURA NO	MODEL/APPLICATION	SAKURA NO
KOMATSU		KOMATSU		KOMATSU	
D60A-8 (DOZERS) 6D125		Fuel Filter.....	FC-5602	Fuel Filter.....	FC-5606
Oil Filter Full Flow.....	C-5614	Hydraulic Oil Filter.....	H-5620	Hydraulic Oil Filter.....	H-5620
		Hydraulic Oil Filter.....	H-5607	Hydraulic Oil Filter.....	H-5601
		Oil Filter By Pass.....	O-5704	Oil Filter Full Flow.....	C-5715
D60E-6 (DOZERS) NH220-C1		D60F-7A (DOZERS) NTO-6-CI/40001		Oil Filter Full Flow.....	C-5701
Air Filter Primary.....	A-5605	Air Filter Secondary.....	A-5408	Oil Filter By Pass.....	O-5704
Air Filter Set.....	A-5604-S	Air Filter Primary.....	A-6113		
Air Filter Secondary.....	A-5606	Fuel Filter.....	FC-5602	D60P-8 (DOZERS) 6D125	
Coolant Filter.....	WC-5707	Fuel Filter.....	FC-5602	Air Filter Secondary.....	A-5606
Fuel Filter.....	F-5601	Hydraulic Oil Filter.....	H-5607	Air Filter Set.....	A-5604-S
Hydraulic Oil Filter.....	H-5620	Hydraulic Oil Filter.....	H-5620	Air Filter Primary.....	A-5605
Hydraulic Oil Filter.....	H-5601	Oil Filter By Pass.....	O-5704	Fuel Filter.....	FC-5602
Oil Filter Full Flow.....	O-5603			Fuel Filter.....	FC-5606
Oil Filter By Pass.....	O-5704	D60F-8 (DOZERS) 6D125		Hydraulic Oil Filter.....	H-5620
		Air Filter Secondary.....	A-5606	Hydraulic Oil Filter.....	H-5601
D60E-7 (DOZERS) NH220C1		Air Filter Set.....	A-5604-S	Oil Filter Full Flow.....	C-5614
Air Filter Set.....	A-5604-S	Air Filter Primary.....	A-5605		
Air Filter Primary.....	A-5605	Fuel Filter.....	FC-5602	D60PL-6 (DOZERS) NH220-C1	
Air Filter Secondary.....	A-5606	Fuel Filter.....	FC-5606	Air Filter Primary.....	A-5605
Fuel Filter.....	FC-5602	Hydraulic Oil Filter.....	H-5620	Air Filter Set.....	A-5604-S
Fuel Filter.....	FC-5606	Hydraulic Oil Filter.....	H-5601	Air Filter Secondary.....	A-5606
Hydraulic Oil Filter.....	H-5601	Oil Filter Full Flow.....	C-5614	Coolant Filter.....	WC-5707
Hydraulic Oil Filter.....	H-5620			Fuel Filter.....	F-5601
Oil Filter By Pass.....	O-5704	D60P (DOZERS) NH220		Hydraulic Oil Filter.....	H-5620
Oil Filter Full Flow.....	C-5605	Air Filter Primary.....	A-5605	Hydraulic Oil Filter.....	H-5601
Oil Filter Full Flow.....	C-5701	Air Filter Secondary.....	A-5606	Oil Filter Full Flow.....	O-5603
Oil Filter Full Flow.....	C-5715	Air Filter Set.....	A-5604-S	Oil Filter By Pass.....	O-5704
		Fuel Filter.....	F-5601		
D60E-8 (DOZERS) 6D125		Hydraulic Oil Filter.....	H-5620	D60PL-7 (DOZERS) NH220C1	
Air Filter Set.....	A-5604-S	Hydraulic Oil Filter.....	H-5610	Air Filter Secondary.....	A-5606
Air Filter Secondary.....	A-5606	Hydraulic Oil Filter.....	H-56600	Air Filter Set.....	A-5604-S
Air Filter Primary.....	A-5605	Oil Filter Full Flow.....	O-5603	Air Filter Primary.....	A-5605
Fuel Filter.....	FC-5606	Oil Filter By Pass.....	O-5704	Fuel Filter.....	FC-5606
Fuel Filter.....	FC-5602			Fuel Filter.....	FC-5602
Hydraulic Oil Filter.....	H-5601	D60P-3 (DOZERS) NH220		Hydraulic Oil Filter.....	H-5601
Hydraulic Oil Filter.....	H-5641	Air Filter Primary.....	A-5637	Hydraulic Oil Filter.....	H-5620
Hydraulic Oil Filter.....	H-5620	Air Filter Primary.....	A-5636	Oil Filter By Pass.....	O-5704
Oil Filter Full Flow.....	C-5614	Fuel Filter.....	F-5601	Oil Filter Full Flow.....	C-5715
		Hydraulic Oil Filter.....	H-5610	Oil Filter Full Flow.....	C-5701
D60F-7 (DOZERS) NTC-743/40001		Hydraulic Oil Filter.....	H-56600	Oil Filter Full Flow.....	C-5605
Air Filter Primary.....	A-6113	Oil Filter Full Flow.....	O-5603		
Air Filter Secondary.....	A-5408	Oil Filter By Pass.....	O-5704	D60PL-8 (DOZERS) 6D125	
Fuel Filter.....	FC-5602			Air Filter Set.....	A-5604-S
Hydraulic Oil Filter.....	H-5607	D60P-6 (DOZERS) NH220-C1		Air Filter Secondary.....	A-5606
Hydraulic Oil Filter.....	H-5620	Air Filter Set.....	A-5604-S	Air Filter Primary.....	A-5605
Oil Filter By Pass.....	O-5704	Air Filter Secondary.....	A-5606	Fuel Filter.....	FC-5606
		Air Filter Primary.....	A-5605	Fuel Filter.....	FC-5602
D60F-7 (DOZERS) NTO-6-CI/40001		Coolant Filter.....	WC-5707	Hydraulic Oil Filter.....	H-5601
Air Filter Primary.....	A-6113	Fuel Filter.....	F-5601	Hydraulic Oil Filter.....	H-5620
Air Filter Secondary.....	A-5408	Hydraulic Oil Filter.....	H-5620	Hydraulic Oil Filter.....	H-5601
Fuel Filter.....	FC-5602	Hydraulic Oil Filter.....	H-5601	Oil Filter Full Flow.....	C-5614
Hydraulic Oil Filter.....	H-5620	Oil Filter Full Flow.....	O-5603		
Hydraulic Oil Filter.....	H-5607	Oil Filter By Pass.....	O-5704	D60S-3 (DOZERS) NH220	
Oil Filter By Pass.....	O-5704			Air Filter Primary.....	A-5637
		D60P-7 (DOZERS) NH220C1		Air Filter Primary.....	A-5636
D60F-7A (DOZERS) NTC-743/40001		Air Filter Set.....	A-5604-S	Fuel Filter.....	F-5601
Air Filter Secondary.....	A-5408	Air Filter Primary.....	A-5605	Hydraulic Oil Filter.....	H-5610
Air Filter Primary.....	A-6113	Air Filter Secondary.....	A-5606	Hydraulic Oil Filter.....	H-56600
		Fuel Filter.....	FC-5602	Oil Filter By Pass.....	O-5704

MODEL/APPLICATION	SAKURA NO	MODEL/APPLICATION	SAKURA NO	MODEL/APPLICATION	SAKURA NO
KOMATSU		KOMATSU		KOMATSU	
D60S-3 (DOZERS) NH220		Oil Filter Full Flow.....	C-5611	D61PX-15 (DOZERS) SAA6D107E-1 (S/N: B40001-49999)	
Oil Filter Full Flow.....	0-5603	D61EX-15EO (DOZERS) SAA6D107E-1 (S/N: B45001-UP)		Hydraulic Oil Filter.....	H-56540
D60S-6 (DOZERS) NH220		Fuel Filter.....	FC-5613	D61PX-23 (DOZERS) SAA6D107E-2 , 2013	
Air Filter Secondary.....	A-5606	Hydraulic Oil Filter.....	H-56540	Air Filter Primary.....	A-5666
Air Filter Set.....	A-5604-S	D61PX-12 (DOZERS) S6D114E-1		Air Filter Secondary.....	A-5667
Air Filter Primary.....	A-5605	Air Filter Secondary.....	A-5667	D61PX-23 (DOZERS) SAA6D107E-2	
Fuel Filter.....	F-5601	Air Filter Primary.....	A-5666	Hydraulic Oil Filter.....	H-56540
Hydraulic Oil Filter.....	H-5610	Cabin Air Filter Set.....	CA-5603-S	D61PXi-23 (DOZERS) SAA6D107E-2 , 2013	
Hydraulic Oil Filter.....	H-5620	Cabin Air Filter.....	CA-56041	Air Filter Secondary.....	A-5667
Hydraulic Oil Filter.....	H-56600	Coolant Filter.....	WC-5706	Air Filter Primary.....	A-5666
Oil Filter Full Flow.....	0-5603	Hydraulic Oil Filter.....	H-5607	D61PXi-23 (DOZERS) SAA6D107E-2	
Oil Filter By Pass.....	0-5704	Hydraulic Oil Filter Return.....	HC-5603	Hydraulic Oil Filter.....	H-56540
D60S-7 (DOZERS) NH220C1		Oil Filter Combination.....	C-5723	D61EX-15EO-BW (DOZERS) SAA6D107E-1KB-W	
Air Filter Primary.....	A-5605	Oil Filter Combination.....	C-5707	Hydraulic Oil Filter.....	H-56540
Air Filter Set.....	A-5604-S	D61EXI-23 (DOZERS) SAA6D107E-2 , 2013		D61PX-15EO-BW (DOZERS)	
Air Filter Secondary.....	A-5606	Air Filter Secondary.....	A-5667	Hydraulic Oil Filter.....	H-56540
Fuel Filter.....	FC-5602	Air Filter Primary.....	A-5666	D63E (DOZERS) 6D125E/1292	
Fuel Filter.....	FC-5606	D61EXI-23 (DOZERS) SAA6D107E-2		Air Filter Primary.....	A-5602
Hydraulic Oil Filter.....	H-5620	Hydraulic Oil Filter.....	H-56540	Air Filter Secondary.....	A-5603
Hydraulic Oil Filter.....	H-5610	D61EX-15 (DOZERS) SAA6D107E-1 , 2005		Fuel Filter.....	FC-5602
Hydraulic Oil Filter.....	H-56600	Air Filter Secondary.....	A-5667	Hydraulic Oil Filter.....	H-5620
Oil Filter By Pass.....	0-5704	Air Filter Primary.....	A-5666	Hydraulic Oil Filter.....	H-5608
Oil Filter Full Flow.....	C-5605	Cabin Air Filter.....	CA-56041	Hydraulic Oil Filter.....	H-5611
Oil Filter Full Flow.....	C-5701	Cabin Air Filter.....	CA-5602	Oil Filter Full Flow.....	C-5614
Oil Filter Full Flow.....	C-5715	Coolant Filter.....	WC-5706	D63E-1 (DOZERS) 6D125	
D60S-8 (DOZERS) 6D125		Fuel Filter.....	F-5218	Fuel Filter.....	FC-5606
Fuel Filter.....	FC-5606	Hydraulic Oil Filter.....	H-5607	D63E-1 (DOZERS) 6D125/1001	
D60S-8 (DOZERS) S/N: 45001		Oil Filter Combination.....	C-5707	Air Filter Secondary.....	A-5603
Air Filter Set.....	A-5604-S	Oil Filter Combination.....	C-5723	Air Filter Primary.....	A-5602
Air Filter Primary.....	A-5605	D61EX-15 (DOZERS) SAA6D107E-1 (S/N: B40001-49999)		Fuel Filter.....	FC-5602
Air Filter Secondary.....	A-5606	Hydraulic Oil Filter.....	H-56540	Hydraulic Oil Filter.....	H-5620
Fuel Filter.....	FC-5602	D61EX-23 (DOZERS) SAA6D107E-2 , 2013		Hydraulic Oil Filter.....	H-5608
Hydraulic Oil Filter.....	H-5620	Air Filter Secondary.....	A-5667	Hydraulic Oil Filter.....	H-5611
Hydraulic Oil Filter.....	H-5610	Air Filter Primary.....	A-5666	Oil Filter Full Flow.....	C-5614
Oil Filter Full Flow.....	C-5614	D61EX-23 (DOZERS) SAA6D107E-2		D65 (DOZERS) 2007	
D61EX-12 (DOZERS) S6D114E-1		Hydraulic Oil Filter.....	H-56540	Fuel Filter.....	FC-5621
Air Filter Secondary.....	A-5667	D61EX-15 (DOZERS) SAA6D107E-1 , 2005		D65A (DOZERS)	
Air Filter Primary.....	A-5666	Air Filter Secondary.....	A-5667	Air Filter Primary.....	A-5605
Cabin Air Filter.....	CA-56041	Air Filter Primary.....	A-5666	Air Filter Set.....	A-5604-S
Cabin Air Filter Set.....	CA-5603-S	Cabin Air Filter.....	CA-56041	Air Filter Secondary.....	A-5606
Coolant Filter.....	WC-5706	Cabin Air Filter.....	CA-5602	Fuel Filter.....	FC-5602
Hydraulic Oil Filter Return.....	HC-5603	Coolant Filter.....	WC-5706	Hydraulic Oil Filter.....	H-5620
Hydraulic Oil Filter.....	H-5607	Fuel Filter Secondary.....	FC-7903	Hydraulic Oil Filter.....	H-5608
Oil Filter Combination.....	C-5707	Fuel/Water Separator.....	SFC-5708	Hydraulic Oil Filter.....	H-5611
Oil Filter Combination.....	C-5723	Hydraulic Oil Filter.....	H-5607	Oil Filter Full Flow.....	C-5614
D61EX-15EO (DOZERS) SAA6D107E-1		Oil Filter Combination.....	C-5707	D65A (DOZERS)	
Air Filter Secondary.....	A-5667	Oil Filter Combination.....	C-5723	Air Filter Primary.....	A-5605
Air Filter Primary.....	A-5666	D61PX-15 (DOZERS) SAA6D107E-1 , 2005		Air Filter Set.....	A-5604-S
Cabin Air Filter.....	CA-5602	Air Filter Secondary.....	A-5667	Air Filter Secondary.....	A-5606
Cabin Air Filter.....	CA-56041	Air Filter Primary.....	A-5666	Fuel Filter.....	FC-5602
Hydraulic Oil Filter.....	H-5607	Cabin Air Filter.....	CA-56041	Hydraulic Oil Filter.....	H-5620
D61EX-15EO (DOZERS) SAA6D107E-1		Cabin Air Filter.....	CA-5602	Hydraulic Oil Filter.....	H-5601
Air Filter Secondary.....	A-5667	Coolant Filter.....	WC-5706	Oil Filter Full Flow.....	C-5614
Air Filter Primary.....	A-5666	Fuel Filter Secondary.....	FC-7903		
Cabin Air Filter.....	CA-5602	Fuel/Water Separator.....	SFC-5708		
Cabin Air Filter.....	CA-56041	Hydraulic Oil Filter.....	H-5607		
Hydraulic Oil Filter.....	H-5607	Oil Filter Combination.....	C-5707		
		Oil Filter Combination.....	C-5723		

Sakura Filter

ENGINE APPLICATION

MODEL/APPLICATION	SAKURA NO	MODEL/APPLICATION	SAKURA NO	MODEL/APPLICATION	SAKURA NO
KOMATSU		KOMATSU		KOMATSU	
D65A (DOZERS) NH220		Hydraulic Oil Filter.....	H-5620	D65E-6 (DOZERS) NH220-C1	
Air Filter Primary.....	A-5605	Oil Filter Full Flow.....	C-5614	Air Filter Primary.....	A-5605
Air Filter Set.....	A-5604-S	D65C-6 (DOZERS) NH220		Air Filter Secondary.....	A-5606
Air Filter Secondary.....	A-5606	Coolant Filter.....	WC-5711	Air Filter Set.....	A-5604-S
Fuel Filter.....	F-5601	Fuel Filter.....	F-5601	Coolant Filter.....	WC-5707
Hydraulic Oil Filter.....	H-5620	Oil Filter Full Flow.....	O-5603	Fuel Filter.....	F-5601
Hydraulic Oil Filter.....	H-56600	Oil Filter By Pass.....	O-5704	Hydraulic Oil Filter.....	H-5620
Hydraulic Oil Filter.....	H-5610	D65E-12 (DOZERS) 6D125		Hydraulic Oil Filter.....	H-5601
Oil Filter Full Flow.....	O-5603	Air Filter Primary.....	A-6113	Oil Filter Full Flow.....	O-5603
Oil Filter By Pass.....	O-5704	Air Filter Secondary.....	A-5408	Oil Filter By Pass.....	O-5704
D65A-6 (DOZERS) NH220		Fuel Filter.....	FC-5602	D65E-7 (DOZERS) NH220C1	
Air Filter Set.....	A-5604-S	Hydraulic Oil Filter.....	H-5607	Fuel Filter.....	FC-5606
Air Filter Primary.....	A-5605	Hydraulic Oil Filter.....	H-5610	D65E-7 (DOZERS) NH220-C1/40001	
Air Filter Secondary.....	A-5606	Hydraulic Oil Filter.....	H-56600	Air Filter Set.....	A-5604-S
Fuel Filter.....	F-5601	Oil Filter Full Flow.....	C-5715	Air Filter Primary.....	A-5605
Hydraulic Oil Filter.....	H-5620	Oil Filter Full Flow.....	C-5701	Air Filter Secondary.....	A-5606
Hydraulic Oil Filter.....	H-5610	Oil Filter Full Flow.....	C-5605	Fuel Filter.....	FC-5602
Hydraulic Oil Filter.....	H-56600	D65E-12 (DOZERS) 6D125/60001 - 60941		Hydraulic Oil Filter.....	H-5601
Oil Filter Full Flow.....	O-5603	Air Filter Secondary.....	A-5408	Hydraulic Oil Filter.....	H-5620
Oil Filter By Pass.....	O-5704	Air Filter Primary.....	A-6113	Oil Filter By Pass.....	O-5704
D65A-6 (DOZERS) NH220-C1		Air Filter Secondary.....	A-5603	Oil Filter Full Flow.....	C-5715
Air Filter Secondary.....	A-5606	Air Filter Primary.....	A-5602	Oil Filter Full Flow.....	C-5605
Air Filter Set.....	A-5604-S	Fuel Filter.....	FC-5602	Oil Filter Full Flow.....	C-5701
Air Filter Primary.....	A-5605	Hydraulic Oil Filter.....	H-5607	D65E-8 (DOZERS) 6D125	
Coolant Filter.....	WC-5707	Hydraulic Oil Filter.....	H-5610	Fuel Filter.....	FC-5606
Fuel Filter.....	F-5601	Hydraulic Oil Filter.....	H-56600	D65E-8 (DOZERS) 6D125/45001	
Hydraulic Oil Filter.....	H-5601	Oil Filter Full Flow.....	C-5614	Air Filter Primary.....	A-5605
Hydraulic Oil Filter.....	H-5620	Oil Filter Full Flow.....	C-5715	Air Filter Set.....	A-5604-S
Oil Filter Full Flow.....	O-5603	Oil Filter Full Flow.....	C-5701	Air Filter Secondary.....	A-5606
Oil Filter By Pass.....	O-5704	Oil Filter Full Flow.....	C-5605	Fuel Filter.....	FC-5602
D65A-7 (DOZERS) NH220C1		D65E-12 (DOZERS) S6D125		Hydraulic Oil Filter.....	H-5601
Fuel Filter.....	FC-5606	Air Filter Primary.....	A-6113	Hydraulic Oil Filter.....	H-5620
D65A-7 (DOZERS) NH220-C1/40001		Air Filter Secondary.....	A-5408	Oil Filter Full Flow.....	C-5614
Air Filter Primary.....	A-5605	Fuel Filter.....	FC-5602	D65EX-12 (DOZERS) 6D125/60001 - 60941	
Air Filter Secondary.....	A-5606	Hydraulic Oil Filter.....	H-5607	Air Filter Secondary.....	A-5408
Air Filter Set.....	A-5604-S	Hydraulic Oil Filter.....	H-5610	Air Filter Primary.....	A-6113
Fuel Filter.....	FC-5602	Hydraulic Oil Filter.....	H-56600	Fuel Filter.....	FC-5602
Hydraulic Oil Filter.....	H-5601	Oil Filter Full Flow.....	C-5605	Hydraulic Oil Filter.....	H-56600
Hydraulic Oil Filter.....	H-5620	Oil Filter Full Flow.....	C-5715	Hydraulic Oil Filter.....	H-5607
Oil Filter Full Flow.....	C-5715	Oil Filter Full Flow.....	C-5701	Hydraulic Oil Filter.....	H-5610
Oil Filter Full Flow.....	C-5605	D65E-12 (DOZERS) S6D125/60001 - 60941		Oil Filter Full Flow.....	C-5605
Oil Filter By Pass.....	O-5704	Air Filter Secondary.....	A-5603	Oil Filter Full Flow.....	C-5715
Oil Filter Full Flow.....	C-5701	Air Filter Primary.....	A-5602	Oil Filter Full Flow.....	C-5701
D65A-8 (DOZERS) 6D125		Air Filter Primary.....	A-6113	D65EX-12 (DOZERS) S6D125/60001 - 60941	
Fuel Filter.....	FC-5606	Air Filter Secondary.....	A-5408	Air Filter Secondary.....	A-5408
D65A-8 (DOZERS) 6D125/45001		Fuel Filter.....	FC-5602	Air Filter Primary.....	A-6113
Air Filter Set.....	A-5604-S	Hydraulic Oil Filter.....	H-5607	Fuel Filter.....	FC-5602
Air Filter Secondary.....	A-5606	Hydraulic Oil Filter.....	H-5610	Hydraulic Oil Filter.....	H-5607
Air Filter Primary.....	A-5605	Hydraulic Oil Filter.....	H-56600	Hydraulic Oil Filter.....	H-56600
Fuel Filter.....	FC-5602	Oil Filter Full Flow.....	C-5614	Hydraulic Oil Filter.....	H-5610
Hydraulic Oil Filter.....	H-5601	Oil Filter Full Flow.....	C-5715	Oil Filter Full Flow.....	C-5715
		Oil Filter Full Flow.....	C-5701	Oil Filter Full Flow.....	C-5701
		Oil Filter Full Flow.....	C-5605		

Sakura Filter

ENGINE APPLICATION

MODEL/APPLICATION	SAKURA NO	MODEL/APPLICATION	SAKURA NO	MODEL/APPLICATION	SAKURA NO
KOMATSU		KOMATSU		KOMATSU	
D65EX-12 (DOZERS) S6D125/60001 - 60941		Oil Filter Full Flow.....	C-5701	Air Filter Set.....	A-5604-S
Oil Filter Full Flow.....	C-5701	Oil Filter Full Flow.....	C-5715	Air Filter Primary.....	A-5605
Oil Filter Full Flow.....	C-5605			Air Filter Secondary.....	A-5606
		D65P-12 (DOZERS) S6D125/60001 - 60941		Fuel Filter.....	FC-5602
D65EX-12 (DOZERS) S6D125E-2		Air Filter Secondary.....	A-5408	Hydraulic Oil Filter.....	H-5620
Fuel Filter.....	F-56040	Air Filter Primary.....	A-6113	Hydraulic Oil Filter.....	H-5601
		Fuel Filter.....	FC-5602	Oil Filter Full Flow.....	C-5614
D65EX-15 (DOZERS) SAA6D125E-3/67001/69000		Hydraulic Oil Filter.....	H-56600		
Air Filter Primary.....	A-5558M	Hydraulic Oil Filter.....	H-5607	D65PL-6 (DOZERS) NH220	
Air Filter Secondary.....	A-5559	Hydraulic Oil Filter.....	H-5610	Air Filter Set.....	A-5604-S
Air Filter Set.....	A-5558M-S	Oil Filter Full Flow.....	C-5605	Air Filter Primary.....	A-5605
Hydraulic Oil Filter.....	H-5607	Oil Filter Full Flow.....	C-5701	Air Filter Secondary.....	A-5606
		Oil Filter Full Flow.....	C-5715	Fuel Filter.....	F-5601
D65EX-15E0 (DOZERS) SAA6D114E-3 (S/N: 69001-UP) , 2007				Hydraulic Oil Filter.....	H-56600
Air Filter Primary.....	A-5558M	D65P-6 (DOZERS) NH220		Hydraulic Oil Filter.....	H-5610
Air Filter Secondary.....	A-5559	Air Filter Secondary.....	A-5606	Hydraulic Oil Filter.....	H-5620
Air Filter Set.....	A-5558M-S	Air Filter Set.....	A-5604-S	Oil Filter Full Flow.....	O-5603
Cabin Air Filter.....	CA-56041	Air Filter Primary.....	A-5605	Oil Filter By Pass.....	O-5704
Cabin Air Filter.....	CA-5602	Fuel Filter.....	F-5601		
Hydraulic Breather.....	H-56610	Hydraulic Oil Filter.....	H-5610	D65PL-6 (DOZERS) NH220-C1	
Oil Filter Combination.....	C-5707	Hydraulic Oil Filter.....	H-5620	Air Filter Set.....	A-5604-S
		Hydraulic Oil Filter.....	H-56600	Air Filter Primary.....	A-5605
D65EX-15E0 (DOZERS) SAA6D114E-3 (S/N: 69001-UP)		Oil Filter Full Flow.....	O-5603	Air Filter Secondary.....	A-5606
Fuel Filter.....	FC-5613	Oil Filter By Pass.....	O-5704	Coolant Filter.....	WC-5707
				Fuel Filter.....	F-5601
D65F-8 (DOZERS) 6D125		D65P-6 (DOZERS) NH220-C1		Hydraulic Oil Filter.....	H-5620
Fuel Filter.....	FC-5606	Air Filter Secondary.....	A-5606	Hydraulic Oil Filter.....	H-5601
		Air Filter Set.....	A-5604-S	Oil Filter Full Flow.....	O-5603
D65F-8 (DOZERS) 6D125/45001		Air Filter Primary.....	A-5605	Oil Filter By Pass.....	O-5704
Air Filter Set.....	A-5604-S	Coolant Filter.....	WC-5707		
Air Filter Primary.....	A-5605	Fuel Filter.....	F-5601	D65PL-7 (DOZERS) NH220C1	
Air Filter Secondary.....	A-5606	Hydraulic Oil Filter.....	H-5620	Fuel Filter.....	FC-5606
Fuel Filter.....	FC-5602	Hydraulic Oil Filter.....	H-5601		
Hydraulic Oil Filter.....	H-5620	Oil Filter By Pass.....	O-5704	D65PL-7 (DOZERS) NH220-C1/40001	
Hydraulic Oil Filter.....	H-56600	Oil Filter Full Flow.....	O-5603	Air Filter Set.....	A-5604-S
Oil Filter Full Flow.....	C-5614	Oil Filter Full Flow.....	O-5603	Air Filter Primary.....	A-5605
Oil Filter By Pass.....	O-5704			Air Filter Secondary.....	A-5606
				Fuel Filter.....	FC-5602
D65P (DOZERS) NH220		D65P-7 (DOZERS) NH220C1		Hydraulic Oil Filter.....	H-5620
Air Filter Set.....	A-5604-S	Fuel Filter.....	FC-5606	Hydraulic Oil Filter.....	H-5601
Air Filter Secondary.....	A-5606			Oil Filter By Pass.....	O-5704
Air Filter Primary.....	A-5605	D65P-7 (DOZERS) NH220-C1/40001		Oil Filter Full Flow.....	C-5605
Fuel Filter.....	F-5601	Air Filter Set.....	A-5604-S	Oil Filter Full Flow.....	C-5715
Hydraulic Oil Filter.....	H-5610	Air Filter Primary.....	A-5605	Oil Filter Full Flow.....	C-5701
Hydraulic Oil Filter.....	H-5620	Air Filter Secondary.....	A-5606		
Hydraulic Oil Filter.....	H-56600	Fuel Filter.....	FC-5602	D65PL-8 (DOZERS) 6D125	
Oil Filter Full Flow.....	O-5603	Hydraulic Oil Filter.....	H-5601	Fuel Filter.....	FC-5606
Oil Filter By Pass.....	O-5704	Hydraulic Oil Filter.....	H-5620		
		Hydraulic Oil Filter.....	H-56600	D65PL-8 (DOZERS) 6D125/45001	
D65P-12 (DOZERS) 6D125/60001 - 60941		Oil Filter Full Flow.....	C-5701	Air Filter Set.....	A-5604-S
Air Filter Secondary.....	A-5408	Oil Filter By Pass.....	O-5704	Air Filter Primary.....	A-5605
Air Filter Primary.....	A-6113	Oil Filter Full Flow.....	C-5605	Air Filter Secondary.....	A-5606
Fuel Filter.....	FC-5602			Fuel Filter.....	FC-5602
Hydraulic Oil Filter.....	H-5607	D65P-8 (DOZERS) 6D105-1		Hydraulic Oil Filter.....	H-5601
Hydraulic Oil Filter.....	H-5610	Oil Filter Full Flow.....	C-5614	Hydraulic Oil Filter.....	H-5620
Hydraulic Oil Filter.....	H-56600			Oil Filter Full Flow.....	C-5614
Oil Filter Full Flow.....	C-5605	D65P-8 (DOZERS) 6D125			
Oil Filter By Pass.....	O-5704	Fuel Filter.....	FC-5606	D65PX-12 (DOZERS) 6D125/60001 - 60941	
				Air Filter Set.....	A-5604-S
		D65P-8 (DOZERS) 6D125/45001		Air Filter Primary.....	A-5605
		Air Filter Full Flow.....	C-5614	Air Filter Secondary.....	A-5606
				Fuel Filter.....	FC-5602
				Hydraulic Oil Filter.....	H-5601
				Hydraulic Oil Filter.....	H-5620
				Oil Filter Full Flow.....	C-5614

MODEL/APPLICATION	SAKURA NO	MODEL/APPLICATION	SAKURA NO	MODEL/APPLICATION	SAKURA NO
KOMATSU		KOMATSU		KOMATSU	
D65PX-12 (DOZERS) 6D125/6001 - 60941		Fuel Filter.....	FC-5602	Oil Filter Combination.....	C-5707
Air Filter Primary.....	A-6113	Hydraulic Oil Filter.....	H-56600	D65PX-16 (DOZERS) KOMATSU SAA6D114E-3	
Air Filter Secondary.....	A-5408	Hydraulic Oil Filter.....	H-5610	Fuel Filter.....	FC-56270
Fuel Filter.....	FC-5602	Hydraulic Oil Filter.....	H-5620	Oil Filter Transmission.....	TC-56010
Hydraulic Oil Filter.....	H-5610	Oil Filter By Pass.....	O-5704	D65PX-16 (DOZERS) SAA6D114E-3	
Hydraulic Oil Filter.....	H-56600	Oil Filter Full Flow.....	C-5715	Fuel Filter.....	FC-5613
Hydraulic Oil Filter.....	H-5607	Oil Filter Full Flow.....	C-5701	D65WX-16 (DOZERS) SAA6D114E-3 , 2011	
Oil Filter Full Flow.....	C-5701	Oil Filter Full Flow.....	C-5605	Air Filter Primary.....	A-5558M
Oil Filter Full Flow.....	C-5605	D655-8 (DOZERS) 6D125		Air Filter Secondary.....	A-5559
Oil Filter Full Flow.....	C-5715	Fuel Filter.....	FC-5606	Air Filter Set.....	A-5558M-S
D65PX-12 (DOZERS) S6D125/6001 - 60941		D655-8 (DOZERS) 6D125/45001		Cabin Air Filter.....	CA-5602
Air Filter Secondary.....	A-5408	Air Filter Set.....	A-5604-S	Hydraulic Oil Filter.....	H-56650
Air Filter Primary.....	A-6113	Air Filter Primary.....	A-5605	Oil Filter Combination.....	C-5707
Fuel Filter.....	FC-5602	Air Filter Secondary.....	A-5606	D65WX-16 (DOZERS) SAA6D114E-3	
Hydraulic Oil Filter.....	H-5610	Fuel Filter.....	FC-5602	Fuel Filter.....	FC-5613
Hydraulic Oil Filter.....	H-5607	Hydraulic Oil Filter.....	H-56600	D65WX (DOZERS) SAA6D114E , 2011	
Hydraulic Oil Filter.....	H-56600	Hydraulic Oil Filter.....	H-5610	Oil Filter Combination.....	C-5707
Oil Filter Full Flow.....	C-5605	Hydraulic Oil Filter.....	H-5620	D65EX-18 (DOZERS) KOMATSU SAA6D114E-6	
Oil Filter Full Flow.....	C-5715	Hydraulic Oil Filter.....	H-5620	Hydraulic Oil Filter.....	H-56652
Oil Filter Full Flow.....	C-5701	Oil Filter Full Flow.....	C-5614	D66S-1 (LOADERS) SA6D110	
D65PX-15 (DOZERS) SA6D125E-3/67001/69000		D65WX-15E (DOZERS)		Fuel Filter.....	FC-5606
Air Filter Primary.....	A-5558M	Air Filter Primary.....	A-5558M	D66S-1 (LOADERS) SA6D110/1001	
Air Filter Secondary.....	A-5559	Air Filter Secondary.....	A-5559	Air Filter Primary.....	A-6113
Air Filter Set.....	A-5558M-S	Air Filter Set.....	A-5558M-S	Air Filter Secondary.....	A-5408
Fuel/Water Separator Secondary..	SFC-5611-10B	Cabin Air Filter.....	CA-56041	Fuel Filter.....	FC-5602
Fuel/Water Separator Secondary..	SFC-5611-10	Fuel Filter.....	FC-5613	Hydraulic Oil Filter.....	H-5611
D65PX-15E0 (DOZERS) SAA6D114E-3 (S/N: 69001-UP) , 2007		Hydraulic Oil Filter.....	H-5607	Hydraulic Oil Filter.....	H-5610
Air Filter Primary.....	A-5558M	Oil Filter Combination.....	C-5707	Hydraulic Oil Filter.....	H-56600
Air Filter Secondary.....	A-5559	D65-16 (DOZERS) SAA6D114E-3 , 2010		Hydraulic Oil Filter.....	H-5620
Air Filter Set.....	A-5558M-S	Air Filter Primary.....	A-5558M	Oil Filter Full Flow.....	C-5614
Cabin Air Filter.....	CA-56041	Air Filter Secondary.....	A-5559	D68-1 (DOZERS) S/N: 45590	
Cabin Air Filter.....	CA-5602	Air Filter Set.....	A-5558M-S	Air Filter Set.....	A-5604-S
Hydraulic Breather.....	H-56610	Cabin Air Filter.....	CA-5602	Air Filter Primary.....	A-5605
Oil Filter Combination.....	C-5707	Hydraulic Oil Filter.....	H-56650	Air Filter Secondary.....	A-5606
D65PX-15E0 (DOZERS) SAA6D114E-3 (S/N: 69001-UP)		Oil Filter Combination.....	C-5707	Fuel Filter.....	FC-5602
Fuel Filter.....	FC-5613	D65EX-16 (DOZERS) KOMATSU SAA6D114E-3		Hydraulic Oil Filter.....	H-5620
D65S-6 (DOZERS) NH220		Fuel Filter.....	FC-56270	Hydraulic Oil Filter.....	H-5601
Air Filter Secondary.....	A-5606	Oil Filter Transmission.....	TC-56010	Oil Filter Full Flow.....	C-5614
Air Filter Primary.....	A-5605	D65EX-16 (DOZERS) KOMATSU SAA6D114E-3		D68E-1 (DOZERS) 6D125	
Air Filter Set.....	A-5604-S	Fuel Filter.....	FC-5613	Air Filter Primary.....	A-5623
Fuel Filter.....	F-5601	D65PX-16 (DOZERS) SAA6D114E-3 , 2010		Air Filter Set.....	A-5622-S
Hydraulic Oil Filter.....	H-5610	Air Filter Secondary.....	A-5559	Air Filter Secondary.....	A-5624
Hydraulic Oil Filter.....	H-56600	Air Filter Set.....	A-5558M-S	Fuel Filter.....	FC-5602
Hydraulic Oil Filter.....	H-5620	Air Filter Primary.....	A-5558M	Fuel Filter.....	FC-5606
Oil Filter Full Flow.....	O-5603	Cabin Air Filter.....	CA-5602	Hydraulic Oil Filter.....	H-5601
Oil Filter By Pass.....	O-5704	Hydraulic Oil Filter.....	H-56650	Hydraulic Oil Filter.....	H-5620
D65S-7 (DOZERS) NH220C1		D65EX-16 (DOZERS) SAA6D114E-3		Oil Filter By Pass.....	C-5718
Air Filter Set.....	A-5604-S	Fuel Filter.....	FC-5613		
Air Filter Primary.....	A-5605	D65PX-16 (DOZERS) SAA6D114E-3 , 2010			
Air Filter Secondary.....	A-5606	Air Filter Secondary.....	A-5559		
Fuel Filter.....	FC-5606	Air Filter Set.....	A-5558M-S		
		Air Filter Primary.....	A-5558M		
		Cabin Air Filter.....	CA-5602		
		Hydraulic Oil Filter.....	H-56650		

Sakura Filter

ENGINE APPLICATION

MODEL/APPLICATION	SAKURA NO	MODEL/APPLICATION	SAKURA NO	MODEL/APPLICATION	SAKURA NO
KOMATSU		KOMATSU		KOMATSU	
D70-LE (DOZERS) 6D125		Fuel Filter.....	FC-5602	Air Filter Primary.....	A-5636
Fuel Filter.....	FC-5606	Hydraulic Oil Filter.....	H-56600	Air Filter Primary.....	A-5637
D70-LE (DOZERS) 6D125/45200		Hydraulic Oil Filter.....	H-5606	Coolant Filter.....	WC-5711
Air Filter Secondary.....	A-5606	Hydraulic Oil Filter.....	H-5610	Fuel Filter.....	F-5601
Air Filter Primary.....	A-5605	Oil Filter Full Flow.....	C-5715	Hydraulic Oil Filter.....	H-55270
Air Filter Primary.....	A-6113	Oil Filter Full Flow.....	C-5605	Hydraulic Oil Filter.....	H-5607
Air Filter Set.....	A-5604-S	Oil Filter Full Flow.....	C-5701	Hydraulic Oil Filter.....	H-5504
Air Filter Secondary.....	A-5408	D80-12 (DOZERS) CUMMINS		Oil Filter Full Flow.....	O-5702
Fuel Filter.....	FC-5602	Air Filter Primary.....	A-5636	Oil Filter Full Flow.....	O-5603
Hydraulic Oil Filter.....	H-5601	Coolant Filter.....	WC-5711	Oil Filter By Pass.....	O-5704
Hydraulic Oil Filter.....	H-5620	Fuel Filter.....	F-5601	D80A-12 (DOZERS) NH220-C1	
Oil Filter Full Flow.....	C-5614	Hydraulic Oil Filter.....	H-5610	Coolant Filter.....	WC-5707
D75A-1 (DOZERS) S6D125		Hydraulic Oil Filter.....	H-5504	Fuel Filter.....	F-5601
Fuel Filter.....	FC-5606	Hydraulic Oil Filter.....	H-55270	Hydraulic Oil Filter.....	H-5607
D75A-1 (DOZERS) S6D125/10001		Hydraulic Oil Filter.....	H-56600	Oil Filter Full Flow.....	O-5603
Air Filter Set.....	A-5604-S	Oil Filter Full Flow.....	O-5603	D80A-18 (DOZERS) CUMMINS NT-855	
Air Filter Primary.....	A-5605	Oil Filter By Pass.....	O-5704	Fuel Filter.....	FC-5606
Air Filter Secondary.....	A-5606	D80-18 (DOZERS) NT-855/25001		D80A-18 (DOZERS) NT-855	
Fuel Filter.....	FC-5602	Air Filter Secondary.....	A-5610	Air Filter Secondary.....	A-5610
Hydraulic Oil Filter.....	H-5620	Air Filter Primary.....	A-5614	Air Filter Primary.....	A-5614
Hydraulic Oil Filter.....	H-5601	Fuel Filter.....	F-5601	Coolant Filter.....	WC-5711
Oil Filter Full Flow.....	C-5605	Fuel Filter.....	FC-5602	Fuel Filter.....	FC-5602
Oil Filter Full Flow.....	C-5701	Hydraulic Oil Filter.....	H-56600	Hydraulic Oil Filter.....	H-56600
Oil Filter Full Flow.....	C-5715	Hydraulic Oil Filter.....	H-5606	Hydraulic Oil Filter.....	H-5610
D75S-2 (LOADERS) NH220		Hydraulic Oil Filter.....	H-5610	Hydraulic Oil Filter.....	H-5606
Air Filter Primary.....	A-5623	Hydraulic Oil Filter.....	H-5606	Oil Filter Full Flow.....	C-5715
Air Filter Set.....	A-5622-S	Hydraulic Oil Filter.....	H-5610	Oil Filter By Pass.....	O-5704
Air Filter Secondary.....	A-5624	Hydraulic Oil Filter.....	H-56600	Oil Filter Full Flow.....	C-5605
Coolant Filter.....	WC-5711	Hydraulic Oil Filter.....	H-5504	Oil Filter Full Flow.....	C-5701
Fuel Filter.....	F-5601	Oil Filter By Pass.....	O-5704	Oil Filter Full Flow.....	C-5701
Hydraulic Oil Filter.....	H-5610	Oil Filter Full Flow.....	O-5603	D80E (DOZERS) NT-855	
Hydraulic Oil Filter.....	H-56600	D80-8 (DOZERS) CUMMINS		Air Filter Primary.....	A-5614
Oil Filter Full Flow.....	O-5603	Air Filter Primary.....	A-5636	Air Filter Secondary.....	A-5610
Oil Filter By Pass.....	O-5704	Coolant Filter.....	WC-5711	Coolant Filter.....	WC-5707
D75S-3 (LOADERS) NTO-6-C1		Fuel Filter.....	F-5601	Fuel Filter.....	F-5601
Air Filter Secondary.....	A-5408	Hydraulic Oil Filter.....	H-55270	Fuel Filter.....	FC-5720
Air Filter Primary.....	A-6113	Hydraulic Oil Filter.....	H-56600	Fuel/Water Separator.....	SFC-5705
Fuel Filter.....	FC-5606	Hydraulic Oil Filter.....	H-5610	Hydraulic Oil Filter.....	H-5610
Fuel Filter.....	F-5601	Hydraulic Oil Filter.....	H-5504	Hydraulic Oil Filter.....	H-5606
Hydraulic Oil Filter.....	H-5606	Oil Filter By Pass.....	O-5704	Hydraulic Oil Filter.....	H-56600
Hydraulic Oil Filter.....	H-5610	Oil Filter Full Flow.....	O-5603	Oil Filter Full Flow.....	C-5605
Hydraulic Oil Filter.....	H-56600	D80A (DOZERS) NT-855		Oil Filter Full Flow.....	C-5715
Oil Filter Full Flow.....	O-5603	Air Filter Secondary.....	A-5610	Oil Filter Full Flow.....	C-5701
Oil Filter By Pass.....	O-5704	Air Filter Primary.....	A-5614	Oil Filter By Pass.....	O-5704
D75S-5 (LOADERS) S6D125		Coolant Filter.....	WC-5707	D80E-12 (DOZERS) NH220-C1	
Fuel Filter.....	FC-5606	Fuel Filter.....	FC-5720	Coolant Filter.....	WC-5707
D75S-5 (LOADERS) S6D125/15001		Fuel Filter.....	F-5601	Fuel Filter.....	F-5601
Air Filter Secondary.....	A-5408	Fuel/Water Separator.....	SFC-5705	Hydraulic Oil Filter.....	H-5607
Air Filter Primary.....	A-6113	Hydraulic Oil Filter.....	H-56600	Oil Filter Full Flow.....	O-5603
D80A-12 (DOZERS) NH220		Hydraulic Oil Filter.....	H-5610	D80E-18 (DOZERS) CUMMINS NT-855	
Air Filter Secondary.....	A-5610	Hydraulic Oil Filter.....	H-5606	Fuel Filter.....	FC-5606
Air Filter Primary.....	A-5614	Oil Filter Full Flow.....	C-5701	D80E-18 (DOZERS) NT-855	
Coolant Filter.....	WC-5707	Oil Filter Full Flow.....	C-5715	D80E-12 (DOZERS) NH220-C1	
Fuel Filter.....	FC-5720	Oil Filter By Pass.....	O-5704	Coolant Filter.....	WC-5707
Fuel Filter.....	F-5601	Oil Filter Full Flow.....	C-5605	Fuel Filter.....	F-5601
Fuel/Water Separator.....	SFC-5705	D80A-12 (DOZERS) NH220		Hydraulic Oil Filter.....	H-5607
Hydraulic Oil Filter.....	H-56600	Air Filter Secondary.....	A-5610	Oil Filter Full Flow.....	O-5603
Hydraulic Oil Filter.....	H-5610	Air Filter Primary.....	A-5614	D80E-18 (DOZERS) NT-855	
Hydraulic Oil Filter.....	H-5606	Coolant Filter.....	WC-5707	D80E-12 (DOZERS) NH220-C1	
Oil Filter Full Flow.....	C-5701	Fuel Filter.....	FC-5720	Coolant Filter.....	WC-5707
Oil Filter Full Flow.....	C-5715	Fuel Filter.....	F-5601	Fuel Filter.....	F-5601
Oil Filter By Pass.....	O-5704	Fuel/Water Separator.....	SFC-5705	Hydraulic Oil Filter.....	H-5607
Oil Filter Full Flow.....	C-5605	Hydraulic Oil Filter.....	H-56600	Oil Filter Full Flow.....	O-5603
		Hydraulic Oil Filter.....	H-5610	D80E-18 (DOZERS) NT-855	
		Hydraulic Oil Filter.....	H-5606	D80E-12 (DOZERS) NH220-C1	
		Oil Filter Full Flow.....	C-5701	Coolant Filter.....	WC-5707
		Oil Filter Full Flow.....	C-5715	Fuel Filter.....	F-5601
		Oil Filter By Pass.....	O-5704	Hydraulic Oil Filter.....	H-5607
		Oil Filter Full Flow.....	C-5605	Oil Filter Full Flow.....	O-5603

MODEL/APPLICATION	SAKURA NO
KOMATSU	
D80E-18 (DOZERS) NT-855	
Air Filter Secondary.....	A-5610
Air Filter Primary.....	A-5614
Coolant Filter.....	WC-5711
Fuel Filter.....	FC-5602
Hydraulic Oil Filter.....	H-5610
Hydraulic Oil Filter.....	H-56600
Hydraulic Oil Filter.....	H-5606
Oil Filter Full Flow.....	C-5605
Oil Filter Full Flow.....	C-5701
Oil Filter Full Flow.....	C-5715
Oil Filter By Pass.....	O-5704
D80P (DOZERS) NT-855	
Air Filter Secondary.....	A-5610
Air Filter Primary.....	A-5614
Coolant Filter.....	WC-5707
Fuel Filter.....	FC-5720
Fuel Filter.....	F-5601
Fuel/Water Separator.....	SFC-5705
Hydraulic Oil Filter.....	H-5610
Hydraulic Oil Filter.....	H-56600
Hydraulic Oil Filter.....	H-5606
Oil Filter Full Flow.....	C-5701
Oil Filter Full Flow.....	C-5715
Oil Filter Full Flow.....	C-5605
Oil Filter By Pass.....	O-5704
D80P-12 (DOZERS) NTO-6-C1	
Air Filter Primary.....	A-6113
Air Filter Secondary.....	A-5408
Coolant Filter.....	WC-5707
Fuel Filter.....	F-5601
Hydraulic Oil Filter.....	H-5607
Hydraulic Oil Filter.....	H-5504
Hydraulic Oil Filter.....	H-55270
Oil Filter Full Flow.....	O-5603
Oil Filter By Pass.....	O-5704
D80P-18 (DOZERS) CUMMINS NT-855	
Fuel Filter.....	FC-5606
D82E (DOZERS) NT-855	
Air Filter Primary.....	A-5614
Air Filter Secondary.....	A-5610
Coolant Filter.....	WC-5707
Fuel Filter.....	F-5601
Fuel Filter.....	FC-5720
Fuel/Water Separator.....	SFC-5705
Hydraulic Oil Filter.....	H-5606
Hydraulic Oil Filter.....	H-5610
Hydraulic Oil Filter.....	H-56600
Oil Filter Full Flow.....	C-5605
Oil Filter By Pass.....	O-5704
Oil Filter Full Flow.....	C-5715
Oil Filter Full Flow.....	C-5701

MODEL/APPLICATION	SAKURA NO
KOMATSU	
D82E-18 (DOZERS) NT-855	
Air Filter Secondary.....	A-5610
Air Filter Primary.....	A-5614
Coolant Filter.....	WC-5711
Fuel Filter.....	FC-5602
Hydraulic Oil Filter.....	H-56600
Hydraulic Oil Filter.....	H-5610
Hydraulic Oil Filter.....	H-5606
Oil Filter Full Flow.....	C-5715
Oil Filter By Pass.....	O-5704
Oil Filter Full Flow.....	C-5701
Oil Filter Full Flow.....	C-5605
D83-1 (DOZERS) S/N: 1001	
Air Filter Secondary.....	A-5408
Fuel Filter.....	FC-5602
Hydraulic Oil Filter.....	H-5601
Hydraulic Oil Filter.....	H-5620
Oil Filter Full Flow.....	C-5715
Oil Filter Full Flow.....	C-5605
Oil Filter Full Flow.....	C-5701
D83E-1 (DOZERS) S6D125	
Fuel Filter.....	FC-5606
D83E-1 (DOZERS) S6D125-1/1001	
Air Filter Secondary.....	A-5408
Air Filter Primary.....	A-6113
Fuel Filter.....	FC-5602
Hydraulic Oil Filter.....	H-5601
Hydraulic Oil Filter.....	H-5620
Oil Filter Full Flow.....	C-5701
Oil Filter Full Flow.....	C-5715
Oil Filter Full Flow.....	C-5605
D83P-1 (DOZERS) S6D125	
Fuel Filter.....	FC-5606
D83P-1 (DOZERS) S6D125-1/1001	
Air Filter Secondary.....	A-5408
Air Filter Primary.....	A-6113
Fuel Filter.....	FC-5602
Hydraulic Oil Filter.....	H-5601
Hydraulic Oil Filter.....	H-5620
Oil Filter Full Flow.....	C-5605
Oil Filter Full Flow.....	C-5701
Oil Filter Full Flow.....	C-5715
Oil Filter Full Flow.....	C-5715
D85 (DOZERS) 148	
Fuel Filter.....	F-2622
Oil Filter Full Flow.....	C-1122
D85-18 (DOZERS) NT-855/25001	
Air Filter Secondary.....	A-5610
Air Filter Primary.....	A-5614
Fuel Filter.....	FC-5602

MODEL/APPLICATION	SAKURA NO
KOMATSU	
Hydraulic Oil Filter.....	H-5610
Hydraulic Oil Filter.....	H-5606
Hydraulic Oil Filter.....	H-56600
Oil Filter Full Flow.....	C-5715
Oil Filter Full Flow.....	C-5605
Oil Filter Full Flow.....	C-5701
Oil Filter By Pass.....	O-5704
D85-21 (DOZERS) 35001	
Air Filter Secondary.....	A-5408
Air Filter Primary.....	A-6113
Fuel Filter.....	FC-5602
Hydraulic Oil Filter.....	H-56600
Hydraulic Oil Filter.....	H-5610
Hydraulic Oil Filter.....	H-5606
Oil Filter Full Flow.....	C-5701
Oil Filter Full Flow.....	C-5605
Oil Filter Full Flow.....	C-5715
D85A (DOZERS) NT-855	
Air Filter Secondary.....	A-5610
Air Filter Primary.....	A-5614
Coolant Filter.....	WC-5707
Fuel Filter.....	F-5601
Fuel Filter.....	FC-5720
Fuel/Water Separator.....	SFC-5705
Hydraulic Oil Filter.....	H-5606
Hydraulic Oil Filter.....	H-5610
Hydraulic Oil Filter.....	H-56600
Oil Filter Full Flow.....	C-5715
Oil Filter By Pass.....	O-5704
Oil Filter Full Flow.....	C-5701
Oil Filter Full Flow.....	C-5605
D85A-12 (DOZERS) NH220C1	
Fuel Filter.....	F-5601
Hydraulic Oil Filter.....	H-5606
Hydraulic Oil Filter.....	H-5607
Oil Filter Full Flow.....	O-5603
D85A-18 (DOZERS) CUMMINS NT-855	
Fuel Filter.....	FC-5606
D85A-18 (DOZERS) NT-855/25001	
Air Filter Secondary.....	A-5610
Air Filter Primary.....	A-5614
Fuel Filter.....	F-5601
Fuel Filter.....	FC-5602
Hydraulic Oil Filter.....	H-5610
Hydraulic Oil Filter.....	H-56600
Hydraulic Oil Filter.....	H-5606
Oil Filter Full Flow.....	C-5605
Oil Filter Full Flow.....	C-5701
Oil Filter By Pass.....	O-5704
Oil Filter Full Flow.....	C-5715
D85A-21 (DOZERS) S6D125	
Fuel Filter.....	FC-5606

Sakura Filter

ENGINE APPLICATION

MODEL/APPLICATION	SAKURA NO	MODEL/APPLICATION	SAKURA NO	MODEL/APPLICATION	SAKURA NO
KOMATSU		KOMATSU		KOMATSU	
D85A-21 (DOZERS) S6D125/35001		D85E-21 (DOZERS) S6D125		D85P-18 (DOZERS) NT-855	
Air Filter Secondary.....	A-5408	Fuel Filter.....	FC-5606	Air Filter Secondary.....	A-5610
Air Filter Primary.....	A-6113			Air Filter Primary.....	A-5614
Fuel Filter.....	FC-5602	D85E-21 (DOZERS) S6D125/35001		Coolant Filter.....	WC-5707
Hydraulic Oil Filter.....	H-5606	Air Filter Secondary.....	A-5408	Fuel Filter.....	FC-5720
Hydraulic Oil Filter.....	H-56600	Air Filter Primary.....	A-6113	Fuel Filter.....	F-5601
Hydraulic Oil Filter.....	H-5610	Fuel Filter.....	FC-5602	Fuel/Water Separator.....	SFC-5705
Oil Filter Full Flow.....	C-5605	Hydraulic Oil Filter.....	H-5610	Hydraulic Oil Filter.....	H-56600
Oil Filter Full Flow.....	C-5701	Hydraulic Oil Filter.....	H-56600	Hydraulic Oil Filter.....	H-5610
Oil Filter Full Flow.....	C-5715	Hydraulic Oil Filter.....	H-5606	Hydraulic Oil Filter.....	H-5606
		Oil Filter Full Flow.....	C-5605	Oil Filter Full Flow.....	C-5715
D85B (DOZERS) 148		Oil Filter Full Flow.....	C-5701	Oil Filter By Pass.....	O-5704
Fuel Filter.....	F-2622	Oil Filter Full Flow.....	C-5715	Oil Filter Full Flow.....	C-5701
Oil Filter Full Flow.....	C-1122			Oil Filter Full Flow.....	C-5605
D85C-12 (DOZERS) NH220		D85E-SS-2A (DOZERS) S6D125		D85P-18 (DOZERS) NT-855/2001	
Coolant Filter.....	WC-5711	Air Filter Secondary.....	A-5408	Air Filter Primary.....	A-5614
Fuel Filter.....	F-5601	Air Filter Primary.....	A-6113	Air Filter Secondary.....	A-5610
Oil Filter Full Flow.....	O-5603	Fuel Filter.....	FC-5606	Fuel Filter.....	FC-5602
Oil Filter By Pass.....	O-5704	Fuel Filter.....	FC-5602	Fuel Filter.....	F-5601
		Hydraulic Oil Filter.....	H-5610	Hydraulic Oil Filter.....	H-56600
D85E (DOZERS) NT-855		Hydraulic Oil Filter.....	H-5607	Hydraulic Oil Filter.....	H-5610
Air Filter Secondary.....	A-5610	Hydraulic Oil Filter.....	H-56600	Hydraulic Oil Filter.....	H-5606
Air Filter Primary.....	A-5614	Oil Filter Full Flow.....	C-5605	Oil Filter Full Flow.....	C-5715
Coolant Filter.....	WC-5707	Oil Filter Full Flow.....	C-5715	Oil Filter Full Flow.....	C-5701
Fuel Filter.....	FC-5720	Oil Filter Full Flow.....	C-5701	Oil Filter By Pass.....	O-5704
Fuel Filter.....	F-5601			Oil Filter Full Flow.....	C-5605
Fuel/Water Separator.....	SFC-5705	D85E-SS-2A (DOZERS) S6D125E-2H-6		D85P-21 (DOZERS) S6D125	
Hydraulic Oil Filter.....	H-5610	Fuel Filter.....	FC-5606	Air Filter Secondary.....	A-5408
Hydraulic Oil Filter.....	H-56600			Air Filter Primary.....	A-6113
Hydraulic Oil Filter.....	H-5606	D85EX-15 (DOZERS) SA6D125E , 2004-2007		Fuel Filter.....	FC-5606
Oil Filter Full Flow.....	C-5715	Air Filter Primary.....	A-5558M	Fuel Filter.....	FC-5602
Oil Filter By Pass.....	O-5704	Air Filter Secondary.....	A-5559	Hydraulic Oil Filter.....	H-56600
Oil Filter Full Flow.....	C-5605	Air Filter Set.....	A-5558M-S	Hydraulic Oil Filter.....	H-5610
Oil Filter Full Flow.....	C-5701	Cabin Air Filter.....	CA-5602	Hydraulic Oil Filter.....	H-5606
		Cabin Air Filter.....	CA-56041	Oil Filter Full Flow.....	C-5715
D85E-12 (DOZERS) NH220C1		Hydraulic Oil Filter.....	H-5646	Oil Filter Full Flow.....	C-5605
Fuel Filter.....	F-5601	Hydraulic Oil Filter.....	H-5629	Oil Filter Full Flow.....	C-5701
Hydraulic Oil Filter.....	H-5607	D85EX-15SL (DOZERS) SA6D125E , 2004		D85P-21 (DOZERS) S6D125/3001	
Hydraulic Oil Filter.....	H-5606	Air Filter Primary.....	A-5558M	Air Filter Secondary.....	A-5408
Oil Filter Full Flow.....	O-5603	Air Filter Secondary.....	A-5559	Air Filter Primary.....	A-6113
		Air Filter Set.....	A-5558M-S	Fuel Filter.....	FC-5602
D85E-18 (DOZERS) CUMMINS NT-855		Cabin Air Filter.....	CA-56041	Hydraulic Oil Filter.....	H-5606
Fuel Filter.....	FC-5606	Cabin Air Filter.....	CA-5602	Hydraulic Oil Filter.....	H-56600
		Hydraulic Oil Filter.....	H-5646	Hydraulic Oil Filter.....	H-5610
D85E-18 (DOZERS) NT-855/25001		Hydraulic Oil Filter.....	H-5629	Oil Filter Full Flow.....	C-5605
Air Filter Secondary.....	A-5610	D85P-12 (DOZERS) NH220-C1		Oil Filter Full Flow.....	C-5701
Air Filter Primary.....	A-5614	Coolant Filter.....	WC-5707	Oil Filter Full Flow.....	C-5715
Fuel Filter.....	FC-5602	Fuel Filter.....	F-5601	D85PX (DOZERS)	
Fuel Filter.....	F-5601	Hydraulic Oil Filter.....	H-5607	Fuel Filter.....	FC-56300
Hydraulic Oil Filter.....	H-5606	Oil Filter Full Flow.....	O-5603	Fuel/Water Separator Secondary..	SFC-5611-10B
Hydraulic Oil Filter.....	H-5610	D85P-18 (DOZERS) CUMMINS NT-855		Fuel/Water Separator Secondary..	SFC-5611-10
Hydraulic Oil Filter.....	H-56600	Fuel Filter.....	FC-5606	Hydraulic Oil Filter.....	H-5610
Oil Filter By Pass.....	O-5704			Hydraulic Oil Filter.....	H-5646
Oil Filter Full Flow.....	C-5701			Hydraulic Oil Filter.....	H-5629
Oil Filter Full Flow.....	C-5715				
Oil Filter Full Flow.....	C-5605				

Sakura Filter

ENGINE APPLICATION

MODEL/APPLICATION	SAKURA NO	MODEL/APPLICATION	SAKURA NO	MODEL/APPLICATION	SAKURA NO
KOMATSU		KOMATSU		KOMATSU	
D85PX (DOZERS)		Fuel Filter.....	F-2626	Fuel Filter.....	FC-5704
Hydraulic Oil Filter.....	H-56600	Hydraulic Oil Filter.....	H-55270	Oil Filter Full Flow.....	C-6202
D85PX-15 (DOZERS)		Hydraulic Oil Filter.....	H-56600	DF100P (ASPHALT PAVER)	
SAG6D125E , 2004-2007		Hydraulic Oil Filter.....	H-5610	F4L912	
Air Filter Primary.....	A-5558M	Hydraulic Oil Filter.....	H-5504	Air Filter Secondary.....	A-6212
Air Filter Secondary.....	A-5559	Oil Filter Full Flow.....	O-5601	Air Filter Primary.....	A-6211
Air Filter Set.....	A-5558M-S	Oil Filter By Pass.....	O-5704	Fuel Filter.....	FC-5704
Cabin Air Filter.....	CA-56041	D955-2 (DOZERS)		Oil Filter Full Flow.....	C-6202
Cabin Air Filter.....	CA-5602	CUMMINS NT-855		DF10C (ASPHALT PAVER)	
Hydraulic Oil Filter.....	H-5629	Fuel Filter.....	FC-5606	F4L912	
Hydraulic Oil Filter.....	H-5646	D955-2 (DOZERS)		Fuel Filter.....	FC-5704
D85EX-15EO (DOZERS)		NT-855/2001		Oil Filter Full Flow.....	C-6202
SAA6D125E-5		Air Filter Secondary.....	A-5610	DF10P (ASPHALT PAVER)	
Air Filter Primary.....	A-5558M	Air Filter Primary.....	A-5614	F4L912	
Air Filter Secondary.....	A-5559	Fuel Filter.....	FC-5602	Fuel Filter.....	FC-5704
Air Filter Set.....	A-5558M-S	Hydraulic Oil Filter.....	H-5606	Oil Filter Full Flow.....	C-6202
Cabin Air Filter.....	CA-5602	Hydraulic Oil Filter.....	H-5610	DF110P (ASPHALT PAVER)	
Cabin Air Filter.....	CA-56041	Hydraulic Oil Filter.....	H-56600	F6L912	
Fuel/Water Separator Secondary..	SFC-5611-10B	Oil Filter Full Flow.....	C-5715	Air Filter Primary.....	A-6211
Fuel/Water Separator Secondary..	SFC-5611-10	Oil Filter Full Flow.....	C-5701	Air Filter Secondary.....	A-6212
Hydraulic Oil Filter.....	H-5646	Oil Filter By Pass.....	O-5704	Fuel Filter.....	FC-5704
Hydraulic Oil Filter.....	H-5629	Oil Filter Full Flow.....	C-5605	Oil Filter Full Flow.....	C-6204
D85EX-15R (DOZERS)		DA85A-12 (DOZERS)		DF120C (ASPHALT PAVER)	
SAG6D125E , 2004-2007		NH220		F6L912	
Air Filter Primary.....	A-5558M	Air Filter Primary.....	A-5623	Air Filter Secondary.....	A-6212
Air Filter Secondary.....	A-5559	Air Filter Set.....	A-5622-S	Air Filter Primary.....	A-6211
Air Filter Set.....	A-5558M-S	Air Filter Secondary.....	A-5624	Fuel Filter.....	FC-5704
Cabin Air Filter.....	CA-5602	Coolant Filter.....	WC-5711	Oil Filter Full Flow.....	C-6204
Cabin Air Filter.....	CA-56041	Fuel Filter.....	F-5601	DF12C (ASPHALT PAVER)	
Hydraulic Oil Filter.....	H-5646	Hydraulic Oil Filter.....	H-5607	F5L912	
Hydraulic Oil Filter.....	H-5629	Hydraulic Oil Filter.....	H-5504	Fuel Filter.....	FC-5704
D85E-SS-2 (DOZERS)		Hydraulic Oil Filter.....	H-55270	Oil Filter Full Flow.....	C-6204
S6D125E-2G-6		Oil Filter Full Flow.....	O-5603	DF12C (ASPHALT PAVER)	
Fuel Filter.....	FC-5606	Oil Filter By Pass.....	O-5704	F6L912	
D90 SERIES C (LOADERS)		DCC045 (DOZERS)		Fuel Filter.....	FC-5704
6V-53		Hydraulic Oil Filter.....	H-5608	Oil Filter Full Flow.....	C-6204
Air Filter.....	A-57240	DCC050 (DOZERS)		DF12P (ASPHALT PAVER)	
Fuel Filter.....	F-6505	Hydraulic Oil Filter.....	H-5608	F5L912	
Fuel Filter Secondary.....	F-6502	DCC060 (DOZERS)		Fuel Filter.....	FC-5704
Oil Filter Full Flow.....	O-6503	Hydraulic Oil Filter.....	H-5601	Oil Filter Full Flow.....	C-6204
D90 SERIES C (LOADERS)		DDM045 (DOZERS)		DF12P (ASPHALT PAVER)	
DT573		Hydraulic Oil Filter.....	H-5608	F6L912	
Air Filter.....	AS-5707	DDM060 (DOZERS)		Fuel Filter.....	FC-5704
Hydraulic Oil Filter Transmission...	H-65030	Hydraulic Oil Filter.....	H-5601	Oil Filter Full Flow.....	C-6204
D90 SERIES C (LOADERS)		DDR040 (DOZERS)		DF135C (ASPHALT PAVER)	
V6R-180		Hydraulic Oil Filter.....	H-5608	Air Filter Secondary.....	A-5106
Fuel Filter.....	FC-1303	DDM060 (DOZERS)		Air Filter Primary.....	A-5105
Fuel Filter.....	F-5701	Hydraulic Oil Filter.....	H-5601	DF15 (FORKLIFTS)	
Fuel Filter.....	FC-5720	Hydraulic Oil Filter.....	H-5608	Fuel Filter.....	FC-5704
Fuel/Water Separator.....	SFC-5705	DDR040 (DOZERS)		Oil Filter Full Flow.....	C-6204
Hydraulic Oil Filter Transmission...	H-65030	Hydraulic Oil Filter.....	H-5608	DF5C (ASPHALT PAVER)	
D955-1 (DOZERS)		DF100C (ASPHALT PAVER)		F2L912	
S4D155		F4L912		Fuel Filter.....	FC-6205
Air Filter Secondary.....	A-5408	Air Filter Secondary.....	A-6212		
Air Filter Primary.....	A-6113	Air Filter Primary.....	A-6211		
Coolant Filter.....	WC-5707				

MODEL/APPLICATION	SAKURA NO	MODEL/APPLICATION	SAKURA NO	MODEL/APPLICATION	SAKURA NO
KOMATSU		KOMATSU		KOMATSU	
DF8P (<i>ASPHALT PAVER</i>) F3L912		F135D (<i>DOZERS</i>)		FD135-4 (<i>FORKLIFTS</i>)	
Fuel Filter.....	FC-5704	Fuel Filter.....	FC-5103	Oil Filter Full Flow.....	C-5614
Oil Filter Full Flow.....	C-6202				
DX37EX-21A (<i>DOZERS</i>) KOMATSU SAA4D102E		F137D (<i>DOZERS</i>)		FD150E-7 (<i>FORKLIFTS</i>) S/N: 6089 & 6075 , 2005	
Air Filter Primary.....	A-56731	Fuel Filter.....	FC-5103	Fuel Filter.....	FC-1503
Air Filter Set.....	A-56731-S				
Air Filter Secondary.....	A-56741				
DX37EX-21A (<i>DOZERS</i>) SAA4D102E		F1500 (<i>MOTOR GRADERS</i>) 4-71		FD15T-20 (<i>FORKLIFTS</i>) 4D92E-08571	
Air Filter Set.....	A-5675-S	Fuel Filter.....	F-6505	Oil Filter Full Flow.....	C-1720
Air Filter Primary.....	A-5673	Fuel Filter Secondary.....	F-6502		
Air Filter Secondary.....	A-8670	Oil Filter Full Flow.....	0-6503		
Cabin Air Filter.....	CA-56041			FD20 (<i>FORKLIFTS</i>) C221	
Fuel Filter.....	F-5218	F1900 (<i>MOTOR GRADERS</i>) 6V-71		Oil Filter Full Flow.....	0-1803
		Fuel Filter.....	F-6503		
E200 (<i>MOTOR GRADERS</i>) DT361		Fuel Filter.....	F-7302	FD20 (<i>FORKLIFTS</i>) G150	
Fuel Filter.....	FC-1810	Oil Filter Full Flow.....	0-6503	Oil Filter Full Flow.....	0-1803
Fuel/Water Separator.....	SFC-5705				
E200 (<i>MOTOR GRADERS</i>) DT407		F240 (<i>DOZERS</i>)		FD20 (<i>FORKLIFTS</i>) G207	
Fuel Filter.....	FC-1810	Fuel Filter.....	FC-5103	Oil Filter Full Flow.....	0-1803
Fuel/Water Separator.....	SFC-5705				
E200 (<i>SCRAPERS</i>) DT414		F240D (<i>DOZERS</i>)		FD20 (<i>FORKLIFTS</i>) AS-5644-S	
Air Filter Primary.....	A-5413	Fuel Filter.....	FC-5103	Air Filter Primary.....	AS-5644
Air Filter Secondary.....	A-5414			Fuel Filter.....	FC-1802
Air Filter Set.....	A-5660-S	F265D (<i>DOZERS</i>)			
Fuel Filter.....	FC-7933	Fuel Filter.....	FC-5103	FD20-10 (<i>FORKLIFTS</i>) 4D95	
Fuel/Water Separator.....	SFC-5705			Air Filter.....	A-8568
E200 (<i>SCRAPERS</i>) DT466		F267D (<i>DOZERS</i>)		Air Filter Set.....	AS-5643-S
Air Filter Primary.....	A-5413	Fuel Filter.....	FC-5103	Air Filter Primary.....	AS-5643
Air Filter Secondary.....	A-5414				
Air Filter Set.....	A-5660-S	F270 (<i>DOZERS</i>)		FD20-5 (<i>FORKLIFTS</i>) C-175	
Fuel Filter.....	FC-7933	Fuel Filter.....	FC-5103	Oil Filter Full Flow.....	0-1901
Fuel/Water Separator.....	SFC-5705				
E211 (<i>SCRAPERS</i>) D407		F270D (<i>DOZERS</i>)		FD20-5 (<i>FORKLIFTS</i>) DL201	
Fuel/Water Separator.....	SFC-5705	Fuel Filter.....	FC-5103	Oil Filter Full Flow.....	0-1901
E-270 (<i>MOTOR GRADERS</i>) DVT-573		FC45 (<i>LOADERS</i>)		FD20L-10 (<i>FORKLIFTS</i>) 4D95	
Air Filter.....	A-5410	Air Filter Primary.....	AS-2205	Air Filter.....	A-8568
Fuel Filter.....	FC-1810	Fuel Filter.....	F-5210	Air Filter Primary.....	AS-5643
Fuel/Water Separator.....	SFC-5705			Air Filter Set.....	AS-5643-S
Hydraulic Oil Filter Transmission....	H-65030	FCD UTILITY (<i>TRACTORS</i>)		FD20S (<i>FORKLIFTS</i>)	
		Fuel Filter.....	F-2601	Air Filter Set.....	AS-5644-S
ET200 (<i>MOTOR GRADERS</i>) DT361		Fuel Filter.....	FC-5103	Air Filter Primary.....	AS-5644
Fuel Filter.....	FC-1810	FD10 (<i>FORKLIFTS</i>) 4D95		Fuel Filter.....	FC-1802
Fuel/Water Separator.....	SFC-5705	Air Filter.....	A-8568		
Hydraulic Oil Filter Transmission....	H-65030	Air Filter Set.....	AS-5643-S	FD20S-5 (<i>FORKLIFTS</i>) 4D95	
		Air Filter Primary.....	AS-5643	Air Filter.....	A-8568
ET200 (<i>MOTOR GRADERS</i>) DT407		FD100 (<i>FORKLIFTS</i>)		Air Filter Primary.....	AS-5643
Fuel Filter.....	FC-1810	Oil Filter Full Flow.....	C-5614	Air Filter Set.....	AS-5643-S
Fuel/Water Separator.....	SFC-5705				
ET200 (<i>MOTOR GRADERS</i>) DT407		FD115 (<i>FORKLIFTS</i>)		FD20SV (<i>FORKLIFTS</i>)	
Fuel Filter.....	FC-1810	Oil Filter Full Flow.....	C-5614	Air Filter Set.....	AS-5644-S
Fuel/Water Separator.....	SFC-5705			Air Filter Primary.....	AS-5644
				Fuel Filter.....	FC-1802

MODEL/APPLICATION	SAKURA NO	MODEL/APPLICATION	SAKURA NO	MODEL/APPLICATION	SAKURA NO
KOMATSU		KOMATSU		KOMATSU	
FD20SV-11 (<i>FORKLIFTS</i>)		FD25S-5 (<i>FORKLIFTS</i>)		FD25T-12 (<i>FORKLIFTS</i>) 2002	
Air Filter Set.....	AS-5644-S	Oil Filter Full Flow.....	C-5615	Air Filter Secondary.....	A-8599
Air Filter Primary.....	AS-5644	Oil Filter Full Flow.....	C-5616		
Fuel Filter.....	FC-1802			FD25T-16 (<i>FORKLIFTS</i>)	
		FD25S-5 ROADWAY (<i>FORKLIFTS</i>)		Air Filter Primary.....	A-8505
FD20V-11 (<i>FORKLIFTS</i>)		Air Filter.....	A-8568		
Air Filter Set.....	AS-5644-S	Air Filter Primary.....	AS-5643	FD25T-16R (<i>FORKLIFTS</i>) 4D94LE , 2007	
Air Filter Primary.....	AS-5644	Air Filter Set.....	AS-5643-S	Fuel Filter.....	FC-5604
Fuel Filter.....	FC-1802	Fuel Filter.....	FC-1802	Oil Filter Full Flow.....	C-5606
		FD25T-5 CONSOLIDATED (<i>FORKLIFTS</i>)		FD20-11 (<i>FORKLIFTS</i>) KOMATSU-4D94LE	
FD23-10 (<i>FORKLIFTS</i>) 4D95		Air Filter Set.....	AS-5643-S	Hydraulic Oil Filter.....	H-5632
Air Filter.....	A-8568	Air Filter.....	A-8568		
Air Filter Primary.....	AS-5643	Air Filter Primary.....	AS-5643	FD30 (<i>FORKLIFTS</i>) C221	
Air Filter Set.....	AS-5643-S	Fuel Filter.....	FC-1802	Oil Filter Full Flow.....	O-1803
		FD25SV (<i>FORKLIFTS</i>)			
FD25 (<i>FORKLIFTS</i>) C221		Air Filter Set.....	AS-5644-S	FD30 (<i>FORKLIFTS</i>) G150	
Oil Filter Full Flow.....	O-1803	Air Filter Primary.....	AS-5644	Oil Filter Full Flow.....	O-1803
		Fuel Filter.....	FC-1802		
FD25 (<i>FORKLIFTS</i>) G150		FD25V (<i>FORKLIFTS</i>)		FD30 (<i>FORKLIFTS</i>) G207	
Oil Filter Full Flow.....	O-1803	Air Filter Set.....	AS-5644-S	Oil Filter Full Flow.....	O-1803
		Air Filter Primary.....	AS-5644		
FD25 (<i>FORKLIFTS</i>) G207		Fuel Filter.....	FC-1802	FD30 (<i>FORKLIFTS</i>) ISUZU DA640	
Oil Filter Full Flow.....	O-1803	FD25V-11 (<i>FORKLIFTS</i>)		Air Filter.....	A-6003
		Air Filter Set.....	AS-5644-S		
FD25 (<i>FORKLIFTS</i>) G207		Air Filter Primary.....	AS-5644	FD30-10 (<i>FORKLIFTS</i>) 4D95	
Air Filter Set.....	AS-5644-S	Fuel Filter.....	FC-1802	Air Filter.....	A-8568
Air Filter Primary.....	AS-5644			Air Filter Primary.....	AS-5643
Fuel Filter.....	FC-1802	FD28-10 (<i>FORKLIFTS</i>) 4D95		Air Filter Set.....	AS-5643-S
		Air Filter.....	A-8568		
FD25-1 (<i>FORKLIFTS</i>) C-175		Air Filter Primary.....	AS-5643	FD30-11 (<i>FORKLIFTS</i>) KOMATSU-4D94LE	
Oil Filter Full Flow.....	O-1901	Air Filter Set.....	AS-5643-S	Hydraulic Oil Filter.....	H-5632
FD25-1 (<i>FORKLIFTS</i>) DL201		FD25-14 (<i>FORKLIFTS</i>) 4D94LE		FD30-11 (<i>FORKLIFTS</i>)	
Oil Filter Full Flow.....	O-1901	Air Filter Primary.....	A-8505	Air Filter Set.....	AS-5644-S
				Air Filter Primary.....	AS-5644
FD25-10 (<i>FORKLIFTS</i>) 4D95		FD25-17 (<i>FORKLIFTS</i>) 4D94LE		Fuel Filter.....	FC-1802
Air Filter.....	A-8568	Air Filter Primary.....	A-8505		
Air Filter Primary.....	AS-5643	FD20-16 (<i>FORKLIFTS</i>) 4D94LE		FD305-5 (<i>FORKLIFTS</i>) 4D95	
Air Filter Set.....	AS-5643-S	Air Filter Primary.....	A-8505	Air Filter.....	A-8568
				Air Filter Primary.....	AS-5643
FD25L-10 (<i>FORKLIFTS</i>) 4D95		FD20-17 (<i>FORKLIFTS</i>) 4D94LE		Air Filter Set.....	AS-5643-S
Air Filter.....	A-8568	Air Filter Primary.....	A-8505		
Air Filter Primary.....	AS-5643	FD20T-16R (<i>FORKLIFTS</i>) 4D94LE , 2007		FD30H-11 (<i>FORKLIFTS</i>)	
Air Filter Set.....	AS-5643-S	Fuel Filter.....	FC-5604	Air Filter Set.....	AS-5644-S
		Oil Filter Full Flow.....	C-5606	Air Filter Primary.....	AS-5644
FD25S (<i>FORKLIFTS</i>)				Fuel Filter.....	FC-1802
Air Filter Set.....	AS-5644-S	FD25-16 (<i>FORKLIFTS</i>) 4D94LE			
Air Filter Primary.....	AS-5644	Air Filter Primary.....	A-8505	FD30J-12 (<i>FORKLIFTS</i>) C240	
Fuel Filter.....	FC-1802			Fuel Filter.....	FC-1006
		FD25-16 (<i>FORKLIFTS</i>) 4D94LE			
FD25S-5 (<i>FORKLIFTS</i>) 4D95		Air Filter Primary.....	A-8505	FD30S-11 (<i>FORKLIFTS</i>)	
Air Filter.....	A-8568			Air Filter Set.....	AS-5644-S
Air Filter Primary.....	AS-5643			Air Filter Primary.....	AS-5644
Air Filter Set.....	AS-5643-S				

Sakura Filter

ENGINE APPLICATION

MODEL/APPLICATION	SAKURA NO	MODEL/APPLICATION	SAKURA NO	MODEL/APPLICATION	SAKURA NO
KOMATSU		KOMATSU		KOMATSU	
FD30S-11 (<i>FORKLIFTS</i>)		FD40-4 (<i>FORKLIFTS</i>)		Oil Filter Full Flow.....	C-1122
Fuel Filter.....	FC-1802	Oil Filter Full Flow.....	C-5615	FG15 (<i>FORKLIFTS</i>)	
FD30SV-11 (<i>FORKLIFTS</i>)		Oil Filter Full Flow.....	C-5616	D11	
Air Filter Set.....	AS-5644-S	FD70H (<i>FORKLIFTS</i>)		Air Filter Primary.....	AS-2205
Air Filter Primary.....	AS-5644	Air Filter Primary.....	AS-5620	Oil Filter Full Flow.....	C-1829
Fuel Filter.....	FC-1802	Fuel Filter.....	FC-1802	FG15 (<i>FORKLIFTS</i>)	
FD30V-11 (<i>FORKLIFTS</i>)		Hydraulic Oil Filter.....	HC-7901	G150	
Air Filter Set.....	AS-5644-S	FG10 (<i>FORKLIFTS</i>)		Oil Filter Full Flow.....	O-1803
Air Filter Primary.....	AS-5644	4P		FG15 (<i>FORKLIFTS</i>)	
Fuel Filter.....	FC-1802	Air Filter.....	A-1004	G207	
FD33 (<i>FORKLIFTS</i>)		Air Filter.....	AS-5412	Oil Filter Full Flow.....	O-1803
6D95L		Oil Filter Full Flow.....	C-1122	FG15 (<i>FORKLIFTS</i>)	
Hydraulic Oil Filter.....	HC-7901	FG10 (<i>FORKLIFTS</i>)		J15	
FD35 (<i>FORKLIFTS</i>)		D11		Air Filter Primary.....	AS-2205
6D95L		Air Filter Primary.....	AS-2205	Oil Filter Full Flow.....	C-1829
Hydraulic Oil Filter.....	HC-7901	Oil Filter Full Flow.....	C-1829	FG18 (<i>FORKLIFTS</i>)	
FD35N (<i>FORKLIFTS</i>)		FG10 (<i>FORKLIFTS</i>)		4P	
6D95L		DPU 40DA		Air Filter.....	AS-5412
Hydraulic Oil Filter.....	HC-7901	Oil Filter Full Flow.....	O-1901	Air Filter.....	A-1004
FD30-14 (<i>FORKLIFTS</i>)		FG10 (<i>FORKLIFTS</i>)		Oil Filter Full Flow.....	C-1122
4D94LE		J15		FG18-4 (<i>FORKLIFTS</i>)	
Air Filter Primary.....	A-8505	Air Filter Primary.....	AS-2205	4P	
FD30-16 (<i>FORKLIFTS</i>)		Oil Filter Full Flow.....	C-1829	Air Filter.....	A-1004
4D94LE		FG10-8 (<i>FORKLIFTS</i>)		Oil Filter Full Flow.....	C-1122
Air Filter Primary.....	A-8505	DPU 40DA		FG18D (<i>FORKLIFTS</i>)	
FD30-17 (<i>FORKLIFTS</i>)		Oil Filter Full Flow.....	O-1901	4P	
4D94LE		FG10ST-15 (<i>FORKLIFTS</i>)		Air Filter.....	AS-5412
Air Filter Primary.....	A-8505	Air Filter Primary.....	AS-2205	Air Filter.....	A-1004
FD30T-14 (<i>FORKLIFTS</i>)		Oil Filter Full Flow.....	C-1829	Oil Filter Full Flow.....	C-1122
4D94E		FG14 (<i>FORKLIFTS</i>)		FG18L (<i>FORKLIFTS</i>)	
Fuel Filter.....	FC-5604	4P		4P	
Oil Filter Full Flow.....	C-5606	Air Filter.....	A-1004	Air Filter.....	AS-5412
FD30T-16R (<i>FORKLIFTS</i>)		Air Filter.....	AS-5412	Oil Filter Full Flow.....	C-1122
4D94LE , 2007		Oil Filter Full Flow.....	C-1122	FG10 FG SERIES (<i>FORKLIFTS</i>)	
Fuel Filter.....	FC-5604	FG14 (<i>FORKLIFTS</i>)		NISSAN J15	
Oil Filter Full Flow.....	C-5606	D11		Oil Filter Full Flow.....	C-1140
FD40 (<i>FORKLIFTS</i>)		Air Filter Primary.....	AS-2205	FG20 (<i>FORKLIFTS</i>)	
6D95L		Oil Filter Full Flow.....	C-1829	D11	
Hydraulic Oil Filter.....	HC-7901	FG14 (<i>FORKLIFTS</i>)		Air Filter Primary.....	AS-2205
FD40Z (<i>FORKLIFTS</i>)		DPU 40DU		Oil Filter Full Flow.....	C-1829
6D95L		Oil Filter Full Flow.....	O-1901	FG20 (<i>FORKLIFTS</i>)	
Hydraulic Oil Filter.....	HC-7901	FG14 (<i>FORKLIFTS</i>)		H20	
FD45 (<i>FORKLIFTS</i>)		J15		Air Filter Primary.....	AS-2205
6D95L		Air Filter Primary.....	AS-2205	Oil Filter Full Flow.....	C-1829
Hydraulic Oil Filter.....	HC-7901	Oil Filter Full Flow.....	C-1829	FG20 (<i>FORKLIFTS</i>)	
FD45H (<i>FORKLIFTS</i>)		FG14-6 (<i>FORKLIFTS</i>)		H20 (Z SERIES)	
6D95L		DPU 40DU		Air Filter Secondary.....	A-7919
Hydraulic Oil Filter.....	HC-7901	Oil Filter Full Flow.....	O-1901	Air Filter Set.....	AS-5644-S
FD45S (<i>FORKLIFTS</i>)		FG15 (<i>FORKLIFTS</i>)		Air Filter Primary.....	AS-5644
6D95L		4P		FG20 (<i>FORKLIFTS</i>)	
Hydraulic Oil Filter.....	HC-7901	Air Filter.....	A-1004	J15	
		Air Filter.....	AS-5412	Air Filter Primary.....	AS-2205
				Oil Filter Full Flow.....	C-1829

MODEL/APPLICATION	SAKURA NO	MODEL/APPLICATION	SAKURA NO	MODEL/APPLICATION	SAKURA NO
KOMATSU		KOMATSU		KOMATSU	
FG20 (<i>FORKLIFTS</i>)		FG25 (<i>FORKLIFTS</i>) H20 (Z SERIES)		Oil Filter Full Flow.....	C-1829
Air Filter Set.....	AS-5644-S	Air Filter Set.....	AS-5644-S	FG30S (<i>FORKLIFTS</i>) H20	
Air Filter Primary.....	AS-5644	Air Filter Primary.....	AS-5644	Air Filter Primary.....	AS-2205
Fuel Filter.....	FC-1802	Air Filter Secondary.....	A-7919	Oil Filter Full Flow.....	C-1829
FG20 (<i>FORKLIFTS</i>) NISSAN GS		FG25 (<i>FORKLIFTS</i>) J15		FG30S-11 (<i>FORKLIFTS</i>)	
Oil Filter Full Flow.....	0-1901	Air Filter Primary.....	AS-2205	Air Filter Primary.....	AS-5644
FG20-4 (<i>FORKLIFTS</i>) NISSAN GS		Oil Filter Full Flow.....	C-1829	Air Filter Set.....	AS-5644-S
Oil Filter Full Flow.....	0-1901	FG25 (<i>FORKLIFTS</i>)		Fuel Filter.....	FC-1802
FG20-5 (<i>FORKLIFTS</i>) G201		Air Filter Set.....	AS-5644-S	FG30SHT (<i>FORKLIFTS</i>)	
Oil Filter Full Flow.....	0-1803	Air Filter Primary.....	AS-5644	Air Filter Primary.....	AS-2205
FG20-58 (<i>FORKLIFTS</i>) G201		Fuel Filter.....	FC-1802	Oil Filter Full Flow.....	C-1829
Oil Filter Full Flow.....	0-1803	FG25-1 (<i>FORKLIFTS</i>) G201		FG33 (<i>FORKLIFTS</i>) P40	
FG20S (<i>FORKLIFTS</i>) C-175		Oil Filter Full Flow.....	0-1803	Air Filter Primary.....	AS-1014
Oil Filter Full Flow.....	0-1901	FG25L (<i>FORKLIFTS</i>) J15		Hydraulic Oil Filter.....	HC-7901
FG20S (<i>FORKLIFTS</i>) DL201		Air Filter Primary.....	AS-2205	Oil Filter Full Flow.....	C-1803
Oil Filter Full Flow.....	0-1901	FG25S (<i>FORKLIFTS</i>)		Oil Filter Full Flow.....	C-1834
FG20S (<i>FORKLIFTS</i>) G201		Air Filter Set.....	AS-5644-S	FG33N (<i>FORKLIFTS</i>) P40	
Oil Filter Full Flow.....	0-1803	Air Filter Primary.....	AS-5644	Air Filter Primary.....	AS-1014
FG20S (<i>FORKLIFTS</i>)		Fuel Filter.....	FC-1802	Hydraulic Oil Filter.....	HC-7901
Oil Filter Full Flow.....	0-1803	FG25T-12 (<i>FORKLIFTS</i>) 37Z-02-0F201L		Oil Filter Full Flow.....	C-1834
FG20ST-04 (<i>FORKLIFTS</i>)		Air Filter Primary.....	AS-2205	Oil Filter Full Flow.....	C-1803
Air Filter Primary.....	AS-2205	Hydraulic Oil Filter Transmission...	HC-1119	Oil Filter Full Flow.....	C-1834
Oil Filter Full Flow.....	C-1829	FG28 (<i>FORKLIFTS</i>) H20		FG35 (<i>FORKLIFTS</i>) P40	
FG23 (<i>FORKLIFTS</i>) H20		Air Filter Primary.....	AS-2205	Air Filter Primary.....	AS-1014
Air Filter Primary.....	AS-2205	Oil Filter Full Flow.....	C-1829	Hydraulic Oil Filter.....	HC-7901
Oil Filter Full Flow.....	C-1829	FG30 (<i>FORKLIFTS</i>) H20		Oil Filter Full Flow.....	C-1803
FG25 (<i>FORKLIFTS</i>) D11		Air Filter Primary.....	AS-2205	Oil Filter Full Flow.....	C-1834
Air Filter Primary.....	AS-2205	Oil Filter Full Flow.....	C-1829	FG40 (<i>FORKLIFTS</i>) P40	
Oil Filter Full Flow.....	C-1829	FG30 (<i>FORKLIFTS</i>) H20 (Z SERIES)		Air Filter Primary.....	AS-1014
FG25 (<i>FORKLIFTS</i>) G150		Air Filter Secondary.....	A-7919	Hydraulic Oil Filter.....	HC-7901
Oil Filter Full Flow.....	0-1803	Air Filter Set.....	AS-5644-S	Oil Filter Full Flow.....	C-1834
FG25 (<i>FORKLIFTS</i>) G207		Air Filter Primary.....	AS-5644	Oil Filter Full Flow.....	C-1803
Oil Filter Full Flow.....	0-1803	FG30-11 (<i>FORKLIFTS</i>) H20 (Z SERIES)		FG40Z (<i>FORKLIFTS</i>) P40	
FG25 (<i>FORKLIFTS</i>) H20		Air Filter Secondary.....	A-7919	Air Filter Primary.....	AS-1014
Air Filter Primary.....	AS-2205	Air Filter Set.....	AS-5644-S	Hydraulic Oil Filter.....	HC-7901
Oil Filter Full Flow.....	C-1829	Air Filter Primary.....	AS-5644	Oil Filter Full Flow.....	C-1834
FG25 (<i>FORKLIFTS</i>) G207		FG30-11 (<i>FORKLIFTS</i>)		Oil Filter Full Flow.....	C-1803
Oil Filter Full Flow.....	0-1803	Air Filter Set.....	AS-5644-S	FG45 (<i>FORKLIFTS</i>) P40	
FG25 (<i>FORKLIFTS</i>) H20		Air Filter Primary.....	AS-5644	Air Filter Primary.....	AS-1014
Air Filter Primary.....	AS-2205	Fuel Filter.....	FC-1802	Hydraulic Oil Filter.....	HC-7901
Oil Filter Full Flow.....	C-1829	FG30-4 (<i>FORKLIFTS</i>) H20		Oil Filter Full Flow.....	C-1834
FG25 (<i>FORKLIFTS</i>) H20		Air Filter Primary.....	AS-2205	Oil Filter Full Flow.....	C-1834
Air Filter Primary.....	AS-2205				

MODEL/APPLICATION	SAKURA NO	MODEL/APPLICATION	SAKURA NO	MODEL/APPLICATION	SAKURA NO
KOMATSU		KOMATSU		KOMATSU	
FG455 <i>(FORKLIFTS)</i> P40		GD28AC-1 <i>(MOTOR GRADERS)</i> 4D105-1		Air Filter Set.....	A-5604-S
Air Filter Primary.....	AS-1014	Air Filter Set.....	A-5655-S	Fuel Filter.....	F-2626
Hydraulic Oil Filter.....	HC-7901	Air Filter Primary.....	A-5616	Hydraulic Oil Filter.....	H-5608
Oil Filter Full Flow.....	C-1803	Air Filter Secondary.....	A-5617	Oil Filter Full Flow.....	O-5601
Oil Filter Full Flow.....	C-1834	Fuel Filter.....	FC-5605		
FU135D <i>(DOZERS)</i>		Hydraulic Oil Filter.....	H-5611	GD37-6H <i>(MOTOR GRADERS)</i> NH220	
Fuel Filter.....	FC-5103	Oil Filter Full Flow.....	C-5606	Air Filter Primary.....	A-5637
FU237D <i>(DOZERS)</i>		Oil Filter Full Flow.....	C-6202	Air Filter Primary.....	A-5636
Fuel Filter.....	FC-5103			Coolant Filter.....	WC-5711
FUD136 <i>(DOZERS)</i>		GD300A-1 <i>(MOTOR GRADERS)</i> 4D150-5/2001		Fuel Filter.....	F-5601
Fuel Filter.....	FC-5103	Air Filter Primary.....	AS-7805	Hydraulic Oil Filter.....	H-5608
FUD136M <i>(DOZERS)</i>		Air Filter Secondary.....	A-7806	Oil Filter Full Flow.....	O-5603
Fuel Filter.....	FC-5103	Fuel Filter.....	FC-5604	Oil Filter By Pass.....	O-5704
FV267D <i>(DOZERS)</i>		Hydraulic Oil Filter.....	H-5611		
Fuel Filter.....	FC-5103	Oil Filter Full Flow.....	C-5614	GD40-2 <i>(MOTOR GRADERS)</i> NH220	
FVV237D <i>(DOZERS)</i>				Air Filter Primary.....	A-5623
Fuel Filter.....	FC-5103	GD305A-1A <i>(MOTOR GRADERS)</i> 6D95L-1/6734		Air Filter Set.....	A-5622-S
FVV240 <i>(DOZERS)</i>		Air Filter Primary.....	AS-7805	Air Filter Secondary.....	A-5624
Fuel Filter.....	FC-5103	Air Filter Secondary.....	A-7806	Coolant Filter.....	WC-5711
FVV267D <i>(DOZERS)</i>		Fuel Filter.....	FC-5604	Fuel Filter.....	F-5601
Fuel Filter.....	FC-5103			Hydraulic Oil Filter.....	H-5611
FVV270 <i>(DOZERS)</i>		GD30-5M <i>(MOTOR GRADERS)</i> 4D105-5		Oil Filter Full Flow.....	O-5603
Fuel Filter.....	FC-5103	Air Filter Set.....	A-5657-S	Oil Filter By Pass.....	O-5704
GD200A-1 <i>(MOTOR GRADERS)</i> 4D150-5/2001		Air Filter Primary.....	A-5649		
Air Filter Primary.....	AS-7805	Fuel Filter.....	F-2626	GD405A-1 <i>(MOTOR GRADERS)</i> 6D105-1/50002	
Air Filter Secondary.....	A-7806	Oil Filter Full Flow.....	O-5601	Air Filter Secondary.....	A-6009
Fuel Filter.....	FC-5604			Air Filter Primary.....	AS-1024
Hydraulic Oil Filter.....	H-5611	GD313A-1 <i>(MOTOR GRADERS)</i> 6D95L		Air Filter Set.....	AS-1024-S
Oil Filter Full Flow.....	C-5614	Oil Filter Full Flow.....	C-5615	Hydraulic Oil Filter.....	H-5608
GD22-1 <i>(MOTOR GRADERS)</i> 4D92		Oil Filter Full Flow.....	C-5616	Hydraulic Oil Filter.....	H-5620
Air Filter Primary.....	A-5616			Oil Filter Full Flow.....	C-5614
Air Filter Set.....	A-5655-S	GD313A-1 <i>(MOTOR GRADERS)</i> 6D95L-1/30001			
Air Filter Secondary.....	A-5617	Air Filter Primary.....	AS-7805	GD461A-1 <i>(MOTOR GRADERS)</i> S6D95L	
Hydraulic Oil Filter.....	H-5611	Air Filter Secondary.....	A-7806	Oil Filter Full Flow.....	C-5616
GD22AC-1 <i>(MOTOR GRADERS)</i> 4D105-1		Fuel Filter.....	FC-5604	Oil Filter Full Flow.....	C-5615
Air Filter Primary.....	A-5616	Hydraulic Oil Filter.....	H-5625		
Air Filter Set.....	A-5655-S	Oil Filter Full Flow.....	C-5604	GD461A-1 <i>(MOTOR GRADERS)</i> S6D95L-1/10001	
Air Filter Secondary.....	A-5617			Air Filter Primary.....	A-5639
Fuel Filter.....	FC-5605	GD31-3H <i>(MOTOR GRADERS)</i> S4D120		Air Filter Secondary.....	A-5635
Hydraulic Oil Filter.....	H-5611	Air Filter Set.....	A-5604-S	Fuel Filter.....	FC-5604
Oil Filter Full Flow.....	C-6202	Air Filter Primary.....	A-5605	Hydraulic Oil Filter.....	H-5620
Oil Filter Full Flow.....	C-5606	Air Filter Secondary.....	A-5606	Hydraulic Oil Filter.....	H-5625
		Fuel Filter.....	F-2626	Oil Filter Full Flow.....	C-5604
		Hydraulic Oil Filter.....	H-5608		
		Oil Filter Full Flow.....	O-5601	GD500R-1 <i>(MOTOR GRADERS)</i> S4D130-1/10001	
				Air Filter Secondary.....	A-5606
		GD31RC-3A <i>(MOTOR GRADERS)</i> 4D130		Air Filter Primary.....	A-5605
		Air Filter Primary.....	A-5602	Air Filter Set.....	A-5604-S
		Air Filter Secondary.....	A-5603	Fuel Filter.....	F-2626
		Coolant Filter.....	WC-5707	Hydraulic Oil Filter.....	H-5608
		Fuel Filter.....	F-2626	Oil Filter By Pass.....	O-5704
		Hydraulic Oil Filter.....	H-5608	Oil Filter Full Flow.....	O-5601
		GD37-5H <i>(MOTOR GRADERS)</i> S4D120		GD500R-1 <i>(MOTOR GRADERS)</i> SYD130-1	
		Air Filter Secondary.....	A-5606	Air Filter Secondary.....	A-5606
		Air Filter Primary.....	A-5605	Air Filter Primary.....	A-5605
				Air Filter Set.....	A-5604-S
				Coolant Filter.....	WC-5707

MODEL/APPLICATION	SAKURA NO	MODEL/APPLICATION	SAKURA NO	MODEL/APPLICATION	SAKURA NO
KOMATSU		KOMATSU		KOMATSU	
GD500R-1 (MOTOR GRADERS) SYD130-1		GD510R-1 (MOTOR GRADERS) S/N: 15001		Air Filter Primary.....	A-5605
Fuel Filter.....	F-2626	Air Filter Secondary.....	A-5635	Air Filter Secondary.....	A-5606
Hydraulic Oil Filter.....	H-5608	Air Filter Primary.....	A-5639	Air Filter Set.....	A-5604-S
Oil Filter By Pass.....	O-5704	Fuel Filter.....	FC-5604	Hydraulic Oil Filter.....	H-5607
Oil Filter Full Flow.....	O-5601	Hydraulic Oil Filter.....	H-5607	Oil Filter Full Flow.....	C-5614
		Oil Filter Full Flow.....	C-5604		
GD500R-2 (MOTOR GRADERS) NH220		GD510R-2 (MOTOR GRADERS) S6D95L		GD521R-1 (MOTOR GRADERS) S6D105-1/10001	
Air Filter Set.....	A-5604-S	Oil Filter Full Flow.....	C-5615	Air Filter Secondary.....	A-5606
Air Filter Primary.....	A-5605	Oil Filter Full Flow.....	C-5616	Air Filter Set.....	A-5604-S
Air Filter Secondary.....	A-5606			Air Filter Primary.....	A-5605
Coolant Filter.....	WC-5711			Hydraulic Oil Filter.....	H-5607
Hydraulic Oil Filter.....	H-5608	GD510R-2 (MOTOR GRADERS) S6D95L-1/15001		Oil Filter Full Flow.....	C-5614
Oil Filter Full Flow.....	O-5603	Air Filter Secondary.....	A-5635		
Oil Filter By Pass.....	O-5704	Air Filter Primary.....	A-5639	GD523A-1 (MOTOR GRADERS)	
		Fuel Filter.....	FC-5604	Air Filter Primary.....	A-5605
GD500R-2 (MOTOR GRADERS) S6D105-1/11002		Hydraulic Oil Filter.....	H-5607	Air Filter Set.....	A-5604-S
Air Filter Set.....	A-5604-S	Oil Filter Full Flow.....	C-5604	Air Filter Secondary.....	A-5606
Air Filter Primary.....	A-5605			Hydraulic Oil Filter.....	H-5620
Air Filter Secondary.....	A-5606	GD511A-1 (MOTOR GRADERS) S6D95L-1/10001		Hydraulic Oil Filter.....	H-5607
Coolant Filter.....	WC-5712	Air Filter Primary.....	A-5639	Oil Filter Full Flow.....	C-5614
Hydraulic Oil Filter.....	H-5608	Air Filter Secondary.....	A-5635		
Oil Filter Full Flow.....	C-5614	Fuel Filter.....	FC-5604	GD523A-1 (MOTOR GRADERS) S6D105-1/30001	
		Hydraulic Oil Filter.....	H-5607	Air Filter Secondary.....	A-5606
GD500R-5 (MOTOR GRADERS) S/N: 11002		Oil Filter Full Flow.....	C-5604	Air Filter Primary.....	A-5605
Air Filter Set.....	A-5604-S			Air Filter Set.....	A-5604-S
Air Filter Primary.....	A-5605	GD511R-1 (MOTOR GRADERS) S6D95L-1/10001		Hydraulic Oil Filter.....	H-5607
Air Filter Secondary.....	A-5606	Air Filter Secondary.....	A-5635	Oil Filter Full Flow.....	C-5614
Hydraulic Oil Filter.....	H-5620	Air Filter Primary.....	A-5639		
Hydraulic Oil Filter.....	H-5608	Fuel Filter.....	FC-5604	GD523R-1 (MOTOR GRADERS) S6D105-1/30001	
Oil Filter Full Flow.....	C-5614	Hydraulic Oil Filter.....	H-5607	Air Filter Secondary.....	A-5606
		Oil Filter Full Flow.....	C-5604	Air Filter Primary.....	A-5605
GD505A-2 (MOTOR GRADERS) S6D105-1/50002				Air Filter Set.....	A-5604-S
Air Filter Set.....	A-5604-S	GD513A-1 (MOTOR GRADERS)		Hydraulic Oil Filter.....	H-5607
Air Filter Secondary.....	A-5606	Air Filter Secondary.....	A-5635	Oil Filter Full Flow.....	C-5614
Air Filter Primary.....	A-5605	Air Filter Primary.....	A-5639		
Coolant Filter.....	WC-5712	Fuel Filter.....	FC-5604	GD525A-1 (MOTOR GRADERS) S6D105-1/50001	
Hydraulic Oil Filter.....	H-5620	Hydraulic Oil Filter.....	H-5607	Air Filter Primary.....	A-5605
Hydraulic Oil Filter.....	H-5608	Hydraulic Oil Filter.....	H-5620	Air Filter Set.....	A-5604-S
Oil Filter Full Flow.....	C-5614	Oil Filter Full Flow.....	C-5604	Air Filter Secondary.....	A-5606
				Hydraulic Oil Filter.....	H-5607
GD505R-2 (MOTOR GRADERS) S6D105-1				Oil Filter Full Flow.....	C-5614
Air Filter Set.....	A-5604-S	GD515A-1 (MOTOR GRADERS)			
Air Filter Primary.....	A-5605	Air Filter Secondary.....	A-5635	GD525A-1 (MOTOR GRADERS) S/N: 50001	
Air Filter Secondary.....	A-5606	Air Filter Primary.....	A-5639	Air Filter Primary.....	A-5605
Coolant Filter.....	WC-5707	Hydraulic Oil Filter.....	H-5607	Air Filter Set.....	A-5604-S
Hydraulic Oil Filter.....	H-5608	Hydraulic Oil Filter.....	H-5620	Air Filter Secondary.....	A-5606
Hydraulic Oil Filter.....	H-5620	Oil Filter Full Flow.....	C-5608	Hydraulic Oil Filter.....	H-5620
Oil Filter Full Flow.....	C-5614			Hydraulic Oil Filter.....	H-5607
		GD521A-1 (MOTOR GRADERS)		Oil Filter Full Flow.....	C-5614
GD505R-2 (MOTOR GRADERS) S6D105-1/30002		Air Filter Set.....	A-5604-S		
Air Filter Set.....	A-5604-S	Air Filter Primary.....	A-5605	GD530 (MOTOR GRADERS)	
Air Filter Primary.....	A-5605	Air Filter Secondary.....	A-5606	Fuel Filter Secondary.....	FC-7903
Air Filter Secondary.....	A-5606	Hydraulic Oil Filter.....	H-5607	Fuel/Water Separator.....	SFC-5706
Coolant Filter.....	WC-5712	Hydraulic Oil Filter.....	H-5620	Fuel/Water Separator.....	SFC-5708
Hydraulic Oil Filter.....	H-5608	Oil Filter Full Flow.....	C-5614	Hydraulic Oil Filter.....	HC-76080
Hydraulic Oil Filter.....	H-5620			Oil Filter Full Flow.....	C-5730
Oil Filter Full Flow.....	C-5614	GD521A-1 (MOTOR GRADERS) S6D105-1/10001			
				GD530-2A (MOTOR GRADERS)	

MODEL/APPLICATION	SAKURA NO	MODEL/APPLICATION	SAKURA NO	MODEL/APPLICATION	SAKURA NO
KOMATSU		KOMATSU		KOMATSU	
GD530-2A (MOTOR GRADERS)		GD555-3 (MOTOR GRADERS) SA6D102E		Oil Filter By Pass..... O-5704	
Air Filter Set.....	A-8521-S	Air Filter Primary.....	A-8577	Oil Filter Full Flow.....	C-5701
Air Filter Primary.....	A-8521	Air Filter Secondary.....	A-8578	Oil Filter Full Flow.....	C-5715
Air Filter Secondary.....	A-8522	Cabin Air Filter.....	CA-56041	Oil Filter Full Flow.....	C-5605
Coolant Filter.....	WC-5706	Fuel/Water Separator.....	SFC-5706	GD600R-3 (MOTOR GRADERS) 6D125-1	
Fuel Filter Secondary.....	FC-7903	Hydraulic Oil Filter.....	H-56600	Fuel Filter.....	FC-5606
Fuel/Water Separator.....	SFC-5706	GD555-3 (MOTOR GRADERS) SAA6D102E		GD600R-3 (MOTOR GRADERS) 6D125-1/14001	
Fuel/Water Separator.....	SFC-5708	Air Filter Secondary.....	A-8578	Air Filter Primary.....	A-5605
Hydraulic Oil Filter.....	HC-76080	Air Filter Primary.....	A-8577	Air Filter Set.....	A-5604-S
Hydraulic Oil Filter.....	HC-5508	Cabin Air Filter.....	CA-56041	Air Filter Secondary.....	A-5606
Oil Filter Full Flow.....	C-5730	Fuel/Water Separator.....	SFC-5706	Fuel Filter.....	FC-5602
GD530-2B (MOTOR GRADERS)		Hydraulic Oil Filter.....	H-56600	Hydraulic Oil Filter.....	H-5620
Air Filter Set.....	A-8521-S	GD555-3C (MOTOR GRADERS) SA6D102E		Oil Filter Full Flow.....	C-5614
Air Filter Primary.....	A-8521	Air Filter Secondary.....	A-8578	GD605 (MOTOR GRADERS)	
Air Filter Secondary.....	A-8522	Air Filter Primary.....	A-8577	Air Filter Set.....	A-5604-S
Coolant Filter.....	WC-5706	Cabin Air Filter.....	CA-56041	Air Filter Primary.....	A-5605
Fuel Filter Secondary.....	FC-7903	Fuel/Water Separator.....	SFC-5706	Air Filter Secondary.....	A-5606
Fuel/Water Separator.....	SFC-5706	Hydraulic Oil Filter.....	H-56600	Fuel Filter.....	FC-5602
Fuel/Water Separator.....	SFC-5708	GD555-3C (MOTOR GRADERS) SAA6D102E		Hydraulic Oil Filter.....	H-5620
Hydraulic Oil Filter.....	HC-76080	Air Filter Secondary.....	A-8578	Oil Filter Full Flow.....	C-5614
Hydraulic Oil Filter.....	HC-5508	Air Filter Primary.....	A-8577	GD605A-1 (MOTOR GRADERS) NH220	
Oil Filter Full Flow.....	C-5730	Cabin Air Filter.....	CA-56041	Air Filter Primary.....	A-5605
GD530-2C (MOTOR GRADERS)		Fuel/Water Separator.....	SFC-5706	Air Filter Set.....	A-5604-S
Air Filter Primary.....	A-8521	Hydraulic Oil Filter.....	H-56600	Air Filter Secondary.....	A-5606
Air Filter Set.....	A-8521-S	GD525A-1C (MOTOR GRADERS)		Coolant Filter.....	WC-5711
Air Filter Secondary.....	A-8522	Cabin Air Filter.....	CA-56150	Hydraulic Oil Filter.....	H-5620
Coolant Filter.....	WC-5706	GD600R (MOTOR GRADERS)		Oil Filter Full Flow.....	O-5603
Fuel Filter Secondary.....	FC-7903	Air Filter Secondary.....	A-5606	Oil Filter By Pass.....	O-5704
Fuel/Water Separator.....	SFC-5706	Air Filter Primary.....	A-5605	GD605A-1 (MOTOR GRADERS) NH220/50002	
Fuel/Water Separator.....	SFC-5708	Air Filter Set.....	A-5604-S	Air Filter Primary.....	A-5605
Hydraulic Oil Filter.....	HC-5508	Fuel Filter.....	FC-5602	Air Filter Set.....	A-5604-S
Hydraulic Oil Filter.....	HC-76080	Hydraulic Oil Filter.....	H-5620	Air Filter Secondary.....	A-5606
Oil Filter Full Flow.....	C-5730	Oil Filter Full Flow.....	C-5614	Fuel Filter.....	F-5601
GD530A-1 (MOTOR GRADERS) CUMMINS DIESEL		GD600R-1 (MOTOR GRADERS) NH220/10002		Hydraulic Oil Filter.....	H-5620
Air Filter Set.....	A-8521-S	Air Filter Set.....	A-5604-S	Hydraulic Oil Filter.....	H-5608
Air Filter Primary.....	A-8521	Air Filter Primary.....	A-5605	Oil Filter Full Flow.....	O-5603
Air Filter Secondary.....	A-8522	Air Filter Secondary.....	A-5606	Oil Filter By Pass.....	O-5704
Fuel Filter Secondary.....	FC-7903	Fuel Filter.....	F-5601	GD605A-2 (MOTOR GRADERS) CUMMINS NH220	
Fuel/Water Separator.....	SFC-5706	Hydraulic Oil Filter.....	H-5620	Fuel Filter.....	FC-5606
Fuel/Water Separator.....	SFC-5708	Oil Filter Full Flow.....	C-5614	GD605A-2 (MOTOR GRADERS) NH220/53001	
Hydraulic Oil Filter.....	HC-5508	GD600R-2 (MOTOR GRADERS) NH220		Air Filter Set.....	A-5604-S
Hydraulic Oil Filter.....	HC-76080	Air Filter Set.....	A-5604-S	Air Filter Primary.....	A-5605
Oil Filter Full Flow.....	C-5730	Air Filter Primary.....	A-5605	Air Filter Secondary.....	A-5606
GD530A-2 (MOTOR GRADERS) CUMMINS DIESEL		Fuel Filter.....	F-5601	Fuel Filter.....	FC-5602
Air Filter Set.....	A-8521-S	Hydraulic Oil Filter.....	H-5608	Hydraulic Oil Filter.....	H-5620
Air Filter Primary.....	A-8521	Oil Filter Full Flow.....	O-5603	Oil Filter Full Flow.....	C-5715
Air Filter Secondary.....	A-8522	GD600R-2 (MOTOR GRADERS) NH220/13001		Oil Filter Full Flow.....	C-5701
Fuel Filter Secondary.....	FC-7903	Air Filter Secondary.....	A-5606	Oil Filter By Pass.....	O-5704
Fuel/Water Separator.....	SFC-5708	Air Filter Set.....	A-5604-S	Oil Filter Full Flow.....	C-5605
Fuel/Water Separator.....	SFC-5706	Air Filter Primary.....	A-5605	GD605A-3 (MOTOR GRADERS) 6D125-1	
Hydraulic Oil Filter.....	HC-5508	Fuel Filter.....	FC-5602		
Hydraulic Oil Filter.....	HC-76080	Hydraulic Oil Filter.....	H-5620		
Oil Filter Full Flow.....	C-5730				

MODEL/APPLICATION	SAKURA NO	MODEL/APPLICATION	SAKURA NO	MODEL/APPLICATION	SAKURA NO
KOMATSU		KOMATSU		KOMATSU	
GD605A-3 (MOTOR GRADERS) 6D125-1		GD613A-1 (MOTOR GRADERS) 6D125-1/30001		GD625A-1 (MOTOR GRADERS) 6D125	
Fuel Filter.....	FC-5606	Air Filter Secondary.....	A-5606	Fuel Filter.....	FC-5606
GD605A-3 (MOTOR GRADERS) 6D125-1/54001		Air Filter Set.....	A-5604-S	GD625A-1 (MOTOR GRADERS) 6D125-1/50001	
Air Filter Set.....	A-5604-S	Air Filter Secondary.....	A-5603	Air Filter Set.....	A-5604-S
Air Filter Primary.....	A-5605	Air Filter Primary.....	A-5605	Air Filter Secondary.....	A-5603
Air Filter Secondary.....	A-5606	Air Filter Primary.....	A-5602	Air Filter Primary.....	A-5605
Fuel Filter.....	FC-5602	Fuel Filter.....	FC-5602	Air Filter Primary.....	A-5602
Hydraulic Oil Filter.....	H-5620	Hydraulic Oil Filter.....	H-5607	Air Filter Secondary.....	A-5606
Oil Filter Full Flow.....	C-5614	Oil Filter Full Flow.....	C-5614	Fuel Filter.....	FC-5602
GD605R-1 (MOTOR GRADERS) NH220/30002		GD613R-1 (MOTOR GRADERS) S6D105-1/30001		Hydraulic Oil Filter.....	H-5620
Air Filter Set.....	A-5604-S	Air Filter Primary.....	A-5639	Hydraulic Oil Filter.....	H-5607
Air Filter Primary.....	A-5605	Air Filter Secondary.....	A-5635	Oil Filter Full Flow.....	C-5614
Air Filter Secondary.....	A-5606	Air Filter Set.....	A-5604-S	GD625A-1 (MOTOR GRADERS)	
Fuel Filter.....	F-5601	Air Filter Primary.....	A-5605	Cabin Air Filter.....	CA-56150
Hydraulic Oil Filter.....	H-5620	Air Filter Secondary.....	A-5606	GD650-1 (MOTOR GRADERS) S6D114	
Hydraulic Oil Filter.....	H-5608	Hydraulic Oil Filter.....	H-5607	Air Filter Primary.....	A-8521
Oil Filter Full Flow.....	O-5603	Oil Filter Full Flow.....	C-5608	Air Filter Secondary.....	A-8522
Oil Filter By Pass.....	O-5704	Oil Filter Full Flow.....	C-5614	Air Filter Set.....	A-8521-S
GD605R-2 (MOTOR GRADERS) CUMMINS NH220		GD615A-1 (MOTOR GRADERS) S6D110-1		Coolant Filter.....	WC-5705
Fuel Filter.....	FC-5606	Air Filter Secondary.....	A-5635	Fuel Filter Secondary.....	FC-7903
GD605R-2 (MOTOR GRADERS) NH220/33001		Air Filter Primary.....	A-5639	Fuel/Water Separator.....	SFC-5706
Air Filter Set.....	A-5604-S	Coolant Filter.....	WC-5707	Fuel/Water Separator.....	SFC-5708
Air Filter Primary.....	A-5605	Hydraulic Oil Filter.....	H-5607	Hydraulic Oil Filter.....	HC-5508
Air Filter Secondary.....	A-5606	Hydraulic Oil Filter.....	H-5620	Hydraulic Oil Filter.....	HC-76080
Fuel Filter.....	FC-5602	Oil Filter Full Flow.....	C-5608	Oil Filter Combination.....	C-5723
Hydraulic Oil Filter.....	H-5620	GD621A-1 (MOTOR GRADERS) S6D105-1/10001		Oil Filter Combination.....	C-5707
Oil Filter By Pass.....	O-5704	Air Filter Secondary.....	A-5635	GD650-2A (MOTOR GRADERS)	
Oil Filter Full Flow.....	C-5701	Air Filter Secondary.....	A-5606	Air Filter Set.....	A-8521-S
Oil Filter Full Flow.....	C-5715	Air Filter Set.....	A-5604-S	Air Filter Primary.....	A-8521
Oil Filter Full Flow.....	C-5605	Air Filter Primary.....	A-5605	Air Filter Secondary.....	A-8522
GD605R-3 (MOTOR GRADERS) 6D125-1		Air Filter Primary.....	A-5639	Coolant Filter.....	WC-5706
Fuel Filter.....	FC-5606	Hydraulic Oil Filter.....	H-5607	Fuel Filter Secondary.....	FC-7903
GD605R-3 (MOTOR GRADERS) 6D125-1/34001		Oil Filter Full Flow.....	C-5614	Fuel/Water Separator.....	SFC-5706
Air Filter Set.....	A-5604-S	Oil Filter Full Flow.....	C-5608	Fuel/Water Separator.....	SFC-5708
Air Filter Primary.....	A-5605	Oil Filter Full Flow.....	C-5614	Hydraulic Oil Filter.....	HC-5508
Air Filter Secondary.....	A-5606	GD621R-1 (MOTOR GRADERS) S6D105-1/10001		Hydraulic Oil Filter.....	HC-76080
Fuel Filter.....	FC-5602	Air Filter Secondary.....	A-5635	Oil Filter Combination.....	C-5707
Hydraulic Oil Filter.....	H-5620	Air Filter Set.....	A-5604-S	Oil Filter Combination.....	C-5723
Oil Filter Full Flow.....	C-5614	Air Filter Primary.....	A-5605	GD650-2B (MOTOR GRADERS)	
GD611A-1 (MOTOR GRADERS) S6D105-1/10001		Air Filter Secondary.....	A-5606	Air Filter Primary.....	A-8521
Air Filter Primary.....	A-5639	Air Filter Secondary.....	A-5606	Air Filter Secondary.....	A-8522
Air Filter Secondary.....	A-5606	Air Filter Primary.....	A-5639	Air Filter Set.....	A-8521-S
Air Filter Primary.....	A-5605	Hydraulic Oil Filter.....	H-5607	Coolant Filter.....	WC-5706
Air Filter Set.....	A-5604-S	Oil Filter Full Flow.....	C-5608	Fuel Filter Secondary.....	FC-7903
Air Filter Secondary.....	A-5635	Oil Filter Full Flow.....	C-5614	Fuel/Water Separator.....	SFC-5708
Hydraulic Oil Filter.....	H-5607	GD623R-1 (MOTOR GRADERS) S6D105-1/30001		Fuel/Water Separator.....	SFC-5706
Oil Filter Full Flow.....	C-5608	Air Filter Set.....	A-5604-S	Hydraulic Oil Filter.....	HC-76080
Oil Filter Full Flow.....	C-5614	Air Filter Secondary.....	A-5635	Hydraulic Oil Filter.....	HC-5508
GD605R-2 (MOTOR GRADERS) NH220/30002		Air Filter Secondary.....	A-5606	Oil Filter Combination.....	C-5707
Fuel Filter.....	FC-5606	Air Filter Primary.....	A-5605	Oil Filter Combination.....	C-5723
Hydraulic Oil Filter.....	H-5620	Air Filter Secondary.....	A-5606	GD650A-2 (MOTOR GRADERS) S6D114	
Oil Filter Full Flow.....	C-5614	Air Filter Primary.....	A-5639	Air Filter Primary.....	A-8521
GD605R-2 (MOTOR GRADERS) NH220/33001		Hydraulic Oil Filter.....	H-5607	Air Filter Secondary.....	A-8522
Air Filter Set.....	A-5604-S	Oil Filter Full Flow.....	C-5608	Air Filter Set.....	A-8521-S
Air Filter Primary.....	A-5605	Oil Filter Full Flow.....	C-5614	Coolant Filter.....	WC-5706
Air Filter Secondary.....	A-5606	GD623R-1 (MOTOR GRADERS) S6D105-1/30001		Fuel Filter Secondary.....	FC-7903
Fuel Filter.....	FC-5602	Air Filter Set.....	A-5604-S	Fuel/Water Separator.....	SFC-5708
Hydraulic Oil Filter.....	H-5620	Air Filter Secondary.....	A-5635	Fuel/Water Separator.....	SFC-5706
Oil Filter Full Flow.....	C-5614	Air Filter Secondary.....	A-5606	Hydraulic Oil Filter.....	HC-76080
GD605R-2 (MOTOR GRADERS) NH220/30002		Air Filter Primary.....	A-5605	Hydraulic Oil Filter.....	HC-5508
Fuel Filter.....	FC-5606	Air Filter Primary.....	A-5639	Oil Filter Combination.....	C-5723
Hydraulic Oil Filter.....	H-5620	Hydraulic Oil Filter.....	H-5607	Oil Filter Combination.....	C-5707
Oil Filter Full Flow.....	C-5614	Oil Filter Full Flow.....	C-5608	GD650A-2 (MOTOR GRADERS) S6D114	
Oil Filter Full Flow.....	C-5605	Oil Filter Full Flow.....	C-5614	Air Filter Primary.....	A-8521
GD605R-2 (MOTOR GRADERS) NH220/33001		Oil Filter Full Flow.....	C-5614	Air Filter Secondary.....	A-8522
Air Filter Set.....	A-5604-S	GD623R-1 (MOTOR GRADERS) S6D105-1/30001		Air Filter Set.....	A-8521-S
Air Filter Primary.....	A-5605	Air Filter Set.....	A-5604-S	Coolant Filter.....	WC-5706
Air Filter Secondary.....	A-5606	Air Filter Secondary.....	A-5635	Fuel Filter Secondary.....	FC-7903
Fuel Filter.....	FC-5602	Air Filter Secondary.....	A-5606	Fuel/Water Separator.....	SFC-5708
Hydraulic Oil Filter.....	H-5620	Air Filter Primary.....	A-5605	Fuel/Water Separator.....	SFC-5706
Oil Filter Full Flow.....	C-5614	Air Filter Primary.....	A-5639	Hydraulic Oil Filter.....	HC-76080
GD605R-2 (MOTOR GRADERS) NH220/30002		Hydraulic Oil Filter.....	H-5607	Hydraulic Oil Filter.....	HC-5508
Fuel Filter.....	FC-5606	Oil Filter Full Flow.....	C-5608	Oil Filter Combination.....	C-5723
Hydraulic Oil Filter.....	H-5620	Oil Filter Full Flow.....	C-5614	Oil Filter Combination.....	C-5707
Oil Filter Full Flow.....	C-5614	Oil Filter Full Flow.....	C-5614	GD650A-2 (MOTOR GRADERS) S6D114	
Oil Filter Full Flow.....	C-5605	Oil Filter Full Flow.....	C-5614	Air Filter Primary.....	A-8521
GD605R-2 (MOTOR GRADERS) NH220/33001		Oil Filter Full Flow.....	C-5614	Air Filter Secondary.....	A-8522
Air Filter Set.....	A-5604-S	GD623R-1 (MOTOR GRADERS) S6D105-1/30001		Air Filter Set.....	A-8521-S
Air Filter Primary.....	A-5605	Air Filter Set.....	A-5604-S	Coolant Filter.....	WC-5706
Air Filter Secondary.....	A-5606	Air Filter Secondary.....	A-5635	Fuel Filter Secondary.....	FC-7903
Fuel Filter.....	FC-5602	Air Filter Secondary.....	A-5606	Fuel/Water Separator.....	SFC-5708
Hydraulic Oil Filter.....	H-5620	Air Filter Primary.....	A-5605	Fuel/Water Separator.....	SFC-5706
Oil Filter Full Flow.....	C-5614	Air Filter Primary.....	A-5639	Hydraulic Oil Filter.....	HC-76080
GD605R-2 (MOTOR GRADERS) NH220/30002		Hydraulic Oil Filter.....	H-5607	Hydraulic Oil Filter.....	HC-5508
Fuel Filter.....	FC-5606	Oil Filter Full Flow.....	C-5608	Oil Filter Combination.....	C-5723
Hydraulic Oil Filter.....	H-5620	Oil Filter Full Flow.....	C-5614	Oil Filter Combination.....	C-5707
Oil Filter Full Flow.....	C-5614	Oil Filter Full Flow.....	C-5614	GD650A-2 (MOTOR GRADERS) S6D114	
Oil Filter Full Flow.....	C-5605	Oil Filter Full Flow.....	C-5614	Air Filter Primary.....	A-8521

MODEL/APPLICATION	SAKURA NO	MODEL/APPLICATION	SAKURA NO	MODEL/APPLICATION	SAKURA NO
KOMATSU		KOMATSU		KOMATSU	
GD650A-2 (MOTOR GRADERS) S6D114		Fuel/Water Separator.....	SFC-5708	GD655-3E0 (MOTOR GRADERS) SAA6D114E-3	
Air Filter Set.....	A-8521-S	Fuel/Water Separator.....	SFC-5706	Air Filter Primary.....	A-5558M
Air Filter Secondary.....	A-8522	Hydraulic Oil Filter.....	HC-5508	Air Filter Secondary.....	A-5559
Air Filter Primary.....	A-8521	Hydraulic Oil Filter.....	HC-76080	Air Filter Set.....	A-5558M-S
Coolant Filter.....	WC-5705	Oil Filter Combination.....	C-5723	Fuel Filter.....	FC-5613
Fuel Filter Secondary.....	FC-7903	Oil Filter Combination.....	C-5707	Hydraulic Oil Filter.....	H-56600
Fuel/Water Separator.....	SFC-5708			Oil Filter Combination.....	C-5707
Fuel/Water Separator.....	SFC-5706	GD650R-1 (MOTOR GRADERS) NH220/21001		GD655A-1 (MOTOR GRADERS) NH220	
Hydraulic Oil Filter.....	HC-5508	Air Filter Secondary.....	A-5606	Air Filter Set.....	A-5604-S
Hydraulic Oil Filter.....	HC-76080	Air Filter Primary.....	A-5605	Air Filter Primary.....	A-5605
Oil Filter Combination.....	C-5707	Air Filter Set.....	A-5604-S	Air Filter Secondary.....	A-5606
Oil Filter Combination.....	C-5723	Fuel Filter.....	F-5601	Coolant Filter.....	WC-5711
		Hydraulic Oil Filter.....	H-5608	Hydraulic Oil Filter.....	H-5620
		Oil Filter Full Flow.....	O-5603	Oil Filter Full Flow.....	O-5603
				Oil Filter By Pass.....	O-5704
GD650A-2B (MOTOR GRADERS) S6D114E/202487		GD650R-2 (MOTOR GRADERS) NH220		GD655A-1 (MOTOR GRADERS) NH220/60001	
Air Filter Set.....	A-8521-S	Fuel Filter.....	FC-5606	Air Filter Set.....	A-5604-S
Air Filter Secondary.....	A-8522			Air Filter Primary.....	A-5605
Air Filter Primary.....	A-8521	GD650R-2 (MOTOR GRADERS) NH220/23001		Air Filter Secondary.....	A-5606
Coolant Filter.....	WC-5705	Air Filter Set.....	A-5604-S	Fuel Filter.....	F-5601
Fuel Filter Secondary.....	FC-7903	Air Filter Primary.....	A-5605	Hydraulic Oil Filter.....	H-5608
Fuel/Water Separator.....	SFC-5706	Air Filter Secondary.....	A-5606	Hydraulic Oil Filter.....	H-5620
Fuel/Water Separator.....	SFC-5708	Fuel Filter.....	FC-5602	Oil Filter By Pass.....	O-5704
Hydraulic Oil Filter.....	HC-5508	Hydraulic Oil Filter.....	H-5620	Oil Filter Full Flow.....	O-5603
Hydraulic Oil Filter.....	HC-76080	Oil Filter Full Flow.....	C-5605		
Oil Filter Combination.....	C-5723	Oil Filter Full Flow.....	C-5701		
Oil Filter Combination.....	C-5707	Oil Filter By Pass.....	O-5704		
		Oil Filter Full Flow.....	C-5715		
GD650A-2C (MOTOR GRADERS) S6D114E/202727		GD650R-3 (MOTOR GRADERS) 6D125-1		GD655A-2 (MOTOR GRADERS) CUMMINS NH220	
Air Filter Set.....	A-8521-S	Fuel Filter.....	FC-5606	Fuel Filter.....	FC-5606
Air Filter Primary.....	A-8521			GD655A-2 (MOTOR GRADERS) NH220/63001	
Air Filter Secondary.....	A-8522	GD650R-3 (MOTOR GRADERS) 6D125-1/24001		Air Filter Set.....	A-5604-S
Coolant Filter.....	WC-5705	Air Filter Set.....	A-5604-S	Air Filter Secondary.....	A-5606
Fuel Filter Secondary.....	FC-7903	Air Filter Secondary.....	A-5606	Air Filter Primary.....	A-5605
Fuel/Water Separator.....	SFC-5706	Air Filter Primary.....	A-5605	Fuel Filter.....	FC-5602
Fuel/Water Separator.....	SFC-5708	Fuel Filter.....	FC-5602	Hydraulic Oil Filter.....	H-5620
Hydraulic Oil Filter.....	HC-5508	Hydraulic Oil Filter.....	H-5620	Oil Filter By Pass.....	O-5704
Hydraulic Oil Filter.....	HC-76080	Oil Filter Full Flow.....	C-5614	Oil Filter Full Flow.....	C-5715
Oil Filter Combination.....	C-5723			Oil Filter Full Flow.....	C-5605
Oil Filter Combination.....	C-5707			Oil Filter Full Flow.....	C-5701
		GD650R-3 (MOTOR GRADERS) S6D114E		GD655A-3 (MOTOR GRADERS) 6D125-1	
GD650A-2E (MOTOR GRADERS) S6D114E		Air Filter Secondary.....	A-5606	Fuel Filter.....	FC-5606
Air Filter Primary.....	A-8521	Air Filter Set.....	A-5604-S	GD655A-3 (MOTOR GRADERS) 6D125-1/64001	
Air Filter Secondary.....	A-8522	Air Filter Primary.....	A-5605	Air Filter Primary.....	A-5605
Air Filter Set.....	A-8521-S	Coolant Filter.....	WC-5712	Air Filter Set.....	A-5604-S
Coolant Filter.....	WC-5705	Fuel Filter.....	FC-5602	Air Filter Secondary.....	A-5606
Fuel Filter Secondary.....	FC-7903	Fuel Filter.....	FC-5613	Fuel Filter.....	FC-5602
Fuel/Water Separator.....	SFC-5706	Hydraulic Oil Filter.....	H-5620	Hydraulic Oil Filter.....	H-5620
Fuel/Water Separator.....	SFC-5708	Oil Filter Full Flow.....	C-5614	Oil Filter Full Flow.....	C-5614
Hydraulic Oil Filter.....	HC-76080			GD655R-1 (MOTOR GRADERS) NH220/40001	
Hydraulic Oil Filter.....	HC-5508	GD655-3A (MOTOR GRADERS) 2008		Air Filter Primary.....	A-5605
Oil Filter Combination.....	C-5707	Air Filter Primary.....	A-5558M	Air Filter Set.....	A-5604-S
Oil Filter Combination.....	C-5723	Air Filter Secondary.....	A-5559	Air Filter Secondary.....	A-5606
		Air Filter Set.....	A-5558M-S	Fuel Filter.....	FC-5602
GD650AW-2C (MOTOR GRADERS) S6D114E/202727		Fuel Filter.....	FC-5621	Hydraulic Oil Filter.....	H-5620
Air Filter Primary.....	A-8521	Fuel Filter.....	FC-5610	Oil Filter Full Flow.....	C-5614
Air Filter Secondary.....	A-8522	Hydraulic Oil Filter.....	H-56600	GD655R-1 (MOTOR GRADERS) NH220/40001	
Air Filter Set.....	A-8521-S	Oil Filter Combination.....	C-5707	Air Filter Primary.....	A-5605
Coolant Filter.....	WC-5705			Air Filter Set.....	A-5604-S
Fuel Filter Secondary.....	FC-7903			Air Filter Secondary.....	A-5606

MODEL/APPLICATION	SAKURA NO	MODEL/APPLICATION	SAKURA NO	MODEL/APPLICATION	SAKURA NO
KOMATSU		KOMATSU		KOMATSU	
GD655R-1 (MOTOR GRADERS) NH220/40001		Air Filter Set.....	A-8521-S	Oil Filter Combination.....	C-5707
Fuel Filter.....	F-5601	Air Filter Secondary.....	A-8522	Oil Filter Combination.....	C-5723
Hydraulic Oil Filter.....	H-5620	Air Filter Primary.....	A-8521		
Hydraulic Oil Filter.....	H-5608	Fuel Filter Secondary.....	FC-7903	GD670AW-2B (MOTOR GRADERS) S6D114E/202487	
Oil Filter Full Flow.....	O-5603	Fuel/Water Separator.....	SFC-5708	Air Filter Primary.....	A-8521
Oil Filter By Pass.....	O-5704	Fuel/Water Separator.....	SFC-5706	Air Filter Set.....	A-8521-S
		Hydraulic Oil Filter.....	HC-5508	Air Filter Secondary.....	A-8522
GD655R-2 (MOTOR GRADERS) CUMMINS NH220		Hydraulic Oil Filter.....	HC-76080	Coolant Filter.....	WC-5705
Fuel Filter.....	FC-5606	Oil Filter Combination.....	C-5707	Fuel Filter Secondary.....	FC-7903
		Oil Filter Combination.....	C-5723	Fuel/Water Separator.....	SFC-5708
GD655R-2 (MOTOR GRADERS) NH220/43001		GD670-2A (MOTOR GRADERS)		Fuel/Water Separator.....	SFC-5706
Air Filter Set.....	A-5604-S	Air Filter Set.....	A-8521-S	Hydraulic Oil Filter.....	HC-76080
Air Filter Primary.....	A-5605	Air Filter Primary.....	A-8521	Hydraulic Oil Filter.....	HC-5508
Air Filter Secondary.....	A-5606	Air Filter Secondary.....	A-8522	Oil Filter Combination.....	C-5707
Fuel Filter.....	FC-5602	Coolant Filter.....	WC-5706	Oil Filter Combination.....	C-5723
Hydraulic Oil Filter.....	H-5620	Fuel Filter Secondary.....	FC-7903		
Oil Filter By Pass.....	O-5704	Fuel/Water Separator.....	SFC-5708	GD670AW-2C (MOTOR GRADERS) S6D114E/202727	
Oil Filter Full Flow.....	C-5701	Fuel/Water Separator.....	SFC-5706	Air Filter Primary.....	A-8521
Oil Filter Full Flow.....	C-5715	Hydraulic Oil Filter.....	HC-76080	Air Filter Secondary.....	A-8522
Oil Filter Full Flow.....	C-5605	Hydraulic Oil Filter.....	HC-5508	Air Filter Set.....	A-8521-S
		Oil Filter Combination.....	C-5723	Coolant Filter.....	WC-5705
GD655R-3 (MOTOR GRADERS) 6D125-1		Oil Filter Combination.....	C-5707	Fuel Filter Secondary.....	FC-7903
Fuel Filter.....	FC-5606			Fuel/Water Separator.....	SFC-5706
		GD670A-2 (MOTOR GRADERS) CUMMINS DIESEL		Fuel/Water Separator.....	SFC-5708
GD655R-3 (MOTOR GRADERS) 6D125-1/44001		Air Filter Set.....	A-8521-S	Hydraulic Oil Filter.....	HC-5508
Air Filter Set.....	A-5604-S	Air Filter Primary.....	A-8521	Hydraulic Oil Filter.....	HC-76080
Air Filter Secondary.....	A-5606	Air Filter Secondary.....	A-8522	Oil Filter Combination.....	C-5707
Air Filter Primary.....	A-5605	Fuel Filter Secondary.....	FC-7903	Oil Filter Combination.....	C-5723
Fuel Filter.....	FC-5602	Fuel/Water Separator.....	SFC-5706		
Hydraulic Oil Filter.....	H-5620	Fuel/Water Separator.....	SFC-5708	GD675-3 (MOTOR GRADERS) SAA6D114E-3	
Oil Filter Full Flow.....	C-5614	Hydraulic Oil Filter.....	HC-5508	Air Filter Primary.....	A-5558M
		Hydraulic Oil Filter.....	HC-76080	Air Filter Secondary.....	A-5559
GD661A-1 (MOTOR GRADERS) S6D95L-1/10001		Oil Filter Combination.....	C-5723	Air Filter Set.....	A-5558M-S
Air Filter Primary.....	A-5639	Oil Filter Combination.....	C-5707	Coolant Filter.....	WC-5711
Air Filter Set.....	A-5604-S			Fuel Filter.....	FC-5613
Air Filter Secondary.....	A-5635	GD670A-2C (MOTOR GRADERS) S6D114E/202727		Hydraulic Oil Filter.....	H-56600
Air Filter Primary.....	A-5605	Air Filter Primary.....	A-8521	Oil Filter Combination.....	C-5707
Air Filter Secondary.....	A-5606	Air Filter Set.....	A-8521-S		
Hydraulic Oil Filter.....	H-5607	Air Filter Secondary.....	A-8522	GD675-3E0 (MOTOR GRADERS) SAA6D114E-3	
Oil Filter Full Flow.....	C-5614	Coolant Filter.....	WC-5705	Air Filter Primary.....	A-5558M
Oil Filter Full Flow.....	C-5608	Fuel Filter Secondary.....	FC-7903	Air Filter Secondary.....	A-5559
		Fuel/Water Separator.....	SFC-5706	Air Filter Set.....	A-5558M-S
GD663A-1 (MOTOR GRADERS) 6D125-1		Fuel/Water Separator.....	SFC-5708	Coolant Filter.....	WC-5711
Fuel Filter.....	FC-5606	Hydraulic Oil Filter.....	HC-76080	Fuel Filter.....	FC-5613
		Hydraulic Oil Filter.....	HC-5508	Hydraulic Oil Filter.....	H-56600
GD663A-1 (MOTOR GRADERS) 6D125-1/30001		Oil Filter Combination.....	C-5723	Oil Filter Combination.....	C-5707
Air Filter Set.....	A-5604-S	Oil Filter Combination.....	C-5707		
Air Filter Primary.....	A-5602			GD655-5 (MOTOR GRADERS) SAA6D107E , 2010	
Air Filter Secondary.....	A-5606	GD670A-2E (MOTOR GRADERS) S6D114E		Air Filter Primary.....	A-5558M
Air Filter Secondary.....	A-5603	Air Filter Set.....	A-8521-S	Air Filter Secondary.....	A-5559
Air Filter Primary.....	A-5605	Air Filter Primary.....	A-8521	Air Filter Set.....	A-5558M-S
Fuel Filter.....	FC-5602	Air Filter Secondary.....	A-8522	Hydraulic Oil Filter.....	H-56600
Hydraulic Oil Filter.....	H-5607	Coolant Filter.....	WC-5705		
Oil Filter Full Flow.....	C-5614	Fuel Filter Secondary.....	FC-7903	GD625A-1C (MOTOR GRADERS)	
		Fuel/Water Separator.....	SFC-5706	Cabin Air Filter.....	CA-56150
GD670-1 (MOTOR GRADERS) CUMMINS DIESEL		Fuel/Water Separator.....	SFC-5708		
		Hydraulic Oil Filter.....	HC-76080	GD705A-3 (MOTOR GRADERS) NT0-6-C1	
		Hydraulic Oil Filter.....	HC-5508	Fuel Filter.....	FC-5606

MODEL/APPLICATION	SAKURA NO	MODEL/APPLICATION	SAKURA NO	MODEL/APPLICATION	SAKURA NO
KOMATSU		KOMATSU		KOMATSU	
GD705A-3 (MOTOR GRADERS) NTO-6/10002		Hydraulic Oil Filter.....	H-56600	Air Filter Primary.....	A-5614
Air Filter Secondary.....	A-5408	Oil Filter Full Flow.....	C-5715	Fuel Filter.....	FC-5602
Air Filter Primary.....	A-6113	Oil Filter Full Flow.....	C-5605	Oil Filter By Pass.....	O-5704
Fuel Filter.....	FC-5602	Oil Filter Full Flow.....	C-5701	Oil Filter Full Flow.....	C-5605
Hydraulic Oil Filter.....	H-5620			Oil Filter Full Flow.....	C-5701
Oil Filter Full Flow.....	C-5715	GD750A-1 (MOTOR GRADERS) S/N: 7003		Oil Filter Full Flow.....	C-5715
Oil Filter Full Flow.....	C-5605	Fuel/Water Separator.....	SFC-5705		
Oil Filter Full Flow.....	C-5701	Fuel/Water Separator.....	SFC-5709-10	GS360-1 (MOTOR GRADERS)	
Oil Filter By Pass.....	O-5704	Hydraulic Oil Filter.....	HC-76080	Air Filter Secondary.....	A-5610
		Oil Filter Combination.....	C-5707	Air Filter Primary.....	A-5614
		Oil Filter Combination.....	C-5723	Fuel Filter.....	FC-5602
GD705A-3 (MOTOR GRADERS) S6D125-1				Hydraulic Oil Filter.....	H-5610
Fuel Filter.....	FC-5606	GD825A-1 (MOTOR GRADERS) S6D140-1/10002		Hydraulic Oil Filter.....	H-56600
		Air Filter Secondary.....	A-5610	Oil Filter By Pass.....	O-5704
		Air Filter Primary.....	A-5614	Oil Filter Full Flow.....	C-5605
		Fuel Filter.....	FC-5703	Oil Filter Full Flow.....	C-5715
		Fuel/Water Separator.....	SFC-5707	Oil Filter Full Flow.....	C-5701
GD705A-4 (MOTOR GRADERS) S6D125-1		Oil Filter Full Flow.....	C-5605		
Fuel Filter.....	FC-5606	Oil Filter Full Flow.....	C-5701	H100 (LOADERS) 6V-71	
		Oil Filter Full Flow.....	C-5715	Fuel Filter.....	F-6503
GD705A-4 (MOTOR GRADERS) S6D125-1/21001				Fuel Filter.....	F-6504
Air Filter Primary.....	A-6113	GD825A-2 (MOTOR GRADERS)		Fuel Filter.....	F-6505
Air Filter Secondary.....	A-5408	Cabin Air Filter.....	CA-56150	Fuel Filter.....	F-7302
Fuel Filter.....	FC-5602			Oil Filter Full Flow.....	O-6503
Hydraulic Oil Filter.....	H-5620	GD825A-2 (MOTOR GRADERS) S6D140/12001			
Oil Filter Full Flow.....	C-5715	Air Filter Primary.....	A-5614	H100 (LOADERS) IHC	
Oil Filter Full Flow.....	C-5701	Air Filter Secondary.....	A-5610	Fuel Filter Secondary.....	FC-54050
Oil Filter Full Flow.....	C-5605	Fuel Filter.....	FC-5703	Fuel/Water Separator.....	SFC-5705
		Fuel/Water Separator.....	SFC-5707	Hydraulic Oil Filter Transmission...	H-65030
GD705R-2 (MOTOR GRADERS) NH220/1001		Hydraulic Oil Filter.....	H-5618	Oil Filter Full Flow.....	C-5402
Air Filter Set.....	A-5622-S	Oil Filter Full Flow.....	C-5715		
Air Filter Secondary.....	A-5624	Oil Filter Full Flow.....	C-5701	H100 (LOADERS) NH220	
Air Filter Primary.....	A-5623	Oil Filter Full Flow.....	C-5605	Fuel Filter.....	F-5701
Fuel Filter.....	F-5601			Hydraulic Oil Filter Transmission...	H-65030
Hydraulic Oil Filter.....	H-5611	GD825A-2 (MOTOR GRADERS) S/N: 11001		Oil Filter Full Flow.....	O-5702
Oil Filter Full Flow.....	O-5603	Air Filter Primary.....	A-5614		
Oil Filter By Pass.....	O-5704	Air Filter Secondary.....	A-5610	H100 (LOADERS) NH250	
		Cabin Air Filter.....	CA-56150	Fuel Filter.....	F-5701
GD705R-4 (MOTOR GRADERS) 6D125-1		Fuel Filter.....	FC-5703	Hydraulic Oil Filter Transmission...	H-65030
Fuel Filter.....	FC-5606	Hydraulic Oil Filter.....	H-5618	Oil Filter Full Flow.....	O-5702
GD705R-4 (MOTOR GRADERS) 6D125-1/16001		GF505A (MOTOR GRADERS)		H100 (LOADERS) NT-855	
Air Filter Secondary.....	A-5606	Air Filter Set.....	A-5604-S	Air Filter.....	AS-5706
Air Filter Primary.....	A-5605	Air Filter Primary.....	A-5605	Fuel Filter.....	FC-5720
Air Filter Set.....	A-5604-S	Air Filter Secondary.....	A-5606	Fuel Filter.....	F-5701
Fuel Filter.....	FC-5602	Hydraulic Oil Filter.....	H-5620	Fuel Filter.....	FC-1303
Hydraulic Oil Filter.....	H-5620	Oil Filter Full Flow.....	C-5614	Fuel/Water Separator.....	SFC-5705
Oil Filter Full Flow.....	C-5614			Hydraulic Oil Filter Transmission...	H-65030
		GF615A-1 (MOTOR GRADERS) S/N: 50001		Oil Filter Full Flow.....	O-5702
GD725A-1 (MOTOR GRADERS)		Air Filter Primary.....	A-5639		
Cabin Air Filter.....	CA-56150	Air Filter Secondary.....	A-5635	H100 SERIES B (LOADERS) IHC	
		Hydraulic Oil Filter.....	H-5607	Fuel Filter Secondary.....	FC-54050
GD725A-1 (MOTOR GRADERS) S6D125		Hydraulic Oil Filter.....	H-5620	Fuel/Water Separator.....	SFC-5705
Fuel Filter.....	FC-5606	Oil Filter Full Flow.....	C-5608	Hydraulic Oil Filter Transmission...	H-65030
				Oil Filter Full Flow.....	C-5402
GD725A-1 (MOTOR GRADERS) S6D125-1/50001		GS360 (STABILIZERS) NTA-855		H100 SERIES C (LOADERS) IHC	
Air Filter Secondary.....	A-5408	Air Filter Secondary.....	A-5610	Fuel Filter Secondary.....	FC-54050
Air Filter Primary.....	A-6113			Fuel/Water Separator.....	SFC-5705
Fuel Filter.....	FC-5602			Hydraulic Oil Filter Transmission...	H-65030
Hydraulic Oil Filter.....	H-5610			Oil Filter Full Flow.....	C-5402

MODEL/APPLICATION	SAKURA NO	MODEL/APPLICATION	SAKURA NO	MODEL/APPLICATION	SAKURA NO
KOMATSU		KOMATSU		KOMATSU	
H100 SERIES C (LOADERS) IHC		H120 SERIES C (LOADERS) 8V-71		H23C (EXCAVATORS) F6L912	
Fuel/Water Separator.....	SFC-5705	Fuel Filter.....	F-6503	Fuel Filter.....	FC-5704
Hydraulic Oil Filter Transmission...	H-65030	Fuel Filter.....	F-7302	Oil Filter Full Flow.....	C-6204
Oil Filter Full Flow.....	C-5402	Oil Filter Full Flow.....	0-6503		
H100B (LOADERS) BD264		H120B (LOADERS)		H23LC (EXCAVATORS) F6L912	
Hydraulic Oil Filter Transmission...	H-65030	Air Filter.....	A-8545	Fuel Filter.....	FC-5704
Oil Filter Full Flow.....	C-5405	Fuel Filter Secondary.....	FC-54050	Oil Filter Full Flow.....	C-6204
		Fuel/Water Separator.....	SFC-5705		
H100C (LOADERS) DT817		H120C (LOADERS) DT817		H240 (CRANES) F6L912	
Fuel Filter Secondary.....	FC-54050	Air Filter Secondary.....	A-5417	Air Filter Secondary.....	A-6302
Oil Filter Full Flow.....	C-5402	Air Filter Primary.....	A-5425	Air Filter Primary.....	A-6207
		Air Filter.....	A-8545	Fuel Filter.....	FC-5704
H100C (LOADERS)		H120C (LOADERS) DT817B		H241 (EXCAVATORS) 16V-149T	
Fuel Filter Secondary.....	FC-54050	Hydraulic Oil Filter Transmission...	H-65030	Fuel Filter Primary.....	FC-6501
Fuel/Water Separator.....	SFC-5705			Fuel Filter Secondary.....	FC-6502
Oil Filter Full Flow.....	C-5402			Fuel/Water Separator.....	SFC-7301
				Oil Filter Full Flow.....	0-6503
H101 (EXCAVATORS) F6L413		H120C (LOADERS) DT817B		H241 (EXCAVATORS) 16V-71T	
Air Filter Primary.....	AS-5628	Air Filter Secondary.....	A-5417	Fuel Filter Secondary.....	FC-6502
Air Filter Set.....	A-5628-S	Air Filter Primary.....	A-5425	Fuel Filter Primary.....	FC-6501
Air Filter Primary.....	A-5628	Air Filter.....	A-8545	Fuel/Water Separator.....	SFC-7301
Fuel Filter.....	FC-5704	Fuel Filter Secondary.....	FC-54050	Oil Filter Full Flow.....	0-6503
Fuel Filter.....	F-2604	Fuel/Water Separator.....	SFC-5705		
Oil Filter Full Flow.....	C-6203	Hydraulic Oil Filter Transmission...	H-65030		
Oil Filter Full Flow.....	C-6204				
H101 (EXCAVATORS) F8L413		H121 (EXCAVATORS) 16V-149T		H241 (EXCAVATORS) KTA-D19893067	
Air Filter Set.....	A-5628-S	Fuel Filter Secondary.....	FC-6502	Coolant Filter.....	WC-5711
Air Filter Primary.....	A-5628	Fuel Filter Primary.....	FC-6501	Fuel Filter.....	FC-5703
Air Filter Primary.....	AS-5628	Fuel/Water Separator.....	SFC-7301	Fuel/Water Separator.....	SFC-5707
Fuel Filter.....	FC-5704	Oil Filter Full Flow.....	0-6503	Oil Filter Full Flow.....	C-5605
Fuel Filter.....	F-2604			Oil Filter Full Flow.....	C-5701
Oil Filter Full Flow.....	C-6204			Oil Filter By Pass.....	C-5718
Oil Filter Full Flow.....	C-6203				
H111 (EXCAVATORS) GM		H121 (EXCAVATORS) VTA-1710		H25 (LOADERS) B	
Air Filter Secondary.....	A-7915	Coolant Filter.....	WC-5711	Air Filter Primary.....	AS-2205
Air Filter Primary.....	A-7912	Fuel Filter.....	FC-5703		
Air Filter Set.....	A-7912-S	Fuel/Water Separator.....	SFC-5707		
		Oil Filter Full Flow.....	C-5715		
		Oil Filter By Pass.....	C-5718		
H120 (LOADERS) 8V-71		H15C (COMPACTORS) F4L912		H25B (LOADERS)	
Fuel Filter.....	F-6503	Oil Filter Full Flow.....	C-6202	Air Filter Primary.....	AS-7609
Fuel Filter.....	F-7302			Fuel Filter.....	FC-5103
Oil Filter Full Flow.....	0-6503			Oil Filter Full Flow.....	0-1803
				Oil Filter Full Flow.....	0-2619
H120 (LOADERS)		H21C (EXCAVATORS) F5L912		H25 SERIES B (LOADERS) 180DLC	
Air Filter.....	A-8545	Air Filter.....	AS-1010	Air Filter Primary.....	AS-7609
Fuel Filter Secondary.....	FC-54050	Fuel Filter.....	FC-5704	Air Filter Primary.....	AS-1014
Fuel/Water Separator.....	SFC-5705	Oil Filter Full Flow.....	C-6204	Air Filter Secondary.....	A-7605
H120 SERIES B (LOADERS) 8V-71		H21P (EXCAVATORS) F5L912		H25 SERIES B (LOADERS) 180GKB	
Fuel Filter.....	F-6503	Air Filter.....	AS-1010	Air Filter Primary.....	AS-1014
Fuel Filter.....	F-7302	Fuel Filter.....	FC-5704		
Oil Filter Full Flow.....	0-6503	Oil Filter Full Flow.....	C-6204	Air Filter Primary.....	A-5628
				Air Filter Primary.....	AS-1014
				Air Filter Primary.....	A-5628

MODEL/APPLICATION	SAKURA NO	MODEL/APPLICATION	SAKURA NO	MODEL/APPLICATION	SAKURA NO
KOMATSU		KOMATSU		KOMATSU	
H25 SERIES B (LOADERS) D188		Air Filter Primary.....	A-5628	H31LC (EXCAVATORS) F6L413	
Air Filter Set.....	A-5628-S	Air Filter Primary.....	AS-1014	Air Filter Primary.....	AS-5628
H285S (EXCAVATORS) CUMMINS		Fuel Filter.....	F-6505	Air Filter Primary.....	A-5628
Air Filter Secondary.....	A-7902	Fuel Filter Secondary.....	F-6502	Air Filter Set.....	A-5628-S
Coolant Filter.....	WC-5703	Hydraulic Oil Filter Transmission...	H-65030	Fuel Filter.....	F-2604
Fuel Filter.....	FC-5703	Oil Filter Full Flow.....	O-6503	Fuel Filter.....	FC-5704
Fuel/Water Separator.....	SFC-5707	H30F SERIES B (LOADERS) D301		Oil Filter Full Flow.....	C-6203
Oil Filter Full Flow.....	C-5605	Air Filter Primary.....	AS-7609	Oil Filter Full Flow.....	C-6204
Oil Filter Full Flow.....	C-5701	Air Filter Primary.....	A-5628	H31P (EXCAVATORS) F6L413	
Oil Filter By Pass.....	C-5718	Air Filter Primary.....	AS-5628	Air Filter Primary.....	AS-5628
H30 (LOADERS)		Air Filter Primary.....	AS-1014	Air Filter Primary.....	A-5628
Air Filter Primary.....	AS-5628	Air Filter Secondary.....	A-7605	Air Filter Set.....	A-5628-S
Air Filter Primary.....	A-5628	Air Filter Set.....	A-5628-S	Fuel Filter.....	FC-5704
Air Filter Set.....	A-5628-S	Air Filter.....	AS-1010	Fuel Filter.....	F-2604
Fuel Filter.....	F-2604	H30F SERIES B (LOADERS) G-263		Oil Filter Full Flow.....	C-6203
Fuel Filter.....	F-2603	Hydraulic Oil Filter Transmission...	H-65030	Oil Filter Full Flow.....	C-6204
H30 SERIES B (LOADERS) 3-53		H30F SERIES B (LOADERS) UD-236		H31P (EXCAVATORS) F8L413	
Air Filter Primary.....	AS-5628	Air Filter Primary.....	AS-5628	Air Filter Primary.....	AS-5628
Air Filter Primary.....	AS-1014	Air Filter Primary.....	AS-1014	Air Filter Primary.....	A-5628
Air Filter Primary.....	A-5628	Air Filter Primary.....	A-5628	Air Filter Set.....	A-5628-S
Air Filter Set.....	A-5628-S	Air Filter Set.....	A-5628-S	Fuel Filter.....	FC-5704
Fuel Filter.....	F-6505	Air Filter.....	AS-1010	Fuel Filter.....	F-2604
Fuel Filter Secondary.....	F-6502	Hydraulic Oil Filter Transmission...	H-65030	Oil Filter Full Flow.....	C-6204
Hydraulic Oil Filter Transmission...	H-65030	H-30R SERIES B (LOADERS) 3-53		Oil Filter Full Flow.....	C-6203
Oil Filter Full Flow.....	O-6503	Fuel Filter Secondary.....	F-6502	H36 (EXCAVATORS) F6L413	
H30 SERIES B (LOADERS) G-263		Fuel Filter.....	F-6505	Air Filter Primary.....	A-5628
Hydraulic Oil Filter Transmission...	H-65030	Hydraulic Oil Filter Transmission...	H-65030	Air Filter Set.....	A-5628-S
H30 SERIES B (LOADERS) UD-236		Oil Filter Full Flow.....	O-6503	Air Filter Primary.....	AS-5628
Air Filter Primary.....	AS-5628	H-30R SERIES B (LOADERS) U-236		Fuel Filter.....	F-2604
Air Filter Primary.....	A-5628	Hydraulic Oil Filter Transmission...	H-65030	Fuel Filter.....	FC-5704
Air Filter Set.....	A-5628-S	H-30R SERIES B (LOADERS) U-240		Oil Filter Full Flow.....	C-6203
Air Filter.....	AS-1010	Hydraulic Oil Filter Transmission...	H-65030	Oil Filter Full Flow.....	C-6204
Air Filter Primary.....	AS-1014	H31 (EXCAVATORS) F6L413		H-40 (LOADERS) G-264	
Hydraulic Oil Filter Transmission...	H-65030	Air Filter Primary.....	AS-5628	Air Filter.....	AS-1010
H30B (LOADERS) D239		Air Filter Primary.....	A-5628	Hydraulic Oil Filter Transmission...	H-65030
Fuel Filter.....	F-2603	Air Filter Set.....	A-5628-S	H-40 (LOADERS) UD-282	
Fuel Filter.....	F-2604	Fuel Filter.....	FC-5704	Hydraulic Oil Filter Transmission...	H-65030
H30B (LOADERS)		Fuel Filter.....	F-2604	H-40 (LOADERS) UD-282	
Air Filter Primary.....	AS-5628	Oil Filter Full Flow.....	C-6204	Hydraulic Oil Filter Transmission...	H-65030
Air Filter Primary.....	AS-7609	Oil Filter Full Flow.....	C-6203	H400 (LOADERS) 12V-71	
Air Filter Secondary.....	A-7605	H31 (EXCAVATORS) F8L413		Fuel Filter.....	F-6504
Air Filter Primary.....	A-5628	Air Filter Primary.....	AS-5628	Hydraulic Oil Filter Transmission...	H-65030
Air Filter Set.....	A-5628-S	Air Filter Primary.....	A-5628	Oil Filter Full Flow.....	O-6503
Fuel Filter.....	F-2604	Air Filter Set.....	A-5628-S	H30F SERIES B (LOADERS) 3-53	
Hydraulic Oil Filter Transmission...	H-65030	Fuel Filter.....	FC-5704	Air Filter Primary.....	AS-5628
H30F SERIES B (LOADERS) 3-53		Fuel Filter.....	F-2604	Air Filter Set.....	A-5628-S
Air Filter Primary.....	AS-5628	Oil Filter Full Flow.....	C-6204	Fuel Filter.....	F-2604
Air Filter Set.....	A-5628-S	Oil Filter Full Flow.....	C-6203	Hydraulic Oil Filter Transmission...	H-65030

MODEL/APPLICATION	SAKURA NO
KOMATSU	
H400 (LOADERS) VT-12-525	
Fuel Filter.....	F-5701
Hydraulic Oil Filter Transmission...	H-65030
Oil Filter Full Flow.....	O-5702
Oil Filter Full Flow.....	C-8031
H400C (LOADERS)	
Air Filter Secondary.....	A-5417
Air Filter Primary.....	A-5425
Coolant Filter.....	WC-5707
Fuel Filter.....	FC-5703
Fuel/Water Separator.....	SFC-5707
Oil Filter By Pass.....	C-5718
Oil Filter Full Flow.....	C-5715
H40B (LOADERS)	
Air Filter Primary.....	AS-5628
Air Filter Primary.....	A-5628
Air Filter Set.....	A-5628-S
H41 (EXCAVATORS) F10L413F	
Air Filter Primary.....	AS-5628
Air Filter Primary.....	A-5628
Air Filter Set.....	A-5628-S
Fuel Filter.....	FC-6202
Fuel Filter.....	F-2604
Oil Filter Full Flow.....	C-6204
H-50 (LOADERS) UB-264	
Air Filter.....	AS-1010
H-50 SERIES B (LOADERS) 3-53	
Fuel Filter Secondary.....	F-6502
Fuel Filter.....	F-6505
Hydraulic Oil Filter Transmission...	H-65030
Oil Filter Full Flow.....	O-6503
H-50 SERIES B (LOADERS) G-301	
Hydraulic Oil Filter Transmission...	H-65030
H-50 SERIES B (LOADERS) UD-282	
Hydraulic Oil Filter Transmission...	H-65030
H-50 SERIES C (LOADERS) 3-53	
Air Filter.....	AS-1010
Fuel Filter.....	F-6505
Fuel Filter Secondary.....	F-6502
Oil Filter Full Flow.....	O-6503
H-50 SERIES C (LOADERS) G-301	
Air Filter Primary.....	AS-5628
Air Filter Primary.....	A-5628
Air Filter Set.....	A-5628-S
H50B (LOADERS)	

MODEL/APPLICATION	SAKURA NO
KOMATSU	
Fuel Filter.....	FC-5403
Hydraulic Oil Filter Transmission...	H-65030
Oil Filter Full Flow.....	C-6204
H50C (LOADERS)	
Air Filter Primary.....	AS-5628
Air Filter Primary.....	A-5628
Air Filter Set.....	A-5628-S
Oil Filter Full Flow.....	C-5814
H51 (EXCAVATORS) F10L413F	
Air Filter Primary.....	AS-5628
Air Filter Primary.....	A-5628
Air Filter Set.....	A-5628-S
Fuel Filter.....	FC-6202
Fuel Filter.....	F-2604
Oil Filter Full Flow.....	C-6204
H51 (EXCAVATORS) VT-903	
Coolant Filter.....	WC-5705
Fuel Filter.....	FC-5702
Oil Filter Full Flow.....	C-5715
Oil Filter By Pass.....	C-5718
H60 (LOADERS) 3-71	
Fuel Filter.....	F-6505
Fuel Filter Secondary.....	F-6502
Hydraulic Oil Filter Transmission...	H-65030
Oil Filter Full Flow.....	O-6503
H60 (LOADERS) G-372	
Hydraulic Oil Filter Transmission...	H-65030
H60 (LOADERS) 6	
Fuel Filter.....	F-2604
Fuel Filter.....	FC-5403
Fuel Filter.....	F-2603
Hydraulic Oil Filter Transmission...	H-65030
Oil Filter Full Flow.....	C-6204
H-60 SERIES B (LOADERS) D301	
Air Filter Primary.....	AS-5628
Air Filter Primary.....	A-5628
Air Filter Set.....	A-5628-S
H-60 SERIES B (LOADERS) G-301	
Air Filter Primary.....	AS-5628
Air Filter Primary.....	A-5628
Air Filter Set.....	A-5628-S
H-60 SERIES B (LOADERS) V-352-C	
Air Filter Primary.....	AS-1024
Air Filter Set.....	AS-1024-S
Air Filter.....	AS-1010
Air Filter Secondary.....	A-7809
Fuel Filter.....	FC-5720
Fuel Filter.....	FC-1303

MODEL/APPLICATION	SAKURA NO
KOMATSU	
Fuel/Water Separator.....	SFC-5705
Oil Filter Full Flow.....	O-5703
H60B (LOADERS)	
Air Filter Secondary.....	A-7809
Air Filter Set.....	AS-1024-S
Air Filter Primary.....	AS-1024
Fuel Filter.....	FC-7933
Fuel Filter.....	FC-5103
Fuel/Water Separator.....	SFC-5705
Oil Filter Full Flow.....	C-6204
H60E (LOADERS)	
Air Filter Primary.....	AS-1024
Air Filter Set.....	AS-1024-S
Air Filter Secondary.....	A-7809
Fuel Filter.....	FC-1810
Fuel Filter.....	FC-7933
Fuel/Water Separator.....	SFC-5705
H65 (EXCAVATORS)	
Air Filter Secondary.....	A-5417
Air Filter Primary.....	A-5425
Fuel Filter.....	FC-5702
Hydraulic Oil Filter.....	HC-5502
Oil Filter Full Flow.....	C-7602
H-65 SERIES B (LOADERS) 3-71	
Fuel Filter.....	F-6505
Fuel Filter Secondary.....	F-6502
Hydraulic Oil Filter Transmission...	H-65030
Oil Filter Full Flow.....	O-6503
H-65 SERIES B (LOADERS) 6	
Air Filter.....	AS-1010
H-65 SERIES C (LOADERS) DT361	
Fuel Filter.....	FC-1810
Fuel/Water Separator.....	SFC-5705
H-65 SERIES C (LOADERS) DT407	
Air Filter Primary.....	A-2210
Air Filter Secondary.....	A-6008
Fuel Filter.....	FC-1810
Fuel/Water Separator.....	SFC-5705
H65C (LOADERS) DT414	
Fuel Filter.....	FC-1810
Fuel Filter.....	FC-7933
H65C (LOADERS)	
Fuel Filter.....	FC-5103
Oil Filter Full Flow.....	C-6204
H-70 (LOADERS) 3-71	
Fuel Filter.....	F-6505
Fuel Filter Secondary.....	F-6502

Sakura Filter

ENGINE APPLICATION

MODEL/APPLICATION	SAKURA NO	MODEL/APPLICATION	SAKURA NO	MODEL/APPLICATION	SAKURA NO
KOMATSU		KOMATSU		KOMATSU	
H-70 (LOADERS) 3-71		Fuel/Water Separator.....	SFC-5705	H90E (LOADERS) DT573	
Oil Filter Full Flow.....	0-6503	H80B (LOADERS) DT466		Fuel Filter.....	FC-1810
H-70 SERIES B (LOADERS) 3-71		Coolant Filter.....	WC-5708	Fuel/Water Separator.....	SFC-5705
Fuel Filter.....	F-6505	Coolant Filter.....	WC-5705	Oil Filter Full Flow.....	C-5402
Fuel Filter Secondary.....	F-6502	Fuel Filter.....	FC-7933	H90E (LOADERS) DT573B	
Oil Filter Full Flow.....	0-6503	Fuel Filter.....	FC-1810	Air Filter.....	A-5410
H-70 SERIES B (LOADERS) U-372		Fuel/Water Separator.....	SFC-5705	Fuel Filter Secondary.....	FC-54050
Hydraulic Oil Filter Transmission...	H-65030	H80B (LOADERS)		Fuel Filter.....	FC-1810
H-70 SERIES C (LOADERS) 4-71		Air Filter.....	A-5434	Fuel Filter.....	FC-7933
Fuel Filter.....	F-6505	Fuel Filter.....	FC-1810	Fuel/Water Separator.....	SFC-5705
Fuel Filter Secondary.....	F-6502	Fuel Filter.....	FC-7933	Oil Filter Full Flow.....	C-5402
Hydraulic Oil Filter Transmission...	H-65030	Fuel/Water Separator.....	SFC-5705	H90E (LOADERS)	
Oil Filter Full Flow.....	0-6503	H-90 (LOADERS) 4-71		Air Filter Set.....	A-5420-S
H-70 SERIES C (LOADERS) C-160		Fuel Filter Secondary.....	F-6502	Air Filter Primary.....	A-5420
Fuel Filter.....	F-5701	Fuel Filter.....	F-6505	Air Filter.....	A-5410
Hydraulic Oil Filter Transmission...	H-65030	Hydraulic Oil Filter Transmission...	H-65030	Fuel Filter.....	FC-1810
Oil Filter Full Flow.....	0-5702	Oil Filter Full Flow.....	0-6503	Fuel/Water Separator.....	SFC-5705
H-70 SERIES F (LOADERS) 4-71		H-90 (LOADERS) WXLC-3		H95 (EXCAVATORS) CUMMINS	
Fuel Filter.....	F-6505	Hydraulic Oil Filter Transmission...	H-65030	Air Filter Secondary.....	A-5715
Fuel Filter Secondary.....	F-6502	H-90 SERIES B (LOADERS) 4-71		Air Filter Primary.....	A-5718
Hydraulic Oil Filter Transmission...	H-65030	Fuel Filter Secondary.....	F-6502	Fuel/Water Separator.....	SFC-5709-10
Oil Filter Full Flow.....	0-6503	Fuel Filter.....	F-6505	Fuel/Water Separator.....	SFC-5705
H-70 SERIES F (LOADERS) C-160		Hydraulic Oil Filter Transmission...	H-65030	Oil Filter By Pass.....	C-5718
Fuel Filter.....	F-5701	Oil Filter Full Flow.....	0-6503	Oil Filter Full Flow.....	C-5715
Hydraulic Oil Filter Transmission...	H-65030	H-90 SERIES B (LOADERS) C-175		HA250 (ARTICULATED TRUCKS) S/N: 60636	
Oil Filter Full Flow.....	0-5702	Fuel Filter.....	FC-5720	Fuel Filter.....	FC-5602
H71 (EXCAVATORS) 3406		Fuel Filter.....	FC-1303	Oil Filter Full Flow.....	C-5605
Air Filter Secondary.....	A-55291	Fuel Filter.....	F-5701	Oil Filter Full Flow.....	C-5715
Air Filter Set.....	A-55211-S	Fuel/Water Separator.....	SFC-5705	HA250-1 (ARTICULATED TRUCKS) S6D125-1	
Air Filter Primary.....	A-55211	Hydraulic Oil Filter Transmission...	H-65030	Fuel Filter.....	FC-5602
Fuel Filter.....	FC-5501	Oil Filter Full Flow.....	0-5702	Oil Filter Full Flow.....	C-5715
Fuel/Water Separator.....	SFC-5705	H-90 SERIES C (LOADERS) 6V-53		Oil Filter Full Flow.....	C-5605
Oil Filter Full Flow.....	C-5516	Fuel Filter Secondary.....	F-6502	Oil Filter Full Flow.....	C-5701
Oil Filter Full Flow.....	C-5523	Fuel Filter.....	F-6505	Oil Filter Full Flow.....	C-5715
H71 (EXCAVATORS) NT-855		Oil Filter Full Flow.....	0-6503	HA250-2 (ARTICULATED TRUCKS) S6D125-1	
Air Filter Secondary.....	A-5417	H-90 SERIES C (LOADERS) DT573		Fuel Filter.....	FC-5602
Air Filter Primary.....	A-5425	Fuel Filter Secondary.....	FC-54050	Oil Filter Full Flow.....	C-5605
Coolant Filter.....	WC-5705	H-90 SERIES C (LOADERS) DVT-573		Oil Filter Full Flow.....	C-5701
Fuel Filter.....	FC-5702	Fuel Filter Secondary.....	FC-54050	Oil Filter Full Flow.....	C-5715
Oil Filter By Pass.....	0-5704	H-90 SERIES C (LOADERS) V6R-180-C1		HA250-2A (ARTICULATED TRUCKS) S6D125-1	
Oil Filter Full Flow.....	C-5715	Fuel Filter.....	FC-5720	Fuel Filter.....	FC-5602
H-80 (LOADERS) DT429		Fuel Filter.....	FC-1303	Oil Filter Full Flow.....	C-5605
Fuel Filter.....	FC-1810	Fuel/Water Separator.....	SFC-5705	Oil Filter Full Flow.....	C-5701
Fuel/Water Separator.....	SFC-5705	Hydraulic Oil Filter Transmission...	H-65030	Oil Filter Full Flow.....	C-5715
H80A (LOADERS) DT429		Oil Filter Full Flow.....	0-5702	HA270 (DUMP TRUCKS) 65226	
Fuel Filter.....	FC-1810			Air Filter Secondary.....	A-5408
				Fuel Filter.....	FC-5602
				Hydraulic Oil Filter.....	H-7972

Sakura Filter

ENGINE APPLICATION

MODEL/APPLICATION	SAKURA NO	MODEL/APPLICATION	SAKURA NO	MODEL/APPLICATION	SAKURA NO
KOMATSU		KOMATSU		KOMATSU	
HA270 (DUMP TRUCKS) 65226		Oil Filter Full Flow.....	C-6203	Oil Filter Full Flow.....	C-6203
Oil Filter Full Flow.....	C-5715	Oil Filter Full Flow.....	C-6204	HC400 (CRANES) F6L912	
Oil Filter Full Flow.....	C-5701	HC170 (CRANES) F8L413F		Air Filter Primary.....	A-6211
Oil Filter Full Flow.....	C-5605	Fuel Filter.....	FC-5704	Air Filter Secondary.....	A-6302
HA270-1 (DUMP TRUCKS) S6D125-1		Oil Filter Full Flow.....	C-6204	Air Filter Primary.....	A-6207
Fuel Filter.....	FC-5602	Oil Filter Full Flow.....	C-6203	Air Filter Secondary.....	A-6212
Oil Filter Full Flow.....	C-5701	HC240 (CRANES) F10L413		Fuel Filter.....	FC-5704
Oil Filter Full Flow.....	C-5715	Fuel Filter.....	FC-6202	Oil Filter Full Flow.....	C-6204
Oil Filter Full Flow.....	C-5605	Fuel Filter.....	F-2604	Oil Filter Full Flow.....	C-6203
HA270-2 (DUMP TRUCKS) S6D125-1		Oil Filter Full Flow.....	C-6204	HC500 (CRANES) KTA-1150	
Fuel Filter.....	FC-5602	Oil Filter Full Flow.....	C-6203	Coolant Filter.....	WC-5705
Oil Filter Full Flow.....	C-5715	HC320 (CRANES) F12L413F		Fuel Filter.....	FC-5702
Oil Filter Full Flow.....	C-5605	Air Filter Secondary.....	A-6302	Oil Filter Full Flow.....	C-5715
Oil Filter Full Flow.....	C-5701	Air Filter Primary.....	A-6207	Oil Filter By Pass.....	O-5704
Oil Filter Full Flow.....	C-5715	Fuel Filter.....	F-2604	HC500 (CRANES) V-555	
HA270-2A (DUMP TRUCKS) S6D125-1		Fuel Filter.....	FC-5704	Coolant Filter.....	WC-5705
Fuel Filter.....	FC-5602	Fuel Filter.....	FC-6202	Fuel Filter.....	FC-5702
Oil Filter Full Flow.....	C-5701	Fuel Filter.....	F-2603	Oil Filter Full Flow.....	C-5715
Oil Filter Full Flow.....	C-5605	Oil Filter Full Flow.....	C-6204	Oil Filter By Pass.....	O-5704
Oil Filter Full Flow.....	C-5715	Oil Filter Full Flow.....	C-6203	HC65 (CRANES) F6L413F	
HAMMER (LOADERS) D226		HC320 (CRANES) F6L912		Fuel Filter.....	FC-5704
Oil Filter Full Flow.....	C-1914	Air Filter Primary.....	A-6207	Oil Filter Full Flow.....	C-6203
HB215LC-1/HYBRID (EXCAVATORS) SAA4D107E-1 , 2011		Air Filter Secondary.....	A-6212	Oil Filter Full Flow.....	C-6204
Air Filter Primary.....	A-5666	Air Filter Primary.....	A-6211	HC70 (CRANES) F6L413F	
Air Filter Secondary.....	A-5667	Air Filter Secondary.....	A-6302	Fuel Filter.....	FC-5704
Hydraulic Oil Filter.....	H-5646	Fuel Filter.....	FC-5704	Oil Filter Full Flow.....	C-6203
Hydraulic Oil Filter.....	H-5629	Oil Filter Full Flow.....	C-6204	Oil Filter Full Flow.....	C-6204
Hydraulic Breather.....	H-56610	Oil Filter Full Flow.....	C-6203	HC75 (CRANES) F6/8L413	
HB205LC-1 / HYBRID (EXCAVATORS) SAA4D107E-1-A		HC360 (CRANES) F12L413F		Fuel Filter.....	F-2603
Air Filter Secondary.....	A-5667	Air Filter Primary.....	A-6207	Fuel Filter.....	F-2604
Air Filter Primary.....	A-5666	Air Filter Secondary.....	A-6302	Fuel Filter.....	FC-5704
Hydraulic Oil Filter.....	H-5646	Fuel Filter.....	F-2603	Fuel Filter.....	FC-5704
Hydraulic Oil Filter.....	H-5629	Fuel Filter.....	FC-6202	Fuel Filter.....	FC-5704
Hydraulic Breather.....	H-56610	Fuel Filter.....	FC-5704	Oil Filter Full Flow.....	C-6204
HC120 (CRANES) F10L413		Fuel Filter.....	F-2604	Oil Filter Full Flow.....	C-6203
Fuel Filter.....	FC-6202	Oil Filter Full Flow.....	C-6204	HD1200M (DUMP TRUCKS) KT2300	
Fuel Filter.....	F-2603	Oil Filter Full Flow.....	C-6203	Air Filter Secondary.....	A-5630
Fuel Filter.....	F-2604	HC40 (CRANES) F6/8L413		Air Filter Set.....	A-5629-S
Oil Filter Full Flow.....	C-6204	Fuel Filter.....	F-2603	Air Filter Primary.....	A-5629
Oil Filter Full Flow.....	C-6203	Fuel Filter.....	F-2604	Coolant Filter.....	WC-5705
HC120 (CRANES) F6/8L413		Fuel Filter.....	FC-5704	Coolant Filter.....	WC-5711
Fuel Filter.....	F-2603	Oil Filter Full Flow.....	C-6204	Fuel Filter.....	FC-5703
Fuel Filter.....	FC-5704	Oil Filter Full Flow.....	C-6203	Fuel/Water Separator.....	SFC-5707
Fuel Filter.....	F-2604	HC400 (CRANES) F12L413F		Hydraulic Oil Filter.....	H-5606
Oil Filter Full Flow.....	C-6203	Air Filter Secondary.....	A-6302	Oil Filter Full Flow.....	C-5715
Oil Filter Full Flow.....	C-6204	Air Filter Primary.....	A-6207	Oil Filter By Pass.....	C-5718
HC170 (CRANES) F6L912		Fuel Filter.....	F-2603	HD1200M (DUMP TRUCKS) KTA-2300	
Fuel Filter.....	FC-5704	Fuel Filter.....	F-2604	Air Filter Set.....	A-5629-S
HC170 (CRANES) F6L912		Fuel Filter.....	FC-6202	Air Filter Primary.....	A-5629
Fuel Filter.....	FC-5704	Fuel Filter.....	FC-5704	Air Filter Secondary.....	A-5630
Fuel Filter.....	FC-5704	Oil Filter Full Flow.....	C-6204	Coolant Filter.....	WC-5705
Fuel Filter.....	FC-5704	HC320 (CRANES) F12L413F		Coolant Filter.....	WC-5711
Fuel Filter.....	FC-5704	Air Filter Secondary.....	A-6302		
Fuel Filter.....	FC-5704	Air Filter Primary.....	A-6207		
Fuel Filter.....	FC-5704	Fuel Filter.....	F-2603		
Fuel Filter.....	FC-6202	Fuel Filter.....	F-2604		
Fuel Filter.....	FC-5704	Oil Filter Full Flow.....	C-6204		
Fuel Filter.....	FC-5704				

MODEL/APPLICATION	SAKURA NO	MODEL/APPLICATION	SAKURA NO	MODEL/APPLICATION	SAKURA NO
KOMATSU		KOMATSU		KOMATSU	
HD1200M (DUMP TRUCKS) KTA-2300		HD1500-7 (DUMP TRUCKS) KOMATSU SDA16V159E-2		Air Filter Primary.....	A-6113
Fuel Filter.....	FC-5703	Hydraulic Oil Filter.....	H-56740	Fuel Filter.....	FC-5602
Fuel/Water Separator.....	SFC-5707			Hydraulic Oil Filter.....	H-5609
Hydraulic Oil Filter.....	H-5606	HD1500-7 (DUMP TRUCKS) SDA12V160		Hydraulic Oil Filter.....	H-5611
Oil Filter By Pass.....	C-5718	Air Filter Secondary.....	A-7902	Oil Filter Full Flow.....	C-5605
Oil Filter Full Flow.....	C-5715	Fuel Filter.....	FC-57290	Oil Filter Full Flow.....	C-5701
				Oil Filter Full Flow.....	C-5715
HD1200M-1 (DUMP TRUCKS) S/N: 1501		HD180-2 / 2 (DUMP TRUCKS) NTO-6		HD205-3 (DUMP TRUCKS) S6D125-1/1003	
Air Filter Primary.....	A-9218	Fuel Filter.....	F-5601	Air Filter Primary.....	A-6113
Air Filter Secondary.....	A-9205	Hydraulic Oil Filter.....	H-5620	Air Filter Secondary.....	A-5408
Air Filter Set.....	A-9218-S	Hydraulic Oil Filter.....	H-5611	Fuel Filter.....	FC-5602
Coolant Filter.....	WC-6901	Oil Filter Full Flow.....	O-5603	Hydraulic Oil Filter.....	H-5609
Fuel Filter.....	FC-5703	Oil Filter By Pass.....	O-5704	Oil Filter Full Flow.....	C-5715
Fuel/Water Separator.....	SFC-5707			Oil Filter Full Flow.....	C-5605
Hydraulic Oil Filter.....	H-85680	HD180-4 / 956 (DUMP TRUCKS) NTO-6-B		Oil Filter Full Flow.....	C-5701
Hydraulic Oil Filter.....	H-7911	Air Filter Secondary.....	A-5408		
Oil Filter Full Flow.....	C-5605	Fuel Filter.....	FC-5602	HD255-5 (DUMP TRUCKS) HD255-5	
Oil Filter Full Flow.....	C-5701	Hydraulic Oil Filter.....	H-5620	Fuel Filter.....	FC-5610
Oil Filter Full Flow.....	C-5715	Hydraulic Oil Filter.....	H-5611		
		Oil Filter By Pass.....	O-5704	HD255-5 (DUMP TRUCKS)	
HD1600M-1 (DUMP TRUCKS) KTA-3067/1005		Oil Filter Full Flow.....	C-5605	Air Filter Secondary.....	A-5408
Air Filter Set.....	A-9218-S	Oil Filter Full Flow.....	C-5701	Air Filter Primary.....	A-6113
Air Filter Secondary.....	A-9205	Oil Filter Full Flow.....	C-5701	Hydraulic Oil Filter.....	H-5609
Air Filter Primary.....	A-9218	Oil Filter Full Flow.....	C-5715	Hydraulic Oil Filter.....	H-5618
Coolant Filter.....	WC-5705			Oil Filter Full Flow.....	C-5701
Fuel Filter.....	FC-5703	HD200-2 (DUMP TRUCKS) NTC-743		Oil Filter Full Flow.....	C-5605
Fuel/Water Separator.....	SFC-5707	Fuel Filter.....	FC-5606	Oil Filter Full Flow.....	C-5715
Hydraulic Oil Filter.....	H-7911				
Hydraulic Oil Filter.....	H-85680	HD200-2 (DUMP TRUCKS) NTC-743/1774		HD255-5 (DUMP TRUCKS) SA6D125E-2/1001	
Oil Filter Full Flow.....	C-5701	Air Filter Secondary.....	A-5408	Air Filter Primary.....	A-10134
Oil Filter By Pass.....	C-5718	Fuel Filter.....	FC-5602	Air Filter Primary.....	A-1013
Oil Filter Full Flow.....	C-5605	Hydraulic Oil Filter.....	H-5611	Air Filter Secondary.....	A-5631
		Hydraulic Oil Filter.....	H-5620	Air Filter Set.....	A-1841-S
HD180-4 (DUMP TRUCKS) NTO-6		Oil Filter Full Flow.....	C-5701	Fuel Filter.....	FC-5602
Air Filter Secondary.....	A-5408	Oil Filter Full Flow.....	O-5603	Hydraulic Oil Filter.....	H-5618
Air Filter Primary.....	A-6113	Oil Filter Full Flow.....	C-5715	Hydraulic Oil Filter.....	H-5609
Fuel Filter.....	F-5601	Oil Filter By Pass.....	O-5704	Oil Filter Full Flow.....	C-5605
Fuel Filter.....	FC-5602	Oil Filter Full Flow.....	C-5605	Oil Filter Full Flow.....	C-5701
Hydraulic Oil Filter.....	H-5611			Oil Filter Full Flow.....	C-5715
Hydraulic Oil Filter.....	H-5620	HD200-2 (DUMP TRUCKS) NTC-743/1002			
Oil Filter Full Flow.....	C-5701	Air Filter Secondary.....	A-5408	HD320-2 (DUMP TRUCKS) NTA-855	
Oil Filter Full Flow.....	C-5715	Air Filter Primary.....	A-6113	Air Filter Secondary.....	A-5408
Oil Filter Full Flow.....	O-5603	Fuel Filter.....	F-5601	Coolant Filter.....	WC-5711
Oil Filter By Pass.....	O-5704	Fuel Filter.....	FC-5602	Fuel Filter.....	FC-5602
Oil Filter Full Flow.....	C-5605	Hydraulic Oil Filter.....	H-5611	Hydraulic Oil Filter.....	H-5610
		Hydraulic Oil Filter.....	H-5620	Hydraulic Oil Filter.....	H-56600
HD180-4 (DUMP TRUCKS) NTO-6-B		Oil Filter Full Flow.....	O-5603	Oil Filter By Pass.....	O-5704
Fuel Filter.....	FC-5606	Oil Filter By Pass.....	O-5704	Oil Filter Full Flow.....	C-5715
		Oil Filter Full Flow.....	C-5605	Oil Filter Full Flow.....	C-5701
HD1500-5 (DUMP TRUCKS) QSK45		Oil Filter Full Flow.....	C-5701	Oil Filter Full Flow.....	C-5605
Coolant Filter.....	WC-5712	Oil Filter Full Flow.....	C-5715		
Coolant Filter.....	WC-5713			HD320-3 (DUMP TRUCKS) CUMMINS NTA-855	
Fuel/Water Separator.....	SFC-5601-02	HD200D-3 (DUMP TRUCKS) S6D125-1		Fuel Filter.....	FC-5606
		Fuel Filter.....	FC-5606		
HD1500-5 (DUMP TRUCKS) SDA12V160		HD200D-3 (DUMP TRUCKS) S6D125-1/1001		HD320-3 (DUMP TRUCKS) NTA-855	
Air Filter Secondary.....	A-7902	Air Filter Secondary.....	A-5408	Coolant Filter.....	WC-5711
				Fuel Filter.....	FC-5602

MODEL/APPLICATION	SAKURA NO	MODEL/APPLICATION	SAKURA NO	MODEL/APPLICATION	SAKURA NO
KOMATSU		KOMATSU		KOMATSU	
HD320-3 (DUMP TRUCKS) NTA-855		HD325-6 (DUMP TRUCKS)		Hydraulic Oil Filter.....	H-7911
Hydraulic Oil Filter.....	H-5609	Coolant Filter.....	WC-56010	Oil Filter Full Flow.....	C-5715
Oil Filter By Pass.....	O-5704	Fuel Filter.....	FC-5703	Oil Filter Full Flow.....	C-5701
Oil Filter Full Flow.....	C-5605	Fuel/Water Separator.....	SFC-5707	Oil Filter Full Flow.....	C-5605
Oil Filter Full Flow.....	C-5715	Hydraulic Oil Filter.....	H-5618		
Oil Filter Full Flow.....	C-5701	Hydraulic Oil Filter.....	H-5609	HD465-5 (DUMP TRUCKS) SAG6D170-1	
		Oil Filter Full Flow.....	C-5715	Air Filter Secondary.....	A-6011
		Oil Filter Full Flow.....	C-5701	Air Filter Primary.....	A-6010
		Oil Filter Full Flow.....	C-5605	Coolant Filter.....	WC-56010
HD320-3 (DUMP TRUCKS) NTA-855/2501		HD325-6 (DUMP TRUCKS) SAG6D140		Fuel Filter.....	FC-5606
Air Filter Primary.....	A-6113	Air Filter Primary.....	A-1013	Fuel Filter.....	FC-5602
Air Filter Secondary.....	A-5408	Air Filter Secondary.....	A-5631	Hydraulic Oil Filter.....	H-5609
Coolant Filter.....	WC-56010	Air Filter Primary.....	A-10134	Hydraulic Oil Filter.....	H-5618
Fuel Filter.....	FC-5602	Air Filter Secondary.....	A-5408	Oil Filter Full Flow.....	C-5701
Hydraulic Oil Filter.....	H-5609	Air Filter Set.....	A-1841-S	Oil Filter Full Flow.....	C-5605
Oil Filter By Pass.....	O-5704	Air Filter Primary.....	A-6113	Oil Filter Full Flow.....	C-5715
Oil Filter Full Flow.....	C-5715	Coolant Filter.....	WC-56010		
Oil Filter Full Flow.....	C-5701	Fuel Filter.....	FC-5703	HD405 (DUMP TRUCKS)	
Oil Filter Full Flow.....	C-5605	Fuel/Water Separator.....	SFC-5707	Coolant Filter.....	WC-6901
		Hydraulic Oil Filter.....	H-5618	Fuel/Water Separator.....	SFC-5601-02
HD325-2 (DUMP TRUCKS) CUMMINS KT-1150		Hydraulic Oil Filter.....	H-5609		
Fuel Filter.....	FC-5721	Oil Filter Full Flow.....	C-5701	HD405-6 (DUMP TRUCKS) SAA6D140E	
		Oil Filter Full Flow.....	C-5605	Air Filter Primary.....	A-10134
HD325-2 (DUMP TRUCKS) KT-1150		Oil Filter Full Flow.....	C-5715	Air Filter Primary.....	A-1013
Air Filter Secondary.....	A-5408			Air Filter Secondary.....	A-5631
Coolant Filter.....	WC-5705	HD325-7 (DUMP TRUCKS) KOMATSU SAA6D140E-3		Air Filter Set.....	A-1841-S
Fuel Filter.....	FC-5702	Hydraulic Oil Filter.....	H-56580	Coolant Filter.....	WC-56010
Hydraulic Oil Filter.....	H-5610	HD325-7 (DUMP TRUCKS) KOMATSU SAA6D140E-5D-01		Fuel Filter.....	FC-5703
Hydraulic Oil Filter.....	H-56600	Hydraulic Oil Filter.....	H-56580	Fuel/Water Separator.....	SFC-5707
Oil Filter By Pass.....	O-5704	HD325-7 (DUMP TRUCKS) SAA6D140E-5		Hydraulic Oil Filter.....	H-5609
Oil Filter Full Flow.....	C-5715	Air Filter Primary.....	A-5558M	Oil Filter Full Flow.....	C-5715
		Air Filter Secondary.....	A-5559	Oil Filter Full Flow.....	C-5701
HD325-3 (DUMP TRUCKS) KT-1150		Air Filter Set.....	A-5558M-S	Oil Filter Full Flow.....	C-5605
Air Filter Secondary.....	A-5408	Fuel/Water Separator Secondary..	SFC-5611-10B		
Coolant Filter.....	WC-5705	Fuel/Water Separator Secondary...	SFC-5611-10	HD405-7 (DUMP TRUCKS) S/N: 7365 , 2008	
Fuel Filter.....	FC-5702	Hydraulic Oil Filter.....	H-85680	Air Filter Set.....	A-5558M-S
Hydraulic Oil Filter.....	H-5609	Hydraulic Oil Filter.....	H-5618	Air Filter Primary.....	A-5558M
Oil Filter Full Flow.....	C-5715	Hydraulic Oil Filter.....	H-5609	Air Filter Secondary.....	A-5559
Oil Filter By Pass.....	O-5704			Air Filter Secondary.....	A-5610
		HD325-7 (DUMP TRUCKS) SAA6D140E-5		Coolant Filter.....	WC-56010
HD325-3 (DUMP TRUCKS) KT-1150/1501		Air Filter Primary.....	A-5558M		
Air Filter Secondary.....	A-5408	Air Filter Secondary.....	A-5559	HD455-1 (DUMP TRUCKS) VTA-1710	
Air Filter Primary.....	A-6113	Air Filter Set.....	A-5558M-S	Air Filter Primary.....	A-6113
Coolant Filter.....	WC-5705	Fuel/Water Separator Secondary..	SFC-5611-10B	Air Filter Secondary.....	A-5408
Fuel Filter.....	FC-5702	Fuel/Water Separator Secondary...	SFC-5611-10	Air Filter Secondary.....	A-5610
Hydraulic Oil Filter.....	H-5609	Hydraulic Oil Filter.....	H-85680	Air Filter Primary.....	A-5614
Oil Filter Full Flow.....	C-5715	Hydraulic Oil Filter.....	H-5618	Fuel Filter.....	FC-5703
Oil Filter By Pass.....	O-5704	Hydraulic Oil Filter.....	H-5609	Fuel/Water Separator.....	SFC-5707
				Fuel/Water Separator.....	SFC-5601-02
HD325-5 (DUMP TRUCKS) S/N: 2001		HD375-6 (DUMP TRUCKS)		Oil Filter By Pass.....	C-5718
Air Filter Secondary.....	A-5408	Air Filter Primary.....	A-5558M	Oil Filter Full Flow.....	C-5715
Coolant Filter.....	WC-6901	Air Filter Secondary.....	A-5559		
Fuel Filter.....	FC-5703	Air Filter Set.....	A-5558M-S	HD460 (DUMP TRUCKS) VT-1710	
Fuel/Water Separator.....	SFC-5707	HD325-7R (DUMP TRUCKS) KOMATSU SAA6D140E-5DR-W		Air Filter Secondary.....	A-5610
Hydraulic Oil Filter.....	H-5609	Hydraulic Oil Filter.....	H-56580	Coolant Filter.....	WC-6901
Oil Filter Full Flow.....	C-5701	HD465-5 (DUMP TRUCKS)		Fuel Filter.....	FC-5703
Oil Filter Full Flow.....	C-5715	Air Filter Primary.....	A-6010	Fuel/Water Separator.....	SFC-5707
Oil Filter Full Flow.....	C-5605	Air Filter Secondary.....	A-6011	Hydraulic Oil Filter.....	H-56600
		Coolant Filter.....	WC-6901	Hydraulic Oil Filter.....	H-5609
		Hydraulic Oil Filter.....	H-85680	Hydraulic Oil Filter.....	H-5609
		Hydraulic Oil Filter.....	H-5618	Hydraulic Oil Filter.....	H-5610

MODEL/APPLICATION	SAKURA NO
KOMATSU	
HD460 (DUMP TRUCKS) VT-1710	
Oil Filter Full Flow.....	C-5605
Oil Filter Full Flow.....	C-5701
Oil Filter Full Flow.....	C-5715
Oil Filter By Pass.....	O-5704
HD460-1 (DUMP TRUCKS) VT-1710	
Coolant Filter.....	WC-5711
Fuel Filter.....	FC-5703
Fuel/Water Separator.....	SFC-5707
Hydraulic Oil Filter.....	H-56600
Hydraulic Oil Filter.....	H-5610
Oil Filter By Pass.....	O-5704
Oil Filter Full Flow.....	C-5715
HD465 (DUMP TRUCKS)	
Air Filter Primary.....	A-5629
Air Filter Secondary.....	A-5630
Air Filter Set.....	A-5629-S
Fuel Filter.....	FC-5602
Oil Filter Full Flow.....	C-5701
Oil Filter Full Flow.....	C-5715
Oil Filter Full Flow.....	C-5605
HD465 (DUMP TRUCKS) SAA6D170E	
Fuel Filter.....	FC-5602
Oil Filter Full Flow.....	C-7005
Oil Filter Full Flow.....	C-5731
Oil Filter By Pass.....	C-5718
HD465-7 (DUMP TRUCKS) KOMATSU SAA6D170E-5	
Fuel Filter.....	F-56050
HD465-7 (DUMP TRUCKS) SAA6D170E	
Air Filter Primary.....	A-8665M
Air Filter Secondary.....	A-8580
Coolant Filter.....	WC-56010
Hydraulic Oil Filter.....	H-5618
Hydraulic Oil Filter.....	H-85680
Oil Filter Full Flow.....	C-5701
Oil Filter Full Flow.....	C-5715
Oil Filter Full Flow.....	C-5605
HD465-7E0 (DUMP TRUCKS) SAA6D170E-5	
Air Filter Secondary.....	A-8580
Air Filter Primary.....	A-8665M
Coolant Filter.....	WC-56010
Fuel/Water Separator Secondary..	SFC-5611-10
Fuel/Water Separator Secondary..	SFC-5611-10B
Hydraulic Oil Filter.....	H-5618
Hydraulic Oil Filter.....	H-85680
HD465-7R (DUMP TRUCKS) KOMATSU SAA6D170E-5BR-W	
Hydraulic Oil Filter.....	H-56580
HD605 (DUMP TRUCKS)	

MODEL/APPLICATION	SAKURA NO
KOMATSU	
Coolant Filter.....	WC-56010
Fuel Filter.....	FC-5602
Oil Filter Full Flow.....	C-5605
Oil Filter Full Flow.....	C-5701
Oil Filter By Pass.....	C-5718
Oil Filter Full Flow.....	C-5715
HD605-5 (DUMP TRUCKS) KOMATSU SAA6D170E	
Hydraulic Oil Filter.....	H-56740
HD605-5 (DUMP TRUCKS) SA6D170E	
Air Filter Secondary.....	A-6011
Air Filter Primary.....	A-6010
Coolant Filter.....	WC-56010
Fuel Filter.....	FC-5602
Hydraulic Oil Filter.....	H-7911
Hydraulic Oil Filter.....	H-85680
Oil Filter Full Flow.....	C-5605
Oil Filter Full Flow.....	C-5701
Oil Filter By Pass.....	C-5718
Oil Filter Full Flow.....	C-5715
HD605-5 (DUMP TRUCKS) SAA6D170E	
Air Filter Secondary.....	A-6011
Air Filter Primary.....	A-6010
Coolant Filter.....	WC-56010
Fuel Filter.....	FC-5602
Hydraulic Oil Filter.....	H-7911
Hydraulic Oil Filter.....	H-85680
Oil Filter Full Flow.....	C-5701
Oil Filter Full Flow.....	C-5718
Oil Filter By Pass.....	C-5718
Oil Filter Full Flow.....	C-5605
Oil Filter Full Flow.....	C-5715
HD605-7 (DUMP TRUCKS) KOMATSU SAA6D170E-3F-8	
Hydraulic Oil Filter.....	H-56580
HD605-7 (DUMP TRUCKS) SAA6D170E	
Air Filter Primary.....	A-6010
Air Filter Secondary.....	A-6011
Cabin Air Filter.....	CA-5676
Fuel Filter.....	FC-5602
Fuel/Water Separator.....	SFC-5601-02
Hydraulic Oil Filter.....	H-7911
Hydraulic Oil Filter.....	H-85680
Oil Filter Full Flow.....	C-5701
Oil Filter Full Flow.....	C-5715
Oil Filter By Pass.....	C-5718
Oil Filter Full Flow.....	C-5605
HD605-7E0 (DUMP TRUCKS) SAA6D170E-5	
Air Filter Secondary.....	A-8580
Air Filter Primary.....	A-8665M
Coolant Filter.....	WC-56010
Hydraulic Oil Filter.....	H-5618
Hydraulic Oil Filter.....	H-85680
HD680-2 (DUMP TRUCKS) VTA-1710	

MODEL/APPLICATION	SAKURA NO
KOMATSU	
Air Filter Secondary.....	A-5610
Air Filter Primary.....	A-5614
Coolant Filter.....	WC-5711
Fuel Filter.....	FC-5703
Fuel/Water Separator.....	SFC-5707
Oil Filter By Pass.....	O-5704
Oil Filter Full Flow.....	C-5715
HD785-7 (DUMP TRUCKS) SAA12V140E-3 , 2007	
Air Filter Secondary.....	A-8580
Air Filter Primary.....	A-8665M
Cabin Air Filter.....	CA-5676
Coolant Filter.....	WC-56010
Fuel/Water Separator Secondary..	SFC-5611-10B
Fuel/Water Separator Secondary..	SFC-5611-10
Hydraulic Oil Filter.....	H-85680
Hydraulic Oil Filter.....	H-5618
HD785-7 (DUMP TRUCKS) KOMATSU SAA12V140E-3B-02	
Hydraulic Oil Filter.....	H-56580
HD785 (DUMP TRUCKS) KTA-2300	
Air Filter Set.....	A-5629-S
Air Filter Primary.....	A-5629
Air Filter Secondary.....	A-5630
Coolant Filter.....	WC-5705
Coolant Filter.....	WC-5711
Fuel Filter.....	FC-5703
Fuel/Water Separator.....	SFC-5707
Hydraulic Oil Filter.....	H-5606
Oil Filter By Pass.....	C-5718
Oil Filter Full Flow.....	C-5715
HD785-1 (DUMP TRUCKS) KT2300	
Air Filter Secondary.....	A-5630
Air Filter Set.....	A-5629-S
Air Filter Primary.....	A-5629
Coolant Filter.....	WC-5705
Fuel Filter.....	FC-5703
Fuel/Water Separator.....	SFC-5707
Hydraulic Oil Filter.....	H-5609
Hydraulic Oil Filter.....	H-85680
Oil Filter By Pass.....	O-5704
Oil Filter Full Flow.....	C-5605
Oil Filter Full Flow.....	C-5701
Oil Filter Full Flow.....	C-5715
Oil Filter By Pass.....	C-5718
HD785-1 (DUMP TRUCKS) KTA-2300	
Air Filter Set.....	A-5629-S
Air Filter Primary.....	A-5629
Air Filter Secondary.....	A-5630
Coolant Filter.....	WC-5705
Fuel Filter.....	FC-5703
Fuel/Water Separator.....	SFC-5707
Hydraulic Oil Filter.....	H-85680
Hydraulic Oil Filter.....	H-7911
Oil Filter By Pass.....	O-5704
Oil Filter Full Flow.....	C-5605
Oil Filter Full Flow.....	C-5701
Oil Filter Full Flow.....	C-5715
Oil Filter By Pass.....	C-5718

MODEL/APPLICATION	SAKURA NO	MODEL/APPLICATION	SAKURA NO	MODEL/APPLICATION	SAKURA NO
KOMATSU		KOMATSU		KOMATSU	
HD785-1 (DUMP TRUCKS) KTA-2300		HD7855LC (DUMP TRUCKS) QST30 SERIES		HM350-1 (ARTICULATED TRUCKS) KOMATSU SAA6D140E-3H-8	
Oil Filter Full Flow.....	C-5605	Air Filter Secondary.....	A-6011	Hydraulic Oil Filter.....	H-56580
Oil Filter Full Flow.....	C-5701	Air Filter Primary.....	A-6010		
Oil Filter Full Flow.....	C-5715	Fuel/Water Separator.....	SFC-5601-02	HM350-1 (ARTICULATED TRUCKS) KOMATSU SAA6D140E-3J-8	
Oil Filter By Pass.....	O-5704	Oil Filter Full Flow.....	C-57430	Hydraulic Oil Filter.....	H-56580
Oil Filter By Pass.....	C-5718	Oil Filter Combination.....	C-5710		
HD785-2 (DUMP TRUCKS) SA8V1710		HD985-3 (DUMP TRUCKS) SA12V140-1		HM350-1 (ARTICULATED TRUCKS) SAA6D140E	
Air Filter Set.....	A-5629-S	Air Filter Secondary.....	A-6011	Air Filter Primary.....	A-8665M
Air Filter Primary.....	A-5629	Air Filter Primary.....	A-6010	Air Filter Secondary.....	A-8580
Air Filter Secondary.....	A-5630	Coolant Filter.....	WC-6901	Cabin Air Filter.....	CA-56100
Fuel Filter.....	FC-5703	Fuel Filter.....	FC-5703	Cabin Air Filter Set.....	CA-5601-S
Fuel/Water Separator.....	SFC-5707	Fuel/Water Separator.....	SFC-5707	Fuel/Water Separator.....	SFC-5601-02
Hydraulic Oil Filter.....	H-7911	Hydraulic Oil Filter.....	H-7911	Hydraulic Oil Filter.....	H-85680
Hydraulic Oil Filter.....	H-85680	Hydraulic Oil Filter.....	H-85680		
Hydraulic Oil Filter.....	H-5609	Hydraulic Oil Filter.....	H-5618	HM350-1 (ARTICULATED TRUCKS) SAA6D140E-3	
Oil Filter Full Flow.....	C-5701	Oil Filter By Pass.....	C-5718	Coolant Filter.....	WC-5708
Oil Filter Full Flow.....	C-5715	Oil Filter Full Flow.....	C-5605	Fuel/Water Separator.....	SFC-5601-02
Oil Filter Full Flow.....	C-5605	Oil Filter Full Flow.....	C-5701		
HD785-3 (DUMP TRUCKS) SA12V140		HF (LOADERS) D-2300		HM300-2 (ARTICULATED TRUCKS) SAA6D125E-5 , 2006	
Air Filter Secondary.....	A-6011	Fuel Filter.....	FC-5103	Cabin Air Filter.....	CA-5602
Air Filter Primary.....	A-6010			Cabin Air Filter.....	CA-5676
Coolant Filter.....	WC-56010	HFC (LOADERS) D-2300		Fuel/Water Separator Secondary..	SFC-5611-10B
Fuel Filter.....	FC-5703	Fuel Filter.....	FC-5103	Fuel/Water Separator Secondary..	SFC-5611-10
Fuel/Water Separator.....	SFC-5707			Hydraulic Oil Filter.....	H-5609
Hydraulic Oil Filter.....	H-7911	HFH (LOADERS) D-2300		Hydraulic Oil Filter.....	H-85680
Hydraulic Oil Filter.....	H-85680	Fuel Filter.....	FC-5103		
Hydraulic Oil Filter.....	H-5618			HM300-2 (ARTICULATED TRUCKS) KOMATSU SAA6D125E-5B-02	
Oil Filter Full Flow.....	C-5605	HH (LOADERS) DJXH		Hydraulic Oil Filter.....	H-56580
Oil Filter Full Flow.....	C-5701	Hydraulic Oil Filter Transmission...	H-65030		
Oil Filter By Pass.....	C-5718			HM350-2 (ARTICULATED TRUCKS) SAA6D140E-5 , 2006	
Oil Filter Full Flow.....	C-5715	HM300 (ARTICULATED TRUCKS)		Cabin Air Filter.....	CA-5676
HD785-5 (DUMP TRUCKS) SA12V140		Air Filter Secondary.....	A-8580	Cabin Air Filter.....	CA-5602
Air Filter Primary.....	A-6010	Air Filter Primary.....	A-8665M	Fuel/Water Separator Secondary..	SFC-5611-10B
Air Filter Secondary.....	A-6011	Cabin Air Filter.....	CA-56100	Fuel/Water Separator Secondary..	SFC-5611-10
Coolant Filter.....	WC-56010	Cabin Air Filter Set.....	CA-5601-S	Hydraulic Oil Filter.....	H-85680
Fuel Filter.....	FC-5703	Fuel/Water Separator Secondary..	SFC-5611-10B		
Fuel/Water Separator.....	SFC-5707	Fuel/Water Separator Secondary..	SFC-5611-10	HM350-2 (ARTICULATED TRUCKS) KOMATSU SAA6D140E-5E-01	
Hydraulic Oil Filter.....	H-5618	Hydraulic Oil Filter.....	H-85680	Hydraulic Oil Filter.....	H-56580
Hydraulic Oil Filter.....	H-85680	Hydraulic Oil Filter.....	H-5609		
Hydraulic Oil Filter.....	H-7911			HM300-1 (ARTICULATED TRUCKS) KOMATSU SAA6D140E-3H-8	
Oil Filter By Pass.....	C-5718	HM350 (ARTICULATED TRUCKS) KOMATSU SAA6D140E		Fuel Filter.....	FC-5612
Oil Filter Full Flow.....	C-5701	Fuel Filter.....	FC-5622		
Oil Filter Full Flow.....	C-5605			HM300-1 (ARTICULATED TRUCKS) KOMATSU SAA6D125E-3G-8M	
Oil Filter Full Flow.....	C-5715	HM350 (ARTICULATED TRUCKS) SAA6D140E		Fuel Filter.....	FC-5612
HD7855LC (DUMP TRUCKS) SAA12V140ZE-2 , 2011		Air Filter Secondary.....	A-8580		
Air Filter Secondary.....	A-6011	Air Filter Primary.....	A-8665M	HM300-1 (ARTICULATED TRUCKS) SAA6D125E	
Air Filter Primary.....	A-6010	Cabin Air Filter Set.....	CA-5601-S	Air Filter Primary.....	A-8665M
Coolant Filter.....	WC-5713	Fuel/Water Separator.....	SFC-5601-02	Air Filter Secondary.....	A-8580
Fuel Filter.....	FC-5703	Hydraulic Oil Filter.....	H-85680	Hydraulic Oil Filter.....	H-5609
Fuel/Water Separator.....	SFC-5707			Oil Filter Full Flow.....	C-5715
Hydraulic Oil Filter.....	H-85680	HM350 (ARTICULATED TRUCKS) SAA6D140E-2		Oil Filter Full Flow.....	C-5701
Hydraulic Oil Filter.....	H-7911	Coolant Filter.....	WC-5708	Oil Filter Full Flow.....	C-5605
Oil Filter Full Flow.....	C-5715				

MODEL/APPLICATION	SAKURA NO	MODEL/APPLICATION	SAKURA NO	MODEL/APPLICATION	SAKURA NO
KOMATSU		KOMATSU		KOMATSU	
HM300-3 (ARTICULATED TRUCKS) SAA6D125E-6 , 2012		JH63-2 (LOADERS) 6B155		Fuel Filter.....	F-1303
Air Filter Primary.....	A-8665M	Air Filter Primary.....	AS-1024	JH90EA (LOADERS) V170	
Air Filter Secondary.....	A-8580	Air Filter Set.....	AS-1024-S	Fuel Filter.....	F-1303
Cabin Air Filter.....	CA-5676	Air Filter Secondary.....	A-6009	JH90EH (LOADERS) DVT-573B	
Hydraulic Oil Filter.....	H-5629	Coolant Filter.....	WC-5707	Fuel Filter Secondary.....	FC-54050
Hydraulic Oil Filter.....	H-5646	Oil Filter Full Flow.....	C-5614	Fuel Filter.....	FC-7933
HM400-2 (ARTICULATED TRUCKS) SAA6D140E-5 , 2006		JH65C (LOADERS) DA640		Fuel/Water Separator.....	SFC-5705
Cabin Air Filter.....	CA-5676	Air Filter Secondary.....	A-7608	Oil Filter Full Flow.....	C-5402
Cabin Air Filter.....	CA-5602	Air Filter Set.....	A-5660-S	JH90EV (LOADERS) V-903	
Fuel/Water Separator Secondary..	SFC-5611-10B	Air Filter Primary.....	A-5413	Coolant Filter.....	WC-5705
Fuel/Water Separator Secondary..	SFC-5611-10	Fuel Filter.....	F-1303	Fuel Filter.....	F-5701
Hydraulic Oil Filter.....	H-85680	JH65C-2 (LOADERS) DA640		Oil Filter Full Flow.....	O-5603
HM400-2 (ARTICULATED TRUCKS) KOMATSU SAA6D140E-5C-01		Air Filter Secondary.....	A-7608	Oil Filter By Pass.....	O-5704
Hydraulic Oil Filter.....	H-56580	Fuel Filter.....	F-1303	JV100-1 (COMPACTORS)	
HM400-1 (ARTICULATED TRUCKS) SAA6D140E-3 , 2008		JH65CH (LOADERS) DT414		Air Filter Secondary.....	A-5606
Cabin Air Filter.....	CA-56100	Fuel/Water Separator.....	SFC-5705	Air Filter Primary.....	A-5605
Fuel/Water Separator Secondary..	SFC-5611-10	JH65CN (LOADERS) C464		Air Filter Set.....	A-5604-S
Fuel/Water Separator Secondary..	SFC-5611-10B	Air Filter Primary.....	A-5413	Hydraulic Oil Filter.....	H-5611
Hydraulic Oil Filter.....	H-85680	Air Filter Set.....	A-5660-S	Oil Filter Full Flow.....	C-5614
HM400-1 (ARTICULATED TRUCKS) KOMATSU SAA6D140E-3B-8		Air Filter Secondary.....	A-7608	JV100A-1 (COMPACTORS) S6D105	
Hydraulic Oil Filter.....	H-56580	Fuel Filter.....	F-5701	Air Filter Primary.....	A-5605
HM400-3 (ARTICULATED TRUCKS) SAA6D140E-6 , 2012		Oil Filter By Pass.....	O-5704	Air Filter Set.....	A-5604-S
Air Filter Secondary.....	A-8580	Oil Filter Full Flow.....	O-5702	Air Filter Secondary.....	A-5606
Air Filter Primary.....	A-8665M	JH65CV (LOADERS) CUMMINS V-504		Hydraulic Oil Filter.....	H-5611
Hydraulic Oil Filter.....	H-5646	Fuel Filter.....	FC-5721	Oil Filter Full Flow.....	C-5614
Hydraulic Oil Filter.....	H-5629	JH65CV (LOADERS) V-504		JV100WA-1 (COMPACTORS) S6D105	
HM400-3 (ARTICULATED TRUCKS) SAA6D140E-5/STAGE IIIB/TIER 4 , 2012		Air Filter Secondary.....	A-7608	Air Filter Primary.....	A-5605
Air Filter Primary.....	A-8665M	Coolant Filter.....	WC-5711	Air Filter Set.....	A-5604-S
Air Filter Secondary.....	A-8580	Fuel Filter.....	FC-5720	Air Filter Secondary.....	A-5606
Hydraulic Oil Filter.....	H-5646	Fuel/Water Separator.....	SFC-5705	Hydraulic Oil Filter.....	H-5611
Hydraulic Oil Filter.....	H-5629	Oil Filter Full Flow.....	O-5703	Oil Filter Full Flow.....	C-5614
HM400-2R (DUMP TRUCKS) KOMATSU SAA6D140E-5CR-W		Oil Filter By Pass.....	O-5704	JV100WP-1 (COMPACTORS) S6D105	
Hydraulic Oil Filter.....	H-56580	JH80B (LOADERS) DT466		Air Filter Secondary.....	A-5606
HO (LOADERS) WXL-3		Fuel/Water Separator.....	SFC-5705	Air Filter Set.....	A-5604-S
Hydraulic Oil Filter Transmission...	H-65030	JH80C (LOADERS) PD6T04		Air Filter Primary.....	A-5605
IHC DROTT 150 (LOADERS)		Fuel Filter.....	F-1801	Hydraulic Oil Filter.....	H-5611
Hydraulic Oil Filter Transmission...	H-65030	Hydraulic Oil Filter.....	H-5618	Oil Filter Full Flow.....	C-5614
JH30B (LOADERS) DA220		Oil Filter By Pass.....	O-18051	L100 (LOADERS) 6V-71	
Air Filter.....	AS-1010	Oil Filter Combination.....	O-1809	Fuel Filter.....	F-6504
Fuel Filter.....	F-1303	JH90E (LOADERS) 6D95L		Fuel Filter.....	F-6503
JH63 (LOADERS) DA220		Fuel Filter.....	F-1303	Fuel Filter.....	F-6505
Fuel Filter.....	F-1303	JH90E (LOADERS) V170		Fuel Filter.....	F-7302
JH90EA (LOADERS) 6D95L		Fuel Filter.....	F-1303	Oil Filter Full Flow.....	O-6503
Fuel Filter.....	F-1303	JH90EA (LOADERS) 6D95L		L100 (LOADERS) IHC	
		Fuel Filter.....	F-1303	Fuel Filter Secondary.....	FC-54050
				Fuel/Water Separator.....	SFC-5705
				Hydraulic Oil Filter Transmission...	H-65030
				Oil Filter Full Flow.....	C-5402

Sakura Filter

ENGINE APPLICATION

MODEL/APPLICATION	SAKURA NO	MODEL/APPLICATION	SAKURA NO	MODEL/APPLICATION	SAKURA NO
KOMATSU		KOMATSU		KOMATSU	
L100 (LOADERS)		Air Filter Primary.....	A-9217	P37 (EXCAVATORS)	
Fuel Filter.....	FC-5715	Air Filter Secondary.....	A-7902	Air Filter Set.....	A-5675-S
Fuel Filter.....	FC-5103	Coolant Filter.....	WC-5707	Air Filter Secondary.....	A-5674
Oil Filter Full Flow.....	C-1807	Fuel Filter.....	FC-5720	Air Filter Primary.....	A-5673
L100 (LOADERS)		Fuel/Water Separator.....	SFC-5705	Air Filter Secondary.....	A-8670
NH220		Oil Filter Full Flow.....	C-5715	Fuel Filter Secondary.....	FC-7903
Fuel Filter.....	F-5701	Oil Filter By Pass.....	O-5704	Fuel/Water Separator.....	SFC-5708
Hydraulic Oil Filter Transmission....	H-65030	LOADSTER 1600 (LOADERS)		P8 (DOZERS)	
Oil Filter Full Flow.....	O-5702	Fuel Filter.....	FC-5103	S/N: 45001	
L100 (LOADERS)		Oil Filter Full Flow.....	O-1902	Air Filter Set.....	A-5604-S
NH250		LOADSTER 1700 (LOADERS)		Air Filter Primary.....	A-5605
Fuel Filter.....	F-5701	Fuel Filter.....	FC-5103	Air Filter Secondary.....	A-5606
Hydraulic Oil Filter Transmission....	H-65030	Oil Filter Full Flow.....	O-1902	Fuel Filter.....	FC-5602
Oil Filter Full Flow.....	O-5702	LOADSTER 1800 (LOADERS)		Hydraulic Oil Filter.....	H-5620
L100 (LOADERS)		Fuel Filter.....	FC-5103	Hydraulic Oil Filter.....	H-5601
NT-855		Oil Filter Full Flow.....	O-1902	Oil Filter Full Flow.....	C-5614
Air Filter.....	AS-5706	LW160-1 (CRANES)		PC01-1 (EXCAVATORS)	
Fuel Filter.....	F-5701	S/N: 1004		GX160K1-SKM1	
Fuel Filter.....	FC-5720	Air Filter Secondary.....	A-5408	Fuel Filter.....	F-5202
Fuel Filter.....	FC-1303	Coolant Filter.....	WC-5707	PC02-1 (EXCAVATORS)	
Fuel/Water Separator.....	SFC-5705	Hydraulic Oil Filter.....	H-7911	1D75-1A/10001	
Hydraulic Oil Filter Transmission....	H-65030	Hydraulic Oil Filter.....	H-5607	Air Filter.....	A-5206
Oil Filter Full Flow.....	O-5702	Hydraulic Oil Filter.....	H-85680	PC02-1 (EXCAVATORS)	
L-100 SERIES E (LOADERS)		Oil Filter Full Flow.....	C-5614	1D75-1B/10001	
Fuel Filter.....	FC-5715	LW200L-1 (CRANES)		Air Filter.....	A-5206
Fuel Filter.....	FC-5103	S/N: 1001		PC02-1 (EXCAVATORS)	
Oil Filter Full Flow.....	C-1807	Air Filter Secondary.....	A-5408	2D92	
L120 (LOADERS)		Coolant Filter.....	WC-5707	Oil Filter Full Flow.....	C-5615
8V-71		Hydraulic Oil Filter.....	H-7911	Oil Filter Full Flow.....	C-5616
Fuel Filter.....	F-6503	Hydraulic Oil Filter.....	H-5607	PC02-1 (EXCAVATORS)	
Fuel Filter.....	F-7302	Hydraulic Oil Filter.....	H-85680	2D94	
Oil Filter Full Flow.....	O-6503	Oil Filter Full Flow.....	C-5614	Hydraulic Oil Filter.....	H-5608
L-150 (LOADERS)		LW250L-1 (CRANES)		Oil Filter Full Flow.....	C-5616
Hydraulic Oil Filter Transmission....	H-65030	S/N: 1001		Oil Filter Full Flow.....	C-5615
L-150 (LOADERS)		Air Filter Set.....	A-5604-S	Oil Filter Full Flow.....	C-5606
UD282F6		Air Filter Primary.....	A-5605	PC02-1 (EXCAVATORS)	
Hydraulic Oil Filter Transmission....	H-65030	Air Filter Secondary.....	A-5606	2D92/11701-UP	
L-165 (LOADERS)		Fuel Filter.....	FC-5602	Air Filter.....	A-52180
D310		Hydraulic Oil Filter.....	H-85680	Hydraulic Oil Filter.....	H-5608
Fuel Filter.....	FC-5103	Hydraulic Oil Filter.....	H-7911	Oil Filter Full Flow.....	C-5604
Fuel Filter.....	FC-5715	Oil Filter Full Flow.....	C-5605	Oil Filter Full Flow.....	C-5606
Fuel Filter.....	F-2604	Oil Filter Full Flow.....	C-5701	PC03 (EXCAVATORS)	
L-175E (LOADERS)		Oil Filter Full Flow.....	C-5715	KOMATSU	
Air Filter Primary.....	A-5413	MC280 (CRANES)		Fuel Filter.....	F-5207
Air Filter Secondary.....	A-5414	F6/8L413		Oil Filter Full Flow.....	C-5205
Air Filter Set.....	A-5660-S	Fuel Filter.....	F-2603	PC03-1 (EXCAVATORS)	
Fuel Filter.....	FC-7933	Fuel Filter.....	FC-5704	1D84-1B/10001	
Fuel Filter.....	FC-1810	Oil Filter Full Flow.....	C-6204	Air Filter.....	A-52180
Hydraulic Oil Filter.....	H-5406	Oil Filter Full Flow.....	C-6203	PC03-1 (EXCAVATORS)	
L-700 (LOADERS)		MC500 (CRANES)		1D84-1A/10001	
Air Filter Set.....	A-9217-S	F6/8L413		Air Filter.....	A-52180
		Fuel Filter.....	FC-5704	PC03-2 (EXCAVATORS)	
		Fuel Filter.....	F-2603	1D84-1C/15001	
		Oil Filter Full Flow.....	C-6204	Air Filter.....	A-52180
		Oil Filter Full Flow.....	C-6203	Fuel Filter.....	F-5207

MODEL/APPLICATION	SAKURA NO	MODEL/APPLICATION	SAKURA NO	MODEL/APPLICATION	SAKURA NO
KOMATSU		KOMATSU		KOMATSU	
PC04 (EXCAVATORS) 2D94-2		PC05-6 (EXCAVATORS) 3D72-2/2519/11701		Fuel Filter.....	FC-5604
Air Filter Primary.....	AS-1014	Fuel Filter.....	F-5207	Hydraulic Oil Filter.....	H-56600
Hydraulic Oil Filter.....	H-5607			Hydraulic Oil Filter.....	H-5610
Hydraulic Oil Filter.....	H-5608	PC05-6F (EXCAVATORS)		Oil Filter Full Flow.....	C-5405
Oil Filter Full Flow.....	C-5606	Fuel Filter.....	FC-1801		
PC04 (EXCAVATORS)		PC05-7 (EXCAVATORS) 3D68E-3/10617		PC100 (EXCAVATORS) S4D105-5	
Hydraulic Oil Filter.....	H-5607	Air Filter.....	AS-5412	Air Filter Secondary.....	A-6009
Hydraulic Oil Filter.....	H-5608	Fuel Filter.....	F-5207	Air Filter Primary.....	AS-1024
Oil Filter Full Flow.....	C-5606	Oil Filter Full Flow.....	C-5708	Air Filter Set.....	AS-1024-S
		Oil Filter Full Flow.....	C-5205	Fuel Filter.....	FC-5604
PC04-1 (EXCAVATORS) 2D92		PC05-7 (EXCAVATORS) 3D68E-3/5001/6221		Hydraulic Oil Filter.....	H-56600
Hydraulic Oil Filter.....	H-5607	Air Filter.....	AS-5412	Hydraulic Oil Filter.....	H-5610
Hydraulic Oil Filter.....	H-5608	Fuel Filter.....	F-5207	Oil Filter Full Flow.....	C-5614
		Oil Filter Full Flow.....	C-5708		
		Oil Filter Full Flow.....	C-5205	PC100 (EXCAVATORS) S4D95L	
PC04-1 (EXCAVATORS) 2D94		PC05-7 (EXCAVATORS) 3D68E-3/8001		Oil Filter Full Flow.....	C-5606
Air Filter Primary.....	AS-1014	Air Filter.....	AS-5412	PC100 (EXCAVATORS) S4D105	
Hydraulic Oil Filter.....	H-5607	Fuel Filter.....	F-5207	Air Filter Primary.....	AS-1024
Hydraulic Oil Filter.....	H-5608	Oil Filter Full Flow.....	C-5708	Air Filter Set.....	AS-1024-S
Oil Filter Full Flow.....	C-5606	Oil Filter Full Flow.....	C-5205	Fuel Filter.....	FC-5604
				Hydraulic Oil Filter.....	H-56600
PC05 (EXCAVATORS)		PC05-7 (EXCAVATORS) 3D72-2/10617		Hydraulic Oil Filter.....	H-5610
Air Filter.....	AS-5412	Air Filter.....	AS-5412	Oil Filter Full Flow.....	C-5614
Fuel Filter.....	F-5207	Fuel Filter.....	F-5207		
Oil Filter Full Flow.....	C-1920	Oil Filter Full Flow.....	C-5708	PC1000 (EXCAVATORS) SA6D170	
		Oil Filter Full Flow.....	C-5205	Air Filter Secondary.....	A-5610
PC05-1 (EXCAVATORS) 3D72-1		PC05-7 (EXCAVATORS) 3D72-2/8001/10616/8001		Air Filter Primary.....	A-5614
Air Filter.....	AS-5412	Air Filter.....	AS-5412	Coolant Filter.....	WC-6901
Fuel Filter.....	F-5207	Fuel Filter.....	F-5207	Fuel Filter.....	FC-5602
Oil Filter Full Flow.....	C-1920	Oil Filter Full Flow.....	C-5708	Hydraulic Oil Filter.....	H-85680
		Oil Filter Full Flow.....	C-5205	Hydraulic Oil Filter.....	H-7911
PC05-1 (EXCAVATORS)		PC05-7E (EXCAVATORS)		Oil Filter Full Flow.....	C-5701
Air Filter.....	AS-5412	Fuel Filter.....	F-5207	Oil Filter Full Flow.....	C-5715
Fuel Filter.....	F-5207	Oil Filter Full Flow.....	C-5708	Oil Filter Full Flow.....	C-5605
Oil Filter Full Flow.....	C-1920				
PC05-1 W (EXCAVATORS)		Air Filter.....	AS-5412	PC1000-1 (EXCAVATORS) SA6D170	
Air Filter.....	AS-5412	Fuel Filter.....	F-5207	Fuel Filter.....	FC-5606
Fuel Filter.....	F-5207	Fuel Filter.....	F-5214	PC1000-1 (EXCAVATORS) SA6D170B-1/10001	
Oil Filter Full Flow.....	C-1920			Air Filter Secondary.....	A-5610
		PC07-2 (EXCAVATORS)		Air Filter Primary.....	A-5614
PC05-5 (EXCAVATORS) 3D72-2/2501		Air Filter.....	AS-5412	Coolant Filter.....	WC-56010
Air Filter Primary.....	AS-8801	Fuel Filter.....	F-5207	Fuel Filter.....	FC-5602
Fuel Filter.....	F-5207			Hydraulic Oil Filter.....	H-85680
		PC09 (EXCAVATORS) KOMATSU		Hydraulic Oil Filter.....	H-7911
PC05-5 (EXCAVATORS) 3D72-2/2501/00101		Fuel Filter.....	F-5207	Hydraulic Oil Filter Return.....	HC-5603
Air Filter Primary.....	AS-8801	Oil Filter Full Flow.....	C-5205	Oil Filter Full Flow.....	C-5605
Fuel Filter.....	F-5207			Oil Filter Full Flow.....	C-5701
		PC09-1 (EXCAVATORS) 2D70E		Oil Filter Full Flow.....	C-5715
PC05-6 (EXCAVATORS) 3D72-2/11701/02519		Air Filter Primary.....	A-8504	PC1000-1 (EXCAVATORS) SA6D170B-1/10001/11763	
Fuel Filter.....	F-5207	Fuel Filter.....	F-5207	Air Filter Secondary.....	A-5610
				Air Filter Primary.....	A-5614
PC05-6 (EXCAVATORS) 3D72-2/11701		PC100 (EXCAVATORS) 6D95L		Coolant Filter.....	WC-6901
Fuel Filter.....	F-5207	Air Filter Secondary.....	A-7806	Fuel Filter.....	FC-5602
		Air Filter Primary.....	AS-7805	Hydraulic Oil Filter.....	H-85680
PC05-6 (EXCAVATORS) 3D72-2/11701		Coolant Filter.....	WC-5707	Hydraulic Oil Filter.....	H-7911
Fuel Filter.....	F-5207				

MODEL/APPLICATION	SAKURA NO	MODEL/APPLICATION	SAKURA NO	MODEL/APPLICATION	SAKURA NO
KOMATSU		KOMATSU		KOMATSU	
PC1000-1 (EXCAVATORS) SA6D170B-1/10001/11763		Oil Filter Full Flow.....	C-5715	Coolant Filter.....	WC-5707
Hydraulic Oil Filter Return.....	HC-5603	Oil Filter Full Flow.....	C-5605	Fuel Filter.....	FC-5604
Oil Filter Full Flow.....	C-5605	PC100-1 (EXCAVATORS) S4D105-5		Hydraulic Oil Filter.....	H-56600
Oil Filter Full Flow.....	C-5701	Air Filter Secondary.....	A-6009	Hydraulic Oil Filter.....	H-5610
Oil Filter Full Flow.....	C-5715	Air Filter Primary.....	AS-1024	Oil Filter Full Flow.....	C-5604
PC1000LC-1 (EXCAVATORS) S6D170-1/10001		Air Filter Set.....	AS-1024-S	PC100-3SER (EXCAVATORS)	
Air Filter Secondary.....	A-5610	Fuel Filter.....	FC-5604	Air Filter Primary.....	AS-7805
Air Filter Primary.....	A-5614	Hydraulic Oil Filter.....	H-56600	Air Filter Secondary.....	A-7806
Coolant Filter.....	WC-6901	Hydraulic Oil Filter.....	H-5610	Fuel Filter.....	FC-5604
Fuel Filter.....	FC-5602	Oil Filter Full Flow.....	C-5614	Hydraulic Oil Filter.....	H-56600
Hydraulic Oil Filter Return.....	HC-5603	PC100-1SER (EXCAVATORS)		Hydraulic Oil Filter.....	H-5610
Hydraulic Oil Filter.....	H-85680	Air Filter Primary.....	AS-1024	Oil Filter Full Flow.....	C-5604
Hydraulic Oil Filter.....	H-7911	Air Filter Set.....	AS-1024-S	Oil Filter Full Flow.....	C-5405
Oil Filter Full Flow.....	C-5701	Air Filter Secondary.....	A-6009	PC100-5 (EXCAVATORS) KOMATSU S4D95L-1	
Oil Filter Full Flow.....	C-5715	Fuel Filter.....	FC-5604	Air Filter Secondary.....	A-5647
Oil Filter Full Flow.....	C-5605	Hydraulic Oil Filter.....	H-56600	PC100-5 (EXCAVATORS) KOMATSU S4D95L-1A	
PC1000LC-1 (EXCAVATORS) SA6D170		Hydraulic Oil Filter.....	H-5610	Air Filter Secondary.....	A-5647
Fuel Filter.....	FC-5606	Oil Filter Full Flow.....	C-5614	PC100-5 (EXCAVATORS) S4D95L	
PC1000LC-1 (EXCAVATORS) SA6D170B-1/10001		PC100-2 (EXCAVATORS) S4D105-5		Air Filter Primary.....	A-7939
Air Filter Secondary.....	A-5610	Air Filter Secondary.....	A-6009	Hydraulic Oil Filter.....	H-5610
Air Filter Primary.....	A-5614	Air Filter Primary.....	AS-1024	Hydraulic Oil Filter.....	H-56600
Coolant Filter.....	WC-56010	Air Filter Set.....	AS-1024-S	Oil Filter Full Flow.....	C-5606
Fuel Filter.....	FC-5602	Fuel Filter.....	FC-5604	PC100-5 (EXCAVATORS) S4D95L-1/28001	
Hydraulic Oil Filter Return.....	HC-5603	Hydraulic Oil Filter.....	H-5610	Air Filter Primary.....	A-7939
Hydraulic Oil Filter.....	H-85680	Hydraulic Oil Filter.....	H-56600	Hydraulic Oil Filter.....	H-56600
Hydraulic Oil Filter.....	H-7911	Oil Filter Full Flow.....	C-5614	Hydraulic Oil Filter.....	H-5610
Oil Filter Full Flow.....	C-5701	PC100-2SER (EXCAVATORS)		Oil Filter Full Flow.....	C-5606
Oil Filter Full Flow.....	C-5715	Air Filter Primary.....	AS-1024	PC100-5 (EXCAVATORS) S4D95L-1/28001/48797	
Oil Filter Full Flow.....	C-5605	Air Filter Set.....	AS-1024-S	Air Filter Primary.....	A-7939
PC1000SE-1 (EXCAVATORS) S6D170-1/10001		Air Filter Secondary.....	A-6009	Coolant Filter.....	WC-5707
Air Filter Secondary.....	A-5610	Fuel Filter.....	FC-5604	Hydraulic Oil Filter.....	H-5610
Air Filter Primary.....	A-5614	Hydraulic Oil Filter.....	H-5610	Hydraulic Oil Filter.....	H-56600
Coolant Filter.....	WC-6901	Hydraulic Oil Filter.....	H-56600	Oil Filter Full Flow.....	C-5606
Fuel Filter.....	FC-5602	Oil Filter Full Flow.....	C-5614	PC100-6 (EXCAVATORS) KOMATSU S4D102E-1D	
Hydraulic Oil Filter.....	H-7911	PC100-3 (EXCAVATORS) 6D95L-1/18001		Oil Filter Full Flow.....	C-5712
Hydraulic Oil Filter.....	H-85680	Air Filter Primary.....	AS-7805	PC100-6 (EXCAVATORS) KOMATSU S4D95L-1	
Hydraulic Oil Filter Return.....	HC-5603	Air Filter Secondary.....	A-7806	Air Filter Secondary.....	A-5647
Oil Filter Full Flow.....	C-5701	Fuel Filter.....	FC-5604	PC100-6 (EXCAVATORS) KOMATSU S4D95L-1J	
Oil Filter Full Flow.....	C-5715	Hydraulic Oil Filter.....	H-56600	Air Filter Secondary.....	A-5647
Oil Filter Full Flow.....	C-5605	Hydraulic Oil Filter.....	H-5610	PC100-6 (EXCAVATORS) S4D102E-1/42554	
PC1000SE-1 (EXCAVATORS) SA6D170		Oil Filter Full Flow.....	C-5604	Air Filter Secondary.....	A-6008
Fuel Filter.....	FC-5606	PC100-3 (EXCAVATORS) 6D95L-1/18001/10001/20188		Air Filter Primary.....	A-5627
PC1000SE-1 (EXCAVATORS) SA6D170B-1/10001		Air Filter Primary.....	AS-7805	Air Filter Set.....	A-5663-S
Air Filter Secondary.....	A-5610	Air Filter Secondary.....	A-7806	Hydraulic Oil Filter.....	H-5610
Air Filter Primary.....	A-5614	Coolant Filter.....	WC-5707	Hydraulic Oil Filter.....	H-56600
Coolant Filter.....	WC-56010	Fuel Filter.....	FC-5604	Oil Filter Full Flow.....	C-5703
Fuel Filter.....	FC-5602	Hydraulic Oil Filter.....	H-56600	PC100-3 (EXCAVATORS) 6D95L-1/18001/20188	
Hydraulic Oil Filter.....	H-7911	Hydraulic Oil Filter.....	H-5610	Air Filter Primary.....	AS-7805
Hydraulic Oil Filter.....	H-85680	Oil Filter Full Flow.....	C-5604		
Hydraulic Oil Filter Return.....	HC-5603				
Oil Filter Full Flow.....	C-5701				
Oil Filter Full Flow.....	C-5715				
Oil Filter Full Flow.....	C-5605				

MODEL/APPLICATION	SAKURA NO	MODEL/APPLICATION	SAKURA NO	MODEL/APPLICATION	SAKURA NO
KOMATSU		KOMATSU		KOMATSU	
PC100-6 (EXCAVATORS) S4D95L		PC10-2 (EXCAVATORS) 3D72-1		Hydraulic Oil Filter Return.....	HC-5603
Air Filter Primary.....	A-7939	Hydraulic Oil Filter.....	HC-5602	Hydraulic Oil Filter.....	H-2709
Hydraulic Oil Filter.....	H-56600	PC10-2 (EXCAVATORS) 3D75-1		Hydraulic Oil Filter.....	H-5652
Hydraulic Oil Filter.....	H-5610	Fuel Filter.....	F-5207	Oil Filter Full Flow.....	C-5605
Oil Filter Full Flow.....	C-5606	Oil Filter Full Flow.....	C-1920	Oil Filter Full Flow.....	C-5701
PC100-6 (EXCAVATORS) S4D95L-1/40001 - 42553		PC10-3 (EXCAVATORS) 3D72-1		Oil Filter Full Flow.....	C-5715
Air Filter Primary.....	A-7939	Hydraulic Oil Filter.....	HC-5602	PC1100-6 (EXCAVATORS) SAA6D170	
Hydraulic Oil Filter.....	H-56600	PC10-3 (EXCAVATORS) 3D75-1		Air Filter Secondary.....	A-5610
Hydraulic Oil Filter.....	H-5610	Fuel Filter.....	F-5207	Air Filter Primary.....	A-5614
Oil Filter Full Flow.....	C-5606	Oil Filter Full Flow.....	C-1920	Coolant Filter.....	WC-56010
PC100-6 (EXCAVATORS) S4D95L-1/40001/143760		PC10-5 (EXCAVATORS) 3D75-2/7001		Fuel Filter.....	FC-5602
Air Filter Primary.....	A-7939	Fuel Filter.....	F-5207	Hydraulic Oil Filter.....	H-5652
Coolant Filter.....	WC-5707	Hydraulic Oil Filter.....	H-5607	Hydraulic Oil Filter Return.....	HC-5603
Hydraulic Oil Filter.....	H-56600	Oil Filter Full Flow.....	C-8012	Hydraulic Oil Filter.....	H-2709
Hydraulic Oil Filter.....	H-5610	PC10-5 (EXCAVATORS) 3D75-2/7001/00101		Oil Filter Full Flow.....	C-5715
Oil Filter Full Flow.....	C-5606	Fuel Filter.....	F-5207	Oil Filter Full Flow.....	C-5701
PC100D-2 (EXCAVATORS) S4D105-5		Hydraulic Oil Filter.....	H-5607	Oil Filter Full Flow.....	C-5605
Air Filter Secondary.....	A-6009	Oil Filter Full Flow.....	C-8012	PC1100-6 (EXCAVATORS) SAA6D170E	
Air Filter Primary.....	AS-1024	PC10-6 (EXCAVATORS) 3D75-2/10501/3044		Fuel Filter.....	FC-5606
Air Filter Set.....	AS-1024-S	Fuel Filter.....	F-5207	PC1100LC-6 (EXCAVATORS) SAA6D170	
Fuel Filter.....	FC-5604	Hydraulic Oil Filter.....	H-5607	Air Filter Secondary.....	A-5610
Hydraulic Oil Filter.....	H-5610	Oil Filter Full Flow.....	C-8012	Air Filter Primary.....	A-5614
Hydraulic Oil Filter.....	H-56600	PC10-6 (EXCAVATORS) 3D75-2/10501/03044		Coolant Filter.....	WC-56010
Oil Filter Full Flow.....	C-5614	Fuel Filter.....	F-5207	Fuel Filter.....	FC-5602
PC100L-2 (EXCAVATORS) S4D105-5		Hydraulic Oil Filter.....	H-5625	Hydraulic Oil Filter.....	H-5652
Air Filter Secondary.....	A-6009	Oil Filter Full Flow.....	C-8012	Hydraulic Oil Filter Return.....	HC-5603
Air Filter Primary.....	AS-1024	PC10-6 (EXCAVATORS) 3D75-2/10501		Hydraulic Oil Filter.....	H-2709
Air Filter Set.....	AS-1024-S	Fuel Filter.....	F-5207	Oil Filter Full Flow.....	C-5701
Fuel Filter.....	FC-5604	Hydraulic Oil Filter.....	H-5625	Oil Filter Full Flow.....	C-5715
Hydraulic Oil Filter.....	H-56600	Oil Filter Full Flow.....	C-8012	Oil Filter Full Flow.....	C-5605
Hydraulic Oil Filter.....	H-5610	PC10-7 (EXCAVATORS) 3D78N-1/25001/27776		PC1100LC-6 (EXCAVATORS) SAA6D170E	
Oil Filter Full Flow.....	C-5614	Air Filter.....	AS-1824	Fuel Filter.....	FC-5606
PC100L-3 (EXCAVATORS) 6D125-1		Fuel Filter.....	F-5207	PC1100SE-6 (EXCAVATORS) SAA6D170E	
Fuel Filter.....	FC-5604	Oil Filter Full Flow.....	C-8012	Fuel Filter.....	FC-5606
Oil Filter Full Flow.....	C-5604	Oil Filter Full Flow.....	C-5708	PC1100SE-6 (EXCAVATORS) SAA6D170E-2/10001	
PC100SS-2 (EXCAVATORS) S4D105-5		PC10-7 (EXCAVATORS) 3D74E-3/27777		Air Filter Secondary.....	A-5610
Air Filter Primary.....	AS-1024	Air Filter.....	AS-5412	Air Filter Primary.....	A-5614
Air Filter Set.....	AS-1024-S	Fuel Filter.....	F-5207	Coolant Filter.....	WC-56010
Air Filter Secondary.....	A-6009	Oil Filter Full Flow.....	C-8012	Fuel Filter.....	FC-5602
Fuel Filter.....	FC-5604	Oil Filter Full Flow.....	C-5708	Hydraulic Oil Filter.....	H-2709
Hydraulic Oil Filter.....	H-56600	PC10-7 (EXCAVATORS) 3D74E-3/27777		Hydraulic Oil Filter Return.....	HC-5603
Hydraulic Oil Filter.....	H-5610	Air Filter.....	AS-5412	Oil Filter Full Flow.....	C-5701
Oil Filter Full Flow.....	C-5614	Fuel Filter.....	F-5207	Oil Filter Full Flow.....	C-5715
PC10-1 (EXCAVATORS) 2D94-1		Oil Filter Full Flow.....	C-5205	Oil Filter Full Flow.....	C-5605
Hydraulic Oil Filter.....	HC-5602	Oil Filter Full Flow.....	C-5708	PC1100SP-6 (EXCAVATORS) SAA6D170	
Oil Filter Full Flow.....	C-5606	PC1100-1 (EXCAVATORS) SAA6D170		Air Filter Secondary.....	A-5610
PC10-1 (EXCAVATORS) 2D94-2		Air Filter Secondary.....	A-5610	Air Filter Primary.....	A-5614
Oil Filter Full Flow.....	C-5606	Air Filter Primary.....	A-5614	Coolant Filter.....	WC-56010
		Coolant Filter.....	WC-56010	Fuel Filter.....	FC-5602
		Fuel Filter.....	FC-5602	Hydraulic Oil Filter.....	H-2709
				Hydraulic Oil Filter Return.....	HC-5603
				Oil Filter Full Flow.....	C-5701
				Oil Filter Full Flow.....	C-5715
				Oil Filter Full Flow.....	C-5605

MODEL/APPLICATION	SAKURA NO	MODEL/APPLICATION	SAKURA NO	MODEL/APPLICATION	SAKURA NO
KOMATSU		KOMATSU		KOMATSU	
PC1100SP-6 (EXCAVATORS) SAA6D170		PC120-3 (EXCAVATORS) 6D95L		Oil Filter Full Flow.....	C-5606
Hydraulic Oil Filter.....	H-2709	Air Filter Secondary.....	A-7806	PC120-6 (EXCAVATORS) KOMATSU S4D95L	
Oil Filter Full Flow.....	C-5605	Air Filter Primary.....	AS-7805	Air Filter Secondary.....	A-5647
Oil Filter Full Flow.....	C-5701	Fuel Filter.....	FC-5604	PC120-6 (EXCAVATORS) KOMATSU S4D102E-1E-2	
Oil Filter Full Flow.....	C-5715	Hydraulic Oil Filter.....	H-56600	Oil Filter Full Flow.....	C-5712
PC12 (EXCAVATORS) 3TN66E		Hydraulic Oil Filter.....	H-5610	PC120-6 (EXCAVATORS) KOMATSU S4D95L-1	
Air Filter Primary.....	AS-1014	Oil Filter Full Flow.....	C-5405	Air Filter Secondary.....	A-5647
Hydraulic Oil Filter.....	H-5607	PC120-3 (EXCAVATORS) 6D95L-1/18001		PC120-6 (EXCAVATORS)	
PC120 (EXCAVATORS) S4D95L		Air Filter Secondary.....	A-7806	Air Filter Primary.....	A-7939
Air Filter Primary.....	A-7939	Air Filter Primary.....	AS-7805	Hydraulic Oil Filter.....	H-5610
Hydraulic Oil Filter.....	H-5610	Fuel Filter.....	FC-5604	Hydraulic Oil Filter.....	H-56600
Hydraulic Oil Filter.....	H-56600	Hydraulic Oil Filter.....	H-5610	Hydraulic Oil Filter.....	H-56600
Oil Filter Full Flow.....	C-5606	Hydraulic Oil Filter.....	H-56600	Oil Filter Full Flow.....	C-5606
PC120 (EXCAVATORS) S4D105		Oil Filter Full Flow.....	C-5604	PC120-6 (EXCAVATORS) S495L-1/45001/143760	
Air Filter Set.....	AS-1024-S	PC120-3 (EXCAVATORS) 6D95L-1/18001/10001/20188		Air Filter Primary.....	A-7939
Air Filter Primary.....	AS-1024	Air Filter Secondary.....	A-7806	Coolant Filter.....	WC-5707
Fuel Filter.....	FC-5604	Air Filter Primary.....	AS-7805	Hydraulic Oil Filter.....	H-56600
Hydraulic Oil Filter.....	H-56600	Coolant Filter.....	WC-5707	Hydraulic Oil Filter.....	H-5610
Hydraulic Oil Filter.....	H-5610	Fuel Filter.....	FC-5604	Oil Filter Full Flow.....	C-5606
Oil Filter Full Flow.....	C-5614	Hydraulic Oil Filter.....	H-5610	PC120-6 (EXCAVATORS) S4D102E	
PC120-1 (EXCAVATORS) S4D105-5		Hydraulic Oil Filter.....	H-56600	Air Filter Primary.....	A-5627
Air Filter Primary.....	AS-1024	Oil Filter Full Flow.....	C-5614	Air Filter Secondary.....	A-6008
Air Filter Set.....	AS-1024-S	PC120-3 (EXCAVATORS) 6D95L-1/18001/20188		Air Filter Set.....	A-5663-S
Air Filter Secondary.....	A-6009	Air Filter Primary.....	AS-7805	Fuel Filter Secondary.....	FC-7903
Fuel Filter.....	FC-5604	Coolant Filter.....	WC-5707	Fuel/Water Separator.....	SFC-5708
Hydraulic Oil Filter.....	H-56600	Fuel Filter.....	FC-5604	Hydraulic Oil Filter.....	H-56600
Hydraulic Oil Filter.....	H-5610	Hydraulic Oil Filter.....	H-5610	Hydraulic Oil Filter.....	H-5610
Oil Filter Full Flow.....	C-5614	Hydraulic Oil Filter.....	H-56600	PC120-6 (EXCAVATORS) S4D102E-1/57001	
PC120-2 (EXCAVATORS) S4D105-5		Oil Filter Full Flow.....	C-5604	Air Filter Primary.....	A-5627
Air Filter Secondary.....	A-6009	PC120-5 (EXCAVATORS) KOMATSU S4D95L		Air Filter Secondary.....	A-6008
Air Filter Primary.....	AS-1024	Air Filter Secondary.....	A-5647	Air Filter Set.....	A-5663-S
Air Filter Set.....	AS-1024-S	PC120-5 (EXCAVATORS) KOMATSU S4D95L-1		Hydraulic Oil Filter.....	H-56600
Fuel Filter.....	FC-5604	Air Filter Secondary.....	A-5647	Hydraulic Oil Filter.....	H-5610
Hydraulic Oil Filter.....	H-5610	PC120-5 (EXCAVATORS) S4D95L		Oil Filter Full Flow.....	C-5703
Hydraulic Oil Filter.....	H-56600	Air Filter Primary.....	A-7939	PC120-6 (EXCAVATORS) S4D95L	
Oil Filter Full Flow.....	C-5614	Hydraulic Oil Filter.....	H-56600	Air Filter Primary.....	A-7939
PC120-3 (EXCAVATORS) 4D95L-1		Hydraulic Oil Filter.....	H-5610	Hydraulic Oil Filter.....	H-5610
Air Filter Primary.....	AS-7805	Oil Filter Full Flow.....	C-5606	Hydraulic Oil Filter.....	H-56600
Air Filter Secondary.....	A-7806	PC120-5 (EXCAVATORS) S4D95L-1/30001/48797		Oil Filter Full Flow.....	C-5606
Fuel Filter.....	FC-5604	Air Filter Primary.....	A-7939	PC120-6 (EXCAVATORS) S4D95L-1/45001/143760	
Hydraulic Oil Filter.....	H-5610	Coolant Filter.....	WC-5707	Air Filter Primary.....	A-7939
Hydraulic Oil Filter.....	H-56600	Hydraulic Oil Filter.....	H-5610	Coolant Filter.....	WC-5707
Oil Filter Full Flow.....	C-5604	Hydraulic Oil Filter.....	H-56600	Hydraulic Oil Filter.....	H-56600
PC120-3 (EXCAVATORS) 6D125-1/18001		Oil Filter Full Flow.....	C-5606	Hydraulic Oil Filter.....	H-5610
Air Filter Primary.....	AS-7805	PC120-5 (EXCAVATORS) S4D95L-1/30001		Oil Filter Full Flow.....	C-5606
Air Filter Secondary.....	A-7806	Air Filter Primary.....	A-7939	PC120-6 (EXCAVATORS) S4D95L-1/45001/57000	
Fuel Filter.....	FC-5604	Hydraulic Oil Filter.....	H-56600	Air Filter Primary.....	A-7939
Hydraulic Oil Filter.....	H-5610	Hydraulic Oil Filter.....	H-5610	Hydraulic Oil Filter.....	H-5610
Hydraulic Oil Filter.....	H-56600	Hydraulic Oil Filter.....	H-5610		
Oil Filter Full Flow.....	C-5604				

MODEL/APPLICATION	SAKURA NO	MODEL/APPLICATION	SAKURA NO	MODEL/APPLICATION	SAKURA NO
KOMATSU		KOMATSU		KOMATSU	
PC120-6 (EXCAVATORS) S4D95L-1/45001/57000		Fuel/Water Separator.....	SFC-56020B	Fuel/Water Separator.....	SFC-56020
Hydraulic Oil Filter.....	H-56600	PC1250-8 (EXCAVATORS) KOMATSU SAA6D170E-5C-01		Fuel/Water Separator.....	SFC-56020B
Oil Filter Full Flow.....	C-5606	Fuel/Water Separator.....	SFC-56020	PC1250SP-8 (EXCAVATORS) SAA6D170E-5	
PC120LC-6 (EXCAVATORS) KOMATSU S4D102E-1E-2		Fuel/Water Separator.....	SFC-56020B	Coolant Filter.....	WC-56010
Oil Filter Full Flow.....	C-5712	PC1250-8 (EXCAVATORS) SAA6D170E-5		Fuel/Water Separator Secondary..	SFC-5611-10B
PC120LC-6 (EXCAVATORS) S4D102E		Coolant Filter.....	WC-56010	Fuel/Water Separator Secondary..	SFC-5611-10
Air Filter Primary.....	A-5627	Fuel/Water Separator Secondary..	SFC-5611-10B	Hydraulic Oil Filter.....	H-5618
Air Filter Set.....	A-5663-S	Fuel/Water Separator Secondary..	SFC-5611-10	Hydraulic Oil Filter Return.....	HC-5603
Air Filter Secondary.....	A-6008	Hydraulic Oil Filter.....	H-5618	PC128US-1 (EXCAVATORS) KOMATSU S4D102E-1F-US	
Fuel Filter Secondary.....	FC-7903	Hydraulic Oil Filter Return.....	HC-5603	Air Filter Secondary.....	A-5647
Fuel/Water Separator.....	SFC-5708	PC1250LC-7 (EXCAVATORS) SAA6D170E-3		PC128US-1 (EXCAVATORS) S4D102E	
Hydraulic Oil Filter.....	H-56600	Cabin Air Filter.....	CA-56041	Fuel Filter Secondary.....	FC-7903
Hydraulic Oil Filter.....	H-5610	Coolant Filter.....	WC-56010	Fuel/Water Separator.....	SFC-5708
PC120LC-6 (EXCAVATORS) SAA4D102E-2		Fuel/Water Separator.....	SFC-5601-02	Hydraulic Oil Filter.....	H-56600
Air Filter Secondary.....	A-5674	Hydraulic Oil Filter.....	H-5618	Oil Filter Full Flow.....	C-5703
PC120SS-2 (EXCAVATORS) S4D105-5		Hydraulic Oil Filter Return.....	HC-5603	PC128US-2 (EXCAVATORS) KOMATSU S4D102E-1V	
Air Filter Primary.....	AS-1024	Hydraulic Oil Filter.....	H-2709	Oil Filter Full Flow.....	C-5712
Air Filter Set.....	AS-1024-S	Hydraulic Breather.....	H-56610	PC128US-2 (EXCAVATORS) KOMATSU SAA6D102E-2D-4	
Air Filter Secondary.....	A-6009	Oil Filter Full Flow.....	C-5715	Oil Filter Full Flow.....	C-5712
Fuel Filter.....	FC-5604	Oil Filter Full Flow.....	C-5605	PC128US-2 (EXCAVATORS)	
Hydraulic Oil Filter.....	H-56600	Oil Filter Full Flow.....	C-5701	Air Filter Primary.....	A-5541
Hydraulic Oil Filter.....	H-5610	PC1250LC-8 (EXCAVATORS) KOMATSU SAA6D170E-5C		Air Filter Secondary.....	A-5540
Oil Filter Full Flow.....	C-5614	Fuel/Water Separator.....	SFC-56020	Fuel Filter Secondary.....	FC-7903
PC1250 (EXCAVATORS)		Fuel/Water Separator.....	SFC-56020B	Fuel/Water Separator.....	SFC-5708
Air Filter Secondary.....	A-6011	PC1250LC-8 (EXCAVATORS) KOMATSU SAA6D170E-5C-01		PC128US-2 (EXCAVATORS) S4D102E	
Air Filter Primary.....	A-6010	Fuel/Water Separator.....	SFC-56020B	Fuel Filter Secondary.....	FC-7903
Cabin Air Filter.....	CA-5602	Fuel/Water Separator.....	SFC-56020	Fuel/Water Separator.....	SFC-5708
Cabin Air Filter.....	CA-56041	PC1250LC-8 (EXCAVATORS) SAA6D170E-5		Hydraulic Oil Filter.....	H-56600
Fuel/Water Separator.....	SFC-5601-02	Coolant Filter.....	WC-56010	Oil Filter Full Flow.....	C-5703
Hydraulic Oil Filter Return.....	HC-5603	Fuel/Water Separator Secondary..	SFC-5611-10B	PC128UU-1 (EXCAVATORS) KOMATSU S4D95L	
Hydraulic Oil Filter.....	H-2709	Fuel/Water Separator Secondary..	SFC-5611-10	Air Filter Secondary.....	A-5647
Oil Filter Full Flow.....	C-5605	Hydraulic Oil Filter Return.....	HC-5603	PC128UU-1 (EXCAVATORS) KOMATSU S4D102E-1F-2	
Oil Filter Full Flow.....	C-5701	Hydraulic Oil Filter.....	H-5618	Air Filter Secondary.....	A-5647
Oil Filter Full Flow.....	C-5715	PC1250SP-7 (EXCAVATORS) SAA6D170E-3		PC128UU-1 (EXCAVATORS) KOMATSU S4D95L-1L	
PC1250-7 (EXCAVATORS) KOMATSU SAA6D170E		Cabin Air Filter.....	CA-56041	Air Filter Secondary.....	A-5647
Hydraulic Oil Filter.....	H-56770	Coolant Filter.....	WC-56010	PC128UU-1 (EXCAVATORS) KOMATSU S4D95L-1L	
PC1250-7 (EXCAVATORS) SAA6D170E		Fuel/Water Separator.....	SFC-5601-02	PC128UU-1 (EXCAVATORS)	
Air Filter Secondary.....	A-8580	Hydraulic Oil Filter.....	H-5618	Air Filter Secondary.....	A-5647
Air Filter Primary.....	A-8665M	Hydraulic Oil Filter.....	H-2709	PC128UU-1 (EXCAVATORS) KOMATSU S4D95L-1L	
Hydraulic Oil Filter Return.....	HC-5603	Hydraulic Oil Filter Return.....	HC-5603	Air Filter Secondary.....	A-5647
Hydraulic Oil Filter.....	H-5618	Hydraulic Breather.....	H-56610	Air Filter Primary.....	A-7939
Hydraulic Oil Filter.....	H-2709	Oil Filter Full Flow.....	C-5605	Fuel Filter Secondary.....	FC-7903
Hydraulic Breather.....	H-56610	Oil Filter Full Flow.....	C-5701	Fuel/Water Separator.....	SFC-5708
Oil Filter Full Flow.....	C-5715	Oil Filter Full Flow.....	C-5701	Hydraulic Oil Filter.....	H-5609
Oil Filter Full Flow.....	C-5701	Oil Filter Full Flow.....	C-5715	Oil Filter Full Flow.....	C-5608
Oil Filter Full Flow.....	C-5605	PC1250SP-8 (EXCAVATORS) KOMATSU SAA6D170E-5C		PC128UU-1 (EXCAVATORS) S4AD102E-1/2347	
PC1250-8 (EXCAVATORS) KOMATSU SAA6D170E-5C		Fuel/Water Separator.....	SFC-56020	Fuel Filter Secondary.....	FC-7903
Fuel/Water Separator.....	SFC-56020	Fuel/Water Separator.....	SFC-56020B	Fuel/Water Separator.....	SFC-5708
PC1250-8 (EXCAVATORS) KOMATSU SAA6D170E-5C		PC1250SP-8 (EXCAVATORS) KOMATSU SAA6D170E-5C-01			
Fuel/Water Separator.....	SFC-56020				

MODEL/APPLICATION	SAKURA NO	MODEL/APPLICATION	SAKURA NO	MODEL/APPLICATION	SAKURA NO
KOMATSU		KOMATSU		KOMATSU	
PC128UU-1 (EXCAVATORS) S4AD102E-1/2347		PC130-5K (EXCAVATORS)		PC138US-8 (EXCAVATORS) SAA4D95LE , 2007	
Oil Filter Full Flow.....	C-5703	Air Filter Secondary.....	A-7964	Air Filter Primary.....	A-5541
PC128UU-1 (EXCAVATORS) S4D102E		Air Filter Primary.....	AS-7988	Air Filter Secondary.....	A-5540
Fuel Filter Secondary.....	FC-7903	Fuel Filter.....	FC-5715	Fuel Filter.....	FC-5615
Fuel/Water Separator.....	SFC-5708	Hydraulic Oil Filter.....	H-5610	Fuel/Water Separator.....	SFC-56040
Hydraulic Oil Filter.....	H-56600	Hydraulic Oil Filter.....	H-56600	Hydraulic Oil Filter.....	H-56650
Oil Filter Full Flow.....	C-5703	Oil Filter Full Flow.....	C-5102	Oil Filter Full Flow.....	C-56191
PC128UU-1 (EXCAVATORS) S4D95L-1/1001 - 2346		PC130-6 (EXCAVATORS) KOMATSU S4D102E		PC14R-2 (EXCAVATORS) 3D67E-1A , 2006	
Air Filter Primary.....	A-7939	Air Filter Secondary.....	A-5647	Fuel Filter.....	F-5207
Hydraulic Oil Filter.....	H-56600	PC130-6 (EXCAVATORS) KOMATSU S4D102E-1E		PC15 (EXCAVATORS) 3TN66E	
Hydraulic Oil Filter.....	H-5610	Oil Filter Full Flow.....	C-5712	Air Filter Primary.....	AS-1014
Oil Filter Full Flow.....	C-5606	PC130-6 (EXCAVATORS) KOMATSU S4D95L-1K		Hydraulic Oil Filter.....	H-5607
PC128UU-1 (EXCAVATORS) S4D102E/2347/26200415		Air Filter Secondary.....	A-5647	PC150 (EXCAVATORS) 1004.4T	
Air Filter Primary.....	A-7939	PC130-6 (EXCAVATORS) S4D102E-1/50356		Oil Filter Full Flow.....	C-5102
Air Filter Set.....	A-5652-S	Air Filter Primary.....	A-5627	PC150 (EXCAVATORS) 6D105	
Fuel Filter Secondary.....	FC-7903	Air Filter Secondary.....	A-6008	Air Filter Secondary.....	A-6009
Fuel/Water Separator.....	SFC-5708	Air Filter Set.....	A-5663-S	Hydraulic Oil Filter.....	H-7911
Hydraulic Oil Filter.....	H-56600	Hydraulic Oil Filter.....	H-5610	Hydraulic Oil Filter.....	H-85680
Hydraulic Oil Filter.....	H-5610	Hydraulic Oil Filter.....	H-56600	Oil Filter Full Flow.....	C-5614
Oil Filter Full Flow.....	C-5703	Oil Filter Full Flow.....	C-5703	PC150 (EXCAVATORS) S6D95L	
PC128UU-2 (EXCAVATORS) KOMATSU S4D102E-1V-2		PC130-6 (EXCAVATORS) S4D95L-1/45001 - 50355		Air Filter Primary.....	AS-1024
Oil Filter Full Flow.....	C-5712	Air Filter Primary.....	A-7939	Air Filter Primary.....	AS-7805
PC128UU-2 (EXCAVATORS) KOMATSU SAA4D102E-2D-4		Hydraulic Oil Filter.....	H-56600	Air Filter Secondary.....	A-6009
Oil Filter Full Flow.....	C-5712	Hydraulic Oil Filter.....	H-5610	Air Filter Secondary.....	A-7806
PC128UU-2 (EXCAVATORS) S4D102E		Oil Filter Full Flow.....	C-5606	Fuel Filter.....	FC-5604
Fuel Filter Secondary.....	FC-7903	PC130-7 (EXCAVATORS) 2007		Hydraulic Oil Filter.....	H-56600
Fuel/Water Separator.....	SFC-5708	Fuel Filter.....	FC-1801	Hydraulic Oil Filter.....	H-5610
Hydraulic Oil Filter.....	H-56600	PC130-7 (EXCAVATORS) SAA4D95LE		Oil Filter Full Flow.....	C-5405
Oil Filter Full Flow.....	C-5703	Air Filter Primary.....	A-5541	PC1500 (EXCAVATORS) S6D170	
PC128UU-2 (EXCAVATORS) KOMATSU SAA4D102E-2D-4		Air Filter Secondary.....	A-5540	Air Filter Secondary.....	A-5610
Oil Filter Full Flow.....	C-5712	Fuel Filter.....	FC-1801	Air Filter Primary.....	A-5614
PC128UU-2 (EXCAVATORS) S4D102E		Hydraulic Oil Filter.....	H-56600	Coolant Filter.....	WC-6901
Fuel Filter Secondary.....	FC-7903	Oil Filter Full Flow.....	C-56190	Fuel Filter.....	FC-5602
Fuel/Water Separator.....	SFC-5708	Oil Filter Full Flow.....	C-56191	Hydraulic Oil Filter.....	H-85680
Hydraulic Oil Filter.....	H-56600	PC138-2 (EXCAVATORS) 2008		Hydraulic Oil Filter.....	H-7911
Oil Filter Full Flow.....	C-5703	Air Filter Primary.....	A-5541	Oil Filter Full Flow.....	C-5715
PC128UU-2 (EXCAVATORS) S4D102E		Fuel Filter.....	FC-1801	Oil Filter Full Flow.....	C-5605
Fuel Filter Secondary.....	FC-7903	Hydraulic Oil Filter.....	H-56650	Oil Filter Full Flow.....	C-5701
Fuel/Water Separator.....	SFC-5708	Oil Filter Full Flow.....	C-56190	PC1500-1 (EXCAVATORS) 2D94-2C	
Hydraulic Oil Filter.....	H-56600	Oil Filter Full Flow.....	C-56191	Air Filter Secondary.....	A-5610
Oil Filter Full Flow.....	C-5703	PC138US-2 (EXCAVATORS) 2008		Air Filter Primary.....	A-5614
PC128UU-2 (EXCAVATORS) S4D102E		Air Filter Primary.....	A-5541	Coolant Filter.....	WC-5703
Fuel Filter Secondary.....	FC-7903	Air Filter Secondary.....	A-5540	Coolant Filter.....	WC-5705
Fuel/Water Separator.....	SFC-5708	Fuel Filter.....	FC-1801	Fuel Filter.....	FC-5602
Hydraulic Oil Filter.....	H-56600	Hydraulic Oil Filter.....	H-56650	Fuel Filter.....	FC-5602
Oil Filter Full Flow.....	C-5703	Oil Filter Full Flow.....	C-56190	Oil Filter By Pass.....	O-5704
PC128UU-2 (EXCAVATORS) S4D102E		Oil Filter Full Flow.....	C-56191	Oil Filter Full Flow.....	C-5715
Fuel Filter Secondary.....	FC-7903	PC130-7 (EXCAVATORS) SAA4D95LE		PC1500-1 (EXCAVATORS) KT-1150 (QTY 2)/10007	
Fuel/Water Separator.....	SFC-5708	Air Filter Primary.....	A-5541		
Hydraulic Oil Filter.....	H-56600	Air Filter Secondary.....	A-5540		
Oil Filter Full Flow.....	C-5703	Fuel Filter.....	FC-1801		
PC128UU-2 (EXCAVATORS) S4D102E		Hydraulic Oil Filter.....	H-56650		
Fuel Filter Secondary.....	FC-7903	Oil Filter Full Flow.....	C-56190		
Fuel/Water Separator.....	SFC-5708	Oil Filter Full Flow.....	C-56191		
Hydraulic Oil Filter.....	H-56600	PC138-2 (EXCAVATORS) 2008			
Oil Filter Full Flow.....	C-5703	Air Filter Primary.....	A-5541		
PC128UU-2 (EXCAVATORS) S4D102E		Air Filter Secondary.....	A-5540		
Fuel Filter Secondary.....	FC-7903	Fuel Filter.....	FC-1801		
Fuel/Water Separator.....	SFC-5708	Hydraulic Oil Filter.....	H-56650		
Hydraulic Oil Filter.....	H-56600	Oil Filter Full Flow.....	C-56190		
Oil Filter Full Flow.....	C-5703	Oil Filter Full Flow.....	C-56191		
PC128UU-2 (EXCAVATORS) S4D102E		PC138US-2 (EXCAVATORS) 2008			
Fuel Filter Secondary.....	FC-7903	Air Filter Primary.....	A-5541		
Fuel/Water Separator.....	SFC-5708	Air Filter Secondary.....	A-5540		
Hydraulic Oil Filter.....	H-56600	Fuel Filter.....	FC-1801		
Oil Filter Full Flow.....	C-5703	Hydraulic Oil Filter.....	H-56650		
PC128UU-2 (EXCAVATORS) S4D102E		Oil Filter Full Flow.....	C-56190		
Fuel Filter Secondary.....	FC-7903	Oil Filter Full Flow.....	C-56191		
Fuel/Water Separator.....	SFC-5708	PC130-7 (EXCAVATORS) SAA4D95LE			
Hydraulic Oil Filter.....	H-56600	Air Filter Primary.....	A-5541		
Oil Filter Full Flow.....	C-5703	Air Filter Secondary.....	A-5540		
PC128UU-2 (EXCAVATORS) S4D102E		Fuel Filter.....	FC-1801		
Fuel Filter Secondary.....	FC-7903	Hydraulic Oil Filter.....	H-56650		
Fuel/Water Separator.....	SFC-5708	Oil Filter Full Flow.....	C-56190		
Hydraulic Oil Filter.....	H-56600	Oil Filter Full Flow.....	C-56191		
Oil Filter Full Flow.....	C-5703	PC130-7 (EXCAVATORS) SAA4D95LE			
PC128UU-2 (EXCAVATORS) S4D102E		Air Filter Primary.....	A-5541		
Fuel Filter Secondary.....	FC-7903	Air Filter Secondary.....	A-5540		
Fuel/Water Separator.....	SFC-5708	Fuel Filter.....	FC-1801		
Hydraulic Oil Filter.....	H-56600	Hydraulic Oil Filter.....	H-56650		
Oil Filter Full Flow.....	C-5703	Oil Filter Full Flow.....	C-56190		
PC128UU-2 (EXCAVATORS) S4D102E		Oil Filter Full Flow.....	C-56191		
Fuel Filter Secondary.....	FC-7903	PC130-7 (EXCAVATORS) SAA4D95LE			
Fuel/Water Separator.....	SFC-5708	Air Filter Primary.....	A-5541		
Hydraulic Oil Filter.....	H-56600	Air Filter Secondary.....	A-5540		
Oil Filter Full Flow.....	C-5703	Fuel Filter.....	FC-1801		
PC128UU-2 (EXCAVATORS) S4D102E		Hydraulic Oil Filter.....	H-56650		
Fuel Filter Secondary.....	FC-7903	Oil Filter Full Flow.....	C-56190		
Fuel/Water Separator.....	SFC-5708	Oil Filter Full Flow.....	C-56191		
Hydraulic Oil Filter.....	H-56600	PC130-7 (EXCAVATORS) SAA4D95LE			
Oil Filter Full Flow.....	C-5703	Air Filter Primary.....	A-5541		
PC128UU-2 (EXCAVATORS) S4D102E		Air Filter Secondary.....	A-5540		
Fuel Filter Secondary.....	FC-7903	Fuel Filter.....	FC-1801		
Fuel/Water Separator.....	SFC-5708	Hydraulic Oil Filter.....	H-56650		
Hydraulic Oil Filter.....	H-56600	Oil Filter Full Flow.....	C-56190		
Oil Filter Full Flow.....	C-5703	Oil Filter Full Flow.....	C-56191		

MODEL/APPLICATION	SAKURA NO	MODEL/APPLICATION	SAKURA NO	MODEL/APPLICATION	SAKURA NO
KOMATSU		KOMATSU		KOMATSU	
PC1500-1 (EXCAVATORS) KT-1150 (QTY 2)/10007 Air Filter Secondary..... A-5610 Air Filter Primary..... A-5614 Coolant Filter..... WC-6901 Fuel Filter..... FC-5602 Hydraulic Oil Filter..... H-7911 Hydraulic Oil Filter..... H-85680 Oil Filter Full Flow..... C-5715 Oil Filter Full Flow..... C-5701 Oil Filter Full Flow..... C-5605		PC150-3 (EXCAVATORS) S6D95L-1/3001/10001/33697 Air Filter Primary..... AS-7805 Air Filter Secondary..... A-7806 Coolant Filter..... WC-5707 Fuel Filter..... FC-5604 Hydraulic Oil Filter..... H-56600 Hydraulic Oil Filter..... H-5610 Oil Filter Full Flow..... C-5604 PC150-3 (EXCAVATORS) S6D95L-1/3001/33698 Air Filter Primary..... AS-7805 Air Filter Secondary..... A-7806 Coolant Filter..... WC-5707 Fuel Filter..... FC-5604 Hydraulic Oil Filter..... H-5610 Hydraulic Oil Filter..... H-56600 Oil Filter Full Flow..... C-5604 PC150-3 (EXCAVATORS) S6D95L-1C/3001 Air Filter Primary..... AS-7805 Air Filter Secondary..... A-7806 Fuel Filter..... FC-5604 Hydraulic Oil Filter..... H-5610 Hydraulic Oil Filter..... H-56600 Oil Filter Full Flow..... C-5604 PC150-3SER (EXCAVATORS) Air Filter Primary..... AS-7805 Air Filter Secondary..... A-7806 Fuel Filter..... FC-5604 Hydraulic Oil Filter..... H-56600 Hydraulic Oil Filter..... H-5610 Oil Filter Full Flow..... C-5604 PC150-5 (EXCAVATORS) S6D95L-1GG Air Filter Set..... A-5663-S Air Filter Primary..... A-5627 Air Filter Secondary..... A-6008 Hydraulic Oil Filter..... H-5610 Hydraulic Oil Filter..... H-56600 Oil Filter Full Flow..... C-5606 PC150-5 (EXCAVATORS) S6D95L-1/6001/58644 Air Filter Set..... A-5663-S Air Filter Primary..... A-5627 Hydraulic Oil Filter..... H-56600 Hydraulic Oil Filter..... H-5610 Oil Filter Full Flow..... C-5606 PC150-6 (EXCAVATORS) Fuel Filter Secondary..... FC-7903 Fuel/Water Separator..... SFC-5708 Hydraulic Oil Filter..... H-5610 Hydraulic Oil Filter..... H-56600 PC150-6K (EXCAVATORS) SA4D102E Air Filter Secondary..... A-7806 Air Filter Primary..... AS-7805 Fuel Filter..... FC-5604 Hydraulic Oil Filter..... H-5610 Hydraulic Oil Filter..... H-56600 Oil Filter Full Flow..... C-5604		Air Filter Secondary..... A-7964 Air Filter Primary..... AS-7988 Fuel/Water Separator..... SFC-5708 Hydraulic Oil Filter..... H-5610 Hydraulic Oil Filter..... H-56600 PC150AV (EXCAVATORS) S6D95L Air Filter Set..... A-5663-S Air Filter Primary..... A-5627 Hydraulic Oil Filter..... H-56600 Hydraulic Oil Filter..... H-5610 Oil Filter Full Flow..... C-5606 PC150LC-1 (EXCAVATORS) 6D105 Air Filter Primary..... AS-1024 Air Filter Set..... AS-1024-S Air Filter Secondary..... A-6009 Hydraulic Oil Filter..... H-85680 Hydraulic Oil Filter..... H-7911 Oil Filter Full Flow..... C-5614 PC150LC-3 (EXCAVATORS) S6D95L-1/3001 Air Filter Primary..... AS-7805 Air Filter Secondary..... A-7806 Fuel Filter..... FC-5604 Hydraulic Oil Filter..... H-56600 Hydraulic Oil Filter..... H-5610 Oil Filter Full Flow..... C-5604 PC150LC-3 (EXCAVATORS) S6D95L-1/3001/10001/33697 Air Filter Secondary..... A-7806 Air Filter Primary..... AS-7805 Coolant Filter..... WC-5707 Fuel Filter..... FC-5604 Hydraulic Oil Filter..... H-56600 Hydraulic Oil Filter..... H-5610 Oil Filter Full Flow..... C-5604 PC150LC-3 (EXCAVATORS) S6D95L-1/3001/33698 Air Filter Primary..... AS-7805 Air Filter Secondary..... A-7806 Coolant Filter..... WC-5707 Fuel Filter..... FC-5604 Hydraulic Oil Filter..... H-56600 Hydraulic Oil Filter..... H-5610 Oil Filter Full Flow..... C-5604 PC150LC-3 (EXCAVATORS) S6D95L-1C/3001 Air Filter Primary..... AS-7805 Air Filter Secondary..... A-7806 Fuel Filter..... FC-5604 Hydraulic Oil Filter..... H-56600 Hydraulic Oil Filter..... H-5610 Oil Filter Full Flow..... C-5604 PC150LC-6 (EXCAVATORS) Fuel Filter Secondary..... FC-7903 Fuel/Water Separator..... SFC-5708	

MODEL/APPLICATION	SAKURA NO	MODEL/APPLICATION	SAKURA NO	MODEL/APPLICATION	SAKURA NO
KOMATSU		KOMATSU		KOMATSU	
PC150LC-6 (EXCAVATORS)		PC15-3 (EXCAVATORS) 3D82E-3/6222		Air Filter Secondary.....	A-8670
Hydraulic Oil Filter.....	H-56600	Fuel Filter.....	F-5207	Fuel Filter Secondary.....	FC-7903
Hydraulic Oil Filter.....	H-5610	Oil Filter Full Flow.....	C-5708	Fuel/Water Separator.....	SFC-5706
		Oil Filter Full Flow.....	C-1011	Fuel/Water Separator.....	SFC-5708
PC150LC-6 (EXCAVATORS) SA4D102E		PC15-3 (EXCAVATORS) 3D84N-2/5001/6221		PC160LC-7 (EXCAVATORS) KOMATSU SAA4D102E	
Air Filter Secondary.....	A-7964	Fuel Filter.....	F-5210	Air Filter Secondary.....	A-56741
Air Filter Primary.....	AS-7988	Oil Filter Full Flow.....	C-8012	Air Filter Primary.....	A-56731
Fuel/Water Separator.....	SFC-5708	Oil Filter Full Flow.....	C-5708	Air Filter Set.....	A-56731-S
Hydraulic Oil Filter.....	H-5610			PC160LC-7 (EXCAVATORS) SAA4D102E	
Hydraulic Oil Filter.....	H-56600	PC15-8 (EXCAVATORS) 3D82E-3		Air Filter Set.....	A-5675-S
		Fuel Filter.....	F-5207	Air Filter Primary.....	A-5673
PC150LC-6K (EXCAVATORS) SA4D102E		Oil Filter Full Flow.....	C-5205	Air Filter Secondary.....	A-5674
Air Filter Primary.....	AS-7988	PC158US-2 (EXCAVATORS) S4D102E-1		Air Filter Secondary.....	A-8670
Air Filter Secondary.....	A-7964	Air Filter Primary.....	A-5541	Cabin Air Filter.....	CA-5602
Fuel/Water Separator.....	SFC-5708	Air Filter Secondary.....	A-5540	Cabin Air Filter.....	CA-56041
Hydraulic Oil Filter.....	H-5610	Hydraulic Oil Filter.....	H-56600	Fuel Filter.....	F-5218
Hydraulic Oil Filter.....	H-56600			Hydraulic Oil Filter.....	H-5646
		PC158USLC-2 (EXCAVATORS) S4D102E-1		Hydraulic Oil Filter.....	H-5629
PC150LC-6K (EXCAVATORS) SA4D102E-1A/K30001/21240928		Air Filter Primary.....	A-5541	PC160LC-7E0 (EXCAVATORS) KOMATSU SAA4D107E-1	
Air Filter Secondary.....	A-7964	Air Filter Secondary.....	A-5540	Air Filter Primary.....	A-56731
Air Filter Primary.....	AS-7988	Hydraulic Oil Filter.....	H-56600	Air Filter Set.....	A-56731-S
Fuel Filter Secondary.....	FC-7903			PC160LC-7E0 (EXCAVATORS) SAA4D107E-1	
Fuel/Water Separator.....	SFC-5708	PC15R-8 (EXCAVATORS) 3D68E-3		Air Filter Primary.....	A-5673
Hydraulic Oil Filter.....	H-56600	Air Filter Primary.....	A-8504	Air Filter Set.....	A-5675-S
Hydraulic Oil Filter.....	H-5610	Fuel Filter.....	F-5207	Cabin Air Filter.....	CA-56041
		Oil Filter Full Flow.....	C-5205	Hydraulic Oil Filter.....	H-5629
PC15-1 (EXCAVATORS) 3D78-1		PC15R-8 (EXCAVATORS)		Hydraulic Oil Filter.....	H-5646
Air Filter Primary.....	AS-2205	Fuel Filter.....	F-5207	Hydraulic Breather.....	H-56610
Fuel Filter.....	F-5210	Oil Filter Full Flow.....	C-5205	Oil Filter Full Flow.....	C-5611
Hydraulic Oil Filter.....	H-5607			PC160LC-7E0 (EXCAVATORS) SAA4D107E-1 (TIER 3)	
Oil Filter Full Flow.....	C-1720	PC1600 (EXCAVATORS) SA6D140		Air Filter Secondary.....	A-5674
		Air Filter Secondary.....	A-5610	PC160LC-7K (EXCAVATORS) KOMATSU SAA4D102E	
PC15-1 (EXCAVATORS) 3D78-1/1001/00603		Air Filter Primary.....	A-5614	Air Filter Primary.....	A-56731
Air Filter Primary.....	AS-2205	Coolant Filter.....	WC-6901	Air Filter Set.....	A-56731-S
Fuel Filter.....	F-5210	Fuel Filter.....	FC-5703	Air Filter Secondary.....	A-56741
Hydraulic Oil Filter.....	H-5607	Fuel/Water Separator.....	SFC-5707		
Oil Filter Full Flow.....	C-8012	Hydraulic Oil Filter.....	H-7911	PC160LC-7K (EXCAVATORS) SAA4D102E	
		Hydraulic Oil Filter.....	H-85680	Air Filter Set.....	A-5675-S
PC15-2 (EXCAVATORS) 3D78-1		Oil Filter Full Flow.....	C-5605	Air Filter Secondary.....	A-5674
Air Filter Primary.....	AS-2205	Oil Filter Full Flow.....	C-5715	Air Filter Primary.....	A-5673
Fuel Filter.....	F-5210	Oil Filter Full Flow.....	C-5701	Air Filter Secondary.....	A-8670
Hydraulic Oil Filter.....	H-5607	Oil Filter By Pass.....	C-5718	Cabin Air Filter.....	CA-5602
Oil Filter Full Flow.....	C-1720			Cabin Air Filter.....	CA-56041
		PC160-6K (EXCAVATORS)		Fuel Filter.....	F-5218
PC15-2 (EXCAVATORS) 3D78-1/10001/02853		Air Filter Primary.....	AS-7988	Hydraulic Oil Filter.....	H-5646
Air Filter Primary.....	AS-2205	Air Filter Secondary.....	A-7964	Hydraulic Oil Filter.....	H-5629
Fuel Filter.....	F-5210	Fuel Filter Secondary.....	FC-7903		
Hydraulic Oil Filter.....	H-5607	Fuel/Water Separator.....	SFC-5708	PC170 (EXCAVATORS) 2007	
Oil Filter Full Flow.....	C-8012	Hydraulic Oil Filter.....	H-56600	Air Filter Secondary.....	A-7964
		Hydraulic Oil Filter.....	H-5610	Air Filter Primary.....	AS-7988
PC15-3 (EXCAVATORS) 3D82E-3/10001/UP		PC160-7 (EXCAVATORS)		Fuel Filter.....	FC-5715
Air Filter Primary.....	AS-2205	Air Filter Primary.....	A-5673		
Fuel Filter.....	F-5207	Air Filter Set.....	A-5675-S		
Oil Filter Full Flow.....	C-8012				
Oil Filter Full Flow.....	C-5708				

MODEL/APPLICATION	SAKURA NO	MODEL/APPLICATION	SAKURA NO	MODEL/APPLICATION	SAKURA NO
KOMATSU		KOMATSU		KOMATSU	
PC170 (EXCAVATORS) 2007		PC18MR-2 (EXCAVATORS) KOMATSU 3D67E-5		PC130-8 (EXCAVATORS) SAA4D95LE-5	
Hydraulic Oil Filter.....	H-5610	Hydraulic Oil Filter.....	H-56530	Air Filter Primary.....	A-5541
Hydraulic Oil Filter.....	H-56600			Air Filter Secondary.....	A-5540
Oil Filter Full Flow.....	C-5102			Hydraulic Oil Filter additional part..	H-7105
		PC118MR-8 (EXCAVATORS) SAA4D95LE-5 , 2011		Hydraulic Oil Filter.....	H-5635
PC180 (EXCAVATORS) PERKINS		Air Filter Primary.....	A-5541	Hydraulic Oil Filter.....	H-56650
Fuel Filter.....	FC-5715	Air Filter Secondary.....	A-5540	Oil Filter Full Flow.....	C-56190
Hydraulic Oil Filter.....	H-5610	Cabin Air Filter.....	CA-56041	Oil Filter Full Flow.....	C-56191
Hydraulic Oil Filter.....	H-56600	Fuel/Water Separator.....	SFC-56040		
Oil Filter Full Flow.....	C-5102	Hydraulic Oil Filter.....	H-56650		
		Hydraulic Breather.....	H-56610	PC138USLC-2 (EXCAVATORS) KOMATSU S4D102E-1V-2	
PC180 (EXCAVATORS) SAA4D102		Oil Filter Full Flow.....	C-56190	Oil Filter Full Flow.....	C-5712
Air Filter Primary.....	AS-7988	Oil Filter Full Flow.....	C-56191		
				PC138USLC-2 (EXCAVATORS) S4D102E/1001/1500	
PC180-3 (EXCAVATORS)		PC138USLC-2A (EXCAVATORS) 1501		Air Filter Secondary.....	A-5540
Air Filter Primary.....	AS-7805	Air Filter Primary.....	A-5541	Air Filter Primary.....	A-5541
Air Filter Secondary.....	A-7806	Air Filter Secondary.....	A-5540		
Fuel Filter.....	FC-5604	Fuel Filter.....	FC-1801	PC138USLC-2 (EXCAVATORS) S/N: 1501	
Hydraulic Oil Filter.....	H-5610	Hydraulic Oil Filter.....	H-56650	Air Filter Secondary.....	A-5540
Hydraulic Oil Filter.....	H-56600	Oil Filter Full Flow.....	C-56190	Air Filter Primary.....	A-5541
Oil Filter Full Flow.....	C-5604	Oil Filter Full Flow.....	C-56191	Fuel Filter.....	FC-1801
Oil Filter Full Flow.....	C-5405			Hydraulic Oil Filter.....	H-56650
		PC160LC-8 (EXCAVATORS) KOMATSU SAA4D107E-1D , 2011		Oil Filter Full Flow.....	C-56190
PC180-5K (EXCAVATORS)		Air Filter Primary.....	A-56731	Oil Filter Full Flow.....	C-56191
Air Filter Secondary.....	A-7964	Air Filter Set.....	A-56731-S		
Air Filter Primary.....	AS-7988	Air Filter Secondary.....	A-56741	PC1800-6 (EXCAVATORS) SAA4D140E	
Fuel Filter.....	FC-5715			Air Filter Primary.....	A-6010
Hydraulic Oil Filter.....	H-56600	PC160LC-8 (EXCAVATORS) SAA4D107E-1D , 2011		Fuel/Water Separator Secondary..	SFC-5611-10B
Hydraulic Oil Filter.....	H-5610	Air Filter Set.....	A-5675-S	Fuel/Water Separator Secondary..	SFC-5611-10
Hydraulic Oil Filter Suction.....	H-2706	Air Filter Primary.....	A-5673	Fuel/Water Separator.....	SFC-5601-02
Oil Filter Full Flow.....	C-5102	Air Filter Secondary.....	A-8670	Oil Filter Full Flow.....	C-5701
		Cabin Air Filter.....	CA-56041	Oil Filter By Pass.....	C-5718
PC180L-3 (EXCAVATORS) S6D95L-1P		Fuel Filter.....	FC-5713	Oil Filter Full Flow.....	C-5715
Air Filter Primary.....	AS-7805	Hydraulic Oil Filter.....	H-5646	Oil Filter Full Flow.....	C-5605
Oil Filter Full Flow.....	C-5606	Hydraulic Oil Filter.....	H-5629		
		Hydraulic Breather.....	H-56610	PC138USLC-11 (EXCAVATORS) KOMATSU SAA4D95LE-7	
PC180-LC3 (EXCAVATORS) S6D95L-1		Oil Filter Full Flow.....	C-5611	Fuel Filter.....	FC-56320
Air Filter Primary.....	AS-7805				
Air Filter Secondary.....	A-7806	PC160LC-8 (EXCAVATORS) SAA4D107E-1D		PC138USLC-11 (EXCAVATORS)	
Coolant Filter.....	WC-5707	Air Filter Secondary.....	A-5674	Hydraulic Oil Filter.....	H-56100
Fuel Filter.....	FC-5604	Fuel Filter.....	FC-5613		
Hydraulic Oil Filter.....	H-5610			PC180LC-7E0 (EXCAVATORS) SAA4D107E-1 (S/N K45001-UP)	
Hydraulic Oil Filter.....	H-56600	PC180LC-3 (EXCAVATORS)		Air Filter Secondary.....	A-5674
Oil Filter Full Flow.....	C-5405	Air Filter Primary.....	AS-7805	Fuel Filter.....	FC-5613
		Air Filter Secondary.....	A-7806		
PC180LC-6K (EXCAVATORS)		Fuel Filter.....	FC-5604	PC180LC-7K (EXCAVATORS) SAA4D102E-4 (S/N K40001-UP)	
Fuel/Water Separator.....	SFC-5708	Hydraulic Oil Filter.....	H-5610	Air Filter Secondary.....	A-5674
Hydraulic Oil Filter.....	H-56600	Hydraulic Oil Filter.....	H-56600		
		Oil Filter Full Flow.....	C-5604	PC180NLC-7E0 (EXCAVATORS) SAA4D107E-1 (S/N K45001-UP)	
PC180LLC-3 (EXCAVATORS) S6D95L-1P				Air Filter Secondary.....	A-5674
Air Filter Primary.....	AS-7805	PC180LC-7 (EXCAVATORS) 2004		Fuel Filter.....	FC-5613
Oil Filter Full Flow.....	C-5606	Air Filter Secondary.....	A-8670		
				PC180NLC-7K (EXCAVATORS) SAA4D102E-4 (S/N K40001-UP)	
PC18MR-2 (EXCAVATORS) KUBOTA , 2005		PC110R-1 (EXCAVATORS)		Air Filter Secondary.....	A-5674
Fuel Filter.....	F-5207	Air Filter Primary.....	A-5541		
Fuel Filter.....	F-5214	Air Filter Secondary.....	A-5540	PC1250-8R (EXCAVATORS) KOMATSU SAA6D170E-5CR	

MODEL/APPLICATION	SAKURA NO	MODEL/APPLICATION	SAKURA NO	MODEL/APPLICATION	SAKURA NO
KOMATSU		KOMATSU		KOMATSU	
PC1250-8R (EXCAVATORS) KOMATSU SAA6D170E-5CR Fuel/Water Separator.....	SFC-56020	Hydraulic Oil Filter.....	H-85680	Coolant Filter.....	WC-5707
Fuel/Water Separator.....	SFC-56020B	Oil Filter Full Flow.....	C-5614	Hydraulic Oil Filter.....	H-85680
PC1250-8R (EXCAVATORS) KOMATSU SAA6D170E-5CR-W Fuel/Water Separator.....	SFC-56020B	PC200 (EXCAVATORS) KOMATSU S6D95L-1 Fuel Filter.....	FC-5601	Hydraulic Oil Filter.....	H-7911
Fuel/Water Separator.....	SFC-56020	PC200 (EXCAVATORS) S6D105 Air Filter Primary.....	A-5605	Oil Filter Full Flow.....	C-5614
PC1250LC-8R (EXCAVATORS) KOMATSU SAA6D170E-5CR Fuel/Water Separator.....	SFC-56020B	Air Filter Secondary.....	A-5606	PC200-1 (EXCAVATORS) S6D105 Air Filter Secondary.....	A-5603
Fuel/Water Separator.....	SFC-56020	Air Filter Set.....	A-5604-S	Air Filter Primary.....	A-5602
PC1250LC-8R (EXCAVATORS) KOMATSU SAA6D170E-5CR-W Fuel/Water Separator.....	SFC-56020B	Hydraulic Oil Filter.....	H-5609	Coolant Filter.....	WC-5707
Fuel/Water Separator.....	SFC-56020	Oil Filter Full Flow.....	C-5614	Hydraulic Oil Filter.....	H-7911
PC1250SP-8R (EXCAVATORS) KOMATSU SAA6D170E-5CR Fuel/Water Separator.....	SFC-56020	PC200 (EXCAVATORS) S6D95 Air Filter Primary.....	AS-1024	Hydraulic Oil Filter.....	H-85680
Fuel/Water Separator.....	SFC-56020B	Air Filter Set.....	AS-1024-S	Oil Filter Full Flow.....	C-5614
PC1250SP-8R (EXCAVATORS) KOMATSU SAA6D170E-5CR-W Fuel/Water Separator.....	SFC-56020	Air Filter Primary.....	A-5602	PC200-1SER (EXCAVATORS) 6D105-1 Air Filter Primary.....	AS-1024
Fuel/Water Separator.....	SFC-56020B	Air Filter Secondary.....	A-5606	Air Filter Set.....	AS-1024-S
PC1250SP-8R (EXCAVATORS) KOMATSU SAA6D170E-5CR-W Fuel/Water Separator.....	SFC-56020B	Air Filter Secondary.....	A-6009	Air Filter Secondary.....	A-6009
Fuel/Water Separator.....	SFC-56020B	Air Filter Secondary.....	A-5603	Coolant Filter.....	WC-5707
PC100L-6 (EXCAVATORS) KOMATSU S4D102E-1D Oil Filter Full Flow.....	C-5712	Coolant Filter.....	WC-5707	Oil Filter Full Flow.....	C-5614
PC120-6Z (EXCAVATORS) KOMATSU S4D102E-1E Oil Filter Full Flow.....	C-5712	Hydraulic Oil Filter.....	H-85680	PC200-2 (EXCAVATORS) 6D105 Air Filter Primary.....	AS-1024
PC20 (EXCAVATORS) 3TN75E Air Filter Primary.....	AS-1014	Hydraulic Oil Filter.....	H-7911	Air Filter Secondary.....	A-6009
Hydraulic Oil Filter.....	H-5607	PC2000 (EXCAVATORS) Air Filter Secondary.....	A-8580	Air Filter Set.....	AS-1024-S
PC20 (EXCAVATORS) 3TNE74 Air Filter Primary.....	AS-1014	Air Filter Primary.....	A-8665M	Coolant Filter.....	WC-5707
Hydraulic Oil Filter.....	H-5607	Cabin Air Filter.....	CA-56041	Hydraulic Oil Filter.....	H-85680
PC20 (EXCAVATORS) Air Filter Primary.....	AS-2205	Fuel/Water Separator Secondary..	SFC-5611-10B	Hydraulic Oil Filter.....	H-7911
Fuel Filter.....	F-5207	Fuel/Water Separator Secondary...	SFC-5611-10	Oil Filter Full Flow.....	C-5614
Hydraulic Oil Filter.....	H-5607	Hydraulic Oil Filter.....	HC-5601	PC200-2 (EXCAVATORS) KOMATSU 6D105-1F Hydraulic Oil Filter.....	H-5613
Oil Filter Full Flow.....	C-1920	PC2000-8 (EXCAVATORS) KOMATSU SAA12V140E-3 , 2007 Air Filter Primary.....	A-8665M	PC200-3 (EXCAVATORS) S6D105 Air Filter Set.....	A-5604-S
PC200 (EXCAVATORS) 6BT5.9 Coolant Filter.....	WC-5707	Air Filter Secondary.....	A-8580	Air Filter Secondary.....	A-5635
Fuel Filter Secondary.....	FC-7903	Cabin Air Filter.....	CA-56041	Air Filter Primary.....	A-5639
Fuel/Water Separator.....	SFC-5708	Coolant Filter.....	WC-56010	Air Filter Primary.....	A-5605
Fuel/Water Separator.....	SFC-5706	Fuel/Water Separator Secondary..	SFC-5611-10B	Air Filter Secondary.....	A-5606
Hydraulic Oil Filter.....	H-5609	Fuel/Water Separator Secondary...	SFC-5611-10	Hydraulic Oil Filter.....	H-5609
Oil Filter Full Flow.....	C-5610	Hydraulic Oil Filter.....	HC-5601	Oil Filter Full Flow.....	C-5608
PC200 (EXCAVATORS) 6D105 Air Filter Secondary.....	A-6009	PC2000-8 (EXCAVATORS) KOMATSU SA6D140E-3 Fuel/Water Separator.....	SFC-56020B	PC200-3 (EXCAVATORS) S6D105-1/20001/61481/78804 Air Filter Secondary.....	A-5606
Hydraulic Oil Filter.....	H-7911	Fuel/Water Separator.....	SFC-56020	Air Filter Primary.....	A-5605
PC200 (EXCAVATORS) 6D105 Air Filter Secondary.....	A-6003	PC2000-8 (EXCAVATORS) SAA12V140E-3 Fuel Filter.....	FC-5614	Air Filter Set.....	A-5604-S
Hydraulic Oil Filter.....	H-7911	Fuel Filter.....	FC-56230	Coolant Filter.....	WC-5707
PC200 (EXCAVATORS) 6D105 Air Filter Secondary.....	A-5603	PC2000-8 (EXCAVATORS) SAA12V140E-3 Coolant Filter.....	WC-56010	Hydraulic Oil Filter.....	H-5609
Hydraulic Oil Filter.....	H-7911	Hydraulic Oil Filter.....	HC-5601	Oil Filter Full Flow.....	C-5614
PC200-1 (EXCAVATORS) 6D105 Air Filter Secondary.....	A-5603	PC200-1 (EXCAVATORS) 6D105 Air Filter Secondary.....	A-5603	PC200-3SER (EXCAVATORS) Air Filter Secondary.....	A-5635
Air Filter Primary.....	A-5602	Air Filter Primary.....	A-5602	Air Filter Primary.....	A-5639

MODEL/APPLICATION	SAKURA NO	MODEL/APPLICATION	SAKURA NO	MODEL/APPLICATION	SAKURA NO
KOMATSU		KOMATSU		KOMATSU	
PC200-3SER (EXCAVATORS)		PC200-6 (EXCAVATORS) S6D95L		Fuel/Water Separator.....	SFC-5706
Hydraulic Oil Filter.....	H-5609	Air Filter Primary.....	A-5639	Fuel/Water Separator.....	SFC-5708
Oil Filter Full Flow.....	C-5608	Air Filter Secondary.....	A-5635	Hydraulic Oil Filter Suction.....	H-2706
PC200-5 (EXCAVATORS) S6D95L-1/45001/35360		Fuel Filter.....	FS-5601	Hydraulic Oil Filter.....	H-56600
Air Filter Primary.....	A-5627	Hydraulic Oil Filter.....	H-85680	Hydraulic Oil Filter.....	H-5610
Air Filter Set.....	A-5663-S	Oil Filter Full Flow.....	C-5606	Oil Filter Full Flow.....	C-5730
Air Filter Secondary.....	A-6008	PC200-6 (EXCAVATORS) S6D95L-1/80001/111868		PC200-7 (EXCAVATORS) SAA6D102E-2 , 2003	
Hydraulic Oil Filter.....	H-7911	Air Filter Primary.....	A-5639	Hydraulic Oil Filter.....	H-5646
Hydraulic Oil Filter.....	H-85680	Air Filter Secondary.....	A-5635	Hydraulic Oil Filter.....	H-5629
Hydraulic Breather.....	H-56610	Coolant Filter.....	WC-5707	PC200-7 (EXCAVATORS) SAA6D102E	
Oil Filter Full Flow.....	C-5606	Hydraulic Oil Filter.....	H-85680	Air Filter Primary.....	A-8577
PC200-5 (EXCAVATORS) S6D95L/45001		Hydraulic Oil Filter.....	H-7911	Air Filter Secondary.....	A-8578
Air Filter Primary.....	A-5627	Hydraulic Breather.....	H-56610	Cabin Air Filter.....	CA-5602
Air Filter Set.....	A-5663-S	Oil Filter Full Flow.....	C-5606	Cabin Air Filter.....	CA-56041
Air Filter Secondary.....	A-6008	PC200-6A (EXCAVATORS) S6D102-1		Fuel Filter.....	FC-5621
Hydraulic Oil Filter.....	H-7911	Air Filter Secondary.....	A-5635	Fuel Filter.....	F-5218
Hydraulic Oil Filter.....	H-85680	Air Filter Primary.....	A-5639	Hydraulic Oil Filter.....	H-5646
Hydraulic Breather.....	H-56610	Fuel Filter.....	FS-5601	Hydraulic Oil Filter.....	H-5629
Oil Filter Full Flow.....	C-5606	Fuel Filter Secondary.....	FC-7903	PC200-7B (EXCAVATORS) SAA6D102E	
PC200-5SER (EXCAVATORS)		Fuel/Water Separator.....	SFC-5706	Air Filter Secondary.....	A-8578
Air Filter Primary.....	A-5627	Fuel/Water Separator.....	SFC-5708	Air Filter Primary.....	A-8577
Air Filter Set.....	A-5663-S	Hydraulic Oil Filter.....	H-85680	Cabin Air Filter.....	CA-56041
Air Filter Secondary.....	A-6008	PC200-6A (EXCAVATORS) S6D102E		Cabin Air Filter.....	CA-5602
Hydraulic Oil Filter.....	H-7911	Air Filter Secondary.....	A-5635	Fuel Filter.....	F-5218
Hydraulic Oil Filter.....	H-85680	Air Filter Primary.....	A-5639	Fuel Filter.....	FC-5621
Hydraulic Breather.....	H-56610	Fuel Filter.....	FS-5601	Hydraulic Oil Filter.....	H-5646
Oil Filter Full Flow.....	C-5606	Fuel Filter Secondary.....	FC-7903	Hydraulic Oil Filter.....	H-5629
PC200-6 (EXCAVATORS) S6D102-1		Fuel/Water Separator.....	SFC-5706	PC200-8 (EXCAVATORS) KOMATSU SAA6D107E	
Air Filter Primary.....	A-5639	Fuel/Water Separator.....	SFC-5708	Hydraulic Oil Filter additional part..	H-7105
Air Filter Secondary.....	A-5635	Hydraulic Oil Filter.....	H-85680	PC200-8 (EXCAVATORS) SAA6D107E	
Fuel Filter.....	FS-5601	PC200-6B (EXCAVATORS) S6D102-1		Air Filter Primary.....	A-5666
Fuel Filter Secondary.....	FC-7903	Air Filter Primary.....	A-5639	Air Filter Secondary.....	A-5667
Fuel/Water Separator.....	SFC-5708	Air Filter Secondary.....	A-5635	Cabin Air Filter.....	CA-56041
Fuel/Water Separator.....	SFC-5706	Fuel Filter.....	FS-5601	Hydraulic Oil Filter.....	H-5629
Hydraulic Oil Filter.....	H-85680	Fuel Filter Secondary.....	FC-7903	Hydraulic Oil Filter.....	H-5646
PC200-6 (EXCAVATORS) S6D102E		Fuel/Water Separator.....	SFC-5706	Hydraulic Breather.....	H-56610
Air Filter Primary.....	A-5639	Fuel/Water Separator.....	SFC-5708	PC200-8 (EXCAVATORS) SAA6D107E-1	
Air Filter Secondary.....	A-5635	Hydraulic Oil Filter.....	H-85680	Fuel Filter.....	FC-5613
Fuel Filter.....	FS-5601	PC200-6B (EXCAVATORS) S6D102E		PC200LC-2 (EXCAVATORS) 6D105	
Fuel Filter Secondary.....	FC-7903	Air Filter Primary.....	A-5639	Air Filter Primary.....	AS-1024
Fuel/Water Separator.....	SFC-5708	Air Filter Secondary.....	A-5635	Air Filter Set.....	AS-1024-S
Fuel/Water Separator.....	SFC-5706	Fuel Filter.....	FS-5601	Air Filter Secondary.....	A-6009
Hydraulic Oil Filter.....	H-85680	Fuel Filter Secondary.....	FC-7903	Coolant Filter.....	WC-5707
PC200-6 (EXCAVATORS) S6D102E-1/96514		Fuel/Water Separator.....	SFC-5706	Hydraulic Oil Filter.....	H-7911
Air Filter Secondary.....	A-5635	Fuel/Water Separator.....	SFC-5708	Hydraulic Oil Filter.....	H-85680
Air Filter Primary.....	A-5639	Hydraulic Oil Filter.....	H-85680	Oil Filter Full Flow.....	C-5614
Fuel Filter Secondary.....	FC-7903	PC200-6K (EXCAVATORS)		PC200LC-3 (EXCAVATORS) S6D105	
Fuel/Water Separator.....	SFC-5708	Air Filter Secondary.....	A-5671	Air Filter Secondary.....	A-5635
Hydraulic Oil Filter.....	H-85680	Air Filter Set.....	AS-5672-S	Air Filter Secondary.....	A-5606
Hydraulic Breather.....	H-56610	Air Filter Primary.....	AS-5670	Air Filter Primary.....	A-5639
Oil Filter Full Flow.....	C-5730	Fuel Filter Secondary.....	FC-7903		

MODEL/APPLICATION	SAKURA NO	MODEL/APPLICATION	SAKURA NO	MODEL/APPLICATION	SAKURA NO
KOMATSU		KOMATSU		KOMATSU	
PC200LC-3 (EXCAVATORS) S6D105		Fuel/Water Separator.....	SFC-5708	Fuel Filter Secondary.....	FC-7903
Air Filter Set.....	A-5604-S	Fuel/Water Separator.....	SFC-5706	Fuel/Water Separator.....	SFC-5706
Air Filter Primary.....	A-5605	Hydraulic Oil Filter.....	H-85680	Fuel/Water Separator.....	SFC-5706
Hydraulic Oil Filter.....	H-5609			Hydraulic Oil Filter.....	H-85680
Oil Filter Full Flow.....	C-5614	PC200LC-6 (EXCAVATORS) S6D102E-1/96514		PC200LL-6 (EXCAVATORS) S6D102E	
Oil Filter Full Flow.....	C-5608	Air Filter Secondary.....	A-5635	Air Filter Secondary.....	A-5635
PC200LC-3 (EXCAVATORS) S6D105-1/20001/61481/78804		Air Filter Primary.....	A-5639	Air Filter Primary.....	A-5639
Air Filter Set.....	A-5604-S	Fuel Filter Secondary.....	FC-7903	Fuel Filter Secondary.....	FC-7903
Air Filter Primary.....	A-5605	Fuel/Water Separator.....	SFC-5708	Fuel Filter Secondary.....	FC-7903
Air Filter Secondary.....	A-5606	Hydraulic Oil Filter.....	H-85680	Fuel Filter.....	FS-5601
Coolant Filter.....	WC-5707	Hydraulic Breather.....	H-56610	Fuel/Water Separator.....	SFC-5708
Hydraulic Oil Filter.....	H-5609	Oil Filter Full Flow.....	C-5730	Fuel/Water Separator.....	SFC-5706
Oil Filter Full Flow.....	C-5614			Hydraulic Oil Filter.....	H-85680
PC200LC-3 (EXCAVATORS) S6D105-1/20001/78805		PC200LC-6 (EXCAVATORS) S6D95L		PC200LL-7 (EXCAVATORS) SAA6D102E	
Air Filter Secondary.....	A-5635	Air Filter Secondary.....	A-5635	Air Filter Primary.....	A-8577
Air Filter Primary.....	A-5639	Air Filter Primary.....	A-5639	Air Filter Secondary.....	A-8578
Hydraulic Oil Filter.....	H-5609	Fuel Filter.....	FS-5601	Cabin Air Filter.....	CA-5602
Oil Filter Full Flow.....	C-5608	Hydraulic Oil Filter.....	H-85680	Cabin Air Filter.....	CA-56041
PC200LC-5 (EXCAVATORS) KOMATSU S6D95L-1		Oil Filter Full Flow.....	C-5606	Fuel Filter.....	F-5218
Fuel Filter.....	FC-5601			Fuel Filter.....	FC-5621
PC200LC-5 (EXCAVATORS) S6D95L-1/45001/35360		PC200LC-7 (EXCAVATORS) SAA6D102E		Hydraulic Oil Filter.....	H-5629
Air Filter Set.....	A-5663-S	Air Filter Secondary.....	A-8578	Hydraulic Oil Filter.....	H-5646
Air Filter Primary.....	A-5627	Air Filter Primary.....	A-8577	Hydraulic Oil Filter.....	H-5629
Air Filter Secondary.....	A-6008	Cabin Air Filter.....	CA-56041		
Hydraulic Oil Filter.....	H-85680	Cabin Air Filter.....	CA-5602	PC200Z-6 (EXCAVATORS) S6D102-1	
Hydraulic Oil Filter.....	H-7911	Fuel Filter.....	FC-5621	Air Filter Primary.....	A-5639
Hydraulic Breather.....	H-56610	Fuel Filter.....	F-5218	Air Filter Secondary.....	A-5635
Oil Filter Full Flow.....	C-5606	Hydraulic Oil Filter.....	H-5646	Fuel Filter Secondary.....	FC-7903
PC200LC-5 (EXCAVATORS) S6D95L/45001		Hydraulic Oil Filter.....	H-5629	Fuel Filter.....	FS-5601
Air Filter Secondary.....	A-6008	PC200LC-7B (EXCAVATORS) SAA6D102E		Fuel/Water Separator.....	SFC-5706
Air Filter Set.....	A-5663-S	Air Filter Secondary.....	A-8578	Fuel/Water Separator.....	SFC-5708
Air Filter Primary.....	A-5627	Air Filter Primary.....	A-8577	Hydraulic Oil Filter.....	H-85680
Air Filter Secondary.....	A-6008	Cabin Air Filter.....	CA-5602		
Hydraulic Oil Filter.....	H-85680	Cabin Air Filter.....	CA-56041	PC200Z-6 (EXCAVATORS) S6D102E	
Hydraulic Oil Filter.....	H-7911	Fuel Filter.....	F-5218	Air Filter Secondary.....	A-5635
Hydraulic Breather.....	H-56610	Fuel Filter.....	FC-5621	Air Filter Primary.....	A-5639
Oil Filter Full Flow.....	C-5606	Hydraulic Oil Filter.....	H-5646	Fuel Filter.....	FS-5601
PC200LC-6 (EXCAVATORS) S6D102-1		Hydraulic Oil Filter.....	H-5629	Fuel Filter Secondary.....	FC-7903
Air Filter Secondary.....	A-5635	PC200LC-8 (EXCAVATORS) KOMATSU SAA6D107E-1B		Fuel/Water Separator.....	SFC-5706
Air Filter Primary.....	A-5639	Hydraulic Oil Filter additional part..	H-7105	Fuel/Water Separator.....	SFC-5708
Fuel Filter Secondary.....	FC-7903			Hydraulic Oil Filter.....	H-85680
Fuel Filter.....	FS-5601	PC200LC-8 (EXCAVATORS) SAA6D107E		PC200Z-6LE (EXCAVATORS) S6D102-1	
Fuel/Water Separator.....	SFC-5708	Air Filter Secondary.....	A-5667	Air Filter Secondary.....	A-5635
Fuel/Water Separator.....	SFC-5706	Air Filter Primary.....	A-5666	Air Filter Primary.....	A-5639
Hydraulic Oil Filter.....	H-85680	Cabin Air Filter.....	CA-56041	Fuel Filter.....	FS-5601
PC200LC-6 (EXCAVATORS) S6D102E		Hydraulic Oil Filter.....	H-5629	Fuel Filter Secondary.....	FC-7903
Air Filter Secondary.....	A-5635	Hydraulic Oil Filter.....	H-5646	Fuel/Water Separator.....	SFC-5708
Air Filter Primary.....	A-5639	Hydraulic Breather.....	H-56610	Fuel/Water Separator.....	SFC-5706
Fuel Filter.....	FS-5601	PC200LC-8 (EXCAVATORS) SAA6D107E-1		Hydraulic Oil Filter.....	H-85680
Fuel/Water Separator.....	SFC-5708	Fuel Filter.....	FC-5613	PC200Z-6LE (EXCAVATORS) S6D102E	
Fuel/Water Separator.....	SFC-5706	PC200LL-6 (EXCAVATORS) S6D102-1		Air Filter Secondary.....	A-5635
Hydraulic Oil Filter.....	H-85680	Air Filter Secondary.....	A-5635	Air Filter Primary.....	A-5639
PC200LC-6 (EXCAVATORS) S6D102E		Air Filter Primary.....	A-5639	Fuel Filter.....	FS-5601
Air Filter Secondary.....	A-5635	Fuel Filter.....	FS-5601	Fuel Filter Secondary.....	FC-7903
Air Filter Primary.....	A-5639	Air Filter Secondary.....	A-5635	Fuel/Water Separator.....	SFC-5708
Fuel Filter.....	FS-5601	Air Filter Primary.....	A-5639	Fuel/Water Separator.....	SFC-5706
Fuel Filter Secondary.....	FC-7903	Fuel Filter.....	FS-5601	Hydraulic Oil Filter.....	H-85680

MODEL/APPLICATION	SAKURA NO	MODEL/APPLICATION	SAKURA NO	MODEL/APPLICATION	SAKURA NO
KOMATSU		KOMATSU		KOMATSU	
PC200Z-6LE (EXCAVATORS) S6D102E		PC20-7 (EXCAVATORS) 3D82E-3/42355/42355		PC20R-8 (EXCAVATORS) 3D84E-3/10001	
Fuel/Water Separator.....	SFC-5706	Fuel Filter.....	F-5207	Air Filter Primary.....	A-8504
Hydraulic Oil Filter.....	H-85680	Oil Filter Full Flow.....	C-1011	Fuel Filter.....	F-5207
		Oil Filter Full Flow.....	C-5708	Oil Filter Full Flow.....	C-5708
PC20-1 (EXCAVATORS) 2D94-2		PC20-7 (EXCAVATORS) 3D84N-2/35001/42354		Oil Filter Full Flow.....	C-5205
Oil Filter Full Flow.....	C-5606	Fuel Filter.....	F-5210	PC20-SER (EXCAVATORS) 3D84-1	
PC20-2 (EXCAVATORS) 3D75-1		Oil Filter Full Flow.....	C-5708	Fuel Filter.....	F-5207
Hydraulic Oil Filter.....	H-5607	Oil Filter Full Flow.....	C-8012	Hydraulic Oil Filter.....	H-5607
PC20-2 (EXCAVATORS) 3D84-1		PC20-8 (EXCAVATORS)		Oil Filter Full Flow.....	C-1920
Air Filter.....	A-8568	Fuel Filter.....	F-5207	PC210 (EXCAVATORS) BT5.9	
Air Filter Primary.....	AS-2205	Oil Filter Full Flow.....	C-5205	Coolant Filter.....	WC-5707
Fuel Filter.....	F-5207	PC20HT-1 (EXCAVATORS) 4D130-1		Hydraulic Oil Filter.....	H-5609
Oil Filter Full Flow.....	C-1920	Fuel Filter.....	F-2626	PC210 (EXCAVATORS)	
PC20-3 (EXCAVATORS) 3D75-1		Hydraulic Oil Filter.....	H-85680	Air Filter Primary.....	AS-5670
Hydraulic Oil Filter.....	H-5607	Hydraulic Oil Filter.....	H-7911	Air Filter Secondary.....	A-5671
PC20-3 (EXCAVATORS) 3D84-1		Oil Filter Full Flow.....	O-5601	Air Filter Set.....	AS-5672-S
Air Filter.....	A-8568	PC20MR-2 (EXCAVATORS) 3D67E-5		Oil Filter Full Flow.....	C-5614
Air Filter Primary.....	AS-2205	Air Filter Secondary.....	A-7618	PC210-3 (EXCAVATORS)	
Fuel Filter.....	F-5207	Air Filter Primary.....	A-8504	Air Filter Primary.....	AS-5670
Oil Filter Full Flow.....	C-1920	Fuel Filter.....	F-5207	Air Filter Set.....	AS-5672-S
PC20-5 (EXCAVATORS) 3D84-1		Oil Filter Full Flow.....	C-8012	Fuel Filter.....	FC-5715
Air Filter Primary.....	AS-2205	PC20MRX-1 (EXCAVATORS) 3D74E		Hydraulic Oil Filter.....	H-5609
Fuel Filter.....	F-5207	Air Filter Primary.....	A-8504	PC210-3 (EXCAVATORS) S/N: 10001	
Hydraulic Oil Filter.....	H-5607	Fuel Filter.....	F-5207	Air Filter Primary.....	A-5639
Oil Filter Full Flow.....	C-1920	PC20R (EXCAVATORS) 3D74E		Hydraulic Oil Filter.....	H-5609
PC20-5 (EXCAVATORS) 3D84-1/18001/13021		Air Filter Primary.....	A-8504	Oil Filter Full Flow.....	C-5608
Air Filter Primary.....	AS-2205	Fuel Filter.....	F-5207	PC210-5K (EXCAVATORS)	
Fuel Filter.....	F-5207	PC20R-8 (EXCAVATORS) 3D82AE/10001		Air Filter Secondary.....	A-5671
Hydraulic Oil Filter.....	H-5607	Air Filter Primary.....	A-8513	Air Filter Set.....	AS-5672-S
Oil Filter Full Flow.....	C-1920	Air Filter Primary.....	A-8504	Air Filter Primary.....	AS-5670
PC20-6 (EXCAVATORS) 3D84-1		Fuel Filter.....	F-5207	Fuel Filter.....	FC-5715
Air Filter Primary.....	AS-2205	Oil Filter Full Flow.....	C-8012	Hydraulic Oil Filter.....	H-85680
Fuel Filter.....	F-5207	Oil Filter Full Flow.....	C-5205	Hydraulic Oil Filter.....	H-7911
Hydraulic Oil Filter.....	H-5607	PC20R-8 (EXCAVATORS) 3D82AE-3E/10001		Oil Filter Full Flow.....	C-5102
Oil Filter Full Flow.....	C-1920	Air Filter Primary.....	A-8513	PC210-6 (EXCAVATORS) S6D102E-1/30980	
PC20-6 (EXCAVATORS) 3D84-1/24001/25916		Air Filter Primary.....	A-8504	Air Filter Secondary.....	A-5635
Air Filter Primary.....	AS-2205	Fuel Filter.....	F-5207	Air Filter Primary.....	A-5639
Fuel Filter.....	F-5207	Oil Filter Full Flow.....	C-5205	Fuel Filter Secondary.....	FC-7903
Hydraulic Oil Filter.....	H-5607	Oil Filter Full Flow.....	C-8012	Fuel/Water Separator.....	SFC-5708
Oil Filter Full Flow.....	C-1920	PC20R-8 (EXCAVATORS) 3D82AE-3F/10001		Hydraulic Oil Filter.....	H-85680
PC20-7 (EXCAVATORS) 3D84N-2		Air Filter Primary.....	A-8504	Hydraulic Breather.....	H-56610
Air Filter Primary.....	AS-2205	Air Filter Primary.....	A-8513	Oil Filter Full Flow.....	C-5730
Fuel Filter.....	F-5210	Fuel Filter.....	F-5207	PC210-6 (EXCAVATORS) S6D95L-1/30001/111868	
Oil Filter Full Flow.....	C-1720	Oil Filter Full Flow.....	C-8012	Air Filter Primary.....	A-5639
Oil Filter Full Flow.....	C-5708	Oil Filter Full Flow.....	C-5205	Air Filter Secondary.....	A-5635
				Coolant Filter.....	WC-5707
				Hydraulic Oil Filter.....	H-7911
				Hydraulic Oil Filter.....	H-85680

MODEL/APPLICATION	SAKURA NO	MODEL/APPLICATION	SAKURA NO	MODEL/APPLICATION	SAKURA NO
KOMATSU		KOMATSU		KOMATSU	
PC210-6 (EXCAVATORS) S6D95L-1/30001/111868		Coolant Filter.....	WC-5707	Hydraulic Oil Filter.....	H-7911
Hydraulic Breather.....	H-56610	Hydraulic Oil Filter.....	H-7911	Hydraulic Oil Filter.....	H-85680
Oil Filter Full Flow.....	C-5606	Hydraulic Oil Filter.....	H-85680	Oil Filter Full Flow.....	C-5614
		Hydraulic Breather.....	H-56610		
		Oil Filter Full Flow.....	C-5606		
PC210-6 (EXCAVATORS) S6D95L-1/30001/30979/111868		PC210LC-6 (EXCAVATORS) S6D95L-1/30001/30979/111868		PC220-1 (EXCAVATORS) S6D105-1	
Air Filter Secondary.....	A-5635	Air Filter Secondary.....	A-5635	Air Filter Primary.....	A-6113
Air Filter Primary.....	A-5639	Air Filter Primary.....	A-5639	Air Filter Secondary.....	A-5408
Coolant Filter.....	WC-5707	Coolant Filter.....	WC-5707	Hydraulic Oil Filter.....	H-5609
Hydraulic Oil Filter.....	H-7911	Hydraulic Oil Filter.....	H-7911	Hydraulic Oil Filter.....	H-7911
Hydraulic Oil Filter.....	H-85680	Hydraulic Oil Filter.....	H-7911	Hydraulic Oil Filter.....	H-85680
Hydraulic Breather.....	H-56610	Hydraulic Breather.....	H-56610	Oil Filter Full Flow.....	C-5614
Oil Filter Full Flow.....	C-5606	Oil Filter Full Flow.....	C-5606		
PC210-6K (EXCAVATORS)		PC210LC-7 (EXCAVATORS)		PC220-2SER (EXCAVATORS)	
Air Filter Primary.....	AS-5670	Air Filter Secondary.....	A-8578	Air Filter Secondary.....	A-5408
Air Filter Secondary.....	A-5671	Air Filter Primary.....	A-8577	Air Filter Primary.....	A-6113
Air Filter Set.....	AS-5672-S	Cabin Air Filter.....	CA-56041	Coolant Filter.....	WC-5707
Fuel Filter Secondary.....	FC-7903	Fuel Filter Secondary.....	FC-7903	Hydraulic Oil Filter.....	H-7911
Fuel/Water Separator.....	SFC-5706	Fuel/Water Separator.....	SFC-5708	Hydraulic Oil Filter.....	H-85680
Fuel/Water Separator.....	SFC-5708	Oil Filter Full Flow.....	C-5611	Oil Filter Full Flow.....	C-5614
Hydraulic Oil Filter.....	H-7911				
Hydraulic Oil Filter.....	H-85680	PC210LC-7K (EXCAVATORS)		PC220-2SER (EXCAVATORS) S6D102E-1	
		Air Filter Primary.....	A-8577	Air Filter Secondary.....	A-5408
PC210-7 (EXCAVATORS) SAA6D102E , 2004		Cabin Air Filter.....	CA-5602	Air Filter Primary.....	A-6113
Air Filter Secondary.....	A-8578	Cabin Air Filter.....	CA-56041	Coolant Filter.....	WC-5707
Air Filter Primary.....	A-8577	Fuel Filter Secondary.....	FC-7903	Hydraulic Oil Filter.....	H-7911
Hydraulic Oil Filter.....	H-5629	Fuel/Water Separator.....	SFC-5708	Hydraulic Oil Filter.....	H-85680
Hydraulic Oil Filter.....	H-5646	Hydraulic Oil Filter.....	H-5629	Oil Filter Full Flow.....	C-5614
Oil Filter Full Flow.....	C-5610	Hydraulic Oil Filter.....	H-5646		
		Oil Filter Full Flow.....	C-5610	PC220-2SER (EXCAVATORS) S6D102E-1/10001/UP	
PC210-7K (EXCAVATORS) SAA6D102E , 2004		PC220 (EXCAVATORS)		Air Filter Primary.....	A-6113
Air Filter Primary.....	A-8577	Air Filter Primary.....	AS-5670	Air Filter Secondary.....	A-5408
Air Filter Secondary.....	A-8578	Air Filter Secondary.....	A-5671	Coolant Filter.....	WC-5707
Hydraulic Oil Filter.....	H-5646	Air Filter Set.....	AS-5672-S	Hydraulic Oil Filter.....	H-7911
Hydraulic Oil Filter.....	H-5629	Oil Filter Full Flow.....	C-5614	Hydraulic Oil Filter.....	H-85680
Oil Filter Full Flow.....	C-5610			Oil Filter Full Flow.....	C-5614
PC210-8 (EXCAVATORS) SAA6D107E , 2006		PC220 (EXCAVATORS) S6D105		PC220-3 (EXCAVATORS) S6D105-1/20001/78506	
Air Filter Secondary.....	A-5667	Air Filter Set.....	A-5604-S	Air Filter Primary.....	A-5639
Air Filter Primary.....	A-5666	Air Filter Primary.....	A-5605	Air Filter Secondary.....	A-5635
Cabin Air Filter.....	CA-56041	Air Filter Secondary.....	A-5606	Coolant Filter.....	WC-5707
Hydraulic Oil Filter.....	H-5646	Hydraulic Oil Filter.....	H-5609	Hydraulic Oil Filter.....	H-5609
Hydraulic Oil Filter.....	H-5629	Oil Filter Full Flow.....	C-5614	Oil Filter Full Flow.....	C-5608
Oil Filter Full Flow.....	C-5611				
PC210LC-6 (EXCAVATORS) S6D102E-1/30980		PC220-1 (EXCAVATORS) S6D102E-1		PC220-3SER (EXCAVATORS)	
Air Filter Secondary.....	A-5635	Air Filter Primary.....	A-6113	Air Filter Set.....	A-5604-S
Air Filter Primary.....	A-5639	Air Filter Secondary.....	A-5408	Air Filter Secondary.....	A-5635
Fuel Filter Secondary.....	FC-7903	Coolant Filter.....	WC-5707	Air Filter Primary.....	A-5605
Fuel/Water Separator.....	SFC-5708	Hydraulic Oil Filter.....	H-85680	Air Filter Primary.....	A-5639
Hydraulic Oil Filter.....	H-85680	Hydraulic Oil Filter.....	H-7911	Hydraulic Oil Filter.....	H-5609
Hydraulic Breather.....	H-56610	Oil Filter Full Flow.....	C-5614	Oil Filter Full Flow.....	C-5608
Oil Filter Full Flow.....	C-5730			Oil Filter Full Flow.....	C-5614
PC210LC-6 (EXCAVATORS) S6D95L-1/30001/111868		PC220-1 (EXCAVATORS) S6D102E-1/10001/UP		PC220-5 (EXCAVATORS) SAA6D95L-1/35001	
Air Filter Primary.....	A-5639	Air Filter Primary.....	A-6113	Air Filter Set.....	A-5663-S
Air Filter Secondary.....	A-5635	Air Filter Secondary.....	A-5408	Air Filter Secondary.....	A-6008
		Coolant Filter.....	WC-5707	Air Filter Primary.....	A-5627
		Hydraulic Oil Filter.....	H-85680	Fuel Filter.....	FC-5621
		Hydraulic Oil Filter.....	H-7911	Hydraulic Oil Filter.....	H-85680
		Oil Filter Full Flow.....	C-5614		

MODEL/APPLICATION	SAKURA NO	MODEL/APPLICATION	SAKURA NO	MODEL/APPLICATION	SAKURA NO
KOMATSU		KOMATSU		KOMATSU	
PC220-5 (EXCAVATORS) SA6D95L-1/35001		Fuel Filter.....	FC-5613	PC220LC-7 (EXCAVATORS) SAA6D102E	
Hydraulic Oil Filter.....	H-7911	Hydraulic Oil Filter.....	H-5646	Air Filter Primary.....	A-8577
Hydraulic Breather.....	H-56610	Hydraulic Oil Filter.....	H-5629	Air Filter Secondary.....	A-8578
Oil Filter Full Flow.....	C-5606			Air Filter Primary.....	A-5666
		PC220AV (EXCAVATORS) SA6D95L		Air Filter Secondary.....	A-5667
PC220-6 (EXCAVATORS) SA6D95L-1/50001		Air Filter Primary.....	A-5627	Cabin Air Filter.....	CA-5602
Air Filter Primary.....	A-5639	Air Filter Set.....	A-5663-S	Cabin Air Filter.....	CA-56041
Air Filter Secondary.....	A-5635	Hydraulic Oil Filter.....	H-85680	Fuel Filter.....	F-5218
Hydraulic Oil Filter.....	H-85680	Hydraulic Oil Filter.....	H-7911	Fuel Filter.....	FC-5621
Hydraulic Oil Filter.....	H-7911	Oil Filter Full Flow.....	C-5606	Hydraulic Oil Filter.....	H-5629
Hydraulic Breather.....	H-56610			Hydraulic Oil Filter.....	H-5646
Oil Filter Full Flow.....	C-5606	PC220LC-3 (EXCAVATORS) S6D105-1/20001/78506			
		Air Filter Secondary.....	A-5635	PC220LC-8 (EXCAVATORS) KOMATSU SAA6D107E-1C-W1	
PC220-6 (EXCAVATORS) SA6D102E-1/52852		Air Filter Primary.....	A-5639	Hydraulic Oil Filter additional part..	H-7105
Air Filter Secondary.....	A-5635	Coolant Filter.....	WC-5707		
Air Filter Primary.....	A-5639	Hydraulic Oil Filter.....	H-5609	PC220LC-8 (EXCAVATORS) SAA6D107E	
Fuel Filter Secondary.....	FC-7903	Oil Filter Full Flow.....	C-5608	Air Filter Primary.....	A-8577
Fuel/Water Separator.....	SFC-5708			Air Filter Primary.....	A-5666
Hydraulic Oil Filter.....	H-85680	PC220LC-3 (EXCAVATORS) S6D105-1/20001/62361		Air Filter Secondary.....	A-8578
Hydraulic Breather.....	H-56610	Air Filter Secondary.....	A-5635	Air Filter Secondary.....	A-5667
Oil Filter Full Flow.....	C-5730	Air Filter Secondary.....	A-5606	Air Filter Secondary.....	A-5667
		Air Filter Primary.....	A-5605	Fuel Filter.....	FC-5613
PC220-6SER (EXCAVATORS)		Air Filter Primary.....	A-5639	Hydraulic Oil Filter.....	H-5629
Air Filter Primary.....	A-5639	Air Filter Set.....	A-5604-S	Hydraulic Oil Filter.....	H-5646
Hydraulic Oil Filter.....	H-7911	Coolant Filter.....	WC-5707		
Hydraulic Oil Filter.....	H-85680	Hydraulic Oil Filter.....	H-5609	PC220LL-7 (EXCAVATORS) SAA6D102E	
Hydraulic Breather.....	H-56610	Oil Filter Full Flow.....	C-5608	Air Filter Secondary.....	A-8578
Oil Filter Full Flow.....	C-5606	Oil Filter Full Flow.....	C-5614	Air Filter Primary.....	A-8577
				Air Filter Primary.....	A-5666
PC220-7 (EXCAVATORS)		PC220LC-5 (EXCAVATORS) SA6D95L-1/35001		Air Filter Secondary.....	A-5667
Air Filter Secondary.....	A-5667	Air Filter Primary.....	A-5627	Cabin Air Filter.....	CA-56041
Air Filter Primary.....	A-5666	Air Filter Set.....	A-5663-S	Cabin Air Filter.....	CA-5602
Hydraulic Oil Filter.....	H-5629	Air Filter Secondary.....	A-6008	Fuel Filter.....	F-5218
Hydraulic Oil Filter.....	H-5646	Fuel Filter.....	FC-5621	Fuel Filter.....	FC-5621
Hydraulic Breather.....	H-56610	Hydraulic Oil Filter.....	H-7911	Hydraulic Oil Filter.....	H-5629
Oil Filter Full Flow.....	C-5611	Hydraulic Oil Filter.....	H-85680	Hydraulic Oil Filter.....	H-5646
		Hydraulic Breather.....	H-56610		
PC220-7 (EXCAVATORS) SAA6D102E		Oil Filter Full Flow.....	C-5606	PC228 (EXCAVATORS) S6D102E	
Air Filter Secondary.....	A-5667			Air Filter Primary.....	AS-5670
Air Filter Primary.....	A-5666	PC220LC-6 (EXCAVATORS) KOMATSU SAA6D102E-1C-7		Air Filter Secondary.....	A-5671
Air Filter Primary.....	A-8577	Fuel Filter.....	FC-5601	Air Filter Set.....	AS-5672-S
Air Filter Secondary.....	A-8578			Coolant Filter.....	WC-5707
Cabin Air Filter.....	CA-56041	PC220LC-6 (EXCAVATORS) SA6D95L-1/50001		Hydraulic Oil Filter.....	H-85680
Cabin Air Filter.....	CA-5602	Air Filter Primary.....	A-5639	Hydraulic Oil Filter.....	H-5609
Fuel Filter.....	FC-5621	Air Filter Secondary.....	A-5635	Oil Filter Full Flow.....	C-5730
Fuel Filter.....	F-5218	Hydraulic Oil Filter.....	H-85680		
Hydraulic Oil Filter.....	H-5629	Hydraulic Oil Filter.....	H-7911	PC228S (EXCAVATORS) 2003	
Hydraulic Oil Filter.....	H-5646	Hydraulic Breather.....	H-56610	Air Filter Secondary.....	A-8578
		Oil Filter Full Flow.....	C-5606	Air Filter Primary.....	A-8577
PC220-8 (EXCAVATORS) KOMATSU SAA6D107E				Fuel Filter.....	F-5218
Hydraulic Oil Filter additional part..	H-7105	PC220LC-6 (EXCAVATORS) SAA6D102E-1/52852		Fuel Filter Secondary.....	FC-7903
		Air Filter Primary.....	A-5639	Fuel/Water Separator.....	SFC-5708
PC220-8 (EXCAVATORS) SAA6D107E		Air Filter Secondary.....	A-5635	Hydraulic Oil Filter.....	H-5646
Air Filter Secondary.....	A-8578	Fuel Filter Secondary.....	FC-7903	Hydraulic Oil Filter.....	H-5629
Air Filter Primary.....	A-8577	Fuel/Water Separator.....	SFC-5708	Oil Filter Full Flow.....	C-5611
Air Filter Primary.....	A-5666	Hydraulic Oil Filter.....	H-85680		
Air Filter Secondary.....	A-5667	Hydraulic Breather.....	H-56610	PC228US-1 (EXCAVATORS) S6D102E	
		Oil Filter Full Flow.....	C-5730	Air Filter Secondary.....	A-5671

MODEL/APPLICATION	SAKURA NO	MODEL/APPLICATION	SAKURA NO	MODEL/APPLICATION	SAKURA NO
KOMATSU		KOMATSU		KOMATSU	
PC228US-1 (EXCAVATORS) S6D102E		PC228USLC-3E0 (EXCAVATORS) SAA6D107E-1		Oil Filter Full Flow.....	C-5606
Air Filter Set.....	AS-5672-S	Fuel Filter.....	FC-5613	PC230LC-6 (EXCAVATORS) SA6D102E-1/10177	
Air Filter Primary.....	AS-5670	Hydraulic Oil Filter.....	H-5646	Air Filter Secondary.....	A-5635
Coolant Filter.....	WC-5707	Hydraulic Oil Filter.....	H-5629	Air Filter Primary.....	A-5639
Hydraulic Oil Filter.....	H-5609	Oil Filter Full Flow.....	C-5611	Fuel Filter Secondary.....	FC-7903
Hydraulic Oil Filter.....	H-85680	PC228UU-1 (EXCAVATORS) S6D102E		Fuel/Water Separator.....	SFC-5708
Oil Filter Full Flow.....	C-5730	Air Filter Set.....	AS-5672-S	Hydraulic Oil Filter.....	H-85680
PC228US-2 (EXCAVATORS) S6D102E		Air Filter Secondary.....	A-5671	Hydraulic Breather.....	H-56610
Air Filter Primary.....	AS-5670	Air Filter Primary.....	AS-5670	Oil Filter Full Flow.....	C-5730
Air Filter Set.....	AS-5672-S	Coolant Filter.....	WC-5707	PC230LC-6 (EXCAVATORS) SAGD95L-1/10001/10176	
Air Filter Secondary.....	A-5671	Hydraulic Oil Filter.....	H-5609	Air Filter Secondary.....	A-5635
Coolant Filter.....	WC-5707	Hydraulic Oil Filter.....	H-85680	Air Filter Primary.....	A-5639
Hydraulic Oil Filter.....	H-5609	Oil Filter Full Flow.....	C-5730	Hydraulic Oil Filter.....	H-7911
Hydraulic Oil Filter.....	H-85680	PC230-6 (EXCAVATORS) KOMATSU SA6D95L		Hydraulic Oil Filter.....	H-85680
Oil Filter Full Flow.....	C-5730	Fuel Filter.....	FC-5601	Hydraulic Breather.....	H-56610
PC228US-3 (EXCAVATORS) SAA6D102E , 2004		PC230-6 (EXCAVATORS) S6D95L-1/20001/UP		Oil Filter Full Flow.....	C-5606
Air Filter Secondary.....	A-8578	Air Filter Primary.....	A-5639	PC230NHD-7 (EXCAVATORS) SAA6D102E-2	
Air Filter Primary.....	A-8577	Hydraulic Oil Filter.....	H-7911	Hydraulic Oil Filter.....	H-5646
Hydraulic Oil Filter.....	H-5629	Hydraulic Oil Filter.....	H-85680	Hydraulic Oil Filter.....	H-5629
Hydraulic Oil Filter.....	H-5646	Hydraulic Breather.....	H-56610	PC230NHD-7K (EXCAVATORS) SAA6D102E-2	
Oil Filter Full Flow.....	C-5610	Oil Filter Full Flow.....	C-5606	Hydraulic Oil Filter.....	H-5646
Oil Filter Full Flow.....	C-5611	PC230-6 (EXCAVATORS) SAGD95L-1/10001/111870		Hydraulic Oil Filter.....	H-5629
PC228USLC-1 (EXCAVATORS)		Air Filter Primary.....	A-5639	PC240 (EXCAVATORS)	
Air Filter Primary.....	A-5639	Air Filter Secondary.....	A-5635	Air Filter Primary.....	AS-5670
Air Filter Secondary.....	A-5635	Hydraulic Oil Filter.....	H-7911	Air Filter Secondary.....	A-5671
Fuel Filter Secondary.....	FC-7903	Hydraulic Oil Filter.....	H-85680	Air Filter Set.....	AS-5672-S
Fuel/Water Separator.....	SFC-5708	Hydraulic Breather.....	H-56610	Fuel Filter.....	FC-5715
PC228USLC-1 (EXCAVATORS) S6D102E		Oil Filter Full Flow.....	C-5606	Hydraulic Oil Filter.....	H-85680
Air Filter Secondary.....	A-5671	PC230-6 (EXCAVATORS) SAGD102E-1/10177		Hydraulic Oil Filter.....	H-7911
Air Filter Set.....	AS-5672-S	Air Filter Secondary.....	A-5635	Oil Filter Full Flow.....	C-5102
Air Filter Primary.....	AS-5670	Air Filter Primary.....	A-5639	PC240-3 (EXCAVATORS)	
Coolant Filter.....	WC-5707	Fuel Filter Secondary.....	FC-7903	Air Filter Primary.....	A-5639
Hydraulic Oil Filter.....	H-85680	Fuel/Water Separator.....	SFC-5708	Hydraulic Oil Filter.....	H-5609
Hydraulic Oil Filter.....	H-5609	Hydraulic Oil Filter.....	H-85680	Oil Filter Full Flow.....	C-5608
Oil Filter Full Flow.....	C-5730	Hydraulic Breather.....	H-56610	PC240-3SER (EXCAVATORS) S6D105-1	
PC228USLC-2 (EXCAVATORS) S6D102E		Oil Filter Full Flow.....	C-5730	Air Filter Secondary.....	A-5635
Air Filter Secondary.....	A-5671	PC230-6 (EXCAVATORS) SAGD95L-1/10001/10176		Air Filter Primary.....	A-5639
Air Filter Set.....	AS-5672-S	Air Filter Primary.....	A-5639	Coolant Filter.....	WC-5707
Air Filter Primary.....	AS-5670	Air Filter Secondary.....	A-5635	Hydraulic Oil Filter.....	H-5609
Coolant Filter.....	WC-5707	Hydraulic Oil Filter.....	H-7911	PC240-5K (EXCAVATORS)	
Hydraulic Oil Filter.....	H-85680	Hydraulic Oil Filter.....	H-85680	Air Filter Primary.....	AS-5670
Hydraulic Oil Filter.....	H-5609	Hydraulic Breather.....	H-56610	Air Filter Secondary.....	A-5671
Oil Filter Full Flow.....	C-5730	Oil Filter Full Flow.....	C-5606	Air Filter Set.....	AS-5672-S
PC228USLC-3 (EXCAVATORS) SAA6D102E		PC230LC-6 (EXCAVATORS) SAGD95L-1/10001/111870		Fuel Filter.....	FC-5715
Air Filter Secondary.....	A-8578	Air Filter Secondary.....	A-5635	Hydraulic Oil Filter.....	H-85680
Air Filter Primary.....	A-8577	Air Filter Primary.....	A-5639	Hydraulic Oil Filter.....	H-7911
Fuel Filter Secondary.....	FC-7903	Hydraulic Oil Filter.....	H-85680	Oil Filter Full Flow.....	C-5102
Fuel/Water Separator.....	SFC-5708	Hydraulic Breather.....	H-56610	PC240-6K (EXCAVATORS)	
Hydraulic Oil Filter.....	H-5629	Oil Filter Full Flow.....	C-5606	Air Filter Primary.....	AS-5670
Hydraulic Oil Filter.....	H-5646	PC230LC-6 (EXCAVATORS) SAGD95L-1/10001/111870		Air Filter Secondary.....	A-5671
Oil Filter Full Flow.....	C-5611	Air Filter Secondary.....	A-5635	Air Filter Set.....	AS-5672-S
		Air Filter Primary.....	A-5639	Fuel Filter.....	FC-5715
		Hydraulic Oil Filter.....	H-85680	Hydraulic Oil Filter.....	H-85680
		Hydraulic Oil Filter.....	H-7911	Hydraulic Oil Filter.....	H-7911
		Hydraulic Breather.....	H-56610	Oil Filter Full Flow.....	C-5102
		Oil Filter Full Flow.....	C-5606		

MODEL/APPLICATION	SAKURA NO	MODEL/APPLICATION	SAKURA NO	MODEL/APPLICATION	SAKURA NO
KOMATSU		KOMATSU		KOMATSU	
PC240-6K (EXCAVATORS)		PC25R-8 (EXCAVATORS) 3D82AE/10001		Fuel Filter.....	FC-5613
Air Filter Secondary.....	A-5671	Air Filter Primary.....	A-8513	Hydraulic Oil Filter.....	H-5646
Air Filter Set.....	AS-5672-S	Air Filter Primary.....	A-8504	Hydraulic Oil Filter.....	H-5629
Air Filter Primary.....	AS-5670	Fuel Filter.....	F-5207		
Fuel Filter Secondary.....	FC-7903	Oil Filter Full Flow.....	C-8012	PC270LL-7 (EXCAVATORS) SAA6D102E	
Fuel/Water Separator.....	SFC-5708	Oil Filter Full Flow.....	C-5205	Air Filter Primary.....	A-5666
Fuel/Water Separator.....	SFC-5706			Air Filter Secondary.....	A-5667
Hydraulic Oil Filter.....	H-7911	PC25R-8 (EXCAVATORS) 3D82AE-3E/10001		Cabin Air Filter.....	CA-5602
Hydraulic Oil Filter.....	H-85680	Air Filter Primary.....	A-8513	Cabin Air Filter.....	CA-56041
		Air Filter Primary.....	A-8504	Fuel Filter.....	F-5218
PC240-7 (EXCAVATORS) 2004		Fuel Filter.....	F-5207	Hydraulic Oil Filter.....	H-5629
Oil Filter Full Flow.....	C-5610	Oil Filter Full Flow.....	C-8012	Hydraulic Oil Filter.....	H-5646
		Oil Filter Full Flow.....	C-5205	Hydraulic Breather.....	H-56610
PC240-8 (EXCAVATORS) 2006				Oil Filter Full Flow.....	C-5611
Hydraulic Oil Filter.....	H-5646	PC25R-8 (EXCAVATORS) 3D82AE-3F/10001			
Hydraulic Oil Filter.....	H-5629	Air Filter Primary.....	A-8513	PC27-8 (EXCAVATORS) 3D82AE-3F	
		Air Filter Primary.....	A-8504	Fuel Filter.....	F-5207
PC240LC (EXCAVATORS) S6D102		Fuel Filter.....	F-5207	Oil Filter Full Flow.....	C-1011
Air Filter Primary.....	AS-5670	Oil Filter Full Flow.....	C-8012		
Air Filter Set.....	AS-5672-S	Oil Filter Full Flow.....	C-5205	PC27MR-2 (EXCAVATORS) 3D82AE , 2005	
Coolant Filter.....	WC-5707			Air Filter Secondary.....	A-5569
Hydraulic Oil Filter.....	H-5609	PC270-7 (EXCAVATORS) SAA6D102E		Air Filter Primary.....	A-8513
		Air Filter Secondary.....	A-5667	Fuel Filter.....	F-5207
PC240LC-7 (EXCAVATORS)		Air Filter Primary.....	A-5666	Oil Filter Full Flow.....	C-8012
Cabin Air Filter.....	CA-56041	Cabin Air Filter.....	CA-5602		
		Cabin Air Filter.....	CA-56041	PC27R-8 (EXCAVATORS) 3D82AE/10001	
PC250LC-6 (EXCAVATORS) SAGD102-1/A82001		Fuel Filter.....	F-5218	Air Filter Primary.....	A-8504
Fuel Filter Secondary.....	FC-7903	Hydraulic Oil Filter.....	H-5629	Air Filter Primary.....	A-8513
Fuel/Water Separator.....	SFC-5706	Hydraulic Oil Filter.....	H-5646	Fuel Filter.....	F-5207
Fuel/Water Separator.....	SFC-5708	Hydraulic Breather.....	H-56610	Oil Filter Full Flow.....	C-8012
Hydraulic Oil Filter.....	H-85680	Oil Filter Full Flow.....	C-5611	Oil Filter Full Flow.....	C-5205
Hydraulic Oil Filter.....	H-7911				
PC25-1 (EXCAVATORS) 3D84N-2		PC270LC-6 (EXCAVATORS) SA6D102E		PC27R-8 (EXCAVATORS) 3D82AE-3E/10001	
Air Filter Primary.....	AS-2205	Hydraulic Oil Filter.....	H-85680	Air Filter Primary.....	A-8513
Fuel Filter.....	F-5210			Air Filter Primary.....	A-8504
Hydraulic Oil Filter.....	H-5607	PC270LC-6LE (EXCAVATORS) SA6D102E		Fuel Filter.....	F-5207
Oil Filter Full Flow.....	C-8012	Hydraulic Oil Filter.....	H-85680	Oil Filter Full Flow.....	C-5205
				Oil Filter Full Flow.....	C-8012
PC25-1 (EXCAVATORS) 3D82E-3		PC270LC-6MH (EXCAVATORS) SA6D102E		PC27R-8 (EXCAVATORS) 3D82AE-3F/10001	
Oil Filter Full Flow.....	C-8012	Hydraulic Oil Filter.....	H-85680	Air Filter Primary.....	A-8504
				Air Filter Primary.....	A-8513
PC25-1 (EXCAVATORS) 3D84N-2/1001/6470		PC270LC-7MH (EXCAVATORS) SAA6D102E		Fuel Filter.....	F-5207
Air Filter Primary.....	AS-2205	Air Filter Secondary.....	A-5667	Oil Filter Full Flow.....	C-5205
Fuel Filter.....	F-5210	Air Filter Primary.....	A-5666	Oil Filter Full Flow.....	C-8012
Hydraulic Oil Filter.....	H-5607	Cabin Air Filter.....	CA-5602		
Oil Filter Full Flow.....	C-1011	Cabin Air Filter.....	CA-56041	PC280-3 (EXCAVATORS) S/N: 10001	
		Fuel Filter.....	F-5218	Air Filter Primary.....	A-5639
PC25-1 (EXCAVATORS) 3D84N-2/1001/6470		Hydraulic Oil Filter.....	H-5646	Hydraulic Oil Filter.....	H-5609
Air Filter Primary.....	AS-2205	Hydraulic Oil Filter.....	H-5629	Oil Filter Full Flow.....	C-5608
Fuel Filter.....	F-5210	Hydraulic Breather.....	H-56610		
Hydraulic Oil Filter.....	H-5607	Oil Filter Full Flow.....	C-5611	PC280-35ER (EXCAVATORS) S6D110	
Oil Filter Full Flow.....	C-1011			Air Filter Primary.....	A-5639
		PC270LC-8 (EXCAVATORS) SAA6D107E-1		Coolant Filter.....	WC-5707
PC25-8 (EXCAVATORS)		Air Filter Secondary.....	A-5667	Hydraulic Oil Filter.....	H-5609
Fuel Filter.....	F-5207	Air Filter Primary.....	A-5666		
Oil Filter Full Flow.....	C-1011	Cabin Air Filter.....	CA-56041	PC280LC-3 (EXCAVATORS) S6D110-1D/10001/55860	

MODEL/APPLICATION	SAKURA NO	MODEL/APPLICATION	SAKURA NO	MODEL/APPLICATION	SAKURA NO
KOMATSU		KOMATSU		KOMATSU	
PC280LC-3 (EXCAVATORS) S6D110-1D/10001/55860		Fuel/Water Separator.....	SFC-5706	Oil Filter Full Flow.....	C-5611
Air Filter Primary.....	A-5639	Hydraulic Oil Filter.....	H-85680	PC240LC-8K (EXCAVATORS) SAA6D107E-1	
Hydraulic Oil Filter.....	H-5609	Hydraulic Oil Filter.....	H-7911	Air Filter Secondary.....	A-5667
Oil Filter Full Flow.....	C-5608	PC290NLC-7K (EXCAVATORS) 2006		Air Filter Primary.....	A-5666
PC28UU-1 (EXCAVATORS) YANMAR/1001		Air Filter Primary.....	A-5666	Cabin Air Filter.....	CA-56041
Air Filter Primary.....	AS-2205	Cabin Air Filter.....	CA-56041	Fuel Filter.....	FC-5613
Fuel Filter.....	F-5210	Fuel Filter Secondary.....	FC-7903	Hydraulic Oil Filter.....	H-5629
Oil Filter Full Flow.....	C-5708	Fuel/Water Separator.....	SFC-5708	Hydraulic Oil Filter.....	H-5646
PC28UU-2 (EXCAVATORS) 3D82E-3/10801		Hydraulic Oil Filter.....	H-5629	Hydraulic Breather.....	H-56610
Air Filter Primary.....	AS-2205	Hydraulic Oil Filter.....	H-5646	Oil Filter Full Flow.....	C-5611
Fuel Filter.....	F-5207	Hydraulic Breather.....	H-56610	PC210-8K (EXCAVATORS) KOMATSU SAA6D107E-1B-WK	
Oil Filter Full Flow.....	C-8012	Oil Filter Full Flow.....	C-5611	Hydraulic Oil Filter additional part..	H-7105
PC28UU-2 (EXCAVATORS) 3D82E-3/24522/UP		PC210NLC-7K (EXCAVATORS) SAA6D102E , 2004		PC210-8K (EXCAVATORS) SAA6D107E-1	
Air Filter Primary.....	AS-2205	Air Filter Secondary.....	A-8578	Air Filter Secondary.....	A-5667
Fuel Filter.....	F-5207	Air Filter Primary.....	A-8577	Air Filter Primary.....	A-5666
Oil Filter Full Flow.....	C-8012	Hydraulic Oil Filter.....	H-5629	Cabin Air Filter.....	CA-56041
PC28UU-2 (EXCAVATORS) 3D84N-2/7001/10800		Hydraulic Oil Filter.....	H-5646	Fuel Filter.....	FC-5613
Air Filter Primary.....	AS-2205	Oil Filter Full Flow.....	C-5610	Hydraulic Oil Filter.....	H-5629
Fuel Filter.....	F-5210	PC210NLC-8K (EXCAVATORS) SAA6D107E-1		Hydraulic Oil Filter.....	H-5646
Oil Filter Full Flow.....	C-8012	Air Filter Secondary.....	A-5667	Hydraulic Breather.....	H-56610
PC28UU-2 (EXCAVATORS) 3D84N-2/7001/10800		Air Filter Primary.....	A-5666	Oil Filter Full Flow.....	C-5611
Air Filter Primary.....	AS-2205	Cabin Air Filter.....	CA-56041	PC210LC-8 (EXCAVATORS) SAA6D107E , 2006	
Fuel Filter.....	F-5210	Fuel Filter.....	FC-5613	Air Filter Secondary.....	A-5667
Oil Filter Full Flow.....	C-8012	Hydraulic Oil Filter.....	H-5629	Air Filter Primary.....	A-5666
PC290 (EXCAVATORS)		Hydraulic Oil Filter.....	H-5646	Cabin Air Filter.....	CA-56041
Air Filter Secondary.....	A-5671	Hydraulic Breather.....	H-56610	Hydraulic Oil Filter.....	H-5646
PC290-7 (EXCAVATORS)		Oil Filter Full Flow.....	C-5611	Hydraulic Oil Filter.....	H-5629
Air Filter Secondary.....	A-5667	PC228USLC-9 (EXCAVATORS) SAA6D107E-1K		Oil Filter Full Flow.....	C-5611
Air Filter Primary.....	A-5666	Air Filter Secondary.....	A-5667	PC210LC-8K (EXCAVATORS) KOMATSU SAA6D107E-1B-WK	
Fuel Filter Secondary.....	FC-7903	Air Filter Primary.....	A-5666	Hydraulic Oil Filter additional part..	H-7105
Fuel/Water Separator.....	SFC-5708	Cabin Air Filter.....	CA-56041	PC210LC-8K (EXCAVATORS) SAA6D107E-1	
Hydraulic Oil Filter.....	H-5646	Hydraulic Oil Filter.....	H-5646	Air Filter Secondary.....	A-5667
Hydraulic Oil Filter.....	H-5629	Hydraulic Oil Filter.....	H-5629	Air Filter Primary.....	A-5666
Hydraulic Breather.....	H-56610	Oil Filter Full Flow.....	C-5611	Cabin Air Filter.....	CA-56041
Oil Filter Full Flow.....	C-5730	PC230NHD-8 (EXCAVATORS) KOMATSU , 2007		Fuel Filter.....	FC-5613
PC290-8 (EXCAVATORS) 2006		Air Filter Primary.....	A-5666	Hydraulic Oil Filter.....	H-5629
Air Filter Secondary.....	A-5667	Air Filter Secondary.....	A-5667	Hydraulic Oil Filter.....	H-5646
Air Filter Primary.....	A-5666	Cabin Air Filter.....	CA-56041	Hydraulic Breather.....	H-56610
Hydraulic Oil Filter.....	H-5629	Hydraulic Oil Filter.....	H-5629	Oil Filter Full Flow.....	C-5611
Hydraulic Oil Filter.....	H-5646	Hydraulic Oil Filter.....	H-5646	PC240-8K (EXCAVATORS) SAA6D107E-1	
PC290LC-6K (EXCAVATORS) SAA6D102EA-1/K30001-UP/21288263-UP		Oil Filter Full Flow.....	C-5611	Air Filter Secondary.....	A-5667
Fuel Filter Secondary.....	FC-7903	PC240LC-8 (EXCAVATORS) KOMATSU SAA6D107E-1		Air Filter Primary.....	A-5666
Fuel/Water Separator.....	SFC-5706	Hydraulic Oil Filter additional part..	H-7105	Cabin Air Filter.....	CA-56041
Fuel/Water Separator.....	SFC-5708	PC240LC-8 (EXCAVATORS) SAA6D107E-1		Fuel Filter.....	FC-5613
Hydraulic Oil Filter Suction.....	H-2706	Air Filter Secondary.....	A-5667	Hydraulic Oil Filter.....	H-5629
Hydraulic Oil Filter.....	H-85680	Air Filter Primary.....	A-5666	Hydraulic Oil Filter.....	H-5646
Hydraulic Breather.....	H-56610	Cabin Air Filter.....	CA-56041	Hydraulic Breather.....	H-56610
PC290NLC-6K (EXCAVATORS)		Fuel Filter.....	FC-5613	Oil Filter Full Flow.....	C-5611
Cabin Air Filter Set.....	CA-5601-S	Hydraulic Oil Filter.....	H-5629	PC240LC-10 (EXCAVATORS) SAA6D107E-2 , 2011	
Fuel Filter Secondary.....	FC-7903	Hydraulic Oil Filter.....	H-5646	Air Filter Secondary.....	A-5667
Fuel/Water Separator.....	SFC-5708	Hydraulic Breather.....	H-56610		

MODEL/APPLICATION	SAKURA NO	MODEL/APPLICATION	SAKURA NO	MODEL/APPLICATION	SAKURA NO
KOMATSU		KOMATSU		KOMATSU	
PC240LC-10 (EXCAVATORS) SAA6D107E-2 , 2011		PC270-8 (EXCAVATORS) KOMATSU SAA6D107E-1E-W1		Oil Filter Full Flow.....	C-5715
Air Filter Primary.....	A-5666	Hydraulic Oil Filter additional part..	H-7105	PC3000 (EXCAVATORS)	
Cabin Air Filter.....	CA-56041	PC270-8 (EXCAVATORS) SAA6D107E-1		Hydraulic Oil Filter.....	H-62110
Hydraulic Oil Filter.....	H-5646	Fuel Filter.....	FC-5613	PC300-1 (EXCAVATORS) NT-855	
Hydraulic Oil Filter.....	H-5629	PC290LC-10 (EXCAVATORS) SAA6D107E-2		Air Filter Secondary.....	A-5408
Oil Filter Full Flow.....	C-5611	Cabin Air Filter.....	CAC-56120	Air Filter Primary.....	A-6113
PC240LC-10 (EXCAVATORS) SAA6D107E-2		Cabin Air Filter.....	CA-56120	Fuel Filter.....	FC-5602
Cabin Air Filter.....	CA-56120	PC230NHD-8K (EXCAVATORS) SAA6D107E-1		Hydraulic Oil Filter.....	H-85680
Cabin Air Filter.....	CAC-56120	Fuel Filter.....	FC-5613	Hydraulic Oil Filter.....	H-7911
PC240NLC-7 (EXCAVATORS) SAA6D102E-2 , 2005		PC200-8M0 (EXCAVATORS) S/N: DBBB2001-UP		Oil Filter By Pass.....	O-5704
Fuel Filter Secondary.....	FC-7903	Fuel/Water Separator.....	SFC-56050	Oil Filter Full Flow.....	C-5701
Fuel/Water Separator.....	SFC-5708	PC200-8M0 (EXCAVATORS) S/N: J60001-UP		Oil Filter Full Flow.....	C-5715
Hydraulic Oil Filter.....	H-5629	Fuel/Water Separator.....	SFC-56050	Oil Filter Full Flow.....	C-5605
Hydraulic Oil Filter.....	H-5646	Fuel/Water Separator.....	SFC-19100B	PC300-15ER (EXCAVATORS)	
PC240NLC-8 (EXCAVATORS)		PC220-8M0 (EXCAVATORS) S/N: DBBG7001-UP		Air Filter Secondary.....	A-5408
Hydraulic Oil Filter.....	H-5646	Fuel/Water Separator.....	SFC-56050	Air Filter Primary.....	A-6113
Hydraulic Oil Filter.....	H-5629	Fuel/Water Separator.....	SFC-19100B	Coolant Filter.....	WC-5707
PC240NLC-8K (EXCAVATORS) SAA6D107E-1		PC220-8M0 (EXCAVATORS) S/N: DBBG7001-UP		Fuel Filter.....	FC-5602
Air Filter Primary.....	A-5666	Fuel/Water Separator.....	SFC-56050	Hydraulic Oil Filter.....	H-7911
Air Filter Secondary.....	A-5667	PC30 (EXCAVATORS) 3TN84E		Hydraulic Oil Filter.....	H-85680
Cabin Air Filter.....	CA-56041	Air Filter Primary.....	AS-1014	Oil Filter By Pass.....	O-5704
Fuel Filter.....	FC-5613	Hydraulic Oil Filter.....	H-5607	Oil Filter Full Flow.....	C-5715
Hydraulic Oil Filter.....	H-5629	PC30 (EXCAVATORS)		Oil Filter Full Flow.....	C-5701
Hydraulic Oil Filter.....	H-5646	Air Filter Primary.....	AS-2205	Oil Filter Full Flow.....	C-5605
Hydraulic Breather.....	H-56610	Fuel Filter.....	F-5207	PC300-25ER (EXCAVATORS)	
Oil Filter Full Flow.....	C-5611	Hydraulic Oil Filter.....	H-5607	Air Filter Secondary.....	A-5408
PC270LC-7 (EXCAVATORS) SAA6D102E		Oil Filter Full Flow.....	C-1920	Air Filter Primary.....	A-6113
Air Filter Secondary.....	A-5667	PC300 (EXCAVATORS) N-855		Coolant Filter.....	WC-5707
Air Filter Primary.....	A-5666	Fuel Filter.....	FC-5602	Fuel Filter.....	FC-5602
Cabin Air Filter.....	CA-56041	Hydraulic Oil Filter.....	H-7911	Hydraulic Oil Filter.....	H-7911
Cabin Air Filter.....	CA-5602	Hydraulic Oil Filter.....	H-85680	Hydraulic Oil Filter.....	H-85680
Fuel Filter.....	F-5218	Oil Filter Full Flow.....	C-5605	Oil Filter Full Flow.....	C-5715
Hydraulic Oil Filter.....	H-5646	Oil Filter Full Flow.....	C-5701	Oil Filter By Pass.....	O-5704
Hydraulic Oil Filter.....	H-5629	Oil Filter Full Flow.....	C-5715	Oil Filter Full Flow.....	C-5605
Hydraulic Breather.....	H-56610	PC300 (EXCAVATORS)		Oil Filter Full Flow.....	C-5701
Oil Filter Full Flow.....	C-5611	Air Filter Primary.....	A-1313	PC300-3 (EXCAVATORS) S6D125-1	
PC27MRX-1 (EXCAVATORS) 3D82AE , 2005		Air Filter Secondary.....	A-1307	Fuel Filter.....	FC-5606
Air Filter Secondary.....	A-5569	Air Filter Set.....	A-5662-S	PC300-3 (EXCAVATORS) S6D125-1/12001/13137	
Air Filter Primary.....	A-8513	Fuel Filter.....	FC-5602	Air Filter Secondary.....	A-5408
Fuel Filter.....	F-5207	Hydraulic Oil Filter.....	H-7911	Air Filter Primary.....	A-6113
Oil Filter Full Flow.....	C-8012	Hydraulic Oil Filter.....	H-85680	Fuel Filter.....	FC-5602
PC290LC-8K (EXCAVATORS) SAA6D107E		Oil Filter Full Flow.....	C-5608	Hydraulic Oil Filter.....	H-7911
Air Filter Secondary.....	A-5667	PC3000 (EXCAVATORS) CUMMINS KTA38 , 2007		Hydraulic Oil Filter.....	H-5652
Air Filter Primary.....	A-5666	Hydraulic Oil Filter.....	H-62110	Hydraulic Oil Filter.....	H-85680
Cabin Air Filter.....	CA-56041	PC3000 (EXCAVATORS) KTA38 , 2007		Oil Filter Full Flow.....	C-5605
Fuel Filter.....	FC-5613	Hydraulic Oil Filter.....	H-62110	Oil Filter Full Flow.....	C-5701
Hydraulic Oil Filter.....	H-5646	PC3000 (EXCAVATORS) KTA38 , 2007		Oil Filter Full Flow.....	C-5715
Hydraulic Oil Filter.....	H-5629	Air Filter Primary.....	A-6113	PC300-3 (EXCAVATORS) S6D125-15/12239/13137	
Oil Filter Full Flow.....	C-5611	Air Filter Secondary.....	A-1307	Air Filter Primary.....	A-6113
		Air Filter Set.....	A-5662-S	Air Filter Secondary.....	A-5408
		Fuel Filter.....	FC-5602	Fuel Filter.....	FC-5602
		Hydraulic Oil Filter.....	H-7911	Hydraulic Oil Filter.....	H-7911
		Hydraulic Oil Filter.....	H-85680	Hydraulic Oil Filter.....	H-85680
		Oil Filter Full Flow.....	C-5608	Oil Filter Full Flow.....	C-5605
				Oil Filter Full Flow.....	C-5701
				Oil Filter Full Flow.....	C-5715

MODEL/APPLICATION	SAKURA NO	MODEL/APPLICATION	SAKURA NO	MODEL/APPLICATION	SAKURA NO
KOMATSU		KOMATSU		KOMATSU	
PC300-3 (EXCAVATORS) S6D125-1S/12239/13137		Air Filter Primary.....	A-1313	PC300-7 (EXCAVATORS) SAA6D114E	
Hydraulic Oil Filter.....	H-85680	Fuel Filter.....	FC-5602	Hydraulic Oil Filter.....	H-56690
Hydraulic Oil Filter.....	H-7911	Hydraulic Oil Filter.....	H-85680		
Oil Filter Full Flow.....	C-5715	Hydraulic Oil Filter.....	H-7911	PC300-7 (EXCAVATORS) SAA6D114E-2A	
Oil Filter Full Flow.....	C-5605	Hydraulic Breather.....	H-56610	Air Filter Set.....	A-5558M-S
Oil Filter Full Flow.....	C-5701	Oil Filter Full Flow.....	C-5614	Air Filter Primary.....	A-5558M
PC300-3SER (EXCAVATORS)		PC300-6 (EXCAVATORS) SAA6D108		Air Filter Secondary.....	A-5559
Air Filter Secondary.....	A-5408	Air Filter Set.....	A-5662-S	Cabin Air Filter.....	CA-5602
Air Filter Primary.....	A-6113	Air Filter Secondary.....	A-1307	Cabin Air Filter.....	CA-56041
Fuel Filter.....	FC-5602	Air Filter Primary.....	A-1313	Fuel Filter.....	F-5218
Hydraulic Oil Filter.....	H-85680	Coolant Filter.....	WC-5705	Hydraulic Oil Filter.....	H-5646
Hydraulic Oil Filter.....	H-5652	Fuel Filter.....	FC-5602	Hydraulic Oil Filter.....	H-5629
Hydraulic Oil Filter.....	H-7911	Hydraulic Oil Filter.....	H-7911	Oil Filter Combination.....	C-5707
Oil Filter Full Flow.....	C-5715	Hydraulic Oil Filter.....	H-85680	PC300AV (EXCAVATORS) SAA6D108	
Oil Filter Full Flow.....	C-5605	Oil Filter Full Flow.....	C-5614	Air Filter Primary.....	A-1313
Oil Filter Full Flow.....	C-5701	PC300-6 (EXCAVATORS) SAA6D108E		Air Filter Secondary.....	A-1307
PC300-5 (EXCAVATORS) SAA6D108/20001		Air Filter Primary.....	A-1313	Air Filter Set.....	A-5662-S
Air Filter Secondary.....	A-1307	Air Filter Set.....	A-5662-S	Fuel Filter.....	FC-5602
Air Filter Primary.....	A-1313	Cabin Air Filter.....	CA-56130	Hydraulic Oil Filter.....	H-85680
Air Filter Set.....	A-5662-S	Fuel Filter.....	FC-5602	Hydraulic Oil Filter.....	H-7911
Fuel Filter.....	FC-5602	Hydraulic Oil Filter.....	H-7911	Oil Filter Full Flow.....	C-5608
Hydraulic Oil Filter.....	H-5652	Hydraulic Oil Filter.....	H-85680	PC300AV (EXCAVATORS) SAA6D108	
Hydraulic Oil Filter.....	H-7911	PC300-6 (EXCAVATORS) SAA6D108E-2A		Air Filter Set.....	A-5662-S
Hydraulic Oil Filter.....	H-85680	Cabin Air Filter.....	CA-56070	Air Filter Secondary.....	A-1307
Oil Filter Full Flow.....	C-5608	Fuel Filter.....	FC-5606	Air Filter Primary.....	A-1313
PC300-5 (EXCAVATORS) SAA6D108-1/20001/10001		PC300-6SER (EXCAVATORS)		Fuel Filter.....	FC-5602
Air Filter Secondary.....	A-1307	Air Filter Secondary.....	A-1307	Hydraulic Oil Filter.....	H-85680
Air Filter Primary.....	A-1313	Air Filter Primary.....	A-1313	Hydraulic Oil Filter.....	H-7911
Air Filter Set.....	A-5662-S	Air Filter Set.....	A-5662-S	Oil Filter Full Flow.....	C-5614
Fuel Filter.....	FC-5602	Fuel Filter.....	FC-5602	PC300HD-5 (EXCAVATORS) SAA6D108-1/10001	
Hydraulic Oil Filter.....	H-5652	Hydraulic Oil Filter.....	H-7911	Air Filter Primary.....	A-1313
Hydraulic Oil Filter.....	H-7911	Hydraulic Oil Filter.....	H-85680	Air Filter Secondary.....	A-1307
Hydraulic Oil Filter.....	H-85680	Hydraulic Breather.....	H-56610	Air Filter Set.....	A-5662-S
Oil Filter Full Flow.....	C-5608	Oil Filter Full Flow.....	C-5614	Fuel Filter.....	FC-5602
PC300-5 (EXCAVATORS) SAA6D108		PC300-7 (EXCAVATORS) 2004		Hydraulic Oil Filter.....	H-7911
Fuel Filter.....	FC-5606	Air Filter Primary.....	A-5558M	Hydraulic Oil Filter.....	H-85680
PC300-5SER (EXCAVATORS)		Air Filter Set.....	A-5558M-S	Hydraulic Oil Filter.....	H-5652
Air Filter Secondary.....	A-1307	Air Filter Secondary.....	A-5559	Oil Filter Full Flow.....	C-5608
Air Filter Primary.....	A-1313	Fuel Filter.....	FC-5610	PC300HD-5 (EXCAVATORS) SAA6D108	
Air Filter Set.....	A-5662-S	Fuel Filter.....	FC-5621	Air Filter Set.....	A-5662-S
Fuel Filter.....	FC-5602	Fuel Filter.....	F-5218	Air Filter Primary.....	A-1313
Hydraulic Oil Filter.....	H-7911	Hydraulic Oil Filter.....	H-5646	Air Filter Secondary.....	A-1307
Hydraulic Oil Filter.....	H-5652	Hydraulic Oil Filter.....	H-5629	Fuel Filter.....	FC-5602
Hydraulic Oil Filter.....	H-85680	Hydraulic Breather.....	H-56610	Hydraulic Oil Filter.....	H-5652
Oil Filter Full Flow.....	C-5608	Oil Filter Combination.....	C-5707	Hydraulic Oil Filter.....	H-7911
PC300-6 (EXCAVATORS) KOMATSU SAA6D108		PC300-7 (EXCAVATORS) KOMATSU SAA6D114E		Hydraulic Oil Filter.....	H-85680
Fuel Filter.....	FC-5610	Hydraulic Oil Filter additional part..	H-7105	Oil Filter Full Flow.....	C-5608
PC300-6 (EXCAVATORS) SAA6D108E-2/30001/19030		PC300-7 (EXCAVATORS) KOMATSU SAA6D114E-2A		PC300HD-6 (EXCAVATORS) SAA6D114 , 2004	
Air Filter Set.....	A-5662-S	Fuel Filter.....	FC-5610	Air Filter Primary.....	A-1013
Air Filter Secondary.....	A-1307			Air Filter Secondary.....	A-5631
				Air Filter Primary.....	A-1013A
				Air Filter Set.....	A-1841-S

MODEL/APPLICATION	SAKURA NO	MODEL/APPLICATION	SAKURA NO	MODEL/APPLICATION	SAKURA NO
KOMATSU		KOMATSU		KOMATSU	
PC300HD-6 (EXCAVATORS) SA6D114 , 2004		Hydraulic Oil Filter.....	H-5629	PC300LC-5 (EXCAVATORS) 614TA	
Fuel Filter.....	FS-5601	Hydraulic Oil Filter.....	H-5646	Air Filter Set.....	A-5662-S
Hydraulic Oil Filter.....	H-85680	Oil Filter Combination.....	C-5707	Air Filter Secondary.....	A-1307
Hydraulic Oil Filter.....	H-7911	PC300HD-7MH (EXCAVATORS) KOMATSU SAA6D114E-2A		Air Filter Primary.....	A-1313
Oil Filter Combination.....	C-57390	Fuel Filter.....	FC-5610	Fuel Filter Secondary.....	FC-7903
Oil Filter Combination.....	C-7927	PC300HD-7MH (EXCAVATORS) SAA6D114E-2A		Fuel/Water Separator.....	SFC-5706
PC300HD-6 (EXCAVATORS) SA6D114-1 , 2004		Air Filter Primary.....	A-5558M	Fuel/Water Separator.....	SFC-5708
Air Filter Primary.....	A-1013	Air Filter Secondary.....	A-5559	Hydraulic Oil Filter.....	H-85680
Air Filter Secondary.....	A-5631	Air Filter Set.....	A-5558M-S	Hydraulic Oil Filter.....	H-7911
Air Filter Primary.....	A-10134	Cabin Air Filter.....	CA-5602	Oil Filter Combination.....	C-5723
Air Filter Set.....	A-1841-S	Cabin Air Filter.....	CA-56041	Oil Filter Combination.....	C-5707
Coolant Filter.....	WC-5705	Fuel Filter.....	F-5218	PC300LC-5 (EXCAVATORS) SA6D108/20001	
Fuel Filter.....	FS-5601	Hydraulic Oil Filter.....	H-5646	Air Filter Set.....	A-5662-S
Fuel/Water Separator.....	SFC-5708	Hydraulic Oil Filter.....	H-5629	Air Filter Primary.....	A-1313
Hydraulic Oil Filter.....	H-7911	Hydraulic Oil Filter.....	H-5629	Air Filter Secondary.....	A-1307
Hydraulic Oil Filter.....	H-85680	Hydraulic Breather.....	H-56610	Fuel Filter.....	FC-5602
Oil Filter Combination.....	C-57390	Oil Filter Combination.....	C-5707	Hydraulic Oil Filter.....	H-5652
Oil Filter Combination.....	C-7927	PC300HD-8 (EXCAVATORS) SAA6D114E-3		Hydraulic Oil Filter.....	H-7911
PC300HD-6MH (EXCAVATORS) SA6D114-1 , 2004		Air Filter Primary.....	A-8665M	Hydraulic Oil Filter.....	H-85680
Air Filter Primary.....	A-1013	Air Filter Secondary.....	A-8580	Oil Filter Full Flow.....	C-5608
Air Filter Secondary.....	A-5631	Cabin Air Filter.....	CA-56041	PC300LC-5 (EXCAVATORS) SA6D108-1/20001/10001	
Air Filter Primary.....	A-10134	Fuel Filter.....	FC-5613	Air Filter Set.....	A-5662-S
Air Filter Set.....	A-1841-S	Hydraulic Oil Filter.....	H-5646	Air Filter Primary.....	A-1313
Coolant Filter.....	WC-5705	Hydraulic Oil Filter.....	H-5629	Air Filter Secondary.....	A-1307
Fuel Filter.....	FS-5601	Hydraulic Oil Filter.....	H-5629	Fuel Filter.....	FC-5602
Fuel/Water Separator.....	SFC-5708	Hydraulic Breather.....	H-56610	Hydraulic Oil Filter.....	H-5652
Hydraulic Oil Filter.....	H-85680	Oil Filter Combination.....	C-5707	Hydraulic Oil Filter.....	H-7911
Hydraulic Oil Filter.....	H-7911	PC300LC-2 (EXCAVATORS) NT-855		Hydraulic Oil Filter.....	H-85680
Oil Filter Combination.....	C-57390	Air Filter Secondary.....	A-5408	Oil Filter Full Flow.....	C-5608
Oil Filter Combination.....	C-7927	Air Filter Primary.....	A-6113	PC300LC-5 (EXCAVATORS) SA6D108	
PC300HD-7 (EXCAVATORS) KOMATSU SAA6D114E-2A		Fuel Filter.....	FC-5602	Fuel Filter.....	FC-5606
Fuel Filter.....	FC-5610	Hydraulic Oil Filter.....	H-7911	PC300LC-6 (EXCAVATORS) SA6D114 , 2004	
PC300HD-7 (EXCAVATORS) SAA6D114E-2A		Hydraulic Oil Filter.....	H-85680	Air Filter Set.....	A-1841-S
Air Filter Set.....	A-5558M-S	Oil Filter By Pass.....	O-5704	Air Filter Secondary.....	A-5631
Air Filter Primary.....	A-5558M	Oil Filter Full Flow.....	C-5605	Air Filter Primary.....	A-10134
Air Filter Secondary.....	A-5559	Oil Filter Full Flow.....	C-5701	Air Filter Primary.....	A-1013
Cabin Air Filter.....	CA-56041	Oil Filter Full Flow.....	C-5715	Fuel Filter.....	FS-5601
Cabin Air Filter.....	CA-5602	PC300LC-3 (EXCAVATORS) S6D125-1/12001/13137		Hydraulic Oil Filter.....	H-85680
Fuel Filter.....	F-5218	Air Filter Primary.....	A-6113	Hydraulic Oil Filter.....	H-7911
Hydraulic Oil Filter.....	H-5629	Air Filter Secondary.....	A-5408	Hydraulic Oil Filter.....	H-7911
Hydraulic Oil Filter.....	H-5646	Fuel Filter.....	FC-5602	Oil Filter Combination.....	C-7927
Oil Filter Combination.....	C-5707	Hydraulic Oil Filter.....	H-7911	Oil Filter Combination.....	C-57390
PC300HD-7L (EXCAVATORS) KOMATSU SAA6D114E-2A		Hydraulic Oil Filter.....	H-5652	PC300LC-6 (EXCAVATORS) SA6D114-1 , 2004	
Fuel Filter.....	FC-5610	Hydraulic Oil Filter.....	H-85680	Air Filter Set.....	A-1841-S
PC300HD-7L (EXCAVATORS) SAA6D114E-2A		Oil Filter Full Flow.....	C-5605	Air Filter Secondary.....	A-5631
Air Filter Primary.....	A-5558M	Oil Filter Full Flow.....	C-5701	Air Filter Primary.....	A-10134
Air Filter Secondary.....	A-5559	Oil Filter Full Flow.....	C-5715	Air Filter Primary.....	A-1013
Air Filter Set.....	A-5558M-S	PC300LC-3 (EXCAVATORS) S6D125-15/12239/13137		Fuel Filter.....	FS-5601
Cabin Air Filter.....	CA-5602	Air Filter Primary.....	A-6113	Fuel/Water Separator.....	SFC-5708
Cabin Air Filter.....	CA-56041	Air Filter Secondary.....	A-5408	Hydraulic Oil Filter.....	H-7911
Fuel Filter.....	F-5218	Fuel Filter.....	FC-5602	Hydraulic Oil Filter.....	H-7911
PC300HD-7L (EXCAVATORS) SAA6D114E-2A		Hydraulic Oil Filter.....	H-7911	Oil Filter Combination.....	C-7927
Air Filter Primary.....	A-5558M	Hydraulic Oil Filter.....	H-85680	Oil Filter Combination.....	C-57390
Air Filter Secondary.....	A-5559	Oil Filter Full Flow.....	C-5715	PC300LC-6 (EXCAVATORS) SA6D114-1 , 2004	
Air Filter Set.....	A-5558M-S	Oil Filter Full Flow.....	C-5701	Air Filter Set.....	A-1841-S
Cabin Air Filter.....	CA-5602	Oil Filter Full Flow.....	C-5715	Air Filter Secondary.....	A-5631
Cabin Air Filter.....	CA-56041	PC300LC-3 (EXCAVATORS) S6D125-15/12239/13137		Air Filter Primary.....	A-10134
Fuel Filter.....	F-5218	Air Filter Primary.....	A-6113	Air Filter Primary.....	A-1013
PC300HD-7L (EXCAVATORS) SAA6D114E-2A		Air Filter Secondary.....	A-5408	Coolant Filter.....	WC-5705
Air Filter Primary.....	A-5558M	Fuel Filter.....	FC-5602	Fuel Filter.....	FS-5601
Air Filter Secondary.....	A-5559	Hydraulic Oil Filter.....	H-7911	Fuel/Water Separator.....	SFC-5708
Air Filter Set.....	A-5558M-S	Hydraulic Oil Filter.....	H-85680	Hydraulic Oil Filter.....	H-7911
Cabin Air Filter.....	CA-5602	Oil Filter Full Flow.....	C-5715	Hydraulic Oil Filter.....	H-85680
Cabin Air Filter.....	CA-56041	Oil Filter Full Flow.....	C-5701	Oil Filter Combination.....	C-7927
Fuel Filter.....	F-5218	Oil Filter Full Flow.....	C-5715		

MODEL/APPLICATION	SAKURA NO	MODEL/APPLICATION	SAKURA NO	MODEL/APPLICATION	SAKURA NO
KOMATSU		KOMATSU		KOMATSU	
PC300LC-6 (EXCAVATORS) SAA6D114-1 , 2004 Oil Filter Combination.....	C-57390	Hydraulic Oil Filter.....	H-5629	Oil Filter Full Flow.....	C-5701
PC300LC-6 (EXCAVATORS) KOMATSU SAA6D108 Fuel Filter.....	FC-5610	Hydraulic Oil Filter.....	H-5646	Oil Filter Full Flow.....	C-5605
PC300LC-6 (EXCAVATORS) KOMATSU SAA6D108E-2 Fuel Filter.....	FC-5601	Hydraulic Breather.....	H-56610	Oil Filter Full Flow.....	C-5715
PC300LC-6 (EXCAVATORS) SAA6D108E-2/30001/19030 Air Filter Secondary.....	A-1307	Oil Filter Combination.....	C-5707	PC30-1 (EXCAVATORS) 3D75-1 Hydraulic Oil Filter.....	H-5607
Air Filter Primary.....	A-1313	PC300LL-6 (EXCAVATORS) SAA6D114-1 , 2004 Air Filter Primary.....	A-1013	PC30-3 (EXCAVATORS) 3D75-1 Hydraulic Oil Filter.....	H-5607
Air Filter Set.....	A-5662-S	Air Filter Secondary.....	A-5631	PC30-5 (EXCAVATORS) 3D84-1/16001/13021 Air Filter Primary.....	AS-2205
Fuel Filter.....	FC-5602	Air Filter Primary.....	A-10134	Fuel Filter.....	F-5207
Hydraulic Oil Filter.....	H-85680	Air Filter Set.....	A-1841-S	Hydraulic Oil Filter.....	H-5607
Hydraulic Oil Filter.....	H-7911	Coolant Filter.....	WC-5705	Oil Filter Full Flow.....	C-1920
Hydraulic Breather.....	H-56610	Fuel Filter.....	FS-5601	PC30-6 (EXCAVATORS) 3D84-1/10001 Air Filter Primary.....	AS-2205
Oil Filter Full Flow.....	C-5614	Fuel/Water Separator.....	SFC-5708	Fuel Filter.....	F-5207
PC300LC-6 (EXCAVATORS) SAA6D108 Air Filter Set.....	A-5662-S	Hydraulic Oil Filter.....	H-7911	Hydraulic Oil Filter.....	H-5607
Air Filter Secondary.....	A-1307	Hydraulic Oil Filter.....	H-85680	Oil Filter Full Flow.....	C-1920
Air Filter Primary.....	A-1313	Oil Filter Combination.....	C-7927	PC30-7 (EXCAVATORS) 3D84E-3/26423 Fuel Filter.....	F-5210
Coolant Filter.....	WC-5705	Oil Filter Combination.....	C-57390	Hydraulic Oil Filter.....	H-5607
Fuel Filter.....	FC-5602	PC300LL-7E0 (EXCAVATORS) SAA6D114E-3 Air Filter Secondary.....	A-8580	Oil Filter Full Flow.....	C-1011
Hydraulic Oil Filter.....	H-85680	Air Filter Primary.....	A-8665M	PC30-7 (EXCAVATORS) 3D84-2/18001/26422 Air Filter Primary.....	AS-2205
Hydraulic Oil Filter.....	H-7911	Cabin Air Filter.....	CA-56041	Fuel Filter.....	F-5210
Oil Filter Full Flow.....	C-5614	Fuel Filter.....	FC-5613	Hydraulic Oil Filter.....	H-5607
PC300LC-6 (EXCAVATORS) SAA6D108E-2A Cabin Air Filter.....	CA-56070	Hydraulic Oil Filter.....	H-5629	Oil Filter Full Flow.....	C-1011
Fuel Filter.....	FC-5606	Hydraulic Oil Filter.....	H-5646	PC30-8 (EXCAVATORS) 3D84E Air Filter Secondary.....	A-5569
PC300LC-7L (EXCAVATORS) KOMATSU SAA6D114E-2A Fuel Filter.....	FC-5610	Oil Filter Combination.....	C-5707	Air Filter Primary.....	A-8513
PC300LC-7L (EXCAVATORS) SAA6D114E-2A Air Filter Primary.....	A-5558M	PC300LL-7L (EXCAVATORS) KOMATSU SAA6D114E-2A Fuel Filter.....	FC-5610	Fuel Filter.....	F-5210
Air Filter Secondary.....	A-5559	Air Filter Primary.....	A-5558M	Hydraulic Oil Filter.....	H-5607
Air Filter Set.....	A-5558M-S	Air Filter Secondary.....	A-5559	Oil Filter Full Flow.....	C-1011
Cabin Air Filter.....	CA-56041	Air Filter Set.....	A-5558M-S	PC30-8 (EXCAVATORS) 3D84E Air Filter Secondary.....	A-5569
Cabin Air Filter.....	CA-5602	Cabin Air Filter.....	CA-56041	Air Filter Primary.....	A-8513
Fuel Filter.....	F-5218	Cabin Air Filter.....	CA-5602	Fuel Filter.....	F-5210
Hydraulic Oil Filter.....	H-5629	Fuel Filter.....	F-5218	Hydraulic Oil Filter.....	H-5607
Hydraulic Oil Filter.....	H-5646	Hydraulic Oil Filter.....	H-5646	Oil Filter Full Flow.....	C-1011
Oil Filter Combination.....	C-5707	Hydraulic Oil Filter.....	H-5629	PC308USLC-3 (EXCAVATORS) SAA6D107E Air Filter Secondary.....	A-5667
PC300LC-8 (EXCAVATORS) KOMATSU SAA6D114E-3D-WT Hydraulic Oil Filter additional part..	H-7105	Hydraulic Oil Filter.....	H-5652	Air Filter Primary.....	A-5666
PC300LC-8 (EXCAVATORS) SAA6D114E-3 Air Filter Primary.....	A-8665M	Hydraulic Oil Filter.....	H-7911	Fuel Filter.....	FC-5613
Air Filter Secondary.....	A-8580	Oil Filter Full Flow.....	C-5715	Hydraulic Oil Filter.....	H-5629
Cabin Air Filter.....	CA-56041	Oil Filter Full Flow.....	C-5701	Hydraulic Oil Filter.....	H-5646
Fuel Filter.....	FC-5613	Oil Filter Full Flow.....	C-5605	PC30MRX-1 (EXCAVATORS) 3D84E Air Filter Primary.....	A-8513
Hydraulic Oil Filter.....	H-5635	PC300NLC-3 (EXCAVATORS) S6D125-1/13137 Air Filter Secondary.....	A-5408	Fuel Filter.....	F-5207
PC300LL-7L (EXCAVATORS) KOMATSU SAA6D114E-2A Fuel Filter.....	FC-5610	Air Filter Primary.....	A-6113	Oil Filter Full Flow.....	C-1011
PC300LL-7L (EXCAVATORS) SAA6D114E-2A Air Filter Primary.....	A-5558M	Fuel Filter.....	FC-5602	PC308USLC-3E0 (EXCAVATORS) Fuel Filter.....	FC-5613
Air Filter Secondary.....	A-5559	Hydraulic Oil Filter.....	H-85680	Hydraulic Oil Filter.....	H-5629
Air Filter Set.....	A-5558M-S	Hydraulic Oil Filter.....	H-5652	Hydraulic Oil Filter.....	H-5646
Cabin Air Filter.....	CA-56041	Hydraulic Oil Filter.....	H-7911	PC300NLC-3 (EXCAVATORS) S6D125-1/13137 Air Filter Secondary.....	A-5408
Cabin Air Filter.....	CA-5602	Oil Filter Full Flow.....	C-5715	Air Filter Primary.....	A-6113
Fuel Filter.....	F-5218	Oil Filter Full Flow.....	C-5701	Fuel Filter.....	FC-5602
Hydraulic Oil Filter.....	H-5629	Oil Filter Full Flow.....	C-5605	Hydraulic Oil Filter.....	H-85680
Hydraulic Oil Filter.....	H-5646	PC300NLC-3 (EXCAVATORS) S6D125-1/13137 Air Filter Primary.....	A-6113	Hydraulic Oil Filter.....	H-5652
Oil Filter Combination.....	C-5707	Fuel Filter.....	FC-5602	Hydraulic Oil Filter.....	H-7911
PC300LC-8 (EXCAVATORS) KOMATSU SAA6D114E-3D-WT Hydraulic Oil Filter additional part..	H-7105	Hydraulic Oil Filter.....	H-85680	PC300NLC-3 (EXCAVATORS) S6D125-1/13137 Air Filter Primary.....	A-6113
PC300LC-8 (EXCAVATORS) SAA6D114E-3 Air Filter Primary.....	A-8665M	Hydraulic Oil Filter.....	H-5652	Fuel Filter.....	FC-5602
Air Filter Secondary.....	A-8580	Hydraulic Oil Filter.....	H-7911	Hydraulic Oil Filter.....	H-85680
Cabin Air Filter.....	CA-56041	Oil Filter Full Flow.....	C-5715	Hydraulic Oil Filter.....	H-5652
Fuel Filter.....	FC-5613	Oil Filter Full Flow.....	C-5701	Hydraulic Oil Filter.....	H-7911
Hydraulic Oil Filter.....	H-5635	Oil Filter Full Flow.....	C-5605		

MODEL/APPLICATION	SAKURA NO	MODEL/APPLICATION	SAKURA NO	MODEL/APPLICATION	SAKURA NO
KOMATSU		KOMATSU		KOMATSU	
PC30R-8 (EXCAVATORS) 3D84E/10001		Hydraulic Oil Filter.....	H-5646	PC350-7 (EXCAVATORS) KOMATSU SAA6D114E-2A	
Air Filter Primary.....	A-8513	Hydraulic Oil Filter.....	H-5629	Fuel Filter.....	FC-5610
Air Filter Secondary.....	A-5569	Hydraulic Breather.....	H-56610	PC350-7 (EXCAVATORS) SAA6D114E-2A	
Fuel Filter.....	F-5210	Oil Filter Combination.....	C-5707	Hydraulic Oil Filter.....	H-5646
Hydraulic Oil Filter.....	H-5607	PC340LC-6K (EXCAVATORS) SAA6D114E-1/K30001-UP/21212392-UP		Hydraulic Oil Filter.....	H-5629
Oil Filter Full Flow.....	C-1011	Air Filter Primary.....	A-10134	Oil Filter Combination.....	C-5707
PC30-SER (EXCAVATORS)		Air Filter Primary.....	A-1013	PC350-8K (EXCAVATORS) 2008	
Fuel Filter.....	F-5207	Air Filter Secondary.....	A-5631	Air Filter Breather.....	A-71330
Hydraulic Oil Filter.....	H-5607	Air Filter Set.....	A-1841-S	Air Filter Primary.....	A-8665M
Oil Filter Full Flow.....	C-1920	Fuel Filter Secondary.....	FC-7903	Air Filter Secondary.....	A-8580
PC340 (EXCAVATORS)		Fuel/Water Separator.....	SFC-5708	Cabin Air Filter.....	CA-56041
Air Filter Breather.....	A-71330	Hydraulic Oil Filter.....	H-7911	Hydraulic Oil Filter.....	H-56292
Air Filter Secondary.....	A-8580	Hydraulic Oil Filter.....	H-85680	Hydraulic Breather.....	H-56610
Fuel Filter Secondary.....	FC-7903	Hydraulic Breather.....	H-56610	Oil Filter Combination.....	C-5707
Fuel/Water Separator.....	SFC-5708	Oil Filter Combination.....	C-5723	PC350AV (EXCAVATORS) SAA6D108	
Hydraulic Oil Filter.....	H-5646	Oil Filter Combination.....	C-5707	Air Filter Set.....	A-5662-S
Hydraulic Oil Filter.....	H-85680	PC340NLC-7K (EXCAVATORS) KOMATSU SAA6D114E-2A		Air Filter Secondary.....	A-1307
Hydraulic Oil Filter.....	H-7911	Fuel Filter.....	FC-5610	Air Filter Primary.....	A-1313
Hydraulic Oil Filter.....	H-5629	PC340NLC-7K (EXCAVATORS) SAA6D114E-2A		Fuel Filter.....	FC-5602
Oil Filter Combination.....	C-5707	Air Filter Primary.....	A-5558M	Hydraulic Oil Filter.....	H-7911
Oil Filter Combination.....	C-5723	Air Filter Secondary.....	A-5559	Hydraulic Oil Filter.....	H-85680
PC340-6 (EXCAVATORS)		Air Filter Set.....	A-5558M-S	Oil Filter Full Flow.....	C-5614
Air Filter Primary.....	A-1013	Cabin Air Filter.....	CA-5602	PC350LC-6 (EXCAVATORS) SAA6D108E-2/10001/19030	
Air Filter Secondary.....	A-5631	Cabin Air Filter.....	CA-56041	Air Filter Secondary.....	A-1307
Air Filter Primary.....	A-10134	Hydraulic Oil Filter.....	H-5629	Air Filter Primary.....	A-1313
Air Filter Set.....	A-1841-S	Hydraulic Oil Filter.....	H-5646	Air Filter Set.....	A-5662-S
Coolant Filter.....	WC-5712	Hydraulic Breather.....	H-56610	Fuel Filter.....	FC-5602
Fuel/Water Separator.....	SFC-5708	Oil Filter Combination.....	C-5707	Hydraulic Oil Filter.....	H-7911
PC340-6 ACTIVE (EXCAVATORS) 2000		PC35 (EXCAVATORS) 3TN84E		Hydraulic Oil Filter.....	H-85680
Fuel/Water Separator.....	SFC-5706	Air Filter Primary.....	AS-1014	Hydraulic Breather.....	H-56610
PC340-6K (EXCAVATORS)		Hydraulic Oil Filter.....	H-5607	Oil Filter Full Flow.....	C-5614
Air Filter Primary.....	A-1013	PC350-6 (EXCAVATORS) SAA6D108E-2/10001/19030		PC350LC-6 (EXCAVATORS) SAA6D108	
Air Filter Secondary.....	A-5631	Air Filter Primary.....	A-1313	Fuel Filter.....	FC-5606
Air Filter Primary.....	A-10134	Air Filter Secondary.....	A-1307	PC350LC-7 (EXCAVATORS) KOMATSU SAA6D114E-2A	
Air Filter Set.....	A-1841-S	Air Filter Set.....	A-5662-S	Fuel Filter.....	FC-5610
Fuel Filter Secondary.....	FC-7903	Fuel Filter.....	FC-5602	PC350LC-7 (EXCAVATORS) SAA6D114E-2A	
Fuel/Water Separator.....	SFC-5708	Hydraulic Oil Filter.....	H-85680	Hydraulic Oil Filter.....	H-5646
Hydraulic Oil Filter.....	H-85680	Hydraulic Oil Filter.....	H-7911	Hydraulic Oil Filter.....	H-5629
Hydraulic Oil Filter.....	H-7911	Hydraulic Breather.....	H-56610	Oil Filter Combination.....	C-5707
Hydraulic Breather.....	H-56610	Oil Filter Full Flow.....	C-5614	PC350LC-8 (EXCAVATORS) KOMATSU , 2008	
Oil Filter Combination.....	C-5723	PC350-6 (EXCAVATORS) SAA6D108		Air Filter Breather.....	A-71330
Oil Filter Combination.....	C-5707	Fuel Filter.....	FC-5606	Hydraulic Oil Filter.....	H-5629
PC340-7 (EXCAVATORS) 2005		PC350-6SER (EXCAVATORS)		Hydraulic Oil Filter.....	H-5646
Air Filter.....	A-3320	Air Filter Secondary.....	A-1307	PC350LC-8 (EXCAVATORS) KOMATSU SAA6D114E-3	
PC340-7K (EXCAVATORS) 2006		Air Filter Primary.....	A-1313	Hydraulic Oil Filter.....	H-5635
Air Filter Primary.....	A-5558M	Air Filter Set.....	A-5662-S	PC350LC-8 (EXCAVATORS)	
Air Filter Secondary.....	A-5559	Fuel Filter.....	FC-5602	PC350LC-8 (EXCAVATORS) KOMATSU SAA6D114E-3	
Air Filter Set.....	A-5558M-S	Hydraulic Oil Filter.....	H-85680	Hydraulic Oil Filter.....	H-5635
Fuel Filter.....	FC-5610	Hydraulic Oil Filter.....	H-7911	PC350LC-8 (EXCAVATORS)	
		Hydraulic Breather.....	H-56610	PC350LC-8 (EXCAVATORS)	
		Oil Filter Full Flow.....	C-5614	PC350LC-8 (EXCAVATORS)	

MODEL/APPLICATION	SAKURA NO	MODEL/APPLICATION	SAKURA NO	MODEL/APPLICATION	SAKURA NO
KOMATSU		KOMATSU		KOMATSU	
PC35MR-5 (EXCAVATORS) S/N: 30001-UP		PC400-3 (EXCAVATORS) S6D125		Air Filter Primary.....	A-1013
Hydraulic Oil Filter.....	H-56110	Air Filter Secondary.....	A-5610	Air Filter Set.....	A-1841-S
PC40 (EXCAVATORS) 4TNE84		Air Filter Primary.....	A-5618	Air Filter Primary.....	A-10134
Air Filter Primary.....	AS-1014	Fuel Filter.....	FC-5602	Air Filter Secondary.....	A-5631
Hydraulic Oil Filter.....	H-5607	Hydraulic Oil Filter.....	H-7911	Fuel Filter.....	FC-5602
PC40 (EXCAVATORS)		Hydraulic Oil Filter.....	H-85680	Hydraulic Oil Filter.....	H-5652
Air Filter Primary.....	AS-2205	Oil Filter Full Flow.....	C-5701	Hydraulic Oil Filter.....	H-5609
Fuel Filter.....	F-5210	Oil Filter Full Flow.....	C-5715	Oil Filter Full Flow.....	C-5605
PC400 (EXCAVATORS) S6D125		Oil Filter By Pass.....	O-5704	Oil Filter Full Flow.....	C-5715
Air Filter Set.....	A-1841-S	Oil Filter Full Flow.....	C-5605	PC400-5 (EXCAVATORS) S6D125-1VV	
Air Filter Primary.....	A-1013	PC400-3 (EXCAVATORS) S6D125-1/11001/13444		Fuel Filter.....	FC-5606
Air Filter Secondary.....	A-5631	Air Filter Secondary.....	A-5408	PC400-6 (EXCAVATORS) SA6D125E	
Air Filter Primary.....	A-10134	Air Filter Primary.....	A-6113	Air Filter Secondary.....	A-5408
Fuel Filter.....	FC-5602	Fuel Filter.....	FC-5602	Air Filter Primary.....	A-6113
Hydraulic Oil Filter.....	H-5609	Hydraulic Oil Filter.....	H-5652	Fuel Filter.....	FC-5602
Oil Filter Full Flow.....	C-5605	Hydraulic Oil Filter.....	H-7911	Hydraulic Oil Filter.....	H-2709
Oil Filter Full Flow.....	C-5701	Hydraulic Oil Filter.....	H-85680	Hydraulic Breather.....	H-56610
Oil Filter Full Flow.....	C-5715	Oil Filter Full Flow.....	C-5715	Oil Filter Full Flow.....	C-5715
PC400 (EXCAVATORS) SA6D125		Oil Filter Full Flow.....	C-5701	Oil Filter Full Flow.....	C-5701
Fuel Filter.....	FC-5602	Oil Filter Full Flow.....	C-5605	Oil Filter Full Flow.....	C-5605
Oil Filter Full Flow.....	C-5701	PC400-3 (EXCAVATORS) S6D125-1T/11455/17974		PC400-6 (EXCAVATORS) SA6D125E-2/30001/60721	
Oil Filter Full Flow.....	C-5715	Fuel Filter.....	FC-5602	Air Filter Primary.....	A-6113
Oil Filter Full Flow.....	C-5605	Hydraulic Oil Filter.....	H-7911	Air Filter Secondary.....	A-5408
PC4000 (EXCAVATORS) CUMMINS KTA38 , 2007		Hydraulic Oil Filter.....	H-85680	Fuel Filter.....	FC-5602
Hydraulic Oil Filter.....	H-62110	Hydraulic Oil Filter.....	H-7911	Hydraulic Oil Filter.....	H-2709
PC4000 (EXCAVATORS) KTA38 , 2007		Oil Filter Full Flow.....	C-5605	Hydraulic Breather.....	H-56610
Oil Filter Full Flow.....	C-5715	Oil Filter Full Flow.....	C-5701	Oil Filter Full Flow.....	C-5715
PC4000 (EXCAVATORS) NT-855		Oil Filter Full Flow.....	C-5701	Oil Filter Full Flow.....	C-5701
Air Filter Secondary.....	A-5610	Oil Filter Full Flow.....	C-5715	Oil Filter Full Flow.....	C-5605
Fuel Filter.....	FC-5602	PC400-3SER (EXCAVATORS)		PC400-6 (EXCAVATORS) SAA6D125E	
Hydraulic Oil Filter.....	H-7911	Air Filter Secondary.....	A-5408	Air Filter Secondary.....	A-5408
Hydraulic Oil Filter.....	H-85680	Air Filter Primary.....	A-6113	Air Filter Primary.....	A-6113
Oil Filter By Pass.....	O-5704	Fuel Filter.....	FC-5602	Fuel Filter.....	FC-5602
Oil Filter Full Flow.....	C-5605	Hydraulic Oil Filter.....	H-5652	Hydraulic Oil Filter.....	H-2709
Oil Filter Full Flow.....	C-5701	Hydraulic Oil Filter.....	H-7911	Oil Filter Full Flow.....	C-5715
Oil Filter Full Flow.....	C-5715	Hydraulic Oil Filter.....	H-85680	Oil Filter Full Flow.....	C-5701
PC400-1SER (EXCAVATORS)		Oil Filter Full Flow.....	C-5715	Oil Filter Full Flow.....	C-5605
Air Filter Secondary.....	A-5610	PC400-5 (EXCAVATORS) S6D125-1VV/20001		PC400-7 (EXCAVATORS)	
Air Filter Primary.....	A-5618	Air Filter Primary.....	A-1013	Air Filter Breather.....	A-92040
Coolant Filter.....	WC-5707	Air Filter Primary.....	A-10134	Fuel/Water Separator Secondary..	SFC-5611-10B
Fuel Filter.....	FC-5602	Air Filter Secondary.....	A-5631	Fuel/Water Separator Secondary..	SFC-5611-10
Hydraulic Oil Filter.....	H-85680	Air Filter Set.....	A-1841-S	Hydraulic Oil Filter.....	H-5639
Hydraulic Oil Filter.....	H-7911	Fuel Filter.....	FC-5602	PC400-7 (EXCAVATORS) SAA6D125E-5	
Oil Filter By Pass.....	O-5704	Hydraulic Oil Filter.....	H-5652	Air Filter Primary.....	A-8665M
Oil Filter Full Flow.....	C-5605	Hydraulic Oil Filter.....	H-5609	Air Filter Secondary.....	A-8580
Oil Filter Full Flow.....	C-5701	Oil Filter Full Flow.....	C-5715	Cabin Air Filter.....	CA-56041
Oil Filter Full Flow.....	C-5715	Oil Filter Full Flow.....	C-5701	Fuel/Water Separator Secondary..	SFC-5611-10B
PC400-5 (EXCAVATORS) S6D125-1/20001/35323		Oil Filter Full Flow.....	C-5605	Fuel/Water Separator Secondary..	SFC-5611-10
Air Filter Set.....	A-1841-S	PC400-5 (EXCAVATORS) S6D125-1/20001/35323		PC400HD-5 (EXCAVATORS) S6D125-1/35323	
Air Filter Primary.....	A-10134	Air Filter Set.....	A-1841-S	Air Filter Set.....	A-1841-S
PC400-5 (EXCAVATORS) S6D125-1/20001/35323		Air Filter Primary.....	A-10134	Air Filter Primary.....	A-10134

MODEL/APPLICATION	SAKURA NO	MODEL/APPLICATION	SAKURA NO	MODEL/APPLICATION	SAKURA NO
KOMATSU		KOMATSU		KOMATSU	
PC400HD-5 (EXCAVATORS) S6D125-1/35323		PC400LC-1 (EXCAVATORS) NT-855		Fuel Filter.....	FC-5606
Air Filter Primary.....	A-1013	Air Filter Secondary.....	A-5610	PC400LC-6 (EXCAVATORS) M11	
Air Filter Secondary.....	A-5631	Fuel Filter.....	FC-5602	Air Filter Primary.....	A-5425
Fuel Filter.....	FC-5602	Hydraulic Oil Filter.....	H-7911	Hydraulic Oil Filter.....	H-5609
Hydraulic Oil Filter.....	H-5609	Hydraulic Oil Filter.....	H-85680	Oil Filter Combination.....	C-5707
Hydraulic Oil Filter.....	H-5652	Oil Filter Full Flow.....	C-5605	Oil Filter Combination.....	C-5723
Oil Filter Full Flow.....	C-5715	Oil Filter By Pass.....	0-5704		
Oil Filter Full Flow.....	C-5605	Oil Filter Full Flow.....	C-5715	PC400LC-6 (EXCAVATORS) SA6D125E	
Oil Filter Full Flow.....	C-5701	Oil Filter Full Flow.....	C-5701	Air Filter Secondary.....	A-5408
				Air Filter Primary.....	A-6113
PC400HD-5 (EXCAVATORS) S6D125-1VV		PC400LC-3 (EXCAVATORS) S6D125-1/11001/13444		Fuel Filter.....	FC-5602
Air Filter Primary.....	A-10134	Air Filter Primary.....	A-6113	Hydraulic Oil Filter.....	H-2709
Air Filter Set.....	A-1841-S	Air Filter Secondary.....	A-5408	Oil Filter Full Flow.....	C-5701
Air Filter Primary.....	A-1013	Fuel Filter.....	FC-5602	Oil Filter Full Flow.....	C-5715
Air Filter Secondary.....	A-5631	Hydraulic Oil Filter.....	H-85680	Oil Filter Full Flow.....	C-5605
Fuel Filter.....	FC-5606	Hydraulic Oil Filter.....	H-7911		
Fuel Filter.....	FC-5602	Hydraulic Oil Filter.....	H-5652	PC400LC-6 (EXCAVATORS) SA6D125E-2/30001/60721	
Hydraulic Oil Filter.....	H-5652	Oil Filter Full Flow.....	C-5715	Air Filter Secondary.....	A-5408
Hydraulic Oil Filter.....	H-5609	Oil Filter Full Flow.....	C-5605	Air Filter Primary.....	A-6113
Oil Filter Full Flow.....	C-5715	Oil Filter Full Flow.....	C-5701	Fuel Filter.....	FC-5602
Oil Filter Full Flow.....	C-5701			Hydraulic Oil Filter.....	H-2709
Oil Filter Full Flow.....	C-5605	PC400LC-3 (EXCAVATORS) S6D125-1T		Hydraulic Breather.....	H-56610
		Fuel Filter.....	FC-5606	Oil Filter Full Flow.....	C-5701
PC400HD-5K (EXCAVATORS) 20001		PC400LC-3 (EXCAVATORS) S6D125-1T/11455/17974		Oil Filter Full Flow.....	C-5715
Air Filter Primary.....	A-1013	Fuel Filter.....	FC-5602	Oil Filter Full Flow.....	C-5605
Air Filter Secondary.....	A-5631	Hydraulic Oil Filter.....	H-85680	Oil Filter Full Flow.....	C-5701
Air Filter Primary.....	A-10134	Hydraulic Oil Filter.....	H-7911		
Air Filter Set.....	A-1841-S	Hydraulic Oil Filter.....	H-5652	PC400LC-6 (EXCAVATORS) SAA6D125E	
Fuel Filter.....	FC-5602	Oil Filter Full Flow.....	C-5715	Air Filter Secondary.....	A-5408
Hydraulic Oil Filter.....	H-5609	Oil Filter Full Flow.....	C-5605	Air Filter Primary.....	A-6113
Oil Filter Full Flow.....	C-5715	Oil Filter Full Flow.....	C-5701	Fuel Filter.....	FC-5602
Oil Filter Full Flow.....	C-5605			Hydraulic Oil Filter.....	H-2709
Oil Filter Full Flow.....	C-5701	PC400LC-5 (EXCAVATORS) S6D125-1VV/20001		Oil Filter Full Flow.....	C-5605
		Air Filter Primary.....	A-1013	Oil Filter Full Flow.....	C-5701
PC400HD-6 (EXCAVATORS) KOMATSU SA6D125E-2		Air Filter Secondary.....	A-5631	Oil Filter Full Flow.....	C-5715
Fuel Filter.....	FC-5610	Air Filter Set.....	A-1841-S		
		Air Filter Primary.....	A-10134	PC400LC-6MH (EXCAVATORS) SA6D125E	
PC400HD-6 (EXCAVATORS) M11		Fuel Filter.....	FC-5602	Air Filter Secondary.....	A-5408
Air Filter Primary.....	A-5425	Hydraulic Oil Filter.....	H-5652	Air Filter Primary.....	A-6113
Hydraulic Oil Filter.....	H-5609	Hydraulic Oil Filter.....	H-5609	Fuel Filter.....	FC-5602
Oil Filter Combination.....	C-5723	Oil Filter Full Flow.....	C-5701	Hydraulic Oil Filter.....	H-2709
Oil Filter Combination.....	C-5707	Oil Filter Full Flow.....	C-5715	Oil Filter Full Flow.....	C-5701
		Oil Filter Full Flow.....	C-5715	Oil Filter Full Flow.....	C-5715
PC400HD-6 (EXCAVATORS) SA6D125E-2		Oil Filter Full Flow.....	C-5605		
Hydraulic Oil Filter.....	H-2709	PC400LC-5 (EXCAVATORS) S6D125-1/20001/35323		PC400LC-6MH (EXCAVATORS) SAA6D125E	
Oil Filter Full Flow.....	C-5605	Air Filter Set.....	A-1841-S	Air Filter Primary.....	A-6113
Oil Filter Full Flow.....	C-5701	Air Filter Primary.....	A-1013	Air Filter Secondary.....	A-5408
Oil Filter Full Flow.....	C-5715	Air Filter Secondary.....	A-5631	Fuel Filter.....	FC-5602
		Air Filter Primary.....	A-10134	Hydraulic Oil Filter.....	H-2709
PC400HD-6LM (EXCAVATORS) KOMATSU SA6D125E-2		Fuel Filter.....	FC-5602	Oil Filter Full Flow.....	C-5715
Fuel Filter.....	FC-5610	Hydraulic Oil Filter.....	H-5609	Oil Filter Full Flow.....	C-5701
		Hydraulic Oil Filter.....	H-5652	Oil Filter Full Flow.....	C-5605
PC400HD-6LM (EXCAVATORS) SA6D125E-2		Oil Filter Full Flow.....	C-5715		
Hydraulic Oil Filter.....	H-2709	Oil Filter Full Flow.....	C-5605	PC400LC-7 (EXCAVATORS) KOMATSU SAA6D125E-3K-8W	
Oil Filter Full Flow.....	C-5605	Oil Filter Full Flow.....	C-5701	Fuel/Water Separator.....	SFC-56020
Oil Filter Full Flow.....	C-5701			Fuel/Water Separator.....	SFC-56020B
Oil Filter Full Flow.....	C-5715	PC400LC-5 (EXCAVATORS) S6D125-1VV			

Sakura Filter

ENGINE APPLICATION

MODEL/APPLICATION	SAKURA NO	MODEL/APPLICATION	SAKURA NO	MODEL/APPLICATION	SAKURA NO
KOMATSU		KOMATSU		KOMATSU	
PC450LC-7 (EXCAVATORS) KOMATSU , 2005		Fuel Filter.....	F-5210	Fuel Filter.....	FC-5604
Hydraulic Breather.....	H-56610	Hydraulic Oil Filter.....	H-5607	Hydraulic Oil Filter.....	H-5607
		Oil Filter Full Flow.....	C-1011	Oil Filter Full Flow.....	C-5606
PC490-10 (EXCAVATORS) SAA6D125E-6		PC50UU-2 (EXCAVATORS) 4D88E-3B/12772/14992		PC60 (EXCAVATORS) 4D95L	
Cabin Air Filter.....	CAC-56120	Air Filter Primary.....	AS-2205	Air Filter Primary.....	AS-1014
Cabin Air Filter.....	CA-56120	Fuel Filter.....	F-5210	Fuel Filter.....	FC-5604
		Hydraulic Oil Filter.....	H-5607	Hydraulic Oil Filter.....	H-5607
PC490LC-10 (EXCAVATORS) SAA6D125E-6		Oil Filter Full Flow.....	C-1011		
Cabin Air Filter.....	CAC-56120	PC50UU-2 (EXCAVATORS) 4D88E-3C/12772/14992		PC600 (EXCAVATORS) CUMMINS N14 , 2004	
Cabin Air Filter.....	CA-56120	Air Filter Primary.....	AS-2205	Fuel/Water Separator.....	SFC-5709-10
		Fuel Filter.....	F-5210		
PC490LC-11 (EXCAVATORS) SAA6D125E-7		Hydraulic Oil Filter.....	H-5607	PC600 (EXCAVATORS) N14 , 2004	
Cabin Air Filter.....	CA-56120	Oil Filter Full Flow.....	C-1011	Air Filter Primary.....	A-6113
Cabin Air Filter.....	CAC-56120	PC50UU-2 (EXCAVATORS) 4D88E-3C/14993		Air Filter Secondary.....	A-5408
		Air Filter Primary.....	AS-2205	Coolant Filter.....	WC-5707
PC400-8R (EXCAVATORS) KOMATSU SAA6D125E-5		Fuel Filter.....	F-5210	Fuel/Water Separator.....	SFC-5509-10
Cabin Air Filter.....	CA-56080	Hydraulic Oil Filter.....	H-5607	Fuel/Water Separator.....	SFC-5709-10
		Oil Filter Full Flow.....	C-1011	Hydraulic Oil Filter.....	H-7911
PC50UU-1 (EXCAVATORS) 1001		Oil Filter Full Flow.....	C-1011	Hydraulic Oil Filter.....	H-85680
Air Filter Primary.....	AS-1014	PC50UU-2 (EXCAVATORS) 4D88E-3C/8001/12771		Oil Filter Combination.....	C-5707
Fuel Filter.....	FC-5604	Air Filter Primary.....	AS-2205	Oil Filter Combination.....	C-5723
Hydraulic Oil Filter.....	H-5607	Fuel Filter.....	F-5210		
		Hydraulic Oil Filter.....	H-5607	PC600 (EXCAVATORS) CUMMINS N14	
PC50UU-2 (EXCAVATORS) 4D84-2GA/12772 - 14992		Oil Filter Full Flow.....	C-1011	Air Filter Secondary.....	A-5408
Air Filter Primary.....	AS-2205	PC5500-6 (EXCAVATORS) SSA12V159		Air Filter Primary.....	A-6113
Fuel Filter.....	F-5210	Air Filter Secondary.....	A-7902		
Hydraulic Oil Filter.....	H-5607	Coolant Filter.....	WC-5703	PC600-7K (EXCAVATORS) 2006	
Oil Filter Full Flow.....	C-1011	Coolant Filter.....	WC-5713	Air Filter Primary.....	A-8665M
		PC50MR-2 (EXCAVATORS) 4D88E , 2005		Air Filter Secondary.....	A-8580
PC50UU-2 (EXCAVATORS) 4D84-2GA/8001 - 12771		Fuel Filter.....	FC-1016	Fuel/Water Separator Secondary..	SFC-5611-10B
Air Filter Primary.....	AS-2205	PC50MR-2 (EXCAVATORS) 4D88E		Fuel/Water Separator Secondary..	SFC-5611-10
Fuel Filter.....	F-5210	Hydraulic Oil Filter.....	H-56540	Hydraulic Breather.....	H-56610
Hydraulic Oil Filter.....	H-5607	PC55MR-3 (EXCAVATORS) 4D88E , 2011			
Oil Filter Full Flow.....	C-1011	Air Filter Primary.....	A-8505	PC600LC-6 (EXCAVATORS) CUMMINS N14	
		Air Filter Secondary.....	A-8599	Fuel/Water Separator.....	SFC-5709-10
PC50UU-2 (EXCAVATORS) 4D88E-3B/14993		PC55MR-3 (EXCAVATORS) YANMAR 4D88E		PC600LC-6 (EXCAVATORS) N14	
Air Filter Primary.....	AS-2205	Hydraulic Oil Filter.....	H-56540	Air Filter Secondary.....	A-6011
Fuel Filter.....	F-5210	PC58UU-3 (EXCAVATORS) 4D88E		Air Filter Primary.....	A-6010
Hydraulic Oil Filter.....	H-5607	Air Filter Secondary.....	A-5569	Coolant Filter.....	WC-5705
Oil Filter Full Flow.....	C-1011	Air Filter Primary.....	A-8513	Fuel/Water Separator.....	SFC-5705
		Hydraulic Oil Filter.....	H-5607	Fuel/Water Separator Secondary..	SFC-1905-10
PC50UU-2 (EXCAVATORS) 4D84-2		PC56-7 (EXCAVATORS) S4D87E-1		Fuel/Water Separator.....	SFC-5709-10
Air Filter Primary.....	AS-2205	Fuel Filter.....	FC-56310	Hydraulic Oil Filter.....	H-2709
Fuel Filter.....	F-5210	PC60 (EXCAVATORS) 4D94-2D		Oil Filter Combination.....	C-5723
Hydraulic Oil Filter.....	H-5607	Air Filter Primary.....	AS-1014	Oil Filter Combination.....	C-5707
Oil Filter Full Flow.....	C-8012				
		PC50UU-2 (EXCAVATORS) 4D84-2GA/14993		PC600LC-8 (EXCAVATORS) SAA6D140E-5	
Air Filter Primary.....	AS-2205	Air Filter Primary.....	AS-1014	Cabin Air Filter.....	CA-56041
				Fuel/Water Separator Secondary..	SFC-5611-10B
PC50UU-2 (EXCAVATORS) 4D84-2				Fuel/Water Separator Secondary..	SFC-5611-10
Air Filter Primary.....	AS-2205				
Fuel Filter.....	F-5210			PC60-1 (EXCAVATORS) 4D94-2	
Hydraulic Oil Filter.....	H-5607			Fuel Filter.....	FC-5604
Oil Filter Full Flow.....	C-8012			Hydraulic Oil Filter.....	H-5607
				Oil Filter Full Flow.....	C-5606

MODEL/APPLICATION	SAKURA NO	MODEL/APPLICATION	SAKURA NO	MODEL/APPLICATION	SAKURA NO
KOMATSU		KOMATSU		KOMATSU	
PC60-1 (EXCAVATORS) 4D94-3		Oil Filter Full Flow.....	C-5606	PC60D-2 (EXCAVATORS) 4D94-2	
Fuel Filter.....	FC-5604	PC60-3-SER (EXCAVATORS) 4D94-3		Fuel Filter.....	FC-5604
Hydraulic Oil Filter.....	H-5607	Fuel Filter.....	FC-5604	Hydraulic Oil Filter.....	H-5607
Oil Filter Full Flow.....	C-5606	Hydraulic Oil Filter.....	H-5607	Oil Filter Full Flow.....	C-5606
PC60-1-SER (EXCAVATORS) 4D94-2		Oil Filter Full Flow.....	C-5606	PC60D-2 (EXCAVATORS) 4D94-3	
Fuel Filter.....	FC-5604	PC60-3-SER (EXCAVATORS) 4D95L-1		Fuel Filter.....	FC-5604
Hydraulic Oil Filter.....	H-5607	Fuel Filter.....	FC-5604	Hydraulic Oil Filter.....	H-5607
Oil Filter Full Flow.....	C-5606	Hydraulic Oil Filter.....	H-5607	Oil Filter Full Flow.....	C-5606
PC60-1-SER (EXCAVATORS) 4D94-3		Oil Filter Full Flow.....	C-5606	PC60L-2 (EXCAVATORS) 4D94-2	
Fuel Filter.....	FC-5604	PC60-5 (EXCAVATORS) 4D95L-1K		Fuel Filter.....	FC-5604
Hydraulic Oil Filter.....	H-5607	Air Filter Primary.....	AS-1014	Hydraulic Oil Filter.....	H-5607
Oil Filter Full Flow.....	C-5606	Fuel Filter.....	FC-5604	Oil Filter Full Flow.....	C-5606
PC60-1-SER (EXCAVATORS) 4D95L-1		Hydraulic Oil Filter.....	H-5607	PC60L-2 (EXCAVATORS) 4D94-3	
Fuel Filter.....	FC-5604	Oil Filter Full Flow.....	C-5604	Fuel Filter.....	FC-5604
Hydraulic Oil Filter.....	H-5607	PC60-5 (EXCAVATORS) 4D95L-1/20501/13144		Hydraulic Oil Filter.....	H-5607
Oil Filter Full Flow.....	C-5606	Air Filter Primary.....	AS-1014	Oil Filter Full Flow.....	C-5606
PC60-2 (EXCAVATORS) 4D94-2		Fuel Filter.....	FC-5604	PC60L-5 (EXCAVATORS) 4D95L-1K	
Fuel Filter.....	FC-5604	Hydraulic Oil Filter.....	H-5607	Air Filter Primary.....	AS-1014
Hydraulic Oil Filter.....	H-5607	Oil Filter Full Flow.....	C-5604	Fuel Filter.....	FC-5604
Oil Filter Full Flow.....	C-5606	PC60-5-SER (EXCAVATORS)		Hydraulic Oil Filter.....	H-5607
PC60-2 (EXCAVATORS) 4D94-3		Air Filter Primary.....	AS-1014	Oil Filter Full Flow.....	C-5604
Fuel Filter.....	FC-5604	Fuel Filter.....	FC-5604	PC60U-5 (EXCAVATORS) 4D95L-1K	
Hydraulic Oil Filter.....	H-5607	Hydraulic Oil Filter.....	H-5607	Air Filter Primary.....	AS-1014
Oil Filter Full Flow.....	C-5606	Oil Filter Full Flow.....	C-5604	Fuel Filter.....	FC-5604
PC60-2-SER (EXCAVATORS) 4D94-2		PC60-6 (EXCAVATORS) 4D95L-1AA		Hydraulic Oil Filter.....	H-5607
Fuel Filter.....	FC-5604	Oil Filter Full Flow.....	C-5615	Oil Filter Full Flow.....	C-5604
Hydraulic Oil Filter.....	H-5607	Oil Filter Full Flow.....	C-5616	PC60U-5 (EXCAVATORS) KOMATSU S4D95L-1K	
Oil Filter Full Flow.....	C-5606	PC60-6 (EXCAVATORS) 4D95L-1BB		Air Filter Secondary.....	A-5647
PC60-2-SER (EXCAVATORS) 4D94-3		Oil Filter Full Flow.....	C-5615	PC60U-5 (EXCAVATORS) S/N: 4501	
Fuel Filter.....	FC-5604	Oil Filter Full Flow.....	C-5616	Air Filter Primary.....	AS-1014
Hydraulic Oil Filter.....	H-5607	PC60-7 (EXCAVATORS) 4D95L-1/45001/15067		Hydraulic Oil Filter.....	H-5607
Oil Filter Full Flow.....	C-5606	Air Filter.....	A-5677	Oil Filter Full Flow.....	C-5604
PC60-2-SER (EXCAVATORS) 4D95L-1		Fuel Filter Secondary.....	FC-7903	PC650 (EXCAVATORS) KT-1150	
Fuel Filter.....	FC-5604	Fuel Filter.....	FC-1801	Coolant Filter.....	WC-5705
Hydraulic Oil Filter.....	H-5607	Fuel/Water Separator.....	SFC-5708	Fuel Filter.....	FC-5602
Oil Filter Full Flow.....	C-5606	Hydraulic Oil Filter.....	H-5607	Hydraulic Oil Filter.....	H-85680
PC60-3 (EXCAVATORS) 4D95L-1		Oil Filter Full Flow.....	C-5606	Hydraulic Oil Filter.....	H-7911
Fuel Filter.....	FC-5604	Oil Filter Full Flow.....	C-5703	Oil Filter Full Flow.....	C-5715
Hydraulic Oil Filter.....	H-5607	PC60-7 (EXCAVATORS) 4D95LE-2		Oil Filter By Pass.....	O-5704
Oil Filter Full Flow.....	C-5615	Air Filter.....	A-5677	PC650 (EXCAVATORS) S6D170	
Oil Filter Full Flow.....	C-5616	Hydraulic Oil Filter.....	H-5607	Coolant Filter.....	WC-6901
Oil Filter Full Flow.....	C-5405	Oil Filter Full Flow.....	C-5604	Fuel Filter.....	FC-5602
PC60-3-SER (EXCAVATORS) 4D94-2		Oil Filter Full Flow.....	C-5615	Hydraulic Oil Filter.....	H-7911
Fuel Filter.....	FC-5604	Oil Filter Full Flow.....	C-5616	Hydraulic Oil Filter.....	H-85680
Hydraulic Oil Filter.....	H-5607	PC60-7 (EXCAVATORS) KOMATSU 4D102E-1B-1		Oil Filter Full Flow.....	C-5715
PC60-3-SER (EXCAVATORS) 4D94-2		Air Filter Secondary.....	A-5647	Oil Filter Full Flow.....	C-5605
Fuel Filter.....	FC-5604			Oil Filter Full Flow.....	C-5701
Hydraulic Oil Filter.....	H-5607				

MODEL/APPLICATION	SAKURA NO	MODEL/APPLICATION	SAKURA NO	MODEL/APPLICATION	SAKURA NO
KOMATSU		KOMATSU		KOMATSU	
PC650 (EXCAVATORS) SA6D140		Fuel Filter.....	FC-5703	Oil Filter By Pass.....	O-5704
Air Filter Secondary.....	A-5610	Fuel/Water Separator.....	SFC-5707	Oil Filter Full Flow.....	C-5715
Air Filter Primary.....	A-5614	Hydraulic Oil Filter.....	HC-5601	Oil Filter Full Flow.....	C-5701
Fuel Filter.....	FC-5703	Hydraulic Oil Filter.....	H-85680	Oil Filter Full Flow.....	C-5605
Fuel/Water Separator.....	SFC-5707	Hydraulic Oil Filter.....	H-7911		
Hydraulic Oil Filter.....	H-85680	Oil Filter Full Flow.....	C-5605	PC650LC-3 (EXCAVATORS) KT19C	
Hydraulic Oil Filter.....	H-7911	Oil Filter Full Flow.....	C-5701	Air Filter Secondary.....	A-5610
Oil Filter Full Flow.....	C-5715	Oil Filter Full Flow.....	C-5715	Air Filter Primary.....	A-5614
Oil Filter Full Flow.....	C-5605			Coolant Filter.....	WC-6901
Oil Filter Full Flow.....	C-5701	PC650-3 (EXCAVATORS) SA6D140-1/10501/10420		Fuel Filter.....	FC-5703
		Air Filter Secondary.....	A-5610	Fuel/Water Separator.....	SFC-5707
PC650-1 (EXCAVATORS) CUMMINS KT-1150		Air Filter Primary.....	A-5614	Hydraulic Oil Filter.....	H-7911
Fuel Filter.....	FC-5606	Fuel Filter.....	FC-5703	Hydraulic Oil Filter.....	HC-5601
		Fuel/Water Separator.....	SFC-5707	Hydraulic Oil Filter.....	H-85680
PC650-1 (EXCAVATORS) KT-1150/10007/117097		Hydraulic Oil Filter.....	HC-5601	Oil Filter Full Flow.....	C-5605
Air Filter Primary.....	A-6113	Hydraulic Oil Filter.....	H-5652	Oil Filter Full Flow.....	C-5701
Air Filter Secondary.....	A-5408	Hydraulic Oil Filter.....	H-7911	Oil Filter Full Flow.....	C-5715
Fuel Filter.....	FC-5602	Hydraulic Oil Filter.....	H-85680		
Fuel Filter.....	FC-5720	Oil Filter Full Flow.....	C-5701	PC650LC-5 (EXCAVATORS) SA6D140-1/20001/18624	
Fuel/Water Separator.....	SFC-5705	Oil Filter Full Flow.....	C-5715	Air Filter Secondary.....	A-5610
Hydraulic Oil Filter.....	H-85680	Oil Filter Full Flow.....	C-5605	Air Filter Primary.....	A-5614
Hydraulic Oil Filter.....	HC-5601			Coolant Filter.....	WC-6901
Hydraulic Oil Filter.....	H-5652	PC650-5 (EXCAVATORS) SA6D140-1/20001/18624		Fuel Filter.....	FC-5703
Hydraulic Oil Filter.....	H-7911	Air Filter Secondary.....	A-5610	Fuel/Water Separator.....	SFC-5707
Oil Filter Full Flow.....	C-5715	Air Filter Primary.....	A-5614	Hydraulic Oil Filter.....	H-7911
Oil Filter By Pass.....	O-5704	Coolant Filter.....	WC-6901	Hydraulic Oil Filter.....	HC-5601
		Fuel Filter.....	FC-5703	Hydraulic Oil Filter.....	H-85680
PC650-1 (EXCAVATORS) S6D170		Fuel/Water Separator.....	SFC-5707	Hydraulic Oil Filter.....	H-5652
Air Filter Secondary.....	A-5408	Hydraulic Oil Filter.....	H-85680	Oil Filter By Pass.....	C-5718
Air Filter Primary.....	A-6113	Hydraulic Oil Filter.....	HC-5601	Oil Filter Full Flow.....	C-5715
Coolant Filter.....	WC-6901	Hydraulic Oil Filter.....	H-5652	Oil Filter Full Flow.....	C-5701
Fuel Filter.....	FC-5606	Hydraulic Oil Filter.....	H-7911	Oil Filter Full Flow.....	C-5605
Fuel Filter.....	FC-5602	Oil Filter Full Flow.....	C-5715		
Hydraulic Oil Filter.....	HC-5601	Oil Filter Full Flow.....	C-5701	PC650LC-5 (EXCAVATORS) SA6D140-1/20001/17739/18623	
Hydraulic Oil Filter.....	H-7911	Oil Filter By Pass.....	C-5718	Air Filter Secondary.....	A-5610
Hydraulic Oil Filter.....	H-85680	Oil Filter Full Flow.....	C-5605	Air Filter Primary.....	A-5614
Oil Filter Full Flow.....	C-5701			Fuel Filter.....	FC-5703
Oil Filter Full Flow.....	C-5715	PC650-5SER (EXCAVATORS)		Fuel/Water Separator.....	SFC-5707
Oil Filter By Pass.....	O-5704	Air Filter Primary.....	A-5614	Hydraulic Oil Filter.....	H-5652
Oil Filter Full Flow.....	C-5605	Coolant Filter.....	WC-56010	Hydraulic Oil Filter.....	H-85680
		Fuel Filter.....	FC-5703	Hydraulic Oil Filter.....	H-7911
PC650-1A (EXCAVATORS) S6D170-1		Fuel/Water Separator.....	SFC-5707	Oil Filter Full Flow.....	C-5715
Air Filter Secondary.....	A-5408	Hydraulic Oil Filter.....	H-85680	Oil Filter Full Flow.....	C-5605
Air Filter Primary.....	A-6113	Hydraulic Oil Filter.....	H-7911	Oil Filter By Pass.....	C-5718
Coolant Filter.....	WC-6901	Hydraulic Oil Filter.....	HC-5601	Oil Filter Full Flow.....	C-5701
Fuel Filter.....	FC-5602	Oil Filter Full Flow.....	C-5605		
Hydraulic Oil Filter.....	H-85680	Oil Filter Full Flow.....	C-5715	PC650SE-5 (EXCAVATORS) SA6D140-1/20001/18624	
Hydraulic Oil Filter.....	H-7911	Oil Filter Full Flow.....	C-5701	Air Filter Secondary.....	A-5610
Hydraulic Oil Filter.....	HC-5601	Oil Filter By Pass.....	C-5718	Air Filter Primary.....	A-5614
Oil Filter Full Flow.....	C-5715			Coolant Filter.....	WC-6901
Oil Filter Full Flow.....	C-5605	PC650E-1 (EXCAVATORS) S6D170		Fuel Filter.....	FC-5703
Oil Filter Full Flow.....	C-5701	Air Filter Primary.....	A-6113	Fuel/Water Separator.....	SFC-5707
		Air Filter Secondary.....	A-5408	Hydraulic Oil Filter.....	H-7911
PC650-3 (EXCAVATORS) KT19C		Coolant Filter.....	WC-6901	Hydraulic Oil Filter.....	HC-5601
Air Filter Secondary.....	A-5610	Fuel Filter.....	FC-5602	Hydraulic Oil Filter.....	H-5652
Air Filter Primary.....	A-5614	Fuel Filter.....	FC-5606	Hydraulic Oil Filter.....	H-85680
Coolant Filter.....	WC-6901	Hydraulic Oil Filter.....	H-7911	Oil Filter Full Flow.....	C-5715
		Hydraulic Oil Filter.....	HC-5601	Oil Filter Full Flow.....	C-5701
		Hydraulic Oil Filter.....	H-85680	Oil Filter By Pass.....	C-5718

MODEL/APPLICATION	SAKURA NO	MODEL/APPLICATION	SAKURA NO	MODEL/APPLICATION	SAKURA NO
KOMATSU		KOMATSU		KOMATSU	
PC650SE-5 (EXCAVATORS) SA6D140-1/20001/18624		Oil Filter Full Flow.....	C-5701	PC7500-1 (EXCAVATORS)	
Oil Filter Full Flow.....	C-5605	Oil Filter Full Flow.....	C-5605	Air Filter.....	A-5677
PC650SE-5 (EXCAVATORS) SA6D140-1/20001/17739/18623		PC710-5 (EXCAVATORS) SA6D140-1/11019/18624		Fuel Filter.....	FC-5604
Air Filter Secondary.....	A-5610	Air Filter Secondary.....	A-5610	Hydraulic Oil Filter.....	H-5607
Air Filter Primary.....	A-5614	Air Filter Primary.....	A-5614	Oil Filter Full Flow.....	C-5405
Fuel Filter.....	FC-5703	Fuel Filter.....	FC-5703	PC750-6 (EXCAVATORS) QSK19	
Fuel/Water Separator.....	SFC-5707	Fuel/Water Separator.....	SFC-5707	Air Filter Secondary.....	A-5610
Hydraulic Oil Filter.....	H-5652	Hydraulic Oil Filter.....	H-7911	Air Filter Primary.....	A-5614
Hydraulic Oil Filter.....	H-7911	Hydraulic Oil Filter.....	H-5652	Coolant Filter.....	WC-56010
Hydraulic Oil Filter.....	H-85680	Hydraulic Oil Filter.....	H-85680	Fuel Filter.....	FC-5703
Oil Filter Full Flow.....	C-5715	Oil Filter Full Flow.....	C-5701	Fuel/Water Separator.....	SFC-5707
Oil Filter Full Flow.....	C-5701	Oil Filter By Pass.....	C-5718	Hydraulic Oil Filter.....	H-7911
Oil Filter By Pass.....	C-5718	Oil Filter Full Flow.....	C-5715	Hydraulic Oil Filter.....	H-85680
Oil Filter Full Flow.....	C-5605	Oil Filter Full Flow.....	C-5605	Hydraulic Oil Filter.....	H-5652
PC600-6 (EXCAVATORS) SA6D140E		PC710-5SER (EXCAVATORS)		Oil Filter By Pass.....	C-5718
Fuel Filter.....	FC-5703	Air Filter Primary.....	A-5614	Oil Filter Full Flow.....	C-5715
Fuel/Water Separator.....	SFC-5707	Fuel Filter.....	FC-5703	Oil Filter Full Flow.....	C-5505
Oil Filter Full Flow.....	C-5605	Fuel/Water Separator.....	SFC-5707	Oil Filter Full Flow.....	C-5605
Oil Filter Full Flow.....	C-5715	Hydraulic Oil Filter.....	HC-5601	Oil Filter Full Flow.....	C-5701
Oil Filter Full Flow.....	C-5701	Hydraulic Oil Filter.....	H-85680	PC750-6 (EXCAVATORS) SAA6D140E	
PC600LC-7 (EXCAVATORS) SA6D140E-3 , 2004		Oil Filter Full Flow.....	C-5605	Air Filter Secondary.....	A-5610
Air Filter Primary.....	A-8665M	Oil Filter Full Flow.....	C-5701	Air Filter Primary.....	A-5614
Air Filter Secondary.....	A-8580	Oil Filter By Pass.....	C-5718	Fuel Filter.....	FC-5703
Cabin Air Filter.....	CA-5602	Oil Filter Full Flow.....	C-5715	Fuel/Water Separator.....	SFC-5707
Cabin Air Filter.....	CA-56041	Oil Filter Full Flow.....	C-5715	Hydraulic Oil Filter.....	H-7911
Fuel/Water Separator Secondary..	SFC-5611-10B	PC710SE-5 (EXCAVATORS) SA6D140-1/11019/18624		Hydraulic Oil Filter.....	H-85680
Fuel/Water Separator Secondary..	SFC-5611-10	Air Filter Secondary.....	A-5610	Oil Filter Full Flow.....	C-5505
Hydraulic Breather.....	H-56610	Air Filter Primary.....	A-5614	Oil Filter Full Flow.....	C-5715
PC600LC-7MH (EXCAVATORS) SA6D140E-3 , 2004		Fuel Filter.....	FC-5703	Oil Filter Full Flow.....	C-5605
Air Filter Secondary.....	A-8580	Fuel/Water Separator.....	SFC-5707	Oil Filter Full Flow.....	C-5701
Air Filter Primary.....	A-8665M	Hydraulic Oil Filter.....	H-85680	PC750-6 (EXCAVATORS) SAA6D140E-2	
Cabin Air Filter.....	CA-56041	Hydraulic Oil Filter.....	H-7911	Air Filter Secondary.....	A-5610
Cabin Air Filter.....	CA-5602	Hydraulic Oil Filter.....	H-5652	Air Filter Primary.....	A-5614
Fuel/Water Separator Secondary..	SFC-5611-10	Oil Filter Full Flow.....	C-5701	Fuel Filter.....	FC-5703
Fuel/Water Separator Secondary..	SFC-5611-10B	Oil Filter By Pass.....	C-5718	Fuel/Water Separator.....	SFC-5707
Hydraulic Breather.....	H-56610	Oil Filter Full Flow.....	C-5715	Hydraulic Oil Filter.....	H-7911
PC60-8 (EXCAVATORS) SAA4D95LE-5		Oil Filter Full Flow.....	C-5605	Hydraulic Oil Filter.....	H-85680
Fuel/Water Separator.....	SFC-56060	PC75 (EXCAVATORS) 4D95L		Oil Filter Full Flow.....	C-5715
PC70 (EXCAVATORS) 4D95L		Fuel Filter.....	FC-1801	Oil Filter Full Flow.....	C-5505
Air Filter.....	A-5677	Hydraulic Oil Filter.....	H-5607	Oil Filter Full Flow.....	C-5605
Fuel Filter.....	FC-1801	Oil Filter Full Flow.....	C-5606	Oil Filter Full Flow.....	C-5701
Hydraulic Oil Filter.....	H-5607	PC75 (EXCAVATORS)		PC750LC-6 (EXCAVATORS) QSK19	
PC710 (EXCAVATORS) SA6D140		Fuel Filter.....	FC-1016	Air Filter Secondary.....	A-5610
Air Filter Secondary.....	A-5610	Oil Filter Full Flow.....	C-1011	Air Filter Primary.....	A-5614
Air Filter Primary.....	A-5614	PC750 (EXCAVATORS) CUMMINS QSK19		Coolant Filter.....	WC-56010
Fuel Filter.....	FC-5703	Fuel/Water Separator.....	SFC-5709-10	Fuel Filter.....	FC-5703
Fuel/Water Separator.....	SFC-5707	PC750 (EXCAVATORS) QSK19		Fuel/Water Separator.....	SFC-5707
Hydraulic Oil Filter.....	H-85680	Fuel/Water Separator.....	SFC-5709-10	Hydraulic Oil Filter.....	H-7911
Hydraulic Oil Filter.....	H-7911	Oil Filter Combination.....	C-5707	Hydraulic Oil Filter.....	H-85680
Oil Filter Full Flow.....	C-5715	Oil Filter Combination.....	C-5723	Hydraulic Oil Filter.....	H-5652

MODEL/APPLICATION	SAKURA NO	MODEL/APPLICATION	SAKURA NO	MODEL/APPLICATION	SAKURA NO
KOMATSU		KOMATSU		KOMATSU	
PC750LC-6 (EXCAVATORS) QSK19		Hydraulic Oil Filter.....	H-85680	PC75UU-3 (EXCAVATORS) KOMATSU 4D102E-1C	
Oil Filter Full Flow.....	C-5605	Hydraulic Oil Filter.....	H-5652	Oil Filter Full Flow.....	C-5712
		Hydraulic Oil Filter.....	H-7911		
PC750LC-6 (EXCAVATORS) SAA6D140E		Oil Filter Full Flow.....	C-5715	PC78MR-6 (EXCAVATORS) S4D95LE-3	
Air Filter Secondary.....	A-5610	Oil Filter By Pass.....	C-5718	Air Filter Primary.....	A-8505
Air Filter Primary.....	A-5614	Oil Filter Full Flow.....	C-5505	Air Filter Secondary.....	A-8599
Fuel Filter.....	FC-5703	Oil Filter Full Flow.....	C-5701	Fuel Filter.....	FC-1801
Fuel/Water Separator.....	SFC-5707	Oil Filter Full Flow.....	C-5605	Fuel Filter.....	FC-1108
Hydraulic Oil Filter.....	H-7911			Oil Filter Full Flow.....	C-56191
Hydraulic Oil Filter.....	H-85680			Oil Filter Full Flow.....	C-56190
Oil Filter Full Flow.....	C-5701	PC750SE-6 (EXCAVATORS) SAA6D140E/10001		PC78MR-6 (EXCAVATORS) S4D95LE-3A	
Oil Filter Full Flow.....	C-5605	Air Filter Secondary.....	A-5610	Hydraulic Oil Filter.....	H-56540
Oil Filter Full Flow.....	C-5505	Air Filter Primary.....	A-5614		
Oil Filter Full Flow.....	C-5715	Fuel Filter.....	FC-5703	PC78MR-8 (EXCAVATORS)	
		Fuel/Water Separator.....	SFC-5707	Fuel Filter.....	FC-1801
PC750LC-6 (EXCAVATORS) SAA6D140E-2		Hydraulic Oil Filter.....	H-7911	Oil Filter Full Flow.....	C-56190
Air Filter Primary.....	A-5614	Hydraulic Oil Filter.....	H-85680	Oil Filter Full Flow.....	C-56191
Air Filter Secondary.....	A-5610	Oil Filter Full Flow.....	C-5505		
Fuel Filter.....	FC-5703	Oil Filter Full Flow.....	C-5701	PC750LC-7 (EXCAVATORS) SAA6D140E	
Fuel/Water Separator.....	SFC-5707	Oil Filter Full Flow.....	C-5605	Air Filter Secondary.....	A-8580
Hydraulic Oil Filter.....	H-85680			Air Filter Primary.....	A-8665M
Hydraulic Oil Filter.....	H-7911	PC750SE-6 (EXCAVATORS) SAA6D140E-2/10001		Cabin Air Filter.....	CA-56041
Oil Filter Full Flow.....	C-5701	Air Filter Secondary.....	A-5610	Coolant Filter.....	WC-56010
Oil Filter Full Flow.....	C-5715	Air Filter Primary.....	A-5614	Hydraulic Oil Filter.....	HC-5602
Oil Filter Full Flow.....	C-5605	Fuel Filter.....	FC-5703	Hydraulic Oil Filter.....	H-5618
Oil Filter Full Flow.....	C-5505	Fuel/Water Separator.....	SFC-5707	Hydraulic Breather.....	H-56610
		Hydraulic Oil Filter.....	H-7911		
PC750LC-6MH (EXCAVATORS) SAA6D140E		Hydraulic Oil Filter.....	H-85680	PC750LC-7MH (EXCAVATORS) SAA6D140E	
Air Filter Secondary.....	A-5610	Oil Filter Full Flow.....	C-5715	Air Filter Secondary.....	A-8580
Air Filter Primary.....	A-5614	Oil Filter Full Flow.....	C-5505	Air Filter Primary.....	A-8665M
Fuel Filter.....	FC-5703	Oil Filter Full Flow.....	C-5701	Cabin Air Filter.....	CA-56041
Fuel/Water Separator.....	SFC-5707	Oil Filter Full Flow.....	C-5605	Coolant Filter.....	WC-56010
Hydraulic Oil Filter.....	H-85680			Hydraulic Oil Filter.....	H-5618
Hydraulic Oil Filter.....	H-7911	PC75R (EXCAVATORS)		Hydraulic Oil Filter.....	HC-5602
Oil Filter Full Flow.....	C-5605	Air Filter Secondary.....	A-7964	Hydraulic Breather.....	H-56610
Oil Filter Full Flow.....	C-5701	Air Filter Secondary.....	A-7004		
Oil Filter Full Flow.....	C-5715	Fuel Filter.....	F-5218	PC78US-6 (EXCAVATORS) 4D95LE-2C	
Oil Filter Full Flow.....	C-5505	Fuel Filter.....	FC-1016	Hydraulic Oil Filter.....	H-56540
		Oil Filter Full Flow.....	C-1011		
PC750LC-6MH (EXCAVATORS) SAA6D140E-2				PC78US-6 (EXCAVATORS) S4D95LE-3	
Air Filter Secondary.....	A-5610	PC75R-2 (EXCAVATORS) S/N: 22E5200001		Air Filter Secondary.....	A-8599
Air Filter Primary.....	A-5614	Fuel Filter.....	F-5218	Air Filter Primary.....	A-8505
Fuel Filter.....	FC-5703	Fuel Filter.....	FC-1016	Fuel Filter.....	FC-1801
Fuel/Water Separator.....	SFC-5707	Oil Filter Full Flow.....	C-1011	Fuel Filter.....	FC-1108
Hydraulic Oil Filter.....	H-7911			Hydraulic Oil Filter.....	H-56540
Hydraulic Oil Filter.....	H-85680	PC75UU-2 (EXCAVATORS) 4D95L-1		Oil Filter Full Flow.....	C-56191
Oil Filter Full Flow.....	C-5715	Fuel Filter Secondary.....	FC-7903	Oil Filter Full Flow.....	C-56190
Oil Filter Full Flow.....	C-5605	Fuel Filter.....	FC-1801		
Oil Filter Full Flow.....	C-5701	Fuel/Water Separator.....	SFC-5708	PC78US-8 (EXCAVATORS) SAA4D95LE	
Oil Filter Full Flow.....	C-5505	Hydraulic Oil Filter.....	H-5607	Hydraulic Oil Filter.....	H-56540
		Oil Filter Full Flow.....	C-5606		
PC750SE-6 (EXCAVATORS) QSK19		PC75UU-3 (EXCAVATORS) 4D102E-1C/15001		PC78UU-6 (EXCAVATORS) 4D95LE-2C	
Air Filter Secondary.....	A-5610	Air Filter.....	A-5677	Hydraulic Oil Filter.....	H-56540
Air Filter Primary.....	A-5614	Fuel Filter Secondary.....	FC-7903		
Coolant Filter.....	WC-56010	Fuel/Water Separator.....	SFC-5708	PC750LC-7 (EXCAVATORS) SAA6D140E	
Fuel Filter.....	FC-5703	Oil Filter Full Flow.....	C-5703	Air Filter Secondary.....	A-8580
Fuel/Water Separator.....	SFC-5707			Air Filter Primary.....	A-8665M

Sakura Filter

ENGINE APPLICATION

MODEL/APPLICATION	SAKURA NO	MODEL/APPLICATION	SAKURA NO	MODEL/APPLICATION	SAKURA NO
KOMATSU		KOMATSU		KOMATSU	
PC78UU-6 (EXCAVATORS) S4A95LE-3		Oil Filter Full Flow.....	C-5715	Cabin Air Filter.....	CA-56041
Hydraulic Oil Filter.....	H-56540	Oil Filter Full Flow.....	C-5505	Coolant Filter.....	WC-56010
PC78UU-8 (EXCAVATORS) SAA4D95LE		Oil Filter Full Flow.....	C-5605	Fuel/Water Separator Secondary..	SFC-5611-10B
Hydraulic Oil Filter.....	H-56540	Oil Filter Full Flow.....	C-5701	Fuel/Water Separator Secondary..	SFC-5611-10
PC80 (EXCAVATORS) 4D105		PC800SE-6 (EXCAVATORS) SAA6D140E/30001		Hydraulic Oil Filter.....	HC-5602
Air Filter Secondary.....	A-7806	Air Filter Secondary.....	A-5610	Hydraulic Breather.....	H-56610
Air Filter Primary.....	AS-7805	Air Filter Primary.....	A-5614	PC800LC-8 (EXCAVATORS) SAA6D140E-5	
Fuel Filter.....	FC-5604	Fuel Filter.....	FC-5703	Air Filter Secondary.....	A-8580
Hydraulic Oil Filter.....	H-5622	Fuel/Water Separator.....	SFC-5707	Air Filter Primary.....	A-8665M
Oil Filter Full Flow.....	C-5614	Hydraulic Oil Filter.....	H-7911	Cabin Air Filter.....	CA-56041
PC80 (EXCAVATORS) 4D95L		Hydraulic Oil Filter.....	H-85680	Coolant Filter.....	WC-56010
Air Filter Primary.....	AS-1014	Oil Filter Full Flow.....	C-5715	Fuel/Water Separator Secondary..	SFC-5611-10B
Fuel Filter.....	FC-5604	Oil Filter Full Flow.....	C-5605	Fuel/Water Separator Secondary..	SFC-5611-10
Hydraulic Oil Filter.....	H-5607	Oil Filter Full Flow.....	C-5701	Hydraulic Oil Filter.....	HC-5602
Oil Filter Full Flow.....	C-5405	Oil Filter Full Flow.....	C-5505	Hydraulic Breather.....	H-56610
PC80 (EXCAVATORS) w/Komatsu 4D105 Eng		PC80-1 (EXCAVATORS) 4D105-5/1001/100006		PC800-8K (EXCAVATORS) SAA6D140E-5	
Hydraulic Oil Filter.....	H-5519	Air Filter Primary.....	AS-7805	Air Filter Secondary.....	A-8580
PC80 (EXCAVATORS) 2006		Air Filter Secondary.....	A-7806	Air Filter Primary.....	A-8665M
Air Filter Primary.....	A-8665M	Fuel Filter.....	FC-5604	Cabin Air Filter.....	CA-56041
Air Filter Secondary.....	A-8580	Hydraulic Oil Filter.....	H-5622	Coolant Filter.....	WC-56010
Fuel/Water Separator Secondary..	SFC-5611-10	Oil Filter Full Flow.....	C-5614	Fuel/Water Separator Secondary..	SFC-5611-10B
Fuel/Water Separator Secondary..	SFC-5611-10B	PC80-1 (EXCAVATORS) w/Komatsu 4D105-5K Eng		Fuel/Water Separator Secondary..	SFC-5611-10
Hydraulic Oil Filter.....	HC-5602	Hydraulic Oil Filter.....	H-5519	Hydraulic Oil Filter.....	HC-5602
Hydraulic Breather.....	H-56610	PC80-3 (EXCAVATORS) 4D95L-1/2001/15941		Hydraulic Breather.....	H-56610
PC800-7 (EXCAVATORS) 2006		Air Filter Primary.....	AS-1014	PC800LC-8E0 (EXCAVATORS) SAA6D140E-5	
Air Filter Primary.....	A-8665M	Fuel Filter.....	FC-5604	Air Filter Primary.....	A-8665M
Air Filter Secondary.....	A-8580	Hydraulic Oil Filter.....	H-5607	Air Filter Secondary.....	A-8580
Fuel/Water Separator Secondary..	SFC-5611-10B	Oil Filter Full Flow.....	C-5604	Cabin Air Filter.....	CA-56041
Fuel/Water Separator Secondary..	SFC-5611-10	PC80-3-SER (EXCAVATORS)		Coolant Filter.....	WC-56010
Hydraulic Oil Filter.....	HC-5602	Air Filter Primary.....	AS-1014	Fuel/Water Separator Secondary..	SFC-5611-10B
Hydraulic Breather.....	H-56610	Fuel Filter.....	FC-5604	Fuel/Water Separator Secondary..	SFC-5611-10
PC800SE-6 (EXCAVATORS) SAA6D140E		Hydraulic Oil Filter.....	H-5607	Hydraulic Oil Filter.....	HC-5602
Air Filter Secondary.....	A-5610	Oil Filter Full Flow.....	C-5604	Hydraulic Breather.....	H-56610
Air Filter Primary.....	A-5614	PC80LC-3 (EXCAVATORS) 4D95L-1/2001/15941		PC800LC-8K (EXCAVATORS) SAA6D140E-5	
Fuel Filter.....	FC-5703	Air Filter Primary.....	AS-1014	Air Filter Primary.....	A-8665M
Fuel/Water Separator.....	SFC-5707	Fuel Filter.....	FC-5604	Air Filter Secondary.....	A-8580
Hydraulic Oil Filter.....	H-85680	Hydraulic Oil Filter.....	H-5607	Cabin Air Filter.....	CA-56041
Hydraulic Oil Filter.....	H-7911	Oil Filter Full Flow.....	C-5604	Coolant Filter.....	WC-56010
Oil Filter Full Flow.....	C-5605	PC800-8 (EXCAVATORS) SAA6D140E-5		Fuel/Water Separator Secondary..	SFC-5611-10B
Oil Filter Full Flow.....	C-5715	Air Filter Secondary.....	A-8580	Fuel/Water Separator Secondary..	SFC-5611-10
Oil Filter Full Flow.....	C-5701	Air Filter Primary.....	A-8665M	Hydraulic Oil Filter.....	HC-5602
PC800SE-6 (EXCAVATORS) SAA6D140E-2/30001		Cabin Air Filter.....	CA-56041	Hydraulic Breather.....	H-56610
Air Filter Secondary.....	A-5610	Coolant Filter.....	WC-56010	PC88MR-8 (EXCAVATORS) SAA4D95LE-5 , 2008	
Air Filter Primary.....	A-5614	Fuel/Water Separator Secondary..	SFC-5611-10B	Cabin Air Filter.....	CA-56041
Fuel Filter.....	FC-5703	Fuel/Water Separator Secondary..	SFC-5611-10	Oil Filter Full Flow.....	C-56191
Fuel/Water Separator.....	SFC-5707	Hydraulic Oil Filter.....	HC-5602	Oil Filter Full Flow.....	C-56190
Hydraulic Oil Filter.....	H-7911	Hydraulic Breather.....	H-56610	PC88MR-8 (EXCAVATORS) KOMATSU SAA4D95LE-5	
Hydraulic Oil Filter.....	H-85680	PC800-8E0 (EXCAVATORS) SAA6D140E-5		Fuel Filter.....	FC-56290
PC800SE-6 (EXCAVATORS) SAA6D140E-2/30001		Air Filter Secondary.....	A-8580	PC88MR-8 (EXCAVATORS) SAA4D95LE-5	
Air Filter Secondary.....	A-5610	Air Filter Primary.....	A-8665M	Hydraulic Oil Filter.....	H-56540
Air Filter Primary.....	A-5614	PC800-8E0 (EXCAVATORS) SAA6D140E-5			
Fuel Filter.....	FC-5703	Air Filter Secondary.....	A-8580		
Fuel/Water Separator.....	SFC-5707	Air Filter Primary.....	A-8665M		

MODEL/APPLICATION	SAKURA NO	MODEL/APPLICATION	SAKURA NO	MODEL/APPLICATION	SAKURA NO
KOMATSU		KOMATSU		KOMATSU	
PC88MR-8 (EXCAVATORS) S/N: F80003-UP Hydraulic Breather..... H-42300		PF-666 (MOTOR GRADERS) DETROIT DIESEL Fuel Filter Secondary..... F-6502 Fuel Filter..... F-6503 Fuel Filter..... F-6505 Oil Filter Full Flow..... 0-6503		PW100-3SER (EXCAVATORS) Air Filter Primary..... AS-7805 Air Filter Secondary..... A-7806 Fuel Filter..... FC-5604 Hydraulic Oil Filter..... H-56600 Hydraulic Oil Filter..... H-5610 Oil Filter Full Flow..... C-5604	
PC90 (EXCAVATORS) 4D95L Air Filter..... A-5677 Fuel Filter..... FC-1801 Hydraulic Oil Filter..... H-5607 Oil Filter Full Flow..... C-5405		PF-777 (MOTOR GRADERS) CUMMINS Fuel Filter..... FC-1303 Fuel Filter..... FC-5720 Fuel Filter..... F-5701 Fuel/Water Separator..... SFC-5705 Hydraulic Oil Filter Transmission... H-65030 Oil Filter Full Flow..... 0-5702 Oil Filter Full Flow..... C-8031 Oil Filter Full Flow..... 0-6503		PW110R (EXCAVATORS) KOMATSU S4D106-1FB Fuel/Water Separator..... SF-52150	
PC90-1 (EXCAVATORS) 4D95L-1/1001/49969 Air Filter..... A-5677 Fuel Filter..... FC-1801 Hydraulic Oil Filter..... H-5607 Oil Filter Full Flow..... C-5405		PF-777 (MOTOR GRADERS) DETROIT DIESEL Fuel Filter..... F-6505 Fuel Filter Secondary..... F-6502 Fuel Filter..... F-6503 Oil Filter Full Flow..... 0-6503		PW110R (EXCAVATORS) Air Filter Secondary..... A-5540 Fuel Filter..... FC-1016 Oil Filter Full Flow..... C-5204	
PC95 (EXCAVATORS) Air Filter Primary..... AS-5628 Air Filter Primary..... A-5628 Air Filter Set..... A-5628-S Fuel Filter..... FC-5715		PW05-1 (EXCAVATORS) 3D72-2/1001 Fuel Filter..... F-5207		PW130 (EXCAVATORS) S4D961-1 Air Filter Primary..... AS-7988 Air Filter Secondary..... A-7964 Fuel Filter..... FC-5605 Hydraulic Oil Filter..... H-56600 Hydraulic Oil Filter..... H-5610 Oil Filter Full Flow..... C-5606	
PC95-1 (EXCAVATORS) Air Filter Primary..... AS-5628 Air Filter Primary..... A-5628 Air Filter Set..... A-5628-S		PW100 (EXCAVATORS) S4D105-5 Air Filter Secondary..... A-6009 Air Filter Primary..... AS-1024 Air Filter Set..... AS-1024-S Fuel Filter..... FC-5604 Hydraulic Oil Filter..... H-5610 Hydraulic Oil Filter..... H-56600 Oil Filter Full Flow..... C-5614		PW130ES-6 (EXCAVATORS) Air Filter Secondary..... A-7964 Air Filter Primary..... AS-7988 Fuel Filter Secondary..... FC-7903 Fuel/Water Separator..... SFC-5708 Hydraulic Oil Filter..... H-56600 Hydraulic Oil Filter..... H-5610	
PC95R-2 (EXCAVATORS) 4D106 Air Filter Primary..... A-5541 Air Filter Secondary..... A-5540 Fuel Filter..... FC-1016 Oil Filter Full Flow..... C-5204		PW100-1 (EXCAVATORS) S4D105-5 Air Filter Primary..... AS-1024 Air Filter Set..... AS-1024-S Air Filter Secondary..... A-6009 Fuel Filter..... FC-5604 Hydraulic Oil Filter..... H-5610 Hydraulic Oil Filter..... H-56600 Oil Filter Full Flow..... C-5614		PW130ES-6K (EXCAVATORS) S4D102E-1AA/K30545-UP/21273646-UP Air Filter Secondary..... A-7964 Air Filter Primary..... AS-7988 Fuel Filter Secondary..... FC-7903 Fuel/Water Separator..... SFC-5708 Hydraulic Oil Filter Suction..... H-2706 Hydraulic Oil Filter..... H-5610 Hydraulic Oil Filter..... H-56600	
PC95R-2 (EXCAVATORS) Fuel/Water Separator..... SF-52150		PW100-1 (EXCAVATORS) S4D105-5/1003 Fuel Filter..... FC-5604 Hydraulic Oil Filter..... H-5610 Hydraulic Oil Filter..... H-56600 Oil Filter Full Flow..... C-5614		PW150-1 (EXCAVATORS) 6D95L-1/1001 Air Filter Secondary..... A-7806 Air Filter Primary..... AS-7805 Fuel Filter..... FC-5604 Hydraulic Oil Filter..... H-56600 Hydraulic Oil Filter..... H-5610 Oil Filter Full Flow..... C-5604	
PD-105 (MOTOR GRADERS) 16V-71 Fuel Filter..... FC-1810 Fuel/Water Separator..... SFC-5705		PW100-3 (EXCAVATORS) S6D95L-1/1601 Air Filter Primary..... AS-7805 Air Filter Secondary..... A-7806 Fuel Filter..... FC-5604 Hydraulic Oil Filter..... H-5610 Hydraulic Oil Filter..... H-56600 Oil Filter Full Flow..... C-5604		PW150ES-6 (EXCAVATORS) Air Filter Secondary..... A-7964 Air Filter Primary..... AS-7988 Fuel Filter Secondary..... FC-7903 Fuel/Water Separator..... SFC-5708 Hydraulic Oil Filter..... H-5610 Hydraulic Oil Filter..... H-56600	
PF55L-1 (EXCAVATORS) S6D105-B-1A/10001/81935 Coolant Filter..... WC-5707 Fuel Filter..... FC-5621 Hydraulic Oil Filter..... H-5609 Oil Filter Full Flow..... C-5608					
PF-666 (MOTOR GRADERS) CUMMINS Fuel Filter..... F-5701 Fuel Filter..... FC-5720 Fuel Filter..... FC-1303 Fuel/Water Separator..... SFC-5705 Hydraulic Oil Filter Transmission... H-65030 Oil Filter Full Flow..... 0-6503 Oil Filter Full Flow..... C-8031 Oil Filter Full Flow..... 0-5702					

Sakura Filter

ENGINE APPLICATION

MODEL/APPLICATION	SAKURA NO	MODEL/APPLICATION	SAKURA NO	MODEL/APPLICATION	SAKURA NO
KOMATSU		KOMATSU		KOMATSU	
PW160ES-7 (EXCAVATORS)		PW110R-1 (EXCAVATORS) KOMATSU		PW160-7 (EXCAVATORS) KOMATSU SAA4D102E-2	
Cabin Air Filter.....	CA-56041	Air Filter Primary.....	A-5541	Air Filter Secondary.....	A-56741
Fuel Filter Secondary.....	FC-7903	Air Filter Secondary.....	A-5540	Air Filter Primary.....	A-56731
Fuel/Water Separator.....	SFC-5708	Fuel Filter.....	FC-1016	Air Filter Set.....	A-56731-S
Hydraulic Oil Filter.....	H-5629	PW110R-1 (EXCAVATORS) KOMATSU S4D106E-1FB		PW160-7 (EXCAVATORS) SAA4D102E-2	
Hydraulic Oil Filter.....	H-5646	Fuel/Water Separator.....	SF-52150	Air Filter Secondary.....	A-8670
PW170ES-6 (EXCAVATORS)		PW118MR-8 (EXCAVATORS) SAA4D95LE-5 , 2011		Air Filter Primary.....	A-5673
Air Filter Secondary.....	A-7964	Air Filter Primary.....	A-5541	Air Filter Secondary.....	A-5674
Air Filter Primary.....	AS-7988	Air Filter Secondary.....	A-5540	Air Filter Set.....	A-5675-S
Fuel Filter Secondary.....	FC-7903	Cabin Air Filter.....	CA-56041	Cabin Air Filter.....	CA-56041
Fuel/Water Separator.....	SFC-5706	Fuel/Water Separator.....	SFC-56040	Fuel Filter.....	F-5218
Fuel/Water Separator.....	SFC-5708	Hydraulic Oil Filter.....	H-56650	Hydraulic Oil Filter.....	H-5646
Hydraulic Oil Filter.....	H-56600	Hydraulic Oil Filter.....	H-56610	Hydraulic Oil Filter.....	H-5629
Hydraulic Oil Filter.....	H-5610	Hydraulic Breather.....	H-56610	Hydraulic Breather.....	H-56610
PW170ES-6 (EXCAVATORS) SAA4D102E		Oil Filter Full Flow.....	C-56191	Oil Filter Full Flow.....	C-5703
Air Filter Secondary.....	A-7964	Oil Filter Full Flow.....	C-56190	PW180-7 (EXCAVATORS) KOMATSU	
Air Filter Primary.....	AS-7988	PW130-7K (EXCAVATORS) SAA4D102E-2		Hydraulic Oil Filter.....	H-5629
Cabin Air Filter Set.....	CA-5601-S	Cabin Air Filter.....	CA-56041	Hydraulic Oil Filter.....	H-5646
Cabin Air Filter.....	CA-56041	Fuel Filter Secondary.....	FC-7903	PW160-7K (EXCAVATORS) SAA4D102E-2	
Fuel/Water Separator.....	SFC-5708	Fuel/Water Separator.....	SFC-5708	Air Filter Secondary.....	A-5674
Hydraulic Oil Filter.....	H-5610	Hydraulic Oil Filter.....	H-56600	PW200 (EXCAVATORS) 2004	
Hydraulic Oil Filter.....	H-56600	PW140-7 (EXCAVATORS) SAA4D107E-1		Air Filter Primary.....	A-8577
PW170-SK (EXCAVATORS)		Air Filter Primary.....	A-8577	Cabin Air Filter.....	CA-56041
Air Filter Primary.....	AS-7988	Air Filter Secondary.....	A-8578	Fuel Filter Secondary.....	FC-7903
Air Filter Secondary.....	A-7964	Cabin Air Filter.....	CA-56041	Fuel/Water Separator.....	SFC-5708
Fuel Filter.....	FC-5715	Fuel Filter.....	FC-5613	Hydraulic Oil Filter.....	H-5646
Hydraulic Oil Filter.....	H-56600	Hydraulic Oil Filter.....	H-5629	Hydraulic Oil Filter.....	H-5629
Hydraulic Oil Filter.....	H-5610	Hydraulic Oil Filter.....	H-5646	PW200-7 (EXCAVATORS) SAA6D102E-2	
Oil Filter Full Flow.....	C-5102	Hydraulic Breather.....	H-56610	Air Filter Primary.....	A-8577
PW170-5K (EXCAVATORS) 1006-6TD		PW148-8 (EXCAVATORS) SAA4D107E-1 , 2010		Air Filter Secondary.....	A-8578
Air Filter Secondary.....	A-7964	Air Filter Secondary.....	A-8578	Cabin Air Filter.....	CA-5602
Air Filter Primary.....	AS-7988	Air Filter Primary.....	A-8577	Cabin Air Filter.....	CA-56041
Fuel Filter.....	FC-5715	Cabin Air Filter.....	CA-56041	Fuel Filter.....	F-5218
Hydraulic Oil Filter.....	H-56600	Hydraulic Oil Filter.....	H-5646	Hydraulic Oil Filter.....	H-5646
Hydraulic Oil Filter.....	H-5610	Hydraulic Oil Filter.....	H-5629	Hydraulic Oil Filter.....	H-5629
Oil Filter Full Flow.....	C-5102	Hydraulic Breather.....	H-56610	Oil Filter Full Flow.....	C-5611
PW170-5K (EXCAVATORS) 1006-6TLR2		Oil Filter Full Flow.....	C-5611	Oil Filter Full Flow.....	C-5610
Air Filter Primary.....	AS-7988	PW148-8 (EXCAVATORS) KOMATSU SAA4D107E-1		PW20-1 (EXCAVATORS) 3D84-1/1001	
Air Filter Secondary.....	A-7964	Fuel/Water Separator.....	SFC-19100	Air Filter Primary.....	AS-2205
Fuel Filter.....	FC-5715	PW148-8 (EXCAVATORS) SAA4D107E-1		Fuel Filter.....	F-5207
Hydraulic Oil Filter.....	H-56600	Fuel Filter.....	FC-5613	Hydraulic Oil Filter.....	HC-5602
Hydraulic Oil Filter.....	H-5610	PW150ES-6K (EXCAVATORS) SAA4D102E-2		Oil Filter Full Flow.....	C-1920
Oil Filter Full Flow.....	C-5102	Air Filter Secondary.....	A-7964	PW210-1 (EXCAVATORS) S6D105-1/10001	
PW170ES-6K (EXCAVATORS) SAA4D102E		Air Filter Primary.....	AS-7988	Air Filter Primary.....	A-5639
Air Filter Secondary.....	A-7964	Cabin Air Filter Set.....	CA-5601-S	Air Filter Secondary.....	A-5635
Air Filter Primary.....	AS-7988	Fuel/Water Separator.....	SFC-5708	Hydraulic Oil Filter.....	H-5609
Cabin Air Filter Set.....	CA-5601-S	Hydraulic Oil Filter.....	H-56600	Oil Filter Full Flow.....	C-5608
Cabin Air Filter.....	CA-56041	Hydraulic Breather.....	H-56610	PW220 (EXCAVATORS) 2004	
Fuel/Water Separator.....	SFC-5708	Oil Filter Full Flow.....	C-5703		
Hydraulic Oil Filter.....	H-5610				
Hydraulic Oil Filter.....	H-56600				

MODEL/APPLICATION	SAKURA NO	MODEL/APPLICATION	SAKURA NO	MODEL/APPLICATION	SAKURA NO
KOMATSU		KOMATSU		KOMATSU	
PW220 (EXCAVATORS) 2004		PW60-1 (EXCAVATORS) 4D94-2/1501		Cabin Air Filter.....	CA-56041
Air Filter Primary.....	A-8577	Air Filter Primary.....	AS-1014	Oil Filter Full Flow.....	C-56190
Cabin Air Filter.....	CA-56041	Fuel Filter.....	FC-5604	Oil Filter Full Flow.....	C-56191
Fuel Filter Secondary.....	FC-7903	Hydraulic Oil Filter.....	H-5607		
Fuel/Water Separator.....	SFC-5708	Oil Filter Full Flow.....	C-5606	PW98MR-8 (EXCAVATORS) SAA4D95LE-5	
Hydraulic Oil Filter.....	H-5646			Hydraulic Oil Filter.....	H-56540
Hydraulic Oil Filter.....	H-5629	PW60-1-SER (EXCAVATORS)		PW98MR-6 (EXCAVATORS) S4D95LE-3 , 2006	
PW200-7H (EXCAVATORS) H50051 - UP		Air Filter Primary.....	AS-1014	Air Filter Secondary.....	A-7004
Air Filter Secondary.....	A-8578	Fuel Filter.....	FC-5604	Air Filter Primary.....	A-8624
Air Filter Primary.....	A-8577	Hydraulic Oil Filter.....	H-5607	Fuel Filter.....	FC-5615
Cabin Air Filter.....	CA-56041	Oil Filter Full Flow.....	C-5606	Fuel Filter.....	FC-1108
Fuel Filter.....	F-5218			Fuel Filter.....	FC-1801
Hydraulic Oil Filter.....	H-5629	PW60-3 (EXCAVATORS) 4D95L-1/2001		Oil Filter Full Flow.....	C-56190
Hydraulic Oil Filter.....	H-5646	Air Filter Primary.....	AS-1014	Oil Filter Full Flow.....	C-56191
Hydraulic Breather.....	H-56610	Fuel Filter.....	FC-5604		
Oil Filter Full Flow.....	C-5611	Hydraulic Oil Filter.....	H-5607	PX21 (EXCAVATORS)	
		Oil Filter Full Flow.....	C-5604	Air Filter Primary.....	A-5673
PW220-7K (EXCAVATORS) SAA6D102E-2		PW60N-1 (EXCAVATORS) 4D94-2D		Air Filter Secondary.....	A-5674
Air Filter Primary.....	A-8577	Air Filter Primary.....	AS-1014	Air Filter Set.....	A-5675-S
Air Filter Secondary.....	A-8578	Fuel Filter.....	FC-5604	Air Filter Secondary.....	A-8670
Cabin Air Filter.....	CA-5602	Hydraulic Oil Filter.....	H-5607	Fuel Filter Secondary.....	FC-7903
Cabin Air Filter.....	CA-56041	Oil Filter Full Flow.....	C-5606	Fuel/Water Separator.....	SFC-5708
Fuel Filter.....	F-5218				
Hydraulic Oil Filter.....	H-5629	PW75 (EXCAVATORS)		R2 D1394 (MOTOR GRADERS) S/N: 30601	
Hydraulic Oil Filter.....	H-5646	Fuel Filter.....	FC-1016	Air Filter Set.....	A-5604-S
Hydraulic Breather.....	H-56610	Oil Filter Full Flow.....	C-1011	Air Filter Primary.....	A-5605
Oil Filter Full Flow.....	C-5611			Air Filter Secondary.....	A-5606
		PW95 (EXCAVATORS)		Hydraulic Oil Filter.....	H-5620
PW30-1 (EXCAVATORS) 3D84-1/1001		Air Filter Primary.....	AS-5628	Oil Filter Full Flow.....	C-5614
Air Filter Primary.....	AS-2205	Air Filter Primary.....	A-5628		
Fuel Filter.....	F-5207	Air Filter Set.....	A-5628-S	S-7B (SKIDDERS) DETROIT DIESEL	
Hydraulic Oil Filter.....	HC-5602	Fuel Filter.....	FC-5715	Fuel Filter.....	F-6505
Oil Filter Full Flow.....	C-1920			Fuel Filter.....	F-6503
		PW95R (EXCAVATORS)		Oil Filter Full Flow.....	O-6503
PW400MH-6 (EXCAVATORS) 6D125E-5		Air Filter Secondary.....	A-5540		
Cabin Air Filter.....	CA-56070	Fuel Filter.....	FC-1016	S7C (SKIDDERS) 3-53	
Fuel Filter.....	FC-5606	Oil Filter Full Flow.....	C-5204	Fuel Filter Secondary.....	F-6502
PW60 (EXCAVATORS) 4D94-2		PW95R-2 (EXCAVATORS) KOMATSU 4D106-1FB		S-7 SERIES B (SKIDDERS) 220	
Fuel Filter.....	FC-5604	Fuel/Water Separator.....	SF-52150	Oil Filter Full Flow.....	O-1901
Hydraulic Oil Filter.....	H-5607				
Oil Filter Full Flow.....	C-5606	PW95R-2 (EXCAVATORS) KOMATSU 4D106-25FB		S-7 SERIES B (SKIDDERS) 3-53	
		Fuel/Water Separator.....	SF-52150	Fuel Filter Secondary.....	F-6502
PW60-1 (EXCAVATORS) 1501		PW95R-2 (EXCAVATORS)		Fuel Filter.....	F-6505
Air Filter Primary.....	AS-1014	Air Filter Primary.....	AS-7805	Oil Filter Full Flow.....	O-6503
Fuel Filter.....	FC-5604	Air Filter Secondary.....	A-7964		
Hydraulic Oil Filter.....	H-5607	Fuel Filter.....	FC-1016	S8 (SKIDDERS) 3-53	
Oil Filter Full Flow.....	C-5606	Oil Filter Full Flow.....	C-5204	Fuel Filter Secondary.....	F-6502
PW60-1 (EXCAVATORS) 4D94-2D		PW95R-2 (EXCAVATORS) YANMAR 4400NLCES		S8 (SKIDDERS) DETROIT DIESEL	
Air Filter Primary.....	AS-1014	Fuel/Water Separator.....	SF-52150	Fuel Filter.....	F-6505
Fuel Filter.....	FC-5604			Fuel Filter.....	F-6503
Hydraulic Oil Filter.....	H-5607	PW98MR-8 (EXCAVATORS) SAA4D95LE-5 , 2012		Oil Filter Full Flow.....	O-6503
Oil Filter Full Flow.....	C-5606	Air Filter Primary.....	AS-7805		
				S8A (SKIDDERS) D358	
				Air Filter Primary.....	AS-7805

MODEL/APPLICATION	SAKURA NO	MODEL/APPLICATION	SAKURA NO	MODEL/APPLICATION	SAKURA NO
KOMATSU		KOMATSU		KOMATSU	
S8A (SKIDDERS) D358		SK07 L (LOADERS)		Air Filter Primary.....	A-8505
Fuel Filter.....	FC-5403	Air Filter Primary.....	AS-2205	Air Filter Secondary.....	A-8599
		Fuel Filter.....	F-5210	Oil Filter Full Flow.....	C-8012
S8A (SKIDDERS) D360		SK07J-2 (LOADERS)		SK815-5 (LOADERS) S4D84E TURBO	
Air Filter Primary.....	AS-7805	Air Filter Primary.....	AS-2205	Air Filter Primary.....	A-8505
Fuel Filter.....	FC-7933	Fuel Filter.....	F-5210	Air Filter Secondary.....	A-8599
Fuel/Water Separator.....	SFC-5705	Oil Filter Full Flow.....	C-1011	Fuel Filter.....	F-5210
S-9A (SKIDDERS) D310		SK09 (LOADERS)		SK820-5 (LOADERS) S4D84E , 2004	
Air Filter Primary.....	AS-5628	Fuel Filter.....	F-5218	Air Filter Primary.....	A-8505
Air Filter Primary.....	A-5628	Fuel Filter.....	F-5210	Air Filter Secondary.....	A-8599
Air Filter Set.....	A-5628-S	Oil Filter Full Flow.....	C-1011	SP6000 (COMPACTORS)	
S9B (SKIDDERS) DT360		SK09J (LOADERS)		Air Filter Primary.....	AS-5628
Air Filter Primary.....	AS-1024	Hydraulic Oil Filter.....	HC-7906	Air Filter Primary.....	A-5628
Air Filter Set.....	AS-1024-S	SK1026-5 (LOADERS) S4D96E , 2004		Air Filter Set.....	A-5628-S
Air Filter Secondary.....	A-7809	Air Filter Set.....	A-8506-S	Fuel Filter.....	FC-5103
Fuel Filter.....	FC-7933	Air Filter Secondary.....	A-7004	SUPER B 45 (LOADERS)	
Fuel/Water Separator.....	SFC-5705	Air Filter Primary.....	A-8506	Fuel Filter.....	FC-5103
SD15 (FORKLIFTS) F2L411W		Fuel Filter.....	FC-5201	SUPER B 450 (LOADERS)	
Fuel Filter.....	FC-6205	Oil Filter Full Flow.....	C-8012	Fuel Filter.....	FC-5103
Oil Filter Full Flow.....	C-8016	SK510-5 (LOADERS) 3D84E , 2008		SUPER BMD (LOADERS)	
Oil Filter Full Flow.....	C-1828	Air Filter Secondary.....	A-5569	Fuel Filter.....	FC-5103
SD20 (FORKLIFTS) C221		Air Filter Primary.....	A-8513	SUPER BTD 6 (LOADERS)	
Oil Filter Full Flow.....	O-1803	Oil Filter Full Flow.....	C-1720	Fuel Filter.....	FC-5103
SD25 (FORKLIFTS) F2L912		SK714 (LOADERS)		SUPER BMD 6 (LOADERS)	
Air Filter.....	A-6809	Air Filter Secondary.....	A-5569	Fuel Filter.....	FC-5103
Fuel Filter.....	FC-6205	Fuel Filter.....	F-5210	SUPER FCD (TRACTORS)	
Fuel Filter.....	F-2604	Hydraulic Oil Filter.....	HC-55220	Fuel Filter.....	F-2601
		Hydraulic Oil Filter.....	HC-5507	Fuel Filter.....	FC-5103
SD25F (FORKLIFTS) F2L912		Oil Filter Full Flow.....	C-1011	SUPER W 9 (LOADERS)	
Air Filter.....	A-6809	SK714-5 (LOADERS)		Fuel Filter.....	FC-5103
Fuel Filter.....	FC-6205	Air Filter Secondary.....	A-5569	SUPER W6 (LOADERS)	
Fuel Filter.....	F-2604	Fuel Filter.....	F-5210	Fuel Filter.....	FC-5103
Oil Filter Full Flow.....	C-6204	Oil Filter Full Flow.....	C-1011	SUPER WD 9 (LOADERS)	
SK04 (LOADERS)		SK815 (LOADERS)		Fuel Filter.....	FC-5103
Air Filter Primary.....	AS-2205	Air Filter Secondary.....	A-5569	SV12 (COMPACTORS) F6L413	
Fuel Filter.....	FC-1501	Fuel Filter.....	F-5210	Air Filter Primary.....	AS-5628
SK05 (LOADERS)		Hydraulic Oil Filter.....	HC-55220	Air Filter Primary.....	A-5628
Air Filter Primary.....	AS-2205	Hydraulic Oil Filter.....	HC-5507	Air Filter Set.....	A-5628-S
Fuel Filter.....	F-5210	Oil Filter Full Flow.....	C-1011	Fuel Filter.....	F-2604
Fuel Filter.....	F-5214	SK818-5 (LOADERS) KOMATSU , 2004		Fuel Filter.....	FC-5704
Oil Filter Full Flow.....	C-1011	Air Filter Secondary.....	A-5569	Oil Filter Full Flow.....	C-6203
SK07 (LOADERS)		Fuel Filter.....	F-5210	Oil Filter Full Flow.....	C-6204
Air Filter Primary.....	AS-2205	Hydraulic Oil Filter.....	HC-55220		
Fuel Filter.....	F-5210	Hydraulic Oil Filter.....	HC-5507		
Fuel Filter.....	F-5214	Oil Filter Full Flow.....	C-1011		
Oil Filter Full Flow.....	C-1011	SK820-5N (LOADERS) S4D98E-2NFD			

MODEL/APPLICATION	SAKURA NO	MODEL/APPLICATION	SAKURA NO	MODEL/APPLICATION	SAKURA NO
KOMATSU		KOMATSU		KOMATSU	
SV7 (COMPACTORS) F3L912		Fuel Filter.....	F-6503	TC4000 (CRANES) KTA-600	
Air Filter Primary.....	A-5628	Oil Filter Full Flow.....	0-6503	Coolant Filter.....	WC-5705
Air Filter Set.....	A-5628-S	T-600 SERIES B (MOTOR GRADERS) C-160		Fuel Filter.....	FC-5720
Air Filter Primary.....	AS-5628	Fuel Filter.....	F-5701	Fuel/Water Separator.....	SFC-5705
Fuel Filter.....	FC-5704	Oil Filter Full Flow.....	0-5702	Oil Filter Full Flow.....	C-5715
Oil Filter Full Flow.....	C-6202	T-600 SERIES B (MOTOR GRADERS) JS-6		TC4000 (CRANES) VT-903	
SV7 (COMPACTORS) F4L912		Fuel Filter.....	F-5701	Coolant Filter.....	WC-5705
Air Filter Set.....	A-5628-S	Oil Filter Full Flow.....	0-5702	Fuel Filter.....	FC-5702
Air Filter Primary.....	AS-5628	T700 (MOTOR GRADERS) CUMMINS		Oil Filter Full Flow.....	C-5715
Air Filter Primary.....	A-5628	Fuel Filter.....	F-5701	Oil Filter By Pass.....	C-5718
Fuel Filter.....	FC-5704	Hydraulic Oil Filter Transmission...	H-65030	TC500 (CRANES) DEUTZ	
Oil Filter Full Flow.....	C-6202	Oil Filter Full Flow.....	0-5702	Fuel Filter.....	FC-5704
T-225SL (LOADERS) V-549		TC1200 (CRANES) F12L413 BF12L413		Fuel Filter.....	F-2603
Oil Filter Full Flow.....	0-6503	Fuel Filter.....	F-2603	Fuel Filter.....	FC-6202
T-300SL (LOADERS) V-549		Fuel Filter.....	FC-6202	Fuel Filter.....	FC-6202
Oil Filter Full Flow.....	0-6503	Fuel Filter.....	F-2604	Oil Filter Full Flow.....	C-6203
T-400 SERIES A (MOTOR GRADERS) 4-53		Oil Filter Full Flow.....	C-6204	Oil Filter Full Flow.....	C-6204
Fuel Filter.....	F-6505	Oil Filter Full Flow.....	C-6203	TC600 (CRANES) F10L413	
Fuel Filter.....	F-6503	TC150 (CRANES) F8L413F		Fuel Filter.....	F-2604
Oil Filter Full Flow.....	0-6503	Fuel Filter.....	FC-5704	Oil Filter Full Flow.....	C-6203
T-400 SERIES A (MOTOR GRADERS) D407A		Oil Filter Full Flow.....	C-6204	Oil Filter Full Flow.....	C-6204
Hydraulic Oil Filter Transmission...	H-65030	Oil Filter Full Flow.....	C-6203	TC600 (CRANES) F12L413	
T500 (MOTOR GRADERS) 4-71		TC2000 (CRANES) F12L413 BF12L413		Fuel Filter.....	FC-5704
Fuel Filter.....	F-6505	Fuel Filter.....	FC-6202	Fuel Filter.....	F-2604
Fuel Filter Secondary.....	F-6502	Fuel Filter.....	F-2603	Oil Filter Full Flow.....	C-6203
Hydraulic Oil Filter Transmission...	H-65030	Fuel Filter.....	F-2604	Oil Filter Full Flow.....	C-6204
Oil Filter Full Flow.....	0-6503	Oil Filter Full Flow.....	C-6204	Oil Filter Full Flow.....	C-6204
T-500 SERIES A (MOTOR GRADERS) 4-71		Oil Filter Full Flow.....	C-6203	TC600 (CRANES) F6L413	
Fuel Filter.....	F-6505	TC280 (CRANES) F10/12L413		Fuel Filter.....	FC-5704
Fuel Filter Secondary.....	F-6502	Fuel Filter.....	FC-6202	Fuel Filter.....	F-2604
Hydraulic Oil Filter Transmission...	H-65030	Fuel Filter.....	F-2604	Oil Filter Full Flow.....	C-6204
Oil Filter Full Flow.....	0-6503	Oil Filter Full Flow.....	C-6204	Oil Filter Full Flow.....	C-6203
T-600 (MOTOR GRADERS) 6-71		Oil Filter Full Flow.....	C-6203	Oil Filter Full Flow.....	C-6204
Fuel Filter.....	F-6505	TC300 (CRANES) F10L413		TC600 (CRANES) F8L413	
Fuel Filter.....	F-6503	Fuel Filter.....	F-2604	Fuel Filter.....	FC-5704
Oil Filter Full Flow.....	0-6503	Oil Filter Full Flow.....	C-6203	Fuel Filter.....	F-2604
T-600 (MOTOR GRADERS) C-160		Oil Filter Full Flow.....	C-6204	Oil Filter Full Flow.....	C-6203
Fuel Filter.....	F-5701	TC300 (CRANES) F6L413		Oil Filter Full Flow.....	C-6204
Oil Filter Full Flow.....	0-5702	Fuel Filter.....	FC-5704	TD12 (DOZERS) D466B	
T-600 (MOTOR GRADERS) JS-6		Oil Filter Full Flow.....	C-6204	Air Filter Set.....	A-7610-S
Fuel Filter.....	F-5701	Oil Filter Full Flow.....	C-6203	Air Filter Primary.....	A-7610
Oil Filter Full Flow.....	0-5702	Oil Filter Full Flow.....	C-6204	Air Filter Secondary.....	A-7608
T-600 SERIES B (MOTOR GRADERS) 6-71		Oil Filter Full Flow.....	C-6203	Fuel Filter.....	FC-7933
Fuel Filter.....	F-6505	TC300 (CRANES) F8L413		Fuel/Water Separator.....	SFC-5705
TC300 (CRANES) F6L413		Fuel Filter.....	FC-5704	TD12C (DOZERS)	
Oil Filter Full Flow.....	C-6204	Oil Filter Full Flow.....	C-6204	Fuel Filter.....	FC-7933
Oil Filter Full Flow.....	C-6203	Oil Filter Full Flow.....	C-6203	Fuel/Water Separator.....	SFC-5705
Fuel Filter.....	FC-5704	TC300 (CRANES) F8L413		TD15B (DOZERS) DT361	
Oil Filter Full Flow.....	C-6204	Fuel Filter.....	FC-5704	Air Filter.....	A-85370
Oil Filter Full Flow.....	C-6203	Oil Filter Full Flow.....	C-6204		
Fuel Filter.....	F-6505	Oil Filter Full Flow.....	C-6203		

MODEL/APPLICATION	SAKURA NO	MODEL/APPLICATION	SAKURA NO	MODEL/APPLICATION	SAKURA NO
KOMATSU		KOMATSU		KOMATSU	
TD15B <i>(DOZERS)</i> DT407		Fuel Filter.....	F-6505	Hydraulic Oil Filter Transmission...	H-65030
Air Filter Set.....	A-5660-S	Fuel Filter Secondary.....	F-6502	Hydraulic Oil Filter.....	H-5406
Air Filter Primary.....	A-5413	Oil Filter Full Flow.....	O-6503	Oil Filter Full Flow.....	C-5402
Fuel Filter.....	FC-1810				
Fuel Filter.....	FC-7933	TD20C <i>(DOZERS)</i> DVT-573B		TD25G <i>(DOZERS)</i> KT-1150	
Fuel/Water Separator.....	SFC-5705	Air Filter Set.....	A-5420-S	Coolant Filter.....	WC-5703
		Air Filter Secondary.....	A-5406	Fuel/Water Separator.....	SFC-5709-10
TD15B <i>(DOZERS)</i> DT466		Air Filter Primary.....	A-5405	Fuel/Water Separator.....	SFC-5705
Air Filter Primary.....	A-5413	Air Filter Primary.....	A-5420	Oil Filter Full Flow.....	C-5715
Air Filter Secondary.....	A-5414	Air Filter Set.....	A-5405-S	Oil Filter By Pass.....	C-5718
Air Filter Set.....	A-5660-S	Fuel Filter Secondary.....	FC-54050		
Fuel Filter.....	FC-1810	Fuel/Water Separator.....	SFC-5705	TD30 <i>(DOZERS)</i>	
Fuel Filter.....	FC-7933	Oil Filter Full Flow.....	C-5402	Air Filter.....	A-8545
Fuel/Water Separator.....	SFC-5705			Hydraulic Oil Filter Transmission...	H-65030
		TD20E <i>(DOZERS)</i> V-800			
TD15C <i>(DOZERS)</i> D505T		Air Filter Set.....	A-5420-S	TD40 <i>(DOZERS)</i> KTA-1150	
Air Filter.....	A-7631	Air Filter Primary.....	A-5420	Coolant Filter.....	WC-5703
Air Filter Set.....	A-7633-S	Fuel Filter Secondary.....	FC-54050	Fuel/Water Separator.....	SFC-5709-10
Air Filter Secondary.....	A-7632	Oil Filter Full Flow.....	C-5402	Fuel/Water Separator.....	SFC-5705
Coolant Filter.....	WC-5705			Oil Filter By Pass.....	C-5718
Fuel Filter Secondary.....	FC-7903	TD20G <i>(DOZERS)</i> CUMMINS		Oil Filter Full Flow.....	C-5715
Fuel/Water Separator.....	SFC-5706	Air Filter.....	A-5434		
Fuel/Water Separator.....	SFC-5708	Fuel Filter.....	FS-5701	TD5 <i>(DOZERS)</i>	
Oil Filter Full Flow.....	C-1305	Fuel/Water Separator.....	SFC-5705	Oil Filter Full Flow.....	O-1803
		Fuel/Water Separator.....	SFC-5709-10		
TD15C <i>(DOZERS)</i> DT407		Fuel/Water Separator Secondary...	SFC-1905-10	TD5B <i>(DOZERS)</i>	
Air Filter Set.....	A-5660-S	Oil Filter By Pass.....	C-5718	Oil Filter Full Flow.....	O-1803
Air Filter Primary.....	A-5413	Oil Filter Full Flow.....	C-5715		
Fuel Filter.....	FC-1810			TD6B SERIES II <i>(DOZERS)</i> D239	
Fuel Filter.....	FC-7933	TD-225SL <i>(DOZERS)</i> 6V-53		Air Filter Secondary.....	A-76560
Fuel/Water Separator.....	SFC-5705	Fuel Filter Secondary.....	F-6502		
		Fuel Filter.....	F-6505	TD7 <i>(DOZERS)</i>	
TD15C <i>(DOZERS)</i> DT466		Oil Filter Full Flow.....	O-6503	Fuel Filter.....	FC-5403
Air Filter Set.....	A-5660-S			Fuel Filter.....	FC-5103
Air Filter Primary.....	A-5413	TD25-250 <i>(DOZERS)</i>			
Air Filter Secondary.....	A-5414	Air Filter.....	A-57240	TD7C <i>(DOZERS)</i> D206	
Fuel Filter.....	FC-1810			Fuel Filter.....	FC-5403
Fuel Filter.....	FC-7933	TD25B <i>(DOZERS)</i> DT817		TD7E <i>(DOZERS)</i> D239	
Fuel/Water Separator.....	SFC-5705	Air Filter Primary.....	A-5425	Fuel Filter.....	FC-5403
		Air Filter.....	A-57240		
TD15C <i>(DOZERS)</i> DT466B		Hydraulic Oil Filter Transmission...	H-65030	TD8 <i>(DOZERS)</i>	
Air Filter Set.....	A-5660-S			Fuel Filter.....	FC-5103
Air Filter Primary.....	A-5413	TD25C <i>(DOZERS)</i> DT817B		Fuel Filter.....	FC-5403
Air Filter Secondary.....	A-5414	Air Filter Secondary.....	A-5417		
Fuel Filter.....	FC-1810	Air Filter Primary.....	A-5425	TD8B <i>(DOZERS)</i> D239	
Fuel Filter.....	FC-7933	Fuel Filter Secondary.....	FC-54050	Air Filter Secondary.....	A-76560
Fuel/Water Separator.....	SFC-5705	Fuel/Water Separator.....	SFC-5705		
		Oil Filter Full Flow.....	C-5402	TD8B SERIES II <i>(DOZERS)</i> D239	
TD15E <i>(DOZERS)</i> DT466C				Air Filter Secondary.....	A-76560
Air Filter Secondary.....	A-5414	TD25E <i>(DOZERS)</i> DT817C			
Air Filter Set.....	A-5660-S	Air Filter Secondary.....	A-5417	TD8C <i>(DOZERS)</i>	
Air Filter Primary.....	A-5413	Fuel Filter Secondary.....	FC-54050	Fuel Filter.....	FC-5103
Fuel Filter.....	FC-7933	Fuel/Water Separator.....	SFC-5705	Fuel Filter.....	FC-5403
Fuel/Water Separator.....	SFC-5705	Oil Filter Full Flow.....	C-5402		
				TD-180FB <i>(DOZERS)</i> 6V-53	
				Air Filter Secondary.....	A-5417
				Fuel Filter Secondary.....	FC-54050
				Fuel/Water Separator.....	SFC-5705

MODEL/APPLICATION	SAKURA NO	MODEL/APPLICATION	SAKURA NO	MODEL/APPLICATION	SAKURA NO
KOMATSU		KOMATSU		KOMATSU	
TD8E (DOZERS) D239		Air Filter Primary.....	A-5628	Fuel Filter.....	F-5701
Fuel Filter.....	FC-5403	Air Filter Set.....	A-5628-S	Oil Filter By Pass.....	O-5704
Fuel Filter.....	FC-5103	Fuel Filter.....	FC-5704	Oil Filter Full Flow.....	O-5702
TD8E (DOZERS) DT239		Oil Filter Full Flow.....	C-6202	W170-2 (LOADERS) NT-855	
Fuel Filter.....	FC-5403	VWA4 (COMPACTORS) F4L912		Coolant Filter.....	WC-5707
Fuel Filter.....	FC-5103	Air Filter Primary.....	AS-5628	Fuel Filter.....	FC-5602
TD8G (DOZERS) D240T		Air Filter Set.....	A-5628-S	Oil Filter By Pass.....	O-5704
Fuel/Water Separator.....	SFC-5708	Air Filter Primary.....	A-5628	Oil Filter Full Flow.....	C-5715
Oil Filter Full Flow.....	C-5703	Fuel Filter.....	FC-5704	Oil Filter Full Flow.....	C-5605
TG25G (DOZERS) KT-1150		Oil Filter Full Flow.....	C-6202	Oil Filter Full Flow.....	C-5701
Coolant Filter.....	WC-5705	VWT 2 (COMPACTORS) F2L912		W180-1 (LOADERS) NT-855	
Fuel Filter.....	FC-5702	Air Filter Primary.....	A-5425	Air Filter Secondary.....	A-5610
Oil Filter Full Flow.....	C-5715	Air Filter Primary.....	AS-1014	Air Filter Primary.....	A-5614
Oil Filter By Pass.....	C-5718	Fuel Filter.....	FC-6205	Coolant Filter.....	WC-5707
UD12 (DITCHERS) NT-855		VWT 4 (COMPACTORS) F2L912		Fuel Filter.....	FC-5602
Coolant Filter.....	WC-5711	Air Filter Primary.....	A-5425	Hydraulic Oil Filter.....	H-5609
Fuel Filter.....	FC-5602	Air Filter Primary.....	AS-1014	Hydraulic Oil Filter.....	H-5618
Oil Filter By Pass.....	O-5704	Fuel Filter.....	FC-6205	Oil Filter By Pass.....	O-5704
Oil Filter Full Flow.....	C-5605	VWT 7 (COMPACTORS) F3L912		Oil Filter Full Flow.....	C-5605
Oil Filter Full Flow.....	C-5701	Air Filter Primary.....	A-5425	Oil Filter Full Flow.....	C-5715
Oil Filter Full Flow.....	C-5715	Air Filter Primary.....	AS-1014	Oil Filter Full Flow.....	C-5701
UD12W (DITCHERS) NT-855		Fuel Filter.....	FC-6205	W20-1 (LOADERS) 4D92	
Coolant Filter.....	WC-5711	Oil Filter Full Flow.....	C-6202	Fuel Filter.....	FC-5604
Fuel Filter.....	FC-5602	VWT 7 (COMPACTORS) F4L912		Oil Filter Full Flow.....	C-5606
Oil Filter Full Flow.....	C-5605	Air Filter Primary.....	A-5425	W260-1 (LOADERS) KT-1150	
Oil Filter Full Flow.....	C-5701	Air Filter Primary.....	AS-1014	Coolant Filter.....	WC-5705
Oil Filter Full Flow.....	C-5715	Fuel Filter.....	FC-5704	Fuel Filter.....	FC-5720
Oil Filter By Pass.....	O-5704	Oil Filter Full Flow.....	C-6202	Fuel/Water Separator.....	SFC-5705
V323 (LOADERS)		VWT 9 (COMPACTORS) F3L912		Hydraulic Oil Filter.....	H-5618
Fuel Filter.....	F-2601	Fuel Filter.....	FC-5704	Hydraulic Oil Filter.....	H-5609
Fuel Filter.....	FC-5103	Oil Filter Full Flow.....	C-6202	Oil Filter Full Flow.....	C-5715
Oil Filter Full Flow.....	C-1122	W120-1 (LOADERS) PD6T		Oil Filter By Pass.....	O-5704
V423 (LOADERS)		Hydraulic Oil Filter.....	H-5618	W30-1 (LOADERS) 4D92	
Fuel Filter.....	F-2603	W120-2 (LOADERS) SAGD110		Fuel Filter.....	FC-5604
Oil Filter Full Flow.....	C-1122	Coolant Filter.....	WC-5707	Oil Filter Full Flow.....	C-5606
VWA 16 (COMPACTORS)		Fuel Filter.....	FC-5602	W40-1 (LOADERS) 4D105-3	
Air Filter.....	AS-1010	Hydraulic Oil Filter.....	H-5618	Fuel Filter.....	FC-5604
VWA 8 (COMPACTORS) F6L912		Hydraulic Oil Filter.....	H-5609	Hydraulic Oil Filter.....	H-5618
Air Filter Primary.....	AS-5628	Oil Filter Full Flow.....	C-5614	Oil Filter Full Flow.....	C-5614
Air Filter Primary.....	A-5628	W120-3 (LOADERS) SAGD110		W40-1 (LOADERS) 4D92	
Air Filter Set.....	A-5628-S	Coolant Filter.....	WC-5707	Fuel Filter.....	FC-5604
Fuel Filter.....	FC-5704	Fuel Filter.....	FC-5602	Hydraulic Oil Filter.....	H-5618
Oil Filter Full Flow.....	C-6204	Hydraulic Oil Filter.....	H-5618	Hydraulic Oil Filter.....	H-5618
VWA4 (COMPACTORS) F3L912		Hydraulic Oil Filter.....	H-5609	Oil Filter Full Flow.....	C-5614
Air Filter Primary.....	AS-5628	Oil Filter Full Flow.....	C-5614	W40-2 (LOADERS) 4D105-3	
VWA4 (COMPACTORS) F3L912		W170-1 (LOADERS) V-903		Fuel Filter.....	FC-5604
Air Filter Primary.....	AS-5628	Coolant Filter.....	WC-5713	Hydraulic Oil Filter.....	H-5618
				Oil Filter Full Flow.....	C-5614
				W40-2 (LOADERS) 4D92	

Sakura Filter

ENGINE APPLICATION

MODEL/APPLICATION	SAKURA NO	MODEL/APPLICATION	SAKURA NO	MODEL/APPLICATION	SAKURA NO
KOMATSU		KOMATSU		KOMATSU	
W40-2 (LOADERS) 4D92		W70-2 (LOADERS) 6D105		Oil Filter Full Flow.....	C-5204
Fuel Filter.....	FC-5604	Coolant Filter.....	WC-5707	WA1200-3 (LOADERS) QSK60	
Hydraulic Oil Filter.....	H-5618	Hydraulic Oil Filter.....	H-5618	Air Filter Secondary.....	A-5610
Oil Filter Full Flow.....	C-5614	Hydraulic Oil Filter.....	H-5609	Air Filter Primary.....	A-5614
W60 (LOADERS) 6B155		Oil Filter Full Flow.....	C-5614	Air Filter Secondary.....	A-8580
Coolant Filter.....	WC-5707	W90-1 (LOADERS) CUMMINS V-504		Air Filter Primary.....	A-8665M
Hydraulic Oil Filter.....	H-5609	Fuel Filter.....	FC-5721	Cabin Air Filter.....	CA-56100
Hydraulic Oil Filter.....	H-5618	W90-1 (LOADERS) V-504		Fuel/Water Separator.....	SFC-5601-02
Oil Filter Full Flow.....	C-5614	Coolant Filter.....	WC-5705	Hydraulic Oil Filter.....	H-7911
W60-1 (LOADERS) 6B155		Fuel Filter.....	FC-5702	Hydraulic Oil Filter.....	H-5652
Coolant Filter.....	WC-5707	Fuel/Water Separator Secondary... SFC-1905-10		Hydraulic Oil Filter.....	H-85680
Hydraulic Oil Filter.....	H-5609	Fuel/Water Separator.....	SFC-5709-10	Hydraulic Oil Filter.....	H-2709
Hydraulic Oil Filter.....	H-5618	Fuel/Water Separator.....	SFC-5705	WA120-1 (LOADERS) 410T	
Oil Filter Full Flow.....	C-5614	Oil Filter Full Flow.....	O-5703	Oil Filter Full Flow.....	C-5615
W60-1 (LOADERS) 6D105		Oil Filter By Pass.....	C-5718	Oil Filter Full Flow.....	C-5616
Coolant Filter.....	WC-5707	Oil Filter Full Flow.....	C-5715	WA120-1 (LOADERS) 6D95L-1/10001	
Hydraulic Oil Filter.....	H-5618	Oil Filter Full Flow.....	C-1305	Air Filter Secondary.....	A-7806
Hydraulic Oil Filter.....	H-5609	Oil Filter By Pass.....	O-5704	Air Filter Primary.....	AS-7805
Oil Filter Full Flow.....	C-5614	W90-2 (LOADERS) S6D105-1		Hydraulic Oil Filter.....	H-5618
W70 (LOADERS) 6B155		Air Filter Set.....	A-5660-S	Hydraulic Oil Filter.....	H-5607
Coolant Filter.....	WC-5707	Air Filter Primary.....	A-5413	Oil Filter Full Flow.....	C-5604
Hydraulic Oil Filter.....	H-5618	Coolant Filter.....	WC-5707	WA120-2L (LOADERS) A30001	
Hydraulic Oil Filter.....	H-5609	Hydraulic Oil Filter.....	H-5609	Air Filter Secondary.....	A-6008
Oil Filter Full Flow.....	C-5614	Hydraulic Oil Filter.....	H-5618	Air Filter Primary.....	A-5627
W70 (LOADERS) 6D105		Oil Filter Full Flow.....	C-5614	Air Filter Set.....	A-5663-S
Coolant Filter.....	WC-5707	W90-3 (LOADERS) S6D105-1		Fuel Filter Secondary.....	FC-7903
Hydraulic Oil Filter.....	H-5618	Air Filter Set.....	A-5660-S	Fuel/Water Separator.....	SFC-5706
Hydraulic Oil Filter.....	H-5609	Air Filter Primary.....	A-5413	Fuel/Water Separator.....	SFC-5708
Oil Filter Full Flow.....	C-5614	Coolant Filter.....	WC-5707	Hydraulic Oil Filter.....	H-5607
W70-1 (LOADERS) 6B155		Hydraulic Oil Filter.....	H-5618	Hydraulic Oil Filter.....	H-5618
Coolant Filter.....	WC-5707	Hydraulic Oil Filter.....	H-5609	WA120-3 (LOADERS) 6D95L-1/50001 - 52999	
Hydraulic Oil Filter.....	H-5618	Oil Filter Full Flow.....	C-5614	Air Filter Secondary.....	A-7806
Hydraulic Oil Filter.....	H-5609	WA100-1 (LOADERS) 6D95L-1/10001		Air Filter Primary.....	AS-7805
Oil Filter Full Flow.....	C-5614	Air Filter Secondary.....	A-6009	Fuel Filter.....	FC-1801
W70-1 (LOADERS) 6D105		Air Filter Secondary.....	A-7806	Hydraulic Oil Filter.....	H-5618
Coolant Filter.....	WC-5707	Air Filter Primary.....	AS-7805	Hydraulic Oil Filter.....	H-5607
Hydraulic Oil Filter.....	H-5618	Air Filter Primary.....	AS-1024	Oil Filter Full Flow.....	C-5606
Hydraulic Oil Filter.....	H-5609	Air Filter Set.....	AS-1024-S	WA120-3 (LOADERS) 6D95L-1/ALL	
Oil Filter Full Flow.....	C-5614	Hydraulic Oil Filter.....	H-5607	Air Filter Secondary.....	A-7806
W70-1 (LOADERS) KOMATSU 6D105-1		Hydraulic Oil Filter.....	H-5618	Air Filter Primary.....	AS-7805
Fuel Filter.....	FC-5601	Hydraulic Oil Filter.....	H-5652	Coolant Filter.....	WC-5707
W70-2 (LOADERS) 6B155		Oil Filter Full Flow.....	C-5604	Fuel Filter Secondary.....	FC-7903
Coolant Filter.....	WC-5707	WA100M (LOADERS)		Fuel/Water Separator.....	SFC-5708
Hydraulic Oil Filter.....	H-5618	Air Filter Primary.....	A-5541	Hydraulic Oil Filter.....	H-5607
Hydraulic Oil Filter.....	H-5609	Air Filter Secondary.....	A-5540	Hydraulic Oil Filter.....	H-5618
Oil Filter Full Flow.....	C-5614	Coolant Filter.....	WC-56010	Oil Filter Full Flow.....	C-5703
W70-1 (LOADERS) KOMATSU 6D105-1		Fuel/Water Separator.....	SFC-5601-02	WA120-3 (LOADERS)	
Fuel Filter.....	FC-5601	WA115-3 (LOADERS)		Air Filter Primary.....	A-5627
W70-2 (LOADERS) 6B155		Fuel Filter.....	FC-1016	Air Filter Set.....	A-5663-S
Coolant Filter.....	WC-5707	WA120-3 (LOADERS)		Air Filter Secondary.....	A-6008
Hydraulic Oil Filter.....	H-5618	Air Filter Primary.....	A-5627	Cabin Air Filter.....	CA-56100
Hydraulic Oil Filter.....	H-5609	Air Filter Set.....	A-5663-S		
Oil Filter Full Flow.....	C-5614	Air Filter Secondary.....	A-6008		
		Cabin Air Filter.....	CA-56100		

MODEL/APPLICATION	SAKURA NO	MODEL/APPLICATION	SAKURA NO	MODEL/APPLICATION	SAKURA NO
KOMATSU		KOMATSU		KOMATSU	
WA100M-5 (LOADERS) S4D95		WA200-6 (LOADERS) SAA4D107E		Air Filter Set.....	A-5604-S
Air Filter Primary.....	A-5541	Air Filter Secondary.....	A-8670	Air Filter Primary.....	A-5605
Air Filter Secondary.....	A-5540	Air Filter Set.....	A-5675-S	Air Filter Secondary.....	A-5606
Fuel Filter.....	F-5214	Air Filter Secondary.....	A-5674	Hydraulic Oil Filter.....	H-5652
Oil Filter Full Flow.....	C-56190	Air Filter Primary.....	A-5673	Hydraulic Oil Filter.....	H-5607
Oil Filter Full Flow.....	C-56191	Fuel Filter.....	FC-5613	Oil Filter Full Flow.....	C-5614
WA150-3 (LOADERS) w/S6D102E-1D Eng.		Oil Filter Full Flow.....	C-5611	WA250-1 (LOADERS) S6D105-1/86423	
Cabin Air Filter.....	CA-56100	WA200-6 (LOADERS) SAA4D107E-1		Air Filter Secondary.....	A-5606
WA150-6 (LOADERS) SAA4D95LE-5		Air Filter Breather.....	A-82010	Air Filter Set.....	A-5604-S
Air Filter Secondary.....	A-5674	Fuel Filter.....	F-56040	Air Filter Primary.....	A-5605
WA150PZ-6 (LOADERS) SAA4D95LE-5		WA200L-5 (LOADERS) SAA6D102E-2		Coolant Filter.....	WC-5707
Air Filter Secondary.....	A-5674	Air Filter Primary.....	A-8577	Hydraulic Oil Filter.....	H-5607
WA200-1 (LOADERS) 6D105-1/10001		Air Filter Secondary.....	A-8578	Hydraulic Oil Filter.....	H-5618
Air Filter Set.....	A-5604-S	Cabin Air Filter.....	CA-5602	Oil Filter Full Flow.....	C-5614
Air Filter Primary.....	A-5605	Fuel Filter.....	F-5218	WA250-3 (LOADERS) S6D95L-1/50001	
Air Filter Secondary.....	A-5606	Oil Filter Full Flow.....	C-5611	Air Filter Primary.....	AS-1024
Air Filter Secondary.....	A-6009	WA200PT-5L (LOADERS) KOMATSU SAA6D102E-2		Air Filter Set.....	AS-1024-S
Air Filter Primary.....	AS-1024	Air Filter Primary.....	A-56731	Air Filter Secondary.....	A-6009
Air Filter Set.....	AS-1024-S	Air Filter Set.....	A-56731-S	Fuel Filter.....	FC-1801
Hydraulic Oil Filter.....	H-5618	WA200PT-5L (LOADERS) SAA6D102E-2		Hydraulic Oil Filter.....	H-5618
Hydraulic Oil Filter.....	H-5652	Air Filter Set.....	A-5675-S	Hydraulic Oil Filter.....	H-5607
Hydraulic Oil Filter.....	H-5607	Air Filter Secondary.....	A-5674	Oil Filter Full Flow.....	C-5606
Oil Filter Full Flow.....	C-5614	Air Filter Primary.....	A-5673	WA250-3 (LOADERS) S6D95L-1/13714	
WA200-5 (LOADERS) KOMATSU SAA6D102E-2		Cabin Air Filter.....	CA-5602	Air Filter Primary.....	AS-1024
Hydraulic Oil Filter.....	HC-56060	Fuel Filter.....	F-5218	Air Filter Set.....	AS-1024-S
WA200-5 (LOADERS) SAA6D102E-2		Oil Filter Full Flow.....	C-5611	Fuel Filter.....	FC-1801
Air Filter Secondary.....	A-8578	WA20-1 (LOADERS) 3D78-1		Hydraulic Oil Filter.....	H-5618
Air Filter Primary.....	A-8577	Air Filter Primary.....	AS-2205	Hydraulic Oil Filter.....	H-5607
Cabin Air Filter.....	CA-5602	Fuel Filter.....	F-5210	Oil Filter Full Flow.....	C-5606
Fuel Filter.....	F-5218	Oil Filter Full Flow.....	C-1720	WA250-3L (LOADERS) A87000	
Oil Filter Full Flow.....	C-5611	WA250 (LOADERS) 6B5.9		Air Filter Secondary.....	A-5635
WA200-5L (LOADERS) KOMATSU SAA6D102E-2		Air Filter Primary.....	A-2210	Air Filter Primary.....	A-5639
Air Filter Primary.....	A-56731	Air Filter Primary.....	A-5639	Fuel Filter Secondary.....	FC-7903
Air Filter Set.....	A-56731-S	Air Filter Secondary.....	A-6008	Fuel/Water Separator.....	SFC-5708
WA200-5L (LOADERS) SAA6D102E-2		Fuel Filter Secondary.....	FC-7903	Fuel/Water Separator.....	SFC-5706
Air Filter Secondary.....	A-5674	Fuel/Water Separator.....	SFC-5708	Hydraulic Oil Filter.....	H-5607
Air Filter Primary.....	A-5673	Fuel/Water Separator.....	SFC-5706	WA250-3L (LOADERS) w/S6D102E Eng.	
Air Filter Set.....	A-5675-S	Hydraulic Oil Filter.....	H-5607	Cabin Air Filter.....	CA-56100
Cabin Air Filter.....	CA-5602	Oil Filter Full Flow.....	C-5730	WA250-5H (LOADERS)	
Fuel Filter.....	F-5218	WA250-1 (LOADERS) CUMMINS		Cabin Air Filter.....	CA-5676
Oil Filter Full Flow.....	C-5611	Air Filter Secondary.....	A-6008	Cabin Air Filter.....	CA-5602
WA200-6 (LOADERS) KOMATSU SAA4D107E		Fuel Filter Secondary.....	FC-7903	Fuel Filter.....	F-5218
Air Filter Primary.....	A-56731	Fuel/Water Separator.....	SFC-5706	WA250-6 (LOADERS) SAA6D107E	
Air Filter Set.....	A-56731-S	Fuel/Water Separator.....	SFC-5708	Air Filter Secondary.....	A-5667
Air Filter Secondary.....	A-56741	Hydraulic Oil Filter.....	H-5607	Air Filter Primary.....	A-5666
		Hydraulic Oil Filter.....	H-5618	Fuel Filter.....	FC-5613
		Oil Filter Full Flow.....	C-5730	Oil Filter Full Flow.....	C-5611
		WA250-1 (LOADERS) S6D105-1/10001			

MODEL/APPLICATION	SAKURA NO	MODEL/APPLICATION	SAKURA NO	MODEL/APPLICATION	SAKURA NO
KOMATSU		KOMATSU		KOMATSU	
WA320-2 (LOADERS) CUMMINS , 1996		Fuel/Water Separator.....	SFC-5708	Hydraulic Oil Filter.....	H-5618
Fuel Filter Secondary.....	FC-7903	Hydraulic Oil Filter.....	H-5618	Hydraulic Oil Filter.....	H-5652
Fuel/Water Separator.....	SFC-5708	Hydraulic Oil Filter.....	H-5609	Oil Filter Full Flow.....	C-5614
Fuel/Water Separator.....	SFC-5706	Oil Filter Combination.....	C-57390		
Oil Filter Full Flow.....	C-5730	Oil Filter Combination.....	C-7927	WA380-1 (LOADERS) SA6D110-1/54352/55205	
WA320-3 (LOADERS) S6D108-1/50001 - 52999		WA320-5 (LOADERS) KOMATSU		Air Filter Secondary.....	A-5408
Air Filter Set.....	A-5662-S	Air Filter Secondary.....	A-8578	Air Filter Primary.....	A-6113
Air Filter Secondary.....	A-1307	Air Filter Primary.....	A-8577	Coolant Filter.....	WC-5707
Air Filter Primary.....	A-1313	Cabin Air Filter.....	CA-5602	Fuel Filter.....	FC-5602
Fuel Filter.....	FC-5602	Cabin Air Filter.....	CA-5676	Hydraulic Oil Filter.....	H-5618
Hydraulic Oil Filter.....	H-5609	Oil Filter Full Flow.....	C-5611	Hydraulic Oil Filter.....	H-5652
Hydraulic Oil Filter.....	H-5618			Hydraulic Oil Filter.....	H-5609
Hydraulic Oil Filter.....	H-5652	WA320-6 (LOADERS) KOMATSU SAA6D107E-1		Oil Filter Full Flow.....	C-5614
Oil Filter Full Flow.....	C-5614	Fuel/Water Separator.....	SFC-19100		
WA320-3 (LOADERS) S6D108-1G/53001		WA320-6 (LOADERS) SAA6D107E		WA380-1 (LOADERS) SA6D110-1/56994	
Air Filter Set.....	A-5662-S	Air Filter Primary.....	A-5666	Air Filter Primary.....	A-1313
Air Filter Secondary.....	A-1307	Air Filter Secondary.....	A-5667	Air Filter Secondary.....	A-1307
Air Filter Primary.....	A-1313	Fuel Filter.....	FC-5613	Air Filter Set.....	A-5662-S
Fuel Filter.....	FC-5602	Oil Filter Full Flow.....	C-5611	Coolant Filter.....	WC-5707
Hydraulic Oil Filter.....	H-5609			Fuel Filter.....	FC-5602
Hydraulic Oil Filter.....	H-5618	WA350-1 (LOADERS) S6D110-1/10001		Hydraulic Oil Filter.....	H-5618
Hydraulic Oil Filter.....	H-5652	Air Filter Set.....	A-5604-S	Hydraulic Oil Filter.....	H-5609
Oil Filter Full Flow.....	C-5614	Air Filter Primary.....	A-5605	Hydraulic Oil Filter.....	H-5652
		Air Filter Secondary.....	A-5606	Oil Filter Full Flow.....	C-5614
WA320-3 (LOADERS) S6D114E		Coolant Filter.....	WC-5707		
Air Filter Secondary.....	A-1307	Fuel Filter.....	FC-5621	WA380-1 (LOADERS) w/Cummins 8.3L Eng.	
Air Filter Primary.....	A-1313	Hydraulic Oil Filter.....	H-5609	Cabin Air Filter.....	CA-56100
Air Filter Set.....	A-5662-S	Hydraulic Oil Filter.....	H-5618		
Coolant Filter.....	WC-5705	Oil Filter Full Flow.....	C-5614	WA380-1LC (LOADERS) 614T	
Fuel/Water Separator.....	SFC-5706			Air Filter Set.....	A-1841-S
Hydraulic Oil Filter.....	H-5618	WA350-1 (LOADERS) S/N: 10001		Air Filter Primary.....	A-10134
Hydraulic Oil Filter.....	H-5609	Air Filter Set.....	A-5604-S	Air Filter Primary.....	A-1013
Oil Filter Combination.....	C-7927	Air Filter Secondary.....	A-5606	Air Filter Secondary.....	A-5631
Oil Filter Combination.....	C-57390	Air Filter Primary.....	A-5605	Cabin Air Filter.....	CA-56100
		Hydraulic Oil Filter.....	H-5618	Fuel Filter Secondary.....	FC-7903
WA320-3 (LOADERS) SA6D102E		Hydraulic Oil Filter.....	H-5609	Fuel/Water Separator.....	SFC-5706
Hydraulic Oil Filter.....	H-56700	Oil Filter Full Flow.....	C-5614	Fuel/Water Separator.....	SFC-5708
				Hydraulic Oil Filter.....	H-5609
WA320-3CS (LOADERS) SA6D102E-1B/50001		WA380-1 (LOADERS) SA6D110-1/10001		Hydraulic Oil Filter.....	H-5618
Air Filter Secondary.....	A-5635	Air Filter Secondary.....	A-1307	Hydraulic Oil Filter.....	H-5609
Air Filter Primary.....	A-5639	Air Filter Secondary.....	A-5408	Oil Filter Combination.....	C-57390
Fuel Filter Secondary.....	FC-7903	Air Filter Set.....	A-5662-S	Oil Filter Combination.....	C-7927
Fuel/Water Separator.....	SFC-5708	Air Filter Primary.....	A-1313		
Hydraulic Oil Filter.....	H-5618	Air Filter Primary.....	A-6113	WA380-1LC (LOADERS)	
Hydraulic Oil Filter.....	H-5652	Fuel Filter.....	FC-5621	Cabin Air Filter.....	CA-56100
Hydraulic Oil Filter.....	H-5609	Hydraulic Oil Filter.....	H-5618	Coolant Filter.....	WC-5706
Oil Filter Full Flow.....	C-5730	Hydraulic Oil Filter.....	H-5609	Fuel Filter Secondary.....	FC-7903
		Hydraulic Oil Filter.....	H-5652	Fuel/Water Separator.....	SFC-5706
WA320-3LE (LOADERS) S6D114E-1/A30001		Oil Filter Full Flow.....	C-5614	Fuel/Water Separator.....	SFC-5708
Air Filter Set.....	A-5662-S			Hydraulic Oil Filter.....	H-5618
Air Filter Secondary.....	A-1307	WA380-1 (LOADERS) SA6D110-1/55205/56993		Hydraulic Oil Filter.....	H-5609
Air Filter Primary.....	A-1313	Air Filter Primary.....	A-6113	Hydraulic Oil Filter.....	H-5652
Coolant Filter.....	WC-5705	Air Filter Secondary.....	A-5408	Hydraulic Oil Filter.....	H-56770
Fuel Filter Secondary.....	FC-7903	Coolant Filter.....	WC-5707	Oil Filter Full Flow.....	C-1305
Fuel/Water Separator.....	SFC-5706	Fuel Filter.....	FC-5602		
Hydraulic Oil Filter.....	H-5618	Hydraulic Oil Filter.....	H-5609	WA380-3 (LOADERS) S6D108-1/20188	
Hydraulic Oil Filter.....	H-5609	Hydraulic Oil Filter.....	H-5652	Air Filter Secondary.....	A-1307
Oil Filter Full Flow.....	C-5730	Oil Filter Full Flow.....	C-5614	Air Filter Primary.....	A-1313
				Air Filter Set.....	A-5662-S
WA320-3LE (LOADERS) S6D114E-1/A30001				Fuel Filter.....	FC-5602
Air Filter Set.....	A-5662-S				
Air Filter Secondary.....	A-1307				
Air Filter Primary.....	A-1313				
Coolant Filter.....	WC-5705				
Fuel Filter Secondary.....	FC-7903				
Fuel/Water Separator.....	SFC-5706				

MODEL/APPLICATION	SAKURA NO	MODEL/APPLICATION	SAKURA NO	MODEL/APPLICATION	SAKURA NO
KOMATSU		KOMATSU		KOMATSU	
WA380-3 (LOADERS) S6D108-1/20188		Air Filter Set.....	A-1841-S	WA380-7 (LOADERS) SAA6D107E-2 , 2011	
Hydraulic Oil Filter.....	H-5609	Coolant Filter.....	WC-5705	Oil Filter Full Flow.....	C-5611
Hydraulic Oil Filter.....	H-5618	Fuel Filter Secondary.....	FC-7903	WA320PZ-6 (LOADERS) SAA6D107E-1	
Hydraulic Oil Filter.....	H-5652	Fuel/Water Separator.....	SFC-5708	Air Filter Secondary.....	A-5667
Oil Filter Full Flow.....	C-5614	Hydraulic Oil Filter.....	H-5609	Air Filter Primary.....	A-5666
		Hydraulic Oil Filter.....	H-5618	WA300-3 (LOADERS) w/SA6D102E Eng.	
WA380-3 (LOADERS) S6D108-1/50001 - 52999		Oil Filter Combination.....	C-7927	Cabin Air Filter.....	CA-56100
Air Filter Secondary.....	A-1307	Oil Filter Combination.....	C-57390	WA350-3 (LOADERS) S6D108	
Air Filter Primary.....	A-1313	WA380-3MC (LOADERS) A51001		Fuel Filter.....	FC-5606
Air Filter Set.....	A-5662-S	Air Filter Primary.....	A-1013	WA350-3 (LOADERS) w/S6D108 Eng.	
Fuel Filter.....	FC-5602	Air Filter Secondary.....	A-5631	Cabin Air Filter.....	CA-56100
Hydraulic Oil Filter.....	H-5652	Air Filter Primary.....	A-10134	WA400-1 (LOADERS) SAA6D110	
Hydraulic Oil Filter.....	H-5618	Air Filter Set.....	A-1841-S	Fuel Filter.....	FC-5606
Hydraulic Oil Filter.....	H-5609	Cabin Air Filter.....	CA-56100	WA400-5 (LOADERS) SAA6D114E	
Oil Filter Full Flow.....	C-5614	Cabin Air Filter Set.....	CA-5601-S	Fuel Filter.....	FC-5610
		Cabin Air Filter Set.....	CA-5603-S	WA400-5 (LOADERS) SAA6D114E	
WA380-3 (LOADERS) S6D108-1/53001		Fuel Filter Secondary.....	FC-7903	Air Filter Primary.....	A-5558M
Air Filter Set.....	A-5662-S	Fuel/Water Separator.....	SFC-5706	Air Filter Secondary.....	A-5559
Air Filter Secondary.....	A-1307	Fuel/Water Separator.....	SFC-5708	Air Filter Set.....	A-5558M-S
Air Filter Primary.....	A-1313	Hydraulic Oil Filter.....	H-5618	Cabin Air Filter.....	CA-5602
Fuel Filter.....	FC-5602	Hydraulic Oil Filter.....	H-56770	Hydraulic Oil Filter.....	H-85680
Hydraulic Oil Filter.....	H-5652	Hydraulic Oil Filter.....	H-5609	Hydraulic Oil Filter.....	H-7911
Hydraulic Oil Filter.....	H-5609	Oil Filter Combination.....	C-7927	Oil Filter Combination.....	C-5707
Hydraulic Oil Filter.....	H-5618	Oil Filter Combination.....	C-57390	WA400-5L (LOADERS) KOMATSU SAA6D114E	
Oil Filter Full Flow.....	C-5614	WA380-5 (LOADERS) 2003		Fuel Filter.....	FC-5610
		Air Filter Primary.....	A-5558M	WA400-5L (LOADERS) KOMATSU SAA6D114E	
WA380-3 (LOADERS) S6D108-1		Air Filter Secondary.....	A-5559	Air Filter Primary.....	A-5558M
Fuel Filter.....	FC-5606	Air Filter Set.....	A-5558M-S	Air Filter Secondary.....	A-5559
		Cabin Air Filter.....	CA-5676	Air Filter Set.....	A-5558M-S
WA380-3H (LOADERS)		Hydraulic Oil Filter.....	H-7911	Cabin Air Filter.....	CA-5602
Air Filter Primary.....	A-5558M	Hydraulic Oil Filter.....	H-85680	Hydraulic Oil Filter.....	H-85680
Air Filter Secondary.....	A-5559	Oil Filter Combination.....	C-5707	Hydraulic Oil Filter.....	H-7911
Air Filter Set.....	A-5558M-S	WA380-6 (LOADERS) 2006		Oil Filter Combination.....	C-5707
Fuel Filter Secondary.....	FC-7903	Air Filter Primary.....	A-5558M	WA400-5L (LOADERS) KOMATSU SAA6D114E	
Fuel/Water Separator.....	SFC-5706	Air Filter Secondary.....	A-5559	Fuel Filter.....	FC-5610
Fuel/Water Separator.....	SFC-5708	Air Filter Set.....	A-5558M-S	WA400-5L (LOADERS) SAA6D114E	
Hydraulic Oil Filter.....	H-5618	Hydraulic Oil Filter.....	H-56650	Air Filter Primary.....	A-5558M
Oil Filter Combination.....	C-57390	Oil Filter Full Flow.....	C-5611	Air Filter Secondary.....	A-5559
Oil Filter Combination.....	C-7927	WA380-6 (LOADERS) CUMMINS QSB6.7		Air Filter Set.....	A-5558M-S
		Fuel Filter.....	FC-5613	Cabin Air Filter.....	CA-5602
WA380-3LCE (LOADERS) A50001		WA380-6 (LOADERS) KOMATSU SAA6D107E-1		Hydraulic Oil Filter.....	H-85680
Air Filter Primary.....	A-1013	Hydraulic Oil Filter.....	H-56652	Hydraulic Oil Filter.....	H-7911
Air Filter Secondary.....	A-5631	WA380-6 (LOADERS) SAA6D107E		Oil Filter Combination.....	C-5707
Air Filter Primary.....	A-10134	Fuel Filter.....	FC-5613	WA400-5L (LOADERS) KOMATSU SAA6D114E	
Air Filter Set.....	A-1841-S	WA380H (LOADERS)		Fuel Filter.....	FC-5610
Coolant Filter.....	WC-5705	Fuel Filter Secondary.....	FC-7903	WA400-5L (LOADERS) SAA6D114E	
Fuel Filter Secondary.....	FC-7903	Fuel/Water Separator.....	SFC-5708	Air Filter Primary.....	A-5558M
Fuel/Water Separator.....	SFC-5708	Fuel/Water Separator.....	SFC-5706	Air Filter Secondary.....	A-5559
Hydraulic Oil Filter.....	H-56770	Hydraulic Oil Filter.....	H-5618	Air Filter Set.....	A-5558M-S
Hydraulic Oil Filter.....	H-5609	Oil Filter Combination.....	C-57390	Cabin Air Filter.....	CA-5602
Oil Filter Combination.....	C-57390	Oil Filter Combination.....	C-7927	Hydraulic Oil Filter.....	H-85680
Oil Filter Combination.....	C-7927	WA380-3LE (LOADERS) S6D114E-1/A50001		Hydraulic Oil Filter.....	H-7911
		Air Filter Primary.....	A-10134	Oil Filter Combination.....	C-5707
		Air Filter Primary.....	A-1013	WA400-5WH (LOADERS) KOMATSU SAA6D114E	
		Air Filter Secondary.....	A-5631	Fuel Filter.....	FC-5610

Sakura Filter

ENGINE APPLICATION

MODEL/APPLICATION	SAKURA NO	MODEL/APPLICATION	SAKURA NO	MODEL/APPLICATION	SAKURA NO
KOMATSU		KOMATSU		KOMATSU	
WA400-5WH (LOADERS) SAA6D114E		WA420-1LC (LOADERS)		Hydraulic Oil Filter.....	H-5609
Air Filter Primary.....	A-5558M	Air Filter Set.....	A-1841-S	Hydraulic Oil Filter.....	H-5652
Air Filter Secondary.....	A-5559	Air Filter Primary.....	A-10134	Hydraulic Oil Filter.....	H-5618
Air Filter Set.....	A-5558M-S	Air Filter Primary.....	A-1013	Oil Filter Full Flow.....	C-5614
Cabin Air Filter.....	CA-5602	Air Filter Secondary.....	A-5631		
Hydraulic Oil Filter.....	H-85680	Fuel Filter Secondary.....	FC-7903	WA420-3 (LOADERS) SAA6D114E-1/19467	
Hydraulic Oil Filter.....	H-7911	Fuel/Water Separator.....	SFC-5706	Air Filter Set.....	A-5662-S
Oil Filter Combination.....	C-5707	Fuel/Water Separator.....	SFC-5708	Air Filter Secondary.....	A-1307
		Hydraulic Oil Filter.....	H-56770	Air Filter Primary.....	A-1313
		Hydraulic Oil Filter.....	H-5652	Fuel Filter.....	FC-5602
		Hydraulic Oil Filter.....	H-5618	Hydraulic Oil Filter.....	H-5618
		Hydraulic Oil Filter.....	H-5609	Hydraulic Oil Filter.....	H-5652
		Oil Filter Combination.....	C-57390	Hydraulic Oil Filter.....	H-5609
		Oil Filter Combination.....	C-7927	Oil Filter Full Flow.....	C-5614
WA40-1 (LOADERS) 1001					
Air Filter Primary.....	AS-1014	WA420-3 (LOADERS) A31001		Air Filter Primary.....	A-10134
Hydraulic Oil Filter.....	HC-5602	Air Filter Primary.....	A-10134	Air Filter Primary.....	A-1013
Oil Filter Full Flow.....	C-5604	Air Filter Primary.....	A-1013	Air Filter Set.....	A-1841-S
		Air Filter Set.....	A-1841-S	Air Filter Secondary.....	A-5631
		Air Filter Secondary.....	A-5631	Coolant Filter.....	WC-5705
		Cabin Air Filter.....	CA-56100	Hydraulic Oil Filter.....	H-5618
		Cabin Air Filter Set.....	CA-5601-S	Hydraulic Oil Filter.....	H-5609
		Cabin Air Filter Set.....	CA-5603-S	Oil Filter Combination.....	C-7927
		Fuel Filter Secondary.....	FC-7903	Oil Filter Combination.....	C-57390
		Fuel/Water Separator.....	SFC-5706		
		Fuel/Water Separator.....	SFC-5708	WA420-3CS (LOADERS) WA6D114-1AA/R50001	
		Hydraulic Oil Filter.....	H-5618	Coolant Filter.....	WC-5703
		Hydraulic Oil Filter.....	H-5609	Fuel Filter Secondary.....	FC-7903
		Oil Filter Combination.....	C-7927	Fuel/Water Separator.....	SFC-5708
		Oil Filter Combination.....	C-57390	Hydraulic Oil Filter.....	H-5609
				Hydraulic Oil Filter.....	H-5618
				Hydraulic Oil Filter.....	H-5652
				Oil Filter Combination.....	C-5723
				Oil Filter Combination.....	C-5707
WA420-1 (LOADERS) 614T		WA420-3 (LOADERS) SAG6D108			
Air Filter Primary.....	A-1013	Air Filter Set.....	A-5662-S	WA420-3H (LOADERS)	
Air Filter Secondary.....	A-5631	Air Filter Secondary.....	A-1307	Air Filter Primary.....	A-10134
Air Filter Primary.....	A-10134	Air Filter Primary.....	A-1313	Air Filter Primary.....	A-5558M
Air Filter Set.....	A-1841-S	Fuel Filter.....	FC-5606	Air Filter Secondary.....	A-5559
Cabin Air Filter.....	CA-56100	Fuel Filter.....	FC-5602	Air Filter Primary.....	A-1013
Coolant Filter.....	WC-5705	Hydraulic Oil Filter.....	H-5652	Air Filter Secondary.....	A-5631
Fuel Filter.....	FC-7903	Hydraulic Oil Filter.....	H-5618	Air Filter Set.....	A-5558M-S
Fuel/Water Separator.....	SFC-5706	Hydraulic Oil Filter.....	H-5609	Air Filter Set.....	A-1841-S
Fuel/Water Separator.....	SFC-5708	Hydraulic Oil Filter.....	H-5609	Fuel Filter Secondary.....	FC-7903
Hydraulic Oil Filter.....	H-5618	Oil Filter Full Flow.....	C-5614	Fuel/Water Separator.....	SFC-5708
Hydraulic Oil Filter.....	H-5609			Fuel/Water Separator.....	SFC-5706
Oil Filter Combination.....	C-7927			Hydraulic Oil Filter.....	H-5618
Oil Filter Combination.....	C-57390			Oil Filter Combination.....	C-57390
				Oil Filter Combination.....	C-7927
WA420-1 (LOADERS) SAG6D110-1/54110/56996		WA420-3 (LOADERS) SAG6D108-1/50001/52999			
Air Filter Secondary.....	A-5408	Air Filter Secondary.....	A-1307	WA420-3LE (LOADERS) A30001	
Air Filter Primary.....	A-6113	Air Filter Set.....	A-5662-S	Air Filter Set.....	A-1841-S
Coolant Filter.....	WC-5707	Air Filter Primary.....	A-1313	Air Filter Primary.....	A-10134
Fuel Filter.....	FC-5602	Fuel Filter.....	FC-5602	Air Filter Primary.....	A-1013
Hydraulic Oil Filter.....	H-5618	Hydraulic Oil Filter.....	H-5618	Air Filter Secondary.....	A-5631
Hydraulic Oil Filter.....	H-5652	Hydraulic Oil Filter.....	H-5652	Air Filter Secondary.....	A-5631
Hydraulic Oil Filter.....	H-5609	Hydraulic Oil Filter.....	H-5609	Air Filter Set.....	A-5558M-S
Oil Filter Full Flow.....	C-5614	Oil Filter Full Flow.....	C-5614	Air Filter Set.....	A-1841-S
				Fuel Filter Secondary.....	FC-7903
				Fuel/Water Separator.....	SFC-5708
				Fuel/Water Separator.....	SFC-5706
				Hydraulic Oil Filter.....	H-5618
				Oil Filter Combination.....	C-57390
				Oil Filter Combination.....	C-7927
WA420-1 (LOADERS) SAG6D110		WA420-3 (LOADERS) SAG6D108-1/53001			
Fuel Filter.....	FC-5606	Air Filter Set.....	A-5662-S	Air Filter Set.....	A-1841-S
		Air Filter Secondary.....	A-1307	Air Filter Primary.....	A-10134
		Air Filter Primary.....	A-1313	Air Filter Primary.....	A-1013
		Fuel Filter.....	FC-5602	Air Filter Secondary.....	A-5631
		Hydraulic Oil Filter.....	H-5618	Fuel Filter Secondary.....	FC-7903
		Hydraulic Oil Filter.....	H-5652	Fuel/Water Separator.....	SFC-5708
		Hydraulic Oil Filter.....	H-5609	Fuel/Water Separator.....	SFC-5706
		Oil Filter Full Flow.....	C-5614	Hydraulic Oil Filter.....	H-5618
				Oil Filter Combination.....	C-57390
				Oil Filter Combination.....	C-7927
WA420-1 (LOADERS) w/Cummins Eng					
Cabin Air Filter.....	CA-56100				

MODEL/APPLICATION	SAKURA NO	MODEL/APPLICATION	SAKURA NO	MODEL/APPLICATION	SAKURA NO
KOMATSU		KOMATSU		KOMATSU	
WA420-3LE (LOADERS) A30001		Hydraulic Oil Filter.....	H-5652	Air Filter Secondary.....	A-5559
Hydraulic Oil Filter.....	H-5609	Oil Filter Full Flow.....	C-5715	Air Filter Set.....	A-5558M-S
Oil Filter Combination.....	C-7927	Oil Filter Full Flow.....	C-5605	Fuel/Water Separator Secondary..	SFC-5611-10B
Oil Filter Combination.....	C-57390	Oil Filter Full Flow.....	C-5701	Fuel/Water Separator Secondary...	SFC-5611-10
WA450-1 (LOADERS) S6D125-1		WA450-3 (LOADERS) MTA11		WA450L-3 (LOADERS) SAGD125E	
Fuel Filter.....	FC-5606	Coolant Filter.....	WC-5713	Fuel Filter.....	FC-5606
WA450-1 (LOADERS) S6D125-1/10001		Fuel/Water Separator.....	SFC-5705	Fuel Filter.....	FC-5602
Fuel Filter.....	FC-5606	Fuel/Water Separator.....	SFC-5709-10	Hydraulic Oil Filter.....	H-5609
WA450-1 (LOADERS) S6D125-1/10001		Hydraulic Oil Filter.....	H-5618	Hydraulic Oil Filter.....	H-5618
Air Filter Set.....	A-1841-S	Hydraulic Oil Filter.....	H-5609	Oil Filter Full Flow.....	C-5701
Air Filter Primary.....	A-1013	Oil Filter Combination.....	C-5723	Oil Filter Full Flow.....	C-5715
Air Filter Secondary.....	A-5631	Oil Filter Combination.....	C-5707	Oil Filter Full Flow.....	C-5605
Air Filter Primary.....	A-10134	WA450-3LE (LOADERS) A30001		WA470-1 (LOADERS) S6D125-1	
Fuel Filter.....	FC-5602	Coolant Filter.....	WC-5713	Fuel Filter.....	FC-5606
Hydraulic Oil Filter.....	H-5618	Fuel/Water Separator.....	SFC-5709-10	WA470-1 (LOADERS) S6D125-1KK/20001	
Hydraulic Oil Filter.....	H-5609	Fuel/Water Separator.....	SFC-5705	Air Filter Secondary.....	A-5631
Hydraulic Oil Filter.....	H-5652	Hydraulic Oil Filter.....	H-5618	Air Filter Set.....	A-1841-S
Oil Filter Full Flow.....	C-5715	Hydraulic Oil Filter.....	H-5609	Air Filter Primary.....	A-1013
Oil Filter Full Flow.....	C-5701	Oil Filter Combination.....	C-5723	Air Filter Primary.....	A-6113
Oil Filter Full Flow.....	C-5605	Oil Filter Combination.....	C-5707	Air Filter Secondary.....	A-5408
WA450-1 (LOADERS) S6D125-1/11574		WA450-3LL (LOADERS) S6D125-1		Air Filter Primary.....	A-10134
Air Filter Secondary.....	A-5408	Fuel Filter.....	FC-5606	Fuel Filter.....	FC-5602
Air Filter Primary.....	A-6113	WA450-3LL (LOADERS) S6D125-1/50305		Hydraulic Oil Filter.....	H-5618
Fuel Filter.....	FC-5602	Air Filter Set.....	A-1841-S	Hydraulic Oil Filter.....	H-5609
Hydraulic Oil Filter.....	H-5652	Air Filter Secondary.....	A-5631	Hydraulic Oil Filter.....	H-5652
Hydraulic Oil Filter.....	H-5618	Air Filter Primary.....	A-10134	Oil Filter Full Flow.....	C-5715
Hydraulic Oil Filter.....	H-5609	Air Filter Primary.....	A-1013	Oil Filter Full Flow.....	C-5701
Oil Filter Full Flow.....	C-5701	Fuel Filter.....	FC-5602	Oil Filter Full Flow.....	C-5605
Oil Filter Full Flow.....	C-5715	Hydraulic Oil Filter.....	H-5618	WA470-1 (LOADERS) S6D125-1KK/10001/19999	
Oil Filter Full Flow.....	C-5605	Hydraulic Oil Filter.....	H-5652	Air Filter Primary.....	A-6113
WA450-2 (LOADERS) CUMMINS LTA10 A25001		Hydraulic Oil Filter.....	H-5609	Air Filter Primary.....	A-1013
Hydraulic Oil Filter.....	H-56770	Oil Filter Full Flow.....	C-5701	Air Filter Secondary.....	A-5631
WA450-2 (LOADERS) LTA10/A25001		Oil Filter Full Flow.....	C-5605	Air Filter Secondary.....	A-5408
Air Filter Primary.....	A-10134	Oil Filter Full Flow.....	C-5715	Air Filter Set.....	A-1841-S
Air Filter Primary.....	A-1013	WA450-3LL (LOADERS) S6D125-1/53001		Air Filter Primary.....	A-10134
Air Filter Set.....	A-1841-S	Air Filter Set.....	A-1841-S	Fuel Filter.....	FC-5602
Coolant Filter.....	WC-5705	Air Filter Primary.....	A-10134	Hydraulic Oil Filter.....	H-5652
Fuel Filter.....	FC-5720	Air Filter Primary.....	A-1013	Hydraulic Oil Filter.....	H-5609
Fuel/Water Separator.....	SFC-5705	Air Filter Secondary.....	A-5631	Hydraulic Oil Filter.....	H-5618
Hydraulic Oil Filter.....	H-5618	Fuel Filter.....	FC-5602	Oil Filter Full Flow.....	C-5715
Hydraulic Oil Filter.....	H-5609	Hydraulic Oil Filter.....	H-5609	Oil Filter Full Flow.....	C-5701
Oil Filter Combination.....	C-5723	Hydraulic Oil Filter.....	H-5652	Oil Filter Full Flow.....	C-5605
Oil Filter Combination.....	C-5707	Hydraulic Oil Filter.....	H-5618	WA470-1 (LOADERS) S6D125-1Z/10001/19999	
WA450-2 (LOADERS) w/Cummins Eng		Oil Filter Full Flow.....	C-5605	Air Filter Primary.....	A-10134
Cabin Air Filter.....	CA-56100	Oil Filter Full Flow.....	C-5701	Air Filter Set.....	A-1841-S
WA450-3 (LOADERS) LTA10		Oil Filter Full Flow.....	C-5715	Air Filter Primary.....	A-1013
Air Filter Secondary.....	A-5610	WA450-6 (LOADERS) KOMATSU SAA6D125E-5D		Air Filter Primary.....	A-6113
Air Filter Primary.....	A-5614	Fuel/Water Separator.....	SFC-56020	Air Filter Secondary.....	A-5631
Fuel Filter.....	FC-5602	Fuel/Water Separator.....	SFC-56020B	Air Filter Secondary.....	A-5408
Hydraulic Oil Filter.....	H-5609	WA450-6 (LOADERS) SAA6D125E-5		Fuel Filter.....	FC-5602
Hydraulic Oil Filter.....	H-5618	Air Filter Primary.....	A-5558M	Hydraulic Oil Filter.....	H-5618
WA450-2 (LOADERS) w/Cummins Eng		WA450-6 (LOADERS) SAA6D125E-5		Hydraulic Oil Filter.....	H-5609
Cabin Air Filter.....	CA-56100	Air Filter Primary.....	A-5558M	Hydraulic Oil Filter.....	H-5652
WA450-3 (LOADERS) LTA10		WA450-6 (LOADERS) SAA6D125E-5		Oil Filter Full Flow.....	C-5715
Air Filter Secondary.....	A-5610	Air Filter Primary.....	A-5558M		
Air Filter Primary.....	A-5614				
Fuel Filter.....	FC-5602				
Hydraulic Oil Filter.....	H-5609				
Hydraulic Oil Filter.....	H-5618				

MODEL/APPLICATION	SAKURA NO	MODEL/APPLICATION	SAKURA NO	MODEL/APPLICATION	SAKURA NO
KOMATSU		KOMATSU		KOMATSU	
WA470-1 (LOADERS) S6D125-1Z/10001/19999 Oil Filter Full Flow..... C-5701 Oil Filter Full Flow..... C-5605		WA470-3H (LOADERS) M11 Air Filter Set..... A-5558M-S Air Filter Primary..... A-5558M Air Filter Secondary..... A-5559 Coolant Filter..... WC-5705 Fuel/Water Separator..... SFC-5705 Fuel/Water Separator..... SFC-5709-10 Hydraulic Oil Filter..... H-5618 Hydraulic Oil Filter..... H-5652 Oil Filter Combination..... C-5723 Oil Filter Combination..... C-5707		Cabin Air Filter..... CA-5602 Fuel/Water Separator..... SFC-5601-02 WA450-5 (LOADERS) SAA6D125E-3 Air Filter Primary..... A-5558M Air Filter Secondary..... A-5559 Air Filter Set..... A-5558M-S Cabin Air Filter..... CA-5676 Cabin Air Filter..... CA-5602 Fuel/Water Separator..... SFC-5601-02 Hydraulic Oil Filter..... H-2709	
WA470-1 (LOADERS) S6D125-1Z/20001 Air Filter Primary..... A-10134 Air Filter Primary..... A-1013 Air Filter Set..... A-1841-S Air Filter Primary..... A-6113 Air Filter Secondary..... A-5631 Air Filter Secondary..... A-5408 Fuel Filter..... FC-5602 Hydraulic Oil Filter..... H-5618 Hydraulic Oil Filter..... H-5652 Hydraulic Oil Filter..... H-5609 Oil Filter Full Flow..... C-5715 Oil Filter Full Flow..... C-5605 Oil Filter Full Flow..... C-5701		WA470-3H (LOADERS) Air Filter Secondary..... A-5631 Fuel Filter..... FC-5602 Hydraulic Oil Filter..... H-5609 Hydraulic Oil Filter..... H-5618 Oil Filter Full Flow..... C-5715 Oil Filter Full Flow..... C-5701 Oil Filter Full Flow..... C-5605		WA470-6 (LOADERS) SAA6D125E-5 , 2008 Air Filter Primary..... A-5558M Air Filter Secondary..... A-5559 Air Filter Set..... A-5558M-S Cabin Air Filter..... CA-5676 Fuel/Water Separator Secondary... SFC-5611-10 Fuel/Water Separator Secondary.. SFC-5611-10B Hydraulic Oil Filter..... H-5646 Hydraulic Oil Filter..... H-5629	
WA470-3 (LOADERS) S6D125-1 Air Filter Set..... A-1841-S Air Filter Primary..... A-1013 Air Filter Secondary..... A-5631 Air Filter Primary..... A-10134 Fuel Filter..... FC-5606 Fuel Filter..... FC-5602 Hydraulic Oil Filter..... H-5618 Hydraulic Oil Filter..... H-5652 Hydraulic Oil Filter..... H-5609 Oil Filter Full Flow..... C-5701 Oil Filter Full Flow..... C-5605 Oil Filter Full Flow..... C-5715		WA470-5 (LOADERS) SAA6D125E-3 , 2001 Air Filter Primary..... A-5558M Air Filter Secondary..... A-5559 Air Filter Set..... A-5558M-S Fuel/Water Separator..... SFC-5601-02 Hydraulic Oil Filter..... H-2709		WA470-6 (LOADERS) KOMATSU SAA6D125E-5 Fuel/Water Separator..... SFC-56020B Fuel/Water Separator..... SFC-56020	
WA470-3 (LOADERS) S6D125-1AM/50001 - 52999 Air Filter Primary..... A-10134 Air Filter Secondary..... A-5631 Air Filter Primary..... A-1013 Air Filter Set..... A-1841-S Fuel Filter..... FC-5602 Hydraulic Oil Filter..... H-5618 Hydraulic Oil Filter..... H-5652 Hydraulic Oil Filter..... H-5609 Oil Filter Full Flow..... C-5701 Oil Filter Full Flow..... C-5605 Oil Filter Full Flow..... C-5715		WA470-5H (LOADERS) Air Filter Primary..... A-5558M Air Filter Secondary..... A-5559 Air Filter Set..... A-5558M-S Cabin Air Filter..... CA-5676 Cabin Air Filter..... CA-5602 Hydraulic Oil Filter..... H-2709		WA470-6 (LOADERS) KOMATSU SAA6D125E-5D Fuel/Water Separator..... SFC-56020B Fuel/Water Separator..... SFC-56020	
WA470-3 (LOADERS) S6D125-1AM/53001 Air Filter Set..... A-1841-S Air Filter Primary..... A-1013 Air Filter Secondary..... A-5631 Air Filter Primary..... A-10134 Fuel Filter..... FC-5602 Hydraulic Oil Filter..... H-5618 Hydraulic Oil Filter..... H-5652 Hydraulic Oil Filter..... H-5609 Oil Filter Full Flow..... C-5605 Oil Filter Full Flow..... C-5701 Oil Filter Full Flow..... C-5715		WA480-5 (LOADERS) KOMATSU SAA6D125E-3 Fuel Filter..... FC-5622 Hydraulic Oil Filter..... H-56770		WA470-6 (LOADERS) KOMATSU SAA6D125E-5D-01 Oil Filter Transmission..... TC-56010	
WA470-3 (LOADERS) S6D125-1AM/50001 - 52999 Air Filter Primary..... A-10134 Air Filter Secondary..... A-5631 Air Filter Primary..... A-1013 Air Filter Set..... A-1841-S Fuel Filter..... FC-5602 Hydraulic Oil Filter..... H-5618 Hydraulic Oil Filter..... H-5652 Hydraulic Oil Filter..... H-5609 Oil Filter Full Flow..... C-5701 Oil Filter Full Flow..... C-5605 Oil Filter Full Flow..... C-5715		WA480-5 (LOADERS) KOMATSU SAA6D125E-3 Air Filter Primary..... A-5558M Air Filter Secondary..... A-5559 Air Filter Set..... A-5558M-S Cabin Air Filter..... CA-5676 Cabin Air Filter..... CA-5602 Fuel/Water Separator..... SFC-5601-02		WA430-6 (LOADERS) SAA6D114E-3 , 2007 Air Filter Primary..... A-5558M Air Filter Secondary..... A-5559 Air Filter Set..... A-5558M-S Cabin Air Filter..... CA-5676 Hydraulic Oil Filter..... H-56650 Oil Filter Combination..... C-5707	
WA470-3 (LOADERS) S6D125-1AM/53001 Air Filter Set..... A-1841-S Air Filter Primary..... A-1013 Air Filter Secondary..... A-5631 Air Filter Primary..... A-10134 Fuel Filter..... FC-5602 Hydraulic Oil Filter..... H-5618 Hydraulic Oil Filter..... H-5652 Hydraulic Oil Filter..... H-5609 Oil Filter Full Flow..... C-5605 Oil Filter Full Flow..... C-5701 Oil Filter Full Flow..... C-5715		WA480-5 (LOADERS) KOMATSU SAA6D125E-3 Air Filter Primary..... A-5558M Air Filter Secondary..... A-5559 Air Filter Set..... A-5558M-S Cabin Air Filter..... CA-5676 Cabin Air Filter..... CA-5602 Fuel/Water Separator..... SFC-5601-02		WA430-6 (LOADERS) SAA6D114E-3 Fuel Filter..... FC-5613	
WA470-3 (LOADERS) S6D125-1AM/50001 - 52999 Air Filter Primary..... A-10134 Air Filter Secondary..... A-5631 Air Filter Primary..... A-1013 Air Filter Set..... A-1841-S Fuel Filter..... FC-5602 Hydraulic Oil Filter..... H-5618 Hydraulic Oil Filter..... H-5652 Hydraulic Oil Filter..... H-5609 Oil Filter Full Flow..... C-5605 Oil Filter Full Flow..... C-5701 Oil Filter Full Flow..... C-5715		WA480-5L (LOADERS) KOMATSU SAA6D125E-3 Hydraulic Oil Filter..... H-56770		WA450-5L (LOADERS) SAA6D125E-3 Air Filter Primary..... A-5558M Air Filter Secondary..... A-5559 Air Filter Set..... A-5558M-S Cabin Air Filter..... CA-5676 Cabin Air Filter..... CA-5602 Fuel/Water Separator..... SFC-5601-02 Hydraulic Oil Filter..... H-2709	
WA470-3 (LOADERS) S6D125-1AM/53001 Air Filter Set..... A-1841-S Air Filter Primary..... A-1013 Air Filter Secondary..... A-5631 Air Filter Primary..... A-10134 Fuel Filter..... FC-5602 Hydraulic Oil Filter..... H-5618 Hydraulic Oil Filter..... H-5652 Hydraulic Oil Filter..... H-5609 Oil Filter Full Flow..... C-5605 Oil Filter Full Flow..... C-5701 Oil Filter Full Flow..... C-5715		WA480-5L (LOADERS) KOMATSU SAA6D125E-3 Air Filter Primary..... A-5558M Air Filter Secondary..... A-5559 Air Filter Set..... A-5558M-S Cabin Air Filter..... CA-5676		WA450-5WH (LOADERS) SAA6D125E-3 Air Filter Primary..... A-5558M Air Filter Secondary..... A-5559 Air Filter Set..... A-5558M-S	

Sakura Filter

ENGINE APPLICATION

MODEL/APPLICATION	SAKURA NO	MODEL/APPLICATION	SAKURA NO	MODEL/APPLICATION	SAKURA NO
KOMATSU		KOMATSU		KOMATSU	
WA450-5WH (LOADERS) SAA6D125E-3		Air Filter Secondary.....	A-5610	Fuel Filter.....	FC-5703
Cabin Air Filter.....	CA-5676	Air Filter Primary.....	A-5614	Fuel/Water Separator.....	SFC-5707
Cabin Air Filter.....	CA-5602	Cabin Air Filter.....	CA-56100	Hydraulic Oil Filter.....	H-5618
Fuel/Water Separator.....	SFC-5601-02	Fuel Filter.....	FC-5703	Hydraulic Oil Filter.....	H-5652
Hydraulic Oil Filter.....	H-2709	Fuel/Water Separator.....	SFC-5707	Hydraulic Oil Filter.....	H-5609
WA480-6 (LOADERS) SAA6D125E-5 , 2008		Hydraulic Oil Filter.....	H-5652	Oil Filter Full Flow.....	C-5605
Air Filter Secondary.....	A-5559	Hydraulic Oil Filter.....	H-5618	Oil Filter Full Flow.....	C-5715
Air Filter Set.....	A-5558M-S	Hydraulic Oil Filter.....	H-5609	Oil Filter Full Flow.....	C-5701
Air Filter Primary.....	A-5558M	Oil Filter Full Flow.....	C-5701	Oil Filter Full Flow.....	C-5715
Cabin Air Filter.....	CA-5676	Oil Filter Full Flow.....	C-5715	Oil Filter Full Flow.....	C-5605
Fuel/Water Separator Secondary..	SFC-5611-10B	Oil Filter Full Flow.....	C-5605		
Fuel/Water Separator Secondary..	SFC-5611-10			WA500-1 (LOADERS) S6D140-1R/20001	
Hydraulic Oil Filter.....	H-5629	WA500-1 (LOADERS) NTA855-C		Air Filter Primary.....	A-5614
Hydraulic Oil Filter.....	H-5646	Air Filter Primary.....	A-5614	Air Filter Secondary.....	A-5610
WA480-6 (LOADERS) KOMATSU SAA6D125E-5E		Hydraulic Oil Filter.....	H-5618	Fuel Filter.....	FC-5703
Fuel/Water Separator.....	SFC-56020	Hydraulic Oil Filter.....	H-5609	Fuel/Water Separator.....	SFC-5707
Fuel/Water Separator.....	SFC-56020B	Oil Filter By Pass.....	C-5718	Hydraulic Oil Filter.....	H-5618
WA400-3 (LOADERS) w/S6D108-1C, SAA6D108E-2B Eng.		Oil Filter Full Flow.....	C-5715	Hydraulic Oil Filter.....	H-5609
Cabin Air Filter.....	CA-56100	Oil Filter Full Flow.....	C-5715	Hydraulic Oil Filter.....	H-5652
WA400-3A (LOADERS) w/S6D108-1C, SAA6D108E-2B Eng.				Oil Filter Full Flow.....	C-5715
Cabin Air Filter.....	CA-56100	WA500-1 (LOADERS) S6D140-1/10001		Oil Filter Full Flow.....	C-5605
WA450-6-W1 (LOADERS) KOMATSU SAA6D125E-5		Air Filter Primary.....	A-5614	Oil Filter Full Flow.....	C-5701
Fuel/Water Separator.....	SFC-56020B	Air Filter Secondary.....	A-5610	Oil Filter Full Flow.....	C-5715
Fuel/Water Separator.....	SFC-56020	Cabin Air Filter.....	CA-56100	Oil Filter Full Flow.....	C-5605
WA470-6A (LOADERS) KOMATSU SAA6D125E-5		Fuel Filter.....	FC-5703		
Fuel/Water Separator.....	SFC-56020	Fuel/Water Separator.....	SFC-5707	WA500-1LC (LOADERS) A60001	
Fuel/Water Separator.....	SFC-56020B	Hydraulic Oil Filter.....	H-5609	Air Filter Secondary.....	A-5610
WA470-6A (LOADERS) KOMATSU SAA6D125E-5D		Hydraulic Oil Filter.....	H-5652	Air Filter Primary.....	A-5614
Fuel/Water Separator.....	SFC-56020	Hydraulic Oil Filter.....	H-5618	Cabin Air Filter.....	CA-56100
Fuel/Water Separator.....	SFC-56020B	Oil Filter Full Flow.....	C-5701	Hydraulic Oil Filter.....	H-5609
WA470-6-LC (LOADERS) KOMATSU SAA6D125E-5		Oil Filter Full Flow.....	C-5715	Hydraulic Oil Filter.....	H-5618
Fuel/Water Separator.....	SFC-56020	Oil Filter Full Flow.....	C-5715	Hydraulic Oil Filter.....	H-5652
Fuel/Water Separator.....	SFC-56020B	Oil Filter Full Flow.....	C-5701	Hydraulic Oil Filter.....	H-5652
WA470-6-LC (LOADERS) KOMATSU SAA6D125E-5D				Oil Filter By Pass.....	C-5718
Fuel/Water Separator.....	SFC-56020	WA500-1 (LOADERS) S6D140-1A/10001 - 19999		Oil Filter Full Flow.....	C-5715
Fuel/Water Separator.....	SFC-56020B	Air Filter Secondary.....	A-5610		
WA480-6A (LOADERS) KOMATSU SAA6D125E-5E		Air Filter Primary.....	A-5614	WA500-1LE (LOADERS) S/N: A61001	
Fuel/Water Separator.....	SFC-56020	Fuel Filter.....	FC-5703	Fuel/Water Separator.....	SFC-5705
Fuel/Water Separator.....	SFC-56020B	Fuel/Water Separator.....	SFC-5707	Fuel/Water Separator.....	SFC-5709-10
WA480-6A (LOADERS) KOMATSU SAA6D125E-5		Hydraulic Oil Filter.....	H-5609	Hydraulic Oil Filter.....	H-5618
Fuel/Water Separator.....	SFC-56020	Hydraulic Oil Filter.....	H-5618	Hydraulic Oil Filter.....	H-5609
Fuel/Water Separator.....	SFC-56020B	Hydraulic Oil Filter.....	H-5652	Oil Filter Combination.....	C-5723
WA480-6H (LOADERS) KOMATSU SAA6D125E-5E		Oil Filter Full Flow.....	C-5605	Oil Filter Combination.....	C-5707
Fuel/Water Separator.....	SFC-56020	Oil Filter Full Flow.....	C-5715		
Fuel/Water Separator.....	SFC-56020B	Oil Filter Full Flow.....	C-5701	WA500-3 (LOADERS) CUMMINS N14	
WA500 (LOADERS)		Oil Filter Full Flow.....	C-5715	Fuel/Water Separator.....	SFC-5709-10
Fuel/Water Separator.....	SFC-56020				
Fuel/Water Separator.....	SFC-56020B	WA500-1 (LOADERS) S6D140-1R/10001 - 19999		WA500-3 (LOADERS) KOMATSU SAD140E	
		Air Filter Secondary.....	A-5610	Hydraulic Oil Filter.....	H-56740
		Air Filter Primary.....	A-5614		
		Fuel Filter.....	FC-5703	WA500-3 (LOADERS) KOMATSU S6D140E-3E	
		Fuel/Water Separator.....	SFC-5707	Fuel/Water Separator.....	SFC-56020B
		Hydraulic Oil Filter.....	H-5618	Fuel/Water Separator.....	SFC-56020
		Hydraulic Oil Filter.....	H-5652		
		Oil Filter Full Flow.....	C-5605	WA500-3 (LOADERS) M11	
		Oil Filter Full Flow.....	C-5715	Cabin Air Filter.....	CA-56100
		Oil Filter Full Flow.....	C-5701	Coolant Filter.....	WC-5708
		Oil Filter Full Flow.....	C-5715	Fuel/Water Separator.....	SFC-5705
				Fuel/Water Separator.....	SFC-5709-10
		WA500-1 (LOADERS) S6D140-1A/20001		Oil Filter Combination.....	C-5723
		Air Filter Secondary.....	A-5610	Oil Filter Combination.....	C-5707
		Air Filter Primary.....	A-5614		

MODEL/APPLICATION	SAKURA NO	MODEL/APPLICATION	SAKURA NO	MODEL/APPLICATION	SAKURA NO
KOMATSU		KOMATSU		KOMATSU	
WA500-3 (LOADERS) N14		Coolant Filter..... WC-5711		WA600-1 (LOADERS) KOMATSU S6D170-1 10001	
Fuel/Water Separator.....	SFC-5709-10	Fuel/Water Separator.....	SFC-5709-10	Hydraulic Oil Filter.....	H-56770
Oil Filter Combination.....	C-5707	Fuel/Water Separator.....	SFC-5705	WA600-1 (LOADERS) QSK19	
Oil Filter By Pass.....	C-5718	Hydraulic Oil Filter.....	H-5618	Air Filter Primary.....	A-7912
Oil Filter Full Flow.....	C-5715	Hydraulic Oil Filter.....	H-5609	Air Filter Set.....	A-7912-S
Oil Filter Combination.....	C-5723	Oil Filter Combination.....	C-5707	Air Filter Secondary.....	A-7915
Oil Filter Full Flow.....	C-5701	Oil Filter Combination.....	C-5723	Fuel/Water Separator.....	SFC-5709-10
Oil Filter Full Flow.....	C-5605	WA500-HLLG (LOADERS) SAAGD140E , 2006		Fuel/Water Separator.....	SFC-5705
WA500-3 (LOADERS)		Air Filter Primary.....	A-8665M	Hydraulic Oil Filter.....	H-5618
Air Filter Secondary.....	A-8580	Air Filter Secondary.....	A-8580	Hydraulic Oil Filter.....	H-5609
Air Filter Primary.....	A-8665M	Cabin Air Filter.....	CA-5676	Oil Filter Combination.....	C-5707
Air Filter Secondary.....	A-5610	Fuel/Water Separator Secondary..	SFC-5611-10B	Oil Filter Combination.....	C-5723
Air Filter Primary.....	A-5614	Fuel/Water Separator Secondary... SFC-5611-10		WA600-1 (LOADERS) S6D170-1	
Cabin Air Filter.....	CA-56100	WA500-6 (LOADERS) SAAGD140E , 2006		Fuel Filter.....	FC-5606
Fuel Filter.....	FC-5703	Air Filter Primary.....	A-8665M	WA600-1 (LOADERS) S6D170-1/10001	
Fuel/Water Separator Secondary..	SFC-5611-10B	Air Filter Secondary.....	A-8580	Air Filter Secondary.....	A-5610
Fuel/Water Separator Secondary... SFC-5611-10		Cabin Air Filter.....	CA-5676	Air Filter Primary.....	A-5614
Fuel/Water Separator.....	SFC-5707	Fuel/Water Separator Secondary..	SFC-5611-10B	Cabin Air Filter.....	CA-56100
Hydraulic Oil Filter.....	H-5618	Fuel/Water Separator Secondary... SFC-5611-10		Fuel Filter.....	FC-5602
Hydraulic Oil Filter.....	H-2709	WA500-7 (LOADERS) SAAGD140E-6 , 2012		Fuel Filter.....	FC-5621
Oil Filter Full Flow.....	C-5715	Air Filter Secondary.....	A-8580	Hydraulic Oil Filter.....	H-5652
Oil Filter Full Flow.....	C-5605	Air Filter Primary.....	A-8665M	Oil Filter Full Flow.....	C-5715
Oil Filter Full Flow.....	C-5701	Hydraulic Oil Filter.....	H-5652	Oil Filter Full Flow.....	C-5701
WA500-3 (LOADERS) S6D140-1		WA50-3 (LOADERS) S3D84E		Oil Filter Full Flow.....	C-5605
Air Filter Secondary.....	A-5610	Air Filter Primary.....	AS-2205	WA600-1 (LOADERS) S6D170-1D/10001	
Air Filter Primary.....	A-5614	Fuel Filter.....	F-5210	Air Filter Secondary.....	A-5610
Coolant Filter.....	WC-5711	WA500-3A (LOADERS) w/SA6D140E-3 Eng.		Air Filter Primary.....	A-5614
Fuel/Water Separator Secondary..	SFC-1905-10	Cabin Air Filter.....	CA-56100	Coolant Filter.....	WC-56010
Fuel/Water Separator.....	SFC-5705	WA50-1 (LOADERS) 4D95S-1D		Fuel Filter.....	FC-5602
Fuel/Water Separator.....	SFC-5709-10	Oil Filter Full Flow.....	C-5615	Hydraulic Oil Filter.....	H-5609
Hydraulic Oil Filter.....	H-5618	Oil Filter Full Flow.....	C-5616	Hydraulic Oil Filter.....	H-5652
Hydraulic Oil Filter.....	H-5652	WA600 (LOADERS) CUMMINS QSK19		Hydraulic Oil Filter.....	H-5618
Hydraulic Oil Filter.....	H-2709	Fuel/Water Separator.....	SFC-5709-10	Oil Filter Full Flow.....	C-5715
Oil Filter Combination.....	C-5723	WA600 (LOADERS) KOMATSU SA6D170E-2		Oil Filter Full Flow.....	C-5605
Oil Filter Combination.....	C-5707	Hydraulic Oil Filter.....	H-56770	Oil Filter Full Flow.....	C-5701
WA500-3 (LOADERS) S6D140E		WA600 (LOADERS) QSK19		Oil Filter Full Flow.....	C-5701
Air Filter Secondary.....	A-5610	Fuel/Water Separator.....	SFC-5709-10	WA600-1 (LOADERS) S6D170-1/10490	
Air Filter Primary.....	A-5614	Oil Filter Combination.....	C-5707	Air Filter Secondary.....	A-5610
Fuel Filter.....	FC-5703	Oil Filter Combination.....	C-5723	Air Filter Primary.....	A-5614
Fuel/Water Separator.....	SFC-5707	WA600 (LOADERS) SA6D170E		Coolant Filter.....	WC-6901
Hydraulic Oil Filter.....	H-5618	Cabin Air Filter.....	CA-56100	Fuel Filter.....	FC-5602
Hydraulic Oil Filter.....	H-2709	Fuel/Water Separator.....	SFC-5709-10	Hydraulic Oil Filter.....	H-5609
Oil Filter Full Flow.....	C-5715	Oil Filter Combination.....	C-5707	Hydraulic Oil Filter.....	H-5652
Oil Filter Full Flow.....	C-5605	Oil Filter Combination.....	C-5723	Hydraulic Oil Filter.....	H-5618
Oil Filter Full Flow.....	C-5701	WA600 (LOADERS) SA6D170E		Oil Filter Full Flow.....	C-5715
WA500-3 (LOADERS) w/Cummins M11 Eng.		Cabin Air Filter.....	CA-56100	Oil Filter Full Flow.....	C-5701
Cabin Air Filter.....	CA-56100	Fuel Filter.....	FC-5602	Oil Filter Full Flow.....	C-5605
WA500-3LE (LOADERS) A70001		Hydraulic Oil Filter.....	H-5609	WA600-1 (LOADERS) w/Cummins Eng	
Hydraulic Oil Filter.....	H-56770	Oil Filter Full Flow.....	C-5605	Cabin Air Filter.....	CA-56100
WA500-3LE (LOADERS) S/N: A70001		Oil Filter Full Flow.....	C-5701	WA600-1 (LOADERS) w/S6D170-1 Eng.	
Cabin Air Filter.....	CA-56100	Oil Filter Full Flow.....	C-5715		

Sakura Filter

ENGINE APPLICATION

MODEL/APPLICATION	SAKURA NO	MODEL/APPLICATION	SAKURA NO	MODEL/APPLICATION	SAKURA NO
KOMATSU		KOMATSU		KOMATSU	
WA600-1 (LOADERS) w/S6D170-1 Eng. Cabin Air Filter.....	CA-56100	Oil Filter Full Flow.....	C-5701	WA65 (LOADERS) 2004 Air Filter Secondary.....	A-7004
WA600-1LC (LOADERS) Air Filter Secondary.....	A-5610	WA600-3 (LOADERS) S6D170E-2C/50001 Air Filter Primary.....	A-5614	Air Filter Primary.....	A-7003
Air Filter Primary.....	A-5614	Air Filter Secondary.....	A-5610	Fuel Filter.....	FC-1016
Cabin Air Filter.....	CA-56100	Coolant Filter.....	WC-56010	Oil Filter Full Flow.....	C-1011
Fuel/Water Separator Secondary..	SFC-1905-10	Fuel Filter.....	FC-5602	WA65-3 (LOADERS) 4D94E Air Filter Secondary.....	A-7004
Fuel/Water Separator.....	SFC-5709-10	Hydraulic Oil Filter.....	H-5652	Air Filter Primary.....	A-7003
Fuel/Water Separator.....	SFC-5705	Hydraulic Oil Filter.....	H-5618	Fuel Filter.....	FC-1016
Hydraulic Oil Filter.....	H-5618	Hydraulic Oil Filter.....	H-85680	WA65-3 (LOADERS) KOMATSU 4D94E Fuel/Water Separator.....	SF-52150
Hydraulic Oil Filter.....	H-5652	Oil Filter Full Flow.....	C-5605	WA65-5 (LOADERS) 4D95-LE3 , 2005 Air Filter Secondary.....	A-7004
Hydraulic Oil Filter.....	H-56770	Oil Filter Full Flow.....	C-5715	Air Filter Primary.....	A-7003
Hydraulic Oil Filter.....	H-5609	Oil Filter Full Flow.....	C-5701	Oil Filter Full Flow.....	C-56191
Oil Filter Full Flow.....	C-5715	Oil Filter Full Flow.....	C-5715	Oil Filter Full Flow.....	C-56190
Oil Filter By Pass.....	C-5718	WA6003A (LOADERS) Air Filter Primary.....	A-5614	WA65-6 (LOADERS) 4D95-LE5 , 2008 Air Filter Secondary.....	A-7004
WA600-1LE (LOADERS) A51001 Air Filter Secondary.....	A-7915	Coolant Filter.....	WC-56010	Oil Filter Full Flow.....	C-56191
Fuel/Water Separator.....	SFC-5709-10	Fuel Filter.....	FC-5602	Oil Filter Full Flow.....	C-56190
Fuel/Water Separator.....	SFC-5705	Hydraulic Oil Filter.....	H-85680	WA700-1 (LOADERS) SA6D170 Air Filter Primary.....	A-5614
Hydraulic Oil Filter.....	H-5652	Hydraulic Oil Filter.....	H-5652	Air Filter Secondary.....	A-5610
Hydraulic Oil Filter.....	H-5609	Oil Filter Full Flow.....	C-5605	Coolant Filter.....	WC-56010
Oil Filter Combination.....	C-5723	Oil Filter Full Flow.....	C-5701	Fuel Filter.....	FC-5606
Oil Filter Combination.....	C-5707	Oil Filter Full Flow.....	C-5715	Fuel Filter.....	FC-5602
WA600-3 (LOADERS) CUMMINS QSK19C Fuel/Water Separator.....	SFC-5709-10	WA6003A (LOADERS) w/SA6D170E-2, SAA6D170E-3 Engs. Cabin Air Filter.....	CA-56100	Hydraulic Oil Filter.....	H-5609
WA600-3 (LOADERS) KOMATSU S6D170-1 Fuel/Water Separator.....	SFC-5709-10	WA600-3L (LOADERS) CUMMINS QSK19-A52001 Fuel/Water Separator.....	SFC-5709-10	Hydraulic Oil Filter.....	H-5618
WA600-3 (LOADERS) QSK19C Fuel/Water Separator.....	SFC-5709-10	WA600-3L (LOADERS) QSK19/A52001 Fuel/Water Separator.....	SFC-5709-10	Hydraulic Oil Filter.....	H-85680
Oil Filter Combination.....	C-5707	Hydraulic Oil Filter.....	H-5618	Hydraulic Oil Filter.....	H-5618
Oil Filter Combination.....	C-5723	Hydraulic Oil Filter.....	H-85680	Oil Filter Full Flow.....	C-5715
WA600-3 (LOADERS) S6D170-1 Air Filter Secondary.....	A-5610	Oil Filter Combination.....	C-5707	Oil Filter Full Flow.....	C-5605
Air Filter Primary.....	A-5614	Oil Filter Combination.....	C-5723	Oil Filter Full Flow.....	C-5701
Coolant Filter.....	WC-5705	WA600-3L (LOADERS) S/N: A52001 Air Filter Secondary.....	A-5610	Oil Filter Full Flow.....	C-5605
Fuel/Water Separator.....	SFC-5709-10	Air Filter Primary.....	A-5614	WA700-1 (LOADERS) SA6D170-1/10001 Air Filter Secondary.....	A-5610
Hydraulic Oil Filter.....	H-5618	Cabin Air Filter.....	CA-56100	Air Filter Primary.....	A-5614
Hydraulic Oil Filter.....	H-85680	Fuel/Water Separator.....	SFC-5709-10	Coolant Filter.....	WC-6901
Oil Filter Combination.....	C-5723	Hydraulic Oil Filter.....	H-5652	Fuel Filter.....	FC-5602
Oil Filter Combination.....	C-5707	Hydraulic Oil Filter.....	H-5609	Hydraulic Oil Filter.....	H-5652
WA600-3 (LOADERS) S6D170E Air Filter Primary.....	A-5614	Oil Filter Combination.....	C-5707	Hydraulic Oil Filter.....	H-5618
Air Filter Secondary.....	A-5610	Oil Filter Combination.....	C-5723	Hydraulic Oil Filter.....	H-5609
Coolant Filter.....	WC-56010	WA600-6 (LOADERS) SAA6D170E-5/TIER3 Air Filter Secondary.....	A-8580	Oil Filter Full Flow.....	C-5715
Fuel Filter.....	FC-5606	Air Filter Primary.....	A-8665M	Oil Filter Full Flow.....	C-5701
Fuel Filter.....	FC-5602	Cabin Air Filter.....	CA-5676	Oil Filter Full Flow.....	C-5605
Hydraulic Oil Filter.....	H-5618	Coolant Filter.....	WC-56010	WA700-1 (LOADERS) SA6D170-1/13144 Air Filter Secondary.....	A-5610
Hydraulic Oil Filter.....	H-85680	Fuel/Water Separator Secondary..	SFC-5611-10B	Air Filter Primary.....	A-5614
Oil Filter Full Flow.....	C-5715	Fuel/Water Separator Secondary..	SFC-5611-10	Coolant Filter.....	WC-6901
Oil Filter Full Flow.....	C-5605	Hydraulic Oil Filter.....	H-5618	Fuel Filter.....	FC-5602
		Hydraulic Oil Filter.....	H-5652	Hydraulic Oil Filter.....	H-5609
				Hydraulic Oil Filter.....	H-5652

Sakura Filter

ENGINE APPLICATION

MODEL/APPLICATION	SAKURA NO	MODEL/APPLICATION	SAKURA NO	MODEL/APPLICATION	SAKURA NO
KOMATSU		KOMATSU		KOMATSU	
WA700-1 (LOADERS) SAGD170-1/13144		Oil Filter Full Flow.....	C-1011	Oil Filter Full Flow.....	C-5701
Hydraulic Oil Filter.....	H-5618	WA75-3 (LOADERS) HA950051		WA800-2 (LOADERS) SA12V140-1/10449	
Oil Filter Full Flow.....	C-5605	Air Filter Secondary.....	A-7004	Air Filter Primary.....	A-5614
Oil Filter Full Flow.....	C-5715	Air Filter Primary.....	A-7003	Air Filter Secondary.....	A-5610
Oil Filter Full Flow.....	C-5701	Fuel Filter.....	FC-1016	Coolant Filter.....	WC-6901
		Oil Filter Full Flow.....	C-1011	Fuel Filter.....	FC-5703
WA700-1 (LOADERS) SAGD170-A-1Q/10001		WA800-1 (LOADERS) SABV170-1C/10001		Fuel/Water Separator.....	SFC-5707
Air Filter Secondary.....	A-5610	Air Filter Secondary.....	A-5610	Hydraulic Oil Filter.....	H-5618
Air Filter Primary.....	A-5614	Air Filter Primary.....	A-5614	Hydraulic Oil Filter.....	H-5609
Coolant Filter.....	WC-56010	Coolant Filter.....	WC-56010	Hydraulic Oil Filter.....	H-5652
Fuel Filter.....	FC-5602	Coolant Filter.....	WC-5703	Oil Filter Full Flow.....	C-5715
Hydraulic Oil Filter.....	H-5652	Fuel Filter.....	FC-5703	Oil Filter Full Flow.....	C-5701
Hydraulic Oil Filter.....	H-5618	Fuel/Water Separator.....	SFC-5707	Oil Filter By Pass.....	C-5718
Hydraulic Oil Filter.....	H-5609	Hydraulic Oil Filter.....	H-5618	Oil Filter Full Flow.....	C-5605
Oil Filter Full Flow.....	C-5605	Hydraulic Oil Filter.....	H-5652		
Oil Filter Full Flow.....	C-5701	Hydraulic Oil Filter.....	H-5609	WA800-2 (LOADERS) SA12V140-1A/10501	
Oil Filter Full Flow.....	C-5715	Oil Filter Full Flow.....	C-5701	Air Filter Primary.....	A-5614
		Oil Filter Full Flow.....	C-5715	Air Filter Secondary.....	A-5610
		Oil Filter Full Flow.....	C-5605	Coolant Filter.....	WC-56010
WA700-3 (LOADERS) 2007		WA800-1 (LOADERS) SABV170-1/10040		Fuel Filter.....	FC-5703
Air Filter Secondary.....	A-8580	Air Filter Secondary.....	A-5610	Fuel/Water Separator.....	SFC-5707
Air Filter Primary.....	A-8665M	Air Filter Primary.....	A-5614	Hydraulic Oil Filter.....	H-5652
Coolant Filter.....	WC-6901	Coolant Filter.....	WC-6901	Hydraulic Oil Filter.....	H-5618
Fuel Filter.....	FC-5703	Coolant Filter.....	WC-6901	Hydraulic Oil Filter.....	H-5609
Fuel/Water Separator.....	SFC-5707	Fuel Filter.....	FC-5703	Oil Filter By Pass.....	C-5718
Hydraulic Oil Filter.....	H-5618	Fuel/Water Separator.....	SFC-5707	Oil Filter Full Flow.....	C-5701
Hydraulic Oil Filter.....	H-2709	Hydraulic Oil Filter.....	H-5618	Oil Filter Full Flow.....	C-5605
Oil Filter Full Flow.....	C-5701	Hydraulic Oil Filter.....	H-5652	Oil Filter Full Flow.....	C-5715
Oil Filter Full Flow.....	C-5715	Hydraulic Oil Filter.....	H-5609	Oil Filter Full Flow.....	C-5715
Oil Filter Full Flow.....	C-5605	Hydraulic Oil Filter.....	H-5605		
		Oil Filter Full Flow.....	C-5701	WA800-2 (LOADERS) SA12V140-1/10501	
		Oil Filter Full Flow.....	C-5715	Air Filter Secondary.....	A-5610
WA700-3 (LOADERS) SAAD170E		WA800-2 (LOADERS) SA12V140-1/10002/10394		Air Filter Primary.....	A-5614
Fuel Filter.....	FC-5602	Air Filter Secondary.....	A-5610	Coolant Filter.....	WC-6901
Fuel Filter.....	FC-5606	Coolant Filter.....	WC-6901	Fuel Filter.....	FC-5703
Oil Filter Full Flow.....	C-5701	Fuel Filter.....	FC-5703	Fuel/Water Separator.....	SFC-5707
Oil Filter By Pass.....	C-5718	Fuel/Water Separator.....	SFC-5707	Hydraulic Oil Filter.....	H-5618
Oil Filter Full Flow.....	C-5605	Hydraulic Oil Filter.....	H-5618	Hydraulic Oil Filter.....	H-5652
Oil Filter Full Flow.....	C-5715	Hydraulic Oil Filter.....	H-5609	Hydraulic Oil Filter.....	H-5609
		Oil Filter Full Flow.....	C-5715	Oil Filter Full Flow.....	C-5605
WA70-1 (LOADERS) 4D95L		Oil Filter Full Flow.....	C-5701	Oil Filter By Pass.....	C-5718
Oil Filter Full Flow.....	C-5615	WA800-2 (LOADERS) SA12V140-1/10394/10448		Oil Filter Full Flow.....	C-5715
Oil Filter Full Flow.....	C-5616	Air Filter Secondary.....	A-5610	Oil Filter Full Flow.....	C-5701
		Air Filter Primary.....	A-5614	Oil Filter Full Flow.....	C-5605
WA70-1 (LOADERS) 4D95L-W-1/10001		Coolant Filter.....	WC-6901		
Air Filter Primary.....	AS-1014	Fuel Filter.....	FC-5703	WA800-3 (LOADERS) SA12V140	
Air Filter.....	A-5677	Fuel/Water Separator.....	SFC-5707	Air Filter Secondary.....	A-5610
Air Filter Secondary.....	A-5621	Hydraulic Oil Filter.....	H-5618	Air Filter Primary.....	A-5614
Air Filter Primary.....	AS-5620	Hydraulic Oil Filter.....	H-5652	Coolant Filter.....	WC-56010
Fuel Filter.....	FC-5604	Hydraulic Oil Filter.....	H-5618	Fuel Filter.....	FC-5703
Hydraulic Oil Filter.....	H-5652	Oil Filter Full Flow.....	C-5604	Fuel/Water Separator.....	SFC-5707
Hydraulic Oil Filter.....	H-5618	Oil Filter Full Flow.....	C-5505	Hydraulic Oil Filter.....	H-5618
Oil Filter Full Flow.....	C-5604			Hydraulic Oil Filter.....	H-85680
Oil Filter Full Flow.....	C-5505			Oil Filter Full Flow.....	C-5701
				Oil Filter Full Flow.....	C-5715
WA75 (LOADERS) 2004				Oil Filter Full Flow.....	C-5605
Air Filter Secondary.....	A-7004	WA800-2 (LOADERS) SA12V140-1R/50001			
Air Filter Primary.....	A-7003	Air Filter Secondary.....	A-5610	Air Filter Secondary.....	A-5610
Fuel Filter.....	FC-1016	Air Filter Primary.....	A-5614	Air Filter Primary.....	A-5614
		Coolant Filter.....	WC-6901	Coolant Filter.....	WC-56010
		Fuel Filter.....	FC-5703	Fuel Filter.....	FC-5703
		Fuel/Water Separator.....	SFC-5707	Fuel/Water Separator.....	SFC-5707
		Hydraulic Oil Filter.....	H-5618	Hydraulic Oil Filter.....	H-5618
		Hydraulic Oil Filter.....	H-5652	Hydraulic Oil Filter.....	H-85680
		Hydraulic Oil Filter.....	H-5609	Oil Filter Full Flow.....	C-5701
		Oil Filter Full Flow.....	C-5715	Oil Filter Full Flow.....	C-5715
		Oil Filter By Pass.....	C-5718	Oil Filter Full Flow.....	C-5605
		Oil Filter Full Flow.....	C-5605		

MODEL/APPLICATION	SAKURA NO	MODEL/APPLICATION	SAKURA NO	MODEL/APPLICATION	SAKURA NO
KOMATSU		KOMATSU		KOMATSU	
WA800-3 (LOADERS) SA12V140-1R/50001		WA90-3 (LOADERS) 4D106E-1		Air Filter Secondary.....	A-7964
Coolant Filter.....	WC-56010	Air Filter Secondary.....	A-7004	Fuel Filter.....	FC-1016
Fuel Filter.....	FC-5703	Air Filter Primary.....	A-7003	Hydraulic Oil Filter Transmission...	HC-45050
Fuel/Water Separator.....	SFC-5707			Oil Filter Full Flow.....	C-5204
Hydraulic Oil Filter.....	H-85680	WA95-3 (LOADERS) S/N: H20677			
Hydraulic Oil Filter.....	H-5618	Fuel Filter.....	F-5218	WB140-2 (BACKHOE LOADERS) S4D106-2	
Oil Filter Full Flow.....	C-5605	Fuel Filter.....	FC-5201	Air Filter Primary.....	A-5541
Oil Filter Full Flow.....	C-5701	Oil Filter Full Flow.....	C-1720	Air Filter Primary.....	AS-7805
Oil Filter Full Flow.....	C-5715			Air Filter Secondary.....	A-7964
		WA95-3 (LOADERS) S/N: HA980051		Air Filter Secondary.....	A-5540
WA85-3 (LOADERS) HA960051		Air Filter Secondary.....	A-7004	Fuel Filter.....	FC-1016
Air Filter Secondary.....	A-7004	Air Filter Primary.....	A-7003	Oil Filter Full Flow.....	C-5204
Air Filter Primary.....	A-7003	Fuel Filter.....	FC-1016		
Fuel Filter.....	FC-1016	Oil Filter Full Flow.....	C-1011	WB140-2 (BACKHOE LOADERS) S/N: 140F1001	
Oil Filter Full Flow.....	C-5204	Oil Filter Full Flow.....	C-5204	Air Filter Primary.....	AS-7805
Oil Filter Full Flow.....	C-1011			Air Filter Secondary.....	A-7964
		WA900-1 (LOADERS) SA12V140-1P/50001		Fuel Filter.....	FC-1016
WA800-3EO (LOADERS) SAA12V140E-3		Air Filter Secondary.....	A-5610	Oil Filter Full Flow.....	C-5204
Cabin Air Filter Set.....	CA-5603-S	Air Filter Primary.....	A-5614		
Cabin Air Filter Set.....	CA-5601-S	Coolant Filter.....	WC-56010	WB140-2N (BACKHOE LOADERS) S4D106-2	
Cabin Air Filter.....	CA-56100	Fuel Filter.....	FC-5703	Air Filter Primary.....	A-5541
Fuel/Water Separator Secondary..	SFC-5611-10	Fuel/Water Separator.....	SFC-5707	Air Filter Secondary.....	A-5540
Fuel/Water Separator Secondary..	SFC-5611-10B	Hydraulic Oil Filter.....	H-5609	Fuel Filter.....	FC-1016
Hydraulic Oil Filter.....	H-5652	Hydraulic Oil Filter.....	H-5652	Oil Filter Full Flow.....	C-5204
		Hydraulic Oil Filter.....	H-5618		
WA800-3EO (LOADERS) w/SA12V140E Eng.		Oil Filter Full Flow.....	C-5715	WB140-2T (BACKHOE LOADERS) S4D106-2	
Cabin Air Filter.....	CA-56100	Oil Filter Full Flow.....	C-5701	Air Filter Secondary.....	A-5540
		Oil Filter Full Flow.....	C-5605	Air Filter Primary.....	AS-7805
				Air Filter Secondary.....	A-7964
WA80-5 (LOADERS) KOMATSU , 2005		WA900-1 (LOADERS) SA12V140/50001		Air Filter Primary.....	A-5541
Air Filter Secondary.....	A-7004	Air Filter Secondary.....	A-5610	Fuel Filter.....	FC-1016
Air Filter Primary.....	A-7003	Air Filter Primary.....	A-5614	Oil Filter Full Flow.....	C-5204
Fuel Filter.....	FC-1108	Coolant Filter.....	WC-56010		
Fuel Filter.....	FC-1801	Fuel Filter.....	FC-5703	WB140PS-2N (BACKHOE LOADERS) S4D106-2	
Oil Filter Full Flow.....	C-56190	Fuel/Water Separator.....	SFC-5707	Air Filter Primary.....	A-5541
Oil Filter Full Flow.....	C-56191	Hydraulic Oil Filter.....	H-5609	Air Filter Secondary.....	A-5540
		Hydraulic Oil Filter.....	H-5652	Fuel Filter.....	FC-1016
WA80-3 (LOADERS) w/S4D95LE Eng.		Hydraulic Oil Filter.....	H-5618	Oil Filter Full Flow.....	C-5204
Cabin Air Filter.....	CA-56100	Oil Filter Full Flow.....	C-5715		
		Oil Filter Full Flow.....	C-5701	WB150-2 (BACKHOE LOADERS) KOMATSU S4D106	
		Oil Filter Full Flow.....	C-5605	Fuel/Water Separator.....	SF-52150
WA90 (LOADERS)					
Air Filter Primary.....	A-7003	WA900-3EO (LOADERS) SAA12V140E-3		WB150-2 (BACKHOE LOADERS)	
Fuel Filter.....	FC-1016	Cabin Air Filter Set.....	CA-5601-S	Fuel/Water Separator.....	SF-52150
Oil Filter Full Flow.....	C-5204	Cabin Air Filter.....	CA-56100		
		Cabin Air Filter Set.....	CA-5603-S	WB150-2 (BACKHOE LOADERS) S4D106	
WA900-3 (LOADERS) SAA12V140		Fuel/Water Separator Secondary...	SFC-5611-10	Air Filter Secondary.....	A-5540
Air Filter Secondary.....	A-5610	Fuel/Water Separator Secondary..	SFC-5611-10B	Fuel Filter.....	FC-1016
Air Filter Primary.....	A-5614	Hydraulic Oil Filter.....	H-5652	Oil Filter Full Flow.....	C-5204
Cabin Air Filter.....	CA-56100	Hydraulic Oil Filter.....	H-85680		
Coolant Filter.....	WC-56010			WB150-2 (BACKHOE LOADERS) S/N: 150F10001	
Fuel/Water Separator Secondary..	SFC-5611-10B	WB140-2 (BACKHOE LOADERS) KOMATSU 4D106-1		Air Filter Secondary.....	A-7964
Fuel/Water Separator Secondary..	SFC-5611-10	Fuel/Water Separator.....	SF-52150	Air Filter Primary.....	AS-7805
Hydraulic Oil Filter.....	H-5618			Fuel Filter.....	FC-1016
		WB140-2 (BACKHOE LOADERS)		Oil Filter Full Flow.....	C-5204
WA900-3 (LOADERS) w/SA12V140 Eng.		Air Filter Primary.....	AS-7805		
Cabin Air Filter.....	CA-56100			WB150-2N (BACKHOE LOADERS) KOMATSU S4D106	

Sakura Filter

ENGINE APPLICATION

MODEL/APPLICATION	SAKURA NO	MODEL/APPLICATION	SAKURA NO	MODEL/APPLICATION	SAKURA NO
KOMATSU		KOMATSU		KOMATSU	
WB150-2N (BACKHOE LOADERS) KOMATSU S4D106 Fuel/Water Separator.....	SF-52150	WB156PS-5 (BACKHOE LOADERS) S4D102LE-2 Air Filter Primary.....	A-5541	Oil Filter Full Flow.....	C-5713
WB150-2N (BACKHOE LOADERS) S4D106 Air Filter Secondary.....	A-5540	Air Filter Secondary.....	A-5540	WB97R-5 (BACKHOE LOADERS) SAA4D104E , 2005 Air Filter Primary.....	A-5541
Fuel Filter.....	FC-1016	Hydraulic Oil Filter Transmission..	HC-45050	Air Filter Secondary.....	A-5540
Oil Filter Full Flow.....	C-5204	WB70A (BACKHOE LOADERS) 4D98E Fuel Filter.....	F-5218	Hydraulic Oil Filter Transmission..	HC-45050
WB150AWS-2N (BACKHOE LOADERS) KOMATSU S4D106 Fuel/Water Separator.....	SF-52150	Fuel Filter.....	FC-1016	Oil Filter Full Flow.....	C-5713
WB150AWS-2N (BACKHOE LOADERS) S4D106 Air Filter Secondary.....	A-5540	Hydraulic Oil Filter.....	HC-7906	WB97S-2 (BACKHOE LOADERS) Fuel/Water Separator.....	SF-52150
Fuel Filter.....	FC-1016	Oil Filter Full Flow.....	C-1011	WB97S-2 (BACKHOE LOADERS) S4D106-2 Air Filter Secondary.....	A-7964
Oil Filter Full Flow.....	C-5204	WB70A-1 (BACKHOE LOADERS) Fuel Filter.....	FC-1016	Air Filter Secondary.....	A-5540
WB150PS-2 (BACKHOE LOADERS) KOMATSU S4D106 Fuel/Water Separator.....	SF-52150	WB91R-2 (BACKHOE LOADERS) 4D106-IFA Air Filter Secondary.....	A-7964	Air Filter Primary.....	A-5541
WB150PS-2 (BACKHOE LOADERS) S4D106 Air Filter Secondary.....	A-5540	Air Filter Primary.....	AS-7805	Air Filter Primary.....	AS-7805
Fuel Filter.....	FC-1016	Fuel Filter.....	FC-1016	Fuel Filter.....	FC-1016
Oil Filter Full Flow.....	C-5204	Oil Filter Full Flow.....	C-5204	Oil Filter Full Flow.....	C-5204
WB150PS-2 (BACKHOE LOADERS) S4D106 Fuel/Water Separator.....	SF-52150	WB93-5 (BACKHOE LOADERS) F4GE-9484F Air Filter Secondary.....	A-5540	WB93R-5 (BACKHOE LOADERS) S4D104E-3 , 2005 Air Filter Primary.....	A-5541
WB150PS-2 (BACKHOE LOADERS) S4D106 Air Filter Secondary.....	A-5540	Air Filter Primary.....	A-5541	Air Filter Secondary.....	A-5540
Fuel Filter.....	FC-1016	Fuel/Water Separator.....	SFC-45030	Hydraulic Oil Filter Transmission..	HC-45050
Oil Filter Full Flow.....	C-5204	Hydraulic Oil Filter Transmission..	HC-45050	Oil Filter Full Flow.....	C-5713
WB150PS-2N (BACKHOE LOADERS) KOMATSU S4D106 Fuel/Water Separator.....	SF-52150	Oil Filter Full Flow.....	C-5713	WB93S-5 (BACKHOE LOADERS) S4D104E-3 , 2005 Air Filter Secondary.....	A-5540
WB150PS-2N (BACKHOE LOADERS) S4D106 Air Filter Secondary.....	A-5540	WB93R-2 (BACKHOE LOADERS) YANMAR/KMTWB003C77F26223 , 2005 Air Filter Primary.....	A-5541	Air Filter Primary.....	A-5541
Fuel Filter.....	FC-1016	Fuel Filter.....	FC-5201	Hydraulic Oil Filter Transmission..	HC-45050
Oil Filter Full Flow.....	C-5204	Fuel Filter.....	FC-1016	Oil Filter Full Flow.....	C-5713
WB142-5 (BACKHOE LOADERS) S4D102LE-2 Air Filter Primary.....	A-5541	Hydraulic Oil Filter Transmission..	HC-45050	WB93S-5E0 (BACKHOE LOADERS) S4D104E-3 , 2005 Air Filter Primary.....	A-5541
Air Filter Secondary.....	A-5540	Oil Filter Full Flow.....	C-5204	Air Filter Secondary.....	A-5540
Hydraulic Oil Filter Transmission..	HC-45050	WB93R-2 (BACKHOE LOADERS) KOMATSU S4D106-2SFA Fuel/Water Separator.....	SF-52150	Hydraulic Oil Filter Transmission..	HC-45050
WB146-5 (BACKHOE LOADERS) S4D102LE-2 Air Filter Primary.....	A-5541	WB93R-2 (BACKHOE LOADERS) S4D106-1FA Air Filter Secondary.....	A-5540	Oil Filter Full Flow.....	C-5713
Air Filter Secondary.....	A-5540	Air Filter Primary.....	AS-7805	WB95R-1 (BACKHOE LOADERS) Air Filter Secondary.....	A-7964
Hydraulic Oil Filter Transmission..	HC-45050	Air Filter Secondary.....	A-7964	Air Filter Primary.....	AS-7805
WB146PS-5 (BACKHOE LOADERS) S4D102LE-2 Air Filter Primary.....	A-5541	Air Filter Primary.....	AS-7805	Fuel Filter.....	FC-1702
Air Filter Secondary.....	A-5540	Air Filter Secondary.....	A-7964	Fuel Filter.....	FC-5103
Hydraulic Oil Filter Transmission..	HC-45050	Air Filter Primary.....	A-5541	Hydraulic Oil Filter.....	HC-7913
WB156-5 (BACKHOE LOADERS) S4D102LE-2 Air Filter Primary.....	A-5541	Fuel Filter.....	FC-5201	Oil Filter Full Flow.....	C-5102
Air Filter Secondary.....	A-5540	Fuel Filter.....	FC-1016	WB97S-5E0 (BACKHOE LOADERS) Air Filter Primary.....	A-5541
Hydraulic Oil Filter Transmission..	HC-45050	Oil Filter Full Flow.....	C-5204	Air Filter Secondary.....	A-5540
WB156-5 (BACKHOE LOADERS) S4D102LE-2 Air Filter Primary.....	A-5541	WB97R (BACKHOE LOADERS) Air Filter Secondary.....	A-7964	Fuel Filter.....	FC-5715
Air Filter Secondary.....	A-5540	Fuel Filter.....	FC-1016	Hydraulic Oil Filter Transmission..	HC-45050
Hydraulic Oil Filter Transmission..	HC-45050	Oil Filter Full Flow.....	C-5204	Oil Filter Full Flow.....	C-5713
WB156-5 (BACKHOE LOADERS) S4D102LE-2 Air Filter Primary.....	A-5541	WB97R (BACKHOE LOADERS) S/N: KMTWB015K77F50008 Air Filter Primary.....	A-5541	WB93R-5E0 (BACKHOE LOADERS) Air Filter Primary.....	A-5541
Air Filter Secondary.....	A-5540	Air Filter Secondary.....	A-5540	Air Filter Secondary.....	A-5540
Hydraulic Oil Filter Transmission..	HC-45050	Fuel Filter.....	FC-5715	Fuel Filter.....	FC-5715
		Hydraulic Oil Filter Transmission..	HC-45050	Hydraulic Oil Filter Transmission..	HC-45050

Sakura Filter

ENGINE APPLICATION

MODEL/APPLICATION	SAKURA NO	MODEL/APPLICATION	SAKURA NO	MODEL/APPLICATION	SAKURA NO
KOMATSU		KOMATSU		KOMATSU	
WB93R-5E0 (BACKHOE LOADERS)		Fuel Filter.....	FC-56300	WH714H (HANDLER TELESCOPIC) KOMATSU , 2004	
Oil Filter Full Flow.....	C-5713	WD900-3 (DOZERS) w/SA12V140-1S Eng.		Fuel Filter.....	FC-5715
WB93R-5E0 (BACKHOE LOADERS) S4D104E-3 , 2005		Cabin Air Filter.....	CA-56100	Oil Filter Full Flow.....	C-5713
Air Filter Secondary.....	A-5540	WF22-2 (MOTOR GRADERS) 1011		WH716 (HANDLER TELESCOPIC) KOMATSU , 2004	
Air Filter Primary.....	A-5541	Fuel Filter.....	F-5601	Fuel Filter.....	FC-5715
Hydraulic Oil Filter Transmission..	HC-45050	Hydraulic Oil Filter.....	H-5620	Oil Filter Full Flow.....	C-5713
Oil Filter Full Flow.....	C-5713	Hydraulic Oil Filter.....	H-5610	WR11 (LOADERS) 6D95L	
WB97R-1 (BACKHOE LOADERS)		Oil Filter Full Flow.....	O-5603	Fuel Filter.....	FC-5604
Air Filter Primary.....	AS-7805	Oil Filter By Pass.....	O-5704	Oil Filter Full Flow.....	C-5616
Air Filter Secondary.....	A-7964	WF22A(T)-2 (MOTOR GRADERS) NTC-743		Oil Filter Full Flow.....	C-5604
Fuel Filter.....	FC-1702	Coolant Filter.....	WC-5707	Oil Filter Full Flow.....	C-5615
Fuel Filter.....	FC-5103	Hydraulic Oil Filter.....	H-56600	WR8 (LOADERS) 4D95L	
Hydraulic Oil Filter.....	HC-7913	Hydraulic Oil Filter.....	H-5620	Fuel Filter.....	FC-5604
Oil Filter Full Flow.....	C-5102	Hydraulic Oil Filter.....	H-5610	Oil Filter Full Flow.....	C-5604
WB97R-2 (BACKHOE LOADERS)		Oil Filter Full Flow.....	O-5603	Oil Filter Full Flow.....	C-5615
Fuel/Water Separator.....	SF-52150	Oil Filter By Pass.....	O-5704	Oil Filter Full Flow.....	C-5616
WB97R-2 (BACKHOE LOADERS) SD106-1FA		WF22A-2 (MOTOR GRADERS) NTC-743		WS16S-1 (SCRAPERS) NTA-855	
Air Filter Primary.....	AS-7805	Coolant Filter.....	WC-5707	Air Filter Secondary.....	A-5610
Air Filter Secondary.....	A-7964	Fuel Filter.....	F-5601	Air Filter Primary.....	A-5614
Fuel Filter.....	FC-1016	Hydraulic Oil Filter.....	H-5610	Coolant Filter.....	WC-5707
Oil Filter Full Flow.....	C-5204	Hydraulic Oil Filter.....	H-5620	Fuel Filter.....	FC-5602
WD500-3 (DOZERS)		Hydraulic Oil Filter.....	H-56600	Hydraulic Oil Filter.....	H-56600
Air Filter Secondary.....	A-5610	Oil Filter Full Flow.....	O-5603	Hydraulic Oil Filter.....	H-5609
Air Filter Primary.....	A-5614	Oil Filter By Pass.....	O-5704	Hydraulic Oil Filter.....	H-5610
Oil Filter Full Flow.....	C-5605	WF600T-1 (LOADERS) S6D140-1/10001		Oil Filter Full Flow.....	C-5605
Oil Filter Full Flow.....	C-5701	Air Filter Secondary.....	A-5610	Oil Filter Full Flow.....	C-5701
Oil Filter Full Flow.....	C-5715	Air Filter Primary.....	A-5614	Oil Filter Full Flow.....	C-5715
WD6001 (DOZERS)		Fuel Filter.....	FC-5703	WS16S-2 (SCRAPERS) NTA-855	
Fuel Filter.....	FC-5602	Fuel/Water Separator.....	SFC-5707	Air Filter Secondary.....	A-5610
Hydraulic Oil Filter.....	H-5652	Hydraulic Oil Filter.....	H-5652	Air Filter Primary.....	A-5614
Hydraulic Oil Filter.....	H-5618	Hydraulic Oil Filter.....	H-5618	Coolant Filter.....	WC-5707
Oil Filter Full Flow.....	C-5701	Hydraulic Oil Filter.....	H-5609	Fuel Filter.....	FC-5602
Oil Filter Full Flow.....	C-5715	Oil Filter Full Flow.....	C-5715	Hydraulic Oil Filter.....	H-5609
Oil Filter Full Flow.....	C-5605	Oil Filter Full Flow.....	C-5701	Hydraulic Oil Filter.....	H-5610
WD600-3 (DOZERS) 2006		Oil Filter Full Flow.....	C-5605	Hydraulic Oil Filter.....	H-56600
Air Filter Secondary.....	A-8580	WH609/1 (HANDLER TELESCOPIC) S/N: KMTWH001C77F60093 , 2004		Oil Filter By Pass.....	O-5704
Air Filter Primary.....	A-8665M	Fuel Filter.....	FC-5715	Oil Filter Full Flow.....	C-5605
Cabin Air Filter.....	CA-5676	Fuel/Water Separator.....	SFC-45030	Oil Filter Full Flow.....	C-5715
Coolant Filter.....	WC-56010	Oil Filter Full Flow.....	C-5713	Oil Filter Full Flow.....	C-5701
Hydraulic Oil Filter.....	H-5609	WH613 (HANDLER TELESCOPIC) KOMATSU , 2004		WS16S-3 (SCRAPERS) 3001	
Hydraulic Oil Filter.....	H-5618	Fuel Filter.....	FC-5715	Air Filter Primary.....	A-5614
Oil Filter Full Flow.....	C-5715	Oil Filter Full Flow.....	C-5713	Air Filter Secondary.....	A-5610
Oil Filter Full Flow.....	C-5701	WH713 (HANDLER TELESCOPIC) 2004		Fuel Filter.....	FC-5703
Oil Filter Full Flow.....	C-5605	Fuel Filter.....	FC-5715	Fuel/Water Separator.....	SFC-5707
WD600-3 (DOZERS) w/SAAGD170E-3 Eng.		Oil Filter Full Flow.....	C-5713	Hydraulic Oil Filter.....	H-5610
Cabin Air Filter.....	CA-56100	WH714 (HANDLER TELESCOPIC) KOMATSU , 2004		Hydraulic Oil Filter.....	H-5609
WD600 (DOZERS)		Fuel Filter.....	FC-5715	Oil Filter Full Flow.....	C-5715
Fuel Filter.....	FC-5715	Oil Filter Full Flow.....	C-5713	Oil Filter Full Flow.....	C-5701
Oil Filter Full Flow.....	C-5713	WH714 (HANDLER TELESCOPIC) KOMATSU , 2004		Oil Filter Full Flow.....	C-5605
		Fuel Filter.....	FC-5715		
		Oil Filter Full Flow.....	C-5713		

MODEL/APPLICATION	SAKURA NO
-------------------	-----------

KOMATSU

WS23-1

(SCRAPERS)

NTA-855

Air Filter Secondary.....	A-5610
Air Filter Primary.....	A-5614
Fuel Filter.....	FC-5602
Hydraulic Oil Filter.....	H-56600
Hydraulic Oil Filter.....	H-5609
Hydraulic Oil Filter.....	H-5610
Oil Filter By Pass.....	O-5704
Oil Filter Full Flow.....	C-5605
Oil Filter Full Flow.....	C-5701
Oil Filter Full Flow.....	C-5715

WS23-2

(SCRAPERS)

S/N: 2001

Air Filter Primary.....	A-5614
Air Filter Secondary.....	A-5610
Fuel Filter.....	FC-5703
Fuel/Water Separator.....	SFC-5707
Hydraulic Oil Filter.....	H-5609
Hydraulic Oil Filter.....	H-5610
Oil Filter Full Flow.....	C-5701
Oil Filter Full Flow.....	C-5715
Oil Filter Full Flow.....	C-5605

WS23S-1

(SCRAPERS)

KT-1150

Air Filter Secondary.....	A-5610
Air Filter Primary.....	A-5614
Coolant Filter.....	WC-5705
Fuel Filter.....	FC-5721
Fuel Filter.....	FC-5702
Hydraulic Oil Filter.....	H-5609
Hydraulic Oil Filter.....	H-5610
Hydraulic Oil Filter.....	H-56600
Oil Filter Full Flow.....	C-5715
Oil Filter By Pass.....	O-5704

WS23S-2

(SCRAPERS)

S6D140/3001

Air Filter Secondary.....	A-5610
Air Filter Primary.....	A-5614
Coolant Filter.....	WC-6901
Fuel Filter.....	FC-5703
Fuel/Water Separator.....	SFC-5707
Hydraulic Oil Filter.....	H-5610
Hydraulic Oil Filter.....	H-5609
Oil Filter Full Flow.....	C-5701
Oil Filter Full Flow.....	C-5715
Oil Filter Full Flow.....	C-5605

WX D65

(DOZERS)

KOMATSU SAA6D114E , 2011

Fuel Filter.....	FC-5610
------------------	---------

XT430L-2

(FELLER BUNCHERS)

QSC8.3/TIER3

Fuel Filter.....	FC-5521
Fuel/Water Separator.....	SFC-5509-10



Technical Specification

B

Sakura Filter

Technical Specification

A-1004 Air Filter Metal End Cap Element



MAZDA 0259-23-603
NISSAN 16546-08000
TOYOTA 17801-34010
MITSUBISHI 3649329
ISUZU 5-14215-003-0

H 1 : 61 (mm)
OD 1 : 250 (mm)
OD 2 : 250 (mm)
ID 1 : 192 (mm)
ID 2 : 192 (mm)

CONT : 20
VOL : 0.092

Note : metal end cap version

A-1841-S Air Filter Set Metal End Cap Element



NISSAN 16546-96070
HITACHI 4288963+4288964
KOMATSU 600-181-1600

Primary Filter uses A-1013
Secondary Filter uses A-5631

H 1 : 395 (mm)
H 2 : 382 (mm)
OD 1 : 276 (mm)
OD 2 : 276 (mm)
ID 1 : 165 (mm)
ID 2 : 23 (mm)

CONT : 4
VOL : 0.163

A-44320 Air Filter Secondary Soft PU end cap Element



CATERPILLAR 267-3005
KOMATSU XA4291

Primary Filter uses A-44310
Set Filter uses A-44310-S

H 1 : 570 (mm)
OD 1 : 294 (mm)
OD 2 : 281 (mm)
ID 1 : 236 (mm)

CONT : 1
VOL : 0.064

A-1013 Air Filter Primary Metal End Cap Element



ISUZU 1-14214126-0
ISUZU 1-14215-181-0
ISUZU 1-86750-309-0
NISSAN 16546-96071
NISSAN 16546-99218

Secondary Filter uses A-5631
Set Filter uses A-1841-S

H 1 : 394.7 (mm)
H 2 : 382 (mm)
OD 1 : 276 (mm)
OD 2 : 275 (mm)
ID 1 : 165 (mm)
ID 2 : 23 (mm)

CONT : 4
VOL : 0.154

Note : Is a Primary Air Filter for A-5631,A-7607

A-2210 Air Filter Primary Metal End Cap Element



FIAT 0068473-3
ISUZU 1-14215-018-0
ISUZU 1-14215007-0
NISSAN 16546-96011

Secondary Filter uses A-6008
Set Filter uses A-6117-S

H 1 : 342.7 (mm)
H 2 : 330 (mm)
OD 1 : 234 (mm)
OD 2 : 234 (mm)
ID 1 : 123 (mm)
ID 2 : 17 (mm)

CONT : 4
VOL : 0.093

A-5105 Air Filter Primary Soft PU end cap Element



BOMAG 05821147
VOLVO 2908237
MASSEY-FERGUSON 3901477M1
J.C.BAMFORD 580-12020

Secondary Filter uses A-5106
Set Filter uses A-5107-S

H 1 : 400 (mm)
H 2 : 367 (mm)
OD 1 : 194 (mm)
OD 2 : 194 (mm)
ID 1 : 113.5 (mm)

CONT : 4
VOL : 0.078

A-10134 Air Filter Primary Metal End Cap Element



MITSUBISHI ME 063130

H 1 : 394.7 (mm)
H 2 : 382 (mm)
OD 1 : 276 (mm)
OD 2 : 275 (mm)
ID 1 : 165 (mm)
ID 2 : 23 (mm)

CONT : 1
VOL : 0.035

Note : Flame retardant version from A-1013

A-3320 Air Filter Plastic framed Element



DAIHATSU 15601-87716
TOYOTA 17801-03030
TOYOTA 17801-74010
DAIHATSU 17801-87104
DAIHATSU 17801-87104-000

H 1 : 51 (mm)
Length 1 : 222.5 (mm)
Width 1 : 165 (mm)

CONT : 24
VOL : 0.060

Note : A-1122 Soft PU Versions, A-3320 Plastic Version

A-5106 Air Filter Secondary Soft PU end cap Element



VOLVO 2908238
MASSEY-FERGUSON 3901478M1
J.C.BAMFORD 580-12021

Primary Filter uses A-5105
Set Filter uses A-5107-S

H 1 : 386 (mm)
H 2 : 380 (mm)
OD 1 : 104 (mm)
OD 2 : 107 (mm)
ID 1 : 93 (mm)

CONT : 25
VOL : 0.178

A-1307 Air Filter Secondary Metal End Cap Element



ISUZU 1-14215085-0
HINO 17801-2460
CATERPILLAR 3I-0179

Primary Filter uses A-1313
Set Filter uses A-5662-S

H 1 : 444.7 (mm)
H 2 : 432 (mm)
OD 1 : 145 (mm)
OD 2 : 145 (mm)
ID 1 : 116.5 (mm)
ID 2 : 23 (mm)

CONT : 9
VOL : 0.106

A-44310 Air Filter Primary Soft PU end cap Element



CATERPILLAR 267-3004
CATERPILLAR 419-9162
KOMATSU XA4292

Secondary Filter uses A-44320
Set Filter uses A-44310-S

H 1 : 617 (mm)
H 2 : 612 (mm)
OD 1 : 450 (mm)
OD 2 : 450 (mm)
ID 1 : 292 (mm)

CONT : 1
VOL : 0.150

A-5114 Air Filter Secondary Metal End Cap Element



CASE 131100190019
INTERNATIONAL HARVESTER 3
148 080
ATLAS COPCO 361 1276

Primary Filter uses A-6808
Set Filter uses A-6808-S

H 1 : 284.5 (mm)
H 2 : 266 (mm)
OD 1 : 69.6 (mm)
OD 2 : 60.7 (mm)
ID 1 : 52.4 (mm)
ID 2 : 16.8 (mm)

CONT : 25
VOL : 0.054

A-1313 Air Filter Primary Metal End Cap Element



CATERPILLAR 099-5801
ISUZU 1-14215084-0
HINO 17720-3640
HINO 17801-2530

Secondary Filter uses A-1307
Set Filter uses A-5662-S

H 1 : 469.75 (mm)
H 2 : 457 (mm)
OD 1 : 232 (mm)
OD 2 : 232 (mm)
ID 1 : 147 (mm)
ID 2 : 23 (mm)

CONT : 4
VOL : 0.123

A-44310-S Air Filter Set Soft PU end cap Element



CATERPILLAR 267-3004+267-3005
KOMATSU XA4292+XA4291

Primary Filter uses A-44310
Secondary Filter uses A-44320

H 1 : 617 (mm)
H 2 : 612 (mm)
OD 1 : 450 (mm)
OD 2 : 450 (mm)
ID 1 : 236 (mm)

CONT : 1
VOL : 0.150

A-5206 Air Filter Metal End Cap Element



YANMAR 114250-12580

H 1 : 45.5 (mm)
OD 1 : 105 (mm)
OD 2 : 100 (mm)
ID 1 : 54.5 (mm)
ID 2 : 6 (mm)

CONT : 50
VOL : 0.038

A-52180 Air Filter Metal End Cap Element With Foam Wrap

YANMAR 114650-12590
YANMAR 114650-12591
KOMATSU YM11465012540



H 1 : 72.5 (mm)
OD 1 : 142 (mm)
OD 2 : 99 (mm)
ID 1 : 94 (mm)
ID 2 : 50 (mm)

CONT : 20
VOL : 0.031

16

A-5408 Air Filter Secondary Metal End Cap Element

ISUZU 1-14215034-0
ISUZU 1-14215036-0
NISSAN 16546-96014



Primary Filter uses A-6113
Set Filter uses A-5653-S
H 1 : 406 (mm)
OD 1 : 192.3 (mm)
OD 2 : 162.5 (mm)
ID 1 : 134.2 (mm)
ID 2 : 17 (mm)

CONT : 9
VOL : 0.167

Note : Is a Secondary Air filter for A-6113,A-54490

21

A-5420 Air Filter Primary Metal End Cap Element

INTERNATIONAL HARVESTER
672019 C2



Secondary Filter uses A-5421
Set Filter uses A-5420-S
H 1 : 342.75 (mm)
H 2 : 330 (mm)
OD 1 : 307 (mm)
OD 2 : 307 (mm)
ID 1 : 196 (mm)
ID 2 : 17 (mm)

CONT : 1
VOL : 0.037

26

A-5309 Air Filter Secondary Metal End Cap Element

MERCEDES-BENZ 002 094 33 04
INTERNATIONAL HARVESTER
3147878R1
DEUTZ 4144897



Primary Filter uses A-6201
Set Filter uses A-6201-S
H 1 : 326 (mm)
H 2 : 326 (mm)
OD 1 : 78 (mm)
OD 2 : 68 (mm)
ID 1 : 58 (mm)
ID 2 : 18 (mm)

CONT : 25
VOL : 0.104

17

A-5410 Air Filter Metal End Cap Element

KOMATSU 385-10161992
INTERNATIONAL HARVESTER
667975 C1
JOHN DEERE AT49022



H 1 : 518 (mm)
OD 1 : 282 (mm)
OD 2 : 282 (mm)
ID 1 : 170 (mm)
ID 2 : 17 (mm)

CONT : 1
VOL : 0.050

22

A-5420-S Air Filter Set Metal End Cap Element

INTERNATIONAL HARVESTER
672019C2+672020C1



Primary Filter uses A-5420
Secondary Filter uses A-5421
H 1 : 331 (mm)
H 2 : 305 (mm)
OD 1 : 307 (mm)
OD 2 : 194 (mm)
ID 1 : 196 (mm)
ID 2 : 17 (mm)

CONT : 1
VOL : 0.041

27

A-5405 Air Filter Primary Metal End Cap Element

HITACHI 4230365
INTERNATIONAL HARVESTER
627127 C1
JOHN DEERE AE30508



Secondary Filter uses A-5406
Set Filter uses A-5405-S
H 1 : 418 (mm)
H 2 : 405.5 (mm)
OD 1 : 264.5 (mm)
OD 2 : 264.5 (mm)
ID 1 : 153 (mm)
ID 2 : 23 (mm)

CONT : 1
VOL : 0.033

18

A-5413 Air Filter Primary Metal End Cap Element

KOMATSU 044-38510-56931
KOMATSU 385-102-56931
CATERPILLAR 3I-0260



Secondary Filter uses A-5414
Set Filter uses A-5660-S
H 1 : 317.7 (mm)
H 2 : 305 (mm)
OD 1 : 264.5 (mm)
OD 2 : 264.5 (mm)
ID 1 : 153 (mm)
ID 2 : 17 (mm)

CONT : 1
VOL : 0.027

23

A-5425 Air Filter Primary Metal End Cap Element

HINO 17801-2020
HINO 17801-2270
HINO 17801-2290



Secondary Filter uses A-5417
Set Filter uses A-5425-S
H 1 : 418.7 (mm)
H 2 : 406 (mm)
OD 1 : 307 (mm)
OD 2 : 307 (mm)
ID 1 : 196 (mm)
ID 2 : 22.7 (mm)

CONT : 1
VOL : 0.050

28

A-5405-S Air Filter Set Metal End Cap Element

HITACHI 4230365+4230364
INTERNATIONAL HARVESTER
627127C1+627128C1



Primary Filter uses A-5405
Secondary Filter uses A-5406
H 1 : 418 (mm)
H 2 : 405.5 (mm)
OD 1 : 264.5 (mm)
OD 2 : 264.5 (mm)
ID 1 : 153 (mm)
ID 2 : 23 (mm)

CONT : 1
VOL : 0.036

19

A-5414 Air Filter Secondary Metal End Cap Element

KOMATSU 044-38510-56941
CATERPILLAR 3I-0254
INTERNATIONAL HARVESTER
627935 C1



Primary Filter uses A-5413
Set Filter uses A-5660-S
H 1 : 266.75 (mm)
H 2 : 254 (mm)
OD 1 : 151 (mm)
OD 2 : 151 (mm)
ID 1 : 123 (mm)
ID 2 : 17 (mm)

CONT : 9
VOL : 0.094

24

A-5434 Air Filter Metal End Cap Element

KOMATSU 381-935694-1
INTERNATIONAL HARVESTER
935694 C1



H 1 : 419.2 (mm)
H 2 : 406.5 (mm)
OD 1 : 264.5 (mm)
OD 2 : 264.5 (mm)
ID 1 : 153 (mm)
ID 2 : 17 (mm)

CONT : 1
VOL : 0.033

29

A-5406 Air Filter Secondary Metal End Cap Element

KOMATSU 381-935-6931
HITACHI 4230364
INTERNATIONAL HARVESTER
627128 C1



Primary Filter uses A-5405
Set Filter uses A-5405-S
H 1 : 367.7 (mm)
H 2 : 355 (mm)
OD 1 : 151 (mm)
OD 2 : 151 (mm)
ID 1 : 123 (mm)
ID 2 : 23 (mm)

CONT : 9
VOL : 0.100

20

A-5417 Air Filter Secondary Metal End Cap Element

NISSAN 16546-90204
INTERNATIONAL HARVESTER
702753 C1



Primary Filter uses A-5425
Set Filter uses A-5425-S
H 1 : 393.7 (mm)
H 2 : 381 (mm)
OD 1 : 194 (mm)
OD 2 : 194 (mm)
ID 1 : 153 (mm)
ID 2 : 22.7 (mm)

CONT : 9
VOL : 0.169

25

A-5437 Air Filter Secondary Metal End Cap Element

CASE 1129112-C1
FURUKAWA 1129112C1



Primary Filter uses AS-8502
Set Filter uses AS-8502-S
H 1 : 365 (mm)
H 2 : 355 (mm)
OD 1 : 104 (mm)
OD 2 : 104 (mm)
ID 1 : 74 (mm)
ID 2 : 17 (mm)

CONT : 25
VOL : 0.141

30

Sakura Filter

Technical Specification

A-55211 Air Filter Primary Rigid PU end cap Element

CATERPILLAR 1P-8483
CATERPILLAR 7W-5313



Secondary Filter uses A-55291
Set Filter uses A-55211-S
H 1 : 395 (mm)
H 2 : 382 (mm)
OD 1 : 316 (mm)
OD 2 : 316 (mm)
ID 1 : 225 (mm)

CONT : 1
VOL : 0.045

Note : is Rigid PU version of A-5521

31

A-5558M Air Filter Primary Soft PU+Metal Element

KOMATSU 600-185-5100P
KOMATSU 600-185-5110
CATERPILLAR 6I-2503



Secondary Filter uses A-5559
Set Filter uses A-5558M-S
H 1 : 417 (mm)
H 2 : 405 (mm)
OD 1 : 280 (mm)
OD 2 : 280 (mm)
ID 1 : 148 (mm)

CONT : 1
VOL : 0.038

Note : with reinforcement

36

A-5602 Air Filter Primary Metal End Cap Element

KOMATSU 600-181-2450
KOMATSU 600-181-2500



Secondary Filter uses A-5603
Set Filter uses A-5601-S
H 1 : 332.75 (mm)
H 2 : 320 (mm)
OD 1 : 246.5 (mm)
OD 2 : 246.5 (mm)
ID 1 : 143.3 (mm)
ID 2 : 17 (mm)

CONT : 1
VOL : 0.026

41

A-55211-S Air Filter Set rigid PU+metal Element

CATERPILLAR 7W-5313+7N-1308



Primary Filter uses A-55211
Secondary Filter uses A-55291
H 1 : 395 (mm)
H 2 : 382 (mm)
OD 1 : 316 (mm)
OD 2 : 316 (mm)
ID 1 : 178 (mm)

CONT : 1
VOL : 0.047

Note : is rigid PU version of A-5521-S

32

A-5558M-S Air Filter Set Soft PU+Metal Element

KOMATSU 600-185-5100
CATERPILLAR 6I-2503+6I-2504



Primary Filter uses A-5558M
Secondary Filter uses A-5559
H 1 : 417 (mm)
H 2 : 405 (mm)
OD 1 : 280 (mm)
OD 2 : 280 (mm)
ID 1 : 148 (mm)

CONT : 1
VOL : 0.038

Note : with reinforcement

37

A-5603 Air Filter Secondary Metal End Cap Element

KOMATSU 600-181-2460
KOMATSU 600-181-2461
KOMATSU 600-311-2460



Primary Filter uses A-5602
Set Filter uses A-5601-S
H 1 : 271 (mm)
H 2 : 269 (mm)
OD 1 : 141 (mm)
OD 2 : 141 (mm)
ID 1 : 107.5 (mm)
ID 2 : 17 (mm)

CONT : 12
VOL : 0.093

42

A-55291 Air Filter Secondary Metal End Cap Element with 10 Bolt Holes

CATERPILLAR 7N-1308



Primary Filter uses A-55211
Set Filter uses A-55211-S
H 1 : 384 (mm)
H 2 : 383 (mm)
OD 1 : 289 (mm)
OD 2 : 219.5 (mm)
ID 1 : 178 (mm)

CONT : 1
VOL : 0.038

33

A-5559 Air Filter Secondary Soft PU end cap Element

KOMATSU 424-01-H0P02
KOMATSU 600-185-5100S
KOMATSU 600-185-5120



Primary Filter uses A-5558
Set Filter uses A-5558-S
H 1 : 394 (mm)
OD 1 : 150 (mm)
OD 2 : 142.3 (mm)
ID 1 : 109 (mm)

CONT : 1
VOL : 0.011

38

A-5604-S Air Filter Set Metal End Cap Element

KOMATSU 600-181-1260
KOMATSU 600-182-2500
KOMATSU 6112-83-7600



Primary Filter uses A-5605
Secondary Filter uses A-5606
H 1 : 380 (mm)
H 2 : 330 (mm)
OD 1 : 244 (mm)
OD 2 : 129 (mm)
ID 1 : 123 (mm)
ID 2 : 17 (mm)

CONT : 1
VOL : 0.030

43

A-5540 Air Filter Secondary Soft PU end cap Element

YANMAR 119117-12570
CATERPILLAR 1318903
PERKINS 26510343
YANMAR Y119117-12570



Primary Filter uses A-5541
Set Filter uses A-5541-S
H 1 : 346 (mm)
H 2 : 340 (mm)
OD 1 : 92 (mm)
OD 2 : 86.5 (mm)
ID 1 : 72.5 (mm)

CONT : 25
VOL : 0.105

34

A-5569 Air Filter Secondary Soft PU end cap Element

VOLVO 11801160
CATERPILLAR 1467473
JOHN DEERE M131803
KOMATSU YM12905112530



Primary Filter uses A-8513
Set Filter uses A-5570-S
H 1 : 265 (mm)
H 2 : 259 (mm)
OD 1 : 61 (mm)
OD 2 : 59 (mm)
ID 1 : 45 (mm)

CONT : 25
VOL : 0.048

39

A-5605 Air Filter Primary Metal End Cap Element

CATERPILLAR 3I-0867
KOMATSU 600-181-1320
KOMATSU 600-181-1340



Secondary Filter uses A-5606
Set Filter uses A-5604-S
H 1 : 393.7 (mm)
H 2 : 381 (mm)
OD 1 : 244.5 (mm)
OD 2 : 244.5 (mm)
ID 1 : 133.5 (mm)
ID 2 : 17 (mm)

CONT : 1
VOL : 0.027

44

A-5541 Air Filter Primary Soft PU end cap Element

YANMAR 119117-12560
CATERPILLAR 131-8902
PERKINS 26510342
HITACHI 4486002



Secondary Filter uses A-5540
Set Filter uses A-5541-S
H 1 : 356 (mm)
H 2 : 347 (mm)
OD 1 : 163.5 (mm)
OD 2 : 163.5 (mm)
ID 1 : 91 (mm)

CONT : 9
VOL : 0.108

35

A-5601-S Air Filter Set Metal End Cap Element

KOMATSU 600-181-8550
KOMATSU 6114-80-7010
KOMATSU 6114-80-7101



Primary Filter uses A-5602
Secondary Filter uses A-5603
H 1 : 320 (mm)
H 2 : 268 (mm)
OD 1 : 246.5 (mm)
OD 2 : 246.5 (mm)
ID 1 : 143 (mm)
ID 2 : 16 (mm)

CONT : 1
VOL : 0.026

40

A-5606 Air Filter Secondary Metal End Cap Element

KOMATSU 600-181-2350
KOMATSU 600-182-2500
KOMATSU 6112-83-7620



Primary Filter uses A-5605
Set Filter uses A-5604-S
H 1 : 342.7 (mm)
H 2 : 330 (mm)
OD 1 : 129 (mm)
OD 2 : 129 (mm)
ID 1 : 97 (mm)
ID 2 : 17 (mm)

CONT : 9
VOL : 0.084

45

Sakura Filter

Technical Specification

A-5608 Air Filter Primary Metal End Cap Element
KOMATSU 600-181-7210



Secondary Filter uses A-5609
Set Filter uses A-5608-S
H 1 : 311.7 (mm)
H 2 : 299 (mm)
OD 1 : 179.5 (mm)
OD 2 : 179.5 (mm)
ID 1 : 101 (mm)
ID 2 : 14 (mm)

CONT : 9
VOL : 0.124

A-5617 Air Filter Secondary Metal End Cap Element
KOMATSU 600-181-9120
KOMATSU 600-181-9320



Primary Filter uses A-5616
Set Filter uses A-5655-S
H 1 : 300.7 (mm)
H 2 : 291 (mm)
OD 1 : 104 (mm)
OD 2 : 104 (mm)
ID 1 : 74 (mm)
ID 2 : 17 (mm)

CONT : 25
VOL : 0.111

A-5624 Air Filter Secondary Metal End Cap Element
KOMATSU 144-01-B5620
CATERPILLAR 3I-0375
KOMATSU 6691-80-7212



Primary Filter uses A-5623
Set Filter uses A-5622-S
H 1 : 374 (mm)
OD 1 : 146.2 (mm)
OD 2 : 146.2 (mm)
ID 1 : 88 (mm)
ID 2 : 17 (mm)

CONT : 9
VOL : 0.093

A-5608-S Air Filter Set Metal End Cap Element
KOMATSU 6141-81-7030



Primary Filter uses A-5608
Secondary Filter uses A-5609
H 1 : 311.7 (mm)
H 2 : 299 (mm)
OD 1 : 179.5 (mm)
OD 2 : 179.5 (mm)
ID 1 : 101 (mm)
ID 2 : 14 (mm)

CONT : 9
VOL : 0.120

A-5618 Air Filter Primary Metal End Cap Element
NISSAN 16546-97004
HINO 17801-2550
HITACHI 4177213



Secondary Filter uses A-5610
Set Filter uses A-5658-S
H 1 : 469.7 (mm)
H 2 : 457 (mm)
OD 1 : 307 (mm)
OD 2 : 307 (mm)
ID 1 : 196 (mm)
ID 2 : 17 (mm)

CONT : 1
VOL : 0.054

A-5627 Air Filter Primary Metal End Cap Element
KOBELCO 2451-U311-3
DAEWOO 2474-6006A
DAEWOO 2474-6006B



Secondary Filter uses A-6008
Set Filter uses A-5663-S
H 1 : 393.7 (mm)
H 2 : 381 (mm)
OD 1 : 235 (mm)
OD 2 : 187 (mm)
ID 1 : 120 (mm)
ID 2 : 17 (mm)

CONT : 1
VOL : 0.026

A-5610 Air Filter Secondary Metal End Cap Element
NISSAN 16546-97005
CATERPILLAR 3I-0125
HITACHI 4177212



Primary Filter uses A-5614
Set Filter uses A-5613-S
H 1 : 449 (mm)
OD 1 : 214.8 (mm)
OD 2 : 185 (mm)
ID 1 : 157.5 (mm)
ID 2 : 17 (mm)

CONT : 4
VOL : 0.099

Note : Is a Secondary Air filter for A-5614,A-5618

A-5621 Air Filter Secondary Metal End Cap Element
KOMATSU 600-181-7360
KOMATSU 600-181-7400S



Primary Filter uses AS-5620
Set Filter uses AS-5620-S
H 1 : 242 (mm)
H 2 : 237 (mm)
OD 1 : 83 (mm)
OD 2 : 83 (mm)
ID 1 : 54 (mm)
ID 2 : 17 (mm)

CONT : 25
VOL : 0.062

A-5628 Air Filter Primary Metal End Cap Element
CHRYSLER 3614353
KOMATSU 600-181-8240



Secondary Filter uses A-7611
Set Filter uses A-5628-S
H 1 : 311 (mm)
H 2 : 305 (mm)
OD 1 : 155 (mm)
OD 2 : 155 (mm)
ID 1 : 88 (mm)
ID 2 : 17 (mm)

CONT : 12
VOL : 0.120

A-5614 Air Filter Primary Metal End Cap Element
CATERPILLAR 3I-0374
KOMATSU 600-181-4400
KOMATSU 600-181-4400P



Secondary Filter uses A-5610
Set Filter uses A-5613-S
H 1 : 469.75 (mm)
H 2 : 457 (mm)
OD 1 : 307 (mm)
OD 2 : 377 (mm)
ID 1 : 196 (mm)
ID 2 : 24 (mm)

CONT : 1
VOL : 0.073

A-5622-S Air Filter Set Metal End Cap Element
KOMATSU 6691-80-7210
KOMATSU 6691-80-7211
KOMATSU 6691-80-7212



Primary Filter uses A-5623
Secondary Filter uses A-5624
H 1 : 393.7 (mm)
H 2 : 381 (mm)
OD 1 : 234 (mm)
OD 2 : 234 (mm)
ID 1 : 123 (mm)
ID 2 : 17 (mm)

CONT : 4
VOL : 0.104

A-5628-S Air Filter Set Metal End Cap Element
CLAAS 3200010+3200020
BLOUNT 537986+537987
BOBCAT 6681474+6681475
JOHN DEERE AT44377+AT44378



Primary Filter uses A-5628
Secondary Filter uses A-7611
H 1 : 311 (mm)
H 2 : 305 (mm)
OD 1 : 155 (mm)
OD 2 : 155 (mm)
ID 1 : 88 (mm)
ID 2 : 17 (mm)

CONT : 12
VOL : 0.194

A-5616 Air Filter Primary Metal End Cap Element
KOMATSU 600-181-9220



Secondary Filter uses A-5617
Set Filter uses A-5655-S
H 1 : 331.7 (mm)
H 2 : 319 (mm)
OD 1 : 209 (mm)
OD 2 : 209 (mm)
ID 1 : 106.5 (mm)
ID 2 : 14 (mm)

CONT : 9
VOL : 0.159

A-5623 Air Filter Primary Metal End Cap Element
CATERPILLAR 3I-0376
KOMATSU 600-181-3300
KOMATSU 6691-81-7210



Secondary Filter uses A-5624
Set Filter uses A-5622-S
H 1 : 393.7 (mm)
H 2 : 381 (mm)
OD 1 : 234 (mm)
OD 2 : 234 (mm)
ID 1 : 123 (mm)
ID 2 : 17 (mm)

CONT : 4
VOL : 0.105

A-5629 Air Filter Primary Metal End Cap Element
ISUZU 1-14125082-0
ISUZU 1-14215082-0
CATERPILLAR 3I-0202



Secondary Filter uses A-5630
Set Filter uses A-5629-S
H 1 : 622 (mm)
H 2 : 609.5 (mm)
OD 1 : 307 (mm)
OD 2 : 307 (mm)
ID 1 : 196 (mm)
ID 2 : 22.7 (mm)

CONT : 1
VOL : 0.071

Sakura Filter

Technical Specification

A-5629-S Air Filter Set Metal End Cap Element

HITACHI 4240294+4240295
KOMATSU
561-02-12330+561-02-12320



Primary Filter uses A-5629
Secondary Filter uses A-5630
H 1 : 622 (mm)
H 2 : 609.5 (mm)
OD 1 : 307 (mm)
OD 2 : 307 (mm)
ID 1 : 196 (mm)
ID 2 : 22.7 (mm)

CONT : 1
VOL : 0.071

A-5637 Air Filter Primary Metal End Cap Element

KOMATSU 6675-81-7230
KOMATSU 6675-81-7231



Secondary Filter uses A-5642
Set Filter uses A-5607-S
H 1 : 224 (mm)
OD 1 : 245 (mm)
OD 2 : 245 (mm)
ID 1 : 132 (mm)

CONT : 4
VOL : 0.072

Note : primary A-5636+A-5637

A-5655-S Air Filter Set Metal End Cap Element

KOMATSU 600-181-9300
KOMATSU 600-181-9301



Primary Filter uses A-5616
Secondary Filter uses A-5617
H 1 : 331.7 (mm)
H 2 : 319 (mm)
OD 1 : 209 (mm)
OD 2 : 209 (mm)
ID 1 : 106.5 (mm)
ID 2 : 14 (mm)

CONT : 9
VOL : 0.159

A-5630 Air Filter Secondary Metal End Cap Element

ISUZU 1-14215081-0
CATERPILLAR 3I-0203
HITACHI 4240295



Primary Filter uses A-5629
Set Filter uses A-5629-S
H 1 : 596.7 (mm)
H 2 : 584 (mm)
OD 1 : 185 (mm)
OD 2 : 185 (mm)
ID 1 : 157.5 (mm)
ID 2 : 17 (mm)

CONT : 1
VOL : 0.025

A-5639 Air Filter Primary Metal End Cap Element

KOBELCO 2451-U324-3
MITSUBISHI 3433000400



Secondary Filter uses A-5635
Set Filter uses A-5654-S
H 1 : 454.7 (mm)
H 2 : 442 (mm)
OD 1 : 263.5 (mm)
OD 2 : 221 (mm)
ID 1 : 136 (mm)
ID 2 : 23 (mm)

CONT : 1
VOL : 0.036

A-5657-S Air Filter Set Metal End Cap Element

KOMATSU 6110-80-7300
KOMATSU 6110-80-7300(SET)
KOMATSU 6610-80-7300



Primary Filter uses A-5649
Secondary Filter uses A-5633
H 1 : 425.8 (mm)
H 2 : 413.5 (mm)
OD 1 : 214 (mm)
OD 2 : 213.5 (mm)
ID 1 : 107 (mm)

CONT : 4
VOL : 0.100

A-5631 Air Filter Secondary Metal End Cap Element

ISUZU 1-14215087-0
NISSAN 16546-96072
HITACHI 4288964



Primary Filter uses A-1013
Set Filter uses A-1841-S
H 1 : 361.75 (mm)
H 2 : 349 (mm)
OD 1 : 162.5 (mm)
OD 2 : 163 (mm)
ID 1 : 134 (mm)
ID 2 : 17 (mm)

CONT : 9
VOL : 0.110

A-5647 Air Filter Secondary Metal End Cap Element

KOMATSU 600-181-9480



Primary Filter uses A-7939
Set Filter uses A-5652-S
H 1 : 280.6 (mm)
H 2 : 280 (mm)
OD 1 : 105 (mm)
OD 2 : 85.5 (mm)
ID 1 : 73.5 (mm)
ID 2 : 17 (mm)

CONT : 12
VOL : 0.055

A-5660-S Air Filter Set Metal End Cap Element

KOMATSU 044-3510-22411
CATERPILLAR 3I-0260+3I-0254
INTERNATIONAL HARVESTER
627934C1+627935C1



Primary Filter uses A-5413
Secondary Filter uses A-5414
H 1 : 305 (mm)
H 2 : 254 (mm)
OD 1 : 264 (mm)
OD 2 : 151 (mm)
ID 1 : 153 (mm)
ID 2 : 17 (mm)

CONT : 1
VOL : 0.027

A-5635 Air Filter Secondary Metal End Cap Element

DAEWOO 2474-9054
KOMATSU 600-181-6730
MITSUBISHI ME033839



Primary Filter uses A-5639
Set Filter uses A-5654-S
H 1 : 414.75 (mm)
H 2 : 402 (mm)
OD 1 : 133.5 (mm)
OD 2 : 133.5 (mm)
ID 1 : 105 (mm)
ID 2 : 17 (mm)

CONT : 9
VOL : 0.086

A-5649 Air Filter Primary Metal End Cap Element

CATERPILLAR 3I-0869
KOMATSU 600-3000-110



Secondary Filter uses A-5633
Set Filter uses A-5657-S
H 1 : 425.8 (mm)
H 2 : 413 (mm)
OD 1 : 214 (mm)
OD 2 : 213.5 (mm)
ID 1 : 107 (mm)

CONT : 4
VOL : 0.097

A-5662-S Air Filter Set Metal End Cap Element

KOMATSU 600-181-8600
KOMATSU 600-182-2700
KOMATSU 600-182-3200



Primary Filter uses A-1313
Secondary Filter uses A-1307
H 1 : 457 (mm)
H 2 : 432 (mm)
OD 1 : 232 (mm)
OD 2 : 145 (mm)
ID 1 : 147 (mm)
ID 2 : 23 (mm)

CONT : 4
VOL : 0.123

A-5636 Air Filter Primary Metal End Cap Element

KOMATSU 6675-81-7020
KOMATSU 6675-81-7021



Secondary Filter uses A-5642
Set Filter uses A-5607-S
H 1 : 249.4 (mm)
H 2 : 224 (mm)
OD 1 : 245 (mm)
OD 2 : 245 (mm)
ID 1 : 132 (mm)
ID 2 : 132 (mm)

CONT : 4
VOL : 0.079

Note : Primary A-5636+A-5637

A-5652-S Air Filter Set Metal End Cap Element

KOMATSU 600-181-9450



Primary Filter uses A-7939
Secondary Filter uses A-5647
H 1 : 315.3 (mm)
H 2 : 305 (mm)
OD 1 : 155 (mm)
OD 2 : 191 (mm)
ID 1 : 88 (mm)
ID 2 : 17 (mm)

CONT : 12
VOL : 0.200

A-5663-S Air Filter Set Metal End Cap Element

KOMATSU 600-181-6050



Primary Filter uses A-5627
Secondary Filter uses A-6008
H 1 : 380 (mm)
H 2 : 330 (mm)
OD 1 : 235 (mm)
OD 2 : 187 (mm)
ID 1 : 120 (mm)
ID 2 : 17 (mm)

CONT : 1
VOL : 0.030

Sakura Filter

Technical Specification

A-5666 Air Filter Primary Soft PU end cap Element

KOMATSU 1308462H1
KOMATSU 600-185-4110
JOHN DEERE AT178516



Secondary Filter uses A-5667
Set Filter uses A-5668-S
H 1 : 483 (mm)
H 2 : 470 (mm)
OD 1 : 237 (mm)
OD 2 : 237 (mm)
ID 1 : 132 (mm)

CONT : 1
VOL : 0.031

76

A-56731-S Air Filter Set Soft PU end cap Element

MANITOU 77549+775480



Primary Filter uses A-56731
Secondary Filter uses A-56741
H 1 : 395 (mm)
H 2 : 385 (mm)
OD 1 : 186 (mm)
OD 2 : 184 (mm)
ID 1 : 87 (mm)

CONT : 0
VOL : 0.000

81

A-5715 Air Filter Secondary Metal End Cap Element

CATERPILLAR 1N-4864
CUMMINS 3013213
CATERPILLAR 3I-0215



Primary Filter uses A-5718
Set Filter uses A-5718-S
H 1 : 571.75 (mm)
H 2 : 559 (mm)
OD 1 : 260 (mm)
OD 2 : 260 (mm)
ID 1 : 231.5 (mm)
ID 2 : 23 (mm)

CONT : 1
VOL : 0.047

86

A-5667 Air Filter Secondary Soft PU end cap Element

KOMATSU 1308463H1
CASE 249988A1
KOMATSU 600-185-4120



Primary Filter uses A-5666
Set Filter uses A-5668-S
H 1 : 469 (mm)
H 2 : 463 (mm)
OD 1 : 133.8 (mm)
OD 2 : 125 (mm)
ID 1 : 95.5 (mm)

CONT : 9
VOL : 0.097

77

A-5674 Air Filter Secondary Soft PU end cap Element

KOMATSU 600-185-2520



Primary Filter uses A-5673
Set Filter uses A-5675-S
H 1 : 382 (mm)
H 2 : 377 (mm)
OD 1 : 107.5 (mm)
OD 2 : 101.5 (mm)
ID 1 : 89 (mm)

CONT : 25
VOL : 0.204

82

A-5718 Air Filter Primary Metal End Cap Element

CUMMINS 3013212
CATERPILLAR 3I-0795
HITACHI 4206272



Secondary Filter uses A-5715
Set Filter uses A-5718-S
H 1 : 622.7 (mm)
H 2 : 610 (mm)
OD 1 : 373 (mm)
OD 2 : 373 (mm)
ID 1 : 262.5 (mm)
ID 2 : 23 (mm)

CONT : 1
VOL : 0.102

87

A-5671 Air Filter Secondary Metal End Cap Element

KOMATSU 205-01-K1480



Primary Filter uses AS-5670
Set Filter uses AS-5672-S
H 1 : 416.7 (mm)
H 2 : 407 (mm)
OD 1 : 116.5 (mm)
OD 2 : 116.5 (mm)
ID 1 : 88 (mm)
ID 2 : 17 (mm)

CONT : 25
VOL : 0.193

78

A-56741 Air Filter Secondary Soft PU end cap Element

MANITOU 775480



Primary Filter uses A-56731
Set Filter uses A-56731-S
H 1 : 382.5 (mm)
H 2 : 378 (mm)
OD 1 : 106 (mm)
OD 2 : 100 (mm)
ID 1 : 87 (mm)

CONT : 0
VOL : 0.000

83

A-57240 Air Filter Metal End Cap Element

CASE 346777R91



H 1 : 266.7 (mm)
H 2 : 254 (mm)
OD 1 : 307 (mm)
OD 2 : 307 (mm)
ID 1 : 196 (mm)
ID 2 : 14 (mm)

CONT : 1
VOL : 0.030

Note : Without Gasket Uses A-5704

88

A-5673 Air Filter Primary Soft PU end cap Element

YANMAR 172660-13840
CATERPILLAR 206-5234
KOMATSU 600-185-2510



Secondary Filter uses A-5674
Set Filter uses A-5675-S
H 1 : 392 (mm)
H 2 : 384 (mm)
OD 1 : 186 (mm)
OD 2 : 186 (mm)
ID 1 : 106 (mm)

CONT : 9
VOL : 0.169

79

A-5675-S Air Filter Set Soft PU end cap Element

KOMATSU 600-185-2500



Primary Filter uses A-5673
Secondary Filter uses A-5674
H 1 : 392 (mm)
H 2 : 384 (mm)
OD 1 : 186 (mm)
OD 2 : 186 (mm)
ID 1 : 106 (mm)

CONT : 1
VOL : 0.018

84

A-6003 Air Filter Metal End Cap Element

ISUZU 9-14215026-0
ISUZU 9-14215138-0



H 1 : 141.5 (mm)
H 2 : 122 (mm)
OD 1 : 250 (mm)
OD 2 : 250 (mm)
ID 1 : 144 (mm)
ID 2 : 144 (mm)

CONT : 1
VOL : 0.011

89

A-56731 Air Filter Primary Soft PU end cap Element

MANITOU 775479



Secondary Filter uses A-56741
Set Filter uses A-56731-S
H 1 : 394.5 (mm)
H 2 : 385 (mm)
OD 1 : 186 (mm)
OD 2 : 184 (mm)
ID 1 : 105.5 (mm)

CONT : 1
VOL : 0.000

80

A-5677 Air Filter Metal End Cap Element

MITSUBISHI 32143-08300
KOMATSU 600-181-6340



H 1 : 254 (mm)
OD 1 : 159 (mm)
OD 2 : 130 (mm)
ID 1 : 84 (mm)
ID 2 : 17 (mm)

CONT : 10
VOL : 0.089

Note : A-1029 (Height Difference)

85

A-6008 Air Filter Secondary Metal End Cap Element

ISUZU 1-14215047-0
ISUZU 1-1425-046-1
NISSAN 16546-96010



Primary Filter uses A-5627
Set Filter uses A-5663-S
H 1 : 330 (mm)
OD 1 : 146 (mm)
OD 2 : 116.5 (mm)
ID 1 : 88 (mm)
ID 2 : 17 (mm)

CONT : 9
VOL : 0.083

90

Sakura Filter

Technical Specification

A-6009 Air Filter Secondary Metal End Cap Element



NISSAN 16546-96004
 KOBELCO 2451U180-3B
 KOBELCO 2451U206-3
 KOMATSU 600-181-8360
 ISUZU 9-14215017-0

Primary Filter uses AS-1024
 Set Filter uses AS-1024-S
 H 1 : 397 (mm)
 H 2 : 397 (mm)
 OD 1 : 146.2 (mm)
 OD 2 : 166.5 (mm)
 ID 1 : 88 (mm)
 ID 2 : 17 (mm)

CONT : 9
 VOL : 0.101

A-6207 Air Filter Primary Metal End Cap Element



MERCEDES-BENZ 001 094 42 04
 MERCEDES-BENZ 001 094 52 04
 IVECO 02165049

Secondary Filter uses A-6302
 Set Filter uses A-6207-S
 H 1 : 374.7 (mm)
 H 2 : 362 (mm)
 OD 1 : 197.5 (mm)
 OD 2 : 197.5 (mm)
 ID 1 : 103.5 (mm)
 ID 2 : 9 (mm)

CONT : 9
 VOL : 0.163

A-6809 Air Filter Metal End Cap Element



COMP AIR C 16012/52

H 1 : 240.75 (mm)
 H 2 : 228 (mm)
 OD 1 : 164 (mm)
 OD 2 : 164 (mm)
 ID 1 : 86 (mm)

CONT : 18
 VOL : 0.165

A-6010 Air Filter Primary Metal End Cap Element



ISUZU 1-14215116-0
 ISUZU 1-14215117-0
 ISUZU 1-14215128-0

Secondary Filter uses A-6011
 Set Filter uses A-6010-S
 H 1 : 495.7 (mm)
 H 2 : 483 (mm)
 OD 1 : 307 (mm)
 OD 2 : 307 (mm)
 ID 1 : 196 (mm)
 ID 2 : 23 (mm)

CONT : 1
 VOL : 0.060

A-6211 Air Filter Primary Metal End Cap Element



MERCEDES-BENZ 001 094 46 04
 DEUTZ 2165044

Secondary Filter uses A-6212
 Set Filter uses A-6211-S
 H 1 : 352.7 (mm)
 H 2 : 340 (mm)
 OD 1 : 164 (mm)
 OD 2 : 164 (mm)
 ID 1 : 87 (mm)
 ID 2 : 8.5 (mm)

CONT : 9
 VOL : 0.108

A-7003 Air Filter Primary Soft PU end cap Element



FIAT 1930587
 PERKINS 26510337
 FIAT 366-08109

Secondary Filter uses A-7004
 Set Filter uses A-7003-S
 H 1 : 327.8 (mm)
 H 2 : 319 (mm)
 OD 1 : 138 (mm)
 OD 2 : 138 (mm)
 ID 1 : 81 (mm)

CONT : 1
 VOL : 0.008

A-6011 Air Filter Secondary Metal End Cap Element



ISUZU 1-14215118-0
 ISUZU 1-14215127-0
 ISUZU 14215-127

Primary Filter uses A-6010
 Set Filter uses A-6010-S
 H 1 : 469.7 (mm)
 H 2 : 457 (mm)
 OD 1 : 185 (mm)
 OD 2 : 185 (mm)
 ID 1 : 157.5 (mm)
 ID 2 : 17 (mm)

CONT : 9
 VOL : 0.190

A-6212 Air Filter Secondary Aluminium casting end cap, Element



DEUTZ 2985037
 VOLVO 4765611

Primary Filter uses A-6211

H 1 : 346 (mm)
 OD 1 : 90 (mm)
 OD 2 : 82 (mm)
 ID 1 : 71 (mm)
 ID 2 : 17 (mm)

CONT : 25
 VOL : 0.089

A-7004 Air Filter Secondary Soft PU end cap Element



FIAT 1930588
 PERKINS 26510338

Primary Filter uses A-7003
 Set Filter uses A-7003-S
 H 1 : 319 (mm)
 H 2 : 312 (mm)
 OD 1 : 84 (mm)
 OD 2 : 79 (mm)
 ID 1 : 63 (mm)

CONT : 25
 VOL : 0.082

A-6113 Air Filter Primary Metal End Cap Element



FIAT 01901779
 ISUZU 1-14215046-0
 NISSAN 16546-96017

Secondary Filter uses A-5408
 Set Filter uses A-5653-S
 H 1 : 418.7 (mm)
 H 2 : 406 (mm)
 OD 1 : 282 (mm)
 OD 2 : 282 (mm)
 ID 1 : 171 (mm)
 ID 2 : 17 (mm)

CONT : 1
 VOL : 0.038

A-6302 Air Filter Secondary Metal End Cap Element



MERCEDES-BENZ 002 094 32 04
 DEUTZ 2241329
 HITACHI 5025800

Primary Filter uses A-6207
 Set Filter uses A-6207-S
 H 1 : 373 (mm)
 OD 1 : 110 (mm)
 OD 2 : 99.5 (mm)
 ID 1 : 90.4 (mm)
 ID 2 : 17 (mm)

CONT : 16
 VOL : 0.088

A-7105 Air Filter Secondary Soft PU end cap Element



VOLVO 11110176
 J.C.BAMFORD 32/925405
 KOMATSU 41901H0P09
 LIEBHERR 7623372
 RENAULT 7700050841

Primary Filter uses A-7106
 Set Filter uses A-7107-S
 H 1 : 454 (mm)
 H 2 : 448 (mm)
 OD 1 : 134 (mm)
 OD 2 : 125 (mm)
 ID 1 : 95.5 (mm)

CONT : 25
 VOL : 0.256

A-6201 Air Filter Primary Metal End Cap Element



MERCEDES-BENZ 001 094 82 04
 DEUTZ 2165038

Secondary Filter uses A-5309
 Set Filter uses A-6201-S
 H 1 : 337.7 (mm)
 H 2 : 325 (mm)
 OD 1 : 148 (mm)
 OD 2 : 148 (mm)
 ID 1 : 72 (mm)
 ID 2 : 8.5 (mm)

CONT : 12
 VOL : 0.116

A-6808 Air Filter Primary Metal End Cap Element



RENAULT 00 03 563 577
 MERCEDES-BENZ 001 094 45 04
 CATERPILLAR 060 129 620
 MASSEY-FERGUSON 3 252 002 M 1

Secondary Filter uses A-5114
 Set Filter uses A-6808-S
 H 1 : 294 (mm)
 H 2 : 284 (mm)
 OD 1 : 126 (mm)
 OD 2 : 126 (mm)
 ID 1 : 66 (mm)
 ID 2 : 9 (mm)

CONT : 10
 VOL : 0.071

A-7106 Air Filter Primary Soft PU end cap Element



VOLVO 11110175
 J.C.BAMFORD 32/925404
 RENAULT 7700050840

Secondary Filter uses A-7105
 Set Filter uses A-7107-S
 H 1 : 473 (mm)
 H 2 : 460 (mm)
 OD 1 : 237 (mm)
 OD 2 : 237 (mm)
 ID 1 : 132 (mm)

CONT : 4
 VOL : 0.128

Sakura Filter

Technical Specification

A-71330 Air Filter Breather Hard PU end cap Element



VOLVO 14500233
KOMATSU 207-60-51310
HYUNDAI 31EE-02110
NEW HOLLAND (CNH) 47587350
J.C.BAMFORD KRJ3461

H 1 : 39 (mm)
H 2 : 31.5 (mm)
OD 1 : 54.5 (mm)
OD 2 : 54.5 (mm)
ID 1 : 31 (mm)
ID 2 : 31 (mm)

CONT : 100
VOL : 0.017

A-7610-S Air Filter Set Metal End Cap Element



JOHN DEERE AT35155+AT31227

Primary Filter uses A-7610
Secondary Filter uses A-7608

H 1 : 317.7 (mm)
H 2 : 305 (mm)
OD 1 : 201.5 (mm)
OD 2 : 201.5 (mm)
ID 1 : 135.5 (mm)
ID 2 : 17 (mm)

CONT : 4
VOL : 0.069

A-7631 Air Filter Metal End Cap Element



CUMMINS 4099423
JOHN DEERE AR61967
JOHN DEERE AR79679

H 1 : 435.2 (mm)
H 2 : 425.5 (mm)
OD 1 : 230.6 (mm)
OD 2 : 230.6 (mm)
ID 1 : 133 (mm)
ID 2 : 10 (mm)

CONT : 4
VOL : 0.115

A-71360 Air Filter Primary Soft PU end cap Element



LIEBHERR 10330469
VOLVO 43904168
FORD 6E7Z-9601-AA
JOHN DEERE AT300487

Secondary Filter uses A-71370
Set Filter uses A-71380-S

H 1 : 425 (mm)
OD 1 : 225 (mm)
OD 2 : 225 (mm)
ID 1 : 130 (mm)

CONT : 4
VOL : 0.107

A-7614 Air Filter Secondary Metal End Cap Element



JOHN DEERE AR-85241

Primary Filter uses A-7615
Set Filter uses A-7615-S

H 1 : 442.75 (mm)
H 2 : 430 (mm)
OD 1 : 162.5 (mm)
OD 2 : 163 (mm)
ID 1 : 134 (mm)
ID 2 : 17 (mm)

CONT : 9
VOL : 0.135

A-7632 Air Filter Secondary Metal End Cap Element



KOMATSU 1251529H1
TIMBERJACK 413283
JOHN DEERE AR61968
JOHN DEERE AR79680

Primary Filter uses A-7631
Set Filter uses A-7633-S

H 1 : 360.4 (mm)
H 2 : 355.6 (mm)
OD 1 : 119 (mm)
OD 2 : 119 (mm)
ID 1 : 100 (mm)
ID 2 : 16 (mm)

CONT : 9
VOL : 0.065

A-7605 Air Filter Secondary Metal End Cap Element



CASE 537335R1
FIAT 79022026
JOHN DEERE AL27159

Primary Filter uses AS-7609
Set Filter uses AS-7609-S

H 1 : 280.7 (mm)
H 2 : 279.4 (mm)
OD 1 : 92.5 (mm)
OD 2 : 75 (mm)
ID 1 : 61 (mm)
ID 2 : 17 (mm)

CONT : 25
VOL : 0.089

A-7615 Air Filter Primary Metal End Cap Element



JOHN DEERE AR-85242

Secondary Filter uses A-7614
Set Filter uses A-7615-S

H 1 : 469.75 (mm)
H 2 : 457 (mm)
OD 1 : 276 (mm)
OD 2 : 275 (mm)
ID 1 : 165 (mm)
ID 2 : 23 (mm)

CONT : 1
VOL : 0.045

A-7633-S Air Filter Set Metal End Cap Element



JOHN DEERE AR79679+AR79680

Primary Filter uses A-7631
Secondary Filter uses A-7632

H 1 : 435.2 (mm)
H 2 : 425.5 (mm)
OD 1 : 230.6 (mm)
OD 2 : 230.6 (mm)
ID 1 : 133 (mm)
ID 2 : 10 (mm)

CONT : 4
VOL : 0.115

A-7608 Air Filter Secondary Metal End Cap Element



ISUZU 1-14215031-0
INTERNATIONAL HARVESTER 110571BC1
CATERPILLAR 3I-0187

Primary Filter uses A-2701
Set Filter uses AS-2712-S

H 1 : 285.9 (mm)
H 2 : 279.5 (mm)
OD 1 : 116.5 (mm)
OD 2 : 116.5 (mm)
ID 1 : 88 (mm)
ID 2 : 17 (mm)

CONT : 25
VOL : 0.135

Note : Is a Secondary Air filter for A-2701,A-7610

A-7615-S Air Filter Set Metal End Cap Element



JOHN DEERE AR85242+AR85241

Primary Filter uses A-7615
Secondary Filter uses A-7614

H 1 : 469.75 (mm)
H 2 : 457 (mm)
OD 1 : 276 (mm)
OD 2 : 275 (mm)
ID 1 : 165 (mm)
ID 2 : 23 (mm)

CONT : 1
VOL : 0.045

A-76560 Air Filter Secondary Metal End Cap Element



CATERPILLAR 3I0207
HITACHI 79933226
JOHN DEERE RE45828

Primary Filter uses AS-76550
Set Filter uses AS-76570-S

H 1 : 304.5 (mm)
H 2 : 303 (mm)
OD 1 : 107.5 (mm)
OD 2 : 85.5 (mm)
ID 1 : 73 (mm)
ID 2 : 17 (mm)

CONT : 25
VOL : 0.133

A-7610 Air Filter Primary Metal End Cap Element



JOHN DEERE AT-35155

Secondary Filter uses A-7608
Set Filter uses A-7610-S

H 1 : 317.7 (mm)
H 2 : 305 (mm)
OD 1 : 201.5 (mm)
OD 2 : 201.5 (mm)
ID 1 : 135.5 (mm)
ID 2 : 17 (mm)

CONT : 12
VOL : 0.200

A-7618 Air Filter Secondary Soft PU end cap Element



YANMAR 119233-12700
MITSUBISHI 32143-11400
JOHN DEERE M123378

Primary Filter uses A-8504
Set Filter uses A-7620-S

H 1 : 173 (mm)
H 2 : 168 (mm)
OD 1 : 44 (mm)
OD 2 : 43 (mm)
ID 1 : 32 (mm)

CONT : 50
VOL : 0.027

A-7806 Air Filter Secondary Metal End Cap Element



YANMAR 119131-12520
ISUZU 14215-167
DAEWOO 2474-9014

Primary Filter uses AS-7805
Set Filter uses AS-5656-S

H 1 : 337 (mm)
H 2 : 330 (mm)
OD 1 : 85.5 (mm)
OD 2 : 85.5 (mm)
ID 1 : 57.5 (mm)
ID 2 : 17 (mm)

CONT : 12
VOL : 0.050

Note : Is a secondary Air Filter for AS-7805,AS-7813,A-7805

Sakura Filter

Technical Specification

A-7809 Air Filter Secondary Metal End Cap Element



NISSAN 16546-Z5003
ATLAS COPCO 3216-708202
CATERPILLAR 3I-0069
JOHN DEERE T46317

Primary Filter uses A-7954
Set Filter uses A-7954-S
H 1 : 387.4 (mm)
H 2 : 381 (mm)
OD 1 : 116.5 (mm)
OD 2 : 116.5 (mm)
ID 1 : 88 (mm)
ID 2 : 17 (mm)

CONT : 25
VOL : 0.178

121

A-7919 Air Filter Secondary Metal End Cap Element



INTERNATIONAL HARVESTER
1043327M91
YANMAR 171064-12520
YANMAR 171064-12550

Primary Filter uses AS-5644
Set Filter uses AS-5644-S
H 1 : 253.5 (mm)
H 2 : 253 (mm)
OD 1 : 81 (mm)
OD 2 : 64.5 (mm)
ID 1 : 55 (mm)
ID 2 : 17 (mm)

CONT : 12
VOL : 0.025

126

A-8505 Air Filter Primary Soft PU end cap Element



OPEL 1#123 84 075
OPEL 1-12384075
SUNWARD 730403000155

Secondary Filter uses A-8599
Set Filter uses A-8602-S
H 1 : 312 (mm)
H 2 : 304 (mm)
OD 1 : 127.5 (mm)
OD 2 : 127.5 (mm)
ID 1 : 83 (mm)

CONT : 16
VOL : 0.109

Note : For Flame Retardant version, use A-76410

131

A-7902 Air Filter Secondary Metal End Cap Element

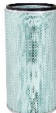

HITACHI 4331920
CATERPILLAR 9Y-7663

Primary Filter uses A-9217
Set Filter uses A-9217-S
H 1 : 563.35 (mm)
H 2 : 550.6 (mm)
OD 1 : 276 (mm)
OD 2 : 276 (mm)
ID 1 : 207.5 (mm)
ID 2 : 22.7 (mm)

CONT : 1
VOL : 0.048

122

A-7939 Air Filter Primary Metal End Cap Element



KOMATSU 600-181-9460
KOMATSU 600-181-9470

Secondary Filter uses A-5647
Set Filter uses A-5652-S
H 1 : 315 (mm)
H 2 : 305.5 (mm)
OD 1 : 155 (mm)
OD 2 : 191 (mm)
ID 1 : 88 (mm)
ID 2 : 17 (mm)

CONT : 12
VOL : 0.175

127

A-8506 Air Filter Primary Soft PU end cap Element



CASE 222425A1
ISUZU 8-97231900-0
JOHN DEERE KV16428

Secondary Filter uses A-8565

H 1 : 330.8 (mm)
H 2 : 322 (mm)
OD 1 : 138 (mm)
OD 2 : 138 (mm)
ID 1 : 81 (mm)

CONT : 12
VOL : 0.099

132

A-7912 Air Filter Primary Metal End Cap Element



HITACHI 408065
CASE 45252
STEIGER 45252
INGERSOLL RAND 506163930

Secondary Filter uses A-7915
Set Filter uses A-7912-S
H 1 : 469.75 (mm)
H 2 : 457 (mm)
OD 1 : 352 (mm)
OD 2 : 352 (mm)
ID 1 : 241 (mm)
ID 2 : 23 (mm)

CONT : 1
VOL : 0.070

123

A-7964 Air Filter Secondary Metal End Cap Element



IVECO 08015449
MASSEY-FERGUSON 1093683M91
FIAT-ALLIS 1909964

Primary Filter uses AS-7988
Set Filter uses AS-7988-S
H 1 : 357 (mm)
H 2 : 355.5 (mm)
OD 1 : 105 (mm)
OD 2 : 85.5 (mm)
ID 1 : 73.5 (mm)
ID 2 : 17 (mm)

CONT : 25
VOL : 0.141

Note : Is a Secondary Air filter for AS-7988,AS-7813,AS-7805,AS-4304

128

A-8506-S Air Filter Set Soft PU end cap Element



CASE 222425A1+222429A1
JOHN DEERE KV16428+AP33331

Primary Filter uses A-8506
Secondary Filter uses A-8565
H 1 : 330.8 (mm)
H 2 : 322 (mm)
OD 1 : 138 (mm)
OD 2 : 138 (mm)
ID 1 : 81 (mm)

CONT : 12
VOL : 0.099

133

A-7912-S Air Filter Set Metal End Cap Element



VOLVO 4881174 + 4881175
EUCLID 9035992+9035993

Primary Filter uses A-7912
Secondary Filter uses A-7915
H 1 : 469.75 (mm)
H 2 : 457 (mm)
OD 1 : 352 (mm)
OD 2 : 352 (mm)
ID 1 : 241 (mm)
ID 2 : 23 (mm)

CONT : 1
VOL : 0.070

124

A-82010 Air Filter Breather Hard PU end cap Element



KOMATSU 421-60-35170

H 1 : 32.5 (mm)
H 2 : 31 (mm)
OD 1 : 55 (mm)
OD 2 : 55 (mm)
ID 1 : 22 (mm)
ID 2 : 26 (mm)

CONT : 100
VOL : 0.014

129

A-8513 Air Filter Primary Soft PU end cap Element



YANMAR 119808-12520
NISSAN 16546-FJ100
KOMATSU 3EB-02-38730
SUNWARD 730403000157

Secondary Filter uses A-5569
Set Filter uses A-5570-S
H 1 : 273.5 (mm)
H 2 : 265 (mm)
OD 1 : 104 (mm)
OD 2 : 104 (mm)
ID 1 : 61 (mm)

CONT : 25
VOL : 0.110

Note : A-85134(with Flame Retardant Media)

134

A-7915 Air Filter Secondary Metal End Cap Element



CATERPILLAR 1N-8164
CATERPILLAR 4N-9164
INGERSOLL RAND 50616408

Primary Filter uses A-7912
Set Filter uses A-7912-S
H 1 : 432.7 (mm)
H 2 : 423 (mm)
OD 1 : 220 (mm)
OD 2 : 220 (mm)
ID 1 : 179 (mm)
ID 2 : 23 (mm)

CONT : 4
VOL : 0.104

125

A-8504 Air Filter Primary Soft PU end cap Element



YANMAR 119655-12560
KOMATSU 11965512560
KUBOTA 1G659-11220

Secondary Filter uses A-7618
Set Filter uses A-7620-S
H 1 : 187 (mm)
H 2 : 179 (mm)
OD 1 : 88.5 (mm)
OD 2 : 88.5 (mm)
ID 1 : 46 (mm)

CONT : 25
VOL : 0.055

130

A-8521 Air Filter Primary Metal End Cap Element



INTERNATIONAL HARVESTER
1298058HI
JOHN DEERE AR82915

Secondary Filter uses A-8522
Set Filter uses A-8521-S
H 1 : 504.7 (mm)
H 2 : 492 (mm)
OD 1 : 230 (mm)
OD 2 : 230 (mm)
ID 1 : 121 (mm)
ID 2 : 10 (mm)

CONT : 4
VOL : 0.134

135

Sakura Filter

Technical Specification

A-8521-S Air Filter Set Metal End Cap Element

INTERNATIONAL HARVESTER
1298058HI+1298059HI



Primary Filter uses A-8521
Secondary Filter uses A-8522
H 1 : 504.7 (mm)
H 2 : 492 (mm)
OD 1 : 230 (mm)
OD 2 : 230 (mm)
ID 1 : 121 (mm)
ID 2 : 10 (mm)

CONT : 4
VOL : 0.134

136

A-8568 Air Filter Metal End Cap Element

KUBOTA 121422-12570
YANMAR 121422-12570
KUBOTA 15287-11490
CASE 167817A1
HITACHI 4311871



H 1 : 232 (mm)
H 2 : 228.5 (mm)
OD 1 : 62.5 (mm)
OD 2 : 62.5 (mm)
ID 1 : 49 (mm)
ID 2 : 17 (mm)

CONT : 25
VOL : 0.038

141

A-8580 Air Filter Secondary Soft PU end cap Element

CATERPILLAR 142-1403
ATLAS COPCO 3222-1881-92
HITACHI 4466268



Primary Filter uses A-8579
Set Filter uses A-8579-S
H 1 : 500 (mm)
H 2 : 494 (mm)
OD 1 : 179 (mm)
OD 2 : 174 (mm)
ID 1 : 148 (mm)

CONT : 1
VOL : 0.019

Note : Is a Secondary Air filter of A-8579M,A-8665M

146

A-8522 Air Filter Secondary Metal End Cap Element

INTERNATIONAL HARVESTER
1298059HI
JOHN DEERE AR81313



Primary Filter uses A-8521
Set Filter uses A-8521-S
H 1 : 425.4 (mm)
H 2 : 419 (mm)
OD 1 : 119 (mm)
OD 2 : 119 (mm)
ID 1 : 100 (mm)
ID 2 : 16 (mm)

CONT : 9
VOL : 0.074

137

A-8577 Air Filter Primary Soft PU end cap Element

PERKINS 26510353
J.C.BAMFORD 32/912901
KOMATSU 42X01H0P02



Secondary Filter uses A-8578
Set Filter uses A-8577-S
H 1 : 423 (mm)
H 2 : 410 (mm)
OD 1 : 207 (mm)
OD 2 : 207 (mm)
ID 1 : 106.5 (mm)

CONT : 1
VOL : 0.021

142

A-8599 Air Filter Secondary Soft PU end cap Element

KUBOTA 119005-12571
CASE 133721A1
HITACHI 4326841



Primary Filter uses A-8505
Set Filter uses A-8602-S
H 1 : 303.5 (mm)
H 2 : 298 (mm)
OD 1 : 83 (mm)
OD 2 : 79 (mm)
ID 1 : 64 (mm)

CONT : 25
VOL : 0.076

Note : Is a Secondary Air filter for A-5669,A-8505

147

A-85370 Air Filter Hard PU end cap Element inside-out flow

CASE 327491R91
FIAT 70634446
CLARK 946092
FARR P24



H 1 : 205 (mm)
Length 1 : 381 (mm)
Width 1 : 267 (mm)

CONT : 1
VOL : 0.026

Note : 24 tubes-4x6

138

A-8578 Air Filter Secondary Soft PU end cap Element

J.C.BAMFORD 32/912902
KOMATSU 42X01H0P01
KOMATSU 600-185-3120



Primary Filter uses A-8577
Set Filter uses A-8577-S
H 1 : 407.5 (mm)
H 2 : 401 (mm)
OD 1 : 107 (mm)
OD 2 : 100 (mm)
ID 1 : 87 (mm)

CONT : 25
VOL : 0.193

143

A-8624 Air Filter Primary Soft PU end cap Element

FIAT-AGRI 1930587
MANITOU 227959



Secondary Filter uses A-8625
Set Filter uses A-8626-S
H 1 : 321 (mm)
H 2 : 312 (mm)
OD 1 : 138 (mm)
OD 2 : 138 (mm)
ID 1 : 81 (mm)

CONT : 16
VOL : 0.128

148

A-85400 Air Filter Hard PU end cap Element inside-out flow

FIAT-ALLIS 70185824
CLARK 945755
FARR P48



H 1 : 205 (mm)
Length 1 : 502 (mm)
Width 1 : 385 (mm)

CONT : 1
VOL : 0.051

Note : 48 Tubes--6 x 8

139

A-8579M Air Filter Primary Soft PU+Metal Element

CATERPILLAR 142-1340
FIAT 4466269
KOMATSU 600-185-6110
HITACHI 76612497



Secondary Filter uses A-8580
Set Filter uses A-8579M-S
H 1 : 521 (mm)
H 2 : 510 (mm)
OD 1 : 313 (mm)
OD 2 : 313 (mm)
ID 1 : 178 (mm)

CONT : 1
VOL : 0.062

Note : Set Filter Uses A-8579-S(SOFT PU)

144

A-8665M Air Filter Primary Soft PU+Metal Element

SCANIA 1387548



Secondary Filter uses A-83090
Set Filter uses A-86651M-S
H 1 : 544 (mm)
H 2 : 515 (mm)
OD 1 : 308 (mm)
OD 2 : 308 (mm)
ID 1 : 177.5 (mm)

CONT : 1
VOL : 0.060

Note : Is a Primary Air Filter of A-83090,A-8580

149

A-8545 Air Filter Metal End Cap Element

ATLAS COPCO 1030-0979-000
INTERNATIONAL HARVESTER
346779 R1
INTERNATIONAL HARVESTER
346779 R91



H 1 : 368.2 (mm)
H 2 : 355.5 (mm)
OD 1 : 352 (mm)
OD 2 : 352 (mm)
ID 1 : 241 (mm)
ID 2 : 13.5 (mm)

CONT : 1
VOL : 0.056

Note : without gaskets version uses A-6702

140

A-8579M-S Air Filter Set Soft PU+Metal Element

CATERPILLAR 142-1340+142-1403
KOMATSU
600-185-6110+600-185-6120



Primary Filter uses A-8579M
Secondary Filter uses A-8580
H 1 : 521 (mm)
H 2 : 510 (mm)
OD 1 : 313 (mm)
OD 2 : 313 (mm)
ID 1 : 178 (mm)

CONT : 1
VOL : 0.062

145

A-8670 Air Filter Secondary Soft PU end cap Element

CASE 187472A1
CASE 187472A2
MASSEY-FERGUSON 4270036M1
NEW HOLLAND (CNH) 8602996



Primary Filter uses A-8671
Set Filter uses A-8672-S
H 1 : 385 (mm)
H 2 : 380 (mm)
OD 1 : 107.5 (mm)
OD 2 : 101.5 (mm)
ID 1 : 89 (mm)

CONT : 25
VOL : 0.152

150

Sakura Filter

Technical Specification

A-92040 Air Filter Breather Metal End Cap Element

KOMATSU 20Y-60-21410
KAWASAKI 30981-70330
HYUNDAI 31EH-00480



H 1 : 33 (mm)
H 2 : 26 (mm)
OD 1 : 73 (mm)
OD 2 : 73 (mm)
ID 1 : 45 (mm)
ID 2 : 45 (mm)

CONT : 100
VOL : 0.025

Note : for Kawasaki Wheel Loader 70IV-2

A-9218-S Air Filter Set Metal End Cap Element

KOMATSU
581-02-12120+581-02-12130
EUCLID 9059562+9038349



Primary Filter uses A-9218
Secondary Filter uses A-9205
H 1 : 596.75 (mm)
H 2 : 584 (mm)
OD 1 : 446.5 (mm)
OD 2 : 468 (mm)
ID 1 : 310 (mm)
ID 2 : 23 (mm)

CONT : 1
VOL : 0.148

AS-1024 Air Filter Primary Metal End Cap Element With Sleeve

NISSAN 16546-96003
NISSAN 16546-96015
NISSAN 16546-96026



Secondary Filter uses A-6009
Set Filter uses AS-1024-S
H 1 : 418.7 (mm)
H 2 : 406 (mm)
OD 1 : 254 (mm)
OD 2 : 201.5 (mm)
ID 1 : 135.5 (mm)
ID 2 : 17 (mm)

CONT : 1
VOL : 0.031

A-9205 Air Filter Secondary Metal End Cap Element

CATERPILLAR 3I-0105
KOMATSU 581-02-12130
EUCLID 9038349



Primary Filter uses A-9218
Set Filter uses A-9218-S
H 1 : 571.75 (mm)
H 2 : 559 (mm)
OD 1 : 301.5 (mm)
OD 2 : 301.5 (mm)
ID 1 : 260.5 (mm)
ID 2 : 23 (mm)

CONT : 1
VOL : 0.063

A-9219 Air Filter Primary Metal End Cap Element

CATERPILLAR 3I-0801
EUCLID 542380
TEREX 9059570



Secondary Filter uses A-7966
Set Filter uses A-9219-S
H 1 : 495.7 (mm)
H 2 : 483 (mm)
OD 1 : 447.5 (mm)
OD 2 : 468 (mm)
ID 1 : 309 (mm)
ID 2 : 23 (mm)

CONT : 1
VOL : 0.122

AS-1024-S Air Filter Set Metal End Cap Element With Sleeve

FIAT 1930751+1930790
KOMATSU 6131-82-7011
FIAT 70684732+1930790
JOHN DEERE T46316+T46317



Primary Filter uses AS-1024
Secondary Filter uses A-6009
H 1 : 418.7 (mm)
H 2 : 406 (mm)
OD 1 : 254 (mm)
OD 2 : 201.5 (mm)
ID 1 : 135.5 (mm)
ID 2 : 17 (mm)

CONT : 1
VOL : 0.031

A-9217 Air Filter Primary Metal End Cap Element

CATERPILLAR 3I-0791
EUCLID 6945659



Secondary Filter uses A-7902
Set Filter uses A-9217-S
H 1 : 597.75 (mm)
H 2 : 585 (mm)
OD 1 : 447 (mm)
OD 2 : 468 (mm)
ID 1 : 281 (mm)
ID 2 : 23 (mm)

CONT : 1
VOL : 0.152

A-9219-S Air Filter Set Metal End Cap Element

EUCLID 9039992+9059570



Primary Filter uses A-9219
Secondary Filter uses A-7966
H 1 : 495.7 (mm)
H 2 : 483 (mm)
OD 1 : 447.5 (mm)
OD 2 : 468 (mm)
ID 1 : 309 (mm)
ID 2 : 23 (mm)

CONT : 1
VOL : 0.122

AS-1824 Air Filter Metal End Cap Element With Sleeve

YANMAR 129350-12900
ISEKI 1480-104-2070-0
NISSAN 16546-00H10



H 1 : 200 (mm)
H 2 : 190 (mm)
OD 1 : 131.5 (mm)
OD 2 : 104 (mm)
ID 1 : 63 (mm)
ID 2 : 17 (mm)

CONT : 16
VOL : 0.079

A-9217-S Air Filter Set Metal End Cap Element

EUCLID 6945659+6945658



Primary Filter uses A-9217
Secondary Filter uses A-7902
H 1 : 597.75 (mm)
H 2 : 585 (mm)
OD 1 : 447 (mm)
OD 2 : 468 (mm)
ID 1 : 281 (mm)
ID 2 : 23 (mm)

CONT : 1
VOL : 0.148

AS-1010 Air Filter Metal End Cap Element With Sleeve

ISUZU 14215-132
CUMMINS 158876
NISSAN 16546-Z5001



H 1 : 266.7 (mm)
H 2 : 254 (mm)
OD 1 : 257 (mm)
OD 2 : 201.5 (mm)
ID 1 : 90.5 (mm)
ID 2 : 14 (mm)

CONT : 1
VOL : 0.021

Note : INN.DIAM=91/17MM Version Uses AS-1025,
INN.DIAM 116/13.5MM Version Uses AS-1037

AS-2205 Air Filter Primary Metal End Cap Element With Sleeve

ISUZU 1-14215014-0
YANMAR 121120-12901
KUBOTA 121420-12511



Secondary Filter uses A-8568
Set Filter uses AS-2206-S
H 1 : 264 (mm)
H 2 : 254 (mm)
OD 1 : 132 (mm)
OD 2 : 104 (mm)
ID 1 : 63 (mm)
ID 2 : 17 (mm)

CONT : 12
VOL : 0.073

A-9218 Air Filter Primary Metal End Cap Element

CATERPILLAR 1W-3637
CATERPILLAR 3I-0793
KOMATSU 581-02-12120
EUCLID 9059562



Secondary Filter uses A-9205
Set Filter uses A-9218-S
H 1 : 596.75 (mm)
H 2 : 584 (mm)
OD 1 : 446.5 (mm)
OD 2 : 468 (mm)
ID 1 : 310 (mm)
ID 2 : 23 (mm)

CONT : 1
VOL : 0.148

AS-1014 Air Filter Primary Metal End Cap Element With Sleeve

ISUZU 1-14215135-0
TOYOTA 1001905
YANMAR 171064-12540



Secondary Filter uses A-7919
Set Filter uses AS-1014-S
H 1 : 288 (mm)
H 2 : 279 (mm)
OD 1 : 160 (mm)
OD 2 : 134 (mm)
ID 1 : 66.5 (mm)
ID 2 : 17 (mm)

CONT : 9
VOL : 0.090

AS-5412 Air Filter Metal End Cap Element With Sleeve

YANMAR 124066-12510
ISEKI 1427-101-2840-0
KUBOTA 15221-11223



H 1 : 184.4 (mm)
H 2 : 178 (mm)
OD 1 : 109.4 (mm)
OD 2 : 83 (mm)
ID 1 : 45 (mm)
ID 2 : 15.3 (mm)

CONT : 25
VOL : 0.079

Sakura Filter

Technical Specification

AS-5620 Air Filter Primary Metal End Cap Element With Sleeve
KOMATSU 600-181-7300



Secondary Filter uses A-5621
Set Filter uses AS-5620-S
H 1 : 290 (mm)
H 2 : 280.5 (mm)
OD 1 : 160 (mm)
OD 2 : 134 (mm)
ID 1 : 87 (mm)
ID 2 : 17 (mm)

CONT : 9
VOL : 0.090

166

AS-5644-S Air Filter Set Metal End Cap Element With Sleeve
KOMATSU 3EC-01-11630(SET)



Primary Filter uses AS-5644
Secondary Filter uses A-7919
H 1 : 288 (mm)
H 2 : 279 (mm)
OD 1 : 160 (mm)
OD 2 : 181.5 (mm)
ID 1 : 66.5 (mm)
ID 2 : 17 (mm)

CONT : 12
VOL : 0.163

171

AS-7609 Air Filter Primary Metal End Cap Element With Sleeve
CATERPILLAR 3I-0228
FIAT 79022025



Secondary Filter uses A-7605
Set Filter uses AS-7609-S
H 1 : 315.9 (mm)
H 2 : 305 (mm)
OD 1 : 160 (mm)
OD 2 : 133.5 (mm)
ID 1 : 82 (mm)
ID 2 : 17 (mm)

CONT : 9
VOL : 0.110

176

AS-5628 Air Filter Primary Metal End Cap Element With Sleeve
MAZDA 0727-23-603
ISUZU 1-14215028-0
ISUZU 1-14215032-0



Secondary Filter uses A-7611
Set Filter uses AS-5628-S
H 1 : 311 (mm)
H 2 : 305 (mm)
OD 1 : 199.3 (mm)
OD 2 : 155 (mm)
ID 1 : 88 (mm)
ID 2 : 17 (mm)

CONT : 12
VOL : 0.194

167

AS-5670 Air Filter Primary Metal End Cap Element With Sleeve
KOMATSU 205-01-73570
KOMATSU 205-01-73750



Secondary Filter uses A-5671
Set Filter uses AS-5672-S
H 1 : 452.75 (mm)
H 2 : 440 (mm)
OD 1 : 278.5 (mm)
OD 2 : 201.5 (mm)
ID 1 : 135 (mm)

CONT : 1
VOL : 0.040

172

AS-7805 Air Filter Primary Metal End Cap Element With Sleeve
IVECO 08014390
MASSEY-FERGUSON 1093682M91
ISUZU 14215-166



Secondary Filter uses A-7806
Set Filter uses AS-5656-S
H 1 : 392 (mm)
H 2 : 381 (mm)
OD 1 : 199 (mm)
OD 2 : 155 (mm)
ID 1 : 88 (mm)
ID 2 : 17 (mm)
Gasket Type : Square

CONT : 9
VOL : 0.169

Note : Long Life Versions Uses AS-7813

177

AS-5643 Air Filter Primary Metal End Cap Element With Sleeve
KOMATSU 37Z-02-AF934A
KOMATSU 3EA-01-18130
HITACHI 4294846



Secondary Filter uses A-8568
Set Filter uses AS-5643-S
H 1 : 263.7 (mm)
H 2 : 251 (mm)
OD 1 : 131.5 (mm)
OD 2 : 148 (mm)
ID 1 : 63 (mm)
ID 2 : 17 (mm)

CONT : 16
VOL : 0.121

168

AS-5672-S Air Filter Set Metal End Cap Element With Sleeve
KOMATSU
205-01-73570+205-01-K1480



Primary Filter uses AS-5670
Secondary Filter uses A-5671
H 1 : 440 (mm)
H 2 : 407 (mm)
OD 1 : 278.5 (mm)
OD 2 : 201.5 (mm)
ID 1 : 135 (mm)

CONT : 1
VOL : 0.040

173

AS-7988 Air Filter Primary Metal End Cap Element With Sleeve
YANMAR 119131-12530
FIAT-ALLIS 1930765
KOMATSU 203-01-K1130



Secondary Filter uses A-7964
Set Filter uses AS-7988-S
H 1 : 393.75 (mm)
H 2 : 381 (mm)
OD 1 : 200 (mm)
OD 2 : 216.5 (mm)
ID 1 : 88 (mm)
ID 2 : 17 (mm)

CONT : 4
VOL : 0.091

178

AS-5643-S Air Filter Set Metal End Cap Element With Sleeve
CASE 167815A1+167817A1
KOMATSU
3EA-01-18130+3EB-02-19840
HITACHI 4294846+4311871
J.C.BAMFORD KAP0482+KAP0727



Primary Filter uses AS-5643
Secondary Filter uses A-8568
H 1 : 263.7 (mm)
H 2 : 251 (mm)
OD 1 : 131.5 (mm)
OD 2 : 148 (mm)
ID 1 : 63 (mm)
ID 2 : 17 (mm)

CONT : 16
VOL : 0.121

169

AS-5706 Air Filter Metal End Cap Element With Sleeve
CUMMINS 158879
NISSAN 16546-90112
CUMMINS 299346



H 1 : 368.25 (mm)
H 2 : 355.5 (mm)
OD 1 : 402.6 (mm)
OD 2 : 307.2 (mm)
ID 1 : 196 (mm)
ID 2 : 13.5 (mm)

CONT : 1
VOL : 0.070

174

AS-8502 Air Filter Primary Metal End Cap Element With Sleeve
FURUKAWA 1129111C1



Secondary Filter uses A-5437
Set Filter uses AS-8502-S
H 1 : 392 (mm)
H 2 : 381 (mm)
OD 1 : 225 (mm)
OD 2 : 174 (mm)
ID 1 : 107.5 (mm)
ID 2 : 17 (mm)

CONT : 4
VOL : 0.107

179

AS-5644 Air Filter Primary Metal End Cap Element With Sleeve
YANMAR 119005-12510
KOBELCO 2446U271S2
MITSUBISHI 32A3005300



Secondary Filter uses A-7919
Set Filter uses AS-5644-S
H 1 : 288 (mm)
H 2 : 279 (mm)
OD 1 : 160 (mm)
OD 2 : 181.5 (mm)
ID 1 : 66.5 (mm)
ID 2 : 17 (mm)

CONT : 12
VOL : 0.154

170

AS-5707 Air Filter Metal End Cap Element With Sleeve
CUMMINS 158871
CUMMINS 158878
NISSAN 16546-M0800



H 1 : 317.7 (mm)
H 2 : 305 (mm)
OD 1 : 352 (mm)
OD 2 : 282 (mm)
ID 1 : 171 (mm)
ID 2 : 13.5 (mm)

CONT : 1
VOL : 0.046

175

AS-8502-S Air Filter Set Metal End Cap Element With Sleeve
FURUKAWA 1129111C1+1129112C1



Primary Filter uses AS-8502
Secondary Filter uses A-5437
H 1 : 392 (mm)
H 2 : 381 (mm)
OD 1 : 225 (mm)
OD 2 : 174 (mm)
ID 1 : 107.5 (mm)
ID 2 : 17 (mm)

CONT : 4
VOL : 0.101

180

Sakura Filter

Technical Specification

AS-8801 Air Filter Primary Metal End Cap Element With Sleeve

YANMAR 119860-12510
KUBOTA 15852-11011
KUBOTA 15852-11080



H 1 : 185 (mm)
H 2 : 177 (mm)
OD 1 : 83 (mm)
OD 2 : 128.5 (mm)
ID 1 : 45 (mm)
ID 2 : 9 (mm)

CONT : 12
VOL : 0.052

181

C-1720 Oil Filter Full Flow Spin-On

TCM 12163-82302
YANMAR 129150-35152



H 1 : 100 (mm)
OD 1 : 90 (mm)
Thread Size : M20X1.5-6H
BPV (kg/cm2) : 1.0
ADBV : YES
Gasket Type : Round

CONT : 36
VOL : 0.040

186

C-1834 Oil Filter Full Flow Spin-On

NISSAN 15208-W3401



H 1 : 130 (mm)
OD 1 : 93 (mm)
Thread Size : 3/4-16 UNF-2B
Gasket Type : Square

CONT : 36
VOL : 0.051

Note : Round Version Uses C-1803

191

C-1011 Oil Filter Full Flow Spin-On

NISSAN 15208-HC400
HINO 15607-1920
MAZDA JEYO-14-302



H 1 : 85 (mm)
OD 1 : 68 (mm)
Thread Size : M20X1.5-6H
BPV (kg/cm2) : 1.0
ADBV : YES
Gasket Type : Round

CONT : 50
VOL : 0.026

Note : Square version uses C-1030

182

C-1803 Oil Filter Full Flow Spin-On

NISSAN 15208-65010
NISSAN 15208-65011
NISSAN 15208-65014



H 1 : 129 (mm)
OD 1 : 93 (mm)
Thread Size : 3/4-16 UNF-2B
ADBV : YES
Gasket Type : Round

CONT : 50
VOL : 0.073

Note : Square Version Uses C-1834

187

C-1914 Oil Filter Full Flow Spin-On

ALLIS CHALMERS 0230578-1
ALFA ROMEO 119003206101
GENERAL MOTORS 7984303



H 1 : 140 (mm)
OD 1 : 93 (mm)
Thread Size : 3/4-16 UNF-2B
BPV (kg/cm2) : 1.0
ADBV : YES
Gasket Type : Square

CONT : 12
VOL : 0.022

192

C-1122 Oil Filter Full Flow Spin-On

TOYOTA 00120-00005
TOYOTA 00120-00007
VW GROUP 021 115 351A
PORSCHE 021.115.351
PORSCHE 021.115.351A



H 1 : 95 (mm)
OD 1 : 93 (mm)
Thread Size : 3/4-16 UNF-2B
BPV (kg/cm2) : 1.0
ADBV : YES
Gasket Type : Square

CONT : 12
VOL : 0.014

183

C-1807 Oil Filter Full Flow Spin-On

NISSAN 15209-76200
NISSAN 15209-76201
NISSAN 15209-C8600



H 1 : 174 (mm)
OD 1 : 93 (mm)
Thread Size : 1-12 UNF-2B
ADBV : YES
Gasket Type : Round

CONT : 12
VOL : 0.023

Note : Square version uses C-1837

188

C-1920 Oil Filter Full Flow Spin-On

MAZDA 0000-23-8173
MAZDA 0813-23-802
MAZDA 0839-14-300
MAZDA 0866-23-803
NISSAN 152087B000



H 1 : 120 (mm)
OD 1 : 76 (mm)
Thread Size : M20X1.5-6H
BPV (kg/cm2) : 1.0
ADBV : YES
Gasket Type : Square

CONT : 50
VOL : 0.043

193

C-1140 Oil Filter Full Flow Spin-On

TOYOTA 90915-03004
TOYOTA 90915-10002
TOYOTA 90915-YZZE2



H 1 : 85 (mm)
OD 1 : 65 (mm)
Thread Size : 3/4-16 UNF-2B
BPV (kg/cm2) : 1.0
ADBV : YES
Gasket Type : Round

CONT : 50
VOL : 0.027

184

C-1828 Oil Filter Full Flow Spin-On

FORDFINISCODE 5007124



H 1 : 120 (mm)
OD 1 : 76 (mm)
Thread Size : 3/4-16 UNF-2B
BPV (kg/cm2) : 1.4 - 1.6
ADBV : YES
Gasket Type : Square

CONT : 50
VOL : 0.043

189

C-2302 Oil Filter Full Flow Spin-On

FORD 000-6731G
CHRYSLER 2196909
AMERICAN MOTORS 3157847
AMERICAN MOTORS 3177601
AMERICAN MOTORS 3177757



H 1 : 130 (mm)
OD 1 : 93 (mm)
Thread Size : 13/16-16 UNF-2B
Gasket Type : Square

CONT : 36
VOL : 0.051

Note : Supersedes C-8002

194

C-1305 Oil Filter Full Flow Spin-On

ISUZU 1-13240046-1
ISUZU 1-13240061-0
ISUZU 1-13240075-0



H 1 : 199 (mm)
OD 1 : 110 (mm)
Thread Size : 1 1/2-12 UNF-2B
Gasket Type : Square

CONT : 12
VOL : 0.036

Note : Without Nut

185

C-1829 Oil Filter Full Flow Spin-On

GENERAL MOTORS 12339994
NISSAN 13210-13211
NISSAN 13212-13213
NISSAN 15208-01B15
NISSAN 15208-55Y00



H 1 : 105 (mm)
OD 1 : 76 (mm)
Thread Size : 3/4-16 UNF-2B
ADBV : YES
Gasket Type : Square

CONT : 50
VOL : 0.038

190

C-5102 Oil Filter Full Flow Spin-On

PERKINS 26540347
PERKINS 2654407



H 1 : 168 (mm)
OD 1 : 93 (mm)
Thread Size : 3/4-16 UNF-2B
BPV (kg/cm2) : 1.0
ADBV : YES
Gasket Type : Square

CONT : 25
VOL : 0.050

195

Sakura Filter

Technical Specification

C-5204 Oil Filter Full Flow Spin-On

YANMAR 119005-35100
YANMAR 16271-32091
YANMAR Y119005-35100



H 1 : 100 (mm)
OD 1 : 80 (mm)
Thread Size : M20X1.5-6H
BPV (kg/cm2) : 1.0
ADBV : YES
Gasket Type : Round

CONT : 50
VOL : 0.045

196

C-5516 Oil Filter Full Flow Spin-On

CATERPILLAR 1R-0716



H 1 : 286 (mm)
OD 1 : 118 (mm)
Thread Size : 1 1/2-16 UN-2B
Gasket Type : Square

CONT : 6
VOL : 0.036

201

C-5608 Oil Filter Full Flow Spin-On

KOMATSU 6134-51-5120
KOMATSU 6134-51-5121



H 1 : 171 (mm)
OD 1 : 108 (mm)
Thread Size : 1 1/8-16 UNF-2B
ADBV : YES
Gasket Type : Square

CONT : 12
VOL : 0.034

206

C-5205 Oil Filter Full Flow Spin-On

YANMAR 119305-35151



H 1 : 65 (mm)
OD 1 : 65 (mm)
Thread Size : M20X1.5-6H
BPV (kg/cm2) : 1.0
ADBV : YES
Gasket Type : Round

CONT : 50
VOL : 0.021

197

C-5523 Oil Filter Full Flow Spin-On With Microfiber media

CATERPILLAR 2P-4005



H 1 : 304 (mm)
OD 1 : 136 (mm)
Thread Size : 1 1/2-16 UN-2B
Gasket Type : Square

CONT : 6
VOL : 0.050

202

C-5610 Oil Filter Full Flow Spin-On Cellulose media

DAEWOO 65055105028
KOMATSU 6736-51-5141



H 1 : 174.4 (mm)
OD 1 : 93 (mm)
Thread Size : 1-16 UNF-2B
ADBV : YES
Gasket Type : Square

CONT : 12
VOL : 0.027

Note : C-5610 cellulose media,C-5611 syntetic media

207

C-5402 Oil Filter Full Flow Spin-On

INTERNATIONAL HARVESTER 684206 C1
INTERNATIONAL HARVESTER 684206 C2



H 1 : 246 (mm)
OD 1 : 136 (mm)
Thread Size : 1 1/2-16 UN-2B
Gasket Type : Square

CONT : 6
VOL : 0.041

198

C-5604 Oil Filter Full Flow Spin-On

KOMATSU 600-211-6240
KOMATSU 600-211-6241



H 1 : 98 (mm)
OD 1 : 93 (mm)
Thread Size : 1-12 UNF-2B
BPV (kg/cm2) : 1.0
ADBV : YES
Gasket Type : Round

CONT : 12
VOL : 0.016

Note : Square Type Height 84 MM Used With C-5615,Round Type Height 84 MM Uses C-5616

203

C-5611 Oil Filter Full Flow Spin-On Synthetic Media

CUMMINS 3977910
KOMATSU 6736-51-5142



H 1 : 174.4 (mm)
OD 1 : 93 (mm)
Thread Size : 1-16 UNF-2B
ADBV : YES
Gasket Type : Square

CONT : 12
VOL : 0.027

Note : C-5610 cellulose media,C-5611 syntetic media

208

C-5405 Oil Filter Full Flow Spin-On

INTERNATIONAL HARVESTER 3136046R93
MC CORMICK (LANDINI-ARGO) MC3136046R93



H 1 : 108 (mm)
OD 1 : 93 (mm)
Thread Size : 1-12 UNF-2B
BPV (kg/cm2) : 1.0
Gasket Type : Square

CONT : 24
VOL : 0.029

199

C-5605 Oil Filter Full Flow Spin-On

MITSUBISHI 32540-01601
MITSUBISHI 37438-02700
MITSUBISHI 37540-01101



H 1 : 262 (mm)
OD 1 : 108 (mm)
Thread Size : 1 1/2-12 UNF-2B
Gasket Type : Square

CONT : 10
VOL : 0.039

204

C-5614 Oil Filter Full Flow Spin-On

MITSUBISHI 32540-21600
KOMATSU 6136-51-5120
KOMATSU 6136-51-5121



H 1 : 171 (mm)
OD 1 : 108 (mm)
Thread Size : 1 1/8-16 UNF-2B
BPV (kg/cm2) : 2.0
Gasket Type : Square

CONT : 12
VOL : 0.035

209

C-5505 Oil Filter Full Flow Spin-On

CATERPILLAR 1R-0714
HITACHI 4429728
FIAT 71455273
MITSUBISHI ME034878
MITSUBISHI ME088519



H 1 : 162 (mm)
OD 1 : 108 (mm)
Thread Size : 1 1/8-16 UNF-2B
Gasket Type : Square

CONT : 12
VOL : 0.034

200

C-5606 Oil Filter Full Flow Spin-On

KOMATSU 600-211-5242



H 1 : 130 (mm)
OD 1 : 93 (mm)
Thread Size : 1-12 UNF-2B
ADBV : YES
Gasket Type : Square

CONT : 12
VOL : 0.021

205

C-5615 Oil Filter Full Flow Spin-On

KOMATSU 600-211-6242



H 1 : 84 (mm)
OD 1 : 93 (mm)
Thread Size : 1-12 UNF-2B
ADBV : YES
Gasket Type : Square

CONT : 12
VOL : 0.015

Note : Round Type Used With C-5604

210

Sakura Filter

Technical Specification

C-5616 Oil Filter Full Flow Spin-On
KOMATSU 600-211-6242



H 1 : 84 (mm)
OD 1 : 93 (mm)
Thread Size : 1-12 UNF-2B
BPV (kg/cm2) : 1.0
ADBV : YES
Gasket Type : Round

CONT : 36
VOL : 0.039

Note : C-5604 (Height difference)

C-5707 Oil Filter Combination Spin-On Seamless
J.C.BAMFORD 02/910965
CUMMINS 3401544
KOMATSU 6742-01-4540



H 1 : 294 (mm)
OD 1 : 118 (mm)
Thread Size : 2 1/4-12 UNF-2B

CONT : 6
VOL : 0.029

Note : Multilayer

C-5715 Oil Filter Full Flow Spin-On
MTU 0031843001
CUMMINS 3313279
MITSUBISHI 37540-01101
CUMMINS 3889310
KOMATSU CULF-670



H 1 : 246 (mm)
OD 1 : 118 (mm)
Thread Size : 1 1/2-12 UNF-2B

CONT : 6
VOL : 0.029

Note : Height 286 MM Uses C-5701

C-56190 Oil Filter Full Flow Spin-On
KOMATSU 600-211-2110



H 1 : 80 (mm)
OD 1 : 74 (mm)
Thread Size : 3/4-16 UNF-2B
BPV (kg/cm2) : 2.0 - 2.5
ADBV : YES
Gasket Type : Round

CONT : 50
VOL : 0.031

Note : C-56191(bottom plate difference)

C-5708 Oil Filter Full Flow Spin-On
J.C.BAMFORD 32/925413
CUMMINS 3937736



H 1 : 174 (mm)
OD 1 : 93 (mm)
Thread Size : 1 1/8-16 UNF-2B
Gasket Type : Square

CONT : 12
VOL : 0.027

Note : Glass Fiber media uses C-5733

C-5718 Oil Filter By Pass Spin-On
ISUZU 1-87310093-0
CATERPILLAR 1W-8845
J.C.BAMFORD 32/919502
HITACHI 4285964



H 1 : 246 (mm)
OD 1 : 115.5 (mm)
Thread Size : 1 3/8-16 UNF-2B

CONT : 6
VOL : 0.032

C-56191 Oil Filter Full Flow Spin-On long life
KOMATSU 600-211-2110
CASE 87409203
NEW HOLLAND (CNH) 87415600
CUMMINS C6002112110



H 1 : 86.5 (mm)
OD 1 : 76 (mm)
Thread Size : 3/4-16 UNF-2B
BPV (kg/cm2) : 1.0
ADBV : YES
Gasket Type : Square

CONT : 50
VOL : 0.032

Note : C-56190(bottom plate difference)

C-5710 Oil Filter Combination Spin-On Seamless
HYUNDAI 11NB-70110
CUMMINS 2882674
CUMMINS 3101869
KOMATSU 600-211-1340



H 1 : 299 (mm)
OD 1 : 118 (mm)
Thread Size : M95X2.5-7H

CONT : 6
VOL : 0.033

Note : Performance Grade Uses C-5724,C-57430

C-5723 Oil Filter Combination Spin-On
KOMATSU 6742-01-4120



H 1 : 280 (mm)
OD 1 : 121 (mm)
Thread Size : 2 1/4-12 UNF-2B
Gasket Type : Square

CONT : 6
VOL : 0.038

C-5701 Oil Filter Full Flow Spin-On
HITACHI 4085913
KOMATSU 600-211-1231



H 1 : 286 (mm)
OD 1 : 118 (mm)
Thread Size : 1 1/2-12 UNF-2B
Gasket Type : Square

CONT : 10
VOL : 0.055

Note : related to:C-5605,C-5731,C-5715(short versions)

C-5712 Oil Filter Full Flow Spin-On
KOMATSU 6732-51-5141



H 1 : 145 (mm)
OD 1 : 93 (mm)
Thread Size : 1-16 UNF-2B
ADBV : YES
Gasket Type : Square

CONT : 12
VOL : 0.023

C-5730 Oil Filter Full Flow Spin-On Synthetic Media
CUMMINS 3903264
VOLVO 9912-90710



H 1 : 174 (mm)
OD 1 : 93 (mm)
Thread Size : 1-16 UNF-2B
Gasket Type : Square

CONT : 12
VOL : 0.030

C-5703 Oil Filter Full Flow Spin-On
HYUNDAI 11E1-70110
GENERAL MOTORS 25011995
CUMMINS 3903224
KOMATSU 6732-51-5140
CASE J908616



H 1 : 135 (mm)
OD 1 : 93 (mm)
Thread Size : 1-16 UNF-2B
Gasket Type : Square

CONT : 12
VOL : 0.018

C-5713 Oil Filter Full Flow Spin-On Synthetic Media
CUMMINS 4897898
CASE 87803261
FOTON C4897898A0571A



H 1 : 172 (mm)
OD 1 : 93.5 (mm)
Thread Size : M27X2-6H
Gasket Type : Square

CONT : 12
VOL : 0.026

Note : C-5734(Economical type of C-5713)

C-5731 Oil Filter Full Flow Spin-On With Microfiber media
CUMMINS 299670



H 1 : 260 (mm)
OD 1 : 118 (mm)
Thread Size : 1 1/2-12 UNF-2B
Gasket Type : Square

CONT : 6
VOL : 0.031

Sakura Filter

Technical Specification

C-57390 Oil Filter Combination Spin-On Synthetic Media
 CUMMINS 3973686
 CASE 87349575



H 1 : 234 (mm)
 OD 1 : 118 (mm)
 Thread Size : 2 1/4-12 UNF-2B

CONT : 6
 VOL : 0.030

226

C-6204 Oil Filter Full Flow Spin-On
 MERCEDES-BENZ 001 184 96 01
 DEUTZ 1173430
 CATERPILLAR 5W-6017
 ALLIS CHALMERS 61671600
 EVOBUS 7.119.226.04



H 1 : 206 (mm)
 OD 1 : 93 (mm)
 Thread Size : 1-12 UNF-2B
 BPV (kg/cm2) : 2.0 - 2.5
 ADBV : YES
 Gasket Type : Square

CONT : 25
 VOL : 0.057

Note : With Grip

231

C-8012 Oil Filter Full Flow Spin-On
 MAHINDRA 14501673990
 HITACHI 26300-21010
 HYUNDAI 26300-21010
 CHRYSLER 4186267
 MITSUBISHI 4253037



H 1 : 78 (mm)
 OD 1 : 86 (mm)
 Thread Size : M20X1.5-6H
 BPV (kg/cm2) : 1.0
 ADBV : YES
 Gasket Type : Square

CONT : 50
 VOL : 0.046

236

C-57430 Oil Filter Full Flow Spin-On Synthetic Media
 CUMMINS 4367100
 KOMATSU 600-211-1340



H 1 : 300 (mm)
 OD 1 : 118 (mm)
 Thread Size : M95X2.5-7H

CONT : 6
 VOL : 0.035

Note : upgrade of C-5710,C-5724

227

C-6210 Oil Filter Full Flow Spin-On
 VOLVO 423135-8



H 1 : 169 (mm)
 OD 1 : 93 (mm)
 Thread Size : 1-12 UNF-2B
 BPV (kg/cm2) : 1.0
 Gasket Type : Square

CONT : 12
 VOL : 0.023

232

C-8016 Oil Filter Full Flow Spin-On
 OPEL 650352
 RENAULT 7 700 638 670
 FORD 741M-6714-BA



H 1 : 87 (mm)
 OD 1 : 76 (mm)
 Thread Size : 3/4-16 UNF-2B
 Gasket Type : Square

CONT : 50
 VOL : 0.034

237

C-5814 Oil Filter Full Flow Spin-On
 MITSUBISHI 34740-00100



H 1 : 167 (mm)
 OD 1 : 93 (mm)
 Thread Size : 1-12 UNF-2B
 ADBV : YES
 Gasket Type : Round

CONT : 12
 VOL : 0.026

228

C-7005 Oil Filter Full Flow Spin-On
 GENERAL MOTORS 25010971
 CATERPILLAR 773899



H 1 : 260 (mm)
 OD 1 : 122 (mm)
 Thread Size : 1 1/2-12 UNF-2B
 Gasket Type : Square

CONT : 6
 VOL : 0.035

233

C-8031 Oil Filter Full Flow Spin-On
 CLARK 152499
 CUMMINS 152499
 CUMMINS 170200



H 1 : 139 (mm)
 OD 1 : 93 (mm)
 Thread Size : 13/16-16 UNF-2B
 BPV (kg/cm2) : 1.0
 Gasket Type : Square

CONT : 24
 VOL : 0.038

238

C-6202 Oil Filter Full Flow Spin-On
 DEMAG 206 089 40
 RENAULT 60 05 024 443



H 1 : 140 (mm)
 OD 1 : 93 (mm)
 Thread Size : 1-12 UNF-2B
 BPV (kg/cm2) : 1.0
 Gasket Type : Square

CONT : 25
 VOL : 0.041

Note : Without Nut

229

C-7602 Oil Filter Full Flow Spin-On
 STEIGER 18842
 DEMAG 25577440
 CLARK 6519239
 CASE A41725
 JOHN DEERE AR43634



H 1 : 174 (mm)
 OD 1 : 127 (mm)
 Thread Size : 1 1/2-16 UN-2B
 Gasket Type : Square

CONT : 6
 VOL : 0.025

234

CA-5601-S Cabin Air Filter Set Plastic framed Element
 KOMATSU 77Z-97-00020



H 1 : 19.5 (mm)
 Length 1 : 303.5 (mm)
 Width 1 : 199 (mm)

CONT : 20
 VOL : 0.036

Note : 1 set= 3 pcs filter

239

C-6203 Oil Filter Full Flow Spin-On
 IVECO 1161934
 IVECO 1902136



H 1 : 169 (mm)
 OD 1 : 93 (mm)
 Thread Size : 1-12 UNF-2B
 BPV (kg/cm2) : 1.0
 Gasket Type : Square

CONT : 25
 VOL : 0.030

230

C-7927 Oil Filter Combination Spin-On
 KOMATSU CULF 3548
 CASE J919562



H 1 : 238 (mm)
 OD 1 : 121 (mm)
 Thread Size : 2 1/4-12 UNF-2B
 Gasket Type : Square

CONT : 6
 VOL : 0.030

235

CA-5602 Cabin Air Filter Plastic framed Element
 KOMATSU 20Y-979-6261

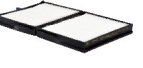

H 1 : 19.7 (mm)
 Length 1 : 266 (mm)
 Width 1 : 142 (mm)

CONT : 20
 VOL : 0.023

240

Sakura Filter

Technical Specification

CA-5603-S Cabin Air Filter Set Plastic framed Element

KOMATSU 14X-911-7741
KOMATSU 77Z-97-00010



H 1 : 19.5 (mm)
Length 1 : 202.5 (mm)
Width 1 : 199 (mm)

CONT : 20
VOL : 0.024

Note : 1 set= 2 pcs filter

241

CA-56120 Cabin Air Filter Paper framed Element

KOMATSU 2A5-979-1551



H 1 : 29 (mm)
Length 1 : 203.5 (mm)
Width 1 : 218.6 (mm)

CONT : 20
VOL : 0.045

Note : For Carbon type please check CAC number.

246

CAC-56120 Cabin Air Filter Paper framed Element with activated charcoal

KOMATSU 2A5-979-1551

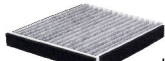

H 1 : 29 (mm)
Length 1 : 203.5 (mm)
Width 1 : 218.6 (mm)

CONT : 20
VOL : 0.051

Note : For Standard type please check CA number.

251

CA-56041 Cabin Air Filter Plastic framed Element

KOMATSU 14X-911-7750
KOMATSU 17M-911-3530
HITACHI 4234793
KOMATSU 569-076-1190
FIAT 71498266



H 1 : 51 (mm)
Length 1 : 220 (mm)
Width 1 : 163 (mm)

CONT : 20
VOL : 0.049

242

CA-56130 Cabin Air Filter Plastic Element

KOMATSU 114-X11-3850



H 1 : 26.5 (mm)
Length 1 : 236.5 (mm)
Width 1 : 201 (mm)

CONT : 20
VOL : 0.047

247

F-1303 Fuel Filter Metal End Cap Element

ISUZU 13240-029
NISSAN 16403-90026
NISSAN 16444-90000
HINO 23401-1030



H 1 : 105 (mm)
OD 1 : 74 (mm)
OD 2 : 74 (mm)
ID 1 : 16 (mm)
ID 2 : 16 (mm)

CONT : 50
VOL : 0.040

252

CA-56070 Cabin Air Filter Paper framed Element

KOMATSU 203-979-6840



H 1 : 24 (mm)
Length 1 : 306 (mm)
Length 2 : 236 (mm)
Width 1 : 198 (mm)

CONT : 20
VOL : 0.047

243

CA-56140 Cabin Air Filter Recirculation Foam Element

KOMATSU EM0055



H 1 : 12 (mm)
Length 1 : 488 (mm)
Width 1 : 88 (mm)

CONT : 50
VOL : 0.031

248

F-1501 Fuel Filter Metal End Cap Element

NISSAN 16403-37000
NISSAN 16403-37225
ISUZU 5-87810005-0



H 1 : 57 (mm)
OD 1 : 74 (mm)
OD 2 : 74 (mm)
ID 1 : 16 (mm)
ID 2 : 16 (mm)

CONT : 24
VOL : 0.012

253

CA-56080 Cabin Air Filter Plastic framed Element

KOMATSU 208-979-7740



H 1 : 19.5 (mm)
Length 1 : 199 (mm)
Width 1 : 101.5 (mm)

CONT : 20
VOL : 0.013

244

CA-56150 Cabin Air Filter Metal framed Element

KOMATSU 23B-950-2170
KOMATSU 23B-950-2171



H 1 : 17 (mm)
Length 1 : 309 (mm)
Width 1 : 170 (mm)

CONT : 25
VOL : 0.056

249

F-1801 Fuel Filter Metal End Cap Element

NISSAN 16444-90001
NISSAN 16444-90026
NISSAN 16444-90127



H 1 : 143 (mm)
H 2 : 140 (mm)
OD 1 : 91.5 (mm)
OD 2 : 91.5 (mm)
ID 1 : 15 (mm)
ID 2 : 15 (mm)

CONT : 50
VOL : 0.073

254

CA-56100 Cabin Air Filter Metal framed Element

KOMATSU 209-97-96260
KOMATSU 421-07-12312



H 1 : 55.8 (mm)
Length 1 : 253.5 (mm)
Width 1 : 153 (mm)

CONT : 20
VOL : 0.057

245

CA-5676 Cabin Air Filter Soft PU framed Element

KOMATSU 426-07-32441
KOMATSU 427-07-22120



H 1 : 46 (mm)
Length 1 : 312 (mm)
Width 1 : 255 (mm)

CONT : 20
VOL : 0.092

250

F-2601 Fuel Filter Metal End Cap Element

MERCEDES-BENZ 1457431261
IVECO 190605
DAEWOO 65.12503-5003



H 1 : 113 (mm)
H 2 : 107 (mm)
OD 1 : 64 (mm)
OD 2 : 64 (mm)
ID 1 : 12.8 (mm)
ID 2 : 12.8 (mm)

CONT : 50
VOL : 0.035

Note : Paper Protector

255

F-2603 Fuel Filter Metal End Cap Element

MERCEDES-BENZ 000 477 31 15
DAIMLER BENZ 4220900051
STEYR-DAIMLER-PUCH 614080740



H 1 : 145 (mm)
H 2 : 130 (mm)
OD 1 : 84.5 (mm)
OD 2 : 84.5 (mm)
ID 1 : 13 (mm)
ID 2 : 13 (mm)

CONT : 50
VOL : 0.062

256

F-5207 Fuel Filter Metal End Cap Element

YANMAR 119810-55650
YANMAR 124550-55700
KUBOTA 16271-43560



H 1 : 87.5 (mm)
H 2 : 85 (mm)
OD 1 : 35 (mm)
OD 2 : 35 (mm)
ID 1 : 11.5 (mm)

CONT : 50
VOL : 0.009

261

F-5601 Fuel Filter Metal End Cap Element

KOMATSU 6610-72-8600



H 1 : 235 (mm)
H 2 : 235 (mm)
OD 1 : 126 (mm)
OD 2 : 126 (mm)
ID 1 : 25 (mm)
ID 2 : 25 (mm)

CONT : 20
VOL : 0.110

Note : Hanger, Paper Protector

266

F-2604 Fuel Filter Metal End Cap Element

MERCEDES-BENZ 000 477 40 15
MERCEDES-BENZ 000 477 45 15
MERCEDES-BENZ 355 470 01 92



H 1 : 145 (mm)
H 2 : 138 (mm)
OD 1 : 83 (mm)
OD 2 : 83 (mm)
ID 1 : 14 (mm)
ID 2 : 14 (mm)

CONT : 50
VOL : 0.062

257

F-5210 Fuel Filter Metal End Cap Element

YANMAR 129100-55650
KUBOTA 15521-43160
KUBOTA 607



H 1 : 89 (mm)
OD 1 : 50 (mm)
OD 2 : 50 (mm)
ID 1 : 20 (mm)

CONT : 50
VOL : 0.017

262

F-56040 Fuel Filter Metal End Cap Element

KOMATSU 600-311-9971



H 1 : 42 (mm)
H 2 : 38.5 (mm)
OD 1 : 60 (mm)
OD 2 : 50 (mm)
ID 1 : 37 (mm)
ID 2 : 37 (mm)

CONT : 50
VOL : 0.017

267

F-2622 Fuel Filter Metal End Cap Element

MERCEDES-BENZ 4773815
DAEWOO 65125035001
CASE 714401R92
CLAAS 99104



H 1 : 112 (mm)
H 2 : 102 (mm)
OD 1 : 69 (mm)
OD 2 : 69 (mm)
ID 1 : 19 (mm)
ID 2 : 19 (mm)

CONT : 50
VOL : 0.034

258

F-5214 Fuel Filter Metal End Cap Element

YANMAR 171081-55910
CASE 282211A1
ISUZU 5-87810874-0



H 1 : 49.5 (mm)
H 2 : 47 (mm)
OD 1 : 35 (mm)
OD 2 : 35 (mm)
ID 1 : 11.5 (mm)

CONT : 100
VOL : 0.010

Note : Paper Wire Mesh

263

F-56050 Fuel Filter Wire Mesh supported Element

KOMATSU 569-04-81270



H 1 : 145.5 (mm)
H 2 : 140.5 (mm)
OD 1 : 73 (mm)
OD 2 : 76 (mm)
ID 1 : 34 (mm)

CONT : 25
VOL : 0.034

Note : Construction & Mining, Komatsu Dump Truck HD-465-7

268

F-2626 Fuel Filter Metal End Cap Element

KOMATSU 6110-70-6202



H 1 : 145 (mm)
H 2 : 130 (mm)
OD 1 : 84.5 (mm)
OD 2 : 84.5 (mm)
ID 1 : 13 (mm)
ID 2 : 13 (mm)

CONT : 50
VOL : 0.062

Gasket Type : Square

259

F-5218 Fuel Filter Metal End Cap Element

YANMAR 121850-55710



H 1 : 70 (mm)
H 2 : 67 (mm)
OD 1 : 35 (mm)
OD 2 : 35 (mm)
ID 1 : 11.5 (mm)

CONT : 50
VOL : 0.012

Note : wire mesh Screen Fuel Strainer

264

F-5701 Fuel Filter Metal End Cap Element

CUMMINS 139097
CUMMINS 256834



H 1 : 251.2 (mm)
H 2 : 238 (mm)
OD 1 : 147.7 (mm)
OD 2 : 147.7 (mm)
ID 1 : 25 (mm)
ID 2 : 25 (mm)

CONT : 9
VOL : 0.074

Note : Hanger, Paper Protector

269

F-5202 Fuel Filter Metal End Cap Element

YANMAR 104500-55710
HITACHI 4294842
ISUZU 5-87810269-0
JOHN DEERE CH15553
FORD SBA130366040



H 1 : 69 (mm)
H 2 : 66.5 (mm)
OD 1 : 35 (mm)
OD 2 : 35 (mm)
ID 1 : 11 (mm)

CONT : 100
VOL : 0.015

Note :

260

F-5501 Fuel Filter Metal End Cap Element

CATERPILLAR 4H-8792
CATERPILLAR 9H-4729



H 1 : 164 (mm)
H 2 : 160.5 (mm)
OD 1 : 88 (mm)
OD 2 : 88 (mm)
ID 1 : 25 (mm)
ID 2 : 25 (mm)

CONT : 25
VOL : 0.044

Note : Paper Protector

265

F-6502 Fuel Filter Secondary Metal End Cap Element

EUCLID 5573261
CASE G-148B 1959



H 1 : 93 (mm)
H 2 : 83 (mm)
OD 1 : 74 (mm)
OD 2 : 74 (mm)
ID 1 : 26 (mm)
ID 2 : 26 (mm)

CONT : 50
VOL : 0.034

270

F-6503 Fuel Filter Metal End Cap Element

CUMMINS 104790
GENERAL MOTORS 5574508



H 1 : 199 (mm)
H 2 : 189 (mm)
OD 1 : 75.5 (mm)
OD 2 : 75.5 (mm)
ID 1 : 24.5 (mm)
ID 2 : 24.5 (mm)

CONT : 50
VOL : 0.073

271

FC-1016 Fuel Filter Spin-On

MITSUBISHI ME 006066



H 1 : 80 (mm)
OD 1 : 90 (mm)
Thread Size : M20X1.5-6H
Gasket Type : Square

CONT : 36
VOL : 0.032

276

FC-1702 Fuel Filter Can-type Housing

VW GROUP 061 198 552
NISSAN 16403-76200
VOLVO 236628
VOLVO 236628/4



H 1 : 71 (mm)
OD 1 : 84 (mm)
OD 2 : 86.5 (mm)
ID 1 : 19.5 (mm)
ID 2 : 19.5 (mm)

CONT : 50
VOL : 0.036

Note : rolled paper version

281

F-6504 Fuel Filter Metal End Cap Element

EUCLID 5524979
GENERAL MOTORS 6436719
ATLAS COPCO 9709002102



H 1 : 217.8 (mm)
H 2 : 201 (mm)
OD 1 : 109.5 (mm)
OD 2 : 109.5 (mm)
ID 1 : 16 (mm)
ID 2 : 16 (mm)

CONT : 25
VOL : 0.084

Note : Hanger

272

FC-1108 Fuel Filter Spin-On

TOYOTA 23390-33010
TOYOTA 23390-64450
DAIHATSU 23390-64450-000



H 1 : 122 (mm)
OD 1 : 67.5 (mm)
Thread Size : 3/4-16 UNF-2B
Thread Nut Size : M36X1.5-6H
Gasket Type : Round

CONT : 50
VOL : 0.039

Note : not for common rail engine

277

FC-1801 Fuel Filter Spin-On

NISSAN 16403-09W00
NISSAN 16403-27000



H 1 : 80 (mm)
OD 1 : 80 (mm)
Thread Size : 3/4-16 UNF-2B
Gasket Type : Round

CONT : 50
VOL : 0.037

282

F-6505 Fuel Filter Metal End Cap Element

EUCLID 5574961
GENERAL MOTORS 5574961



H 1 : 139 (mm)
H 2 : 134 (mm)
OD 1 : 74 (mm)
OD 2 : 74 (mm)
ID 1 : 26 (mm)
ID 2 : 26 (mm)

CONT : 50
VOL : 0.051

273

FC-1303 Fuel Filter Spin-On

HINO 23401-1190
HINO 23401-1371
HINO 23401-1400



H 1 : 125 (mm)
OD 1 : 102 (mm)
Thread Size : 1-14 UNS-2B
Gasket Type : Round

CONT : 12
VOL : 0.022

Note : Seat Zinc Coating

278

FC-1802 Fuel Filter Spin-On

NISSAN 16405-34W00
NISSAN 16405-R8104
NISSAN 16405-R8300



H 1 : 116 (mm)
OD 1 : 80 (mm)
Thread Size : 3/4-16 UNF-2B
Thread Nut Size : M10X1.5
Gasket Type : Round

CONT : 50
VOL : 0.050

Note : Rolled paper version see FC-1819

283

F-7302 Fuel Filter Sock Element

CASE 434871R91
GENERAL MOTORS 5575032



H 1 : 213 (mm)
H 2 : 213 (mm)
OD 1 : 75 (mm)
OD 2 : 75 (mm)
ID 1 : 31.5 (mm)
ID 2 : 31.5 (mm)

CONT : 25
VOL : 0.040

274

FC-1501 Fuel Filter Spin-On

NISSAN 16403-89TA1
NISSAN 16403-J5500
HITACHI 4285643



H 1 : 87 (mm)
OD 1 : 80 (mm)
Thread Size : 3/4-16 UNF-2B
Gasket Type : Round

CONT : 50
VOL : 0.039

279

FC-1810 Fuel Filter Spin-On with head body

NISSAN 16403-99013
NISSAN 16403-NY001



H 1 : 145 (mm)
OD 1 : 93 (mm)
Thread Size : 1-14 UNS-2B
Gasket Type : Square

CONT : 12
VOL : 0.024

284

FC-1006 Fuel Filter Spin-On

SUZUKI 15410-78E00
SUZUKI 15411-78E00



H 1 : 120 (mm)
OD 1 : 80 (mm)
Thread Size : M20X1.5-6H
Thread Nut Size : M22X1.5-6H
Gasket Type : Round

CONT : 50
VOL : 0.053

275

FC-1503 Fuel Filter Spin-On High Efficiency

ISUZU 1-13240009-0
ISUZU 1-13240041-0



H 1 : 125 (mm)
OD 1 : 90 (mm)
Thread Size : 3/4-16 UNF-2B
Gasket Type : Round

CONT : 25
VOL : 0.035

280

FC-5103 Fuel Filter Can-type Housing

ALLIS CHALMERS 1919100
MANITOU 49660
CASE K915319



H 1 : 71 (mm)
OD 1 : 85 (mm)
OD 2 : 89 (mm)
ID 1 : 39 (mm)
ID 2 : 15 (mm)

CONT : 50
VOL : 0.036

285

Sakura Filter

Technical Specification

FC-5201 Fuel Filter Spin-On
YANMAR 123907-55800



H 1 : 150 (mm)
OD 1 : 90 (mm)
Thread Size : M20X1.5-6H
Gasket Type : Round

CONT : 25
VOL : 0.041

286

FC-5601 Fuel Filter Spin-On
KOMATSU 600-311-8220
KOMATSU 6136-71-6120



H 1 : 143 (mm)
OD 1 : 80 (mm)
Thread Size : 3/4-16 UNF-2B
Gasket Type : Round

CONT : 25
VOL : 0.031

291

FC-5610 Fuel Filter Spin-On
KOMATSU 600-311-8321



H 1 : 145 (mm)
OD 1 : 93 (mm)
Thread Size : 1-14 UNS-2B
Gasket Type : Square

CONT : 12
VOL : 0.023

Note :

296

FC-5403 Fuel Filter Spin-On With Drain Plug
ATLAS COPCO 1619-2684
DEUTZ 2133558
DEUTZ 2133943



H 1 : 173.4 (mm)
H 2 : 148 (mm)
OD 1 : 76 (mm)
Thread Size : M16X1.5-6H
Gasket Type : Square

CONT : 25
VOL : 0.041

Note :

287

FC-5602 Fuel Filter Spin-On
ISUZU 1-13240044-0
KOMATSU 600-311-8291
ISUZU X1.3240021



H 1 : 175 (mm)
OD 1 : 93 (mm)
Thread Size : 1-14 UNS-2B
Gasket Type : Round

CONT : 12
VOL : 0.026

292

FC-5612 Fuel Filter Spin-On
KOMATSU 600-311-3510
KOMATSU 600-319-3510



H 1 : 286 (mm)
OD 1 : 118 (mm)
Thread Size : 1 1/4-12 UNF-2B
Gasket Type : Square

CONT : 6
VOL : 0.038

Note : High performance grade uses FC-5622

297

FC-54050 Fuel Filter Secondary Spin-On
THERMO-KING 11.3855
GALION 120301
CASE 359251C1
CASE 674293C1
KOMATSU 674293C1



H 1 : 220 (mm)
OD 1 : 93 (mm)
Thread Size : 7/8-14 UNF-2B
Gasket Type : Square

CONT : 12
VOL : 0.031

288

FC-5604 Fuel Filter Spin-On
KOMATSU 600-311-6220
KOMATSU 600-311-6221
KOMATSU 600-311-7410



H 1 : 87 (mm)
OD 1 : 80 (mm)
Thread Size : 3/4-16 UNF-2B
Gasket Type : Round

CONT : 50
VOL : 0.039

293

FC-5613 Fuel Filter Spin-On High Efficiency
KOMATSU 6754-71-6130
KOMATSU 6754-71-6140
KOMATSU 6754-79-6130



H 1 : 174 (mm)
OD 1 : 93 (mm)
Thread Size : M20X1.5-6H
Gasket Type : Square

CONT : 12
VOL : 0.025

Note : absolute micron rating 4.69, single layer media

298

FC-5501 Fuel Filter Spin-On
CATERPILLAR 1P-2299



H 1 : 174 (mm)
OD 1 : 93 (mm)
Thread Size : 1-14 UNS-2B
Gasket Type : Square

CONT : 25
VOL : 0.052

Note : High Performance Grade Uses FC-5523

289

FC-5605 Fuel Filter Spin-On
KOMATSU 600-311-8221



H 1 : 148 (mm)
OD 1 : 76 (mm)
Thread Size : 3/4-16 UNF-2B
Gasket Type : Square

CONT : 25
VOL : 0.027

Note : FC-5605=Height 148 MM, FC-5618= Height 114.7 MM

294

FC-5614 Fuel Filter Spin-On High Efficiency
KOMATSU 600-311-3520



H 1 : 286 (mm)
OD 1 : 115.5 (mm)
Thread Size : 1 5/8-12 UNF-2B
Gasket Type : Square

CONT : 6
VOL : 0.033

Note : For high pressure fuel injection systems

299

FC-5521 Fuel Filter Spin-On
CUMMINS 3973232
NEW HOLLAND (CNH) 87360572



H 1 : 174 (mm)
OD 1 : 93 (mm)
Thread Size : 7/8-14 UNF-2B
Gasket Type : Square

CONT : 12
VOL : 0.027

290

FC-5606 Fuel Filter Spin-On
KOMATSU 600-311-8282
KOMATSU 600-311-8293



H 1 : 150 (mm)
H 2 : 141 (mm)
OD 1 : 93 (mm)
Thread Size : 1-14 UNS-2B
Gasket Type : Square

CONT : 12
VOL : 0.020

Note : Drain Nut

295

FC-5615 Fuel Filter Spin-On High Efficiency
CUMMINS 4942437
CUMMINS 4946635
YALE & TOWNE 580090996
KOMATSU 600-311-3530
KOMATSU 600-319-3530



H 1 : 143.5 (mm)
OD 1 : 80 (mm)
Thread Size : M22X1.5-6H
Gasket Type : Round

CONT : 24
VOL : 0.030

Note : For High Pressure Fuel Injection Systems

300

FC-5621 Fuel Filter Spin-On

KOMATSU 600-311-9120
KOMATSU 600-311-9121



H 1 : 174 (mm)
OD 1 : 93 (mm)
OD 2 : 92.7 (mm)
Thread Size : 1-14 UNS-2B
Thread Nut Size : M8X1.25
Gasket Type : Square

CONT : 12
VOL : 0.024

301

FC-56300 Fuel Filter Spin-On High Efficiency

KOMATSU 600-311-3841
KOMATSU 600-319-3841



H 1 : 275 (mm)
OD 1 : 125 (mm)
Thread Size : 1 3/8-12 UNF-2B
Gasket Type : Square

CONT : 6
VOL : 0.033

306

FC-5704 Fuel Filter Spin-On

VOLVO 241672
VOLVO 243004
MASSEY-FERGUSON 2871513M1



H 1 : 123 (mm)
OD 1 : 76 (mm)
Thread Size : M16X1.5-6H
Gasket Type : Square

CONT : 50
VOL : 0.047

Note : With Center Tube

311

FC-5622 Fuel Filter Spin-On High Efficiency

KOMATSU 600-311-3310
KOMATSU 600-311-3510
KOMATSU 600-319-3310
KOMATSU 600-319-3510



H 1 : 286 (mm)
OD 1 : 118 (mm)
Thread Size : 1 1/4-12 UNF-2B
Gasket Type : Square

CONT : 6
VOL : 0.032

Note : For high pressure fuel injection systems

302

FC-56310 Fuel Filter Spin-On High Efficiency

KOMATSU 22H-04-11240



H 1 : 100 (mm)
H 2 : 100 (mm)
OD 1 : 80 (mm)
Thread Size : M20X1.5-6H
Gasket Type : Round

CONT : 50
VOL : 0.041

Note : for Komatsu PC56-7

307

FC-5713 Fuel Filter Spin-On

CUMMINS 3959612



H 1 : 174 (mm)
OD 1 : 93 (mm)
Thread Size : 7/8-14 UNF-2B
Gasket Type : Square

CONT : 12
VOL : 0.027

Note : 5 micron

312

FC-56230 Fuel Filter Spin-On High Efficiency

KOMATSU 600-311-3550
KOMATSU 600-319-3550



H 1 : 286 (mm)
OD 1 : 115.5 (mm)
Thread Size : 1 5/8-12 UNF-2B
Gasket Type : Square

CONT : 6
VOL : 0.034

Note : For high pressure fuel injection systems

303

FC-56320 Fuel Filter Spin-On High Efficiency

KOMATSU 600-319-3881



H 1 : 148 (mm)
OD 1 : 80 (mm)
Thread Size : 13/16-16 UNF-2B
Gasket Type : Round

CONT : 24
VOL : 0.031

Note : Alternate parts FC-56290

308

FC-5715 Fuel Filter Spin-On With Drain Plug

KHD(KLOCKNER-HUMBOLT-DEUTZ) 1174482
J.C.BAMFORD 32/912001



H 1 : 163 (mm)
OD 1 : 81.5 (mm)
Thread Size : M16X1.5-6H
Thread Nut Size : M8X1.25
Gasket Type : Square

CONT : 25
VOL : 0.037

313

FC-56270 Fuel Filter Spin-On High Efficiency

KOMATSU 600-319-3750



H 1 : 174 (mm)
OD 1 : 93 (mm)
Thread Size : 7/8-14 UNF-2B
Gasket Type : Square

CONT : 12
VOL : 0.027

304

FC-5702 Fuel Filter Spin-On

MITSUBISHI 32540-20300
MITSUBISHI 32562-20300
HITACHI 4085912



H 1 : 175 (mm)
OD 1 : 93 (mm)
Thread Size : 1-14 UNS-2B
Gasket Type : Square

CONT : 12
VOL : 0.030

Note : Drain nut

309

FC-5720 Fuel Filter Spin-On

CUMMINS 154709
CUMMINS 3315844



H 1 : 135 (mm)
OD 1 : 93 (mm)
Thread Size : 1-14 UNS-2B
Gasket Type : Square

CONT : 12
VOL : 0.021

Note : Is a short version of FC-57270

314

FC-56290 Fuel Filter Spin-On High Efficiency

KOMATSU 600-311-3870
KOMATSU 600-319-3870



H 1 : 148 (mm)
OD 1 : 80 (mm)
Thread Size : 13/16-16 UNF-2B
Gasket Type : Round

CONT : 24
VOL : 0.031

Note : for Komatsu Excavator PC70-8

305

FC-5703 Fuel Filter Spin-On High Efficiency

MTU 0010925601
CUMMINS 299202
CUMMINS 3313306
KOMATSU 600-311-7130



H 1 : 286 (mm)
OD 1 : 118 (mm)
Thread Size : 1 1/4-12 UNF-2B
Gasket Type : Square

CONT : 6
VOL : 0.030

310

FC-5721 Fuel Filter Spin-On

CUMMINS 156172
FIAT-ALLIS 70697633
FORD 749F9176AAA
VOLVO 79250023



H 1 : 136 (mm)
OD 1 : 93 (mm)
Thread Size : 1-14 UNS-2B
Gasket Type : Square

CONT : 12
VOL : 0.023

315

FC-57290 Fuel Filter Spin-On High Efficiency
CUMMINS 4964234



H 1 : 262 (mm)
OD 1 : 118 (mm)
Thread Size : 2 1/4-12 UNF-2B

CONT : 6
VOL : 0.032

316

FC-6505 Fuel Filter Spin-On
GENERAL MOTORS 23518528
GENERAL MOTORS 25011024



H 1 : 228 (mm)
OD 1 : 118 (mm)
Thread Size : 1 1/4-12 UNF-2B
Gasket Type : Square

CONT : 6
VOL : 0.027

321

FS-5701 Fuel Filter Metal body In-Line
CUMMINS 3826094
NEW HOLLAND (CNH) 86597473



H 1 : 96 (mm)
OD 1 : 44.5 (mm)
Inlet : 10 (mm)
Outlet : 10 (mm)

CONT : 12
VOL : 0.005

326

FC-6202 Fuel Filter Spin-On
MERCEDES-BENZ 000 092 83 01
MERCEDES-BENZ 000 092 94 01
DEUTZ 1161003



H 1 : 140 (mm)
OD 1 : 93 (mm)
Thread Size : M16X1.5-6H
Gasket Type : Square

CONT : 25
VOL : 0.041

317

FC-6506 Fuel Filter Spin-On
DETROIT DIESEL 23518532
GENERAL MOTORS 23518532
GENERAL MOTORS 25011026



H 1 : 228 (mm)
OD 1 : 118 (mm)
Thread Size : 1 1/16-16 UNF-2B
Gasket Type : Square

CONT : 6
VOL : 0.027

322

H-2706 Hydraulic Oil Filter Suction Wire Mesh supported Element
YANMAR 172162-73700
HITACHI 4210224



H 1 : 134.8 (mm)
H 2 : 128 (mm)
OD 1 : 150 (mm)
OD 2 : 150 (mm)
ID 1 : 87 (mm)
Thread Size : M10X1.5-6H

CONT : 6
VOL : 0.028

327

FC-6205 Fuel Filter Spin-On
DEUTZ 1174424
CROSLAND 5003



H 1 : 79 (mm)
OD 1 : 76 (mm)
Thread Size : M16X1.5-6H
Gasket Type : Square

CONT : 50
VOL : 0.031

Note : With center tube

318

FC-7903 Fuel Filter Secondary Spin-On High Efficiency
J.C.BAMFORD 02/910155
CUMMINS 3903640
CUMMINS 3931063



H 1 : 115 (mm)
OD 1 : 76 (mm)
Thread Size : M16X1.5-6H
Gasket Type : Square

CONT : 25
VOL : 0.023

323

H-2709 Hydraulic Oil Filter Metal End Cap Element
KOMATSU 07063-01383
KOMATSU 208-60-61150
HITACHI 4287634
HITACHI 76580323



H 1 : 450 (mm)
OD 1 : 180 (mm)
OD 2 : 180 (mm)
ID 1 : 110 (mm)
ID 2 : 110 (mm)

CONT : 9
VOL : 0.173

328

FC-6501 Fuel Filter Primary Spin-On
GENERAL MOTORS 25014274
GENERAL MOTORS 6438839



Secondary Filter uses FC-6502

H 1 : 203 (mm)
OD 1 : 93 (mm)
Thread Size : 1-12 UNF-2B
Gasket Type : Square

CONT : 12
VOL : 0.028

319

FC-7933 Fuel Filter Spin-On
CASE 672603C2



H 1 : 200 (mm)
OD 1 : 108 (mm)
Thread Size : 7/8-14 UNF-2B
Gasket Type : Square

CONT : 6
VOL : 0.021

324

H-42300 Hydraulic Breather Foam Element
KOMATSU 423-60-35460



H 1 : 14 (mm)
OD 1 : 47 (mm)
OD 2 : 47 (mm)
ID 1 : 33 (mm)
ID 2 : 33 (mm)

CONT : 100
VOL : 0.015

329

FC-6502 Fuel Filter Secondary Spin-On
GENERAL MOTORS 25010778
GENERAL MOTORS 6438840



Primary Filter uses FC-6501

H 1 : 175 (mm)
OD 1 : 93 (mm)
Thread Size : 13/16-12 UNF-2B
Gasket Type : Square

CONT : 12
VOL : 0.025

320

FS-5601 Fuel Filter Metal body In-Line
CASE 194199A1
KOMATSU 2070-4A1100



H 1 : 94 (mm)
H 2 : 60 (mm)
OD 1 : 50 (mm)
OD 2 : 44 (mm)
Inlet : 13 (mm)
Outlet : 13 (mm)

CONT : 50
VOL : 0.019

325

H-5406 Hydraulic Oil Filter Metal End Cap Element
INTERNATIONAL HARVESTER 631144 C1
INTERNATIONAL HARVESTER 631144 C2

















H 1 : 228 (mm)
OD 1 : 114 (mm)
OD 2 : 114 (mm)
ID 1 : 58.5 (mm)
ID 2 : 13.5 (mm)

CONT : 20
VOL : 0.074

330

Sakura Filter

Technical Specification

<p>H-5503</p> <p>Hydraulic Oil Filter Metal End Cap Element</p> <p>CATERPILLAR 1R-0720 CATERPILLAR 4J-6064</p>  <p>H 1 : 228 (mm) OD 1 : 130 (mm) OD 2 : 130 (mm) ID 1 : 84.4 (mm) ID 2 : 84.4 (mm)</p> <p>CONT : 20 VOL : 0.105</p> <p>Note : Performance grade uses H-5526</p> <p style="text-align: right;">331</p>	<p>H-55280</p> <p>Hydraulic Oil Filter Metal End Cap Element with synthetic media</p> <p>CATERPILLAR 132-8876 CATERPILLAR 4T-3132</p>  <p>H 1 : 228.2 (mm) H 2 : 225 (mm) OD 1 : 130 (mm) OD 2 : 130 (mm) ID 1 : 84.4 (mm) ID 2 : 84.4 (mm)</p> <p>CONT : 6 VOL : 0.031</p> <p style="text-align: right;">336</p>	<p>H-5609</p> <p>Hydraulic Oil Filter Metal End Cap Element Cellulose media</p> <p>KOMATSU 07063-01142 KOMATSU 07063-01412 KOMATSU 195-60-16320</p>  <p>H 1 : 300.5 (mm) OD 1 : 150 (mm) OD 2 : 150 (mm) ID 1 : 110 (mm) ID 2 : 110 (mm)</p> <p>CONT : 6 VOL : 0.059</p> <p style="text-align: right;">341</p>
<p>H-5504</p> <p>Hydraulic Oil Filter Metal End Cap Element</p> <p>CATERPILLAR 1R-0719 CATERPILLAR 2M-3943 CATERPILLAR 9M-9740</p>  <p>H 1 : 234 (mm) OD 1 : 101 (mm) OD 2 : 101 (mm) ID 1 : 59 (mm) ID 2 : 59 (mm)</p> <p>CONT : 20 VOL : 0.071</p> <p style="text-align: right;">332</p>	<p>H-5601</p> <p>Hydraulic Oil Filter Metal End Cap Element</p> <p>KOMATSU 144-60-11160</p>  <p>H 1 : 277 (mm) OD 1 : 100 (mm) OD 2 : 100 (mm) ID 1 : 60 (mm) ID 2 : 60 (mm)</p> <p>CONT : 25 VOL : 0.092</p> <p style="text-align: right;">337</p>	<p>H-5610</p> <p>Hydraulic Oil Filter Metal End Cap Element</p> <p>KOMATSU 07063-01100 KOMATSU 141-60-18270 KOMATSU 175-60-27380</p>  <p>H 1 : 292 (mm) OD 1 : 130 (mm) OD 2 : 130 (mm) ID 1 : 86 (mm) ID 2 : 86 (mm)</p> <p>CONT : 6 VOL : 0.040</p> <p style="text-align: right;">342</p>
<p>H-5519</p> <p>Hydraulic Oil Filter Metal End Cap Element</p> <p>SUMITOMO KRJ 1599</p>  <p>H 1 : 291 (mm) OD 1 : 112 (mm) OD 2 : 112 (mm) ID 1 : 70 (mm) ID 2 : 70 (mm)</p> <p>CONT : 9 VOL : 0.049</p> <p style="text-align: right;">333</p>	<p>H-5606</p> <p>Hydraulic Oil Filter Metal End Cap Element</p> <p>KOMATSU 175-49-11580 KOMATSU 2-3EB-66-21140</p>  <p>H 1 : 233.3 (mm) H 2 : 231 (mm) OD 1 : 100 (mm) OD 2 : 100 (mm) ID 1 : 42 (mm) ID 2 : 35.8 (mm)</p> <p>CONT : 20 VOL : 0.074</p> <p style="text-align: right;">338</p>	<p>H-56100</p> <p>Hydraulic Oil Filter Metal End Cap Element</p> <p>KOMATSU 22P-60-21161</p>  <p>H 1 : 104.5 (mm) H 2 : 99.5 (mm) OD 1 : 110 (mm) OD 2 : 110 (mm) ID 1 : 61 (mm) ID 2 : 61 (mm)</p> <p>CONT : 25 VOL : 0.048</p> <p style="text-align: right;">343</p>
<p>H-5526</p> <p>Hydraulic Oil Filter Metal End Cap Element With Microfiber media</p> <p>CATERPILLAR 4J-6064 CATERPILLAR 9W-6428</p>  <p>H 1 : 228 (mm) OD 1 : 130 (mm) OD 2 : 130 (mm) ID 1 : 85 (mm) ID 2 : 85 (mm)</p> <p>CONT : 12 VOL : 0.062</p> <p style="text-align: right;">334</p>	<p>H-5607</p> <p>Hydraulic Oil Filter Metal End Cap Element</p> <p>KOMATSU 07063-01054 KOMATSU 154-60-12170 KOMATSU ZZ0706301054</p>  <p>H 1 : 211 (mm) OD 1 : 100 (mm) OD 2 : 100 (mm) ID 1 : 60 (mm) ID 2 : 60 (mm)</p> <p>CONT : 20 VOL : 0.059</p> <p style="text-align: right;">339</p>	<p>H-5611</p> <p>Hydraulic Oil Filter Metal End Cap Element</p> <p>KOMATSU 101-60-15170 KOMATSU 101-60-15171</p>  <p>H 1 : 143 (mm) OD 1 : 64.8 (mm) OD 2 : 64.8 (mm) ID 1 : 25.5 (mm) ID 2 : 25.5 (mm)</p> <p>CONT : 50 VOL : 0.041</p> <p style="text-align: right;">344</p>
<p>H-55270</p> <p>Hydraulic Oil Filter Metal End Cap Element with synthetic media</p> <p>CATERPILLAR 4T-3131</p>  <p>H 1 : 231 (mm) OD 1 : 101 (mm) OD 2 : 101 (mm) ID 1 : 59 (mm) ID 2 : 59 (mm)</p> <p>CONT : 12 VOL : 0.028</p> <p style="text-align: right;">335</p>	<p>H-5608</p> <p>Hydraulic Oil Filter Metal End Cap Element</p> <p>KOMATSU 130-60-48210</p>  <p>H 1 : 278.5 (mm) OD 1 : 65 (mm) OD 2 : 65 (mm) ID 1 : 25.5 (mm) ID 2 : 25.5 (mm)</p> <p>CONT : 25 VOL : 0.041</p> <p style="text-align: right;">340</p>	<p>H-56110</p> <p>Hydraulic Oil Filter Metal End Cap Element</p> <p>KOMATSU 3EC-66-71540</p>  <p>H 1 : 133.5 (mm) H 2 : 131 (mm) OD 1 : 83 (mm) OD 2 : 83 (mm) ID 1 : 41.8 (mm) ID 2 : 41.8 (mm)</p> <p>CONT : 25 VOL : 0.038</p> <p style="text-align: right;">345</p>

Sakura Filter

Technical Specification

H-5613 Hydraulic Oil Filter Metal End Cap Element
KOMATSU 205-60-51450



H 1 : 197 (mm)
H 2 : 190 (mm)
OD 1 : 150 (mm)
OD 2 : 150 (mm)
ID 1 : 73.5 (mm)
Thread Size : M10X1.5-6H

CONT : 9
VOL : 0.053

346

H-5629 Hydraulic Oil Filter Metal End Cap Element with synthetic media
KOMATSU 207-60-71180



H 1 : 200 (mm)
OD 1 : 150 (mm)
OD 2 : 150 (mm)
ID 1 : 92 (mm)
ID 2 : 92 (mm)

CONT : 10
VOL : 0.069

351

H-5641 Hydraulic Oil Filter Metal End Cap Element
KOMATSU 144-49-13853



H 1 : 162.6 (mm)
H 2 : 139.5 (mm)
OD 1 : 60 (mm)
OD 2 : 60 (mm)
ID 1 : 26.5 (mm)
ID 2 : 26.5 (mm)

CONT : 25
VOL : 0.021

356

H-5618 Hydraulic Oil Filter Metal End Cap Element
MITSUBISHI 385-10100021
MITSUBISHI 385-10100022
KOMATSU 424-16-11140



H 1 : 229.6 (mm)
H 2 : 227 (mm)
OD 1 : 110 (mm)
OD 2 : 110 (mm)
ID 1 : 44 (mm)
ID 2 : 44 (mm)

CONT : 20
VOL : 0.074

347

H-56292 Hydraulic Oil Filter Wire Mesh supported Element
KOMATSU 207-60-71183



H 1 : 205 (mm)
H 2 : 200 (mm)
OD 1 : 150 (mm)
OD 2 : 150 (mm)
ID 1 : 92 (mm)
ID 2 : 92 (mm)

CONT : 9
VOL : 0.060

Note : 2000 Hoken Komatsu Excavator

352

H-5646 Hydraulic Oil Filter Metal End Cap Element Cellulose media
KOMATSU 207-60-71180



H 1 : 200 (mm)
OD 1 : 150 (mm)
OD 2 : 150 (mm)
ID 1 : 92 (mm)
ID 2 : 92 (mm)

CONT : 10
VOL : 0.062

Note : H-5629 (Media difference)

357

H-5620 Hydraulic Oil Filter Metal End Cap Element
KOMATSU 281-16-11290
KOMATSU 287-16-11510



H 1 : 233 (mm)
OD 1 : 100 (mm)
OD 2 : 100 (mm)
ID 1 : 42 (mm)
ID 2 : 42 (mm)

CONT : 20
VOL : 0.074

348

H-5632 Hydraulic Oil Filter Element
KOMATSU 3EB-66-11711
KOMATSU 3EB6-61-1710
KOMATSU 3EB7-61-1710
KOMATSU 3EB7-61-1711



H 1 : 165 (mm)
H 2 : 152 (mm)
OD 1 : 90 (mm)
OD 2 : 90 (mm)
Thread Size : 3/4 BSPT

CONT : 25
VOL : 0.053

353

H-5652 Hydraulic Oil Filter Metal End Cap Element
KOMATSU 285-62-17320A



H 1 : 51.8 (mm)
OD 1 : 52 (mm)
OD 2 : 52 (mm)
ID 1 : 37.5 (mm)
ID 2 : 37.5 (mm)

CONT : 12
VOL : 0.003

358

H-5622 Hydraulic Oil Filter Metal End Cap Element
KOMATSU 198-49-11440



H 1 : 291.5 (mm)
OD 1 : 112 (mm)
OD 2 : 112 (mm)
ID 1 : 70 (mm)
ID 2 : 70 (mm)

CONT : 10
VOL : 0.051

349

H-5635 Hydraulic Oil Filter Metal End Cap Element
KOMATSU 22B-60-11160



H 1 : 138.5 (mm)
H 2 : 130.5 (mm)
OD 1 : 125 (mm)
OD 2 : 124 (mm)
ID 1 : 97.8 (mm)
Thread Size : M10X1.5-6H

CONT : 12
VOL : 0.036

354

H-56530 Hydraulic Oil Filter Metal End Cap Element with synthetic media
KOMATSU 22L-60-22120



H 1 : 131 (mm)
OD 1 : 83.2 (mm)
OD 2 : 83.2 (mm)
ID 1 : 42.2 (mm)
ID 2 : 42.2 (mm)

CONT : 25
VOL : 0.034

359

H-5625 Hydraulic Oil Filter Metal End Cap Element
YANMAR 172141-73760
KOMATSU 311781-31140



H 1 : 178 (mm)
OD 1 : 89 (mm)
OD 2 : 89 (mm)
ID 1 : 60 (mm)
ID 2 : 60 (mm)

CONT : 25
VOL : 0.057

350

H-5639 Hydraulic Oil Filter Metal End Cap Element with synthetic media
KOMATSU 208-60-71121
KOMATSU 208-60-71122A



H 1 : 200 (mm)
OD 1 : 180 (mm)
OD 2 : 180 (mm)
ID 1 : 110 (mm)
ID 2 : 110 (mm)

CONT : 6
VOL : 0.051

355

H-56540 Hydraulic Oil Filter Metal End Cap Element Synthetic Media
KOMATSU 21W-60-41121



H 1 : 100 (mm)
OD 1 : 110 (mm)
OD 2 : 110 (mm)
ID 1 : 61 (mm)
ID 2 : 61 (mm)

CONT : 12
VOL : 0.021

360

H-56570 Hydraulic Oil Filter Transmission Wire Mesh supported Element
KOMATSU 195-13-13420



H 1 : 90 (mm)
H 2 : 85.5 (mm)
OD 1 : 57 (mm)
OD 2 : 57 (mm)
ID 1 : 43 (mm)
ID 2 : 6.6 (mm)

CONT : 50
VOL : 0.021

361

H-56652 Hydraulic Oil Filter Metal End Cap Element
KOMATSU 423-60-45461



H 1 : 204 (mm)
OD 1 : 110 (mm)
OD 2 : 110 (mm)
ID 1 : 61 (mm)
ID 2 : 61 (mm)

CONT : 9
VOL : 0.029

366

H-62110 Hydraulic Oil Filter Metal End Cap Element
KOMATSU 6964737
LIEBHERR 736 4368



H 1 : 213 (mm)
H 2 : 167 (mm)
OD 1 : 81.5 (mm)
OD 2 : 71 (mm)
ID 1 : 40 (mm)

CONT : 9
VOL : 0.019

371

H-56580 Hydraulic Oil Filter Metal End Cap Element
KOMATSU 569-43-83920



H 1 : 207.5 (mm)
H 2 : 203 (mm)
OD 1 : 51 (mm)
OD 2 : 51 (mm)
ID 1 : 23 (mm)

CONT : 12
VOL : 0.010

362

H-56690 Hydraulic Oil Filter Metal End Cap Element
KOMATSU 207-60-61250



H 1 : 144 (mm)
OD 1 : 30 (mm)
OD 2 : 34 (mm)
ID 1 : 21 (mm)

CONT : 50
VOL : 0.015

367

H-65030 Hydraulic Oil Filter Transmission Metal End Cap Element
VOLVO 15052
HITACHI 1930779
GENERAL MOTORS 25010836
GENERAL MOTORS 25011193
ALLIS CHALMERS 618179



H 1 : 228 (mm)
H 2 : 226 (mm)
OD 1 : 109.5 (mm)
OD 2 : 109.5 (mm)
ID 1 : 38.3 (mm)
ID 2 : 38.3 (mm)

CONT : 12
VOL : 0.043

372

H-56600 Hydraulic Oil Filter Metal End Cap Element with synthetic media
KOMATSU 07063-51100



H 1 : 292 (mm)
OD 1 : 130 (mm)
OD 2 : 130 (mm)
ID 1 : 86 (mm)
ID 2 : 86 (mm)

CONT : 1
VOL : 0.010

363

H-56700 Hydraulic Oil Filter Wire Mesh supported Element
KOMATSU 421-43-H0P43



H 1 : 71 (mm)
H 2 : 65.5 (mm)
OD 1 : 56 (mm)
OD 2 : 56 (mm)
ID 1 : 27 (mm)

CONT : 50
VOL : 0.025

Note : Komatsu wheel Loader WA320-3H Active, WA420-3H

368

H-7105 Hydraulic Oil Filter additional part Metal End Cap Element With Microfiber media
VOLVO 14532686
HITACHI 4157882



H 1 : 86 (mm)
H 2 : 82.5 (mm)
OD 1 : 42.5 (mm)
OD 2 : 42.5 (mm)
ID 1 : 21.5 (mm)

CONT : 50
VOL : 0.014

373

H-56610 Hydraulic Breather Foam Element
KOMATSU 204-60-21470
KOMATSU 20Y-60-21470



H 1 : 23 (mm)
OD 1 : 47 (mm)
OD 2 : 47 (mm)
ID 1 : 33 (mm)
ID 2 : 33 (mm)

CONT : 100
VOL : 0.008

364

H-56740 Hydraulic Oil Filter Aluminium casting end cap, Element
KOMATSU 562-15-11570



H 1 : 255 (mm)
H 2 : 138.5 (mm)
OD 1 : 78 (mm)
OD 2 : 70 (mm)
ID 1 : 10 (mm)
Thread Size : M10X1.5-6H

CONT : 25
VOL : 0.058

Note : with magnet

369

H-7911 Hydraulic Oil Filter Metal End Cap Element
KOMATSU 07063-01210
KOMATSU 205-60-51430



H 1 : 450 (mm)
OD 1 : 150 (mm)
OD 2 : 150 (mm)
ID 1 : 110 (mm)
ID 2 : 110 (mm)

CONT : 6
VOL : 0.080

Note : Without gasket

374

H-56650 Hydraulic Oil Filter Metal End Cap Element With Microfiber media
KOMATSU 14X-60-31150



H 1 : 200 (mm)
OD 1 : 110 (mm)
OD 2 : 110 (mm)
ID 1 : 61 (mm)
ID 2 : 61 (mm)

CONT : 9
VOL : 0.029

365

H-56770 Hydraulic Oil Filter Metal End Cap Element
KOMATSU 209-38-12470
KOMATSU 421-43-27920



H 1 : 82.5 (mm)
OD 1 : 42.5 (mm)
OD 2 : 42.5 (mm)
ID 1 : 21 (mm)

CONT : 25
VOL : 0.008

370

H-7972 Hydraulic Oil Filter Metal End Cap Element With Microfiber media
FAIREY ARLON 370L110A
FAIREYAR 370L123A
FAIREYAR 370L123GDH20
CATERPILLAR 311955



H 1 : 101.5 (mm)
H 2 : 94.5 (mm)
OD 1 : 93 (mm)
OD 2 : 93 (mm)
ID 1 : 47 (mm)

CONT : 25
VOL : 0.036

375

Sakura Filter

Technical Specification

H-85680 Hydraulic Oil Filter Metal End Cap Element

SUMITOMO KRJ15830
SUMITOMO KRJ20710



H 1 : 454 (mm)
H 2 : 449 (mm)
OD 1 : 150 (mm)
OD 2 : 150 (mm)
ID 1 : 110 (mm)
ID 2 : 110 (mm)

CONT : 1
VOL : 0.013

376

HC-5502 Hydraulic Oil Filter Spin-On

DEMAG 04425274
DEMAG 4425274
JOHN DEERE AZ36942



H 1 : 305 (mm)
OD 1 : 136 (mm)
Thread Size : 1 1/2-16 UN-2B
ADBV : YES
Gasket Type : Square

CONT : 6
VOL : 0.050

381

HC-5602 Hydraulic Oil Filter Spin-On

KOMATSU 113-60-43320
KOMATSU 113-60-43321
KOMATSU 209-607-6210
HITACHI 4205684
KUBOTA 68773-62230



H 1 : 171 (mm)
OD 1 : 125 (mm)
Thread Size : M48X2-6H

CONT : 6
VOL : 0.026

386

HC-1119 Hydraulic Oil Filter Transmission Spin-On

TOYOTA 32670-12620-71



H 1 : 80 (mm)
OD 1 : 74 (mm)
Thread Size : 3/4-16 UNF-2B
BPV (kg/cm2) : 1.0
ADBV : YES
Gasket Type : Round

CONT : 50
VOL : 0.030

377

HC-5507 Hydraulic Oil Filter Spin-On Synthetic Media

CATERPILLAR 144-6691
DEUTZ 4118911
CLARK 6661248
NEW HOLLAND (CNH) 920019190



H 1 : 152 (mm)
OD 1 : 94.5 (mm)
Thread Size : 1 3/8-12 UNF-2B

CONT : 12
VOL : 0.024

382

HC-5603 Hydraulic Oil Filter Return Spin-On

KOMATSU 21N-60-12210
YAMASHIN CSP-10L-10



H 1 : 289 (mm)
OD 1 : 127 (mm)
Thread Size : M48X2-6H

CONT : 6
VOL : 0.046

387

HC-2701 Hydraulic Oil Filter Transmission Spin-On

HITACHI 4230376
HITACHI 4286837
KOMATSU BW252116



H 1 : 232 (mm)
H 2 : 213.5 (mm)
OD 1 : 93 (mm)
Thread Size : 1-12 UNF-2B
Thread Nut Size : M24X1.5
BPV (kg/cm2) : 2.5
Gasket Type : Square

CONT : 12
VOL : 0.036

378

HC-5508 Hydraulic Oil Filter Spin-On Synthetic Media

KOMATSU 1281327H1
CASE 1346028C1
CATERPILLAR 9T5916



H 1 : 240 (mm)
OD 1 : 94.5 (mm)
Thread Size : 1 3/8-12 UNF-2B

CONT : 12
VOL : 0.036

Note : with Glass Fiber Media

383

HC-56060 Hydraulic Oil Filter Spin-On

KOMATSU 418-18-34160



H 1 : 155 (mm)
OD 1 : 82.5 (mm)
ID 1 : 155 (mm)
Thread Size : M45X1.5-6H
Gasket Type : Round

CONT : 12
VOL : 0.019

Note : for Komatsu Wheel Loader WA200-5

388

HC-45050 Hydraulic Oil Filter Transmission Spin-On Synthetic Media

CASE-IH CNH 1302541
CASE-IH CNH 181167A1
CUMMINS 181167A1



H 1 : 152 (mm)
OD 1 : 94.5 (mm)
Thread Size : 13/16-16 UNF-2B
Gasket Type : Round

CONT : 12
VOL : 0.024

Note : Aluminium casting version

379

HC-55220 Hydraulic Oil Filter Spin-On With Microfiber media

CATERPILLAR 1261815
CHARLES MACHINE 159074



H 1 : 152 (mm)
OD 1 : 94.5 (mm)
Thread Size : 1 3/8-12 UNF-2B

CONT : 12
VOL : 0.024

384

HC-76080 Hydraulic Oil Filter Spin-On Synthetic Media

CASE 1266751H2
CASE 294721A1
J.C.BAMFORD 32905501
NEW HOLLAND (CNH) 9821387
JOHN DEERE AL77061



H 1 : 152 (mm)
OD 1 : 94.5 (mm)
Thread Size : 1 3/8-12 UNF-2B

CONT : 12
VOL : 0.024

Note : with Glass Fiber Media

389

HC-5402 Hydraulic Oil Filter Spin-On

INTERNATIONAL HARVESTER 1103452C2
INTERNATIONAL HARVESTER 1103462-C1



H 1 : 225 (mm)
OD 1 : 127 (mm)
Thread Size : 3X8

CONT : 6
VOL : 0.031

380

HC-5601 Hydraulic Oil Filter Spin-On

KOMATSU 113-60-23160



H 1 : 221 (mm)
OD 1 : 108 (mm)
Thread Size : 1 1/8-16 UNF-2B
Gasket Type : Square

CONT : 6
VOL : 0.023

385

HC-76130 Hydraulic Oil Filter Transmission Spin-On With Microfiber media

ZF 0501323154
J.C.BAMFORD 32925905
CASE 8603535
CASE 87519452
JOHN DEERE AT336140



H 1 : 199 (mm)
OD 1 : 94.5 (mm)
Thread Size : 1 3/8-12 UNF-2B
Thread Stud Size : M24X1.5

CONT : 12
VOL : 0.024

390

Sakura Filter

Technical Specification

HC-7901 Hydraulic Oil Filter Spin-On

INTERNATIONAL HARVESTER
075912103
KOBELCO 2446U141S2



H 1 : 130 (mm)
OD 1 : 93 (mm)
Thread Size : 1 1/8-16 UNF-2B
Gasket Type : Round

CONT : 12
VOL : 0.020

Note : Seat assy zinc coating

391

O-1809 Oil Filter Combination Metal End Cap Element

NISSAN 15274-90225
NISSAN 15274-90228
NISSAN 15274-90229



H 1 : 192 (mm)
H 2 : 182 (mm)
OD 1 : 100 (mm)
OD 2 : 100 (mm)
ID 1 : 40 (mm)
ID 2 : 16.5 (mm)

CONT : 25
VOL : 0.061

Note : Paper Protector

396

O-5601 Oil Filter Full Flow Metal End Cap Element

KOMATSU 6110-53-5120
KOMATSU 6114-50-5100
KOMATSU 6120-50-5103



H 1 : 233.7 (mm)
H 2 : 231.5 (mm)
OD 1 : 100 (mm)
OD 2 : 100 (mm)
ID 1 : 42 (mm)
ID 2 : 42 (mm)

CONT : 20
VOL : 0.080

Note : Paper Protector

401

HC-7906 Hydraulic Oil Filter Spin-On

J.C.BAMFORD 32/901701



H 1 : 178 (mm)
OD 1 : 128.8 (mm)
Thread Size : 1 1/4-11
Gasket Type : Square

CONT : 6
VOL : 0.028

Note : Paper protector

392

O-1901 Oil Filter Full Flow Metal End Cap Element

PERKINS 101606
FORD 2701-E6731A



H 1 : 99 (mm)
H 2 : 97 (mm)
OD 1 : 97 (mm)
OD 2 : 97 (mm)
ID 1 : 34 (mm)
ID 2 : 34 (mm)

CONT : 50
VOL : 0.060

Note : Paper protector

397

O-5603 Oil Filter Full Flow Metal End Cap Element

KOMATSU 6610-50-4400
KOMATSU 6610-50-5100
KOMATSU 6610-51-4400



H 1 : 237 (mm)
H 2 : 231 (mm)
OD 1 : 128 (mm)
OD 2 : 128 (mm)
ID 1 : 56.4 (mm)
ID 2 : 56.4 (mm)

CONT : 25
VOL : 0.128

Note : Paper Protector

402

HC-7913 Hydraulic Oil Filter Spin-On

CLARK 234099
CATERPILLAR 311980
J.C.BAMFORD 4110147
FIAT 906041007



H 1 : 140 (mm)
OD 1 : 93.5 (mm)
Thread Size : 2-16 UNF-2B
Gasket Type : Square

CONT : 12
VOL : 0.024

Note : Paper protector

393

O-1902 Oil Filter Full Flow Metal End Cap Element

MAZDA 0636-23-802
MAZDA 0727-23-820A
MERCURISER 35-16595



H 1 : 114 (mm)
H 2 : 112 (mm)
OD 1 : 97 (mm)
OD 2 : 97 (mm)
ID 1 : 34 (mm)
ID 2 : 34 (mm)

CONT : 50
VOL : 0.066

Note : Paper protector

398

O-5702 Oil Filter Full Flow Metal End Cap Element

CUMMINS 158139
KOMATSU 6610-51-5100
KOMATSU CULF-516



H 1 : 249 (mm)
H 2 : 244.5 (mm)
OD 1 : 126 (mm)
OD 2 : 126 (mm)
ID 1 : 39 (mm)
ID 2 : 39 (mm)

CONT : 9
VOL : 0.050

Note : Paper Protector

403

O-1803 Oil Filter Full Flow Metal End Cap Element

NISSAN 15208-32200
NISSAN 15208-32225
INTERNATIONAL HARVESTER
3110452R91



H 1 : 141 (mm)
H 2 : 137 (mm)
OD 1 : 72.5 (mm)
OD 2 : 72.5 (mm)
ID 1 : 33 (mm)
ID 2 : 33 (mm)

CONT : 50
VOL : 0.051

Note : Paper Protector

394

O-2619 Oil Filter Full Flow Metal End Cap Element

COMP AIR 1078A/06950



H 1 : 262 (mm)
H 2 : 256 (mm)
OD 1 : 90.5 (mm)
OD 2 : 90.5 (mm)
ID 1 : 50 (mm)
ID 2 : 50 (mm)

CONT : 25
VOL : 0.067

Note : Paper Protection

399

O-5703 Oil Filter Full Flow Metal End Cap Element

FORD 1461524
CUMMINS 173174
FORD 68MF6731BAA



H 1 : 195 (mm)
H 2 : 189 (mm)
OD 1 : 121 (mm)
OD 2 : 121 (mm)
ID 1 : 38.5 (mm)
ID 2 : 39 (mm)

CONT : 12
VOL : 0.047

Note : Paper Protector

404

O-18051 Oil Filter By Pass Metal End Cap Element

NISSAN 15274-90226
NISSAN 15274-90227
NISSAN 15274-99126
NISSAN 15274-99227



H 1 : 245 (mm)
H 2 : 235 (mm)
OD 1 : 130 (mm)
OD 2 : 130 (mm)
ID 1 : 15.5 (mm)
ID 2 : 15.5 (mm)

CONT : 25
VOL : 0.119

Note : Paper Protector

395

O-5501 Oil Filter Full Flow Metal End Cap Element

CATERPILLAR 5S-0484
CATERPILLAR 7M-3800



H 1 : 233 (mm)
OD 1 : 97 (mm)
OD 2 : 97 (mm)
ID 1 : 42 (mm)
ID 2 : 42 (mm)

CONT : 25
VOL : 0.066

Note : Paper Protector

400

O-5704 Oil Filter By Pass Can-type Depth

CUMMINS 101855
SUMITOMO 136750
CUMMINS 256838

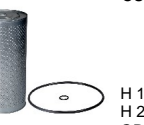

H 1 : 382 (mm)
H 2 : 376 (mm)
OD 1 : 197 (mm)
OD 2 : 197 (mm)
ID 1 : 22 (mm)
ID 2 : 22 (mm)

CONT : 6
VOL : 0.111

Note : Paper Protector

405

Sakura Filter

Technical Specification

O-5705 Oil Filter By Pass Can-type Depth
CUMMINS 256839



H 1 : 248 (mm)
OD 1 : 196.5 (mm)
OD 2 : 196.5 (mm)
ID 1 : 27 (mm)
ID 2 : 27 (mm)

CONT : 9
VOL : 0.120

406

SFC-19100 Fuel/Water Separator Spin-On
KOMATSU 600-311-3620
KOMATSU 600-319-3610



H 1 : 169 (mm)
H 2 : 156 (mm)
OD 1 : 93 (mm)
Thread Size : 1-14 UNS-2B
Thread Nut Size : 1 1/4"X10 UNS-2A
Gasket Type : Square

CONT : 12
VOL : 0.030

Note : bowl not included

411

SFC-56020 Fuel/Water Separator Spin-On 10 Micron
KOMATSU 600-311-3400
KOMATSU 600-311-4510
KOMATSU 600-311-4540
KOBELCO LV21P01018P1-DK



H 1 : 255 (mm)
OD 1 : 118 (mm)
Thread Size : 1 1/4-12 UNF-2B
Gasket Type : Square

CONT : 6
VOL : 0.039

Note : For high pressure fuel injection systems suction side only

416

O-6503 Oil Filter Full Flow Metal End Cap Element
GENERAL MOTORS 357304
GENERAL MOTORS 5573014
GENERAL MOTORS 5573102



H 1 : 231 (mm)
H 2 : 227 (mm)
OD 1 : 109.5 (mm)
OD 2 : 109.5 (mm)
ID 1 : 37 (mm)
ID 2 : 37 (mm)

CONT : 12
VOL : 0.043

Note : Metal Protector

407

SFC-19100B Fuel/Water Separator Spin-On With Bowl
KOMATSU 600-311-3620
KOMATSU 600-319-3610
KOMATSU 600-319-3620



H 1 : 198 (mm)
H 2 : 156 (mm)
OD 1 : 93 (mm)
Thread Size : 1-14 UNS-2B
Thread Nut Size : 1 1/4"X10 UNS-2A
Gasket Type : Square

CONT : 12
VOL : 0.049

Note : SFC-19100 and FB-19100

412

SFC-56020B Fuel/Water Separator Spin-On With Bowl 10 Micron
KOMATSU 600-319-4540



H 1 : 255 (mm)
OD 1 : 118 (mm)
Thread Size : 1 1/4-12 UNF-2B
Gasket Type : Square

CONT : 6
VOL : 0.038

Note : SFC-56020 and FB-1813

417

O-7901 Oil Filter Full Flow Metal End Cap Element
PERKINS 30211
CROSLAND 403
GENERAL MOTORS 6435092



H 1 : 153 (mm)
H 2 : 151 (mm)
OD 1 : 73 (mm)
OD 2 : 73 (mm)
ID 1 : 37 (mm)
ID 2 : 37 (mm)

CONT : 50
VOL : 0.050

Note : Paper Protector

408

SFC-45030 Fuel/Water Separator Spin-On With Drain
CUMMINS 2830348
NEW HOLLAND (CNH) 87803192
CASE-IH CNH 87803194



H 1 : 148 (mm)
OD 1 : 76 (mm)
Thread Size : M16X1.5-6H
Gasket Type : Square

CONT : 12
VOL : 0.019

413

SFC-56040 Fuel/Water Separator Spin-On 10 Micron
CUMMINS 4941237
KOMATSU 600-311-4120
KOMATSU 600-319-4110



H 1 : 118.5 (mm)
OD 1 : 93 (mm)
Thread Size : M24X1.5-6H
Gasket Type : Square

CONT : 12
VOL : 0.022

Note : For high pressure fuel injection systems suction side only

418

SF-52150 Fuel/Water Separator Metal End Cap Element
YANMAR 120324-55760



H 1 : 60 (mm)
H 2 : 60 (mm)
OD 1 : 73 (mm)
OD 2 : 73 (mm)
ID 1 : 11 (mm)
ID 2 : 11 (mm)

CONT : 50
VOL : 0.024

409

SFC-5509-10 Fuel/Water Separator Spin-On 10 Micron
CUMMINS 3406889
CUMMINS 3954891
CUMMINS 3954904
CUMMINS 4070801



H 1 : 211 (mm)
OD 1 : 93 (mm)
Thread Size : 1-14 UNS-2B
Gasket Type : Square

CONT : 12
VOL : 0.036

414

SFC-56050 Fuel/Water Separator Spin-On High Efficiency
KOMATSU 600-319-5610



H 1 : 175 (mm)
OD 1 : 136 (mm)
Thread Size : M36X1.5-6H
Gasket Type : Square

CONT : 6
VOL : 0.027

Note : 10 micron, bowl not included

419

SFC-1905-10 Fuel/Water Separator Secondary Spin-On 10 Micron
MASSEY-FERGUSON 108615W1
BOMAG 31701062
LIEBHERR 7364111
KOBELCO YN02PU1010P1



H 1 : 169 (mm)
H 2 : 156 (mm)
OD 1 : 93 (mm)
Thread Size : 1-14 UNS-2B
Thread Nut Size : 1 1/4"X10 UNS-2B
Gasket Type : Square

CONT : 12
VOL : 0.026

Note : bowl not included

410

SFC-5601-02 Fuel/Water Separator Spin-On High Efficiency
CUMMINS 3089916
KOMATSU 600-311-3110
KOMATSU 600-311-3111
KOMATSU 600-319-3111A



H 1 : 311.4 (mm)
H 2 : 286 (mm)
OD 1 : 118 (mm)
Thread Size : 1 1/4-12 UNF-2B

CONT : 6
VOL : 0.039

Note : High efficiency filter for high pressure fuel injection systems

415

SFC-56060 Fuel/Water Separator Spin-On
KOMATSU 600-319-5910



H 1 : 165 (mm)
H 2 : 147 (mm)
OD 1 : 108 (mm)
Thread Size : M36X1.5-6H

CONT : 12
VOL : 0.032

Note : Komatsu Excavator PC60-8

420

Sakura Filter

Technical Specification

SFC-5611-10 Fuel/Water Separator Secondary Spin-On 10 Micron

KOMATSU 600-311-3410
KOMATSU 600-319-3240A



H 1 : 255 (mm)
OD 1 : 118 (mm)
Thread Size : 1 1/4-12 UNF-2B
Gasket Type : Square

CONT : 6
VOL : 0.032

Note : For high pressure fuel injection systems suction side only

SFC-5708 Fuel/Water Separator Spin-On

CUMMINS 3286503
CUMMINS 3843760
CUMMINS 3903202



H 1 : 140 (mm)
OD 1 : 76 (mm)
Thread Size : M16X1.5-6H

CONT : 25
VOL : 0.033

Note : with drain plug

WC-5703 Coolant Filter Spin-On

CUMMINS 3318319
HITACHI 4266063
KOMATSU 6742-01-3490



H 1 : 136 (mm)
OD 1 : 93 (mm)
Thread Size : 11/16-16 UNF-2B
Gasket Type : Square

CONT : 12
VOL : 0.018

Note : Coolants = 23 units

SFC-5611-10B Fuel/Water Separator Secondary Spin-On With Bowl 10 Micron

KOMATSU 600-311-3410
KOMATSU 600-319-3240A



H 1 : 345 (mm)
H 2 : 255 (mm)
OD 1 : 118 (mm)
Thread Size : 1 1/4-12 UNF-2B
Gasket Type : Square

CONT : 6
VOL : 0.039

Note : For high pressure fuel injection systems suction side only

SFC-5709-10 Fuel/Water Separator Spin-On 10 Micron

CATERPILLAR 256-8753
CUMMINS 3329289
HITACHI 4377880



H 1 : 245 (mm)
OD 1 : 93 (mm)
Thread Size : 1-14 UNS-2B
Gasket Type : Square

CONT : 6
VOL : 0.019

WC-5705 Coolant Filter Spin-On

CUMMINS 299080
CUMMINS 3100304
CUMMINS 3305367



H 1 : 100 (mm)
OD 1 : 93 (mm)
Thread Size : 11/16-16 UNF-2B
Gasket Type : Square

CONT : 12
VOL : 0.018

Note : Coolants = 4 units

SFC-5705 Fuel/Water Separator Spin-On

ISUZU 1-13240044-1
CUMMINS 3308638
CUMMINS 3315843
SUNWARD 750201011130



H 1 : 174 (mm)
OD 1 : 93 (mm)
Thread Size : 1-14 UNS-2B
Gasket Type : Square

CONT : 12
VOL : 0.026

SFC-7301 Fuel/Water Separator Spin-On

GENERAL MOTORS 25312317



H 1 : 191 (mm)
OD 1 : 93 (mm)
Thread Size : 1-12 UNF-2B
Gasket Type : Square

CONT : 12
VOL : 0.033

WC-5706 Coolant Filter Spin-On

KOMATSU 600-411-1140
KOMATSU 600-411-1191



H 1 : 100 (mm)
OD 1 : 93 (mm)
Thread Size : 11/16-16 UNF-2B
Gasket Type : Square

CONT : 12
VOL : 0.018

Note : Coolants = 6 units

SFC-5706 Fuel/Water Separator Spin-On

J.C.BAMFORD 02/910150
J.C.BAMFORD 02/910150A
HYUNDAI 11E1-70210
CUMMINS 3935274
CASE J925274



H 1 : 163.7 (mm)
H 2 : 134 (mm)
OD 1 : 93 (mm)
OD 2 : 92.7 (mm)
Thread Size : 13/16-18 UNF-2B
Thread Nut Size : M14X2
Gasket Type : Square

CONT : 12
VOL : 0.021

TC-56010 Oil Filter Transmission Spin-On With Removal Nut

KAWASAKI 31115-70010
KOMATSU 714-07-28711
KOMATSU 714-07-28712
KOMATSU 714-07-28713



H 1 : 260 (mm)
H 2 : 248 (mm)
OD 1 : 106 (mm)
Thread Size : M60X2-6H
Gasket Type : Square

CONT : 6
VOL : 0.047

WC-5707 Coolant Filter Spin-On

INGERSOLL RAND 35357276
KOMATSU 600-411-1180
KOMATSU 6134-61-8110
KOMATSU 6710-61-8110



H 1 : 135 (mm)
OD 1 : 93 (mm)
Thread Size : 11/16-16 UNF-2B
Gasket Type : Square

CONT : 12
VOL : 0.018

Note : Coolants = 8 units

SFC-5707 Fuel/Water Separator Spin-On With Drain Plug

MTU 0010925601
CUMMINS 3309437
CUMMINS 3313304
HITACHI 4202934



H 1 : 311.4 (mm)
H 2 : 286 (mm)
OD 1 : 115.5 (mm)
Thread Size : 1 1/4-12 UNF-2B
Gasket Type : Square

CONT : 6
VOL : 0.036

WC-56010 Coolant Filter Spin-On

KOMATSU 600-411-1171
KOBELCO LV52V01002P1



H 1 : 200.4 (mm)
OD 1 : 108 (mm)
Thread Size : 11/16-16 UNF-2B
Gasket Type : Square

CONT : 6
VOL : 0.020

WC-5708 Coolant Filter Spin-On

GENERAL MOTORS 23507189
FIAT 4393504
CASE 441365C1



H 1 : 136 (mm)
OD 1 : 93 (mm)
Thread Size : 11/16-16 UNF-2B
Gasket Type : Square

CONT : 12
VOL : 0.027

Note : Coolant = 15 units

WC-5711

Coolant Filter Spin-On

CUMMINS 3315115
 CUMMINS 3316462
 CUMMINS 4058964



H 1 : 100 (mm)
 OD 1 : 93 (mm)
 Thread Size : 11/16-16 UNF-2B
 Gasket Type : Square

CONT : 12
 VOL : 0.014

Note : Coolants = 8 units

436

WC-5712

Coolant Filter Spin-On

CUMMINS 3100307
 CUMMINS 3315114
 CUMMINS 3316053



H 1 : 135 (mm)
 OD 1 : 93 (mm)
 Thread Size : 11/16-16 UNF-2B
 Gasket Type : Square

CONT : 12
 VOL : 0.020

Note : Coolants = 12 units

437

WC-5713

Coolant Filter Spin-On

HITACHI 4228689
 INGERSOLL RAND 57165805



H 1 : 136 (mm)
 OD 1 : 93 (mm)
 Thread Size : 11/16-16 UNF-2B
 Gasket Type : Square

CONT : 12
 VOL : 0.022

Note : Coolants = 15 units

438

WC-6901

Coolant Filter Spin-On

CUMMINS 3305371
 INGERSOLL RAND 56985971



H 1 : 189 (mm)
 OD 1 : 93 (mm)
 Thread Size : 11/16-16 UNF-2B
 Gasket Type : Square

CONT : 12
 VOL : 0.036

Note : Coolants = 23 units

439