



SAKURA

VOLVO

Heavy Equipments

FILTER SUB-CATALOGUE





Table of Contents

Engine Application

A

Technical Specification

B



Engine Application

A

Sakura Filter

ENGINE APPLICATION

MODEL/APPLICATION	SAKURA NO	MODEL/APPLICATION	SAKURA NO	MODEL/APPLICATION	SAKURA NO
VOLVO		VOLVO		VOLVO	
2005 (TRACTORS) 2005 Air Filter Secondary.....	A-6302	414 (DUMP TRUCKS) w / Scania Eng. Fuel Filter.....	FC-7103	Fuel Filter.....	FC-7103
2005 (TRACTORS) w / Volvo Eng. Fuel Filter.....	FC-7103	414B (DUMP TRUCKS) SCANIA SCANIA Air Filter Secondary.....	A-5408	442B (DUMP TRUCKS) SCANIA DS14A Oil Filter Full Flow.....	C-7921
2105 (TRACTORS) Air Filter Secondary.....	A-6302	414B (DUMP TRUCKS) w / Scania Eng. Fuel Filter.....	FC-7103	442B (DUMP TRUCKS) w / Scania DS14A Eng. Fuel Filter.....	FC-7103
2105 (TRACTORS) w / Volvo Eng. Fuel Filter.....	FC-7103	414B (DUMP TRUCKS) w / Scania Eng. Fuel Filter.....	FC-7103	443 (DUMP TRUCKS) SCANIA DS14A Oil Filter Full Flow.....	C-7921
2650 (TRACTORS) Air Filter Secondary.....	A-6302	420 (DUMP TRUCKS) SCANIA SCANIA Oil Filter Full Flow.....	C-7921	445 (DUMP TRUCKS) GMC 12V-71T Oil Filter By Pass.....	O-2605
2650 (TRACTORS) w / Volvo Eng. Fuel Filter.....	FC-7103	425 (DUMP TRUCKS) SCANIA DS11 Air Filter Set.....	A-5425-S	4500 (LOADERS) VOLVO TD70H , 1979-1986 Air Filter Set.....	A-6304-S
2654 (TRACTORS) Air Filter Secondary.....	A-6302	425 (DUMP TRUCKS) w / Scania DS11 Eng. Fuel Filter.....	FC-7103	Air Filter Primary.....	A-6303
2654 (TRACTORS) w / Volvo Eng. Fuel Filter.....	FC-7103	425 (DUMP TRUCKS) w / Scania DS11 Eng. Fuel Filter.....	FC-7103	4600 (LOADERS) VOLVOBM TD100A , 1980-1983 Air Filter Primary.....	A-6303
290BLC (EXCAVATORS) Hydraulic Oil Filter.....	HC-7901	425B (DUMP TRUCKS) SCANIA DS11 Air Filter Set.....	A-5425-S	Air Filter Set.....	A-6304-S
30A (ARTICULATED TRUCKS) Fuel Filter.....	FC-7103	425B (DUMP TRUCKS) w / Scania DS11 Eng. Fuel Filter.....	FC-7103	4600 (LOADERS) VOLVO TD100G Air Filter Set.....	A-6304-S
3500 (MOTOR GRADERS) VOLVO VOLVO Air Filter Primary.....	A-6303	4300 (LOADERS) VOLVOBM TD45 , 1977-1982 Air Filter Secondary.....	A-6302	Air Filter Primary.....	A-6303
Air Filter Set.....	A-6304-S	4300B (LOADERS) VOLVOBM TD45 , 1977-1982 Air Filter Secondary.....	A-6302	Air Filter Set.....	A-6304-S
3700 (MOTOR GRADERS) VOLVO TD70E Air Filter Primary.....	A-6303	435 (DUMP TRUCKS) CUMMINS KT-1150 Fuel Filter.....	FC-5721	5350 (DUMP TRUCKS) VOLVO TD70G Air Filter Primary.....	A-6303
Air Filter Set.....	A-6304-S	Fuel Filter.....	FC-5702	Air Filter Set.....	A-6304-S
412 (DUMP TRUCKS) SCANIA D8 Oil Filter Full Flow.....	C-7921	440 (DUMP TRUCKS) CUMMINS NT-855 Fuel Filter.....	FC-5702	Fuel Filter.....	FC-7103
412 (DUMP TRUCKS) VOLVOBM DS8 Oil Filter Full Flow.....	C-7921	Fuel Filter.....	FC-5721	5350B (DUMP TRUCKS) VOLVO TD70G Air Filter Set.....	A-6304-S
412T (DUMP TRUCKS) SCANIA D8 Oil Filter Full Flow.....	C-7921	441 (DUMP TRUCKS) SCANIA DS14A Oil Filter Full Flow.....	C-7921	Air Filter Primary.....	A-6303
412T (DUMP TRUCKS) VOLVOBM DS8 Oil Filter Full Flow.....	C-7921	441 (DUMP TRUCKS) w / Scania DS14A Eng. Fuel Filter.....	FC-7103	5350B (DUMP TRUCKS) VOLVOBM TD71G Air Filter Set.....	A-6304-S
414 (DUMP TRUCKS) SCANIA SCANIA Air Filter Secondary.....	A-5408	442 (DUMP TRUCKS) SCANIA DS14A Oil Filter Full Flow.....	C-7921	Air Filter Primary.....	A-6303
Oil Filter Full Flow.....	C-7921	442 (DUMP TRUCKS) w / Scania DS14A Eng. Fuel Filter.....	FC-7103	5350B (DUMP TRUCKS) w / Volvo TD70G Eng. Fuel Filter.....	FC-7103
				5350B (DUMP TRUCKS) w / Volvo TD71G Eng. Fuel Filter.....	FC-7103

MODEL/APPLICATION	SAKURA NO
VOLVO	
540 (DUMP TRUCKS) CUMMINS KT-1150	
Fuel Filter.....	FC-5721
Fuel Filter.....	FC-5702
6300 (LOADERS) VOLVO BM TD43B	
Air Filter Secondary.....	A-6302
646B (LOADERS) VOLVOBM D45	
Air Filter Secondary.....	A-6302
646B (LOADERS) VOLVOBM D45B	
Air Filter Secondary.....	A-6302
646B (LOADERS) VOLVOBM TD45	
Air Filter Secondary.....	A-6302
646B (LOADERS) VOLVOBM TD45B	
Air Filter Secondary.....	A-6302
A20C (ARTICULATED TRUCKS) VOLVO TD73 , 1995	
Hydraulic Oil Filter.....	HC-5508
A25C (ARTICULATED TRUCKS)	
Air Filter Secondary.....	A-5311
Air Filter Primary.....	A-6303
Air Filter Breather.....	A-5101
Cabin Air Filter.....	CA-2405
Fuel Filter.....	FC-5723
Fuel Filter.....	FC-7901
Fuel Filter Primary.....	FC-7107
Hydraulic Oil Filter Transmission....	H-7102
Oil Filter By Pass.....	C-5717
Oil Filter Full Flow.....	C-7105
Oil Filter Full Flow.....	C-2508
Oil Filter Full Flow.....	C-71060
A25D (ARTICULATED TRUCKS) VOLVO D10B , 2001-UP	
Air Filter Secondary.....	A-8580
Air Filter Set.....	AS-8579-S
Air Filter Primary.....	AS-8579M
Air Filter Breather.....	A-5101
Air Filter Primary.....	AS-8579
Air Filter Breather.....	A-2417
Cabin Air Filter.....	CA-2401
Cabin Air Filter.....	CA-2402
Cabin Air Filter.....	CAV-2401
Coolant Filter.....	WC-7101
Fuel Filter.....	FC-7102
Fuel/Water Separator Primary.....	SFC-7912-30
Hydraulic Oil Filter.....	HC-5508
Oil Filter Full Flow.....	C-7105
Oil Filter By Pass.....	C-5717
A30 (ARTICULATED TRUCKS) 9.6L 9603cc 586 CID	
Fuel Filter.....	FC-7103

MODEL/APPLICATION	SAKURA NO
VOLVO	
A30C (ARTICULATED TRUCKS) VOLVO TD104 , 1997-2001	
Air Filter Primary.....	AS-8579
Air Filter Set.....	AS-8579-S
Air Filter Primary.....	AS-8579M
Air Filter Secondary.....	A-8580
Fuel/Water Separator Primary.....	SFC-7912-30
Hydraulic Oil Filter.....	HC-5508
A30C (ARTICULATED TRUCKS) VOLVO TD103 , 1996-1997	
Air Filter Primary.....	AS-8579M
Air Filter Set.....	AS-8579-S
Air Filter Primary.....	AS-8579
Air Filter Secondary.....	A-8580
Fuel/Water Separator Primary.....	SFC-7912-30
Hydraulic Oil Filter.....	HC-5508
A30C (ARTICULATED TRUCKS)	
Air Filter Primary.....	AS-8579M
Air Filter Secondary.....	A-8580
Air Filter Primary.....	AS-8579
Air Filter Set.....	AS-8579-S
Air Filter Breather.....	A-5101
Cabin Air Filter.....	CA-2405
Coolant Filter.....	WC-71030
Coolant Filter.....	WC-7101
Fuel Filter Primary.....	FC-7107
Fuel Filter.....	FC-5723
Fuel/Water Separator Primary.....	SFC-7912-30
Hydraulic Oil Filter.....	HC-5508
Oil Filter By Pass.....	C-5717
Oil Filter Full Flow.....	C-7105
Oil Filter Full Flow.....	C-71060
Oil Filter Full Flow.....	C-2508
A30D (ARTICULATED TRUCKS) VOLVO D9A , 2004-UP	
Air Filter Secondary.....	A-8580
Air Filter Primary.....	AS-8579
Air Filter Breather.....	A-5101
Air Filter Primary.....	AS-8579M
Air Filter Set.....	AS-8579-S
Fuel Filter.....	FC-7108
Oil Filter Full Flow.....	C-7105
Oil Filter By Pass.....	C-5717
A35 (ARTICULATED TRUCKS) 12.0L 11995cc 732 CID	
Fuel Filter.....	FC-7103
A35C (ARTICULATED TRUCKS)	
Air Filter Set.....	A-7912-S
Air Filter Primary.....	A-5718
Air Filter Secondary.....	A-7915
Air Filter Set.....	A-7119-S
Air Filter Secondary.....	A-5715
Air Filter Primary.....	A-7912
Air Filter Breather.....	A-5101
Air Filter Primary.....	A-7118
Air Filter Secondary.....	A-7117

MODEL/APPLICATION	SAKURA NO
VOLVO	
Cabin Air Filter.....	CA-2405
Coolant Filter.....	WC-7101
Coolant Filter.....	WC-71030
Fuel Filter Primary.....	FC-7107
Fuel Filter.....	FC-5723
Fuel/Water Separator Primary.....	SFC-7912-30
Hydraulic Oil Filter.....	HC-5508
Oil Filter Full Flow.....	C-7105
Oil Filter By Pass.....	C-5717
Oil Filter Full Flow.....	C-71060
Oil Filter Full Flow.....	C-2508
A40 (ARTICULATED TRUCKS)	
Air Filter Secondary.....	A-7117
Air Filter Secondary.....	A-5715
Air Filter Primary.....	A-7118
Air Filter Set.....	A-7119-S
Air Filter Breather.....	A-5101
Air Filter Primary.....	A-5718
Cabin Air Filter.....	CA-2405
Coolant Filter.....	WC-7101
Fuel Filter.....	FC-5723
Fuel Filter Primary.....	FC-7107
Fuel/Water Separator Primary.....	SFC-7912-30
Hydraulic Oil Filter.....	HC-5508
Oil Filter Full Flow.....	C-71060
Oil Filter Full Flow.....	C-2508
Oil Filter By Pass.....	C-5717
Oil Filter Full Flow.....	C-7105
A40D (ARTICULATED TRUCKS) 2000-UP	
Air Filter Breather.....	A-5101
Air Filter Breather.....	A-2417
Air Filter Secondary.....	A-7109
Air Filter Set.....	A-7110-S
Air Filter Primary.....	A-7108
Cabin Air Filter.....	CA-2402
Cabin Air Filter.....	CAV-2401
Cabin Air Filter.....	CA-2401
Coolant Filter.....	WC-7101
Fuel Filter.....	FC-7102
Fuel/Water Separator Primary.....	SFC-7912-30
Hydraulic Oil Filter.....	H-85560
Hydraulic Oil Filter.....	HC-5508
Oil Filter By Pass.....	C-5717
Oil Filter Full Flow.....	C-7105
A40E (ARTICULATED TRUCKS) 2007-UP	
Air Filter Secondary.....	A-71460
Air Filter Breather.....	A-2417
Air Filter Primary.....	A-71450
Air Filter Set.....	A-71470-S
Cabin Air Filter.....	CA-2401
Cabin Air Filter.....	CA-2402
Cabin Air Filter.....	CAV-2401
Fuel Filter.....	FC-7108
Fuel/Water Separator.....	SFC-5301-10B
Fuel/Water Separator.....	SFC-5301-10
Hydraulic Oil Filter.....	HC-5504
Oil Filter Full Flow.....	C-7105

Sakura Filter

ENGINE APPLICATION

MODEL/APPLICATION	SAKURA NO	MODEL/APPLICATION	SAKURA NO	MODEL/APPLICATION	SAKURA NO
VOLVO		VOLVO		VOLVO	
A40E (<i>ARTICULATED TRUCKS</i>) 2007-UP Oil Filter By Pass.....	C-5717	Air Filter Set.....	A-56731-S	EC140B (<i>EXCAVATORS</i>) VOLVO D4D EAE1 , 1996 Air Filter Primary.....	A-56731
ABG7820 (<i>ASPHALT PAVER</i>) DEUTZ AG TCD2013 L06 2V Air Filter Primary.....	AS-5102	BL70 (<i>LOADERS</i>) VOLVO D4D 10001 - 11488 Hydraulic Oil Filter.....	HC-7001	Air Filter Set.....	A-56731-S
Air Filter Set.....	AS-5102-S	BL70 (<i>LOADERS</i>) VOLVO D5D 11489 - UP Air Filter Primary.....	A-56731	Air Filter Secondary.....	A-56741
ABG7820B (<i>ASPHALT PAVER</i>) VOLVO D7E , 2011 Air Filter Primary.....	AS-5102	Hydraulic Oil Filter.....	HC-7001	EC140B (<i>EXCAVATORS</i>) D4D Fuel Filter.....	EF-2405
Air Filter Set.....	AS-5102-S	BL71 (<i>LOADERS</i>) VOLVO D5D , 2011 Air Filter Secondary.....	A-56741	EC140B (<i>EXCAVATORS</i>) Air Filter Primary.....	A-5673
ABG8820B (<i>ASPHALT PAVER</i>) VOLVO D7E , 2011 Air Filter Set.....	AS-5102-S	Air Filter Set.....	A-56731-S	Air Filter Set.....	A-5675-S
Air Filter Primary.....	AS-5102	Air Filter Primary.....	A-56731	Air Filter Breather.....	A-71330
BL61 (<i>LOADERS</i>) VOLVO D5D , 2011 Air Filter Secondary.....	A-56741	Air Filter Secondary.....	A-5541M	Air Filter Secondary.....	A-8670
Air Filter Primary.....	A-56731	Cabin Air Filter.....	CA-2401	Cabin Air Filter.....	CA-71010
Air Filter Set.....	A-56731-S	Cabin Air Filter.....	CAV-2401	Cabin Air Filter.....	CA-71020
BL61 (<i>LOADERS</i>) VOLVO D4D CBE1 , 2002 Hydraulic Oil Filter.....	HC-7001	Fuel Filter.....	FC-71100	Coolant Filter.....	WC-7101
BL61 PLUS (<i>LOADERS</i>) VOLVO D5D , 2011 Air Filter Primary.....	A-56731	Fuel/Water Separator Secondary... SFC-7101-10 Hydraulic Oil Filter Transmission.. HC-45050 Hydraulic Oil Filter.....	HC-5506	Fuel/Water Separator.....	SF-7922
Air Filter Set.....	A-56731-S	Oil Filter Full Flow.....	C-6202	Hydraulic Oil Filter.....	H-7101
Air Filter Secondary.....	A-56741	BL71 (<i>LOADERS</i>) VOLVO D4D CBE1 , 2002 Hydraulic Oil Filter.....	HC-7001	Hydraulic Oil Filter.....	H-2719
BL61 PLUS (<i>LOADERS</i>) VOLVO , 2007 Hydraulic Oil Filter.....	HC-7001	BL71 PLUS (<i>LOADERS</i>) VOLVO D5D , 2011 Air Filter Set.....	A-56731-S	Hydraulic Oil Filter.....	HC-8805
BL61 PLUS (<i>LOADERS</i>) VOLVO D4D CBE1 , 2002 Hydraulic Oil Filter.....	HC-7001	Air Filter Secondary.....	A-56741	Oil Filter Full Flow.....	EO-2626
BL60 (<i>LOADERS</i>) VOLVO D5D 11315 - UP , 2012 Air Filter Primary.....	A-56731	Air Filter Primary.....	A-56731	EC160 (<i>EXCAVATORS</i>) 4.0L 3998cc 244 CID , 4000 Fuel Filter.....	FC-7103
Air Filter Set.....	A-56731-S	BL71 PLUS (<i>LOADERS</i>) VOLVO , 2007 Hydraulic Oil Filter.....	HC-7001	EC160 (<i>EXCAVATORS</i>) 1996-UP Air Filter Secondary.....	A-6705
Air Filter Secondary.....	A-56741	BL71B (<i>LOADERS</i>) VOLVO D5D , 2011 Air Filter Set.....	A-56731-S	Fuel Filter.....	FC-5715
BL60 (<i>LOADERS</i>) Air Filter Secondary.....	A-5540	Air Filter Primary.....	A-56731	Oil Filter Full Flow.....	C-5102
Air Filter Primary.....	A-5541	Air Filter Secondary.....	A-56741	Oil Filter Full Flow.....	C-7105
Air Filter Set.....	A-5541M-S	DR861 (<i>ARTICULATED TRUCKS</i>) w / Volvo TD60A Eng. Fuel Filter.....	FC-7103	EC160B (<i>EXCAVATORS</i>) VOLVO D6D EHE2 , 2003 Air Filter Secondary.....	A-56741
Air Filter Primary.....	A-76231	DR860T (<i>ARTICULATED TRUCKS</i>) w / Volvo TD60A Eng. Fuel Filter.....	FC-7103	Air Filter Set.....	A-56731-S
Air Filter Primary.....	A-5541M	EC140B (<i>EXCAVATORS</i>) VOLVO D4D , 2002 Air Filter Secondary.....	A-56741	Air Filter Primary.....	A-56731
Cabin Air Filter.....	CAV-2401	EC160B (<i>EXCAVATORS</i>) D6D Fuel Filter.....	EF-2405	EC160B (<i>EXCAVATORS</i>) Air Filter Breather.....	A-71330
Cabin Air Filter.....	CA-2401	EC160C (<i>EXCAVATORS</i>) VOLVO (S/N: V-ACT-UP) , 2007-UP Fuel Filter.....	FC-71120	Air Filter Primary.....	A-5673
Fuel/Water Separator Secondary... SFC-7101-10 Hydraulic Oil Filter.....	HC-5506	EC160C (<i>EXCAVATORS</i>) VOLVO (S/N: V-ACT-UP) , 2007-UP Fuel Filter.....	FC-71120	Air Filter Set.....	A-5675-S
Hydraulic Oil Filter Transmission.. HC-45050 Oil Filter Full Flow.....	C-6202	Air Filter Secondary.....	A-56741	Air Filter Secondary.....	A-8670
BL61B (<i>LOADERS</i>) VOLVO D5D , 2011 Air Filter Primary.....	A-56731	Air Filter Set.....	A-56731-S	Cabin Air Filter.....	CA-71020
Air Filter Secondary.....	A-56741	Air Filter Primary.....	A-56731	Cabin Air Filter.....	CA-71010

MODEL/APPLICATION	SAKURA NO	MODEL/APPLICATION	SAKURA NO	MODEL/APPLICATION	SAKURA NO
VOLVO		VOLVO		VOLVO	
EC160C (EXCAVATORS) VOLVO D6E , 2007		EC140 (EXCAVATORS) CUMMINS , 1996-UP		EC240C L (EXCAVATORS) VOLVO D7E	
Air Filter Primary.....	A-56731	Air Filter Secondary.....	A-6008	Air Filter Primary.....	AS-5102
Air Filter Set.....	A-56731-S	Air Filter Breather.....	A-71330	Air Filter Set.....	AS-5102-S
Air Filter Secondary.....	A-56741	Fuel Filter Secondary.....	FC-7903		
Hydraulic Oil Filter.....	H-7106	Fuel/Water Separator.....	SFC-5706	EC240C LR (EXCAVATORS) VOLVO D7E	
		Hydraulic Oil Filter.....	HC-8805	Air Filter Set.....	AS-5102-S
EC180C (EXCAVATORS) VOLVO D6E , 2007		Hydraulic Oil Filter.....	H-2719	Air Filter Primary.....	AS-5102
Air Filter Secondary.....	A-56741	Oil Filter Full Flow.....	C-5704		
Air Filter Primary.....	A-56731			EC240C NL (EXCAVATORS) VOLVO D7E	
Air Filter Set.....	A-56731-S	EC15BXR (EXCAVATORS) S/N: 10151-99999 , 2005-UP		Air Filter Primary.....	AS-5102
Hydraulic Oil Filter.....	H-7106	Air Filter Primary.....	A-8504	Air Filter Set.....	AS-5102-S
		Oil Filter Full Flow.....	C-1011		
EC135B (EXCAVATORS) D4D		EC180 (EXCAVATORS)		EC250D (EXCAVATORS) VOLVO D8H , 2011	
Fuel Filter.....	EF-2405	Air Filter Secondary.....	A-6705	Air Filter Primary.....	AS-5102
		Fuel Filter.....	FC-5715	Air Filter Set.....	AS-5102-S
EC135B (EXCAVATORS) VOLVO D4D		Oil Filter Full Flow.....	C-5102		
Air Filter Primary.....	A-56731	EC140C (EXCAVATORS) VOLVO D4E		EC250DL (EXCAVATORS) VOLVO DH8 INTERIM TIER 4 , 2012	
Air Filter Secondary.....	A-56741	Hydraulic Oil Filter.....	H-7106	Air Filter Primary.....	AS-5102
Air Filter Set.....	A-56731-S			Air Filter Set.....	AS-5102-S
		EC200 (EXCAVATORS) S/N: 2760--UP , 1996-UP		EC250DLR (EXCAVATORS) VOLVO DH8 INTERIM TIER 4 , 2012	
EC160C L (EXCAVATORS) VOLVO D6E		Air Filter Secondary.....	A-7105	Air Filter Primary.....	AS-5102
Air Filter Primary.....	A-56731	Air Filter Primary.....	A-7106	Air Filter Set.....	AS-5102-S
Air Filter Secondary.....	A-56741	Fuel Filter.....	FC-5723		
Air Filter Set.....	A-56731-S	Fuel Filter.....	FC-7901	EC250DNL (EXCAVATORS) VOLVO DH8 INTERIM TIER 4 , 2012	
		Fuel Filter Primary.....	FC-7107	Air Filter Set.....	AS-5102-S
EC160C NL (EXCAVATORS) VOLVO D6E		Oil Filter Full Flow.....	C-71060	Air Filter Primary.....	AS-5102
Air Filter Primary.....	A-56731	Oil Filter Full Flow.....	C-7105		
Air Filter Set.....	A-56731-S	EC240B (EXCAVATORS) VOLVO D7D		EC290B (EXCAVATORS) VOLVO D7D	
Air Filter Secondary.....	A-56741	Air Filter Primary.....	AS-5102	Air Filter Primary.....	AS-5102
		Air Filter Set.....	AS-5102-S	Air Filter Set.....	AS-5102-S
EC180B (EXCAVATORS) VOLVO D6D EHE2 , 2003		EC240B (EXCAVATORS) VOLVO D7E		EC290C (EXCAVATORS) VOLVO D7E , 2007	
Air Filter Set.....	A-56731-S	Air Filter Primary.....	AS-5102	Air Filter Set.....	AS-5102-S
Air Filter Secondary.....	A-56741	Air Filter Set.....	AS-5102-S	Air Filter Primary.....	AS-5102
Air Filter Primary.....	A-56731			Air Filter Set.....	AS-5102-S
EC180B (EXCAVATORS) D6D		EC240B (EXCAVATORS) VOLVO D7DEBEZ		EC290C L (EXCAVATORS) VOLVO D7E	
Fuel Filter.....	EF-2405	Air Filter Breather.....	A-71330	Air Filter Primary.....	AS-5102
		Air Filter Primary.....	AS-5102	Air Filter Set.....	AS-5102-S
EC180C L (EXCAVATORS) VOLVO D6E		Air Filter Set.....	AS-5102-S	EC290C LR (EXCAVATORS) VOLVO D7E	
Air Filter Secondary.....	A-56741	Air Filter Secondary.....	A-8651	Air Filter Primary.....	AS-5102
Air Filter Set.....	A-56731-S	Cabin Air Filter.....	CA-71020	Air Filter Set.....	AS-5102-S
Air Filter Primary.....	A-56731	Coolant Filter.....	WC-7101		
		Fuel Filter.....	FC-71100	EC290C NL (EXCAVATORS) VOLVO D7E	
EC180D (EXCAVATORS) VOLVO D4HINTERIM TIER 4 , 2012		Fuel Filter.....	FC-71120	Air Filter Primary.....	AS-5102
Air Filter Secondary.....	A-56741	Hydraulic Oil Filter.....	H-7101	Air Filter Set.....	AS-5102-S
Air Filter Primary.....	A-56731	Hydraulic Oil Filter.....	HC-7901		
Air Filter Set.....	A-56731-S	Hydraulic Oil Filter.....	HC-8805	EC240BLC (EXCAVATORS)	
		Hydraulic Oil Filter.....	H-2719	Air Filter Set.....	AS-5102-S
EC130C (EXCAVATORS) 1996-UP		Oil Filter Full Flow.....	C-6204	Air Filter Set.....	AS-5102-S
Air Filter Primary.....	A-6207			Air Filter Secondary.....	A-8651
Air Filter Secondary.....	A-6302	EC240C (EXCAVATORS) VOLVO D7E , 2007		Air Filter Primary.....	AS-5102
Coolant Filter.....	WC-7101	Air Filter Primary.....	AS-5102	Air Filter Breather.....	A-71330
Fuel Filter.....	FC-5704			Cabin Air Filter.....	CA-71010
Fuel Filter.....	FC-5105				
Fuel Filter.....	FC-7901				

MODEL/APPLICATION	SAKURA NO	MODEL/APPLICATION	SAKURA NO	MODEL/APPLICATION	SAKURA NO
VOLVO		VOLVO		VOLVO	
EC240BLC (EXCAVATORS)		Fuel/Water Separator Primary..... SFC-7912-30		Air Filter Primary..... A-28710	
Fuel Filter..... FC-71100		Oil Filter By Pass..... C-5717		Coolant Filter..... WC-5713	
Fuel/Water Separator..... SF-7922		Oil Filter Full Flow..... C-7105		Fuel/Water Separator..... SFC-5705	
Hydraulic Oil Filter..... H-7101		Oil Filter Full Flow..... C-71060		Hydraulic Oil Filter..... H-2709	
Oil Filter Full Flow..... C-6204		EC290 (EXCAVATORS) 1996-UP		Hydraulic Oil Filter..... H-2719	
EC210C (EXCAVATORS) VOLVO D6E , 2007		Air Filter Set..... A-28730-S		Hydraulic Oil Filter..... HC-5602	
Air Filter Set..... A-56731-S		Air Filter Secondary..... A-7967		Oil Filter Combination..... C-5723	
Air Filter Primary..... A-56731		Air Filter Breather..... A-71330		EC390 (EXCAVATORS)	
Air Filter Secondary..... A-56741		Air Filter Primary..... A-28710		Air Filter Secondary..... A-8651	
Hydraulic Oil Filter..... H-7106		Coolant Filter..... WC-5711		Air Filter Set..... AS-5102-S	
EC210 (EXCAVATORS) 1996-UP		Fuel Filter Secondary..... FC-7903		Air Filter Primary..... AS-5102	
Air Filter Secondary..... A-6008		Fuel/Water Separator..... SFC-5706		Coolant Filter..... WC-7101	
Air Filter Breather..... A-71330		Hydraulic Oil Filter..... H-2719		Fuel Filter Primary..... FC-7107	
Fuel Filter Secondary..... FC-7903		Hydraulic Oil Filter..... HC-8805		Fuel Filter..... FC-5723	
Fuel/Water Separator..... SFC-5706		Oil Filter Combination..... C-5723		Fuel Filter..... FC-5704	
Hydraulic Oil Filter..... HC-8805		EC235C (EXCAVATORS) VOLVO D6E , 2007		Fuel/Water Separator Primary..... SFC-7912-30	
Hydraulic Oil Filter..... H-2719		Hydraulic Oil Filter..... H-7106		Hydraulic Oil Filter..... HC-5508	
Oil Filter Full Flow..... C-5704		EC300D (EXCAVATORS) VOLVO D8H , 2011		Oil Filter Full Flow..... C-7105	
EC210B (EXCAVATORS) VOLVO D6D EFE2		Air Filter Set..... AS-5102-S		Oil Filter Full Flow..... C-71060	
Air Filter Breather..... A-71330		Air Filter Primary..... AS-5102		Oil Filter By Pass..... C-5717	
Air Filter Secondary..... A-7105		EC300DL (EXCAVATORS) VOLVO D8H INTERIM TIER 4 , 2012		EC360CL (EXCAVATORS) D12DEBE3	
Air Filter Primary..... A-7106		Air Filter Primary..... AS-5102		Hydraulic Oil Filter Return..... H-71210	
Cabin Air Filter..... CA-71020		Air Filter Set..... AS-5102-S		EC450 (EXCAVATORS)	
Cabin Air Filter..... CA-71010		EC300DLR (EXCAVATORS) VOLVO D8H INTERIM TIER 4 , 2012		Air Filter Secondary..... A-6224	
Coolant Filter..... WC-7101		Air Filter Primary..... AS-5102		Air Filter Primary..... A-68042	
Fuel/Water Separator..... SF-7922		Air Filter Set..... AS-5102-S		Air Filter Set..... A-68042-S	
Hydraulic Oil Filter..... H-7101		EC300DNL (EXCAVATORS) VOLVO D8H INTERIM TIER 4 , 2012		Coolant Filter..... WC-7101	
Hydraulic Oil Filter..... HC-8805		Air Filter Set..... AS-5102-S		Fuel Filter..... FC-5723	
Hydraulic Oil Filter..... H-2719		Air Filter Primary..... AS-5102		Fuel Filter..... FC-7901	
Oil Filter Full Flow..... EO-2404		EC300DNL (EXCAVATORS) VOLVO D8H INTERIM TIER 4 , 2012		Fuel Filter Primary..... FC-7107	
EC240 (EXCAVATORS) 1996-UP		Air Filter Set..... AS-5102-S		Fuel Filter..... FC-5704	
Air Filter Secondary..... A-6008		Air Filter Primary..... AS-5102		Oil Filter Full Flow..... C-7105	
Air Filter Breather..... A-71330		EC30 (EXCAVATORS) S/N: 10151-99999 , 2005-UP		Oil Filter Full Flow..... C-71060	
Coolant Filter..... WC-5711		Air Filter Primary..... A-8513		Oil Filter By Pass..... C-5717	
Fuel Filter Secondary..... FC-7903		Oil Filter Full Flow..... C-1011		EC460C (EXCAVATORS) VOLVO D12D , 2008-UP	
Fuel/Water Separator..... SFC-5706		EC330B (EXCAVATORS)		Hydraulic Oil Filter additional part. H-7105	
Hydraulic Oil Filter..... H-2719		Air Filter Secondary..... A-8580		EC460 (EXCAVATORS) 1996-UP	
Hydraulic Oil Filter..... HC-8805		Air Filter Primary..... AS-8579M		Air Filter Secondary..... A-2207	
Oil Filter Combination..... C-5723		Air Filter Set..... AS-8579-S		Air Filter Primary..... A-2209	
EC25 (EXCAVATORS) MITSUBISHI S3L2 (S/N: 10151-99999) , 2005-UP		Air Filter Primary..... AS-8579		Air Filter Set..... A-2209-S	
Air Filter Secondary..... A-5569		Cabin Air Filter..... CA-71020		Coolant Filter..... WC-5713	
Air Filter Primary..... A-8513		Coolant Filter..... WC-7101		Fuel/Water Separator..... SFC-5705	
Hydraulic Oil Filter..... HC-55190		Fuel Filter..... FC-7102		Hydraulic Oil Filter..... HC-5602	
Oil Filter Full Flow..... C-1011		Hydraulic Oil Filter..... H-2719		Hydraulic Oil Filter..... H-2709	
EC280 (EXCAVATORS)		Hydraulic Oil Filter..... H-2709		Hydraulic Oil Filter..... H-2719	
Air Filter Primary..... A-5301		Hydraulic Oil Filter..... HC-5602		Oil Filter Combination..... C-5723	
Air Filter Secondary..... A-6210		Oil Filter Full Flow..... C-7105		EC460B (EXCAVATORS)	
Coolant Filter..... WC-7101		Oil Filter By Pass..... C-5717		Air Filter Secondary..... A-7117	
Fuel Filter..... FC-5704		EC360 (EXCAVATORS) 1996-UP		Air Filter Primary..... A-7118	
Fuel Filter Primary..... FC-7107		Air Filter Secondary..... A-7967		Air Filter Set..... A-7119-S	
Fuel Filter..... FC-5723		Air Filter Set..... A-28730-S		Cabin Air Filter..... CA-71020	
				Coolant Filter..... WC-7101	
				Fuel Filter..... FC-7102	

MODEL/APPLICATION	SAKURA NO	MODEL/APPLICATION	SAKURA NO	MODEL/APPLICATION	SAKURA NO
VOLVO		VOLVO		VOLVO	
EC460B (EXCAVATORS)		ECR58 (EXCAVATORS) S/N: 10001-99999 , 2005-UP		Fuel Filter.....	FC-71100
Hydraulic Oil Filter.....	H-2719	Air Filter Primary.....	A-8505	Fuel/Water Separator Secondary...	SFC-7101-10
Hydraulic Oil Filter.....	H-2709	Air Filter Secondary.....	A-8599	Oil Filter Full Flow.....	C-6204
Hydraulic Oil Filter.....	HC-5602	Oil Filter Full Flow.....	C-1720	EW170 (EXCAVATORS) 1996-UP	
Oil Filter By Pass.....	C-5717	ECR88 (EXCAVATORS) S/N: 10001-99999 , 2005-UP		Air Filter Breather.....	A-71330
Oil Filter Full Flow.....	C-7105	Air Filter Primary.....	A-8505	Air Filter Secondary.....	A-6008
EC460B LC (EXCAVATORS)		Air Filter Secondary.....	A-8599	Fuel Filter Secondary.....	FC-7903
Hydraulic Oil Filter.....	HC-5602	Oil Filter Full Flow.....	C-1720	Fuel/Water Separator.....	SFC-5706
EC480E (EXCAVATORS) D13J		ECR35D (EXCAVATORS) VOLVO D1.8A		Hydraulic Oil Filter.....	HC-8805
Hydraulic Oil Filter Return.....	H-71210	Fuel Filter.....	FC-24010	Hydraulic Oil Filter.....	H-2719
EC55B (EXCAVATORS) S/N: 30001-99999 , 2005-UP		ECR50D (EXCAVATORS) VOLVO D2.6A		Oil Filter Full Flow.....	C-5704
Air Filter Primary.....	A-8505	Fuel Filter.....	FC-24010	EW180B (EXCAVATORS) 2005-UP	
Air Filter Secondary.....	A-8599	ECR145 (EXCAVATORS)		Air Filter Secondary.....	A-8578
EC55B (EXCAVATORS)		Hydraulic Oil Filter.....	H-7106	Air Filter Primary.....	A-8577
Air Filter Primary.....	A-8505	EW160 (EXCAVATORS) 4.0L 3998cc 244 CID , 4000		Cabin Air Filter.....	CA-71020
EC650 (EXCAVATORS)		Fuel Filter.....	FC-7103	Fuel Filter.....	FC-71100
Air Filter Secondary.....	A-6224	EW140C (EXCAVATORS) 2007-UP		Fuel/Water Separator Secondary...	SFC-7101-10
Air Filter Primary.....	A-68042	Air Filter Set.....	A-5675-S	Oil Filter Full Flow.....	C-6204
Air Filter Set.....	A-68042-S	Air Filter Breather.....	A-71330	EW145B (EXCAVATORS) D6D	
Coolant Filter.....	WC-7101	Air Filter Secondary.....	A-8670	Fuel Filter.....	EF-2405
Fuel Filter Primary.....	FC-7107	Air Filter Primary.....	A-5673	EW200 (EXCAVATORS) S/N: 3175-UP	
Fuel Filter.....	FC-5704	Cabin Air Filter.....	CA-2401	Air Filter Secondary.....	A-7105
Fuel Filter.....	FC-5723	Cabin Air Filter.....	CAV-2401	Air Filter Primary.....	A-7106
Fuel Filter.....	FC-7901	Fuel/Water Separator.....	SFC-5301-10	Fuel Filter.....	FC-5723
Oil Filter Full Flow.....	C-71060	Fuel/Water Separator.....	SFC-5301-10B	Fuel Filter Primary.....	FC-7107
Oil Filter Full Flow.....	C-7105	Oil Filter Full Flow.....	C-6204	Fuel Filter.....	FC-7901
Oil Filter By Pass.....	C-5717	EW140C (EXCAVATORS) VOLVO D5E , 2007		Oil Filter Full Flow.....	C-71060
ECR305C (EXCAVATORS) VOLVO D7E , 2011		Air Filter Secondary.....	A-56741	Oil Filter Full Flow.....	C-7105
Air Filter Primary.....	AS-5102	Air Filter Primary.....	A-56731	EW230B (EXCAVATORS) S/N: 1736--UP	
Air Filter Set.....	AS-5102-S	Air Filter Set.....	A-56731-S	Air Filter Primary.....	A-7106
ECR305CL (EXCAVATORS) VOLVO D7E , 2011		EW140D (EXCAVATORS) VOLVO D4H , 2012		Air Filter Secondary.....	A-7105
Air Filter Set.....	AS-5102-S	Air Filter Secondary.....	A-56741	Fuel Filter.....	FC-7901
Air Filter Primary.....	AS-5102	Air Filter Primary.....	A-56731	Fuel Filter.....	FC-5723
ECR235C L (EXCAVATORS) VOLVO D6E		Air Filter Set.....	A-56731-S	Fuel Filter Primary.....	FC-7107
Air Filter Primary.....	A-56731	EW130C (EXCAVATORS)		Oil Filter Full Flow.....	C-71060
Air Filter Set.....	A-56731-S	Air Filter Primary.....	A-6207	Oil Filter Full Flow.....	C-7105
Air Filter Secondary.....	A-56741	Air Filter Secondary.....	A-6302	EW200B (EXCAVATORS) VOLVO D6D EFE2 , 2005-UP	
Hydraulic Oil Filter.....	H-7106	Coolant Filter.....	WC-7101	Air Filter Primary.....	A-8577
ECR28 (EXCAVATORS) S/N: 60110151-60199999 , 2005-UP		Fuel Filter.....	FC-5704	Air Filter Secondary.....	A-8578
Air Filter Secondary.....	A-5569	Fuel Filter.....	FC-7901	EW210C (EXCAVATORS) VOLVO D6E , 2008-UP	
Oil Filter Full Flow.....	C-1809	Oil Filter Full Flow.....	C-5102	Air Filter Secondary.....	A-7105
ECR38 (EXCAVATORS) S/N: 60210151-60299999 , 2005-UP		EW160B (EXCAVATORS) VOLVO , 2004-UP		Air Filter Primary.....	A-7106
Air Filter Secondary.....	A-5569	Air Filter Primary.....	A-8577	EW55B (EXCAVATORS) S/N: 30001-99999 , 2005-UP	
Air Filter Primary.....	A-8513	Air Filter Secondary.....	A-8578	Air Filter Primary.....	A-8505
Hydraulic Oil Filter.....	HC-5506	Cabin Air Filter.....	CA-71020	Air Filter Secondary.....	A-8599
				FC2924C (EXCAVATORS) VOLVO D7E , 2011	
				Air Filter Primary.....	AS-5102
				Air Filter Set.....	AS-5102-S

Sakura Filter

ENGINE APPLICATION

MODEL/APPLICATION	SAKURA NO	MODEL/APPLICATION	SAKURA NO	MODEL/APPLICATION	SAKURA NO
VOLVO		VOLVO		VOLVO	
FC3329C (EXCAVATORS) VOLVO D7E , 2011 Air Filter Set..... AS-5102-S Air Filter Primary..... AS-5102		Fuel/Water Separator..... SFC-5706 Hydraulic Oil Filter..... HC-5508 Hydraulic Oil Filter..... HC-5503		G946B (MOTOR GRADERS) VOLVO D8H , 2011 Air Filter Primary..... AS-5102 Air Filter Set..... AS-5102-S Hydraulic Oil Filter..... HC-7001	
FE42T (TRACTORS) CAT 3116 Oil Filter Full Flow..... C-5510		G730B (MOTOR GRADERS) VOLVO D7D Air Filter Set..... AS-5102-S Air Filter Primary..... AS-5102		G960 (MOTOR GRADERS) VOLVO D7E , 2006 Air Filter Primary..... AS-5102 Air Filter Set..... AS-5102-S Hydraulic Oil Filter..... HC-7001	
FE42T (TRACTORS) VOLVO VE7 Fuel Filter Primary..... FC-7107 Fuel Filter..... FC-5723 Oil Filter By Pass..... C-5717 Oil Filter Full Flow..... C-71060		G740 (MOTOR GRADERS) Air Filter Set..... A-28730-S Air Filter Primary..... A-28710 Air Filter Primary..... AS-5102 Air Filter Secondary..... A-8651 Air Filter Set..... AS-5102-S Coolant Filter..... WC-5705 Coolant Filter..... WC-5711 Fuel/Water Separator..... SFC-5705 Hydraulic Oil Filter..... HC-5503 Oil Filter Combination..... C-5723		G960B (MOTOR GRADERS) VOLVO D8H , 2011 Air Filter Set..... AS-5102-S Air Filter Primary..... AS-5102 Hydraulic Oil Filter..... HC-7001	
G60 (MOTOR GRADERS) Coolant Filter..... WC-5705 Fuel Filter Secondary..... FC-7903 Fuel/Water Separator..... SFC-5706 Fuel/Water Separator..... SFC-5705 Hydraulic Oil Filter Full Flow..... HC-79331 Oil Filter Full Flow..... C-5704		G740B (MOTOR GRADERS) VOLVO D10BGAE2 Air Filter Primary..... AS-8579M Air Filter Secondary..... A-8580 Air Filter Primary..... AS-8579 Air Filter Set..... AS-8579-S Coolant Filter..... WC-7101 Fuel Filter..... FC-7102 Fuel/Water Separator Primary..... SFC-7912-30 Hydraulic Oil Filter..... HC-5503 Hydraulic Oil Filter..... HC-5508 Oil Filter By Pass..... C-5717 Oil Filter Full Flow..... C-7105		G960B (MOTOR GRADERS) VOLVO D8H , 2011 Air Filter Set..... AS-5102-S Air Filter Primary..... AS-5102 Hydraulic Oil Filter..... HC-7001	
G710B (MOTOR GRADERS) VOLVO D7D Air Filter Primary..... AS-5102 Air Filter Set..... AS-5102-S		G710 (MOTOR GRADERS) Air Filter Primary..... A-1313 Air Filter Set..... AS-5102-S Air Filter Set..... A-5662-S Air Filter Secondary..... A-1307 Air Filter Secondary..... A-8651 Air Filter Primary..... AS-5102 Fuel Filter Secondary..... FC-7903 Fuel/Water Separator..... SFC-5706 Hydraulic Oil Filter..... HC-5503 Hydraulic Oil Filter..... HC-5508 Oil Filter Full Flow..... C-5704		KL121 (EXCAVATORS) w / Volvo D100B Eng. Fuel Filter..... FC-7103	
G720B (MOTOR GRADERS) VOLVO D7DGBE3 Air Filter Set..... AS-5102-S Air Filter Primary..... AS-5102		G930 (MOTOR GRADERS) VOLVO D7E , 2006 Air Filter Set..... AS-5102-S Air Filter Primary..... AS-5102 Hydraulic Oil Filter..... HC-7001		KL130 (EXCAVATORS) w / Volvo D70 Eng. Fuel Filter..... FC-7103	
G726B (MOTOR GRADERS) VOLVO D7D Air Filter Primary..... AS-5102 Air Filter Set..... AS-5102-S		G930B (MOTOR GRADERS) VOLVO D8H , 2011 Air Filter Primary..... AS-5102 Air Filter Set..... AS-5102-S Hydraulic Oil Filter..... HC-7001		KL250 (EXCAVATORS) w / Volvo D100B Eng. Fuel Filter..... FC-7103	
G720 (MOTOR GRADERS) Air Filter Secondary..... A-8651 Air Filter Primary..... AS-5102 Air Filter Secondary..... A-1307 Air Filter Primary..... A-1313 Air Filter Set..... AS-5102-S Air Filter Set..... A-5662-S Coolant Filter..... WC-5711 Coolant Filter..... WC-5705 Fuel Filter Secondary..... FC-7903		G940 (MOTOR GRADERS) VOLVO D7E , 2006 Air Filter Primary..... AS-5102 Air Filter Set..... AS-5102-S Hydraulic Oil Filter..... HC-7001		L110E (LOADERS) VOLVO D7D LABE2 , 2002-UP Air Filter Secondary..... A-8651 Air Filter Breather..... A-2417 Air Filter..... AH-7908 Air Filter Primary..... AS-5102 Air Filter Set..... AS-5102-S Cabin Air Filter..... CA-2402 Cabin Air Filter..... CA-2401 Cabin Air Filter..... CAV-2401 Coolant Filter..... WC-7101 Fuel Filter..... FC-71100 Fuel/Water Separator Secondary.. SFC-7101-10 Hydraulic Oil Filter..... HC-5506 Oil Filter Full Flow..... C-6204	
		G940B (MOTOR GRADERS) VOLVO D8H , 2011 Air Filter Primary..... AS-5102 Air Filter Set..... AS-5102-S Hydraulic Oil Filter..... HC-7001		L110E (LOADERS) VOLVO D7D Air Filter Set..... AS-5102-S Air Filter Primary..... AS-5102 Hydraulic Oil Filter..... HC-7001	
		G946 (MOTOR GRADERS) VOLVO D7E , 2006 Air Filter Primary..... AS-5102 Air Filter Set..... AS-5102-S Hydraulic Oil Filter..... HC-7001		L110F (LOADERS) VOLVO D7E , 2007 Air Filter Primary..... AS-5102 Air Filter Set..... AS-5102-S Hydraulic Oil Filter..... HC-7001	
		G940B (MOTOR GRADERS) VOLVO D8H , 2011 Air Filter Primary..... AS-5102 Air Filter Set..... AS-5102-S Hydraulic Oil Filter..... HC-7001		L120E (LOADERS) VOLVO D7DLAE2 , 2002-UP Air Filter..... AH-7908 Air Filter Primary..... AS-5102 Air Filter Set..... AS-5102-S Air Filter Secondary..... A-8651 Air Filter Breather..... A-2417 Cabin Air Filter..... CA-2401	

MODEL/APPLICATION	SAKURA NO	MODEL/APPLICATION	SAKURA NO	MODEL/APPLICATION	SAKURA NO
VOLVO		VOLVO		VOLVO	
L120E (LOADERS) VOLVO D7DLAE2 , 2002-UP		Oil Filter By Pass.....	C-5717	Oil Filter By Pass.....	C-5717
Cabin Air Filter.....	CAV-2401	Oil Filter Full Flow.....	C-7105	Oil Filter Full Flow.....	C-7105
Cabin Air Filter.....	CA-2402			Oil Filter Full Flow.....	C-71060
Coolant Filter.....	WC-7101	L140 (LOADERS)		L17 (LOADERS) w / Volvo Eng.	
Fuel Filter.....	FC-71100	Air Filter Secondary.....	A-7967	Fuel Filter.....	FC-7103
Fuel Filter.....	FC-71120	Air Filter Primary.....	A-28710		
Fuel/Water Separator Secondary... SFC-7101-10		Air Filter Set.....	A-28730-S	L180C (LOADERS) VOLVO TD122KHE , 1997-2002	
Fuel/Water Separator.....	SFC-7901-30	Fuel Filter.....	FC-5721	Hydraulic Oil Filter.....	HC-7001
Hydraulic Oil Filter.....	HC-5506			L180C (LOADERS) VOLVO TD122KLE , 1997-2002	
Oil Filter Full Flow.....	C-6204	L150E (LOADERS) VOLVO D10B , 2002-UP		Hydraulic Oil Filter.....	HC-7001
		Air Filter.....	AH-7908		
L120E (LOADERS) VOLVO D7DLAE2		Air Filter Primary.....	A-7118	L180E (LOADERS) VOLVO D12C , 2002-UP	
Air Filter Set.....	AS-5102-S	Air Filter Set.....	A-7119-S	Hydraulic Oil Filter.....	HC-7001
Air Filter Primary.....	AS-5102	Air Filter Secondary.....	A-7117		
Hydraulic Oil Filter.....	HC-7001	Air Filter Breather.....	A-2417	L180E (LOADERS) VOLVO D12C , 2002-UP	
		Cabin Air Filter.....	CAV-2401	Air Filter Secondary.....	A-7117
L120F (LOADERS) VOLVO D7E , 2007		Cabin Air Filter.....	CA-2402	Air Filter Primary.....	A-7118
Air Filter Primary.....	AS-5102	Cabin Air Filter.....	CA-2401	Air Filter Breather.....	A-2417
Air Filter Set.....	AS-5102-S	Coolant Filter.....	WC-7101	Air Filter.....	AH-7908
Hydraulic Oil Filter.....	HC-7001	Fuel Filter.....	FC-7102	Air Filter Set.....	A-7119-S
		Fuel/Water Separator Primary..... SFC-7912-30		Cabin Air Filter.....	CA-2402
L120G (LOADERS) VOLVO D8H , 2012		Hydraulic Oil Filter.....	HC-5506	Cabin Air Filter.....	CAV-2401
Air Filter Primary.....	AS-5102	Hydraulic Oil Filter.....	H-71130	Cabin Air Filter.....	CA-2401
Air Filter Set.....	AS-5102-S	Oil Filter Full Flow.....	C-2508	Coolant Filter.....	WC-7101
Hydraulic Oil Filter.....	HC-7001	Oil Filter By Pass.....	C-5717	Fuel Filter.....	FC-7102
		Oil Filter Full Flow.....	C-7105	Fuel/Water Separator Primary..... SFC-7912-30	
L120B (LOADERS) 1991-1995		L150E (LOADERS) VOLVO D12D , 2002-2007		Hydraulic Oil Filter.....	H-71130
Hydraulic Oil Filter.....	HC-5508	Hydraulic Oil Filter.....	HC-7001	Hydraulic Oil Filter.....	HC-5506
				Oil Filter Full Flow.....	C-2508
L120C (LOADERS) 1986-1991		L150E (LOADERS) VOLVO D10B		Oil Filter Full Flow.....	C-7105
Air Filter Breather.....	A-5101	Hydraulic Oil Filter.....	HC-7001	Oil Filter By Pass.....	C-5717
Air Filter Secondary.....	A-5311				
Air Filter.....	AH-7908	L150F (LOADERS) VOLVO D12D , 2007		L180E (LOADERS) VOLVO D12C	
Air Filter Primary.....	A-6303	Hydraulic Oil Filter.....	HC-7001	Hydraulic Oil Filter.....	HC-7001
Coolant Filter.....	WC-7101				
Fuel Filter Primary.....	FC-7107	L150G (LOADERS) VOLVO D13H-E , 2011		L180E HL (LOADERS) VOLVO D12C , 2002-UP	
Fuel Filter.....	FC-7901	Hydraulic Oil Filter.....	HC-7001	Air Filter Secondary.....	A-7117
Fuel Filter.....	FC-5723			Air Filter Primary.....	A-7118
Hydraulic Oil Filter.....	HC-5508	L150G (LOADERS) VOLVO D13H-F , 2011		Air Filter Breather.....	A-2417
Oil Filter By Pass.....	C-5717	Hydraulic Oil Filter.....	HC-7001	Air Filter.....	AH-7908
Oil Filter Full Flow.....	C-7105			Air Filter Set.....	A-7119-S
Oil Filter Full Flow.....	C-71060	L150D (LOADERS) 2000-2002		Cabin Air Filter.....	CAV-2401
		Air Filter Secondary.....	A-8580	Cabin Air Filter.....	CA-2401
L120D (LOADERS)		Air Filter Set.....	AS-8579-S	Cabin Air Filter.....	CA-2402
Air Filter Secondary.....	A-8651	Air Filter Primary.....	AS-8579M	Coolant Filter.....	WC-7101
Air Filter Primary.....	AS-5102	Air Filter.....	AH-7908	Fuel Filter.....	FC-7102
Air Filter Set.....	AS-5102-S	Air Filter Primary.....	AS-8579	Fuel/Water Separator.....	SFC-7901-30
Cabin Air Filter.....	CA-2401	Cabin Air Filter.....	CA-2401	Fuel/Water Separator Primary..... SFC-7912-30	
Cabin Air Filter.....	CA-2402	Cabin Air Filter.....	CAV-2401	Hydraulic Oil Filter.....	H-71130
Cabin Air Filter.....	CAV-2401	Coolant Filter.....	WC-7101	Hydraulic Oil Filter.....	HC-5506
Coolant Filter.....	WC-7101	Fuel Filter Primary.....	FC-7107	Oil Filter Full Flow.....	C-2508
Fuel Filter.....	FC-5723	Fuel Filter.....	FC-5723	Oil Filter Full Flow.....	C-7105
Fuel Filter Primary.....	FC-7107	Fuel/Water Separator Primary..... SFC-7912-30		Oil Filter By Pass.....	C-5717
Fuel/Water Separator.....	SFC-7901-30	Fuel/Water Separator.....	SFC-7901-30		
Fuel/Water Separator Primary..... SFC-7912-30		Hydraulic Oil Filter.....	H-71130	L180E HL (LOADERS) VOLVO D12C , 2002	
Hydraulic Oil Filter.....	HC-5508	Hydraulic Oil Filter.....	HC-5508	Hydraulic Oil Filter.....	HC-7001
Oil Filter Full Flow.....	C-71060				

Sakura Filter

ENGINE APPLICATION

MODEL/APPLICATION	SAKURA NO	MODEL/APPLICATION	SAKURA NO	MODEL/APPLICATION	SAKURA NO
VOLVO		VOLVO		VOLVO	
L180F (LOADERS) VOLVO D12D , 2007		Fuel/Water Separator..... SFC-7901-30		L25B (LOADERS) VOLVO D3D , 2002-UP	
Hydraulic Oil Filter..... HC-7001		Hydraulic Oil Filter..... H-71130		Air Filter Primary..... A-8553	
L180G (LOADERS) VOLVO D13H-F , 2011		Hydraulic Oil Filter..... HC-5506		Air Filter..... A-8554	
Hydraulic Oil Filter..... HC-7001		Oil Filter By Pass..... C-5717		Fuel Filter..... FC-71100	
L180G (LOADERS) VOLVO D13H-F , 2011		Oil Filter Full Flow..... C-2508		Fuel Filter..... FC-6205	
Hydraulic Oil Filter..... HC-7001		Oil Filter Full Flow..... C-71060		Fuel Filter..... FC-5101	
L180D (LOADERS)		Oil Filter Full Flow..... C-7105		Oil Filter Full Flow..... C-6806	
Air Filter Secondary..... A-7117		L220E (LOADERS) VOLVO D12C , 2002-UP		L330D (LOADERS) 2000-2002	
Air Filter..... AH-7908		Air Filter Breather..... A-2417		Air Filter Set..... A-7912-S	
Air Filter Primary..... A-7118		Air Filter Set..... A-7119-S		Air Filter Primary..... A-7912	
Air Filter Set..... A-7119-S		Air Filter Secondary..... A-7117		Air Filter Secondary..... A-7915	
Cabin Air Filter..... CAV-2401		Air Filter Breather..... A-5101		Cabin Air Filter..... CA-2401	
Cabin Air Filter..... CA-2401		Air Filter..... AH-7908		Cabin Air Filter..... CAV-2401	
Cabin Air Filter..... CA-2402		Air Filter Primary..... A-7118		Cabin Air Filter..... CA-2402	
Coolant Filter..... WC-7101		Cabin Air Filter..... CA-2401		Coolant Filter..... WC-7101	
Fuel Filter..... FC-5723		Cabin Air Filter..... CAV-2401		Fuel Filter Primary..... FC-7107	
Fuel Filter Primary..... FC-7107		Cabin Air Filter..... CA-2402		Fuel Filter..... FC-5723	
Fuel/Water Separator..... SFC-7901-30		Coolant Filter..... WC-7101		Fuel/Water Separator Primary.... SFC-7912-30	
Fuel/Water Separator Primary.... SFC-7912-30		Fuel Filter..... FC-7102		Hydraulic Oil Filter..... HC-5503	
Hydraulic Oil Filter..... HC-5508		Fuel/Water Separator Primary.... SFC-7912-30		Hydraulic Oil Filter..... H-71130	
Hydraulic Oil Filter..... H-71130		Hydraulic Oil Filter..... HC-5506		Oil Filter Full Flow..... C-7105	
Oil Filter Full Flow..... C-7105		Hydraulic Oil Filter..... H-71130		Oil Filter By Pass..... C-5717	
Oil Filter Full Flow..... C-71060		Oil Filter Full Flow..... C-7105		L330E (LOADERS) VOLVO D16B , 2002-UP	
Oil Filter By Pass..... C-5717		Oil Filter By Pass..... C-5717		Air Filter Secondary..... A-7915	
L190 (LOADERS) CUMMINS NTA-855		Oil Filter Full Flow..... C-2508		Air Filter Primary..... A-7912	
Fuel Filter..... FC-5721		L220E (LOADERS) VOLVO D12C , 2002		Air Filter..... AH-7908	
L190B (LOADERS) w / Volvo Eng.		Hydraulic Oil Filter..... HC-7001		Air Filter Set..... A-7912-S	
Fuel Filter..... FC-7103		L220E (LOADERS) VOLVO D12D , 2002		Air Filter Breather..... A-2417	
L20B (LOADERS)		Hydraulic Oil Filter..... HC-7001		Cabin Air Filter..... CAV-2401	
Air Filter..... A-8554		L220F (LOADERS) VOLVO D12D , 2007		Cabin Air Filter..... CA-2402	
Fuel Filter..... FC-6205		Hydraulic Oil Filter..... HC-7001		Cabin Air Filter..... CA-2401	
L220D (LOADERS) VOLVO TD122KHE , 1997-2002		L220F (LOADERS) VOLVO D12D , 2007		Coolant Filter..... WC-7101	
Hydraulic Oil Filter..... HC-7001		Hydraulic Oil Filter..... HC-7001		Fuel Filter..... FC-7102	
L220D (LOADERS) VOLVO TD122KLE , 1997-2002		L220F (LOADERS) VOLVO D12D		Fuel/Water Separator Primary.... SFC-7912-30	
Hydraulic Oil Filter..... HC-7001		Air Filter Secondary..... A-7117		Hydraulic Oil Filter..... H-71130	
L220D (LOADERS)		Air Filter Primary..... A-7118		Hydraulic Oil Filter..... HC-5503	
Air Filter Breather..... A-2417		Air Filter Set..... A-7119-S		Oil Filter Full Flow..... C-7105	
Air Filter Set..... A-7119-S		Air Filter..... AH-7908		Oil Filter By Pass..... C-5717	
Air Filter Secondary..... A-7117		Air Filter Breather..... A-2417		L35B (LOADERS) DEUTZ BF4L1011F , 1998-UP	
Air Filter Primary..... A-7118		Cabin Air Filter..... CA-2402		Fuel Filter..... FC-6205	
Cabin Air Filter..... CAV-2401		Cabin Air Filter..... CAV-2401		Oil Filter Full Flow..... C-1828	
Cabin Air Filter..... CA-2402		Cabin Air Filter..... CA-2401		L45B (LOADERS) DEUTZ BF4M1013E , 1998-UP	
Cabin Air Filter..... CA-2401		Fuel Filter..... FC-7108		Air Filter Primary..... A-5105	
Coolant Filter..... WC-7101		Fuel/Water Separator..... SFC-5301-10B		Air Filter Secondary..... A-5106	
Fuel Filter Primary..... FC-7107		Fuel/Water Separator..... SFC-5301-10		Oil Filter Full Flow..... C-6215	
Fuel Filter..... FC-5723		Hydraulic Oil Filter..... HC-5506		L45F (LOADERS) VOLVO D5D4.8L TIER3 , 4800, 2009	
Fuel/Water Separator Primary.... SFC-7912-30		Oil Filter By Pass..... C-5717		Air Filter Secondary..... A-56741	
		Oil Filter Full Flow..... C-7105		Air Filter Primary..... A-56731	
		L220G (LOADERS) VOLVO D13H-E , 2011		Air Filter Set..... A-56731-S	
		Hydraulic Oil Filter..... HC-7001		L50 (LOADERS) VOLVO , 2004-UP	
		L220G (LOADERS) VOLVO D13H-F , 2011		Fuel Filter..... FC-71100	
		Hydraulic Oil Filter..... HC-7001			

MODEL/APPLICATION	SAKURA NO	MODEL/APPLICATION	SAKURA NO	MODEL/APPLICATION	SAKURA NO
VOLVO					
L50E (LOADERS)					
VOLVO D4D , 2004-2008					
Air Filter Secondary.....	A-56741				
Air Filter Primary.....	A-56731				
Air Filter Set.....	A-56731-S				
L50F (LOADERS)					
VOLVO D5D4.8L TIER3 , 4800, 2009					
Air Filter Primary.....	A-56731				
Air Filter Set.....	A-56731-S				
Air Filter Secondary.....	A-56741				
L50D (LOADERS)					
4.0L 3998cc 244 CID , 4000					
Fuel Filter.....	FC-7103				
L50D (LOADERS)					
2000-UP					
Air Filter Breather.....	A-2417				
Air Filter Primary.....	A-6211				
Air Filter Secondary.....	A-6212				
Cabin Air Filter.....	CA-2401				
Cabin Air Filter.....	CA-2402				
Cabin Air Filter.....	CAV-2401				
Coolant Filter.....	WC-7101				
Fuel Filter.....	FC-5715				
Fuel/Water Separator Primary....	SFC-7912-30				
Hydraulic Oil Filter.....	H-85560				
Hydraulic Oil Filter.....	HC-5508				
Hydraulic Oil Filter.....	HC-6802				
Oil Filter Full Flow.....	C-5102				
Oil Filter Full Flow.....	C-7105				
L60E (LOADERS)					
VOLVO D6D LBE2 , 2002-UP					
Air Filter Breather.....	A-2417				
Air Filter Secondary.....	A-7105				
Air Filter Primary.....	A-7106				
Cabin Air Filter.....	CA-2401				
Cabin Air Filter.....	CA-2402				
Cabin Air Filter.....	CAV-2401				
Coolant Filter.....	WC-7101				
Fuel Filter.....	FC-71100				
Fuel/Water Separator Secondary...	SFC-7101-10				
Hydraulic Oil Filter.....	HC-6802				
Oil Filter Full Flow.....	C-6204				
L81 (LOADERS)					
VOLVO , 2004-UP					
Fuel Filter.....	F-2604				
L90E (LOADERS)					
VOLVO D6D LBE2 , 2002-UP					
Air Filter Secondary.....	A-7105				
Air Filter Primary.....	A-7106				
Fuel Filter.....	FC-71100				
Fuel/Water Separator Secondary...	SFC-7101-10				
Hydraulic Oil Filter.....	HC-5506				
Oil Filter Full Flow.....	C-6204				
L90E (LOADERS)					
VOLVO D6D LBE2 , 2002					
Hydraulic Oil Filter.....	HC-7001				
L90E (LOADERS)					
VOLVO D6D , 1992-1995					
Hydraulic Oil Filter.....	HC-5508				
L90D (LOADERS)					
2000-2002					
Air Filter Primary.....	A-7106				
Air Filter Secondary.....	A-7105				
Cabin Air Filter.....	CAV-2401				
Cabin Air Filter.....	CA-2402				
Cabin Air Filter.....	CA-2401				
Coolant Filter.....	WC-7101				
Fuel Filter Primary.....	FC-7107				
Fuel Filter.....	FC-5723				
Fuel/Water Separator.....	SFC-7901-30				
Fuel/Water Separator Primary....	SFC-7912-30				
Hydraulic Oil Filter.....	HC-5508				
Oil Filter Full Flow.....	C-7105				
Oil Filter Full Flow.....	C-71060				
LC120 (LOADERS)					
w / Volvo Eng.					
Fuel Filter.....	FC-7103				
LF70B (LOADERS)					
w / Volvo Eng.					
Fuel Filter.....	FC-7103				
LM1240 (LOADERS)					
w / Volvo D70B Eng.					
Fuel Filter.....	FC-7103				
LM1241 (LOADERS)					
w / Volvo TD42 Eng.					
Fuel Filter.....	FC-7103				
LM1641 (LOADERS)					
w / Volvo D100 Eng.					
Fuel Filter.....	FC-7103				
LM1641 (LOADERS)					
w / Volvo TD100 Eng.					
Fuel Filter.....	FC-7103				
LM841 (LOADERS)					
w / Volvo D60A Eng.					
Fuel Filter.....	FC-7103				
LM845 (LOADERS)					
w / Volvo D60A Eng.					
Fuel Filter.....	FC-7103				
LM846 (LOADERS)					
w / Volvo D60A Eng.					
Fuel Filter.....	FC-7103				
MC70 (LOADERS)					
KUBOTA V2003T-EB (S/N: 60000-99999)					
Air Filter Primary.....	A-7003				
Air Filter Secondary.....	A-7004				
MC80 (LOADERS)					
4.2L 4228cc 258 CID , 4200					
Fuel Filter.....	FC-7103				
MC80 (LOADERS)					
S/N: 60000-99999					
Air Filter Primary.....	A-7003				
Air Filter Secondary.....	A-7004				
Fuel Filter.....	FC-5715				
MC90 (LOADERS)					
4.2L 4228cc 258 CID , 4200					
Fuel Filter.....	FC-7103				
MC90 (LOADERS)					
PERKINS 1004-42					
Hydraulic Oil Filter.....	HC-5508				
MW500 (MILLING MACHINE)					
DEUTZ TCD2012					
Hydraulic Oil Filter.....	H-86030-12				
S840 (COMBINES HARVESTERS)					
Fuel Filter.....	FC-7103				
SD110 (COMPACTORS)					
Hydraulic Oil Filter.....	HC-71030				
T230 (TRACTORS)					
Fuel Filter.....	F-2601				
T-35 (TRACTORS)					
Fuel Filter.....	F-2604				
T350 (TRACTORS)					
Fuel Filter.....	F-2601				
T55 (TRACTORS)					
Fuel Filter.....	F-2604				
VAK510 (MOTOR GRADERS)					
w / Volvo Eng.					
Fuel Filter.....	FC-7103				
VHK312 (MOTOR GRADERS)					
w / Volvo Eng.					
Fuel Filter.....	FC-7103				
VHK3500 (MOTOR GRADERS)					
w / Volvo TD70E Eng.					
Fuel Filter.....	FC-7103				
VHK 312 ROADSCRAPER (TRACTORS)					
Air Filter Secondary.....	A-6302				
Air Filter Primary.....	A-6207				
Fuel Filter.....	FC-5704				
Oil Filter Full Flow.....	C-6210				



Technical Specification

B

Sakura Filter

Technical Specification

A-1307 Air Filter Secondary Metal End Cap Element

ISUZU 1-14215085-0
HINO 17801-2460
CATERPILLAR 3I-0179



Primary Filter uses A-1313
Set Filter uses A-5662-S
H 1 : 444.7 (mm)
H 2 : 432 (mm)
OD 1 : 145 (mm)
OD 2 : 145 (mm)
ID 1 : 116.5 (mm)
ID 2 : 23 (mm)

CONT : 9
VOL : 0.106

A-2417 Air Filter Breather Soft PU end cap Element

VOLVO 11707077-1



H 1 : 73.5 (mm)
H 2 : 57 (mm)
OD 1 : 106 (mm)
OD 2 : 106 (mm)
ID 1 : 63 (mm)

CONT : 50
VOL : 0.056

A-5106 Air Filter Secondary Soft PU end cap Element

VOLVO 2908238
MASSEY-FERGUSON 3901478M1
J.C.BAMFORD 580-12021



Primary Filter uses A-5105
Set Filter uses A-5107-S
H 1 : 386 (mm)
H 2 : 380 (mm)
OD 1 : 104 (mm)
OD 2 : 107 (mm)
ID 1 : 93 (mm)

CONT : 25
VOL : 0.178

A-1313 Air Filter Primary Metal End Cap Element

CATERPILLAR 099-5801
ISUZU 1-14215084-0
HINO 17720-3640
HINO 17801-2530



Secondary Filter uses A-1307
Set Filter uses A-5662-S
H 1 : 469.75 (mm)
H 2 : 457 (mm)
OD 1 : 232 (mm)
OD 2 : 232 (mm)
ID 1 : 147 (mm)
ID 2 : 23 (mm)

CONT : 4
VOL : 0.123

A-28710 Air Filter Primary Metal End Cap Element

HYUNDAI 11N8-22140



Secondary Filter uses A-28720
Set Filter uses A-28730-S
H 1 : 502.75 (mm)
H 2 : 490 (mm)
OD 1 : 276 (mm)
OD 2 : 275 (mm)
ID 1 : 165 (mm)
ID 2 : 19 (mm)

CONT : 1
VOL : 0.047

A-5301 Air Filter Primary Metal End Cap Element

ATLAS COPCO 1619-27-98-00
DEUTZ 2165041
DEUTZ 2165054



Secondary Filter uses A-6210
Set Filter uses A-5301-S
H 1 : 383.7 (mm)
H 2 : 371 (mm)
OD 1 : 228 (mm)
OD 2 : 228 (mm)
ID 1 : 117 (mm)
ID 2 : 11 (mm)

CONT : 1
VOL : 0.023

A-2207 Air Filter Secondary Metal End Cap Element

ORENSTEIN & KOPPEL 1433799
CATERPILLAR 3I-0191
FORD 703408
FIAT 70671839



Primary Filter uses A-2209
Set Filter uses A-2209-S
H 1 : 546 (mm)
H 2 : 533 (mm)
OD 1 : 194 (mm)
OD 2 : 194 (mm)
ID 1 : 153 (mm)
ID 2 : 22.7 (mm)

CONT : 9
VOL : 0.221

Note : Is a Secondary Air filter for A-2209,A-22320

A-28730-S Air Filter Set Metal End Cap Element

HYUNDAI 11N8-22140+11N8-22150



Primary Filter uses A-28710
Secondary Filter uses A-28720
H 1 : 502.75 (mm)
H 2 : 490 (mm)
OD 1 : 276 (mm)
OD 2 : 275 (mm)
ID 1 : 134 (mm)
ID 2 : 19 (mm)

CONT : 1
VOL : 0.047

A-5311 Air Filter Secondary Metal End Cap Element

DEUTZ 414 4966
VOLVO 4785749
MAN 51.08405-0001
FORD 86509129



Primary Filter uses A-6303
Set Filter uses A-6304-S
H 1 : 480 (mm)
OD 1 : 141 (mm)
OD 2 : 127 (mm)
ID 1 : 116 (mm)
ID 2 : 17 (mm)

CONT : 9
VOL : 0.116

A-2209 Air Filter Primary Metal End Cap Element

FIAT 70671838



Secondary Filter uses A-2207
Set Filter uses A-2209-S
H 1 : 596.7 (mm)
H 2 : 584 (mm)
OD 1 : 307 (mm)
OD 2 : 307 (mm)
ID 1 : 196 (mm)
ID 2 : 22.7 (mm)

CONT : 1
VOL : 0.075

A-5101 Air Filter Breather Spin-On with clamp

VOLVO 1082111
HITACHI 4881323
CROSLAND 9215



H 1 : 87 (mm)
H 2 : 70 (mm)
OD 1 : 85 (mm)
OD 2 : 87.4 (mm)
ID 1 : 25 (mm)

CONT : 25
VOL : 0.029

A-5408 Air Filter Secondary Metal End Cap Element

ISUZU 1-14215034-0
ISUZU 1-14215036-0
NISSAN 16546-96014



Primary Filter uses A-6113
Set Filter uses A-5653-S
H 1 : 406 (mm)
OD 1 : 192.3 (mm)
OD 2 : 162.5 (mm)
ID 1 : 134.2 (mm)
ID 2 : 17 (mm)

CONT : 9
VOL : 0.167

Note : Is a Secondary Air filter for A-6113,A-54490

A-2209-S Air Filter Set Metal End Cap Element

FIAT 70671838+70671839



Primary Filter uses A-2209
Secondary Filter uses A-2207
H 1 : 596.7 (mm)
H 2 : 584 (mm)
OD 1 : 307 (mm)
OD 2 : 307 (mm)
ID 1 : 196 (mm)
ID 2 : 22.7 (mm)

CONT : 1
VOL : 0.075

A-5105 Air Filter Primary Soft PU end cap Element

BOMAG 05821147
VOLVO 2908237
MASSEY-FERGUSON 3901477M1
J.C.BAMFORD 580-12020



Secondary Filter uses A-5106
Set Filter uses A-5107-S
H 1 : 400 (mm)
H 2 : 367 (mm)
OD 1 : 194 (mm)
OD 2 : 194 (mm)
ID 1 : 113.5 (mm)

CONT : 4
VOL : 0.078

A-5425 Air Filter Primary Metal End Cap Element

HINO 17801-2020
HINO 17801-2270
HINO 17801-2290



Secondary Filter uses A-5417
Set Filter uses A-5425-S
H 1 : 418.7 (mm)
H 2 : 406 (mm)
OD 1 : 307 (mm)
OD 2 : 307 (mm)
ID 1 : 196 (mm)
ID 2 : 22.7 (mm)

CONT : 1
VOL : 0.050

Sakura Filter

Technical Specification

A-5425-S Air Filter Set Metal End Cap Element

INTERNATIONAL HARVESTER
702864C1+702753C1



Primary Filter uses A-5425
Secondary Filter uses A-5417
H 1 : 418.7 (mm)
H 2 : 406 (mm)
OD 1 : 307 (mm)
OD 2 : 307 (mm)
ID 1 : 196 (mm)
ID 2 : 22.7 (mm)

CONT : 1
VOL : 0.049

A-5569 Air Filter Secondary Soft PU end cap Element

VOLVO 11801160
CATERPILLAR 1467473
JOHN DEERE M131803
KOMATSU YM12905112530



Primary Filter uses A-8513
Set Filter uses A-5570-S
H 1 : 265 (mm)
H 2 : 259 (mm)
OD 1 : 61 (mm)
OD 2 : 59 (mm)
ID 1 : 45 (mm)

CONT : 25
VOL : 0.048

A-56741 Air Filter Secondary Soft PU end cap Element

MANITOU 775480



Primary Filter uses A-56731
Set Filter uses A-56731-S
H 1 : 382.5 (mm)
H 2 : 378 (mm)
OD 1 : 106 (mm)
OD 2 : 100 (mm)
ID 1 : 87 (mm)

CONT : 0
VOL : 0.000

A-5540 Air Filter Secondary Soft PU end cap Element

YANMAR 119117-12570
CATERPILLAR 1318903
PERKINS 26510343
YANMAR Y119117-12570



Primary Filter uses A-5541
Set Filter uses A-5541-S
H 1 : 346 (mm)
H 2 : 340 (mm)
OD 1 : 92 (mm)
OD 2 : 86.5 (mm)
ID 1 : 72.5 (mm)

CONT : 25
VOL : 0.105

A-5662-S Air Filter Set Metal End Cap Element

KOMATSU 600-181-8600
KOMATSU 600-182-2700
KOMATSU 600-182-3200



Primary Filter uses A-1313
Secondary Filter uses A-1307
H 1 : 457 (mm)
H 2 : 432 (mm)
OD 1 : 232 (mm)
OD 2 : 145 (mm)
ID 1 : 147 (mm)
ID 2 : 23 (mm)

CONT : 4
VOL : 0.123

A-5675-S Air Filter Set Soft PU end cap Element

KOMATSU 600-185-2500



Primary Filter uses A-5673
Secondary Filter uses A-5674
H 1 : 392 (mm)
H 2 : 384 (mm)
OD 1 : 186 (mm)
OD 2 : 186 (mm)
ID 1 : 106 (mm)

CONT : 1
VOL : 0.018

A-5541 Air Filter Primary Soft PU end cap Element

YANMAR 119117-12560
CATERPILLAR 131-8902
PERKINS 26510342
HITACHI 4486002



Secondary Filter uses A-5540
Set Filter uses A-5541-S
H 1 : 356 (mm)
H 2 : 347 (mm)
OD 1 : 163.5 (mm)
OD 2 : 163.5 (mm)
ID 1 : 91 (mm)

CONT : 9
VOL : 0.108

A-5673 Air Filter Primary Soft PU end cap Element

YANMAR 172660-13840
CATERPILLAR 206-5234
KOMATSU 600-185-2510



Secondary Filter uses A-5674
Set Filter uses A-5675-S
H 1 : 392 (mm)
H 2 : 384 (mm)
OD 1 : 186 (mm)
OD 2 : 186 (mm)
ID 1 : 106 (mm)

CONT : 9
VOL : 0.169

A-5715 Air Filter Secondary Metal End Cap Element

CATERPILLAR 1N-4864
CUMMINS 3013213
CATERPILLAR 3I-0215



Primary Filter uses A-5718
Set Filter uses A-5718-S
H 1 : 571.75 (mm)
H 2 : 559 (mm)
OD 1 : 260 (mm)
OD 2 : 260 (mm)
ID 1 : 231.5 (mm)
ID 2 : 23 (mm)

CONT : 1
VOL : 0.047

A-5541M Air Filter Primary Soft PU+Metal Element

CATERPILLAR 131-8902



Secondary Filter uses A-5540
Set Filter uses A-5541M-S
H 1 : 356 (mm)
H 2 : 347 (mm)
OD 1 : 163.5 (mm)
OD 2 : 163.5 (mm)
ID 1 : 91 (mm)

CONT : 9
VOL : 0.108

A-56731 Air Filter Primary Soft PU end cap Element

MANITOU 775479



Secondary Filter uses A-56741
Set Filter uses A-56731-S
H 1 : 394.5 (mm)
H 2 : 385 (mm)
OD 1 : 186 (mm)
OD 2 : 184 (mm)
ID 1 : 105.5 (mm)

CONT : 1
VOL : 0.000

A-5718 Air Filter Primary Metal End Cap Element

CUMMINS 3013212
CATERPILLAR 3I-0795
HITACHI 4206272



Secondary Filter uses A-5715
Set Filter uses A-5718-S
H 1 : 622.7 (mm)
H 2 : 610 (mm)
OD 1 : 373 (mm)
OD 2 : 373 (mm)
ID 1 : 262.5 (mm)
ID 2 : 23 (mm)

CONT : 1
VOL : 0.102

A-5541M-S Air Filter Set Soft PU+Metal Element

CATERPILLAR 131-8902+131-8903



Primary Filter uses A-5541M
Secondary Filter uses A-5540
H 1 : 353 (mm)
H 2 : 344 (mm)
OD 1 : 163.5 (mm)
OD 2 : 163.5 (mm)
ID 1 : 91 (mm)

CONT : 9
VOL : 0.116

A-56731-S Air Filter Set Soft PU end cap Element

MANITOU 77549+775480



Primary Filter uses A-56731
Secondary Filter uses A-56741
H 1 : 395 (mm)
H 2 : 385 (mm)
OD 1 : 186 (mm)
OD 2 : 184 (mm)
ID 1 : 87 (mm)

CONT : 0
VOL : 0.000

A-6008 Air Filter Secondary Metal End Cap Element

ISUZU 1-14215047-0
ISUZU 1-1425-046-1
NISSAN 16546-96010



Primary Filter uses A-5627
Set Filter uses A-5663-S
H 1 : 330 (mm)
OD 1 : 146 (mm)
OD 2 : 116.5 (mm)
ID 1 : 88 (mm)
ID 2 : 17 (mm)

CONT : 9
VOL : 0.083

Sakura Filter

Technical Specification

A-6207 Air Filter Primary Metal End Cap Element

MERCEDES-BENZ 001 094 42 04
MERCEDES-BENZ 001 094 52 04
IVECO 02165049



Secondary Filter uses A-6302
Set Filter uses A-6207-S
H 1 : 374.7 (mm)
H 2 : 362 (mm)
OD 1 : 197.5 (mm)
OD 2 : 197.5 (mm)
ID 1 : 103.5 (mm)
ID 2 : 9 (mm)

CONT : 9
VOL : 0.163

31

A-6302 Air Filter Secondary Metal End Cap Element

MERCEDES-BENZ 002 094 32 04
DEUTZ 2241329
HITACHI 5025800



Primary Filter uses A-6207
Set Filter uses A-6207-S
H 1 : 373 (mm)
OD 1 : 110 (mm)
OD 2 : 99.5 (mm)
ID 1 : 90.4 (mm)
ID 2 : 17 (mm)

CONT : 16
VOL : 0.088

36

A-68042-S Air Filter Set Metal End Cap Element

MERCEDES-BENZ 003 094 15 04+003 094 16 04



Primary Filter uses A-68042
Secondary Filter uses A-5318
H 1 : 472.7 (mm)
H 2 : 460 (mm)
OD 1 : 302 (mm)
OD 2 : 302 (mm)
ID 1 : 191 (mm)
ID 2 : 11 (mm)

CONT : 1
VOL : 0.054

41

A-6210 Air Filter Secondary Metal End Cap Element

MERCEDES-BENZ 003 094 45 04
DEUTZ 42480759
INGERSOLL RAND 92686930



Primary Filter uses A-5301
Set Filter uses A-5301-S
H 1 : 380 (mm)
OD 1 : 121 (mm)
OD 2 : 111 (mm)
ID 1 : 105 (mm)
ID 2 : 17 (mm)

CONT : 16
VOL : 0.131

32

A-6303 Air Filter Primary Metal End Cap Element

MERCEDES-BENZ 001 094 79 04
MERCEDES-BENZ 012 094 87 02
IVECO 02165059



Secondary Filter uses A-5311
Set Filter uses A-6304-S
H 1 : 494.75 (mm)
H 2 : 482 (mm)
OD 1 : 241.5 (mm)
OD 2 : 241.5 (mm)
ID 1 : 137 (mm)
ID 2 : 11 (mm)

CONT : 1
VOL : 0.037

37

A-7003 Air Filter Primary Soft PU end cap Element

FIAT 1930587
PERKINS 26510337
FIAT 366-08109



Secondary Filter uses A-7004
Set Filter uses A-7003-S
H 1 : 327.8 (mm)
H 2 : 319 (mm)
OD 1 : 138 (mm)
OD 2 : 138 (mm)
ID 1 : 81 (mm)

CONT : 1
VOL : 0.008

42

A-6211 Air Filter Primary Metal End Cap Element

MERCEDES-BENZ 001 094 46 04
DEUTZ 2165044



Secondary Filter uses A-6212
Set Filter uses A-6211-S
H 1 : 352.7 (mm)
H 2 : 340 (mm)
OD 1 : 164 (mm)
OD 2 : 164 (mm)
ID 1 : 87 (mm)
ID 2 : 8.5 (mm)

CONT : 9
VOL : 0.108

33

A-6304-S Air Filter Set Metal End Cap Element

DEUTZ 2165056+4144966



Primary Filter uses A-6303
Secondary Filter uses A-5311
H 1 : 494.75 (mm)
H 2 : 482 (mm)
OD 1 : 141.5 (mm)
OD 2 : 241.5 (mm)
ID 1 : 132 (mm)
ID 2 : 17 (mm)

CONT : 1
VOL : 0.037

38

A-7004 Air Filter Secondary Soft PU end cap Element

FIAT 1930588
PERKINS 26510338



Primary Filter uses A-7003
Set Filter uses A-7003-S
H 1 : 319 (mm)
H 2 : 312 (mm)
OD 1 : 84 (mm)
OD 2 : 79 (mm)
ID 1 : 63 (mm)

CONT : 25
VOL : 0.082

43

A-6212 Air Filter Secondary Aluminium casting end cap, Element

DEUTZ 2985037
VOLVO 4765611



Primary Filter uses A-6211
H 1 : 346 (mm)
OD 1 : 90 (mm)
OD 2 : 82 (mm)
ID 1 : 71 (mm)
ID 2 : 17 (mm)

CONT : 25
VOL : 0.089

34

A-6705 Air Filter Secondary Soft PU end cap Element

KHD(KLOCKNER-HUMBOLT-DEUTZ) 0441 5906
VOLVO (TRUCK/VCE/VME/PENTA) 11705111
MASSEY-FERGUSON 3901476M1

Primary Filter uses A-6703
Set Filter uses A-6706-S
H 1 : 360 (mm)
OD 1 : 85.6 (mm)
OD 2 : 85 (mm)
ID 1 : 71 (mm)

CONT : 25
VOL : 0.099

39

A-7105 Air Filter Secondary Soft PU end cap Element

VOLVO 11110176
J.C.BAMFORD 32/925405
KOMATSU 41901H0P09
LIEBHERR 7623372
RENAULT 7700050841

Primary Filter uses A-7106
Set Filter uses A-7107-S
H 1 : 454 (mm)
H 2 : 448 (mm)
OD 1 : 134 (mm)
OD 2 : 125 (mm)
ID 1 : 95.5 (mm)

CONT : 25
VOL : 0.256

44

A-6224 Air Filter Secondary Metal End Cap Element

MAN 81.08405.0011
MAN 81.0845.0013
INGERSOLL RAND 92035955



Primary Filter uses A-6804
Set Filter uses A-6804-S
H 1 : 471 (mm)
OD 1 : 161 (mm)
OD 2 : 151 (mm)
ID 1 : 141 (mm)
ID 2 : 17 (mm)

CONT : 9
VOL : 0.140

35

A-68042 Air Filter Primary Metal End Cap Element

MERCEDES-BENZ 003 094 15 04



Secondary Filter uses A-5318
Set Filter uses A-68042-S
H 1 : 472.7 (mm)
H 2 : 460 (mm)
OD 1 : 302 (mm)
OD 2 : 302 (mm)
ID 1 : 191 (mm)
ID 2 : 11 (mm)

CONT : 1
VOL : 0.054

Note : Is a Primary Air Filter for A-5318,A-6224

40

A-7106 Air Filter Primary Soft PU end cap Element

VOLVO 11110175
J.C.BAMFORD 32/925404
RENAULT 7700050840



Secondary Filter uses A-7105
Set Filter uses A-7107-S
H 1 : 473 (mm)
H 2 : 460 (mm)
OD 1 : 237 (mm)
OD 2 : 237 (mm)
ID 1 : 132 (mm)

CONT : 4
VOL : 0.128

45

Sakura Filter

Technical Specification

A-7108 Air Filter Primary Soft PU end cap Element

VOLVO 11110217



Secondary Filter uses A-7109
Set Filter uses A-7110-S
H 1 : 493 (mm)
H 2 : 480 (mm)
OD 1 : 362 (mm)
OD 2 : 362 (mm)
ID 1 : 229 (mm)

CONT : 1
VOL : 0.073

46

A-7119-S Air Filter Set Soft PU end cap Element

VOLVO 11033998+11033999
VOLVO 110339983+110033991
TEREX 15272252+15272253



Primary Filter uses A-7118
Secondary Filter uses A-7117
H 1 : 580 (mm)
H 2 : 569 (mm)
OD 1 : 313 (mm)
OD 2 : 313 (mm)
ID 1 : 178 (mm)

CONT : 1
VOL : 0.064

51

A-76231 Air Filter Primary Soft PU end cap Element flame retardant media

CLARK 1241080
TOYOTA 17741-U3330-71
KOMATSU 3EC02A541E



H 1 : 356 (mm)
H 2 : 347 (mm)
OD 1 : 163.5 (mm)
OD 2 : 163.5 (mm)
ID 1 : 91 (mm)

CONT : 9
VOL : 0.116

Note : Flame Retardant version of A-5541

56

A-7109 Air Filter Secondary Soft PU end cap Element

VOLVO 11110218



Primary Filter uses A-7108
Set Filter uses A-7110-S
H 1 : 484 (mm)
OD 1 : 229 (mm)
OD 2 : 220 (mm)
ID 1 : 175 (mm)

CONT : 1
VOL : 0.029

47

A-71330 Air Filter Breather Hard PU end cap Element

VOLVO 14500233
KOMATSU 207-60-51310
HYUNDAI 31EE-02110
NEW HOLLAND (CNH) 47587350
J.C.BAMFORD KRJ3461



H 1 : 39 (mm)
H 2 : 31.5 (mm)
OD 1 : 54.5 (mm)
OD 2 : 54.5 (mm)
ID 1 : 31 (mm)
ID 2 : 31 (mm)

CONT : 100
VOL : 0.017

52

A-7912 Air Filter Primary Metal End Cap Element

HITACHI 408065
CASE 45252
STEIGER 45252
INGERSOLL RAND 506163930



Secondary Filter uses A-7915
Set Filter uses A-7912-S
H 1 : 469.75 (mm)
H 2 : 457 (mm)
OD 1 : 352 (mm)
OD 2 : 352 (mm)
ID 1 : 241 (mm)
ID 2 : 23 (mm)

CONT : 1
VOL : 0.070

57

A-7110-S Air Filter Set Soft PU end cap Element

VOLVO 11110217+11110218



Primary Filter uses A-7108
Secondary Filter uses A-7109
H 1 : 493 (mm)
H 2 : 480 (mm)
OD 1 : 362 (mm)
OD 2 : 362 (mm)
ID 1 : 229 (mm)

CONT : 1
VOL : 0.073

48

A-71450 Air Filter Primary Soft PU end cap Element

VOLVO 11110532



Secondary Filter uses A-71460
Set Filter uses A-71470-S
H 1 : 569 (mm)
H 2 : 556 (mm)
OD 1 : 362 (mm)
OD 2 : 362 (mm)
ID 1 : 229 (mm)

CONT : 1
VOL : 0.089

53

A-7912-S Air Filter Set Metal End Cap Element

VOLVO 4881174 + 4881175
EUCLID 9035992+9035993



Primary Filter uses A-7912
Secondary Filter uses A-7915
H 1 : 469.75 (mm)
H 2 : 457 (mm)
OD 1 : 352 (mm)
OD 2 : 352 (mm)
ID 1 : 241 (mm)
ID 2 : 23 (mm)

CONT : 1
VOL : 0.070

58

A-7117 Air Filter Secondary Soft PU end cap Element

VOLVO CONSTRUCTION EQUIPMENT 11033999
VOLVO CONSTRUCTION EQUIPMENT 11033999-1



Primary Filter uses A-7118
Set Filter uses A-7119-S
H 1 : 563 (mm)
H 2 : 557 (mm)
OD 1 : 179 (mm)
OD 2 : 179 (mm)
ID 1 : 148 (mm)

CONT : 6
VOL : 0.133

49

A-71460 Air Filter Secondary Soft PU end cap Element

VOLVO 11110533



H 1 : 562 (mm)
OD 1 : 229 (mm)
OD 2 : 220 (mm)
ID 1 : 175 (mm)

CONT : 1
VOL : 0.037

54

A-7915 Air Filter Secondary Metal End Cap Element

CATERPILLAR 1N-8164
CATERPILLAR 4N-9164
INGERSOLL RAND 50616408



Primary Filter uses A-7912
Set Filter uses A-7912-S
H 1 : 432.7 (mm)
H 2 : 423 (mm)
OD 1 : 220 (mm)
OD 2 : 220 (mm)
ID 1 : 179 (mm)
ID 2 : 23 (mm)

CONT : 4
VOL : 0.104

59

A-7118 Air Filter Primary Soft PU end cap Element

VOLVO CONSTRUCTION EQUIPMENT 11033998
VOLVO CONSTRUCTION EQUIPMENT 11033998-3



Secondary Filter uses A-7117
Set Filter uses A-7119-S
H 1 : 580 (mm)
H 2 : 569 (mm)
OD 1 : 313 (mm)
OD 2 : 313 (mm)
ID 1 : 178 (mm)

CONT : 1
VOL : 0.068

50

A-71470-S Air Filter Set Soft PU end cap Element

VOLVO 11110532+1110533



Primary Filter uses A-71450
Secondary Filter uses A-71460
H 1 : 569 (mm)
H 2 : 556 (mm)
OD 1 : 362 (mm)
OD 2 : 362 (mm)
ID 1 : 175 (mm)

CONT : 1
VOL : 0.090

55

A-7967 Air Filter Secondary Metal End Cap Element

ISUZU 1-14215089-0
NISSAN 16546-96065
KOBELCO 2446U250S-2



Primary Filter uses A-1828
Set Filter uses A-1840-S
H 1 : 495.7 (mm)
H 2 : 483 (mm)
OD 1 : 162.3 (mm)
OD 2 : 162.3 (mm)
ID 1 : 134 (mm)
ID 2 : 17 (mm)

CONT : 9
VOL : 0.152

60

Sakura Filter

Technical Specification

A-8504 Air Filter Primary Soft PU end cap Element



YANMAR 119655-12560
KOMATSU 11965512560
KUBOTA 1G659-11220

Secondary Filter uses A-7618
Set Filter uses A-7620-S
H 1 : 187 (mm)
H 2 : 179 (mm)
OD 1 : 88.5 (mm)
OD 2 : 88.5 (mm)
ID 1 : 46 (mm)

CONT : 25
VOL : 0.055

A-8577 Air Filter Primary Soft PU end cap Element



PERKINS 26510353
J.C.BAMFORD 32/912901
KOMATSU 42X01H0P02

Secondary Filter uses A-8578
Set Filter uses A-8577-S
H 1 : 423 (mm)
H 2 : 410 (mm)
OD 1 : 207 (mm)
OD 2 : 207 (mm)
ID 1 : 106.5 (mm)

CONT : 1
VOL : 0.021

A-8670 Air Filter Secondary Soft PU end cap Element



CASE 187472A1
CASE 187472A2
MASSEY-FERGUSON 4270036M1
NEW HOLLAND (CNH) 8602996

Primary Filter uses A-8671
Set Filter uses A-8672-S
H 1 : 385 (mm)
H 2 : 380 (mm)
OD 1 : 107.5 (mm)
OD 2 : 101.5 (mm)
ID 1 : 89 (mm)

CONT : 25
VOL : 0.152

A-8505 Air Filter Primary Soft PU end cap Element



OPEL 1#123 84 075
OPEL 1-12384075
SUNWARD 730403000155

Secondary Filter uses A-8599
Set Filter uses A-8602-S
H 1 : 312 (mm)
H 2 : 304 (mm)
OD 1 : 127.5 (mm)
OD 2 : 127.5 (mm)
ID 1 : 83 (mm)

CONT : 16
VOL : 0.109

Note : For Flame Retardant version, use A-76410

A-8578 Air Filter Secondary Soft PU end cap Element



J.C.BAMFORD 32/912902
KOMATSU 42X01H0P01
KOMATSU 600-185-3120

Primary Filter uses A-8577
Set Filter uses A-8577-S
H 1 : 407.5 (mm)
H 2 : 401 (mm)
OD 1 : 107 (mm)
OD 2 : 100 (mm)
ID 1 : 87 (mm)

CONT : 25
VOL : 0.193

AH-7908 Air Filter Rigid PU end cap Disposable Housing



VOLVO 11033214
CUMMINS 3908719
IVECO 8007965

H 1 : 276 (mm)
H 2 : 241 (mm)
Intake Connection Height : 35 (mm)
Outside Housing OD 1 : 216 (mm)
Outside Housing OD 2 : 216 (mm)
Intake Connection ID 1 : 75 (mm)

CONT : 4
VOL : 0.070

A-8513 Air Filter Primary Soft PU end cap Element



YANMAR 119808-12520
NISSAN 16546-FJ100
KOMATSU 3EB-02-38730
SUNWARD 730403000157

Secondary Filter uses A-5569
Set Filter uses A-5570-S
H 1 : 273.5 (mm)
H 2 : 265 (mm)
OD 1 : 104 (mm)
OD 2 : 104 (mm)
ID 1 : 61 (mm)

CONT : 25
VOL : 0.110

Note : A-85134(with Flame Retardant Media)

A-8580 Air Filter Secondary Soft PU end cap Element



CATERPILLAR 142-1403
ATLAS COPCO 3222-1881-92
HITACHI 4466268

Primary Filter uses A-8579
Set Filter uses A-8579-S
H 1 : 500 (mm)
H 2 : 494 (mm)
OD 1 : 179 (mm)
OD 2 : 174 (mm)
ID 1 : 148 (mm)

CONT : 1
VOL : 0.019

Note : Is a Secondary Air filter of A-8579M,A-8665M

AS-5102 Air Filter Primary Soft PU end cap Element With Sleeve



VOLVO 11110022
HITACHI 4459549

Secondary Filter uses A-5103
Set Filter uses AS-5102-S
H 1 : 522 (mm)
H 2 : 510 (mm)
OD 1 : 280 (mm)
OD 2 : 280 (mm)
ID 1 : 148 (mm)

CONT : 1
VOL : 0.047

A-8553 Air Filter Primary Soft PU end cap Element



YANMAR 129948-12621
VOLVO (TRUCK/VCE/VME/PENTA) 14255046
KUBOTA 1G377-11210

Secondary Filter uses A-8554
Set Filter uses A-8553-S
H 1 : 362 (mm)
H 2 : 328 (mm)
OD 1 : 149 (mm)
OD 2 : 149 (mm)
ID 1 : 84 (mm)

CONT : 12
VOL : 0.120

A-8599 Air Filter Secondary Soft PU end cap Element



KUBOTA 119005-12571
CASE 133721A1
HITACHI 4326841

Primary Filter uses A-8505
Set Filter uses A-8602-S
H 1 : 303.5 (mm)
H 2 : 298 (mm)
OD 1 : 83 (mm)
OD 2 : 79 (mm)
ID 1 : 64 (mm)

CONT : 25
VOL : 0.076

Note : Is a Secondary Air filter for A-5669,A-8505

AS-5102-S Air Filter Set Soft PU end cap Element With Sleeve



VOLVO 11110022+11110023

Primary Filter uses AS-5102
Secondary Filter uses A-5103
H 1 : 522 (mm)
H 2 : 510 (mm)
OD 1 : 280 (mm)
OD 2 : 280 (mm)
ID 1 : 148 (mm)

CONT : 1
VOL : 0.050

A-8554 Air Filter Soft PU end cap Element



KHD(KLOCKNER-HUMBOLT-DEUTZ) 118 0870
YANMAR 129948-12630
VOLVO (TRUCK/VCE/VME/PENTA) 14255061
MASSEY-FERGUSON 3901465M2

H 1 : 345 (mm)
H 2 : 342 (mm)
OD 1 : 75 (mm)
OD 2 : 77 (mm)
ID 1 : 62 (mm)

CONT : 25
VOL : 0.104

A-8651 Air Filter Secondary Soft PU end cap Element



HITACHI 4459548
KOMATSU 600-185-4220
JOHN DEERE F434395
CASE IH275810A1

Primary Filter uses A-8650
Set Filter uses A-8652-S
H 1 : 502 (mm)
H 2 : 497 (mm)
OD 1 : 150 (mm)
OD 2 : 141.5 (mm)
ID 1 : 109 (mm)

CONT : 9
VOL : 0.134

Note : Is a long life version of A-5103

AS-8579 Air Filter Primary Soft PU end cap Element With Sleeve



VOLVO 11033996
VOLVO BM 110339967
CATERPILLAR 142-1340

Secondary Filter uses A-8580
Set Filter uses AS-8579-S
H 1 : 521 (mm)
H 2 : 510 (mm)
OD 1 : 313 (mm)
OD 2 : 313 (mm)
ID 1 : 178 (mm)

CONT : 1
VOL : 0.057

Sakura Filter

Technical Specification

AS-8579-S Air Filter Set Soft PU end cap Element With Sleeve

TEREX 15270188 + 15270189
HITACHI 76612497+4466268



Primary Filter uses AS-8579
Secondary Filter uses A-8580
H 1 : 521 (mm)
H 2 : 510 (mm)
OD 1 : 313 (mm)
OD 2 : 313 (mm)
ID 1 : 178 (mm)

CONT : 1
VOL : 0.057

C-1828 Oil Filter Full Flow Spin-On

FORDFINISCODE 5007124



H 1 : 120 (mm)
OD 1 : 76 (mm)
Thread Size : 3/4-16 UNF-2B
BPV (kg/cm2) : 1.4 - 1.6
ADBV : YES
Gasket Type : Square

CONT : 50
VOL : 0.043

C-5717 Oil Filter By Pass Spin-On

VOLVO 477556
VOLVO 477556-5



H 1 : 259 (mm)
OD 1 : 108 (mm)
Thread Size : 1 3/8-16 UNF-2B
Gasket Type : Square

CONT : 6
VOL : 0.026

AS-8579M Air Filter Primary Soft PU+Metal Element With Sleeve

HITACHI 76612497



Secondary Filter uses A-8580
Set Filter uses AS-8579M-S
H 1 : 521 (mm)
H 2 : 510 (mm)
OD 1 : 313 (mm)
OD 2 : 313 (mm)
ID 1 : 178 (mm)

CONT : 1
VOL : 0.060

Note : with metal reinforcement

C-2508 Oil Filter Full Flow Spin-On

RENAULT 0 000 054 020
RENAULT 0 000 504 020
RENAULT 0 001 907 947



H 1 : 206 (mm)
OD 1 : 93 (mm)
Thread Size : 1-12 UNF-2B
BPV (kg/cm2) : 2.0 - 2.5
ADBV : YES
Gasket Type : Square

CONT : 12
VOL : 0.031

Note : With Hat

C-5723 Oil Filter Combination Spin-On

KOMATSU 6742-01-4120



H 1 : 280 (mm)
OD 1 : 121 (mm)
Thread Size : 2 1/4-12 UNF-2B
Gasket Type : Square

CONT : 6
VOL : 0.038

C-1011 Oil Filter Full Flow Spin-On

NISSAN 15208-HC400
HINO 15607-1920
MAZDA JEYO-14-302



H 1 : 85 (mm)
OD 1 : 68 (mm)
Thread Size : M20X1.5-6H
BPV (kg/cm2) : 1.0
ADBV : YES
Gasket Type : Round

CONT : 50
VOL : 0.026

Note : Square version uses C-1030

C-5102 Oil Filter Full Flow Spin-On

PERKINS 26540347
PERKINS 2654407



H 1 : 168 (mm)
OD 1 : 93 (mm)
Thread Size : 3/4-16 UNF-2B
BPV (kg/cm2) : 1.0
ADBV : YES
Gasket Type : Square

CONT : 25
VOL : 0.050

C-6202 Oil Filter Full Flow Spin-On

DEMAG 206 089 40
RENAULT 60 05 024 443



H 1 : 140 (mm)
OD 1 : 93 (mm)
Thread Size : 1-12 UNF-2B
BPV (kg/cm2) : 1.0
Gasket Type : Square

CONT : 25
VOL : 0.041

Note : Without Nut

C-1720 Oil Filter Full Flow Spin-On

TCM 12163-82302
YANMAR 129150-35152



H 1 : 100 (mm)
OD 1 : 90 (mm)
Thread Size : M20X1.5-6H
BPV (kg/cm2) : 1.0
ADBV : YES
Gasket Type : Round

CONT : 36
VOL : 0.040

C-5510 Oil Filter Full Flow Spin-On Cellulose media

CATERPILLAR 1R-0658
CATERPILLAR 1R-1807
CATERPILLAR 3Y-0900x
CATERPILLAR 3Y-900X



H 1 : 262 (mm)
OD 1 : 108 (mm)
Thread Size : 1 1/8-16 UNF-2B
Gasket Type : Square

CONT : 6
VOL : 0.023

Note : High performance grade uses C-5522 ,Aluminium Casting version uses C-5506

C-6204 Oil Filter Full Flow Spin-On

MERCEDES-BENZ 001 184 96 01
DEUTZ 1173430
CATERPILLAR 5W-6017
ALLIS CHALMERS 61671600
EVOBUS 7.119.226.04



H 1 : 206 (mm)
OD 1 : 93 (mm)
Thread Size : 1-12 UNF-2B
BPV (kg/cm2) : 2.0 - 2.5
ADBV : YES
Gasket Type : Square

CONT : 25
VOL : 0.057

Note : With Grip

C-1809 Oil Filter Full Flow Spin-On

NISSAN 15208-AA080
NISSAN 15208-HC010
NISSAN 15208-HC430



H 1 : 65 (mm)
OD 1 : 68 (mm)
Thread Size : M20X1.5-6H
BPV (kg/cm2) : 1.0
ADBV : YES
Gasket Type : Round

CONT : 50
VOL : 0.021

C-5704 Oil Filter Full Flow Spin-On Cellulose media

J.C.BAMFORD 02/910140
J.C.BAMFORD 02/910140A
CUMMINS 3903264



H 1 : 174 (mm)
OD 1 : 93 (mm)
Thread Size : 1-16 UNF-2B
Gasket Type : Square

CONT : 12
VOL : 0.023

Note : High Performance Grade Uses C-5730

C-6210 Oil Filter Full Flow Spin-On

VOLVO 423135-8



H 1 : 169 (mm)
OD 1 : 93 (mm)
Thread Size : 1-12 UNF-2B
BPV (kg/cm2) : 1.0
Gasket Type : Square

CONT : 12
VOL : 0.023

Sakura Filter

Technical Specification

C-6215 Oil Filter Full Flow Spin-On

BMW 17 22 1 331 206.2
RENAULT 5 001 846 639
FENDT F 284 201 310 040



H 1 : 206 (mm)
OD 1 : 93 (mm)
Thread Size : 1-12 UNF-2B
BPV (kg/cm2) : 2.0 - 2.5
Gasket Type : Square

CONT : 12
VOL : 0.028

91

CA-2401 Cabin Air Filter Plastic framed Element

VOLVO 11703979



H 1 : 44 (mm)
Length 1 : 435 (mm)
Width 1 : 123 (mm)

CONT : 16
VOL : 0.049

Note : For Anti Virus type please check CAV number.

96

CAV-2401 Cabin Air Filter Plastic framed Element antivirus,antibacterial

VOLVO 11703979



H 1 : 44 (mm)
Length 1 : 435 (mm)
Width 1 : 111 (mm)

CONT : 16
VOL : 0.051

Note : For Standard type please check CA number.

101

C-6806 Oil Filter Full Flow Spin-On

VW GROUP 035 115 591
DEUTZ 1174416
KHD(KLOCKNER-HUMBOLT-DEUTZ) 1174416
VOLVO 5000480
GENERAL MOTORS 6696776



H 1 : 90 (mm)
OD 1 : 76 (mm)
Thread Size : 3/4-16 UNF-2B
BPV (kg/cm2) : 2.0 - 2.5
ADBV : YES
Gasket Type : Square

CONT : 50
VOL : 0.036

92

CA-2402 Cabin Air Filter Plastic framed Element

VOLVO 11703980



H 1 : 62 (mm)
Length 1 : 506 (mm)
Width 1 : 286 (mm)

CONT : 16
VOL : 0.167

97

EF-2405 Fuel Filter Eco Element High Efficiency

DEUTZ 0293 1116
DEUTZ 02931449
DEUTZ 0425 2603
VOLVO 11988962



H 1 : 98.5 (mm)
H 2 : 87.5 (mm)
OD 1 : 73 (mm)
OD 2 : 72 (mm)
ID 1 : 37 (mm)
ID 2 : 11 (mm)

CONT : 50
VOL : 0.033

102

C-7105 Oil Filter Full Flow Spin-On

VOLVO 478736
VOLVO 478736-2
RENAULT 5 001 846 642



H 1 : 259 (mm)
OD 1 : 108 (mm)
Thread Size : 1 1/8-16 UNF-2B
Gasket Type : Square

CONT : 6
VOL : 0.026

93

CA-2405 Cabin Air Filter Soft PU framed Element

VOLVO 11007388
VOLVO 110073889
VOLVO 1584575
VOLVO 1584575-3



H 1 : 45 (mm)
Length 1 : 268 (mm)
Width 1 : 188 (mm)

CONT : 20
VOL : 0.059

98

EO-2404 Oil Filter Full Flow Eco Element

LINDE 000 983 1637
VOLVO 11708551
DEUTZ 293 1095



H 1 : 213 (mm)
H 2 : 199 (mm)
OD 1 : 83 (mm)
OD 2 : 83 (mm)
ID 1 : 37 (mm)
ID 2 : 9 (mm)

CONT : 50
VOL : 0.094

103

C-71060 Oil Filter Full Flow Spin-On

FAW D.L DIESEL 1012010A53DM
VOLVO 466634-3



H 1 : 259 (mm)
OD 1 : 108 (mm)
Thread Size : 1 1/8-16 UNF-2B
BPV (kg/cm2) : 2.0
Gasket Type : Square

CONT : 6
VOL : 0.029

Note : C-71060 with bypass valve,C-7105 without by pass vale

94

CA-71010 Cabin Air Filter Plastic framed Element

VOLVO 14506997



H 1 : 30 (mm)
Length 1 : 416 (mm)
Width 1 : 300 (mm)

CONT : 5
VOL : 0.026

99

EO-2626 Oil Filter Full Flow Eco Element

MERCEDES-BENZ 000 180 16 09
VOLVO 11708550
MERCEDES-BENZ 904 180 00 09



H 1 : 148.5 (mm)
H 2 : 136 (mm)
OD 1 : 84 (mm)
OD 2 : 83 (mm)
ID 1 : 37 (mm)
ID 2 : 9.25 (mm)

CONT : 50
VOL : 0.067

104

C-7921 Oil Filter Full Flow Spin-On

PERKINS 140 516 130
SAAB-SCANIA 173171
KUBOTA 1C010-32430



H 1 : 92 (mm)
OD 1 : 93 (mm)
Thread Size : 3/4-16 UNF-2B
BPV (kg/cm2) : 1.0
ADBV : YES
Gasket Type : Square

CONT : 12
VOL : 0.016

Note : With HAT/CAP

95

CA-71020 Cabin Air Filter Plastic framed Element

VOLVO 14503269



H 1 : 56.5 (mm)
Length 1 : 325.5 (mm)
Width 1 : 152.5 (mm)

CONT : 20
VOL : 0.081

100

F-2601 Fuel Filter Metal End Cap Element

MERCEDES-BENZ 1457431261
IVECO 190605
DAEWOO 65.12503-5003



H 1 : 113 (mm)
H 2 : 107 (mm)
OD 1 : 64 (mm)
OD 2 : 64 (mm)
ID 1 : 12.8 (mm)
ID 2 : 12.8 (mm)

CONT : 50
VOL : 0.035

Note : Paper Protector

105

Sakura Filter

Technical Specification

F-2604 Fuel Filter Metal End Cap Element

MERCEDES-BENZ 000 477 40 15
 MERCEDES-BENZ 000 477 45 15
 MERCEDES-BENZ 355 470 01 92



H 1 : 145 (mm)
 H 2 : 138 (mm)
 OD 1 : 83 (mm)
 OD 2 : 83 (mm)
 ID 1 : 14 (mm)
 ID 2 : 14 (mm)

CONT : 50
 VOL : 0.062

106

FC-5704 Fuel Filter Spin-On

VOLVO 241672
 VOLVO 243004
 MASSEY-FERGUSON 2871513M1



H 1 : 123 (mm)
 OD 1 : 76 (mm)
 Thread Size : M16X1.5-6H
 Gasket Type : Square

CONT : 50
 VOL : 0.047

Note : With Center Tube

111

FC-7102 Fuel Filter Spin-On High Efficiency

VOLVO 420799
 VOLVO 420799-9
 VOLVO 8193841



H 1 : 214 (mm)
 OD 1 : 93 (mm)
 Thread Size : M18X1.5-6H
 Gasket Type : Square

CONT : 6
 VOL : 0.016

116

FC-24010 Fuel Filter Spin-On High Efficiency

VOLVO 17246025



H 1 : 100 (mm)
 OD 1 : 90 (mm)
 Thread Size : M20X1.5-6H
 Gasket Type : Round

CONT : 25
 VOL : 0.036

107

FC-5715 Fuel Filter Spin-On With Drain Plug

KHD(KLOCKNER-HUMBOLT-DEUTZ) 1174482
 J.C.BAMFORD 32/912001



H 1 : 163 (mm)
 OD 1 : 81.5 (mm)
 Thread Size : M16X1.5-6H
 Thread Nut Size : M8X1.25
 Gasket Type : Square

CONT : 25
 VOL : 0.037

112

FC-7103 Fuel Filter Spin-On

VOLVO 8385932



H 1 : 145 (mm)
 OD 1 : 76 (mm)
 Thread Size : M16X1.5-6H
 Thread Nut Size : M8X1.25
 Gasket Type : Square

CONT : 25
 VOL : 0.034

Note : Drain Nut

117

FC-5101 Fuel Filter Can-type Housing

MASSEY-FERGUSON 1896287M91
 PEUGEOT 1906.12



H 1 : 113 (mm)
 OD 1 : 84 (mm)
 OD 2 : 87.3 (mm)
 ID 1 : 19 (mm)
 ID 2 : 19 (mm)

CONT : 50
 VOL : 0.054

108

FC-5721 Fuel Filter Spin-On

CUMMINS 156172
 FIAT-ALLIS 70697633
 FORD 749F9176AAA
 VOLVO 79250023



H 1 : 136 (mm)
 OD 1 : 93 (mm)
 Thread Size : 1-14 UNS-2B
 Gasket Type : Square

CONT : 12
 VOL : 0.023

113

FC-7107 Fuel Filter Primary Spin-On

VOLVO 466987-5



H 1 : 123 (mm)
 OD 1 : 76 (mm)
 Thread Size : M16X1.5-6H
 Gasket Type : Square

CONT : 12
 VOL : 0.012

118

FC-5105 Fuel Filter Can-type Housing

MASSEY-FERGUSON 1896287M91
 MASSEY-FERGUSON 3405419M1
 MASSEY-FERGUSON 3405419M91



H 1 : 113 (mm)
 OD 1 : 85.5 (mm)
 ID 1 : 36.5 (mm)
 ID 2 : 19 (mm)

CONT : 50
 VOL : 0.054

109

FC-5723 Fuel Filter Spin-On

LOMBARDINI 276-2175-046
 VOLVO 7243004-4



H 1 : 122 (mm)
 OD 1 : 76 (mm)
 Thread Size : M16X1.5-6H
 Gasket Type : Square

CONT : 50
 VOL : 0.047

Note : High Performance versions uses FC-25060

114

FC-7108 Fuel Filter Spin-On High Efficiency

VOLVO 20405160
 VOLVO 20430751
 MACK 2053-9582
 VOLVO 20976003



H 1 : 264.7 (mm)
 OD 1 : 108 (mm)
 Thread Size : M32X1.5-6H
 Gasket Type : Square

CONT : 6
 VOL : 0.026

Note : High performance version of FC-7104

119

FC-5702 Fuel Filter Spin-On

MITSUBISHI 32540-20300
 MITSUBISHI 32562-20300
 HITACHI 4085912



H 1 : 175 (mm)
 OD 1 : 93 (mm)
 Thread Size : 1-14 UNS-2B
 Gasket Type : Square

CONT : 12
 VOL : 0.030

Note : Drain nut

110

FC-6205 Fuel Filter Spin-On

DEUTZ 1174424
 CROSLAND 5003



H 1 : 79 (mm)
 OD 1 : 76 (mm)
 Thread Size : M16X1.5-6H
 Gasket Type : Square

CONT : 50
 VOL : 0.031

Note : With center tube

115

FC-71100 Fuel Filter Spin-On

VOLVO 11708555



H 1 : 108 (mm)
 OD 1 : 93.5 (mm)
 Thread Size : M16X1.5-6H
 Gasket Type : Square

CONT : 12
 VOL : 0.018

120

Sakura Filter

Technical Specification

FC-71120 Fuel Filter Spin-On High Efficiency



DEUTZ 1182674
VOLVO 20805349
BOMAG 5717966
VOLVO 80676462
FENDT F934201060010

H 1 : 200 (mm)
OD 1 : 93 (mm)
Thread Size : M18X1.5-6H
Gasket Type : Square

CONT : 12
VOL : 0.030

121

H-65030 Hydraulic Oil Filter Transmission Metal End Cap Element



VOLVO 15052
HITACHI 1930779
GENERAL MOTORS 25010836
GENERAL MOTORS 25011193
ALLIS CHALMERS 618179

H 1 : 228 (mm)
H 2 : 226 (mm)
OD 1 : 109.5 (mm)
OD 2 : 109.5 (mm)
ID 1 : 38.3 (mm)
ID 2 : 38.3 (mm)

CONT : 12
VOL : 0.043

126

H-71130 Hydraulic Oil Filter Metal End Cap Element



VOLVO 11026936-2
ARLON TXW8BCC25

H 1 : 390 (mm)
H 2 : 390 (mm)
OD 1 : 126 (mm)
OD 2 : 126 (mm)
ID 1 : 91.6 (mm)
ID 2 : 9 (mm)

CONT : 6
VOL : 0.054

131

FC-7901 Fuel Filter Spin-On



VOLVO 795210
EMD/GENERAL MOTORS 8423132
EMD/GENERAL MOTORS EMD 8423132

H 1 : 179 (mm)
OD 1 : 93 (mm)
Thread Size : 1-12 UNF-2B
Gasket Type : Square

CONT : 12
VOL : 0.029

122

H-7101 Hydraulic Oil Filter Metal End Cap Element



VOLVO 14509379

H 1 : 450 (mm)
OD 1 : 150 (mm)
OD 2 : 150 (mm)
ID 1 : 110 (mm)
ID 2 : 110 (mm)

CONT : 6
VOL : 0.085

127

H-71210 Hydraulic Oil Filter Return Metal End Cap Element



VOLVO 14569658

H 1 : 432.5 (mm)
H 2 : 430 (mm)
OD 1 : 178 (mm)
OD 2 : 178 (mm)
ID 1 : 109 (mm)

CONT : 1
VOL : 0.019

Note : Volvo Hydraulic Excavators EC360CL, EC 480E

132

FC-7903 Fuel Filter Secondary Spin-On High Efficiency



J.C.BAMFORD 02/910155
CUMMINS 3903640
CUMMINS 3931063

H 1 : 115 (mm)
OD 1 : 76 (mm)
Thread Size : M16X1.5-6H
Gasket Type : Square

CONT : 25
VOL : 0.023

123

H-7102 Hydraulic Oil Filter Transmission Metal End Cap Element



MERCEDES-BENZ 000 270 10 98
ZF 0501 203 018
ZF 0750 131 003

H 1 : 103.7 (mm)
H 2 : 97.3 (mm)
OD 1 : 68.6 (mm)
OD 2 : 68.6 (mm)
ID 1 : 33 (mm)

CONT : 50
VOL : 0.037

128

H-85560 Hydraulic Oil Filter Metal End Cap Element with synthetic media



VOLVO 11026932
VOLVO 110269321
TAMROCK 86727289
CASE 87353685

H 1 : 290 (mm)
OD 1 : 126 (mm)
OD 2 : 126 (mm)
ID 1 : 91.6 (mm)
ID 2 : 9 (mm)

CONT : 6
VOL : 0.040

133

H-2709 Hydraulic Oil Filter Metal End Cap Element

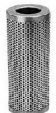

KOMATSU 07063-01383
KOMATSU 208-60-61150
HITACHI 4287634
HITACHI 76580323

H 1 : 450 (mm)
OD 1 : 180 (mm)
OD 2 : 180 (mm)
ID 1 : 110 (mm)
ID 2 : 110 (mm)

CONT : 9
VOL : 0.173

124

H-7105 Hydraulic Oil Filter additional part Metal End Cap Element With Microfiber media



VOLVO 14532686
HITACHI 4157882

H 1 : 86 (mm)
H 2 : 82.5 (mm)
OD 1 : 42.5 (mm)
OD 2 : 42.5 (mm)
ID 1 : 21.5 (mm)

CONT : 50
VOL : 0.014

129

H-86030-12 Hydraulic Oil Filter Metal End Cap Element Synthetic Media



HYDAC 0240D010BN3HC

H 1 : 175 (mm)
H 2 : 168.5 (mm)
OD 1 : 68.6 (mm)
OD 2 : 68.6 (mm)
ID 1 : 32.4 (mm)

CONT : 0
VOL : 0.000

134

H-2719 Hydraulic Oil Filter Metal End Cap Element Cellulose media



HYUNDAI 31E3-0018
HITACHI 4294135
YAMASHIN DT-04-10-10

H 1 : 87 (mm)
H 2 : 83.5 (mm)
OD 1 : 42.5 (mm)
OD 2 : 42.5 (mm)
ID 1 : 21.5 (mm)

CONT : 50
VOL : 0.011

Note : Wiremesh type uses H-5211

125

H-7106 Hydraulic Oil Filter Metal End Cap Element with synthetic media



VOLVO 14539482

H 1 : 432.5 (mm)
H 2 : 430 (mm)
OD 1 : 150 (mm)
OD 2 : 150 (mm)
ID 1 : 112 (mm)
ID 2 : 110 (mm)

CONT : 6
VOL : 0.076

130

HC-45050 Hydraulic Oil Filter Transmission Spin-On Synthetic Media



CASE-IH CNH 1302541
CASE-IH CNH 181167A1
CUMMINS 181167A1

H 1 : 152 (mm)
OD 1 : 94.5 (mm)
Thread Size : 13/16-16 UNF-2B
Gasket Type : Round

CONT : 12
VOL : 0.024

Note : Aluminium casting version

135

Sakura Filter

Technical Specification

HC-5503 Hydraulic Oil Filter Spin-On Synthetic Media

CATERPILLAR 1081153
INGERSOLL RAND 51302214
VOLVO BM 9658998



H 1 : 293 (mm)
OD 1 : 122 (mm)
Thread Size : 1 3/4-12 UNF-2B

CONT : 6
VOL : 0.032

Note : with Glass Fiber media

136

HC-5602 Hydraulic Oil Filter Spin-On

KOMATSU 113-60-43320
KOMATSU 113-60-43321
KOMATSU 209-607-6210
HITACHI 4205684
KUBOTA 68773-62230



H 1 : 171 (mm)
OD 1 : 125 (mm)
Thread Size : M48X2-6H

CONT : 6
VOL : 0.026

141

HC-79331 Hydraulic Oil Filter Full Flow Spin-On

VOLVO 12754597



H 1 : 270 (mm)
OD 1 : 123 (mm)
Thread Size : 1 1/2-16 UN-2B
Gasket Type : Square

CONT : 6
VOL : 0.039

Note : HC-7933 (qty.outer packing difference)

146

HC-5504 Hydraulic Oil Filter Spin-On Synthetic Media

CASE 132575302
CATERPILLAR 1G-8878
NEW HOLLAND (CNH) 81863799



H 1 : 240 (mm)
OD 1 : 94.5 (mm)
Thread Size : 1 3/8-12 UNF-2B
Gasket Type : Square

CONT : 12
VOL : 0.035

Note : HC-7927 ==> cellulose media
HC-5504 ==> with glass fiber media

137

HC-6802 Hydraulic Oil Filter Spin-On

MASSEY-FERGUSON 2979653M1
VOLVO 4787923
INGERSOLL RAND 54672654



H 1 : 213.5 (mm)
OD 1 : 93 (mm)
Thread Size : 1-12 UNF-2B
ADBV : YES
Gasket Type : Square

CONT : 12
VOL : 0.034

142

HC-8805 Hydraulic Oil Filter Spin-On

INTERPARTS KNJ0288



H 1 : 136 (mm)
OD 1 : 93 (mm)
Thread Size : 1 1/8-16 UNS-2B
Gasket Type : Square

CONT : 12
VOL : 0.022

147

HC-5506 Hydraulic Oil Filter Spin-On Synthetic Media

CATERPILLAR 310694
CASE A49386
JOHN DEERE AT112393



H 1 : 293 (mm)
OD 1 : 116 (mm)
Thread Size : 1 3/4-12 UNF-2B

CONT : 6
VOL : 0.034

Note : with glass fiber media

138

HC-7001 Hydraulic Oil Filter Spin-On

GEHL 137359
NEW HOLLAND (CNH) 85802793



H 1 : 293 (mm)
OD 1 : 116 (mm)
Thread Size : 1 3/4-12 UNF-2B

CONT : 6
VOL : 0.031

143

O-2605 Oil Filter By Pass Can-type Depth

IVECO 1168469
KHD(KLOCKNER-HUMBOLT-DEUTZ) 1168469
LIEBHERR 5502266



H 1 : 203 (mm)
H 2 : 197 (mm)
OD 1 : 108 (mm)
OD 2 : 108 (mm)
ID 1 : 13 (mm)
ID 2 : 13 (mm)

CONT : 25
VOL : 0.070

148

HC-5508 Hydraulic Oil Filter Spin-On Synthetic Media

KOMATSU 1281327H1
CASE 1346028C1
CATERPILLAR 9T5916



H 1 : 240 (mm)
OD 1 : 94.5 (mm)
Thread Size : 1 3/8-12 UNF-2B

CONT : 12
VOL : 0.036

Note : with Glass Fiber Media

139

HC-71030 Hydraulic Oil Filter Spin-On

VOLVO 43921394



H 1 : 170 (mm)
OD 1 : 128.5 (mm)
Thread Size : 1 1/2-16 UN-2B

CONT : 0
VOL : 0.000

144

SF-7922 Fuel/Water Separator Metal framed Element

SEPAR 01030
CASE 87409379



H 1 : 51 (mm)
Length 1 : 88 (mm)
Width 1 : 88 (mm)

CONT : 50
VOL : 0.034

149

HC-55190 Hydraulic Oil Filter Spin-On With Microfiber media

VOLVO 11037650
VOLVO 110376506
CHARLES MACHINE 149641A
J.C.BAMFORD 32/922500



H 1 : 240 (mm)
OD 1 : 94.5 (mm)
Thread Size : 1 3/8-12 UNF-2B

CONT : 12
VOL : 0.035

140

HC-7901 Hydraulic Oil Filter Spin-On

INTERNATIONAL HARVESTER 075912103
KOBELCO 2446U141S2



H 1 : 130 (mm)
OD 1 : 93 (mm)
Thread Size : 1 1/8-16 UNF-2B
Gasket Type : Round

CONT : 12
VOL : 0.020

Note : Seat assy zinc coating

145

SFC-5301-10 Fuel/Water Separator Spin-On 10 Micron

MERCEDES-BENZ 000 470 04 69
MERCEDES-BENZ A 000 470 04 69
MERCEDES-BENZ A 000 477 13 02
MERCEDES-BENZ R90-MER-01



H 1 : 217 (mm)
OD 1 : 108 (mm)
Thread Size : 1-14 UNS-2B

CONT : 6
VOL : 0.022

Note : bowl not included

150

Sakura Filter

Technical Specification

SFC-5301-10B

Fuel/Water Separator Spin-On With Bowl 10 Micron

MERCEDES-BENZ 000 470 04 69
 MERCEDES-BENZ A 000 470 04 69
 MERCEDES-BENZ R90-MER-01



H 1 : 308 (mm)
 H 2 : 217 (mm)
 OD 1 : 108 (mm)
 Thread Size : 1-14 UNS-2B

CONT : 6
 VOL : 0.029

Note : SFC-5301-10 and FB-1813

151

SFC-7912-30

Fuel/Water Separator Primary Spin-On 30 Micron

HYUNDAI 11LB-20310
 SAAB-SCANIA 1393640
 ATLAS COPCO 2914807000
 VOLVO 8159975



Secondary Filter uses SFC-7912-10
 Final Filter uses SFC-7912-02
 H 1 : 155,3 (mm)
 H 2 : 143,5 (mm)
 OD 1 : 108 (mm)
 Thread Size : 1-14 UNS-2B
 Gasket Type : Square

CONT : 12
 VOL : 0.033

Note : for 300RC series,400 series,600 series,700 series

156

WC-71030

Coolant Filter Spin-On

VOLVO 20458769
 VOLVO 3945411



H 1 : 136 (mm)
 OD 1 : 93 (mm)
 Thread Size : M16X1.5-6H
 Gasket Type : Square

CONT : 12
 VOL : 0.021

161

SFC-5705

Fuel/Water Separator Spin-On

ISUZU 1-13240044-1
 CUMMINS 3308638
 CUMMINS 3315843
 SUNWARD 750201011130



H 1 : 174 (mm)
 OD 1 : 93 (mm)
 Thread Size : 1-14 UNS-2B
 Gasket Type : Square

CONT : 12
 VOL : 0.026

152

WC-5705

Coolant Filter Spin-On

CUMMINS 299080
 CUMMINS 3100304
 CUMMINS 3305367



H 1 : 100 (mm)
 OD 1 : 93 (mm)
 Thread Size : 11/16-16 UNF-2B
 Gasket Type : Square

CONT : 12
 VOL : 0.018

Note : Coolants = 4 units

157

SFC-5706

Fuel/Water Separator Spin-On

J.C.BAMFORD 02/910150
 J.C.BAMFORD 02/910150A
 HYUNDAI 11E1-70210
 CUMMINS 3935274
 CASE J925274



H 1 : 163.7 (mm)
 H 2 : 134 (mm)
 OD 1 : 93 (mm)
 OD 2 : 92.7 (mm)
 Thread Size : 13/16-18 UNF-2B
 Thread Nut Size : M14X2
 Gasket Type : Square

CONT : 12
 VOL : 0.021

153

WC-5711

Coolant Filter Spin-On

CUMMINS 3315115
 CUMMINS 3316462
 CUMMINS 4058964



H 1 : 100 (mm)
 OD 1 : 93 (mm)
 Thread Size : 11/16-16 UNF-2B
 Gasket Type : Square

CONT : 12
 VOL : 0.014

Note : Coolants = 8 units

158

SFC-7101-10

Fuel/Water Separator Secondary Spin-On 10 Micron

VOLVO 11110474
 VOLVO 11110668



H 1 : 204 (mm)
 OD 1 : 108 (mm)
 Thread Size : 1-14 UNS-2B
 Gasket Type : Square

CONT : 10
 VOL : 0.036

Note : bowl not included

154

WC-5713

Coolant Filter Spin-On

HITACHI 4228689
 INGERSOLL RAND 57165805



H 1 : 136 (mm)
 OD 1 : 93 (mm)
 Thread Size : 11/16-16 UNF-2B
 Gasket Type : Square

CONT : 12
 VOL : 0.022

Note : Coolants = 15 units

159

SFC-7901-30

Fuel/Water Separator Spin-On 30 Micron

VOLVO 11110189
 VOLVO 11110474



H 1 : 204 (mm)
 OD 1 : 108 (mm)
 Thread Size : 1-14 UNS-2B
 Gasket Type : Square

CONT : 10
 VOL : 0.024

Note : Bowl not included

155

WC-7101

Coolant Filter Spin-On

VOLVO 1661964
 VOLVO 1699830
 VOLVO 1699830-4



H 1 : 145 (mm)
 OD 1 : 93 (mm)
 Thread Size : M16X1.5-6H
 Gasket Type : Square

CONT : 12
 VOL : 0.020

Note : Coolants = 4 units

160