

# Clamp Catalogue

Hose Clamps

Cable Ties



**MH/HS Series**  
Part Stainless Steel,  
Perforated Band



page  
**6**

**MAH/HAS Series**  
All Stainless Steel,  
Perforated Band

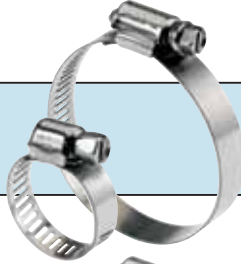

page  
**8**

**316 Series**  
All 316 Stainless Steel

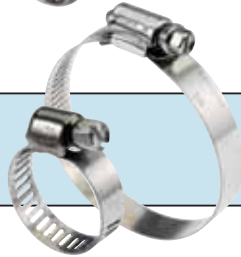

page  
**10**

**SMH/SHS Series**  
Part Stainless Steel,  
Solid Band



page  
**11**

**EFI Series**  
Extended Tang  
Micro Clamps



page  
**11**

**MP Series**  
Part Stainless Steel,  
Solid Band



page  
**12**

**SMP Series**  
All Stainless Steel,  
Solid Band



page  
**13**

**TTBY Series**  
Part Stainless Steel,  
Solid Band



page  
**14**

**TTBS Series**  
All Stainless Steel,  
Solid Band



page  
**15**

**TTBU Series**  
T-Bolt Ultimate Clamps



page  
**16**

**TS Series**  
Tri-Strength Clamps



page  
**16**

**QR Series**  
Quick Release Clamps



page  
**17**

**CV Series**  
CV Boot Clamps



page  
**17**

# contents

**UB Series**  
Uni Band,  
All Stainless Steel



page  
**18**

**CTC Series**  
Constant Tension  
Band Clamps



page  
**21**

**NA Series**  
Nut and Bolt Clamps



page  
**19**

**DW Series**  
Double Wire Clamps



page  
**21**

**TEC Series**  
Double Ear Clamps



page  
**19**

**CAI Series**  
Vinyl Coated Clamps



page  
**20**

**Cable Ties**  
Nylon and Stainless  
Steel Cable Ties



page  
**25**

**TRLC Series**  
Rubber Lined Clamps



page  
**20**

**Tools and  
Accessories**



page  
**29**

**SL Series**  
Spring Lock Clamps



page  
**21**

**Packaging and  
Merchandising**



page  
**33**







# Hose Clamps

Since 1976 Tridon Australia has been at the forefront of hose clamp technology. With a comprehensive range and proven quality and reliability, Tridon clamps are second to none.

All Tridon hose clamps are manufactured to stringent TS16949 / ISO9001 accredited quality standards and include a complete range of solid and perforated band worm drive clamps, heavy duty T-Bolt clamps and a range of specialty clamps suitable for automotive, industrial, marine or general purpose use.



# MH/HS

## MH/HS Series Part Stainless Steel, Perforated Band



- Superior design, proven reliability, trusted brand
- For automotive and general purpose use
- 301 stainless steel band
- Built to SAE J1508 Standard
- Hexagonal head with screwdriver slot
- Used in OE applications
- Low free torque for ease of installation
- Flexible band for superior sealing, conforms to hose
- High strength for reliable sealing
- Refer to page 34 for packaging styles
- Made in Australia

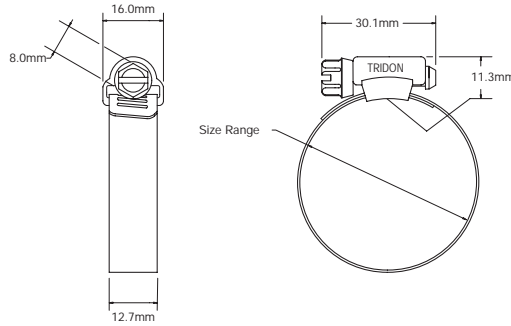
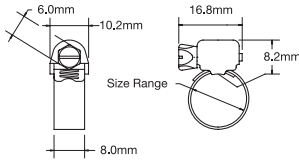

### Part No. MH004 – MH040

<b>Series</b>	MH (Micro Clamp)
<b>Band</b>	301 Stainless Steel
<b>Housing</b>	Mild Steel
<b>Screw</b>	Carbon Steel Zinc Plated (Hex Head)

### Part No. HS006 – HS270

<b>Series</b>	HS (Regular Clamp)
<b>Band</b>	301 Stainless Steel
<b>Housing</b>	Stainless Steel*
<b>Screw</b>	Carbon Steel Zinc Plated (Hex Head)

### Merchandisers & Clamp Packs

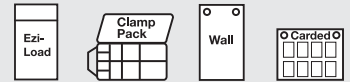

Refer to pages 35-38 for details

\* Some sizes are manufactured using carbon steel zinc plated housing







Ezi-Load Clamp Merchandiser



Torque Screwdriver (CTD-2)

# MH/HS

Size Range			Refills for Ezi-Load Merchandiser ELM300 		 (PACK OF 10)	 (PACK OF 20)			
	mm	Part No.	Qty per Card	Part No.	Qty per Refill	Part No.	Part No.	Part No.	Min. Order Qty
<b>Micro Clamp</b>									
6 - 16	MH004C	2	MH004RF	20	MH004P	MH004-20	MH004	500	
11 - 18	MH005C	2	MH005RF	20	MH005P	MH005-20	MH005	500	
11 - 22	MH006C	2	MH006RF	20	MH006P	MH006-20	MH006	500	
13 - 25					MH008P		MH008	500	
14 - 27					MH010P		MH010	500	
17 - 32					MH012P		MH012	500	
18 - 38					MH016P		MH016	500	
22 - 45					MH020P		MH020	500	
33 - 51					MH024P		MH024	500	
40 - 57					MH028P		MH028	500	
46 - 64					MH032P		MH032	500	
52 - 70					MH036P		MH036	300	
59 - 76					MH040P		MH040	300	
<b>Regular Clamp</b>									
11 - 22					HS006P	HS006-20	HS006	500	
13 - 25			HS008RF	15	HS008P	HS008-20	HS008	500	
14 - 27	HS010C	2	HS010RF	15	HS010P	HS010-20	HS010	500	
18 - 32	HS012C	2	HS012RF	15	HS012P	HS012-20	HS012	500	
21 - 38	HS016C	2	HS016RF	15	HS016P	HS016-20	HS016	500	
21 - 44	HS020C	1			HS020P	HS020-20	HS020	500	
27 - 51	HS024C	1	HS024RF	10	HS024P	HS024-20	HS024	500	
33 - 57	HS028C	1	HS028RF	10	HS028P	HS028-20	HS028	500	
40 - 64	HS032C	1	HS032RF	10	HS032P	HS032-20	HS032	500	
46 - 70					HS036P	HS036-20	HS036	300	
52 - 76					HS040P		HS040	300	
59 - 83					HS044P		HS044	300	
65 - 89					HS048P		HS048	300	
71 - 95					HS052P		HS052	300	
78 - 102					HS056P		HS056	300	
84 - 108					HS060P		HS060	300	
90 - 114					HS064P		HS064	200	
103 - 127					HS072P		HS072	200	
117 - 140					HS080P		HS080	100	
125 - 146					HS084P		HS084	100	
106 - 152					HS088P		HS088	100	
115 - 165					HS096P		HS096	100	
133 - 178					HS104P		HS104	100	
146 - 197							HS116	10	
159 - 206							HS120	10	
175 - 217							HS128	10	
181 - 225							HS136	10	
206 - 251							HS152	10	
222 - 273							HS164	10	
260 - 311							HS188	10	
267 - 318							HS192	10	
298 - 349							HS212	10	
391 - 441							HS270	10	

# MAH/HAS

## MAH/HAS Series All Stainless Steel, Perforated Band



- For marine, industrial, automotive, agricultural, chemical and general purpose use
- All stainless steel for corrosion protection
- Built to SAE J1508 Standard
- Hexagonal head with screwdriver slot
- Low free torque for ease of installation
- Used in OE applications
- Flexible band for superior sealing, conforms to hose
- High strength for reliable sealing
- Refer to page 34 for packaging styles
- Made in Australia

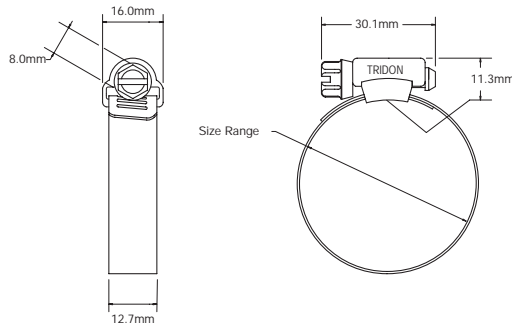
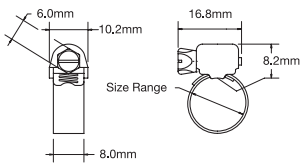

### Part No. MAH004 – MAH040

<b>Series</b>	MAH (Micro Clamp)
<b>Band</b>	301 Stainless Steel
<b>Housing</b>	301 Stainless Steel
<b>Screw</b>	305 Stainless Steel (Hex Head)

### Part No. HAS006 – HAS270

<b>Series</b>	HAS (Regular Clamp)
<b>Band</b>	301 Stainless Steel
<b>Housing</b>	301 Stainless Steel
<b>Screw</b>	305 Stainless Steel (Hex Head)

### Merchandisers & Clamp Packs

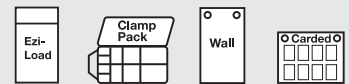

Refer to pages 35-38 for details







Hose Clamp Nut Driver (CND-1)



Comprehensive range of quality tools to suit Tridon hose clamps



# MAH/HAS

Size Range			Refills for Ezi-Load Merchandiser ELM300S 		 (PACK OF 10)	 (PACK OF 100)			
	mm	Part No.	Qty per Card	Part No.	Qty per Refill	Part No.	Part No.	Part No.	Min. Order Qty
<b>Micro Clamp</b>									
6 - 16	MAH004C	2	MAH004RF	20	MAH004P	MAH004-100	MAH004	500	
11 - 18	MAH005C	2	MAH005RF	20	MAH005P	MAH005-100	MAH005	500	
11 - 22	MAH006C	2	MAH006RF	20	MAH006P	MAH006-100	MAH006	500	
13 - 25					MAH008P		MAH008	500	
14 - 27					MAH010P		MAH010	500	
17 - 32					MAH012P		MAH012	500	
18 - 38					MAH016P		MAH016	500	
22 - 45					MAH020P		MAH020	500	
33 - 51					MAH024P		MAH024	500	
40 - 57					MAH028P		MAH028	500	
46 - 64					MAH032P		MAH032	500	
52 - 70					MAH036P		MAH036	300	
59 - 76					MAH040P		MAH040	300	
<b>Regular Clamp</b>									
11 - 22					HAS006P	HAS006-100	HAS006	500	
13 - 25	HAS008C	2	HAS008RF	15	HAS008P	HAS008-100	HAS008	500	
14 - 27	HAS010C	2	HAS010RF	15	HAS010P	HAS010-100	HAS010	500	
18 - 32	HAS012C	2	HAS012RF	15	HAS012P	HAS012-100	HAS012	500	
21 - 38	HAS016C	2	HAS016RF	15	HAS016P	HAS016-100	HAS016	500	
21 - 44	HAS020C	1			HAS020P	HAS020-100	HAS020	500	
27 - 51	HAS024C	1	HAS024RF	10	HAS024P	HAS024-100	HAS024	500	
33 - 57	HAS028C	1	HAS028RF	10	HAS028P	HAS028-100	HAS028	500	
40 - 64	HAS032C	1	HAS032RF	10	HAS032P	HAS032-100	HAS032	500	
46 - 70					HAS036P	HAS036-100	HAS036	300	
52 - 76					HAS040P		HAS040	300	
59 - 83					HAS044P		HAS044	300	
65 - 89					HAS048P		HAS048	300	
71 - 95					HAS052P		HAS052	300	
78 - 102					HAS056P		HAS056	300	
84 - 108					HAS060P		HAS060	300	
90 - 114					HAS064P		HAS064	200	
103 - 127					HAS072P		HAS072	200	
117 - 140					HAS080P		HAS080	100	
125 - 146					HAS084P		HAS084	100	
106 - 152					HAS088P		HAS088	100	
115 - 165					HAS096P		HAS096	100	
133 - 178					HAS104P		HAS104	100	
146 - 197							HAS116	10	
159 - 206							HAS120	10	
175 - 217							HAS128	10	
181 - 225							HAS136	10	
206 - 251							HAS152	10	
222 - 273							HAS164	10	
260 - 311							HAS188	10	
267 - 318							HAS192	10	
298 - 349							HAS212	10	
391 - 441							HAS270	10	

# 316



## 316 Series All 316 Stainless Steel (Acid Proof), Perforated Band

- For marine, industrial, agricultural, chemical and general purpose use
- Built to SAE J1508 Standard
- All 316 stainless steel for superior corrosion resistance
- Hexagonal head with screwdriver slot
- Low free torque for ease of installation
- Flexible band for superior sealing
- High strength for reliable sealing
- Made in Australia

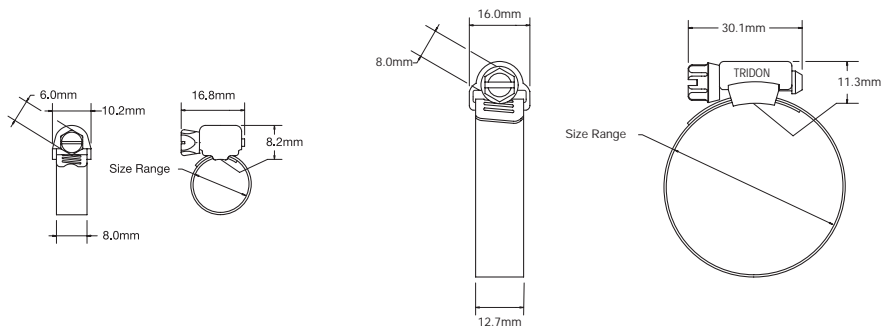

### Part No. M316-004 – M316-040

**Series** M316 (Micro Clamp)  
**Band** 316 Stainless Steel  
**Housing** 316 Stainless Steel  
**Screw** 316 Stainless Steel (Hex Head)

### Part No. H316-006 – H316-270

**Series** H316 (Regular Clamp)  
**Band** 316 Stainless Steel  
**Housing** 316 Stainless Steel  
**Screw** 316 Stainless Steel (Hex Head)

Size Range	Box		Bulk	
	mm	Part No.	Qty	Min. Order Qty
<b>Micro Clamp</b>				
6 - 16	M316-004P	10	M316-004	500
11 - 18	M316-005P	10	M316-005	500
11 - 22	M316-006P	10	M316-006	500
13 - 25	M316-008P	10	M316-008	500
14 - 27	M316-010P	10	M316-010	500
17 - 32	M316-012P	10	M316-012	500
18 - 38	M316-016P	10	M316-016	500
22 - 45	M316-020P	10	M316-020	500
33 - 51	M316-024P	10	M316-024	500
40 - 57	M316-028P	10	M316-028	500
46 - 64	M316-032P	10	M316-032	500
52 - 70	M316-036P	10	M316-036	300
59 - 76	M316-040P	10	M316-040	300
<b>Regular Clamp</b>				
11 - 22	H316-006P	10	H316-006	500
13 - 25	H316-008P	10	H316-008	500
14 - 27	H316-010P	10	H316-010	500
18 - 32	H316-012P	10	H316-012	500
21 - 38	H316-016P	10	H316-016	500
21 - 44	H316-020P	10	H316-020	500
27 - 51	H316-024P	10	H316-024	500
33 - 57	H316-028P	10	H316-028	500

Size Range	Box		Bulk	
	mm	Part No.	Qty	Min. Order Qty
40 - 64	H316-032P	10	H316-032	500
46 - 70	H316-036P	10	H316-036	300
52 - 76	H316-040P	10	H316-040	300
59 - 83	H316-044P	10	H316-044	300
65 - 89	H316-048P	10	H316-048	300
71 - 95	H316-052P	10	H316-052	300
78 - 102	H316-056P	10	H316-056	300
84 - 108	H316-060P	10	H316-060	300
90 - 114	H316-064P	10	H316-064	300
103 - 127	H316-072P	10	H316-072	200
117 - 140	H316-080P	10	H316-080	200
106 - 152	H316-088P	10	H316-088	100
115 - 165	H316-096P	10	H316-096	100
133 - 178	H316-104P	10	H316-104	100
146 - 197			H316-116	10
159 - 206			H316-120	10
175 - 217			H316-128	10
181 - 225			H316-136	10
206 - 251			H316-152	10
222 - 273			H316-164	10
260 - 311			H316-188	10
267 - 318			H316-192	10
298 - 349			H316-212	10
391 - 441			H316-270	10

# SMH/SHS

## SMH/SHS Series Part Stainless Steel, Solid Band



- Australian industry standard sizing and part numbers
- Heavy duty, non perforated band
- For automotive and general purpose use
- 430 Stainless steel band and housing
- Rolled edge and underside to prevent hose damage
- Technically advanced design for superior sealing

■ Merchandiser & Clamp Pack

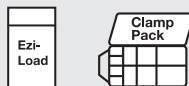

Refer to pages 35-38 for details

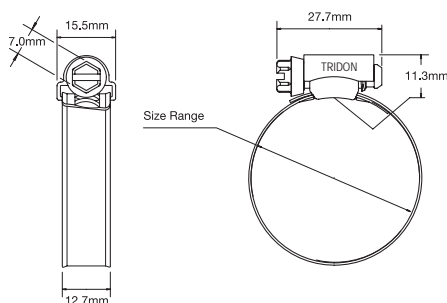
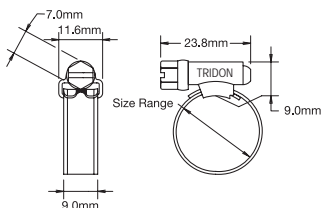

Part No. SMH004 – SMH006

<b>Series</b>	SMH (Micro Clamp)
<b>Band</b>	430 Stainless Steel
<b>Housing</b>	430 Stainless Steel
<b>Screw</b>	Carbon Steel Zinc Plated

Part No. SHS008 – SHS048

<b>Series</b>	SHS (Regular Clamp)
<b>Band</b>	430 Stainless Steel
<b>Housing</b>	430 Stainless Steel
<b>Screw</b>	Carbon Steel Zinc Plated

Size Range	Part No.
mm	Pack of 10
<b>Micro Clamp</b>	
6 - 16	SMH004P
11 - 18	SMH005P
11 - 22	SMH006P
<b>Regular Clamp</b>	
13 - 25	SHS008P
14 - 27	SHS010P
18 - 32	SHS012P
21 - 38	SHS016P
21 - 44	SHS020P
27 - 51	SHS024P
33 - 57	SHS028P
40 - 64	SHS032P
46 - 70	SHS036P
52 - 76	SHS040P
59 - 83	SHS044P
65 - 89	SHS048P

# EFI

## EFI Series Extended Tang Micro Clamps



- Tridon Micro (MH) Clamp with an extended tang covers the perforations to prevent marking on soft rubber hoses
- Ideally suited for use on fuel lines
- For EFI combination clamp pack see page 35 (Part No. FI220)
- Made in Australia

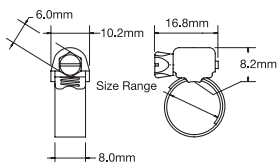

<b>Series</b>	EFI
<b>Band</b>	301 Stainless Steel
<b>Housing</b>	Carbon Steel Zinc Plated
<b>Screw</b>	Carbon Steel Zinc Plated (Hex Head)

■ Clamp Pack Part No. FI220



Refer to page 35 for details

Size Range	Part No. Boxed		Bulk Quantities		
	mm	Pack of 10	Pack of 20	Part No.	Min. Order Qty
7 - 15		EFI004P	EFI004-20	EFI004	500
9 - 17		EFI005P	EFI005-20	EFI005	500
14 - 22		EFI006P	EFI006-20	EFI006	500



# MP Series (Multi-Purpose) Part Stainless Steel, Solid Band

- For industrial, hardware, automotive and general purpose use
- 430 stainless steel band
- Heavy duty, non-perforated band and housing
- Available with removable safety collar to prevent screwdriver slip injuries
- Rolled edge and smooth underside to prevent hose damage
- Technically advanced design improves sealing capability
- Refer to page 34 for packaging styles

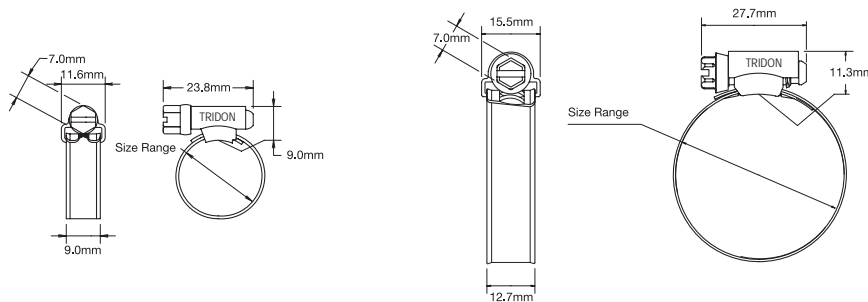

## Part No. MP000 – MP00

**Series** MP (Micro Clamp)  
**Band** 430 Stainless Steel  
**Housing** 430 Stainless Steel  
**Screw** Carbon Steel Zinc Plated

## Part No. MP0A – MP13

**Series** MP (Regular Clamp)  
**Band** 430 Stainless Steel  
**Housing** 430 Stainless Steel  
**Screw** Carbon Steel Zinc Plated

## Merchandise & Clamp Pack

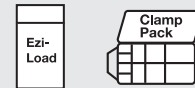

Refer to pages 35-38 for details

Size Range	Non-Collared		
	(PACK OF 10)		Min. Order Qty
mm	Part No.	Part No.	
<b>Micro Clamp</b>			
9.5 - 12	MP000P	MP000	500
11 - 16	MPM00P	MPM00	500
13 - 20	MP00P	MP00	500
<b>Regular Clamp</b>			
16 - 24	MP0AP	MP0A	500
16 - 27	MP0P	MP0	500
18 - 25	MP0XP	MP0X	500
22 - 32	MP1AP	MP1A	500
22 - 38	MP1P	MP1	500
30 - 42	MP1XP	MP1X	500
35 - 48	MP2AP	MP2A	500
35 - 53	MP2P	MP2	500
40 - 57	MP2XP	MP2X	500
52 - 70	MP3P	MP3	300
65 - 90	MP4P	MP4	300
85 - 110	MP5P	MP5	300
105 - 130	MP6P	MP6	200
130 - 155	MP7P	MP7	100
155 - 180	MP8P	MP8	100
180 - 205		MP9	10
205 - 230		MP10	10
230 - 255		MP11	10
255 - 280		MP12	10
280 - 305		MP13	10

Removable Safety Collar				
Part No.	Qty per Card	Part No.	Part No.	Min. Order Qty
<b>Micro Clamp</b>				
MP000C	2	MPC000P	MPC000	500
MPM00C	2	MPCM00P	MPCM00	500
MP00C	2	MPC00P	MPC00	500
<b>Regular Clamp</b>				
		MPC0AP	MPC0A	500
MP0C	2	MPC0P	MPC0	500
MP0XC	2	MPC0XP	MPC0X	500
MP1AC	2	MPC1AP	MPC1A	500
MP1C	2	MPC1P	MPC1	500
MP1XC	1	MPC1XP	MPC1X	500
MP2AC	1	MPC2AP	MPC2A	500
MP2C	1	MPC2P	MPC2	500
MP2XC	1	MPC2XP	MPC2X	500
		MPC3P	MPC3	300
		MPC4P	MPC4	300
		MPC5P	MPC5	300
		MPC6P	MPC6	200
		MPC7P	MPC7	100
		MPC8P	MPC8	100
			MPC9	10
			MPC10	10
			MPC11	10
			MPC12	10
			MPC13	10





## SMP Series (Multi-Purpose) All Stainless Steel, Solid Band

- For industrial, hardware, automotive and general purpose use
- All 300 series stainless steel for superior corrosion protection
- Heavy duty, non-perforated band
- Available with removable safety collar to prevent screwdriver slip injuries
- Rolled edge and smooth underside to prevent hose damage
- Technically advanced design improves sealing capability
- Refer to page 34 for packaging styles

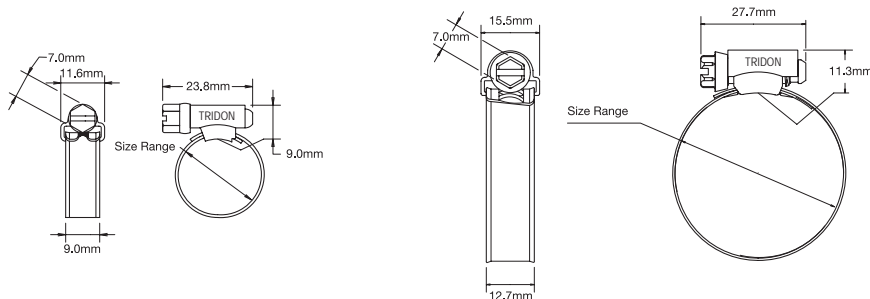

### Part No. SMP000 – SMP00

**Series** SMP (Micro Clamp)  
**Band** 304 Stainless Steel  
**Housing** 304 Stainless Steel  
**Screw** 302 Stainless Steel

### Part No. SMP0A – SMP13

**Series** SMP (Regular Clamp)  
**Band** 304 Stainless Steel  
**Housing** 301 Stainless Steel  
**Screw** 304 Stainless Steel

■ Merchandiser & Clamp Pack

Refer to pages 35-38 for details

Size Range	Non-Collared		
	(PACK OF 10)		Min. Order Qty
mm	Part No.	Part No.	
<b>Micro Clamp</b>			
9.5 - 12	SMP000P	SMP000	500
11 - 16	SMPM00P	SMPM00	500
13 - 20	SMP00P	SMP00	500
<b>Regular Clamp</b>			
16 - 24	SMP0AP	SMP0A	500
16 - 27	SMP0P	SMP0	500
22 - 32	SMP1AP	SMP1A	500
22 - 38	SMP1P	SMP1	500
30 - 42	SMP1XP	SMP1X	500
35 - 48	SMP2AP	SMP2A	500
35 - 53	SMP2P	SMP2	500
40 - 57	SMP2XP	SMP2X	500
52 - 70	SMP3P	SMP3	300
65 - 90	SMP4P	SMP4	300
85 - 110	SMP5P	SMP5	300
105 - 130	SMP6P	SMP6	200
130 - 155	SMP7P	SMP7	100
155 - 180	SMP8P	SMP8	100
180 - 205		SMP9	10
205 - 230		SMP10	10
230 - 255		SMP11	10
255 - 280		SMP12	10
280 - 305		SMP13	10

Removable Safety Collar				
Part No.	Qty per Card	Part No.	Part No.	Min. Order Qty
<b>Micro Clamp</b>				
SMP000C	2	SMPC000P	SMPC000	500
SMPM00C	2	SMPCM00P	SMPCM00	500
SMP00C	2	SMPC00P	SMPC00	500
<b>Regular Clamp</b>				
		SMPC0AP	SMPC0A	500
SMP0C	2	SMPC0P	SMPC0	500
SMP1AC	2	SMPC1AP	SMPC1A	500
SMP1C	2	SMPC1P	SMPC1	500
SMP1XC	1	SMPC1XP	SMPC1X	500
SMP2AC	1	SMPC2AP	SMPC2A	500
SMP2C	1	SMPC2P	SMPC2	500
SMP2XC	1	SMPC2XP	SMPC2X	500
		SMPC3P	SMPC3	300
		SMPC4P	SMPC4	300
		SMPC5P	SMPC5	300
		SMPC6P	SMPC6	200
		SMPC7P	SMPC7	100
		SMPC8P	SMPC8	100
			SMPC9	10
			SMPC10	10
			SMPC11	10
			SMPC12	10
			SMPC13	10

# TTBY

## TTBY Series (T-Bolt) Part Stainless Steel, Solid Band



- For heavy duty applications where large tightening forces are required
- 430 stainless steel band and bridge - carbon steel, zinc plated bolt, trunnions and collar
- Rolled edge to prevent hose damage
- Easy installation - a bolt is used for tightening not a nut which ensures full travel when using a socket
- Extra solid construction with the highest grade materials and 3 welds per band on larger sizes
- Solid trunnions with hex head bolt
- Superior sealing - tighter seals at lower bolt torques
- Made in Australia

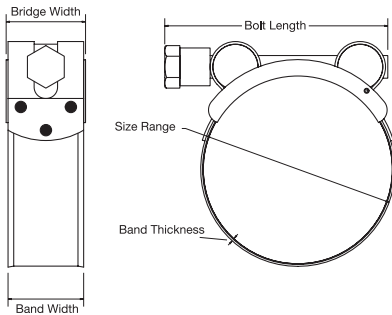

\*Dimensions - Band and Bolt

	Part No.	Band Width	Bridge Width	Band Thickness	Bolt	Bolt Length
1	TTBY17-19 to TTBY27-29	16mm	18mm	0.7mm	M5	40mm
2	TTBY29-31 to TTBY62-65	20mm	22mm	0.7mm	M6	55mm
3	TTBY64-67 to TTBY126-134	24mm	27mm	1.0mm	M8	80mm
4	TTBY131-139 to TTBY292-304	26mm	29mm	1.2mm	M10	105mm

■ Merchandiser  
Part No. TBM71



Refer to page 39 for details

<b>Series</b>	TTBY (T-Bolt Clamp)
<b>Band</b>	430 Stainless Steel
<b>Bridge</b>	430 Stainless Steel
<b>Bolt</b>	High Tensile Carbon Steel Zinc Plated
<b>Trunnion</b>	Carbon Steel Zinc Plated
<b>Collar</b>	Carbon Steel Zinc Plated

Dimensions*	Size Range	Box	
	mm	Part No.	Qty
1	17 - 19	TTBY17-19P	10
	18 - 20	TTBY18-20P	10
	20 - 22	TTBY20-22P	10
	21 - 23	TTBY21-23P	10
	23 - 25	TTBY23-25P	10
	24 - 26	TTBY24-26P	10
	26 - 28	TTBY26-28P	10
	27 - 29	TTBY27-29P	10
2	29 - 31	TTBY29-31P	10
	30 - 33	TTBY30-33P	10
	32 - 35	TTBY32-35P	10
	34 - 37	TTBY34-37P	10
	36 - 39	TTBY36-39P	10
	38 - 41	TTBY38-41P	10
	40 - 43	TTBY40-43P	10
	42 - 45	TTBY42-45P	10
	44 - 47	TTBY44-47P	10
	46 - 49	TTBY46-49P	10
	48 - 51	TTBY48-51P	10
	50 - 53	TTBY50-53P	10
52 - 55	TTBY52-55P	10	

Dimensions*	Size Range	Box	
	mm	Part No.	Qty
2	54 - 57	TTBY54-57P	10
	56 - 59	TTBY56-59P	10
	58 - 61	TTBY58-61P	10
	60 - 63	TTBY60-63P	10
	62 - 65	TTBY62-65P	10
	3	64 - 67	TTBY64-67P
66 - 70		TTBY66-70P	10
68 - 73		TTBY68-73P	10
71 - 76		TTBY71-76P	10
74 - 79		TTBY74-79P	10
77 - 82		TTBY77-82P	10
80 - 85		TTBY80-85P	10
83 - 88		TTBY83-88P	10
86 - 91		TTBY86-91P	10
89 - 94		TTBY89-94P	10
92 - 97		TTBY92-97P	10
95 - 100		TTBY95-100P	10
98 - 103		TTBY98-103P	10
101 - 107		TTBY101-107P	10

Dimensions*	Size Range	Box	
	mm	Part No.	Qty
3	104 - 112	TTBY104-112P	10
	108 - 116	TTBY108-116P	10
	113 - 121	TTBY113-121P	10
	117 - 125	TTBY117-125P	10
	122 - 130	TTBY122-130P	10
	126 - 134	TTBY126-134P	10
	131 - 139	TTBY131-139P	10
4	140 - 148	TTBY140-148P	10
	149 - 161	TTBY149-161P	5
	162 - 174	TTBY162-174P	5
	175 - 187	TTBY175-187P	5
	188 - 200	TTBY188-200P	5
	201 - 213	TTBY201-213P	5
	214 - 226	TTBY214-226P	5
	227 - 239	TTBY227-239P	5
	240 - 252	TTBY240-252P	5
	253 - 265	TTBY253-265P	5
	266 - 278	TTBY266-278P	5
	279 - 291	TTBY279-291P	5
	292 - 304	TTBY292-304P	5

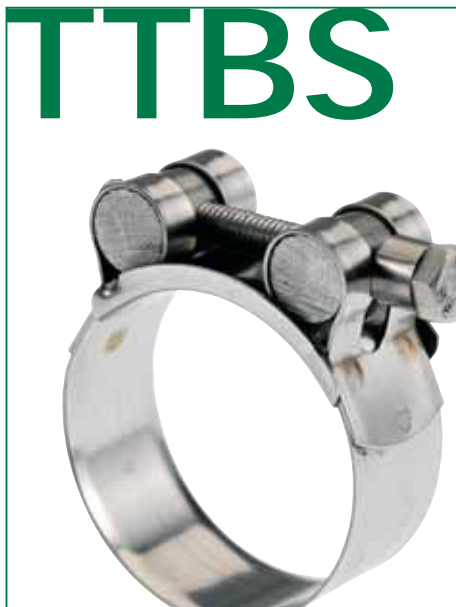

# TTBS Series (T-Bolt)

## All Stainless Steel, Solid Band

- For heavy duty applications where large tightening forces are required
- All 300 series stainless steel for corrosion protection
- Rolled edge to prevent hose damage
- Easy installation - a bolt is used for tightening not a nut which ensures full travel when using a socket
- Extra solid construction with the highest grade materials and 3 welds per band on larger sizes
- Solid trunnions with hex head bolt
- Superior sealing - tighter seals at lower bolt torques
- Made in Australia

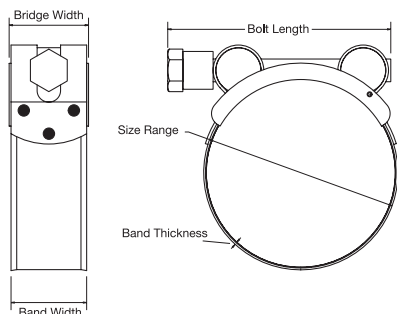

<b>Series</b>	TTBS (T-Bolt Clamp)
<b>Band</b>	304 Stainless Steel
<b>Bridge</b>	304 Stainless Steel
<b>Bolt</b>	High Tensile 316 Stainless Steel
<b>Trunnion</b>	300 Series Stainless
<b>Collar</b>	300 Series Stainless

\*Dimensions – Band and Bolt

	Part No.	Band Width	Bridge Width	Band Thickness	Bolt	Bolt Length
1	TTBS17-19 to TTBS27-29	16mm	18mm	0.7mm	M5	40mm
2	TTBS29-31 to TTBS62-65	20mm	22mm	0.7mm	M6	55mm
3	TTBS64-67 to TTBS126-134	24mm	27mm	1.0mm	M8	80mm
4	TTBS131-139 to TTBS292-304	26mm	29mm	1.2mm	M10	105mm

■ Merchandiser  
Part No. TBMSS71



Refer to page 39 for details

Dimensions*	Size Range	Box	
	mm	Part No.	Qty
1	17 - 19	TTBS17-19P	10
	18 - 20	TTBS18-20P	10
	20 - 22	TTBS20-22P	10
	21 - 23	TTBS21-23P	10
	23 - 25	TTBS23-25P	10
	24 - 26	TTBS24-26P	10
	26 - 28	TTBS26-28P	10
	27 - 29	TTBS27-29P	10
2	29 - 31	TTBS29-31P	10
	30 - 33	TTBS30-33P	10
	32 - 35	TTBS32-35P	10
	34 - 37	TTBS34-37P	10
	36 - 39	TTBS36-39P	10
	38 - 41	TTBS38-41P	10
	40 - 43	TTBS40-43P	10
	42 - 45	TTBS42-45P	10
	44 - 47	TTBS44-47P	10
	46 - 49	TTBS46-49P	10
	48 - 51	TTBS48-51P	10
	50 - 53	TTBS50-53P	10
	52 - 55	TTBS52-55P	10

Dimensions*	Size Range	Box	
	mm	Part No.	Qty
2	54 - 57	TTBS54-57P	10
	56 - 59	TTBS56-59P	10
	58 - 61	TTBS58-61P	10
	60 - 63	TTBS60-63P	10
	62 - 65	TTBS62-65P	10
	3	64 - 67	TTBS64-67P
66 - 70		TTBS66-70P	10
68 - 73		TTBS68-73P	10
71 - 76		TTBS71-76P	10
74 - 79		TTBS74-79P	10
77 - 82		TTBS77-82P	10
80 - 85		TTBS80-85P	10
83 - 88		TTBS83-88P	10
86 - 91		TTBS86-91P	10
89 - 94		TTBS89-94P	10
92 - 97		TTBS92-97P	10
95 - 100		TTBS95-100P	10
98 - 103		TTBS98-103P	10
101 - 107		TTBS101-107P	10

Dimensions*	Size Range	Box	
	mm	Part No.	Qty
3	104 - 112	TTBS104-112P	10
	108 - 116	TTBS108-116P	10
	113 - 121	TTBS113-121P	10
	117 - 125	TTBS117-125P	10
	122 - 130	TTBS122-130P	10
	126 - 134	TTBS126-134P	10
	131 - 139	TTBS131-139P	10
	140 - 148	TTBS140-148P	10
4	149 - 161	TTBS149-161P	5
	162 - 174	TTBS162-174P	5
	175 - 187	TTBS175-187P	5
	188 - 200	TTBS188-200P	5
	201 - 213	TTBS201-213P	5
	214 - 226	TTBS214-226P	5
	227 - 239	TTBS227-239P	5
	240 - 252	TTBS240-252P	5
	253 - 265	TTBS253-265P	5
	266 - 278	TTBS266-278P	5
	279 - 291	TTBS279-291P	5
	292 - 304	TTBS292-304P	5



## TTBU Series T-Bolt Ultimate Clamps

- For performance automotive and general applications including turbo charging, intercooler, air intake, radiator and exhaust pipes
- Band size ideal for performance automotive applications
- Clamps individually packed in popular sizes
- 430 stainless steel band and bridge, carbon steel, zinc plated bolt, trunnions and collar
- Easy installation – a bolt is used for tightening not a nut which ensures full travel when using a socket
- Made in Australia

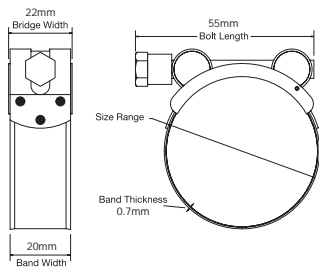

<b>Series</b>	TTBU
<b>Band</b>	430 Stainless Steel
<b>Bridge</b>	430 Stainless Steel
<b>Bolt</b>	High Tensile Carbon Steel Zinc Plated
<b>Trunnion</b>	Carbon Steel Zinc Plated
<b>Collar</b>	Carbon Steel Zinc Plated

Size Range	Part No.	Qty
mm	Carded	
29 - 31	TTBU29-31C	1
32 - 35	TTBU32-35C	1
36 - 39	TTBU36-39C	1
40 - 43	TTBU40-43C	1
44 - 47	TTBU44-47C	1
48 - 51	TTBU48-51C	1
52 - 55	TTBU52-55C	1
56 - 59	TTBU56-59C	1

Size Range	Part No.	Qty
mm	Carded	
60 - 63	TTBU60-63C	1
64 - 67	TTBU64-67C	1
66 - 70	TTBU66-70C	1
68 - 73	TTBU68-73C	1
71 - 76	TTBU71-76C	1
74 - 79	TTBU74-79C	1
77 - 82	TTBU77-82C	1
80 - 85	TTBU80-85C	1



## TS Series Tri-Strength Clamps

- For heavy duty use such as industrial, agricultural and truck applications
- All 304 stainless steel for corrosion resistance
- Perforated band
- Band Width: 16mm, Band Thickness: 0.65mm

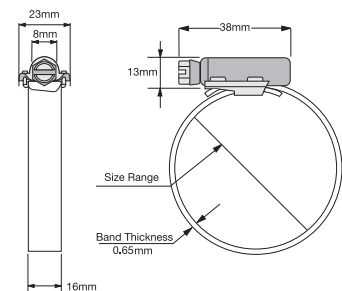

<b>Series</b>	TS
<b>Band</b>	304 Stainless Steel
<b>Housing</b>	304 Stainless Steel
<b>Screw</b>	304 Stainless Steel

Size Range	Part No.	Bulk Quantities	
mm	Pack of 10	Part No.	Min. Order Qty
27 - 51	TS51P	TS51	500
33 - 57	TS57P	TS57	500
40 - 64	TS64P	TS64	250
59 - 83	TS83P	TS83	250
71 - 95	TS95P	TS95	250
78 - 102	TS102P	TS102	100

Size Range	Part No.	Bulk Quantities	
mm	Pack of 10	Part No.	Min. Order Qty
91 - 114	TS114P	TS114	100
102 - 127	TS127P	TS127	100
143 - 216	TS216P	TS216	50
181 - 254	TS254P	TS254	50
238 - 311	TS311P	TS311	50





## QR Series Quick Release Clamps

- Unique quick-release design between the one piece housing and band allows for quick and easy installation in restricted or difficult areas
- Ideal for applications where clamps must be open for installation
- Used extensively in the telecommunications industry on cable installations where open air application demands durability
- Can be joined together to achieve greater dimensions

Size Range mm	Part No.	Bulk Quantities	
	Pack of 10	Part No.	Min. Order Qty
23 - 70	QR-036P	QR-036	100
42 - 90	QR-048P	QR-048	100
51 - 130	QR-072P	QR-072	100
51 - 152	QR-088P	QR-088	100
51 - 176	QR-104P	QR-104	100
60 - 215	QR-128P	QR-128	100
60 - 254	QR-152P	QR-152	100
60 - 311	QR-188P	QR-188	100

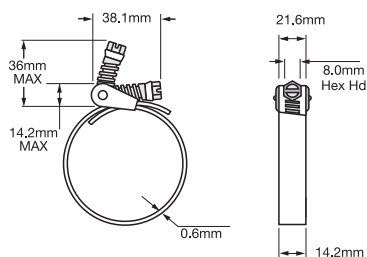

<b>Series</b>	QR
<b>Band</b>	304 Stainless Steel
<b>Housing</b>	304 Stainless Steel
<b>Screw</b>	410 Stainless Steel (Hex Head)
<b>Bridge</b>	410 Stainless Steel

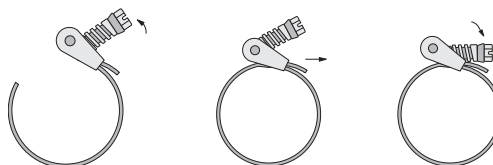

1. Loop disengaged clamp around object
2. Slip band through housing
3. Snap screw down and tighten



## CV Series CV Boot Clamps, 430 Stainless Steel

- Used over CV boots to prevent grease leakage and keep shafts dust free
- Several lengths available to suit both ends of rubber boot
- Refer to page 32 for details on Banding Tool and CV Boot Clamp Installer

Length mm	Width mm	Part No.	Bulk Quantities	
		Pack of 20	Part No.	Min. Order Qty
130	6.3	CV130-20	CV2-63130	500
280	6.3	CV280-20	CV280	500
360	6.3	CV360-20	CV360	500
480	6.3	CV480-20	CV480	500
680	6.3	CV680-20	CV680	500

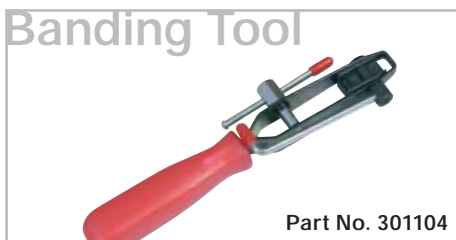

■ CV Boot Combo Kit  
Part No. CVCP10

Refer to page 34 for details



## UB Series Uni Band, All Stainless Steel

- Universal clamping system for industrial applications
- All 301 stainless steel for maximum tensile strength, superior durability and corrosion resistance
- Heavy duty, stainless steel band provided in 30 metre lengths, 4 widths and 2 thicknesses with buckle to suit
- Variable diameter covers a wide range of shapes and sizes to suit all types of applications
- Common applications include large diameter hose clamping, power poles and cables, clamping around pipes or tanks, concrete piping, cable bundling etc.
- Available with handy pastic reel for easier handling
- Uniband Clamping Tool (see page 32) enables correct tensioning of band and provides easy cut-off facility

### Handy Plastic Reel

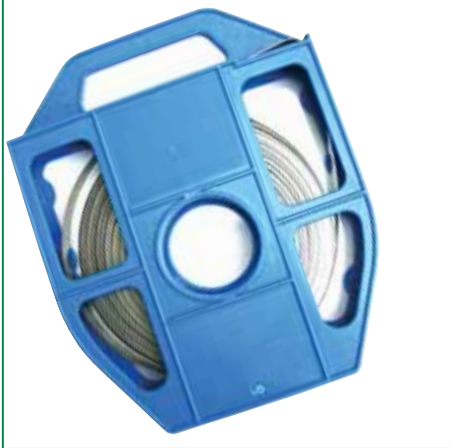

Uni Band				
Size Range			Part No.	
Width	Thickness	Length	for Roll	for Plastic Reel
	mm			
9.5mm / 3/8"	0.65	30	UBB006-30P	UBB006-30R
12.7mm / 1/2"	0.65	30	UBB008-30P	UBB008-30R
15.9mm / 5/8"	0.75	30	UBB010-30P	UBB010-30R
19.0mm / 3/4"	0.75	30	UBB012-30P	UBB012-30R



Stainless Steel Buckle



Stainless Steel Folding Clip



Stainless Steel Screw Buckle

### Clamping Tool



Accessories			
Size Range	Buckle	Folding Clip	Screw Buckle
	Part No. Pack of 100	Part No. Pack of 100	Part No. Pack of 100
9.5mm / 3/8"	UBL006/100		
12.7mm / 1/2"	UBL008/100	UBF008/100	
15.9mm / 5/8"	UBL010/100	UBF010/100	UBS010/100
19.0mm / 3/4"	UBL012/100	UBF012/100	UBS012/100



## NA Series Nut & Bolt Clamps

- Ideal for use in confined spaces
- Fixed nut for ease of tightening
- OEM applications
- Rolled edge to prevent hose damage
- 6mm hexagonal head with screwdriver slot, 9mm band width

Size Range	Part No.	Bulk Quantities	
mm	Pack of 10	Part No.	Min. Order Qty
7 - 9	NA0709P	NA0709	100
8 - 10	NA0810P	NA0810	100
9 - 11	NA0911P	NA0911	100
12 - 14	NA1214P	NA1214	100
13 - 15	NA1315P	NA1315	100
14 - 16	NA1416P	NA1416	100

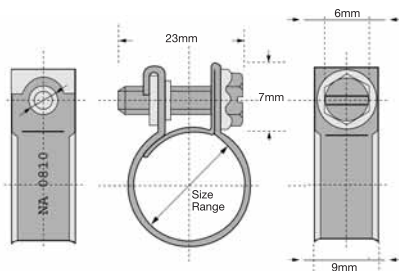

Series NA

Band Aluzinc or Carbon Steel Zinc Plated  
 Nut Carbon Steel Zinc Plated  
 Bolt Carbon Steel Zinc Plated

■ Clamp Pack Part No. FI220

Refer to page 35 for details



## TEC Series Double Ear Clamps

- A simple and economical solution for many difficult tightening and sealing problems
- Zinc plated steel
- Disturbing clasps, screws and band ends can be avoided by mounting an ear clamp
- Mounting and dismounting is simple, the ear clamp is easily passed over the material that is to be mounted and is then squeezed together by top join pincers (see page 31)
- Suitable for use on compressed air, gas and liquid lines

Size Range	Part No.	Bulk Quantities	
mm	Pack of 20	Part No.	Min. Qty
4 - 6	TEC46-20	TEC46	100
5 - 7	TEC57-20	TEC57	100
7 - 9	TEC79-20	TEC79	100
9 - 11	TEC911-20	TEC911	100
11 - 13	TEC1113-20	TEC1113	100
13 - 15	TEC1315-20	TEC1315	100
15 - 17	TEC1517-20	TEC1517	100
15 - 18	TEC1518-20	TEC1518	100
17 - 20	TEC1720-20	TEC1720	100
20 - 23	TEC2023-20	TEC2023	100
22 - 25	TEC2225-20	TEC2225	100
23 - 25	TEC2325-20	TEC2325	100
25 - 28	TEC2528-20	TEC2528	100
28 - 31	TEC2831-20	TEC2831	100
31 - 34	TEC3134-20	TEC3134	100
34 - 37	TEC3437-20	TEC3437	100
37 - 40	TEC3740-20	TEC3740	100
40 - 43	TEC4043-20	TEC4043	100
43 - 46	TEC4346-20	TEC4346	100



■ Clamp Packs  
 Part No. TEC300 & FI220



Refer to page 35 for details

### How to use a Double Ear Clamp

One ear should be closed all the way. When the second ear is closed, the first ear will open slightly. This creates a spring-like action which holds against pressure, vibration and hose shrinking caused by temperature changes or ageing.

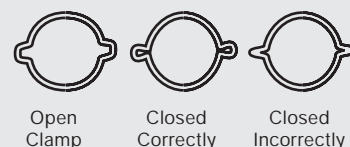

# CAI



## CAI Series Vinyl Coated Clamps

- For use in holding pipes, hoses, tubing, cables, wires etc
- Aluminium chromate-coated mild steel
- Ideal for automotive, plumbing, construction, industrial, marine, electrical, power equipment, lawn and garden applications

Size mm	Bulk Quantities		
	Part No.	Part No.	Min. Order Qty
6	CAI0250P	CAI0250	500
8	CAI0312P	CAI0312	500
10	CAI0375P	CAI0375	500
13	CAI0500P	CAI0500	500
14	CAI0562P	CAI0562	500
16	CAI0625P	CAI0625	500
19	CAI0750P	CAI0750	500
25	CAI1000P	CAI1000	500
32	CAI1250P	CAI1250	300

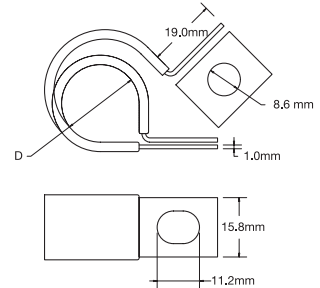

# TRLC



## TRLC Series Rubber-Lined Clamps

- For pipes, cables, groups of cables, hoses, etc
- The clip is made from zinc plated carbon steel or 304 stainless steel, the inside and edges of which are protected by a rubber lining
- On closing the band, the clamp adapts itself easily to the dimensions it is to fit
- Impacts and vibrations are absorbed by the rubber lining
- Great resistance to water, wear, fluctuations in temperature and ageing
- Used in the automotive industry, mechanical and apparatus construction, electrical, hydraulic and pneumatic engineering, process industries, shipbuilding, refrigeration and freezing plants etc

**Series** TRLC

**Rubber** E.P.D.M. Rubber

**Band** Carbon Steel Zinc Plated  
or 304 Stainless Steel

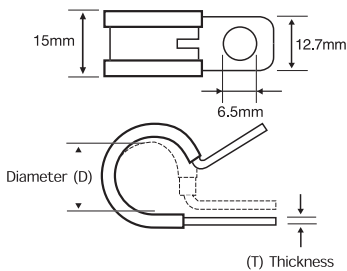

■ **Clamp Pack**  
Part No. TRLC90K



Refer to page 35 for details

Size mm		Boxed Part No. Pack of 10	
(D)	(T)	Carbon Steel	All Stainless
3.2	0.8	TRLC3P	
4.8	0.8	TRLC5P	
6.4	0.8	TRLC6P	TRLCSS6P
7.9	0.8	TRLC8P	TRLCSS8P
9.5	0.8	TRLC10P	TRLCSS10P
11.1	0.8	TRLC11P	
12.7	1.0	TRLC13P	TRLCSS13P
14.3	1.0	TRLC14P	
15.9	1.0	TRLC16P	TRLCSS16P
17.5	1.0	TRLC18P	TRLCSS18P
19.0	1.0	TRLC19P	TRLCSS19P
20.6	1.0	TRLC21P	
22.2	1.0	TRLC22P	TRLCSS22P
25.4	1.0	TRLC25P	TRLCSS25P
27.0	1.3	TRLC27P	TRLCSS27P
28.6	1.3	TRLC29P	

Size mm		Boxed Part No. Pack of 10	
(D)	(T)	Carbon Steel	All Stainless
30.2	1.3	TRLC30P	TRLCSS30P
31.8	1.3	TRLC32P	
33.3	1.3	TRLC33P	
34.9	1.3	TRLC35P	TRLCSS35P
36.5	1.3	TRLC37P	
38.1	1.3	TRLC38P	
39.0	1.3	TRLC39P	
42.0	1.3	TRLC42P	TRLCSS42P
44.5	1.3	TRLC44P	
47.0	1.3	TRLC47P	
51.8	1.3	TRLC51P	
54.0	1.3	TRLC54P	
60.0	1.3	TRLC60P	
64.0	1.3	TRLC64P	
74.0	1.3	TRLC74P	
110.0	1.3	TRLC110P	





## SL Series Spring Lock Clamps

- Quick assembly, re-useable for low pressure sealing applications
- Interlocking, one piece band
- Available in 6mm & 8mm band widths
- Mechanical lock, non-welded
- For ease of installation use pinching pliers
- Stainless AISI 201

Size			Part No.	Bulk Quantities	
Open mm	Closed mm	Band Width (W) mm	Pack of 10	Part No.	Min. Order Qty
11.5	9	6	SL6090P	SL6090	100
12.5	10	6	SL6100P	SL6100	100
19	16	8	SL8160P	SL8160	100
22.5	19.5	8	SL8195P	SL8195	100
24	21	8	SL8210P	SL8210	100
29	26	8	SL8260P	SL8260	100

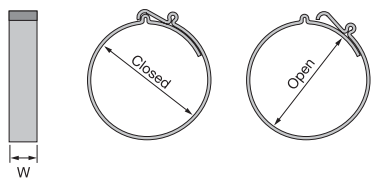

## CTC Series Constant Tension Band Clamps

- For radiator and vacuum hoses in cars and light trucks
- Expands and contracts maintaining seal around hose
- Heat treated chrome vanadium steel with delta tone finish
- Size range from 6mm to 51mm
- For detailed specifications, technical drawings, order quantities and complete size range, please contact Tridon Customer Service



## DW Series Double Wire Clamps

- Suitable for low pressure, flexible hose applications
- Expands and contracts maintaining seal around hose
- Three different colours - gold, silver, black
- Size range from 6.6mm to 75mm
- For detailed specifications, technical drawings, order quantities and complete size range, please contact Tridon Customer Service

## Cable Ties

Tridon cable ties are available in assorted materials, colours and sizes to suit all types of applications.

Nylon cable ties are manufactured from virgin nylon 6/6 and are UL94V-2 flammable rated. Black cable ties have been U.V. stabilised to resist material breakdown and increase service life.

Stainless steel cable ties are manufactured from 304 grade stainless steel with a unique ball locking mechanism.

All cable ties are packaged in handy retail packs or trade quantities. Merchandisers are also available to display popular cable ties.

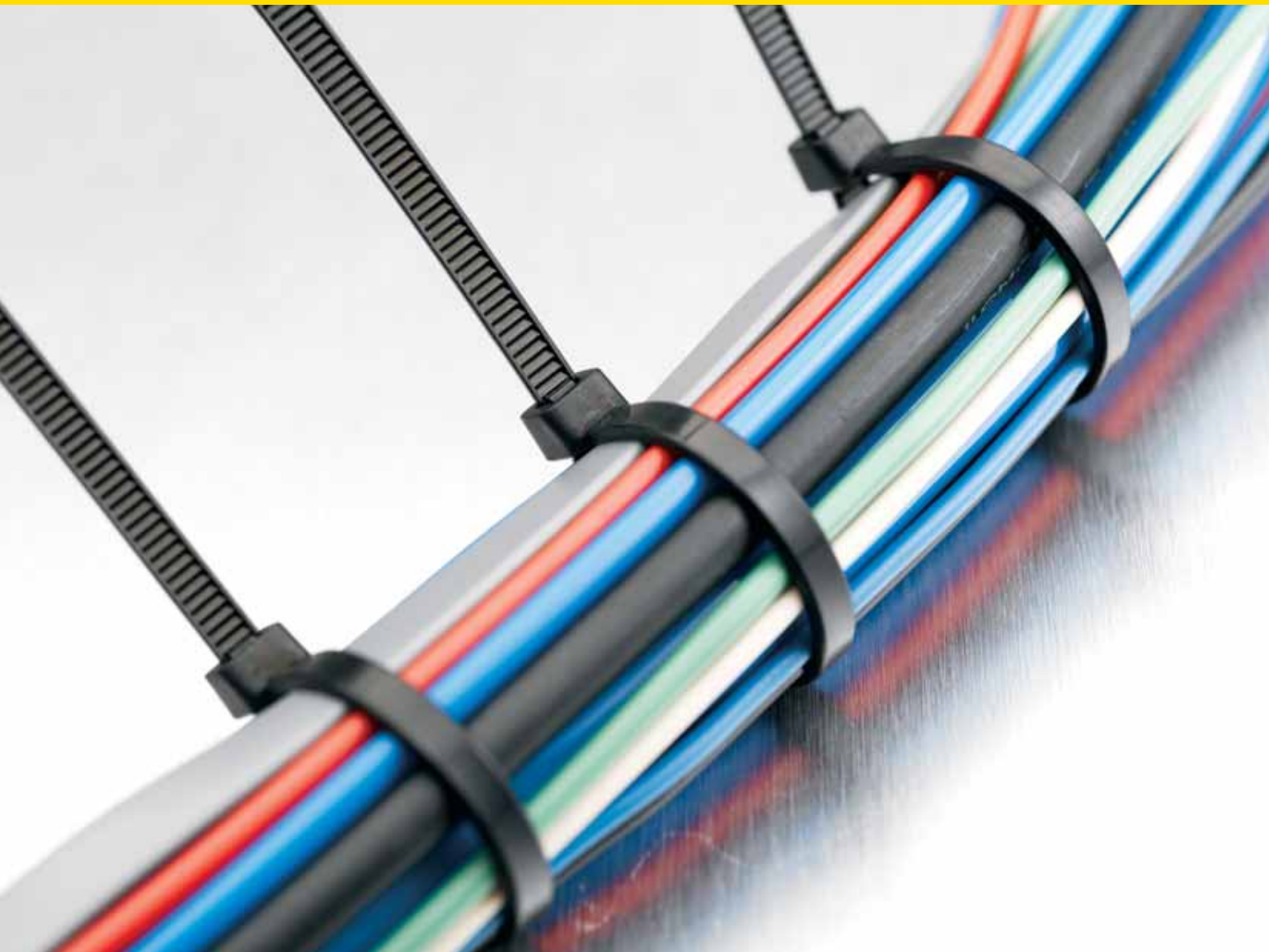

# NT



## Cable Tie Retail Packs

### Natural

Width	Length	Retail Packs		Bulk Quantities	
		Part No.	Qty	Part No.	Qty
3	60	CT603NTCD	100	CTB603NT	500
3	100	CT103NTCD	100	CTB103NT	500
3	100			CTW103NT	1000
4	150	CT154NTCD	100	CTB154NT	500
4	200	CT204NTCD	100	CTB204NT	500
4	250	CT254NTCD	100		
4	300	CT304NTCD	100		
5	200	CT205NTCD	100	CTB205NT	500
5	250	CT255NTCD	100	CTB255NT	500
5	300	CT305NTCD	100	CTB305NT	500
5	400	CT405NTCD	25		
5	450	CT455NTCD	25		
8	200	CT208NTCD	25		
8	250	CT258NTCD	25		
8	300	CT308NTCD	25		
8	350	CT358NTCD	25		
8	400	CT408NTCD	25		
9	550	CT559NTCD	25		
9	750	CT759NTCD	25		
9	1000	CT1009NTCD	25	CTB1009NT	250
12	650	CT6512NTCD	25		

# BK



### Black (U.V. Stabilised)

Width	Length	Retail Packs		Bulk Quantities	
		Part No.	Qty	Part No.	Qty
3	60	CT603BKCD	100	CTB603BK	500
3	100	CT103BKCD	100	CTB103BK	500
4	150	CT154BKCD	100	CTB154BK	500
4	200	CT204BKCD	100	CTB204BK	500
4	250	CT254BKCD	100		
4	300	CT304BKCD	100		
5	200	CT205BKCD	100	CTB205BK	500
5	250	CT255BKCD	100	CTB255BK	500
5	300	CT305BKCD	100	CTB305BK	500
5	400	CT405BKCD	25	CTB405BK	500
5	400	CT405BKCD-100	100		
5	450	CT455BKCD	25	CTB455BK	500
5	450	CT455BKCD-100	100		
8	200	CT208BKCD	25		
8	250	CT258BKCD	25		
8	300	CT308BKCD	25		
8	350	CT358BKCD	25		
8	400	CT408BKCD	25	CTB408BK	500
8	400	CT408BKCD-100	100		
9	550	CT559BKCD	25		
9	750	CT759BKCD	25		
9	1000	CT1009BKCD	25		
12	650	CT6512BKCD	25		

# Cable Tie Assorted Packs

## Natural



Part No.	Width mm	Length mm	Qty	Total Pack Qty
CTP10	3	100	25	75
	5	120	25	
	5	200	25	
CTP20	3	100	25	40
	3	150	8	
	4	200	7	
CTP21	3	100	300	300
CTP23	3	200	200	200

## Black (U.V. Stabilised)



Part No.	Width mm	Length mm	Qty	Total Pack Qty
CTP11	3	80	100	250
	3	120	100	
	4	200	50	
CTP13	3	100	50	150
	5	120	50	
	5	200	50	
CTP22	3	100	300	300
CTP24	3	200	200	200

## Assorted Colours



Part No.	Width mm	Length mm	Qty	Total Pack Qty
CTP03	3	100	1000	1000
CTP07	3	100	300	500
	3	150	200	
CTP08	3	100	300	500
	3	200	200	
CTP18	4	150	75	75



# COMBO



## Cable Tie Combo Pack

- Contains popular sizes of black (U.V. Stabilised) cable ties in one handy carry pack
- 1000 cable ties in total

Contents		Part No. CTCP10	
Width mm	Length mm	Part No.	Total Pack Qty
3	100	CT103BKCD	2 x Packs of 100
4	150	CT154BKCD	2 x Packs of 100
5	200	CT205BKCD	4 x Packs of 100
5	300	CT305BKCD	2 x Packs of 100

# SS



## SS Series 304 Stainless Steel Cable Ties

- Stainless steel cable ties with a unique ball locking mechanism
- Quick and easy to install by hand or with cable tie cutter (Part No. CTC2065), refer to page 31 for details
- Can be used in environmentally harsh conditions including indoors, outdoors and underground

Width mm	Length mm	Part No.	Qty
4.5	127	CTSS124	50
4.5	152	CTSS154	50
4.5	201	CTSS204	50
4.5	266	CTSS264	50
4.5	300	CTSS304	50
4.5	362	CTSS364	50
4.5	521	CTSS524	50
8.0	127	CTSS128	50
8.0	152	CTSS158	50
8.0	201	CTSS208	50
8.0	266	CTSS268	50
8.0	300	CTSS308	50
8.0	362	CTSS368	50
8.0	521	CTSS528	50

## Cable Tie Cutter



Part No. CTC2065

### n Merchandisers

Rotary Merchandiser

Part No. CTM01

Dimensions: 640mm (w) x 1800mm (h)

Refer to page 40 for details



Counter Merchandiser

Part No. CTM02

Dimensions: 380mm (w) x 550mm (h) x 200mm (d)





## Tools and Accessories

Tridon Australia offers a comprehensive range of high quality tools and accessories for easy removal and installation of hose clamps.

With over 20 tools and accessories to choose from there will be one to suit most applications.





## Torque Screwdriver

Part No: CTD-1 (Short) & CTD-2 (Long) Driver Head

- Applies torque by a twist of the dial
- Torque meter window clearly indicates torque measurement
- Locking torque setting for continuous use without resetting
- Includes 6mm, 7mm and 8mm sockets
- Packed in protective blow case
- For use on all Tridon worm drive hose clamps

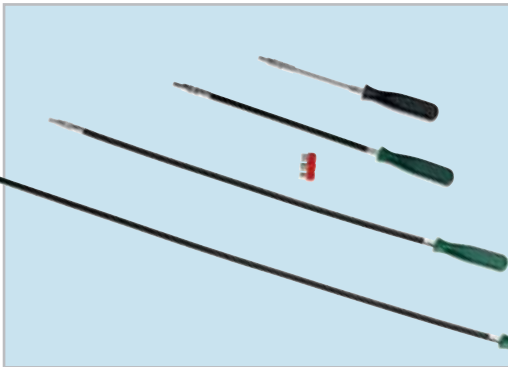

## Hose Clamp Nut Driver

Part No: CND-1 (150mm), CND-2 (300mm),  
CND-3 (600mm), CND-4 (900mm)

- For easy installation and removal of most hose clamps
- Flexible shaft allows access to difficult locations
- High torque grip for positive tensioning of clamps
- Includes 6mm, 7mm and 8mm sockets
- For use on all Tridon worm drive hose clamps



## Universal Hose Clamp Plier Set – 2 piece

Part No: 301171

- Set includes cross slotted jaw plier and wide, flat band hose clamp jaw plier to service most hose clamps in ring type or flat band type
- Both pliers feature ratchet lock mechanism holding the clamp in an open position for easy installation and removal
- For use with CTC Series clamps (see page 21)



## Hose Clamp Plier - Flat Band 45°

Part No: 301030

- Designed for installation and removal of flat band style hose clamps (see DW clamps page 21)
- Locking mechanism holds clamp in position
- Heat treated alloy steel
- 45° offset head enables easier access in restricted areas
- 215mm overall length



## Hose Clamp Plier - Flexible

Part No: 301172

- Ideal when replacing fuel, oil and water hoses
- 530mm (21") flexible extension is ideal for working in hidden areas
- Self-locking plier holds the ring for easy removal
- For use with CTC & DW Series clamps (see page 21)



## Multi-Purpose Hose & Wire Pliers – 2 piece

Part No: 301170

- Ideal for disassembly of vacuum hose, radiator hose, fuel hose, spark plug lead wire etc.
- Capacity: 6mm - 19mm
- Length: 215mm - 255mm



## Hose Clamp Plier – Flat Band Straight

Part No: 301031

- Designed for installation and removal of flat band style hose clamps such as CTC Series clamps (see page 21)
- Durable heat treated alloy steel
- Locking mechanism holds the clamp in position
- 210mm overall length



## Radiator Hose Pliers

Part No: 301029

- Slip joint operation
- 285mm overall length
- Features "shark tooth" security grip
- 3 positive positions
- Removes radiator or heater hose promptly and safely



## Pincing Pliers

Part No: SCP-1 Standard Top Join Pincer (left)  
FCP-1 Side and Top Join Pincer (right)

- Used for TEC Series (Double Ear Clamp) see page 19

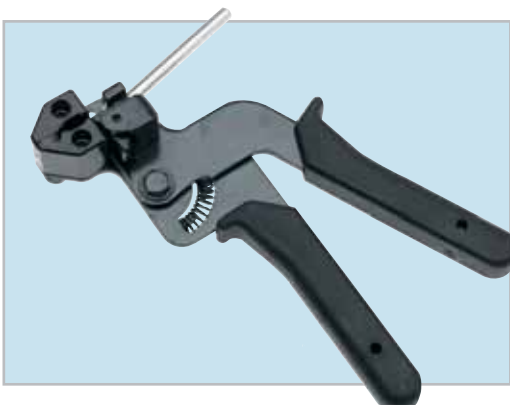

## Cable Tie Cutter

Part No: CTC2065

- Used for tensioning and cutting SS Series stainless steel cable ties (see page 28)
- Includes cut-off lever

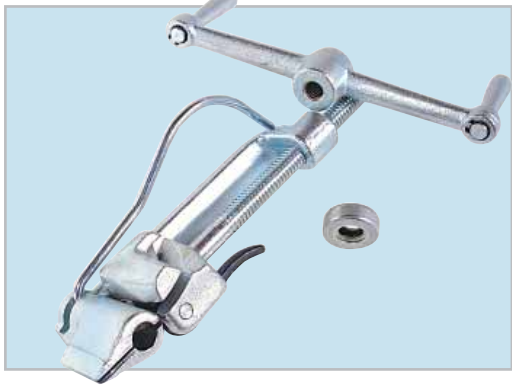

## Uniband Clamping Tool

Part No: CT1

- Used for UB Series (Uni Band) refer to page 18
- Enables correct tensioning of band and provides easy cut-off facility



## Banding Tool with Cutter

Part No: 301104

- In-built cutter provides for correct and economical paring
- Designed for use on CV joints with band type, boot clamps (see page 17)
- Makes installation easy

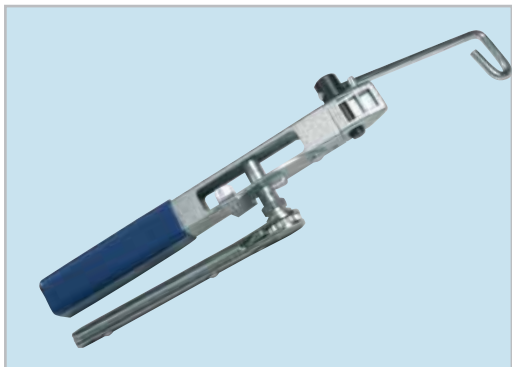

## CV Boot Clamp Installer

Part No: 311288

- Installs low-profile clamps used to hold CV boots on most FWD vehicles
- Ratchet action and inbuilt cutter
- Fasten the clamp swiftly and securely
- For use with CV Series clamps (see page 17)

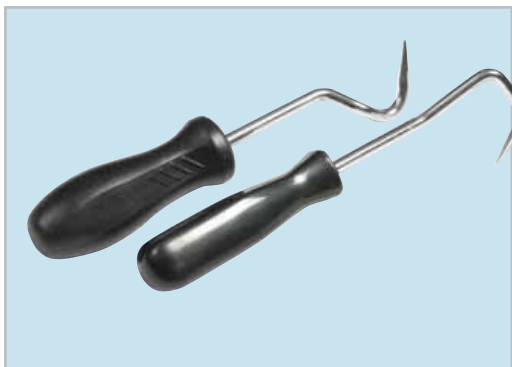

## Hose Remover Set – 2 piece

Part No: 301151

- Hook and pick radiator hose removal set
- Removes hoses after the hose clamp is released
- Special hook design for easy removal of hoses even in confined spaces
- Durable large handles provide a firm grip



## Hose Removal Pliers

Part No: 301173

- For easy removal of 4mm to 13mm vacuum and fuel hoses





## Packaging and Merchandising

Tridon hose clamps are available in a variety of packaging styles to suit retail or trade requirements.

Carded and boxed clamps are available in attractive, colour coded packaging for easy identification. Bulk quantities also available.

Tridon offers the largest and most innovative range of convenient merchandisers and workshop packs to store and display popular Tridon clamps.



# Boxed Clamp



- Available in a variety of conveniently sized packs of 10 or 20
- Bulk quantities also available
- Packaging is colour coded to enable quick and easy identification
- All boxes are clearly marked with part number and barcode



# Carded Clamp



- Handy carded packaging, ideal for use in retail and self-serve sales areas
- Colour coded backing cards make product selection easy
- Clamps secured behind blister to enable identification without opening the pack
- Available in popular sizes in full stainless or part stainless steel hose clamps
- All cards individually barcoded
- Card dimensions 90mm (w) x 140mm (h)
- Supplied in outers of 10 cards



## T-Bolt Ultimate

- For applications where superior sealing is required
- Individually packed in 16 popular sizes
- Ideal for automotive performance applications such as turbo charging, intercooler, etc.



## Vehicle Handy Pack

- Contains three useful sizes to fit hoses ranging from 11 – 57mm
- Ideally suited as emergency pack in service stations
- Attractive carded packaging

# CV Boot Combo Kit

- Contains stainless steel CV Boot clamps and banding tool with cutter
- This useful kit has all stainless steel clamps required for the replacement of CV boots of all sizes



CV Boot Combo Kit Part No. CVCP10 Contents : 30 Clamps			
Part No.	Width mm	Length mm	Quantity
CV2-63130	6.3	130	5
CV280	6.3	280	10
CV360	6.3	360	5
CV480	6.3	480	5
CV680	6.3	680	5
301104	Banding Tool		1

# Clamp Packs



- Assorted clamp packs to suit a variety of applications
- Handy carry case provides one compact storage location
- Packs clearly marked with size range
- Ideal for farm, workshop or mobile use



**Multi Purpose – Part Stainless**  
Part No. MP125  
Contents : 125 Clamps

Part No.	Quantity
MPCM00	20
MPC00	20
MPC0	20
MPC1A	20
MPC1	20
MPC2	15
MPC3	10

**Multi Purpose – All Stainless**  
Part No. SMP125  
Contents : 125 Clamps

Part No.	Quantity
SMPCM00	20
SMPC00	20
SMPC0	20
SMPC1A	20
SMPC1	20
SMPC2	15
SMPC3	10

**Perforated Band – Part Stainless**  
Part No. CWP150  
Contents : 150 Clamps

Part No.	Quantity
MH004	15
MH006	15
EF1004	15
EF1006	15
HS010	15
HS012	15
HS016	15
HS024	15
HS028	15
HS032	15

**Perforated Band – All Stainless**  
Part No. CWP150SS  
Contents : 150 Clamps

Part No.	Quantity
MAH004	30
MAH006	30
HAS010	15
HAS012	15
HAS016	15
HAS024	15
HAS028	15
HAS032	15



**Solid Band Clamp Pack**  
Part No. SBP82  
Contents : 82 Clamps

Part No.	Quantity
SMH004	20
SMH006	20
SHS010	10
SHS012	10
SHS016	10
SHS024	6
SHS028	6

**Double Ear Clamp Pack**  
Part No. TEC300  
Contents : 300 Clamps plus Pincer

Part No.	Size mm	Quantity
TEC57	5 - 7	30
TEC79	7 - 9	30
TEC911	9 - 11	30
TEC1113	11 - 13	30
TEC1315	13 - 15	30
TEC1517	15 - 17	30
TEC1518	15 - 18	30
TEC1720	17 - 20	30
TEC2023	20 - 23	30
TEC2325	23 - 25	30
SCP-1	Std Top Join Pincer	1

**Fuel Injection Clamp Pack**  
Part No. FI220  
Contents : 220 Clamps

Part No.	Size mm	Quantity
EF1004	7 - 15	20
EF1005	9 - 17	20
EF1006	14 - 22	10
NA0709	7 - 9	20
NA0810	8 - 10	20
NA0911	9 - 11	20
NA1214	12 - 14	20
NA1315	13 - 15	20
TEC79	7 - 9	20
TEC1113	11 - 13	20
TEC1315	13 - 15	20
TEC1517	15 - 17	10

**Rubber-Lined Clamp Pack**  
Part No. TRLC90K  
Contents : 90 Clamps

Part No.	Quantity
TRLC3	10
TRLC5	10
TRLC6	10
TRLC8	10
TRLC10	10
TRLC11	10
TRLC13	10
TRLC14	5
TRLC16	10
TRLC18	5



# Ezi-Load Merchandisers



- Display, organise and dispense popular MH/HS or MAH/HAS Series perforated hose clamps
- Each merchandiser contains a range of 300 popular hose clamps in full stainless or part stainless steel
- Durable metal frame provides easy storage for refill boxes
- Easy to position as a wall-mounted or freestanding unit
- Gravity fed box design allows for easy access of hose clamps
- Re-order part number clearly marked on perforated tear-off strip
- Holds two boxes of each part number to manage stock levels
- Easy to refill when merchandiser needs replenishing
- Compact in size – only 310mm (w) x 760mm (h) x 200mm (d)



ELM300



ELM300S

MH/HS Series Part Stainless Steel, Perforated Band		
Size mm	Part No. ELM300	
	Part No.	Boxes
6 - 16	MH004RF	2
11 - 18	MH005RF	2
11 - 22	MH006RF	2
13 - 25	HS008RF	2
14 - 27	HS010RF	2
18 - 32	HS012RF	2
21 - 38	HS016RF	2
27 - 51	HS024RF	2
33 - 57	HS028RF	2
40 - 64	HS032RF	2

Refill Box	
Part No.	Qty
MH004RF	20
MH005RF	20
MH006RF	20
HS008RF	15
HS010RF	15
HS012RF	15
HS016RF	15
HS024RF	10
HS028RF	10
HS032RF	10

MAH/HAS Series All Stainless Steel, Perforated Band		
Size mm	Part No. ELM300S	
	Part No.	Boxes
6 - 16	MAH004RF	2
11 - 18	MAH005RF	2
11 - 22	MAH006RF	2
13 - 25	HAS008RF	2
14 - 27	HAS010RF	2
18 - 32	HAS012RF	2
21 - 38	HAS016RF	2
27 - 51	HAS024RF	2
33 - 57	HAS028RF	2
40 - 64	HAS032RF	2

Refill Box	
Part No.	Qty
MAH004RF	20
MAH005RF	20
MAH006RF	20
HAS008RF	15
HAS010RF	15
HAS012RF	15
HAS016RF	15
HAS024RF	10
HAS028RF	10
HAS032RF	10

## How to use the Ezi-Load Merchandiser



**1** Remove perforated tear-off strip and reorder refill box required



**2** To change refill boxes unfasten holding clip at top, remove empty box and insert refill



**3** Gravity fed box system enables easy access to clamps

## Carded Clamp Merchandisers



- Holds popular clamp sizes to suit many applications in all stainless or part stainless steel
- Attractive, convenient retail display for wall and pegboard mounting
- Contains 40 cards (5 per hook)
- Cards are individually barcoded
- Dimensions 450mm (w) x 380mm (h)



MH/HS Series Part Stainless Steel Perforated Band	
Part No. CCM01	Qty
MH004C	5
MH006C	5
HS010C	5
HS012C	5
HS016C	5
HS020C	5
HS028C	5
HS032C	5

MAH/HAS Series All Stainless Steel Perforated Band	
Part No. CCM02	Qty
MAH004C	5
MAH006C	5
HAS010C	5
HAS012C	5
HAS016C	5
HAS020C	5
HAS028C	5
HAS032C	5



# Wall Merchandisers



- Available for Solid band, Perforated band or Multi-Purpose hose clamps
- Each merchandiser contains a range of 120 popular hose clamps in full stainless or part stainless steel
- Simple to load and select from, professionally displays Tridon hose clamps
- For wall and pegboard mounting
- Multi-Purpose clamps feature a removable safety collar
- Dimensions 382mm (w) x 934mm (h)



CM4SB

SMH/SHS Series Part Stainless Steel Solid Band	
Part No. CM4SB	
Part No.	Qty
SMH004	15
SMH006	15
SHS010	15
SHS012	15
SHS016	15
SHS024	15
SHS028	15
SHS032	15



CM4MP

MP Series Part Stainless Steel Multi-Purpose	
Part No. CM4MP	
Part No.	Qty
MPC000	15
MPCM00	15
MPC00	15
MPC0	15
MPC1	15
MPC1X	15
MPC2	15
MPC3	15



CM4SMP

SMP Series Full Stainless Steel Multi-Purpose	
Part No. CM4SMP	
Part No.	Qty
SMPC000	15
SMPCM00	15
SMPC00	15
SMPC0	15
SMPC1	15
SMPC1X	15
SMPC2	15
SMPC3	15

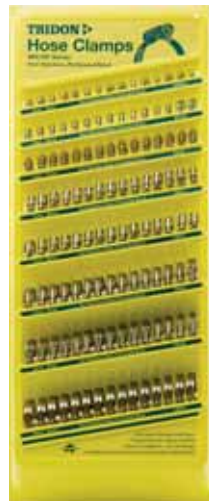

CM4HC

MH/HS Series Part Stainless Steel Perforated Band	
Part No. CM4HC	
Part No.	Qty
MH004	15
MH006	15
HS010	15
HS012	15
HS016	15
HS024	15
HS028	15
HS032	15



CM4DC

MAH/HAS Series Full Stainless Steel Perforated Band	
Part No. CM4DC	
Part No.	Qty
MAH004	15
MAH006	15
HAS010	15
HAS012	15
HAS016	15
HAS024	15
HAS028	15
HAS032	15

# T-Bolt Merchandisers



- Durable metal display board with hooks
- Each merchandiser contains a range of 71 popular T-Bolt clamps
- Available in full stainless or stainless steel band
- Easy selection - part numbers and sizes are clearly identified on merchandiser
- For wall and pegboard mounting
- Dimensions 580mm (w) x 800mm (h)



TBM71



TBMSS71

TTBY Series Stainless Steel Band Part No. TBM71	
Part No.	Qty
TTBY 17-19	4
TTBY 20-22	4
TTBY 26-28	4
TTBY 29-31	4
TTBY 32-35	4
TTBY 36-39	4
TTBY 40-43	4
TTBY 44-47	4
TTBY 48-51	4
TTBY 52-55	4
TTBY 56-59	4
TTBY 60-63	4
TTBY 64-67	4
TTBY 68-73	4
TTBY 74-79	3
TTBY 80-85	3
TTBY 86-91	3
TTBY 104-112	3
TTBY 113-121	3

TTBS Series Full Stainless Steel Part No. TBMSS71	
Part No.	Qty
TTBS 17-19	4
TTBS 20-22	4
TTBS 26-28	4
TTBS 29-31	4
TTBS 32-35	4
TTBS 36-39	4
TTBS 40-43	4
TTBS 44-47	4
TTBS 48-51	4
TTBS 52-55	4
TTBS 56-59	4
TTBS 60-63	4
TTBS 64-67	4
TTBS 68-73	4
TTBS 74-79	3
TTBS 80-85	3
TTBS 86-91	3
TTBS 104-112	3
TTBS 113-121	3

# Cable Tie Merchandisers

- Convenient way to store and display a wide range of popular cable ties
- Freestanding rotary unit is fully mobile and can be easily moved around the store
- Compact counter unit can also be wall mounted to maximise space
- Durable metal merchandisers

## Rotary Merchandiser

CONTENTS	Part No. CTM01 Dimensions: 640mm (w) x 1800mm (h)		
Part No.	Qty	Colour	Size (mm)
CT103BKCD	6 x Packs of 100	Black	3 x 100
CT154BKCD	6 x Packs of 100	Black	4 x 150
CT205BKCD	6 x Packs of 100	Black	5 x 200
CT255BKCD	6 x Packs of 100	Black	5 x 250
CT305BKCD	6 x Packs of 100	Black	5 x 300
CT408BKCD	6 x Packs of 25	Black	8 x 400
CTB255BK	1 x Pack of 500	Black	5 x 250
CT103NTCD	6 x Packs of 100	Natural	3 x 100
CT154NTCD	6 x Packs of 100	Natural	4 x 150
CT205NTCD	6 x Packs of 100	Natural	5 x 200
CT255NTCD	6 x Packs of 100	Natural	5 x 250
CT305NTCD	6 x Packs of 100	Natural	5 x 300
CT408NTCD	6 x Packs of 25	Natural	8 x 400
CTP07	2 x Packs of 500	Assorted	4 x 150
CTP10	8 x Packs of 75	Natural	Various
CTP13	8 x Packs of 150	Assorted	Various
CTP18	8 x Packs of 75	Assorted	Various
CTCP10	3 x Combo Packs	Black	Various



CTM01

## Counter Merchandiser

CONTENTS	Part No. CTM02 Dimensions: 380mm (w) x 550mm (h) x 200mm (d)		
Part No.	Qty	Colour	Size (mm)
CT103BKCD	10 x Packs of 100	Black	3 x 100
CT154BKCD	10 x Packs of 100	Black	4 x 150
CT205BKCD	10 x Packs of 100	Black	5 x 200
CT305BKCD	10 x Packs of 100	Black	5 x 300
CTP03	2 x Packs of 1000	Assorted	3 x 100



CTM02